



CMA Testing and Certification Laboratories

廠商會檢定中心

TEST REPORT

Report No. : AR0017722(8) Date : 16 Apr 2013
Application No. : LR007627(0)
Client : Kid Galaxy Inc
150 Dow Street,
Unit 425B Manchester, nh03101

Sample Description : One(1) item of submitted sample stated to be :

Sample Description	Mode number
GOGO Auto -- Garbage Truck	10423
GOGO Auto series	10481 / 10482 / 10438 / 10484 / 10421 / 10422 / 10420 / 10478 / 10415 / 10438 / 10471 / 10472 / 10433 / 10569 / 10570 / 40215 / 10436 / 10436 / 10460 / 10414 / 10709 / 10710 / 10711 / 10712 / 10435 / 10410 / 10705 / 10706

Sample registration no. : RR008824-001
Radio Frequency : 27.145MHz Transmitter
Rating : 1 x 9V size battery
No. of submitted sample : Four (4) piece (s)

Date Received : 21 Mar 2013
Test Period : 25 Mar 2013 to 10 Apr 2013
Test Requested : FCC Part 15 Certification.

For and on behalf of
CMA Industrial Development Foundation Limited

Authorized Signature : _____

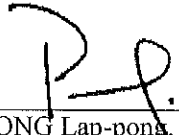
Mr. WONG Lap-pong, Andrew
Assistant Manager
Electrical Division

Page 1 of 24

FCC ID: QEA-E003-27T

This document is issued subject to the latest CMA Testing General Terms and Conditions of Testing and Inspection Services, available on request or accessible at website www.cmatcl.com.
This document shall not be reproduced except in full or with written approval by CMA Testing.

CMA Industrial Development Foundation Limited
Room 1302, Yan Hing Centre, 9-13 Wong Chuk Yeung St., Fo Tan, Shatin, N.T., Hong Kong.
Tel: (852) 2698 8198 Fax: (852) 2695 4177 E-mail: info@cmatcl.com Web Site: <http://www.cmatcl.com>



**CMA Testing
and Certification
Laboratories**

廠商會檢定中心

TEST REPORT

Report No. : AR0017722(8) Date : 16 Apr 2013

Test Method : 47 CFR Part 15 (10-1-10 Edition)
ANSI C63.4 – 2009

Test Result : See attached sheet(s) from page 2 to 24.

Conclusion : The submitted sample was found to comply with requirement of FCC Part 15
Subpart C.

Remark : All twenty-nine models are the same in circuitry and components; and therefore
model 10423 was chosen to be the representative of the test sample. The difference
between the tested model and the declared model(s) is/are the model number, color
and sample description.

For and on behalf of
CMA Industrial Development Foundation Limited

Authorized Signature : _____

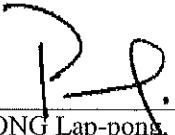
Mr. WONG Lap-pong, Andrew
Assistant Manager
Electrical Division

Page 2 of 24

FCC ID: QEA-E003-27T

This document is issued subject to the latest CMA Testing General Terms and Conditions of Testing and Inspection Services, available on request or accessible at website www.cmatcl.com.
This document shall not be reproduced except in full or with written approval by CMA Testing

CMA Industrial Development Foundation Limited

Room 1302, Yan Hing Centre, 9-13 Wong Chuk Yeung St., Fo Tan, Shatin, N.T., Hong Kong.

Tel: (852) 2698 8198 Fax: (852) 2695 4177 E-mail: info@cmatcl.com Web Site: <http://www.cmatcl.com>

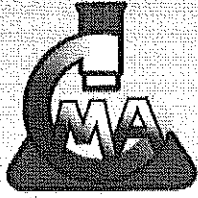

**CMA Testing
and Certification
Laboratories**

廠商會檢定中心

TEST REPORT

Report No. : AR0017722(8)

Date : 16 Apr 2013

Table of Contents

1	General Information.....	4
1.1	General Description.....	4
1.2	Location of the test site.....	5
1.3	List of measuring equipment.....	6
1.4	Measurement Uncertainty.....	6
2	Description of the radiated emission test.....	7
2.1	Test Procedure.....	7
2.2	Test Result.....	7
2.3	Radiated Emission Measurement Data.....	8
3	Description of the Line-conducted Test.....	9
3.1	Test Procedure.....	9
3.2	Test Result.....	9
3.3	Graph and Table of Conducted Emission Measurement Data.....	9
4	Photograph.....	10
4.1	Photographs of the Test Setup for Radiated Emission and Conducted Emission.....	10
4.2	Photographs of the External and Internal Configurations of the EUT.....	10
5	Supplementary document.....	11
5.1	Bandwidth.....	11
5.2	Duty cycle.....	11
5.3	Transmission time.....	11
6	Appendices.....	13

FCC ID: QEA-E003-27T

Page 3 of 24

This document is issued subject to the latest CMA Testing General Terms and Conditions of Testing and Inspection Services, available on request or accessible at website www.cmatcl.com
This document shall not be reproduced except in full or with written approval by CMA Testing

CMA Industrial Development Foundation Limited

Room 1302, Yan Hing Centre, 9-13 Wong Chuk Yeung St., Fo Tan, Shatin, N.T., Hong Kong

Tel: (852) 2698 8198 Fax: (852) 2695 4177 E-mail: info@cmatcl.com Web Site: <http://www.cmatcl.com>



**CMA Testing
and Certification
Laboratories**

廠商會檢定中心

TEST REPORT

Report No. : AR0017722(8)

Date : 16 Apr 2013

1 General Information

1.1 General Description

The equipment under test (EUT) is a transmitter for Garbage Truck RC car. It operates at 27.145MHz and the oscillation of radio control is generated by a crystal. The EUT is powered by 1 x 9V battery. There are two buttons on the EUT. When the buttons are pressed, it will transmit radio control signal to receiver.

The antenna is permanently attached in EUT and the radio output power is unable to adjust.

The brief circuit description is listed as follows:

- S1, S2 and its associated circuit act as power circuit.
- R2, R3, R4, R5, R6, R7, D1, C3, C4 and its associated circuit act as encoding circuit
- R8, R9, Q3, C7, C6, X1, C5, L1, R10 and its associated circuit act as 27.145MHz high frequency oscillatory circuit
- R11, C8, C11, Q4, R12, L2, C10, C12, L3, C13, L4 and its associated circuit act as modulator and amplifier circuit

FCC ID: QEA-E003-27T

Page 4 of 24

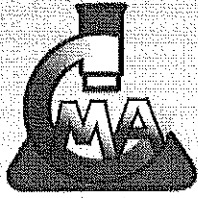

**CMA Testing
and Certification
Laboratories**

廠商會檢定中心

TEST REPORT

Report No. : AR0017722(8)

Date : 16 Apr 2013

1.2 Location of the test site

FCC Registered Test Site Number: 552221

Radiated emissions measurements are investigated and taken pursuant to the procedures of ANSI C63.4 – 2009. A Semi-Anechoic Chamber Testing Site is set up for investigation and located at:

Ground Floor, Yan Hing Centre,
9 – 13 Wong Chuk Yeung Street,
Fo Tan, Shatin,
New Territories,
Hong Kong.

Conducted emissions measurements are investigated and also taken pursuant to the procedures of ANSI C63.4 – 2009. A shielded room is located at :

Ground Floor, Yan Hing Centre,
9 – 13 Wong Chuk Yeung Street,
Fo Tan, Shatin,
New Territories,
Hong Kong.

FCC ID: QEA-E003-27T

Page 5 of 24

This document is issued subject to the latest CMA Testing General Terms and Conditions of Testing and Inspection Services, available on request or accessible at website www.cmatcl.com.
This document shall not be reproduced except in full or with written approval by CMA Testing

CMA Industrial Development Foundation Limited

Room 1302, Yan Hing Centre, 9-13 Wong Chuk Yeung St., Fo Tan, Shatin, N.T., Hong Kong.

Tel: (852) 2698 8198 Fax: (852) 2695 4177 E-mail: info@cmatcl.com Web Site: <http://www.cmatcl.com>

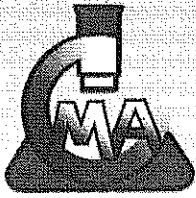

CMA Testing and Certification Laboratories

廠商會檢定中心

TEST REPORT

Report No. : AR0017722(8)

Date : 16 Apr 2013

1.3 List of measuring equipment

Equipment	Manufacturer	Model No.	Serial No.	Calibration Due Date
EMI Test Receiver	R&S	ESCI	100152	28 May 2013
Broadband Antenna	Schaffner	CBL6112B	2718	16 Jan 2014
Loop Antenna	EMCO	6502	00056620	15 Sep 2013
Coaxial Cable	Schaffner	RG 213/U	N/A	28 May 2013
Coaxial Cable	Schaffner	RG 214/U	N/A	28 May 2013

1.4 Measurement Uncertainty

The reported uncertainty is based on a standard uncertainty multiplied by a coverage factor $k=2$, providing a level of confidence of approximately 95%.

Radiated emissions

Frequency	Uncertainty (U_{lab})
30MHz ~ 200MHz (Horizontal)	4.83dB
30MHz ~ 200MHz (Vertical)	4.84dB
200MHz ~ 1000MHz (Horizontal)	4.66dB
200MHz ~ 1000MHz (Vertical)	4.65dB

Conducted emissions

Frequency	Uncertainty (U_{lab})
150kHz~30MHz	3.02dB

FCC ID: QEA-E003-27T

Page 6 of 24

This document is issued subject to the latest CMA Testing General Terms and Conditions of Testing and Inspection Services, available on request or accessible at website www.cmatcl.com. This document shall not be reproduced except in full or with written approval by CMA Testing.

CMA Industrial Development Foundation Limited

Room 1302, Yan Hing Centre, 9-13 Wong Chuk Yeung St., Fo Tan, Shatin, N.T., Hong Kong.

Tel: (852) 2698 8198 Fax: (852) 2695 4177 E-mail: info@cmatcl.com Web Site: <http://www.cmatcl.com>

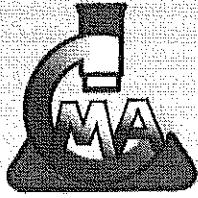

**CMA Testing
and Certification
Laboratories**

廠商會檢定中心

TEST REPORT

Report No. : AR0017722(8)

Date : 16 Apr 2013

2 Description of the radiated emission test

2.1 Test Procedure

Radiated emissions measurements are investigated and taken pursuant to the procedures of ANSI C63.4 – 2009.

The equipment under test (EUT) was placed on a non-conductive turntable with dimensions of 1.5m x 1m and 0.8m high above the ground. 3m from the EUT, a broadband antenna mounting on the mast received the signal strength. The turntable was rotated to maximize the emission level. The antenna was then moving along the mast from 1m up to 4m until no more higher value was found. Both horizontal and vertical polarization of the antenna were placed and investigated.

For below 30MHz, a loop antenna with its vertical plane is placed 3m from the EUT and rotated about its vertical axis for maximum response at each azimuth about the EUT. And the centre of the loop shall be 1 m above the ground.

The device was rotated through three orthogonal axes to determine which attitude and configuration produce the highest emission during measurement for Radiated Emission measurement.

2.2 Test Result

Peak Detector data was measured unless otherwise stated.

“#” means emissions appearing within the restricted bands shall follow the requirement of section 15.205.

The frequencies from fundamental up to the tenth harmonics were investigated, and emissions more 20dB below limit were not reported. Thus, those highest emissions were presented in next page (section 2.3).

It was found that the EUT meet the FCC requirement.

FCC ID: QEA-E003-27T

Page 7 of 24

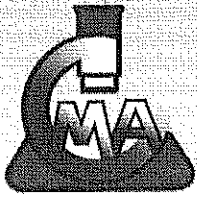

Report No. : AR0017722(8)

Date : 16 Apr 2013

2.3 Radiated Emission Measurement Data

Radiated emission

pursuant to

the requirement of FCC Part 15 subpart C

Environmental conditions:

Parameter	Recorded value	
Ambient temperature:	23	° C
Relative humidity:	75	%

Detector: Peak (Fundamental frequency), Quasi-peak (outside operation band)

RBW: 120kHz

VBW: 300kHz

Frequency (MHz)	Polarity (H/V)	Reading at 3m (dBµV)	Antenna Factor and Cable Loss (dB/m)	Average Factor (dB)	Field Strength at 3m (dBµV/m)	Limit at 3m (dBµV/m)	Margin (dB)
27.146	V	68.6	9.9	- 7.2	71.3	80.0	- 8.7
54.294	V	16.9	10.2	-	27.1	40.0	- 12.9
81.432	V	9.3	8.6	-	17.9	40.0	- 22.1
# 108.541	V	10.3	12.4	-	22.7	43.5	- 20.8
# 135.747	V	9.0	14.7	-	23.7	43.5	- 19.8
# 162.836	V	8.8	12.0	-	20.8	43.5	- 22.7
189.982	V	9.7	11.2	-	20.9	43.5	- 22.6
217.149	V	10.1	11.9	-	22.0	46.0	- 24.0
244.265	V	12.0	11.9	-	23.9	46.0	- 22.1
271.484	V	9.3	15.0	-	24.3	46.0	- 21.7

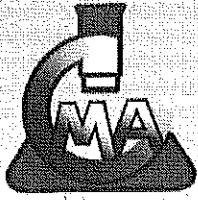

**CMA Testing
and Certification
Laboratories**

廠商會檢定中心

TEST REPORT

Report No. : AR0017722(8)

Date : 16 Apr 2013

3 Description of the Line-conducted Test

3.1 Test Procedure

Conducted emissions measurements are investigated and also taken pursuant to the procedures of ANSI C63.4 – 2009. The EUT was setup as described in the procedures, and both lines were measured.

3.2 Test Result

No measurement is required as the EUT is a battery-operated product.

3.3 Graph and Table of Conducted Emission Measurement Data

Not Applicable

FCC ID: QEA-E003-27T

Page 9 of 24

This document is issued subject to the latest CMA Testing General Terms and Conditions of Testing and Inspection Services, available on request or accessible at website www.cmatcl.com
This document shall not be reproduced except in full or with written approval by CMA Testing

CMA Industrial Development Foundation Limited

Room 1302, Yan Hing Centre, 9-13 Wong Chuk Yeung St., Fo Tan, Shatin, N.T., Hong Kong

Tel: (852) 2698 8198 Fax: (852) 2695 4177 E-mail: info@cmatcl.com Web Site: <http://www.cmatcl.com>



**CMA Testing
and Certification
Laboratories**

廠商會檢定中心

TEST REPORT

Report No. : AR0017722(8)

Date : 16 Apr 2013

4 Photograph

4.1 Photographs of the Test Setup for Radiated Emission and Conducted Emission

For electronic filing, the photos are saved with filename TSup1.jpg to TSup2.jpg.

4.2 Photographs of the External and Internal Configurations of the EUT

For electronic filing, the photos are saved with filename ExPho1.jpg to ExPho2.jpg and InPho1.jpg to InPho2.jpg.

FCC ID: QEA-E003-27T

Page 10 of 24

This document is issued subject to the latest CMA Testing General Terms and Conditions of Testing and Inspection Services, available on request or accessible at website www.cmatcl.com.
This document shall not be reproduced except in full or with written approval by CMA Testing.

CMA Industrial Development Foundation Limited

Room 1302, Yan Hing Centre, 9-13 Wong Chuk Yeung St., Fo Tan, Shatin, N.T., Hong Kong.

Tel: (852) 2698 8198 Fax: (852) 2695 4177 E-mail: info@cmatcl.com Web Site: <http://www.cmatcl.com>

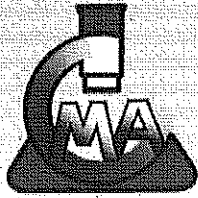

Report No. : AR0017722(8)

Date : 16 Apr 2013

5 Supplementary document

The following document were submitted by applicant, and for electronic filing, the document are saved with the following filenames:

Document	Filename
ID Label/Location	LabelSmp.jpg
Block Diagram	BlkDia.pdf
Schematic Diagram	Schem.pdf
Users Manual	UserMan.pdf
Operational Description	OpDes.pdf

5.1 Bandwidth

The plot on saved in TestRpt2.pdf shows the fundamental emission is confined in the specified band. It also shows that the band edge met the 15.209 requirement at 26.9599 and 27.2801 MHz.

Emission at 26.96MHz = 16.94 dBuV/m

Emission at 27.28MHz = 17.81 dBuV/m

5.2 Duty cycle

The duty cycle is simply the on-time divided by the period:

The duration of one cycle = 4.1739ms

Duration of pulse = 1.8261ms

Number of pulse = 1

Effective period of the cycle = 1.8261ms x 1
= 1.8261ms

Duty Cycle = 1.8261 / 4.1739
= 0.437

Therefore, the average factor is found by $20 \log_{10} 0.437 = -7.2\text{dB}$



**CMA Testing
and Certification
Laboratories**

廠商會檢定中心

TEST REPORT

Report No. : AR0017722(8)

Date : 16 Apr 2013

5.3 Transmission time

Not Applicable

FCC ID: QEA-E003-27T

Page 12 of 24

This document is issued subject to the latest CMA Testing General Terms and Conditions of Testing and Inspection Services, available on request or accessible at website www.cmatcl.com.
This document shall not be reproduced except in full or with written approval by CMA Testing

CMA Industrial Development Foundation Limited

Room 1302, Yan Hing Centre, 9-13 Wong Chuk Yeung St., Fo Tan, Shatin, N.T., Hong Kong.

Tel: (852) 2698 8198 Fax: (852) 2695 4177 E-mail: info@cmatcl.com Web Site: <http://www.cmatcl.com>

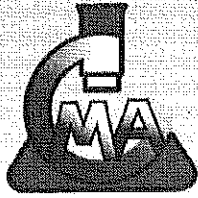

**CMA Testing
and Certification
Laboratories**

廠商會檢定中心

TEST REPORT

Report No. : AR0017722(8)

Date : 16 Apr 2013

6 Appendices

A1.	Photos of the set-up of Radiated Emissions	1	page
A2.	Photos of External Configurations	1	page
A3.	Photos of Internal Configurations	1	page
A4.	ID Label/Location	1	page
A5.	Bandwidth Plot	1	page
A6.	Average Factor	1	page
A7.	Block Diagram	1	page
A8.	Schematics Diagram	1	page
A9.	User Manual	2	pages
A10.	Operation Description	1	page

FCC ID: QEA-E003-27T

Page 13 of 24

This document is issued subject to the latest CMA Testing General Terms and Conditions of Testing and Inspection Services, available on request or accessible at website www.cmatcl.com
This document shall not be reproduced except in full or with written approval by CMA Testing

CMA Industrial Development Foundation Limited

Room 1302, Yan Hing Centre, 9-13 Wong Chuk Yeung St., Fo Tan, Shatin, N.T., Hong Kong.

Tel: (852) 2698 8198 Fax: (852) 2695 4177 E-mail: info@cmatcl.com Web Site: <http://www.cmatcl.com>



**CMA Testing
and Certification
Laboratories**

廠商會檢定中心

TEST REPORT

Report No. : AR0017722(8)

Date : 16 Apr 2013

A1. Photos of the set-up of Radiated Emissions

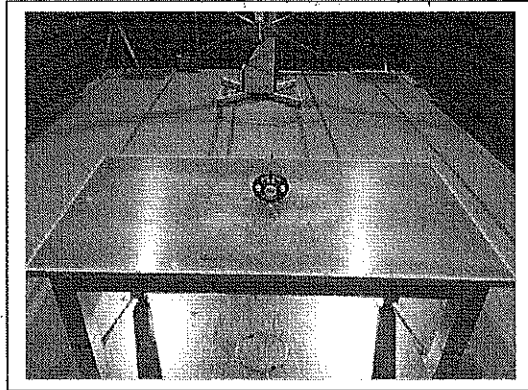

(Front view)

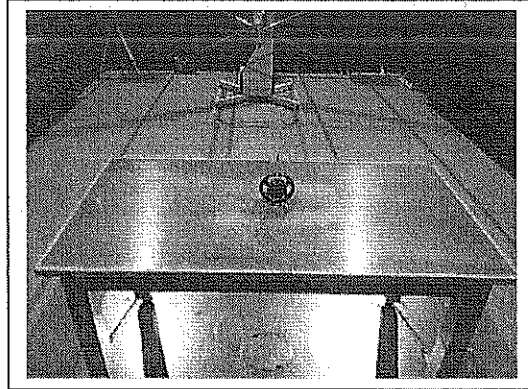

(Back view)

Tested by:

Mr. LEUNG Shu-kan, Ken

Reviewed by:

Mr. WONG Lap-pong, Andrew

FCC ID: QEA-E003-27T

Page 14 of 24

This document is issued subject to the latest CMA Testing General Terms and Conditions of Testing and Inspection Services, available on request or accessible at website www.cmatcl.com.
This document shall not be reproduced except in full or with written approval by CMA Testing

CMA Industrial Development Foundation Limited

Room 1302, Yan Hing Centre, 9-13 Wong Chuk Yeung St., Fo Tan, Shatin, N.T., Hong Kong.

Tel: (852) 2698 8198 Fax: (852) 2695 4177 E-mail: info@cmatcl.com Web Site: <http://www.cmatcl.com>



**CMA Testing
and Certification
Laboratories**

廠商會檢定中心

TEST REPORT

Report No. : AR0017722(8)

Date : 16 Apr 2013

A2. Photos of External Configurations

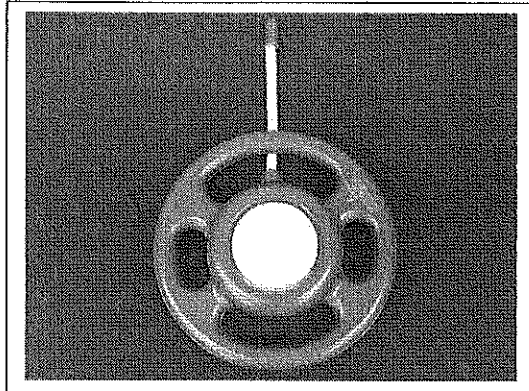

External Configuration 1

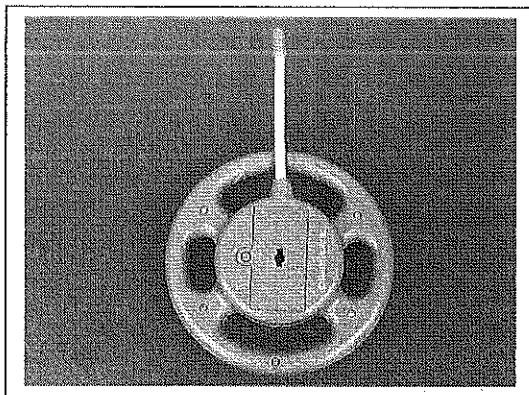

External Configuration 2

Tested by:

Mr. LEUNG Shu-kan, Ken

Reviewed by:

Mr. WONG Lap-pong, Andrew

FCC ID: QEA-E003-27T

Page 15 of 24

This document is issued subject to the latest CMA Testing General Terms and Conditions of Testing and Inspection Services, available on request or accessible at website www.cmatcl.com.
This document shall not be reproduced except in full or with written approval by CMA Testing.

CMA Industrial Development Foundation Limited

Room 1302, Yan Hing Centre, 9-13 Wong Chuk Yeung St., Fo Tan, Sha Tin, N.T., Hong Kong.

Tel: (852) 2698 8198 Fax: (852) 2695 4177 E-mail: info@cmatcl.com Web Site: <http://www.cmatcl.com>



**CMA Testing
and Certification
Laboratories**

廠商會檢定中心

TEST REPORT

Report No. : AR0017722(8)

Date : 16 Apr 2013

A3. Photos of Internal Configurations

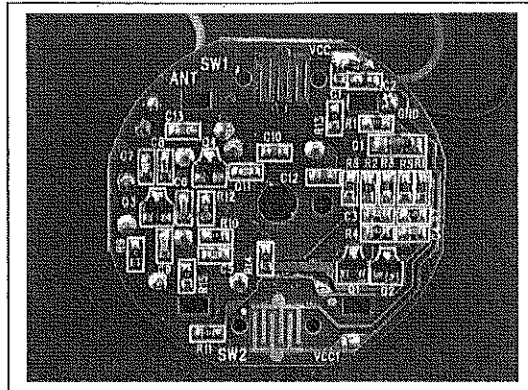

Internal Configuration 1

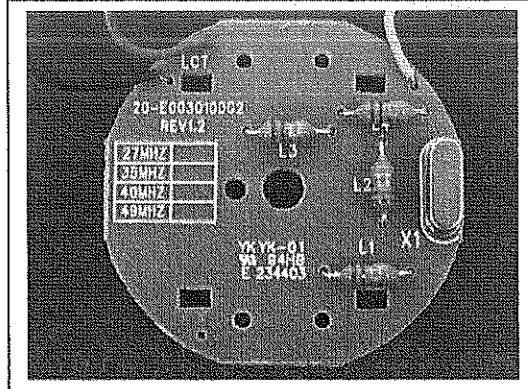

Internal Configuration 2

Tested by:

Mr. LEUNG Shu-kan, Ken

Reviewed by:

Mr. WONG Lap-pong, Andrew

FCC ID: QEA-E003-27T

Page 16 of 24

This document is issued subject to the latest CMA Testing General Terms and Conditions of Testing and Inspection Services, available on request or accessible at website www.cmatcl.com. This document shall not be reproduced except in full or with written approval by CMA Testing.

CMA Industrial Development Foundation Limited

Room 1302, Yan Hing Centre, 9-13 Wong Chuk Yeung St., Fo Tan, Shatin, N.T., Hong Kong.

Tel: (852) 2698 8198 Fax: (852) 2695 4177 E-mail: info@cmatcl.com Web Site: <http://www.cmatcl.com>

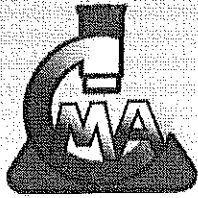

**CMA Testing
and Certification
Laboratories**

廠商會檢定中心

TEST REPORT

Report No. : AR0017722(8)

Date : 16 Apr 2013

A4. ID Label / Location

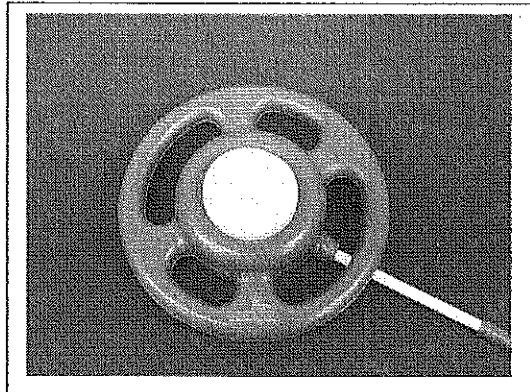

ID Label 1

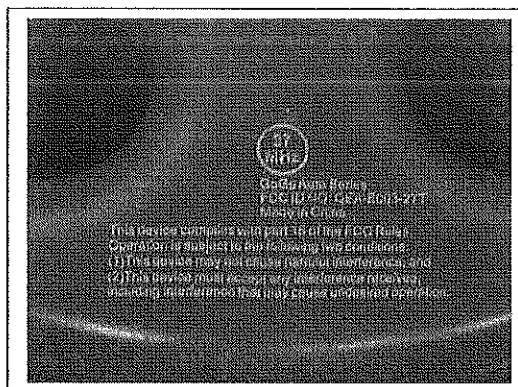

ID Label 2

Tested by:

Mr. LEUNG Shu-kan, Ken

Reviewed by:

Mr. WONG Lap-pong, Andrew

FCC ID: QEA-E003-27T

Page 17 of 24

This document is issued subject to the latest CMA Testing General Terms and Conditions of Testing and Inspection Services, available on request or accessible at website www.cmatcl.com
This document shall not be reproduced except in full or with written approval by CMA Testing

CMA Industrial Development Foundation Limited

Room 1302, Yan Hing Centre, 9-13 Wong Chuk Yeung St., Fo Tan, Shatin, N.T., Hong Kong

Tel: (852) 2698 8198 Fax: (852) 2695 4177 E-mail: info@cmatcl.com Web Site: <http://www.cmatcl.com>



Report No. : AR0017722(8)

Date : 16 Apr 2013

A7. Block Diagram

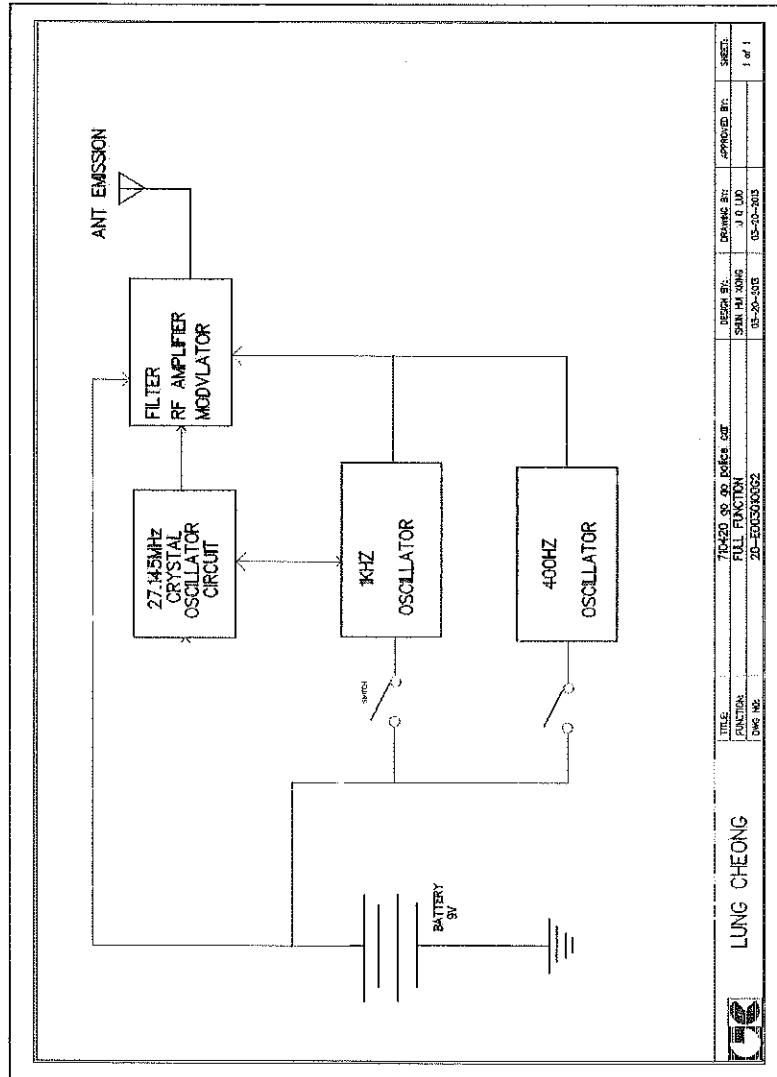

Tested by: *Ken*
Mr. LEUNG Shu-kan, Ken

Reviewed by: *P.R.*
Mr. WONG Lap-pong, Andrew

FCC ID: QEA-E003-27T

This document is issued subject to the latest CMA Testing General Terms and Conditions of Testing and Inspection Services, available on request or accessible at website www.cmatcl.com. This document shall not be reproduced except in full or with written approval by CMA Testing.

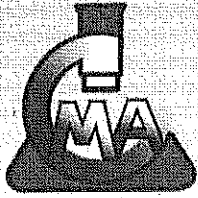

Report No. : AR0017722(8)

Date : 16 Apr 2013

A8. Schematic Diagram

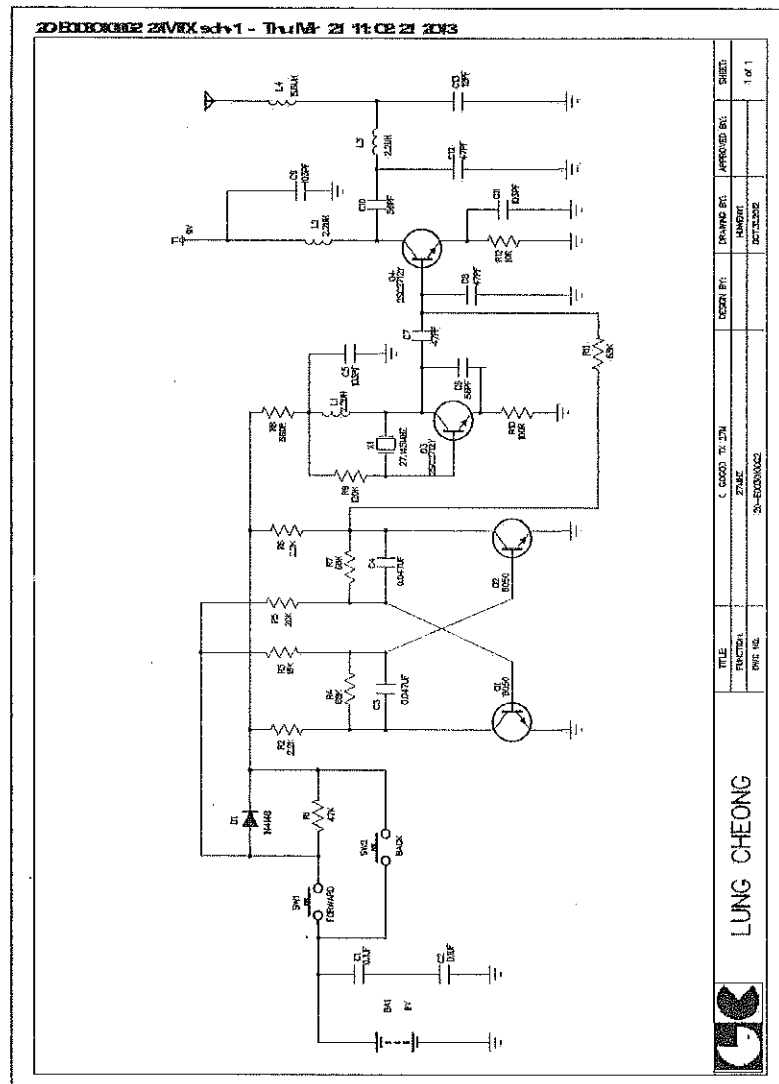

Tested by: *Ken*
Mr. LEUNG Shu-kan, Ken

Reviewed by: *P.P.*
Mr. WONG Lap-pong, Andrew

FCC ID: QEA-E003-27T

Page 21 of 24



CMA Testing and Certification Laboratories

廠商會檢定中心

TEST REPORT

Report No. : AR0017722(8)

Date : 16 Apr 2013

A9. User Manual

GO GO AUTO

OPERATING INSTRUCTIONS

Vehicle

- Unscrew battery box door with a phillips screwdriver.
- Remove battery box door from chassis.
- Install 3-AA batteries with correct polarities show inside battery compartment.
- Reattach battery box door.
- Turn switch ON to start the vehicle. ON/OFF switch is located on the bottom of the vehicle.



Remote Controller

- Unscrew battery door with a phillips screwdriver to open battery door.
- Install 1-9V battery with polarity as shown inside battery compartment.
- Check to see that vehicle is turned on.
- Press button for forward and turn.

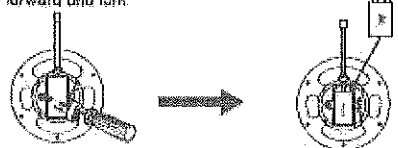

Function



FORWARD: push upper button
TURN: push lower button

The radio circuitry in your car and remote controller is sensitive. Radio interference can affect the control of your car. You may have to choose another location to operate your car.

Toll Free Kid Galaxy Hot Line: 800-816-1135

Kid Galaxy
Copyright ©2011 Kid Galaxy, Inc.

Tested by:

Mr. LEUNG Shu-kan, Ken

Reviewed by:

Mr. WONG Lap-pong, Andrew

FCC ID: QEA-E003-27T

Page 22 of 24

This document is issued subject to the latest CMA Testing General Terms and Conditions of Testing and Inspection Services, available on request or accessible at website www.cmatcl.com. This document shall not be reproduced except in full or with written approval by CMA Testing.

CMA Industrial Development Foundation Limited

Room 1302, Yan Hing Centre, 9-13 Wong Chuk Yeung St., Fo Tan, Shatin, N.T., Hong Kong.

Tel: (852) 2698 8198 Fax: (852) 2695 4177 E-mail: info@cmatcl.com Web Site: <http://www.cmatcl.com>

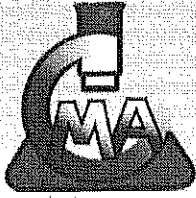

CMA Testing and Certification Laboratories

廠商會檢定中心

TEST REPORT

Report No. : AR0017722(8)

Date : 16 Apr 2013

A9. User Manual

USER MANUAL

Warning: Changes or modifications to this unit not expressly approved by the party responsible for compliance could void the user authority to operate the equipment.

This device complies with part 15 of the FCC Rules. Operation is subject to the following two conditions: (1) this device may not cause harmful interference, and (2) this device must accept any interference received, including interference that may cause undesired operation.

NOTE: This equipment has been tested and found to comply with the requirements of a Class B digital device, pursuant to Part 15 of the FCC Rules. These limits are designed to provide reasonable protection against harmful interference in a residential installation. This equipment generates, uses and can radiate radio frequency energy and, if not installed and used in accordance with the instructions, may cause harmful interference to radio communications.

However, there is no guarantee that interference will not occur in a particular installation. If this equipment does cause harmful interference to radio or television reception, which can be determined by turning the equipment, off and on, the user is encouraged to try to correct the interference by one or more of the following measures:

- Reorient or relocate the receiving antenna.
- Increase the separation between the equipment and receiver.
- Connect the equipment into an outlet on a circuit different from that to which the receiver is connected.
- Consult the dealer or an experienced radio/TV technician for help.
- Do not mix old and new batteries.
- Do not mix alkaline, standard (carbon-zinc), or rechargeable (Nickel-cadmium) batteries.

Go Go Auto Series

Tested by:

Mr. LEUNG Shu-kan, Ken

Reviewed by:

Mr. WONG Lap-pong, Andrew

FCC ID: QEA-E003-27T

Page 23 of 24

This document is issued subject to the latest CMA Testing General Terms and Conditions of Testing and Inspection Services, available on request or accessible at website www.cmatcl.com
This document shall not be reproduced except in full or with written approval by CMA Testing

CMA Industrial Development Foundation Limited

Room 1302, Yan Hing Centre, 9-13 Wong Chuk Yeung St., Fo Tan, Shatin, N.T., Hong Kong.

Tel: (852) 2698 8198 Fax: (852) 2695 4177 E-mail: info@cmatcl.com Web Site: <http://www.cmatcl.com>



**CMA Testing
and Certification
Laboratories**

廠商會檢定中心

TEST REPORT

Report No. : AR0017722(8)

Date : 16 Apr 2013

A10. Operation Description

Kid Galaxy RC-TOY GO GO CAR TX

OPERATION PRINCIPLE

The Kid Galaxy RC toy go go car TX operates basing on the controlling signals encode by 2 channel circuit;Afer modulation, the hight frequency oscillatory signals were emitted to control the progress, retreat functions for the RX. The modulation type is AM.

Circuits' composition:

Power circuit;encoding circuit;high frequency oscillatory circuit, modulator and amplifier circuit.

1. Power circuit:

S1, S2

2. encoding circuit:

R2, R3, R4, R5, R6, R7, D1, C3, C4

3. 27.145MHz high frequency oscillatory circuit decoder circuit:

R8, R9, Q3, C7, C6, X1, C5, L1, R10

4. modulator and amplifier circuit:

R11, C8, C11, Q4, R12, L2, C10, C12, L3, C13, L4, ANT

***** End of Report *****

Tested by:

Mr. LEUNG Shu-kan, Ken

Reviewed by:

Mr. WONG Lap-pong, Andrew

FCC ID: QEA-E003-27T

Page 24 of 24

This document is issued subject to the latest CMA Testing General Terms and Conditions of Testing and Inspection Services, available on request or accessible at website www.cmatcl.com. This document shall not be reproduced except in full or with written approval by CMA Testing.

CMA Industrial Development Foundation Limited

Room 1302, Yan Hing Centre, 9-13 Wong Chuk Yeung St., Fo Tan, Shatin, N.T., Hong Kong.

Tel: (852) 2698 8198 Fax: (852) 2695 4177 E-mail: info@cmatcl.com Web Site: <http://www.cmatcl.com>