

# Product Operation Manual

**3+**  
AGES

Thank you for choosing our product! Please read this instruction manual carefully before using, as it contains all the informations you need to know about how to use this product correctly with fun.

Colors And Contents May Vary From Illustration.



**2.4GHz**  
FREQUENCY

## Battery Installation

### Replacing batteries of the transmitter

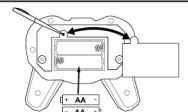

- Controller requires 2-AA batteries. (included)

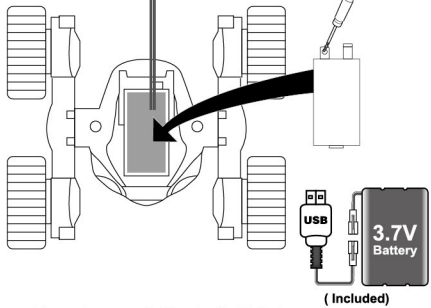
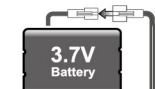

Power Requirement (Included)

(Included)

The statements should be displayed in the user manual: changes or modifications not expressly approved by the party responsible for compliance could void the user's authority to operate the equipment.

This equipment has been tested and found to comply with the limits for a Class B digital device, pursuant to Part 15 of the FCC Rules. These limits are designed to provide reasonable protection against harmful interference in a residential installation. This equipment generates, uses and can radiate radio frequency energy and, if not installed and used in accordance with the instructions, may cause harmful interference to radio communications. However, there is no guarantee that interference will not occur in a particular installation.

If this equipment does cause harmful interference to radio or television reception, which can be determined by turning the equipment off and on, the user is encouraged to try to correct the interference by one or more of the following measures:

- Reorient or relocate the receiving antenna.
- Increase the separation between the equipment and receiver.
- Connect the equipment into an outlet on a circuit different from that to which the receiver is connected.
- Consult the dealer or an experienced radio/TV technician for help.

This equipment complies with FCC radiation exposure limits set forth for an uncontrolled environment. This transmitter must not be co-located or operating in conjunction with any other antenna or transmitter.

This device complies with Part 15 of the FCC Rules. Operation is subject to the following two conditions: (1) this device may not cause harmful interference, and (2) this device must accept any interference received, including interference that may cause undesired operation.

changes or modifications not expressly approved by the party responsible for compliance could void the user's authority to operate the equipment.

Item NO: 5588-625

Product Name: Remote control car series

# The Basic Operation of The Products

1

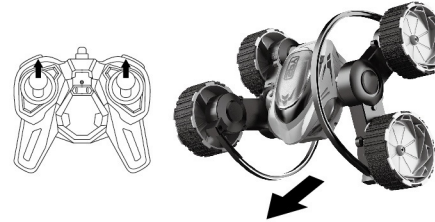

Forward

2



Backward

3

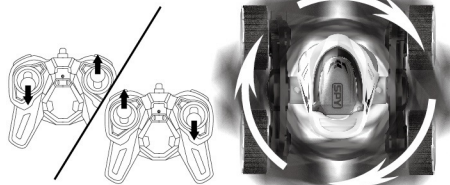

360°Rotation

4

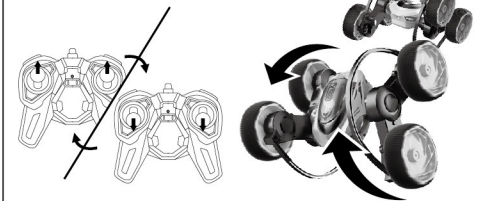

Tumble

## CAUTIONS

When the car is in motion, do not touch the wheels by hand to avoid damages to the car.



Do not bend the antenna or point it at other people or articles to avoid hurts.



Do not play in a place with puddle, mud or sand.



Do not play on the roads or in any other dangerous places to avoid accidents.

## BATTERY SAFETY

- (1) The placement or replacement of batteries is to be performed by an adult.
- (2) Remove the rechargeable battery from the chassis before charging.
- (3) Always remove exhausted batteries from the car and the transmitter.
- (4) Make sure the main switch is set to OFF before installing the battery pack into the car body.
- (5) Batteries must be inserted with the correct polarity.
- (6) Non-chargeable batteries shall not be recharged.
- (7) Do not short-circuit the batteries.
- (8) Always remove the batteries from the car and the transmitter after playing.
- (9) Never throw the batteries into fire to avoid explosion or leakage.
- (10) Do not mix batteries from different producers or new and old batteries.
- (11) You should only use batteries of the same or equivalent types as recommended.
- (12) Check the batteries on a regular basis to avoid leakage.
- (13) Keep this manual well for future reference as it contains important information about this product.



## Remote Control Operation

Forward



Backward



360°Rotation

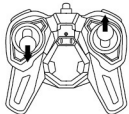

Tumble

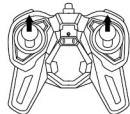

MADE IN CHINA



**WARNING:**

**CHOKING HAZARD** - small parts,  
Not for children under 3 years.

