



Ecom Sertech Corp.

Rm. 258, Bldg. 17, NO.195, Sec. 4 Chung Hsing Rd., ChuTung Chen, Hsinchu, Taiwan 310, R.O.C
TEL:886-3-5918012 FAX: 886-3-5825720

FCC ID : QDWWN360G
Report No. : ER03-06-079FRF
Page 1 of 55



TEST REPORT

Product Name : 802.11g WLAN Mini PCI Card
Model Number : WN360g

Applicant : AirVast Technology Inc.
Address : 4F,NO.1, Ln.21, Hsin Hua Rd., Kueishan Industria Park,
Taoyuan 330, Taiwan, R.O.C

Received Date : Jun. 25, 2003

Tested Date : Jun. 25~Jul. 10, 2003

Notes :

1. This report will be invalid if duplicated or photocopied in part.
2. This report refers only to the specimen(s) submitted to testing, and be invalid as seperately used.
3. This report is invalid without examination stamp and signature of this institute.
4. The tested specimen(s) will be preserved for thirty days from the data issued.
5. The report must not be used to claim product certification, approval, or endorsement by NVLAP, NIST, or any agency of the federal government.





Ecom Sertech Corp.

Rm. 258, Bldg. 17, NO.195, Sec. 4 Chung Hsing Rd., ChuTung Chen, Hsinchu, Taiwan 310, R.O.C
TEL:886-3-5918012 FAX: 886-3-5825720

FCC ID : QDWWN360G
Report No. : ER03-06-079FRF
Page 2 of 55

Test Report Certification

Product Name : 802.11g WLAN Mini PCI Card
Model Number : WN360g
Applicant : AirVast Technology Inc.

Measurement Standard :

47 CFR Part 15, Subpart B and Subpart C (Section 15.247),
ANSI C63.4-2001

Tested By : K. P. Pang , **Date** : Jul 15, 2003
(K. P. Pang)

Reviewed By : Roger Sheng , **Date** : Jul 16, 2003
(Roger Sheng)

Approved By : Chieh-De Tsai , **Date** : _____
(Chieh-De Tsai , Manager)

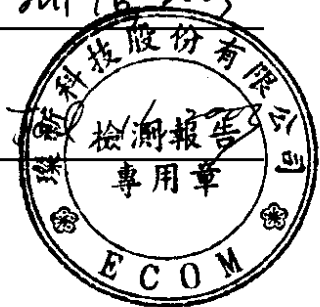

WE HEREBY CERTIFY THAT: The measurements shown in the attachment were made in accordance with the procedures indicated, and the energy emitted by the equipment was found to be within the limits applicable. We assume full responsibility for the accuracy and completeness of these measurements and vouch for the qualifications of all persons taking them.



TABLE OF CONTENTS

TITLE	PAGE NO.
1. GENERAL INFORMATION	5
1.1 General Statement.....	5
1.2 General Description of EUT & Power.....	5
1.3 Description of Peripherals.....	6
1.4 EUT & Peripherals Setup Diagram.....	7
1.5 EUT Operating Condition.....	7
1.6 Description of Test Site	8
1.7 Summary of Test Results.....	8
2. CONDUCTED POWERLINE TEST	9
2.1 Test Equipments	9
2.2 Test Setup	9
2.3 Conducted Power Line Emission Limit.....	10
2.4 Test Procedure	10
2.5 Uncertainty of Conducted Emission	10
2.6 Conducted Power Line Emission.....	11
2.7 Photos Of Conduction Test.....	12
3. RADIATED EMISSION TEST	13
3.1 Test Equipments	13
3.2 Test Setup	13
3.3 Radiation Limit.....	14
3.4 Test Procedures.....	15
3.5 Uncertainty of Radiated Emission	15
3.6 Radiated Rf Noise Measurement	16-35
3.7 Photos of Open Site	36-37
4. 6dB BANDWIDTH MEASUREMENT	38
4.1 Test Equipments	38
4.2 Test Setup	38
4.3 Limits of 6dB Bandwidth Measurement.....	38
4.4 Test Procedure	38
4.5 Uncertainty of Conducted Emission	39
4.6 Test Results.....	39
4.7 Photo of 6dB Bandwidth Measurement.....	40-41
5. MAXIMUM PEAK OUTPUT POWER	42
5.1 test equipments	42
5.2 Test Setup	42
5.3 Limits of Maximum Peak Output Power.....	42
5.4 Test Procedure	43
5.5 Uncertainty of Conducted Emission	43
5.6 Test Results.....	43
6. POWER SPECTRAL DENSITY MEASUREMENT	44
6.1 Test Equipments	44
6.2 Test Setup	44
6.3 Limits of Power Spectral Density Measurement	44
6.4 Test Procedure	45
6.5 Uncertainty of Conducted Emission	45
6.6 Test Results.....	45
6.7 Photo of Power Spectral Density Measurement	46-47



Ecom Sertech Corp.

Rm. 258, Bldg. 17, NO.195, Sec. 4 Chung Hsing Rd., ChuTung Chen, Hsinchu, Taiwan 310, R.O.C
TEL:886-3-5918012 FAX : 886-3-5825720

FCC ID : QDWWN360G
Report No. : ER03-06-079FRF
Page 4 of 55

TABLE OF CONTENTS

TITLE	PAGE NO.
7. OUT OF BAND MEASUREMENT	48
7.1 Test Equipments	48
7.2 Test Setup	48
7.3 Limits of Out of Band Emissions Measurement	48
7.4 Test Procedure	49
7.5 Uncertainty of Conducted Emission	49
7.6 Test Results	49-52
8. ANTENNA REQUIREMENT	53
8.1 Standard Applicable	53
8.2 Antenna Connected Construction	53
9. RF EXPOSURE EVALUATION	54
9.1 Friis Formula	54
9.2 EUT Operating Condition	54
9.3 Test Result of Rf Exposure Evaluation	55
9.3.1 Antenna Gain	55
9.3.2 Output Power Into Antenna & Rf Exposure Evaluation Distance	55



1. GENERAL INFORMATION

1.1 General Statement

MEASUREMENT DEVIATION : Comply with standard in full

TRACEABILITY : This test result is traceable to national or international std.

1.2 General Description of EUT & Power

MANUFACTURER : AirVast Technology Inc.
SAMPLE NAME : 802.11g WLAN Mini PCI Card
MODEL NO : WN360g
FREQUENCY RANGE : 2412 MHz TO 2462MHz
CHANNEL NUMBER : 11
AIR DATA RATE : 54Mbps (802.11g Mode), 11Mbps(802.11b Mode)
TYPE OF MODULATION : Orthogonal Frequency Division Multiplex or Direct Sequence Spread Spectrum
FREQUENCY SELECTION : BY SOFTWARE
EUT Description : 2.4GHz (Orthogonal Frequency Division Multiplex or Direct Sequence Spread Spectrum) Data Transceiver for Wireless Broadband Router
ANTENNA TYPE : DIPOLE ANTENNA
POWER SOURCE : 3.3VDC(From PC)
DATA APPLIED TO

1. Company name : Sercomm Corporation
Model name : WN360g
Brand name : Sercomm Corporation
Address : 10th FL., No. 19-13, Sanchung Road, NanKang, Taipei City, Taiwan 115, R.O.C.
2. Company name : Teletronics International Inc.
Model name : WN-360g
Brand name : Teletronics International Inc.
Address : 1803 Research Blvd., Suite 404 Rockville, MD 20850-3155 USA
3. Company name : PILOTECH SYSTEMS CO., LTD.
Model name : WP026g
Brand name : PILOTECH SYSTEMS CO., LTD
Address : 9th FL. 3, No. 134, CHUNG-HSING RD. SEC. 3, HSINTIEN, TAI PEI HSIEN TAIWAN R.O.C.



Ecom Sertech Corp.

Rm. 258, Bldg. 17, NO.195, Sec. 4 Chung Hsing Rd., ChuTung Chen, Hsinchu, Taiwan 310, R.O.C
TEL:886-3-5918012 FAX : 886-3-5825720

FCC ID : QDWWN360G
Report No. : ER03-06-079FRF
Page 6 of 55

4. Company name : EDIMAX TECHNOLOGY CO., LTD.
Model name : EW-7151MG
Brand name : EDIMAX TECHNOLOGY CO., LTD.
Address : 7, LANE 116, WU-KUNG SECOND ROAD WU-KUINDUSTRIAL PARK, TAIPE HSIEN TAIWAN, R.O.C.
5. Company name : Comtrend Corporation.
Model name : CT-WN-360g
Brand name : Comtrend Corporation.
Address : 3F-1, 10 Lane 609 Chung Hsin Road, Sec. 5 San Chung City, Taipei Hsien, Taiwan 241.

1.3 Description of Peripherals

(1) Notebook PC

MANUFACTURER : DELL CORP.
MODEL NUMBER : PP01L
SERIAL NUMBER : CN-09C748-48155-1AP-6081
FCC : DOC
POWER CORD : Unshielded, Detachable, 1.8m

(2) PRINT

MANUFACTURER : Hp Corp.
MODEL NUMBER : C6431D
SERIAL NUMBER : CN19T6S011
FCC ID : DOC
POWER SOURCE : 100-240VAC,50/60Hz,0.7A
SIGNAL CABLE : Shielded , Undetachable , 1.8m

(3) MODEM

MANUFACTURER : ZYXEL communication Corp.
MODEL NUMBER : Omni 56K
SERIAL NUMBER : S1Z4107729
FCC ID : 1880MN156K
POWER SOURCE : 9VAC(From Power Adapter)
SIGNAL CABLE : Shielded , Undetachable , 1.8m

(4) Notebook PC

MANUFACTURER : DELL CORP.
MODEL NUMBER : PP01L
SERIAL NUMBER : CN-09C748-48155-1AP-6630
FCC : DOC
POWER CORD : Unshielded, Detachable, 1.8m

1.4 EUT & Peripherals Setup Diagram

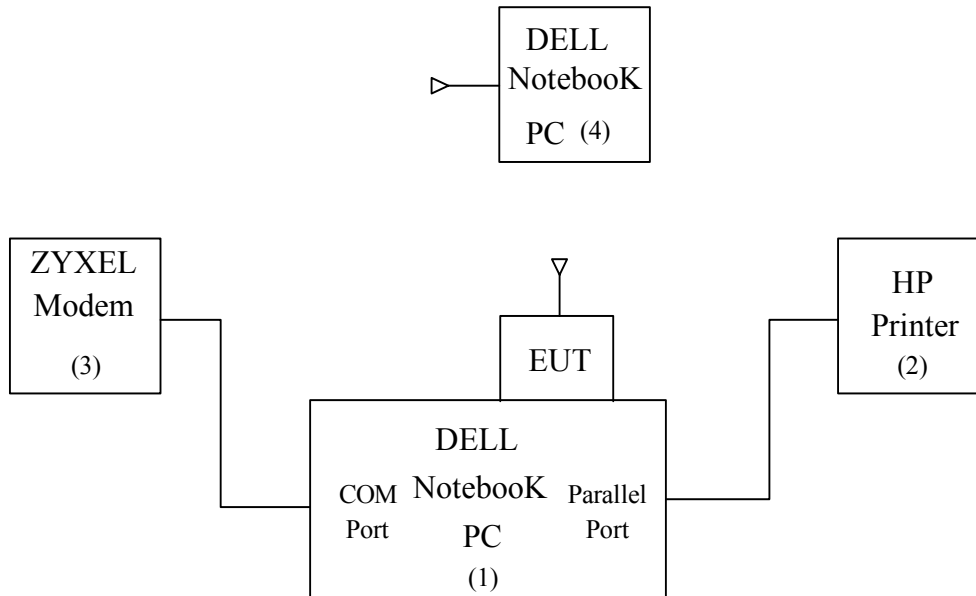

1.5 EUT Operating Condition

1. Set up all computers like the setup diagram.
2. NB (1) ping 192.168.1.90 -t -l 5000 to EUT
3. NB (4) ping 192.168.1.80 -t -l 5000 to NB(1)
4. All of the function are under run.
5. Start test.



Ecom Sertech Corp.

Rm. 258, Bldg. 17, NO.195, Sec. 4 Chung Hsing Rd., ChuTung Chen, Hsinchu, Taiwan 310, R.O.C
TEL:886-3-5918012 FAX: 886-3-5825720

FCC ID : QDWWN360G
Report No. : ER03-06-079FRF
Page 8 of 55

1.6 Description of Test Site

SITE DESCRIPTION : FCC certificate NO. : 90585
BSMI certificate NO. : SL2-IN-E-0002
NVLAP Lab code : 200118-0
CNLA certificate NO. : CNLA-ZL97018
VCCI certificate NO. : R-1229, C-1250

NAME OF SITE : Ecom Sertech Corp. Hsinchu
(Spin-off from ITRI / ERSO on April. 01, 2003)

SITE LOCATION : Rm.258, Bldg.17, NO.195 , Sec. 4, Chung Hsing Rd.,
Chu-Tung Chen. Hsin-Chu, Taiwan 310 R.O.C.

1.7 Summary of Test Results

The EUT has been tested according to the following specifications :

APPLIED STANDARD : 47 CFR Part 15, Subpart B and Subpart C			
Standard Section	Test Type and Limit	Result	REMARK
15.107 15.207	AC Power Conducted Emission Limit : Table 15.209	PASS	Meet the requirement of limit
15.247(a)(2)	Spectrum Bandwidth of a Direct Sequence Spread Spectrum System Limit : 6dB bandwidth > 500KHz	PASS	Meet the requirement of limit
15.247(b)	Maximum Peak Output Power Limit : max. 30dBm	PASS	Meet the requirement of limit
15.109 15.205 15.209	Transmitter Radiated Emissions Limit : Table 15.209	PASS	Meet the requirement of limit
15.247(d)	Power Spectral Density Limit : max. 8dBm	PASS	Meet the requirement of limit
15.247(c)	Out of Band Emission and Restricted Band Radiation Limit:20dB less than peak value of fundamental frequency Restricted band Limit:Table 15.209	PASS	Meet the requirement of limit



2. CONDUCTED POWERLINE TEST

2.1 Test Equipments

The following test equipments are used during the conducted powerline tests :

Manufacturer or Type	Model No	Serial No.	Date of Calibration	Calibration Period	Remark
SPECTRUM ANALYZER & DISPLAY	HP 8568A	2235A02320	APR. 01, 2003	1 Year	PRETEST
QUASI-PEAK ADAPTER	HP 85650 A	2341A00672	APR. 01, 2003	1 Year	PRETEST
ISOLATION TRANSFORMER	SOLAR 7032-1	N/A	N/A	N/A	FINAL
L.I.S.N.	EMCO 3850/2	9311-1025 9401-1028	JAN. 08, 2003 For Characteristic impedance MAY 18, 2003 For Insertion loss	1 Year	FINAL
TEST RECEIVER	R/S ESHS30	838550/003	JAN. 22, 2003	1 Year	FINAL
SHIELDED ROOM	KEENE 5983	NO.1	N/A	N/A	FINAL
PULSE LIMIT	R/S EHS3Z2	357.8810.52	JUL. 10, 2003	1 Year	FINAL
N TYPE COAXIAL CABLE	-----	-----	JUL. 10, 2003	1 Year	FINAL
50Ω TERMINATOR	-----	-----	JUL. 10, 2003	1 Year	FINAL

2.2 Test Setup

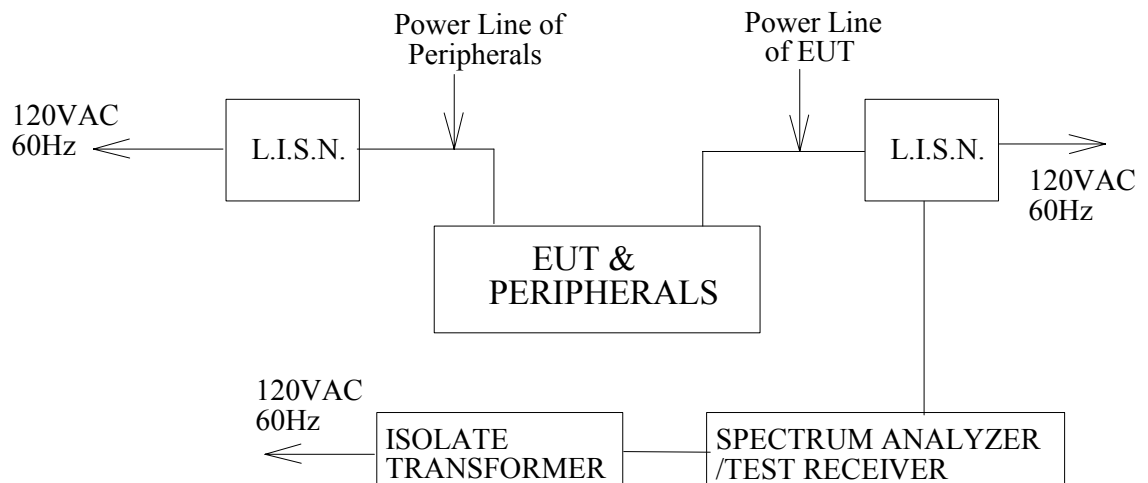



2.3 Conducted Power Line Emission Limit

All emanation from a class B computing device or system , including any network of conductors and apparatus connected thereto, shall not exceed the level of field strengths specified below :

Frequency (MHz)	Maximum Rf Line Voltage (dB μ V)			
	CLASS A		CLASS B	
	Q.P.	Ave.	Q.P.	Ave.
0.15 - 0.50	79	66	66-56	56-46
0.50 - 5.00	73	60	56	46
5.00 - 30.0	73	60	60	50

For intentional device, according to § 15.207(a) Line Conducted Emission Limit is same as above table.

2.4 Test Procedure

The test procedure is performed in a 12ft×12ft×8ft(L×W×H) shielded room. the EUT along with its peripherals were placed on a 1.0m(W)× 1.5m(L) and 0.8m in height wooden table and the EUT was adjusted to maintain a 0.4 meter space from a vertical reference plane. The EUT was connected to power mains through a line impedance stabilization network (LISN) which provides 50 ohm coupling impedance for measuring instrument and the chasis ground was bounded to the horizontal ground plane of shielded room. All peripherals were connected to the second LISN and the chasis ground also bounded to the horizontal ground plane of shielded room. The excess power cable between the EUT and the LISN was bundled. The power cables of peripherals were unbundled. All connecting cables of EUT and peripherals were moved to find the maximum emission.

2.5 Uncertainty of Conducted Emission

The uncertainty of conducted emission is ± 1.36 dB.



Ecom Sertech Corp.

Rm. 258, Bldg. 17, NO.195, Sec. 4 Chung Hsing Rd., ChuTung Chen, Hsinchu, Taiwan 310, R.O.C
TEL:886-3-5918012 FAX: 886-3-5825720

FCC ID : QDWWN360G
Report No. : ER03-06-079FRF
Page 11 of 55

2.6 Conducted Power Line Emission

The frequency spectrum from 0.45 MHz to 30 MHz was investigated. All emissions not reported below are more than 20 dB below the prescribed limits.

Temperature : 26 °C

Humidity : 65 % RH

Frequency (MHz)	Loss(dB)		Measurement				L1 Emission (dBμV)		L2 Emission (dBμV)		Limits (dBμV)	
			L1(dBμV)		L2(dBμV)		Q.P.	A.V.	Q.P.	A.V.	Q.P.	A.V.
	L1	L2	Q.P.	A.V.	Q.P.	A.V.						
0.150	0.1	0.2	*	*	*	*	*	*	*	*	66.00	56.00
0.264	0.10	0.20	39.90	*	*	*	40.00	*	*	*	61.30	51.30
0.267	0.10	0.20	*	*	38.00	*	*	*	38.20	*	61.21	51.21
0.531	0.10	0.20	*	*	36.50	*	*	*	36.70	*	56.00	46.00
0.597	0.10	0.20	28.70	*	*	*	28.80	*	*	*	56.00	46.00
0.729	0.10	0.20	*	*	28.00	*	*	*	28.20	*	56.00	46.00
1.944	0.10	0.20	*	*	16.60	*	*	*	16.80	*	56.00	46.00
1.992	0.10	0.20	27.00	*	*	*	27.10	*	*	*	56.00	46.00
2.931	0.19	0.20	*	*	21.70	*	*	*	21.90	*	56.00	46.00
4.050	0.20	0.20	27.60	*	*	*	27.80	*	*	*	56.00	46.00
4.782	0.20	0.20	*	*	27.00	*	*	*	27.20	*	60.00	50.00
7.173	0.32	0.30	30.00	*	*	*	30.32	*	*	*	60.00	50.00
9.000	0.40	0.40	39.20	*	*	*	39.60	*	*	*	60.00	50.00
12.783	0.50	0.50	24.00	*	*	*	24.50	*	*	*	60.00	50.00
13.149	0.50	0.51	*	*	32.10	*	*	*	32.61	*	61.00	51.00
15.477	0.65	0.65	*	*	30.70	*	*	*	31.35	*	60.00	50.00
15.492	0.65	0.65	23.40	*	*	*	24.05	*	*	*	60.00	50.00
30.000	1.4	1.8	*	*	*	*	*	*	*	*	60.00	50.00

REMARKS : 1. * Undetectable or the Q.P.values is lower than the limits of Ave.

2.7 Photos Of Conduction Test



3. RADIATED EMISSION TEST

3.1 Test Equipments

The following test equipments are utilized in making the measurements contained in this report.

Manufacturer Or Type	Model No	Serial No	Date Of Calibration	Calibration Period	Remark
CHASE BI-LOG ANTENNA	CBL6112B	2421	MAY 07, 2003	1 Year	FINAL
R/S TEST RECEIVER	ESMI	842088/005 841978/008	SEPT. 03, 2002	1 Year	FINAL
OPEN SITE	-----	No.2	JAN. 10, 2003	1 Year	FINAL
N TYPE COAXIAL CABLE	CHA9525	4	JUL. 13, 2002	1 Year	FINAL
Horn Antenna	AH-118	10089	FEB. 25, 2003	1 Year	FINAL
HP Pre-amplifier	8449B	3008A01471	OCT. 11, 2002	1 Year	FINAL
HP High pass filter	84300/80038	011	cal. on use	1 Year	FINAL
Horn Antenna	AH-840	03077	FEB. 25, 2003	1 Year	FINAL

3.2 Test Setup

The diagram below shows the test setup which is utilized to make these measurements.

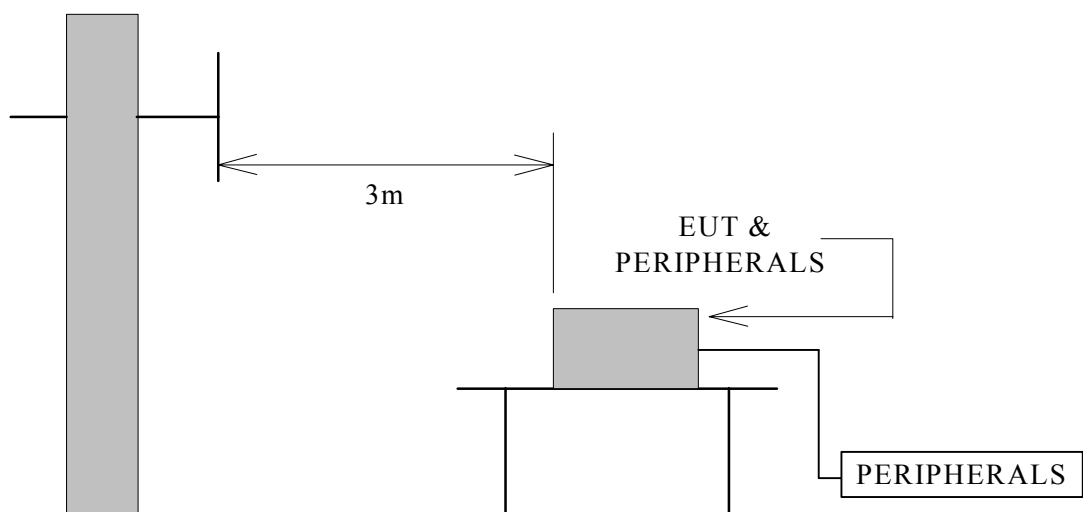

Antenna Elevation Variable



Ecom Sertech Corp.

Rm. 258, Bldg. 17, NO.195, Sec. 4 Chung Hsing Rd., ChuTung Chen, Hsinchu, Taiwan 310, R.O.C
TEL:886-3-5918012 FAX: 886-3-5825720

FCC ID : QDWWN360G
Report No. : ER03-06-079FRF
Page 14 of 55

3.3 Radiation Limit

For unintentional device, according to § 15.109(a), except for Class A digital devices, the field strength of radiated emissions from unintentional radiators at a distance of 3 meters shall not exceed the following values :

Frequency (MHz)	Distance (METERS)	Radiated (dB μ V/M)	Radiated (μ V/M)
30-88	3	40.0	100
88-216	3	43.5	150
216-960	3	46.0	200
Above 960	3	54.0	500

For intentional device, according to § 15.209(a), the general requirement of field strength of radiated emissions from intentional radiators at a distance of 3 meters shall not exceed the above table.



3.4 Test Procedures

- a. The EUT was placed on the top of a rotating table 0.8 meters above the ground at a 10 meter open area test site. The table was rotated 360 degrees to determine the position of the highest radiation.
- b. The EUT was set 3 meters away from the interference-receiving antenna, which was mounted on the top of a variable-height antenna tower.
- c. The antenna is a broadband antenna, and its height is varied from one meter to four meters above the ground to determine the maximum value of the field strength. Both horizontal and vertical polarizations of the antenna are set to make the measurement.
- d. For each suspected emission, the EUT was arranged to its worst case and then the antenna was tuned to heights from 1 meter to 4 meters and the rotatable table was turned from 0 degrees to 360 degrees to find the maximum reading.
- e. The test-receiver system was set to Peak Detect Function and Specified Bandwidth with Maximum Hold Mode.
- f. If the emission level of the EUT in peak mode was 10 dB lower than the limit specified, then testing could be stopped and the peak values of the EUT would be reported. Otherwise the emissions that did not have 10 dB margin would be re-tested one by one using peak, quasi-peak or average method as specified and then reported in a data sheet.

NOTE :

1. The resolution bandwidth and video bandwidth of test receiver/spectrum analyzer is 120 KHz for Peak detection (PK) and Quasi-peak detection (QP) at frequency below 1GHz.
2. The resolution bandwidth and video bandwidth of test receiver/spectrum analyzer is 1 MHz for Peak detection and frequency above 1GHz.
3. The resolution bandwidth of test receiver/spectrum analyzer is 1 MHz and the video bandwidth is 10 Hz for Average detection (AV) at frequency above 1GHz.

3.5 Uncertainty of Radiated Emission

The uncertainty of radiated emission is ± 2.72 dB.



3.6 Radiated Rf Noise Measurement

Test Requirement: 15.109, 15.209

The frequency spectrum from 30 MHz to 1000 MHz was investigated. All emissions not reported below are more than 20 dB below the prescribed limits.

All readings are quasi-peak values.

Temperature : 31 °C

Humidity : 53 % RH

Frequency (MHz)	Antenna Factor (dB)	Cable Loss (dB)	Meter Reading at 3m(dB μ V/M)		Limits at 3m (dB μ V/M)	Emission Level at 3m(dB μ V/M)	
			Horizontal	Vertical		Horizontal	Vertical
30.00	21.39	0.90	*	*	40.00	*	*
266.22	13.22	3.33	22.10	15.80	46.00	38.65	32.35
279.99	13.34	3.44	23.10	17.50	46.00	39.88	34.28
319.99	14.25	3.72	20.10	16.70	46.00	38.07	34.67
439.99	17.67	4.48	18.50	17.20	46.00	40.65	39.35
701.98	19.45	5.91	18.60	18.50	46.00	43.96	43.86
798.90	20.52	6.39	15.80	16.10	46.00	42.71	43.01
1000.00	21.58	7.00	*	*	54.00	*	*

REMARKS : 1. * Undetectable

2. Emission level (dB μ V/M) =Antenna Factor (dB/m) + Cable loss (dB)
+ Meter Reading (dB μ V).

3. According to technical experiences, all spurious emission at channel 1,6,11 are almost the same below 1GHz,so that the channel 1 was chosen as representation for the test.

4. For 11Mbps (802.11b Mode) .



Ecom Sertech Corp.

Rm. 258, Bldg. 17, NO.195, Sec. 4 Chung Hsing Rd.,ChuTung Chen, Hsinchu, Taiwan 310, R.O.C
TEL:886-3-5918012 FAX : 886-3-5825720

FCC ID : QDWWN360G
Report No. : ER03-06-079FRF
Page 17 of 55

Test Requirement: 15.109, 15.209

The frequency spectrum from 30 MHz to 1000 MHz was investigated. All emissions not reported below are more than 20 dB below the prescribed limits.

All readings are quasi-peak values.

Temperature : 31 °C

Humidity : 53 % RH

Frequency (MHz)	Antenna Factor (dB)	Cable Loss (dB)	Meter Reading at 3m(dB μ V/M)		Limits at 3m (dB μ V/M)	Emission Level at 3m(dB μ V/M)	
			Horizontal	Vertical		Horizontal	Vertical
			30.00	21.39		0.90	*
266.22	13.22	3.33	17.90	14.80	46.00	34.45	31.35
279.99	13.34	3.44	23.30	16.90	46.00	40.08	33.68
319.99	14.25	3.72	24.20	18.70	46.00	42.17	36.67
439.99	17.67	4.48	15.50	16.70	46.00	37.65	38.85
701.98	19.45	5.91	15.50	15.30	46.00	40.86	40.66
798.90	20.52	6.39	14.80	14.90	46.00	41.71	41.81
1000.00	21.58	7.00	*	*	54.00	*	*

REMARKS : 1. *Undetectable

2. Emission level (dB μ V/M) =Antenna Factor (dB/m) + Cable loss (dB)
+ Meter Reading (dB μ V).

3. According to technical experiences, all spurious emission at channel 1,6,11 are almost the same below 1GHz,so that the channel 1 was chosen as representation for the test.

4. For 54Mbps (802.11g Mode) .



Ecom Sertech Corp.

Rm. 258, Bldg. 17, NO.195, Sec. 4 Chung Hsing Rd., ChuTung Chen, Hsinchu, Taiwan 310, R.O.C
TEL:886-3-5918012 FAX : 886-3-5825720

FCC ID : QDWWN360G
Report No. : ER03-06-079FRF
Page 18 of 55

Test Requirement: 15.109 ,15.209

The frequency spectrum above 1 GHz was investigated. All emissions not reported below are more than 40 dB below the prescribed limits. Readings are both peak and average values.

Operation Mode:	Receiving	Test Date :	2003/7/5
Fundamental Frequency:	2412MHz (CH 1)	Test By:	K.P. Pang
Temperature :	27 °C	Humidity :	65%

Freq.	Reading	AF	Closs	Pre-amp	Dist	Filter	Level	Limit	Margin	Mark	Pol.	Height
MHz	dBuV	dBuV	dB	dB	dB	dB	dBuV/m	dBuV/m	dB	P/Q/A	H/V	Meter
4823.91	47.32	34.44	2.77	35.38	9.5	0	39.65	74	-34.35	P	H	1.0
4823.91	44.36	34.44	2.77	35.38	9.5	0	36.69	54	-17.31	A	H	1.0
7236.84	40.12	39.81	3.94	35.56	9.5	0	38.81	74	-35.19	P	H	1.0
7236.84	28.01	39.81	3.94	35.56	9.5	0	26.70	54	-27.30	A	H	1.0
9647.88	43.61	38.54	4.10	35.67	9.5	0	41.07	74	-32.93	P	H	1.0
9647.88	36.31	38.54	4.10	35.67	9.5	0	33.77	54	-20.23	A	H	1.0
4823.81	50.87	34.44	2.77	35.38	9.5	0	43.20	74	-30.80	P	V	1.0
4823.81	49.98	34.44	2.77	35.38	9.5	0	42.31	54	-11.69	A	V	1.0
7236.11	39.12	39.81	3.94	35.56	9.5	0	37.81	74	-36.19	P	V	1.0
7236.11	28.01	39.81	3.94	35.56	9.5	0	26.70	54	-27.30	A	V	1.0
9647.95	46.27	38.54	4.10	35.67	9.5	0	43.73	74	-30.27	P	V	1.0
9647.95	40.12	38.54	4.10	35.67	9.5	0	37.58	54	-16.42	A	V	1.0

Note :

1. Measurement was up to 18GHz harmonic,“---” means that the emissions level is too low to be measured.
2. AF: Antenna Factor, Closs: Cable Loss, Pre-Amp: Preamplifier gain,
Filter: High Pass Filter Insertion Loss (3.5GHz)
3. Analyzer setting P(Peak): RBW=1MHz, VBW=1MHz, A(Average): RBW=1MHz,VBW=10Hz
4. Dist : correction to extrea plate reading to 3m specification distance 1m measurement
distance = -9.5dB
5. The result basic equation calculation as follow :
Level = Reading + AF + Closs - Preamp + Fitler - Dist, Margin = Level - Limit
6. for wireless 802.11b mode



Ecom Sertech Corp.

Rm. 258, Bldg. 17, NO.195, Sec. 4 Chung Hsing Rd., ChuTung Chen, Hsinchu, Taiwan 310, R.O.C
TEL:886-3-5918012 FAX : 886-3-5825720

FCC ID : QDWWN360G
Report No. : ER03-06-079FRF
Page 19 of 55

Test Requirement: 15.109 ,15.209

The frequency spectrum above 1 GHz was investigated. All emissions not reported below are more than 40 dB below the prescribed limits. Readings are both peak and average values.

Operation Mode:	Receiving	Test Date :	2003/7/5
Fundamental Frequency:	2437MHz (CH 6)	Test By:	K.P. Pang
Temperature :	27 °C	Humidity :	65%

Freq.	Reading	AF	Closs	Pre-amp	Dist	Filter	Level	Limit	Margin	Mark	Pol.	Height
MHz	dBuV	dBuV	dB	dB	dB	dB	dBuV/m	dBuV/m	dB	P/Q/A	H/V	Meter
4873.88	47.78	34.77	2.80	35.40	9.5	0	40.45	74	-33.55	P	H	1.0
4873.88	44.31	34.77	2.80	35.40	9.5	0	36.98	54	-17.02	A	H	1.0
7311.84	40.18	39.78	4.00	35.57	9.5	0	38.89	74	-35.11	P	H	1.0
7311.84	28.14	39.78	4.00	35.57	9.5	0	26.85	54	-27.15	A	H	1.0
9747.88	44.67	38.53	4.02	35.72	9.5	0	41.99	74	-32.01	P	H	1.0
9747.88	34.98	38.53	4.02	35.72	9.5	0	32.30	54	-21.70	A	H	1.0
4873.85	54.34	34.77	2.80	35.40	9.5	0	47.01	74	-26.99	P	V	1.0
4873.85	52.19	34.77	2.80	35.40	9.5	0	44.86	54	-9.14	A	V	1.0
7311.08	39.54	39.78	4.00	35.57	9.5	0	38.25	74	-35.75	P	V	1.0
7311.08	28.01	39.78	4.00	35.57	9.5	0	26.72	54	-27.28	A	V	1.0
9747.88	45.08	38.53	4.02	35.72	9.5	0	42.40	74	-31.60	P	V	1.0
9747.88	39.26	38.53	4.02	35.72	9.5	0	36.58	54	-17.42	A	V	1.0

Note :

1. Measurement was up to 18GHz harmonic,“---” means that the emissions level is too low to be measured.
2. AF: Antenna Factor, Closs: Cable Loss, Pre-Amp: Preamplifier gain,
Filter: High Pass Filter Insertion Loss (3.5GHz)
3. Analyzer setting P(Peak): RBW=1MHz, VBW=1MHz, A(Average): RBW=1MHz,VBW=10Hz
4. Dist : correction to extra plate reading to 3m specification distance 1m measurement
distance = -9.5dB
5. The result basic equation calculation as follow :
Level = Reading + AF + Closs - Preamp + Filtler - Dist, Margin = Level - Limit
6. for wireless 802.11b mode



Ecom Sertech Corp.

Rm. 258, Bldg. 17, NO.195, Sec. 4 Chung Hsing Rd., ChuTung Chen, Hsinchu, Taiwan 310, R.O.C
TEL:886-3-5918012 FAX : 886-3-5825720

FCC ID : QDWWN360G
Report No. : ER03-06-079FRF
Page 20 of 55

Test Requirement: 15.109 ,15.209

The frequency spectrum above 1 GHz was investigated. All emissions not reported below are more than 40 dB below the prescribed limits. Readings are both peak and average values.

Operation Mode:	Receiving	Test Date :	2003/7/5
Fundamental Frequency:	2462MHz (CH 11)	Test By:	K.P. Pang
Temperature :	27 °C	Humidity :	65%

Freq.	Reading	AF	Closs	Pre-amp	Dist	Filter	Level	Limit	Margin	Mark	Pol.	Height
MHz	dBuV	dBuV	dB	dB	dB	dB	dBuV/m	dBuV/m	dB	P/Q/A	H/V	Meter
4923.85	50.88	35.10	2.83	35.41	9.5	0	43.90	74	-30.10	P	H	1.0
4923.85	48.32	35.10	2.83	35.41	9.5	0	41.34	54	-12.66	A	H	1.0
7386.68	39.41	39.75	4.06	35.57	9.5	0	38.14	74	-35.86	P	H	1.0
7386.68	28.21	39.75	4.06	35.57	9.5	0	26.94	54	-27.06	A	H	1.0
9847.83	45.67	38.52	3.93	35.77	9.5	0	42.85	74	-31.15	P	H	1.0
9847.83	37.46	38.52	3.93	35.77	9.5	0	34.64	54	-19.36	A	H	1.0
4923.85	54.36	35.10	2.83	35.41	9.5	0	47.38	74	-26.62	P	V	1.0
4923.85	56.48	35.10	2.83	35.41	9.5	0	49.50	54	-4.50	A	V	1.0
7386.76	39.45	39.75	4.06	35.57	9.5	0	38.18	74	-35.82	P	V	1.0
7386.76	27.68	39.75	4.06	35.57	9.5	0	26.41	54	-27.59	A	V	1.0
9847.83	45.12	38.52	3.93	35.77	9.5	0	42.30	74	-31.70	P	V	1.0
9847.83	39.88	38.52	3.93	35.77	9.5	0	37.06	54	-16.94	A	V	1.0

Note :

1. Measurement was up to 18GHz harmonic,“---” means that the emissions level is too low to be measured.
2. AF: Antenna Factor, Closs: Cable Loss, Pre-Amp: Preamplifier gain, Filter: High Pass Filter Insertion Loss (3.5GHz)
3. Analyzer setting P(Peak): RBW=1MHz, VBW=1MHz, A(Average): RBW=1MHz,VBW=10Hz
4. Dist : correction to extra plate reading to 3m specification distance 1m measurement distance = -9.5dB
5. The result basic equation calculation as follow :
Level = Reading + AF + Closs - Preamp + Filtler - Dist, Margin = Level - Limit
6. for wireless 802.11b mode



Ecom Sertech Corp.

Rm. 258, Bldg. 17, NO.195, Sec. 4 Chung Hsing Rd.,ChuTung Chen, Hsinchu, Taiwan 310, R.O.C
TEL:886-3-5918012 FAX : 886-3-5825720

FCC ID : QDWWN360G
Report No. : ER03-06-079FRF
Page 21 of 55

Test Requirement: 15.109 ,15.209

The frequency spectrum above 1 GHz was investigated. All emissions not reported below are more than 40 dB below the prescribed limits. Readings are both peak and average values.

Operation Mode:	Receiving	Test Date :	2003/7/5
Fundamental Frequency:	2412MHz (CH 1)	Test By:	K.P. Pang
Temperature :	27 °C	Humidity :	65%

Freq.	Reading	AF	Closs	Pre-amp	Dist	Filter	Level	Limit	Margin	Mark	Pol.	Height
MHz	dBuV	dBuV	dB	dB	dB	dB	dBuV/m	dBuV/m	dB	P/Q/A	H/V	Meter
4823.91	47.61	34.4	2.77	35.38	9.5	0	39.94	74	-34.06	P	H	1.0
4823.91	43.93	34.4	2.77	35.38	9.5	0	36.26	54	-17.74	A	H	1.0
7236.84	39.31	39.8	3.94	35.56	9.5	0	38.00	74	-36.00	P	H	1.0
7236.84	27.32	39.8	3.94	35.56	9.5	0	26.01	54	-27.99	A	H	1.0
9647.88	43.52	38.5	4.10	35.67	9.5	0	40.98	74	-33.02	P	H	1.0
9647.88	35.83	38.5	4.10	35.67	9.5	0	33.29	54	-20.71	A	H	1.0
4823.81	51.75	34.4	2.77	35.38	9.5	0	44.08	74	-29.92	P	V	1.0
4823.81	50.02	34.4	2.77	35.38	9.5	0	42.35	54	-11.65	A	V	1.0
7236.11	39.41	39.8	3.94	35.56	9.5	0	38.10	74	-35.90	P	V	1.0
7236.11	27.32	39.8	3.94	35.56	9.5	0	26.01	54	-27.99	A	V	1.0
9647.95	45.25	38.5	4.10	35.67	9.5	0	42.71	74	-31.29	P	V	1.0
9647.95	39.61	38.5	4.10	35.67	9.5	0	37.07	54	-16.93	A	V	1.0

Note :

1. Measurement was up to 18GHz harmonic,“---” means that the emissions level is too low to be measured.
2. AF: Antenna Factor, Closs: Cable Loss, Pre-Amp: Preamplifier gain,
Filter: High Pass Filter Insertion Loss (3.5GHz)
3. Analyzer setting P(Peak): RBW=1MHz, VBW=1MHz, A(Average): RBW=1MHz,VBW=10Hz
4. Dist : correction to extra plate reading to 3m specification distance 1m measurement
distance = -9.5dB
5. The result basic equation calculation as follow :
Level = Reading + AF + Closs - Preamp + Filtler - Dist, Margin = Level - Limit
6. for wireless 802.1g mode



Ecom Sertech Corp.

Rm. 258, Bldg. 17, NO.195, Sec. 4 Chung Hsing Rd., ChuTung Chen, Hsinchu, Taiwan 310, R.O.C
 TEL:886-3-5918012 FAX: 886-3-5825720

FCC ID : QDWWN360G
 Report No. : ER03-06-079FRF
 Page 22 of 55

Test Requirement: 15.109 ,15.209

The frequency spectrum above 1 GHz was investigated. All emissions not reported below are more than 40 dB below the prescribed limits. Readings are both peak and average values.

Operation Mode:	Receiving	Test Date :	2003/7/5
Fundamental Frequency:	2437MHz (CH 6)	Test By:	K.P. Pang
Temperature :	27 °C	Humidity :	65%

Freq.	Reading	AF	Closs	Pre-amp	Dist	Filter	Level	Limit	Margin	Mark	Pol.	Height
MHz	dBuV	dBuV	dB	dB	dB	dB	dBuV/m	dBuV/m	dB	P/Q/A	H/V	Meter
4873.88	47.71	34.77	2.80	35.40	9.5	0	40.38	74	-33.62	P	H	1.0
4873.88	44.31	34.77	2.80	35.40	9.5	0	36.98	54	-17.02	A	H	1.0
7311.84	40.65	39.78	4.00	35.57	9.5	0	39.36	74	-34.64	P	H	1.0
7311.84	27.93	39.78	4.00	35.57	9.5	0	26.64	54	-27.36	A	H	1.0
9747.88	43.24	38.53	4.02	35.72	9.5	0	40.56	74	-33.44	P	H	1.0
9747.88	35.55	38.53	4.02	35.72	9.5	0	32.87	54	-21.13	A	H	1.0
4873.85	55.53	34.77	2.80	35.40	9.5	0	48.20	74	-25.80	P	V	1.0
4873.85	53.91	34.77	2.80	35.40	9.5	0	46.58	54	-7.42	A	V	1.0
7311.08	39.05	39.78	4.00	35.57	9.5	0	37.76	74	-36.24	P	V	1.0
7311.08	27.09	39.78	4.00	35.57	9.5	0	25.80	54	-28.20	A	V	1.0
9747.88	44.92	38.53	4.02	35.72	9.5	0	42.24	74	-31.76	P	V	1.0
9747.88	38.57	38.53	4.02	35.72	9.5	0	35.89	54	-18.11	A	V	1.0

Note :

1. Measurement was up to 18GHz harmonic,“---” means that the emissions level is too low to be measured.
2. AF: Antenna Factor, Closs: Cable Loss, Pre-Amp: Preamplifier gain,
Filter: High Pass Filter Insertion Loss (3.5GHz)
3. Analyzer setting P(Peak): RBW=1MHz, VBW=1MHz, A(Average): RBW=1MHz,VBW=10Hz
4. Dist : correction to extra plate reading to 3m specification distance 1m measurement
distance = -9.5dB
5. The result basic equation calculation as follow :
Level = Reading + AF + Closs - Preamp + Filtler - Dist, Margin = Level - Limit
6. for wireless 802.11g mode



Ecom Sertech Corp.

Rm. 258, Bldg. 17, NO.195, Sec. 4 Chung Hsing Rd., ChuTung Chen, Hsinchu, Taiwan 310, R.O.C
TEL:886-3-5918012 FAX : 886-3-5825720

FCC ID : QDWWN360G
Report No. : ER03-06-079FRF
Page 23 of 55

Test Requirement: 15.109 ,15.209

The frequency spectrum above 1 GHz was investigated. All emissions not reported below are more than 40 dB below the prescribed limits. Readings are both peak and average values.

Operation Mode:	Receiving	Test Date :	2003/7/5
Fundamental Frequency:	2462MHz (CH 11)	Test By:	K.P. Pang
Temperature :	27 °C	Humidity :	65%

Freq.	Reading	AF	Closs	Pre-amp	Dist	Filter	Level	Limit	Margin	Mark	Pol.	Height
MHz	dBuV	dBuV	dB	dB	dB	dB	dBuV/m	dBuV/m	dB	P/Q/A	H/V	Meter
4923.85	51.09	35.10	2.83	35.41	9.5	0	44.11	74	-29.89	P	H	1.0
4923.85	47.76	35.10	2.83	35.41	9.5	0	40.78	54	-13.22	A	H	1.0
7386.68	39.31	39.75	4.06	35.57	9.5	0	38.04	74	-35.96	P	H	1.0
7386.68	27.27	39.75	4.06	35.57	9.5	0	26.00	54	-28.00	A	H	1.0
9847.83	44.67	38.52	3.93	35.77	9.5	0	41.85	74	-32.15	P	H	1.0
9847.83	36.56	38.52	3.93	35.77	9.5	0	33.74	54	-20.26	A	H	1.0
4923.85	57.97	35.10	2.83	35.41	9.5	0	50.99	74	-23.01	P	V	1.0
4923.85	56.55	35.10	2.83	35.41	9.5	0	49.57	54	-4.43	A	V	1.0
7386.76	39.12	39.75	4.06	35.57	9.5	0	37.85	74	-36.15	P	V	1.0
7386.76	27.27	39.75	4.06	35.57	9.5	0	26.00	54	-28.00	A	V	1.0
9847.83	45.68	38.52	3.93	35.77	9.5	0	42.86	74	-31.14	P	V	1.0
9847.83	39.13	38.52	3.93	35.77	9.5	0	36.31	54	-17.69	A	V	1.0

Note :

1. Measurement was up to 18GHz harmonic,“---” means that the emissions level is too low to be measured.
2. AF: Antenna Factor, Closs: Cable Loss, Pre-Amp: Preamplifier gain, Filter: High Pass Filter Insertion Loss (3.5GHz)
3. Analyzer setting P(Peak): RBW=1MHz, VBW=1MHz, A(Average): RBW=1MHz,VBW=10Hz
4. Dist : correction to extra plate reading to 3m specification distance 1m measurement distance = -9.5dB
5. The result basic equation calculation as follow :
Level = Reading + AF + Closs - Preamp + Filtler - Dist, Margin = Level - Limit
6. for wireless 802.11g mode



Ecom Sertech Corp.

Rm. 258, Bldg. 17, NO.195, Sec. 4 Chung Hsing Rd., ChuTung Chen, Hsinchu, Taiwan 310, R.O.C
 TEL:886-3-5918012 FAX : 886-3-5825720

FCC ID : QDWWN360G
 Report No. : ER03-06-079FRF
 Page 24 of 55

Test Requirement: 15.205

The frequency spectrum above 1 GHz was investigated. All emissions not reported below are more than 40 dB below the prescribed limits. Readings are both peak and average values.

Operation Mode:	Transmitting	Test Date :	2003/7/5
Fundamental Frequency:	2412MHz (CH 1)	Test By:	K.P. Pang
Temperature :	30 °C	Humidity :	65%

Freq.	Reading	AF	Closs	Pre-amp	Dist	Filter	Level	Limit	Margin	Mark	Pol.	Height
MHz	dBuV	dBuV	dB	dB	dB	dB	dBuV/m	dBuV/m	(dB)	(P/Q/A)	(H/V)	(Meter)
2411.11	81.19	31.79	2.36	0.00	9.5	0	105.83	Fundamental frequency		P	H	1.0
2412.47	73.71	31.79	2.36	0.00	9.5	0	98.36		A	H	1.0	
4823.93	47.74	34.44	2.77	35.38	9.5	1	41.07	74	-32.93	P	H	1.0
4823.93	43.78	34.44	2.77	35.38	9.5	1	37.11	54	-16.89	A	H	1.0
7235.72	39.48	39.81	3.94	35.56	9.5	1	39.17	74	-34.83	P	H	1.0
7235.72	27.52	39.81	3.94	35.56	9.5	1	27.21	54	-26.79	A	H	1.0
9647.83	43.55	38.54	4.10	35.67	9.5	1	42.01	74	-31.99	P	H	1.0
9647.83	35.85	38.54	4.10	35.67	9.5	1	34.31	54	-19.69	A	H	1.0
12059.93*	---	42.60	15.20	35.30	9.5	1	---	---	---	---	H	1.0
14471.97*	---	43.40	16.80	34.00	9.5	1	---	---	---	---	H	1.0
16884.01	---	45.20	17.60	34.30	9.5	1	---	---	---	---	H	1.0
19296.05*	---	36.30	18.50	34.30	9.5	1	---	---	---	---	H	1.0
21708.09	---	36.20	19.20	34.60	9.5	1	---	---	---	---	H	1.0
24120.13	---	36.80	21.00	34.20	9.5	1	---	---	---	---	H	1.0

Note :

- The measurement was searched to 10th harmonic, Remark “---” means that the emissions level is too low to be measured.
- AF: Antenna Factor, Closs: Cable Loss, Pre-Amp: Preamplifier gain, Filter: High Pass Filter Insertion Loss (3.5GHz)
- Analyzer setting P(Peak): RBW=1MHz, VBW=1MHz, A(Average): RBW=1MHz, VBW=10Hz
- Remark “*” means that Restricted band.
- Dist : correction to extra plate reading to 3m specification distance 1m measurement
 $distance = -9.5dB$
- The result basic equation calculation is as follow:
 $Level=Reading+AF+Closs-Preamp+Filter-Dist, Margin=Level-Limit$
- The other emission levels were very low against the limit
- for wireless 802.11b mode
- Test Distance : at 3M



Ecom Sertech Corp.

Rm. 258, Bldg. 17, NO.195, Sec. 4 Chung Hsing Rd., ChuTung Chen, Hsinchu, Taiwan 310, R.O.C
 TEL:886-3-5918012 FAX : 886-3-5825720

FCC ID : QDWWN360G
 Report No. : ER03-06-079FRF
 Page 25 of 55

Test Requirement: 15.205

The frequency spectrum above 1 GHz was investigated. All emissions not reported below are more than 40 dB below the prescribed limits. Readings are both peak and average values.

Operation Mode:	Transmitting	Test Date :	2003/7/5
Fundamental Frequency:	2412MHz (CH 1)	Test By:	K.P. Pang
Temperature :	30 °C	Humidity :	65%

Freq.	Reading	AF	Closs	Pre-amp	Dist	Filter	Level	Limit	Margin	Mark	Pol.	Height
MHz	dBuV	dBuV	dB	dB	dB	dB	dBuV/m	dBuV/m	dB	P/Q/A	H/V	Meter
2411.22	76.32	31.79	2.36	0.00	9.5	0	100.96	Fundamental frequency		P	V	1.0
2411.22	71.24	31.79	2.36	0.00	9.5	95.88	A			V	1.0	
4823.87	51.22	34.44	2.77	35.38	9.5	1	44.55	74	-29.45	P	V	1.0
4823.87	47.76	34.44	2.77	35.38	9.5	1	41.09	54	-12.91	A	V	1.0
7236.94	40.52	39.81	3.94	35.56	9.5	1	40.21	74	-33.79	P	V	1.0
7236.94	28.61	39.81	3.94	35.56	9.5	1	28.30	54	-25.70	A	V	1.0
9647.83	44.91	38.54	4.10	35.67	9.5	1	43.37	74	-30.63	P	V	1.0
9647.83	38.32	38.54	4.10	35.67	9.5	1	36.78	54	-17.22	A	V	1.0
12059.93*	---	42.60	15.20	35.30	9.5	1	---	---	---	---	V	1.0
14471.97*	---	43.40	16.80	34.00	9.5	1	---	---	---	---	V	1.0
16884.01	---	45.20	17.60	34.30	9.5	1	---	---	---	---	V	1.0
19296.05*	---	36.30	18.50	34.30	9.5	1	---	---	---	---	V	1.0
21708.09	---	36.20	19.20	34.60	9.5	1	---	---	---	---	V	1.0
24120.13	---	36.80	21.00	34.20	9.5	1	---	---	---	---	V	1.0

Note :

- The measurement was searched to 10th harmonic, Remark “---” means that the emissions level is too low to be measured.
- AF: Antenna Factor, Closs: Cable Loss, Pre-Amp: Preamplifier gain, Filter: High Pass Filter Insertion Loss (3.5GHz)
- Analyzer setting P(Peak): RBW=1MHz, VBW=1MHz, A(Average): RBW=1MHz, VBW=10Hz
- Remark “*” means that Restricted band.
- Dist : correction to extrea plate reading to 3m specification distance 1m measurement distance = -9.5dB
- The result basic equation calculation is as follow:
 $Level=Reading+AF+Closs+Preamp+Filter-Dist, Margin=Level-Limit$
- The other emission levels were very low against the limit
- for wireless 802.11b mode
- Test Distance : at 3M



Ecom Sertech Corp.

Rm. 258, Bldg. 17, NO.195, Sec. 4 Chung Hsing Rd., ChuTung Chen, Hsinchu, Taiwan 310, R.O.C
 TEL:886-3-5918012 FAX : 886-3-5825720

FCC ID : QDWWN360G
 Report No. : ER03-06-079FRF
 Page 26 of 55

Test Requirement: 15.205

The frequency spectrum above 1 GHz was investigated. All emissions not reported below are more than 40 dB below the prescribed limits. Readings are both peak and average values.

Operation Mode:	Transmitting	Test Date :	2003/7/5
Fundamental Frequency:	2437MHz (CH 6)	Test By:	K.P. Pang
Temperature :	30 °C	Humidity :	65%

Freq.	Reading	AF	Closs	Pre-amp	Dist	Filter	Level	Limit	Margin	Mark	Pol.	Height
MHz	dBuV	dBuV	dB	dB	dB	dB	dBuV/m	dBuV/m	dB	P/Q/A	H/V	Meter
2437.55	79.62	31.76	2.43	0.00	9.5	0	104.31	Fundamental frequency		P	H	1.0
2437.55	72.16	31.76	2.43	0.00	9.5	0	96.85		A	H	1.0	
4873.84	49.68	34.77	2.80	35.40	9.5	1	43.35	74	-30.65	P	H	1.0
4873.84	44.86	34.77	2.80	35.40	9.5	1	38.53	54	-15.47	A	H	1.0
7311.51	40.31	39.78	4.00	35.57	9.5	1	40.02	74	-33.98	P	H	1.0
7311.51	28.26	39.78	4.00	35.57	9.5	1	27.97	54	-26.03	A	H	1.0
9747.89	43.52	38.53	4.02	35.72	9.5	1	41.84	74	-32.16	P	H	1.0
9747.89	34.32	38.53	4.02	35.72	9.5	1	32.64	54	-21.36	A	H	1.0
12185.10*	---	32.14	4.53	35.24	9.5	1	---	---	---	---	H	1.0
14622.12	---	43.40	16.80	34.00	9.5	1	---	---	---	---	H	1.0
17059.14	---	45.20	17.60	34.30	9.5	1	---	---	---	---	H	1.0
19496.16*	---	36.30	18.50	34.30	9.5	1	---	---	---	---	H	1.0
21933.18	---	36.20	19.20	34.60	9.5	1	---	---	---	---	H	1.0
24370.2	---	36.80	21.00	34.20	9.5	1	---	---	---	---	H	1.0

Note :

1. The measurement was searched to 10th harmonic, Remark “---” means that the emissions level is too low to be measured.
2. AF: Antenna Factor, Closs: Cable Loss, Pre-Amp: Preamplifier gain, Filter: High Pass Filter Insertion Loss (3.5GHz)
3. Analyzer setting P(Peak): RBW=1MHz, VBW=1MHz, A(Average): RBW=1MHz, VBW=10Hz
4. Remark “*” means that Restricted band.
5. Dist : correction to extra plate reading to 3m specification distance 1m measurement
 $distance = -9.5dB$
6. The result basic equation calculation is as follow:
 $Level=Reading+AF+Closs-Preamp+Filter-Dist, Margin=Level-Limit$
7. The other emission levels were very low against the limit
8. for wireless 802.11b mode
9. Test Distance : at 3M



Ecom Sertech Corp.

Rm. 258, Bldg. 17, NO.195, Sec. 4 Chung Hsing Rd., ChuTung Chen, Hsinchu, Taiwan 310, R.O.C
 TEL:886-3-5918012 FAX : 886-3-5825720

FCC ID : QDWWN360G
 Report No. : ER03-06-079FRF
 Page 27 of 55

Test Requirement: 15.205

The frequency spectrum above 1 GHz was investigated. All emissions not reported below are more than 40 dB below the prescribed limits. Readings are both peak and average values.

Operation Mode:	Transmitting	Test Date :	2003/7/5
Fundamental Frequency:	2437MHz (CH 6)	Test By:	K.P. Pang
Temperature :	30 °C	Humidity :	65%

Freq.	Reading	AF	Closs	Pre-amp	Dist	Filter	Level	Limit	Margin	Mark	Pol.	Height
MHz	dBuV	dBuV	dB	dB	dB	dB	dBuV/m	dBuV/m	dB	P/Q/A	H/V	Meter
2437.88	72.36	31.76	2.43	0.00	9.5	0	97.05	Fundamental frequency		P	V	1.0
2437.88	65.53	31.76	2.43	0.00	9.5	0	90.22			A	V	1.0
4873.81	51.52	34.77	2.80	35.40	9.5	1	45.19	74	-28.81	P	V	1.0
4873.81	48.52	34.77	2.80	35.40	9.5	1	42.19	54	-11.81	A	V	1.0
7312.51	40.96	39.77	4.00	35.57	9.5	1	40.67	74	-33.33	P	V	1.0
7312.51	28.92	39.77	4.00	35.57	9.5	1	28.63	54	-25.37	A	V	1.0
9747.77	45.91	38.53	4.02	35.72	9.5	1	44.23	74	-29.77	P	V	1.0
9747.77	38.84	38.53	4.02	35.72	9.5	1	37.16	54	-16.84	A	V	1.0
12185.10*	---	32.14	4.53	35.24	9.5	1	---	---	---	---	V	1.0
14622.12	---	43.40	16.80	34.00	9.5	1	---	---	---	---	V	1.0
17059.14	---	45.20	17.60	34.30	9.5	1	---	---	---	---	V	1.0
19496.16*	---	36.30	18.50	34.30	9.5	1	---	---	---	---	V	1.0
21933.18	---	36.20	19.20	34.60	9.5	1	---	---	---	---	V	1.0
24370.20	---	36.80	21.00	34.20	9.5	1	---	---	---	---	V	1.0

Note :

- The measurement was searched to 10th harmonic, Remark “---” means that the emissions level is too low to be measured.
- AF: Antenna Factor, Closs: Cable Loss, Pre-Amp: Preamplifier gain, Filter: High Pass Filter Insertion Loss (3.5GHz)
- Analyzer setting P(Peak): RBW=1MHz, VBW=1MHz, A(Average): RBW=1MHz, VBW=10Hz
- Remark “*” means that Restricted band.
- Dist : correction to extrea plate reading to 3m specification distance 1m measurement
 distance = -9.5dB
- The result basic equation calculation is as follow:
 Level=Reading+AF+Closs+Preamp+Filter-Dist,Margin=Level-Limit
- The other emission levels were very low against the limit
- for wireless 802.11b mode
- Test Distance : at 3M



Ecom Sertech Corp.

Rm. 258, Bldg. 17, NO.195, Sec. 4 Chung Hsing Rd., ChuTung Chen, Hsinchu, Taiwan 310, R.O.C
 TEL:886-3-5918012 FAX : 886-3-5825720

FCC ID : QDWWN360G
 Report No. : ER03-06-079FRF
 Page 28 of 55

Test Requirement: 15.205

The frequency spectrum above 1 GHz was investigated. All emissions not reported below are more than 40 dB below the prescribed limits. Readings are both peak and average values.

Operation Mode:	Transmitting	Test Date :	2003/7/5
Fundamental Frequency:	2462MHz (CH 11)	Test By:	K.P. Pang
Temperature :	30 °C	Humidity :	65%

Freq.	Reading	AF	Closs	Pre-amp	Dist	Filter	Level	Limit	Margin	Mark	Pol.	Height
MHz	dBuV	dBuV	dB	dB	dB	dB	dBuV/m	dBuV/m	dB	P/Q/A	H/V	Meter
2461.88	78.77	31.74	2.49	0.00	9.5	0	103.50	Fundamental frequency		P	H	1.0
2461.88	70.70	31.74	2.49	0.00	9.5	0	95.43		A	H	1.0	
4923.82	50.45	35.10	2.83	35.41	9.5	1	44.47	74	-29.53	P	H	1.0
4923.82	46.72	35.10	2.83	35.41	9.5	1	40.74	54	-13.26	A	H	1.0
7386.68	39.82	39.75	4.06	35.57	9.5	1	39.55	74	-34.45	P	H	1.0
7386.68	27.93	39.75	4.06	35.57	9.5	1	27.66	54	-26.34	A	H	1.0
9848.01	43.25	38.52	3.93	35.77	9.5	1	41.43	74	-32.57	P	H	1.0
9848.01	33.74	38.52	3.93	35.77	9.5	1	31.92	54	-22.08	A	H	1.0
14772.06	---	43.40	16.80	34.00	9.5	1	---	---	---	---	H	1.0
17234.08	---	45.20	17.60	34.30	9.5	1	---	---	---	---	H	1.0
19696.1*	---	36.30	18.50	34.30	9.5	1	---	---	---	---	H	1.0
22158.12*	---	36.20	19.20	34.60	9.5	1	---	---	---	---	H	1.0
24620.14	---	36.80	21.00	34.20	9.5	1	---	---	---	---	H	1.0

Note :

- The measurement was searched to 10th harmonic, Remark “---” means that the emissions level is too low to be measured.
- AF: Antenna Factor, Closs: Cable Loss, Pre-Amp: Preamplifier gain, Filter: High Pass Filter Insertion Loss (3.5GHz)
- Analyzer setting P(Peak): RBW=1MHz, VBW=1MHz, A(Average): RBW=1MHz, VBW=10Hz
- Remark “*” means that Restricted band.
- Dist : correction to extra plate reading to 3m specification distance 1m measurement
 distance = -9.5dB
- The result basic equation calculation is as follow:
 Level=Reading+AF+Closs-Preamp+Filter-Dist, Margin=Level-Limit
- The other emission levels were very low against the limit
- for wireless 802.11b mode
- Test Distance : at 3M



Ecom Sertech Corp.

Rm. 258, Bldg. 17, NO.195, Sec. 4 Chung Hsing Rd., ChuTung Chen, Hsinchu, Taiwan 310, R.O.C
 TEL:886-3-5918012 FAX : 886-3-5825720

FCC ID : QDWWN360G
 Report No. : ER03-06-079FRF
 Page 29 of 55

Test Requirement: 15.205

The frequency spectrum above 1 GHz was investigated. All emissions not reported below are more than 40 dB below the prescribed limits. Readings are both peak and average values.

Operation Mode:	Transmitting	Test Date :	2003/7/5
Fundamental Frequency:	2462MHz (CH 11)	Test By:	K.P. Pang
Temperature :	30 °C	Humidity :	65%

Freq.	Reading	AF	Closs	Pre-amp	Dist	Filter	Level	Limit	Margin	Mark	Pol.	Height
MHz	dBuV	dBuV	dB	dB	dB	dB	dBuV/m	dBuV/m	dB	P/Q/A	H/V	Meter
2462.83	70.52	31.74	2.49	0.00	9.5	0	95.25	Fundamental frequency		P	V	1.0
2462.83	63.16	31.74	2.49	0.00	9.5	0	87.89		A	V	1.0	
4923.83	51.26	35.10	2.83	35.41	9.5	1	45.28	74	-28.72	P	V	1.0
4923.83	47.76	35.10	2.83	35.41	9.5	1	41.78	54	-12.22	A	V	1.0
7386.16	40.42	39.75	4.06	35.57	9.5	1	40.15	74	-33.85	P	V	1.0
7386.16	28.26	39.75	4.06	35.57	9.5	1	27.99	54	-26.01	A	V	1.0
9847.88	45.32	38.52	3.93	35.77	9.5	1	43.50	74	-30.50	P	V	1.0
9847.88	38.92	38.52	3.93	35.77	9.5	1	37.10	54	-16.90	A	V	1.0
12310.04*	---	32.14	4.53	35.24	9.5	1	---	---	---	---	V	1.0
14772.06	---	43.40	16.80	34.00	9.5	1	---	---	---	---	V	1.0
17234.08	---	45.20	17.60	34.30	9.5	1	---	---	---	---	V	1.0
19696.1*	---	36.30	18.50	34.30	9.5	1	---	---	---	---	V	1.0
22158.12*	---	36.20	19.20	34.60	9.5	1	---	---	---	---	V	1.0
24620.14	---	36.80	21.00	34.20	9.5	1	---	---	---	---	V	1.0

Note :

- The measurement was searched to 10th harmonic, Remark “---” means that the emissions level is too low to be measured.
- AF: Antenna Factor, Closs: Cable Loss, Pre-Amp: Preamplifier gain, Filter: High Pass Filter Insertion Loss (3.5GHz)
- Analyzer setting P(Peak): RBW=1MHz, VBW=1MHz, A(Average): RBW=1MHz, VBW=10Hz
- Remark “*” means that Restricted band.
- Dist : correction to extrea plate reading to 3m specification distance 1m measurement
 distance = -9.5dB
- The result basic equation calculation is as follow:
 Level=Reading+AF+Closs-Preamp+Filter-Dist,Margin=Level-Limit
- The other emission levels were very low against the limit
- for wireless 802.11b mode
- Test Distance : at 3M



Ecom Sertech Corp.

Rm. 258, Bldg. 17, NO.195, Sec. 4 Chung Hsing Rd., ChuTung Chen, Hsinchu, Taiwan 310, R.O.C
 TEL:886-3-5918012 FAX : 886-3-5825720

FCC ID : QDWWN360G
 Report No. : ER03-06-079FRF
 Page 30 of 55

Test Requirement: 15.205

The frequency spectrum above 1 GHz was investigated. All emissions not reported below are more than 40 dB below the prescribed limits. Readings are both peak and average values.

Operation Mode:	Transmitting	Test Date :	2003/7/5
Fundamental Frequency:	2412MHz (CH 1)	Test By:	K.P. Pang
Temperature :	30 °C	Humidity :	65%

Freq.	Reading	AF	Closs	Pre-amp	Dist	Filter	Level	Limit	Margin	Mark	Pol.	Height
MHz	dBuV	dBuV	dB	dB	dB	dB	dBuV/m	dBuV/m	(dB)	(P/Q/A)	(H/V)	(Meter)
2412.47	75.92	31.79	2.36	0.00	9.5	0	100.57	Fundamental frequency		P	H	1.0
2412.47	68.46	31.79	2.36	0.00	9.5	0	93.11		A	H	1.0	
4823.87	50.51	34.44	2.77	35.38	9.5	1	43.84	74	-30.16	P	H	1.0
4823.87	46.87	34.44	2.77	35.38	9.5	1	40.20	54	-13.80	A	H	1.0
7236.13	41.47	39.81	3.94	35.56	9.5	1	41.16	74	-32.84	P	H	1.0
7236.13	29.45	39.81	3.94	35.56	9.5	1	29.14	54	-24.86	A	H	1.0
9647.87	45.53	38.54	4.10	35.67	9.5	1	43.99	74	-30.01	P	H	1.0
9647.87	37.94	38.54	4.10	35.67	9.5	1	36.40	54	-17.60	A	H	1.0
12059.93*	---	42.60	15.20	35.30	9.5	1	---	---	---	---	H	1.0
14471.97*	---	43.40	16.80	34.00	9.5	1	---	---	---	---	H	1.0
16884.01	---	45.20	17.60	34.30	9.5	1	---	---	---	---	H	1.0
19296.05*	---	36.30	18.50	34.30	9.5	1	---	---	---	---	H	1.0
21708.09	---	36.20	19.20	34.60	9.5	1	---	---	---	---	H	1.0
24120.13	---	36.80	21.00	34.20	9.5	1	---	---	---	---	H	1.0

Note :

- The measurement was searched to 10th harmonic, Remark “---” means that the emissions level is too low to be measured.
- AF: Antenna Factor, Closs: Cable Loss, Pre-Amp: Preamplifier gain, Filter: High Pass Filter Insertion Loss (3.5GHz)
- Analyzer setting P(Peak): RBW=1MHz, VBW=1MHz, A(Average): RBW=1MHz, VBW=10Hz
- Remark “*” means that Restricted band.
- Dist : correction to extra plate reading to 3m specification distance 1m measurement
 $distance = -9.5dB$
- The result basic equation calculation is as follow:
 $Level=Reading+AF+Closs-Preamp+Filter-Dist, Margin=Level-Limit$
- The other emission levels were very low against the limit
- for wireless 802.11g mode
- Test Distance : at 3M



Ecom Sertech Corp.

Rm. 258, Bldg. 17, NO.195, Sec. 4 Chung Hsing Rd., ChuTung Chen, Hsinchu, Taiwan 310, R.O.C
 TEL:886-3-5918012 FAX : 886-3-5825720

FCC ID : QDWWN360G
 Report No. : ER03-06-079FRF
 Page 31 of 55

Test Requirement: 15.205

The frequency spectrum above 1 GHz was investigated. All emissions not reported below are more than 40 dB below the prescribed limits. Readings are both peak and average values.

Operation Mode:	Transmitting	Test Date :	2003/7/5
Fundamental Frequency:	2412MHz (CH 1)	Test By:	K.P. Pang
Temperature :	30 °C	Humidity :	65%

Freq.	Reading	AF	Closs	Pre-amp	Dist	Filter	Level	Limit	Margin	Mark	Pol.	Height
MHz	dBuV	dBuV	dB	dB	dB	dB	dBuV/m	dBuV/m	dB	P/Q/A	H/V	Meter
2410.27	73.69	31.79	2.35	0.00	9.5	0	98.33	Fundamental frequency		P	V	1.0
2410.27	65.71	31.79	2.35	0.00	9.5	0	90.35			A	V	1.0
4823.85	53.52	34.44	2.77	35.38	9.5	1	46.85	74	-27.15	P	V	1.0
4823.85	51.06	34.44	2.77	35.38	9.5	1	44.39	54	-9.61	A	V	1.0
7236.29	41.52	39.81	3.94	35.56	9.5	1	41.21	74	-32.79	P	V	1.0
7236.29	29.02	39.81	3.94	35.56	9.5	1	28.71	54	-25.29	A	V	1.0
9647.87	45.72	38.54	4.10	35.67	9.5	1	44.18	74	-29.82	P	V	1.0
9647.87	38.72	38.54	4.10	35.67	9.5	1	37.18	54	-16.82	A	V	1.0
12059.93*	---	42.60	15.20	35.30	9.5	1	---	---	---	---	V	1.0
14471.97*	---	43.40	16.80	34.00	9.5	1	---	---	---	---	V	1.0
16884.01	---	45.20	17.60	34.30	9.5	1	---	---	---	---	V	1.0
19296.05*	---	36.30	18.50	34.30	9.5	1	---	---	---	---	V	1.0
21708.09	---	36.20	19.20	34.60	9.5	1	---	---	---	---	V	1.0
24120.13	---	36.80	21.00	34.20	9.5	1	---	---	---	---	V	1.0

Note :

- The measurement was searched to 10th harmonic, Remark “---” means that the emissions level is too low to be measured.
- AF: Antenna Factor, Closs: Cable Loss, Pre-Amp: Preamplifier gain, Filter: High Pass Filter Insertion Loss (3.5GHz)
- Analyzer setting P(Peak): RBW=1MHz, VBW=1MHz, A(Average): RBW=1MHz, VBW=10Hz
- Remark “*” means that Restricted band.
- Dist : correction to extra plate reading to 3m specification distance 1m measurement
 $distance = -9.5dB$
- The result basic equation calculation is as follow:
 $Level=Reading+AF+Closs-Preamp+Filter-Dist, Margin=Level-Limit$
- The other emission levels were very low against the limit
- for wireless 802.11g mode
- Test Distance : at 3M



Ecom Sertech Corp.

Rm. 258, Bldg. 17, NO.195, Sec. 4 Chung Hsing Rd., ChuTung Chen, Hsinchu, Taiwan 310, R.O.C
 TEL:886-3-5918012 FAX : 886-3-5825720

FCC ID : QDWWN360G
 Report No. : ER03-06-079FRF
 Page 32 of 55

Test Requirement: 15.205

The frequency spectrum above 1 GHz was investigated. All emissions not reported below are more than 40 dB below the prescribed limits. Readings are both peak and average values.

Operation Mode:	Transmitting	Test Date :	2003/7/5
Fundamental Frequency:	2437MHz (CH 6)	Test By:	K.P. Pang
Temperature :	30 °C	Humidity :	65%

Freq.	Reading	AF	Closs	Pre-amp	Dist	Filter	Level	Limit	Margin	Mark	Pol.	Height
MHz	dBuV	dBuV	dB	dB	dB	dB	dBuV/m	dBuV/m	dB	P/Q/A	H/V	Meter
2437.94	77.28	31.76	2.43	0.00	9.5	0	101.97	Fundamental frequency		P	H	1.0
2437.94	68.46	31.76	2.43	0.00	9.5	0	93.15		A	H	1.0	
4873.86	50.43	34.77	2.80	35.40	9.5	1	44.10	74	-29.90	P	H	1.0
4873.86	47.31	34.77	2.80	35.40	9.5	1	40.98	54	-13.02	A	H	1.0
7311.82	40.31	39.78	4.00	35.57	9.5	1	40.02	74	-33.98	P	H	1.0
7311.82	28.16	39.78	4.00	35.57	9.5	1	27.87	54	-26.13	A	H	1.0
9747.87	44.08	38.53	4.02	35.72	9.5	1	42.40	74	-31.60	P	H	1.0
9747.87	36.69	38.53	4.02	35.72	9.5	1	35.01	54	-18.99	A	H	1.0
12185.10*	---	32.14	4.53	35.24	9.5	1	---	---	---	---	H	1.0
14622.12	---	43.40	16.80	34.00	9.5	1	---	---	---	---	H	1.0
17059.14	---	45.20	17.60	34.30	9.5	1	---	---	---	---	H	1.0
19496.16*	---	36.30	18.50	34.30	9.5	1	---	---	---	---	H	1.0
21933.18	---	36.20	19.20	34.60	9.5	1	---	---	---	---	H	1.0
24370.20	---	36.80	21.00	34.20	9.5	1	---	---	---	---	H	1.0

Note :

- The measurement was searched to 10th harmonic, Remark “---” means that the emissions level is too low to be measured.
- AF: Antenna Factor, Closs: Cable Loss, Pre-Amp: Preamplifier gain, Filter: High Pass Filter Insertion Loss (3.5GHz)
- Analyzer setting P(Peak): RBW=1MHz, VBW=1MHz, A(Average): RBW=1MHz, VBW=10Hz
- Remark “*” means that Restricted band.
- Dist : correction to extra plate reading to 3m specification distance 1m measurement
 $distance = -9.5dB$
- The result basic equation calculation is as follow:
 $Level=Reading+AF+Closs-Preamp+Filter-Dist, Margin=Level-Limit$
- The other emission levels were very low against the limit
- for wireless 802.11g mode
- Test Distance : at 3M



Ecom Sertech Corp.

Rm. 258, Bldg. 17, NO.195, Sec. 4 Chung Hsing Rd., ChuTung Chen, Hsinchu, Taiwan 310, R.O.C
 TEL:886-3-5918012 FAX : 886-3-5825720

FCC ID : QDWWN360G
 Report No. : ER03-06-079FRF
 Page 33 of 55

Test Requirement: 15.205

The frequency spectrum above 1 GHz was investigated. All emissions not reported below are more than 40 dB below the prescribed limits. Readings are both peak and average values.

Operation Mode:	Transmitting	Test Date :	2003/7/5
Fundamental Frequency:	2437MHz (CH 6)	Test By:	K.P. Pang
Temperature :	30 °C	Humidity :	65%

Freq.	Reading	AF	Closs	Pre-amp	Dist	Filter	Level	Limit	Margin	Mark	Pol.	Height
MHz	dBuV	dBuV	dB	dB	dB	dB	dBuV/m	dBuV/m	dB	P/Q/A	H/V	Meter
2436.11	71.41	31.76	2.42	0.00	9.5	0	96.10	Fundamental frequency		P	V	1.0
2436.11	64.45	31.76	2.42	0.00	9.5	0	89.14			A	V	1.0
4873.88	54.19	34.77	2.80	35.40	9.5	1	47.86	74	-26.14	P	V	1.0
4873.88	52.18	34.77	2.80	35.40	9.5	1	45.85	54	-8.15	A	V	1.0
7311.39	39.61	39.78	4.00	35.57	9.5	1	39.32	74	-34.68	P	V	1.0
7311.39	27.57	39.78	4.00	35.57	9.5	1	27.28	54	-26.72	A	V	1.0
9747.87	45.02	38.53	4.02	35.72	9.5	1	43.34	74	-30.66	P	V	1.0
9747.87	38.75	38.53	4.02	35.72	9.5	1	37.07	54	-16.93	A	V	1.0
12185.10*	---	32.14	4.53	35.24	9.5	1	---	---	---	---	V	1.0
14622.12	---	43.40	16.80	34.00	9.5	1	---	---	---	---	V	1.0
17059.14	---	45.20	17.60	34.30	9.5	1	---	---	---	---	V	1.0
19496.16*	---	36.30	18.50	34.30	9.5	1	---	---	---	---	V	1.0
21933.18	---	36.20	19.20	34.60	9.5	1	---	---	---	---	V	1.0
24370.20	---	36.80	21.00	34.20	9.5	1	---	---	---	---	V	1.0

Note :

- The measurement was searched to 10th harmonic, Remark “---” means that the emissions level is too low to be measured.
- AF: Antenna Factor, Closs: Cable Loss, Pre-Amp: Preamplifier gain, Filter: High Pass Filter Insertion Loss (3.5GHz)
- Analyzer setting P(Peak): RBW=1MHz, VBW=1MHz, A(Average): RBW=1MHz, VBW=10Hz
- Remark “*” means that Restricted band.
- Dist : correction to extra plate reading to 3m specification distance 1m measurement
 distance = -9.5dB
- The result basic equation calculation is as follow:
 Level=Reading+AF+Closs-Preamp+Filter-Dist, Margin=Level-Limit
- The other emission levels were very low against the limit
- for wireless 802.11g mode
- Test Distance : at 3M



Ecom Sertech Corp.

Rm. 258, Bldg. 17, NO.195, Sec. 4 Chung Hsing Rd., ChuTung Chen, Hsinchu, Taiwan 310, R.O.C
 TEL:886-3-5918012 FAX : 886-3-5825720

FCC ID : QDWWN360G
 Report No. : ER03-06-079FRF
 Page 34 of 55

Test Requirement: 15.205

The frequency spectrum above 1 GHz was investigated. All emissions not reported below are more than 40 dB below the prescribed limits. Readings are both peak and average values.

Operation Mode:	Transmitting	Test Date :	2003/7/5
Fundamental Frequency:	2462MHz (CH 11)	Test By:	K.P. Pang
Temperature :	30 °C	Humidity :	65%

Freq.	Reading	AF	Closs	Pre-amp	Dist	Filter	Level	Limit	Margin	Mark	Pol.	Height
MHz	dBuV	dBuV	dB	dB	dB	dB	dBuV/m	dBuV/m	dB	P/Q/A	H/V	Meter
2462.83	75.57	31.74	2.49	0.00	9.5	0	100.30	Fundamental frequency		P	H	1.0
2462.83	66.48	31.74	2.49	0.00	9.5	0	91.21		A	H	1.0	
4923.86	49.69	35.10	2.83	35.41	9.5	1	43.71	74	-30.29	P	H	1.0
4923.86	45.96	35.10	2.83	35.41	9.5	1	39.98	54	-14.02	A	H	1.0
7386.22	39.55	39.75	4.06	35.57	9.5	1	39.28	74	-34.72	P	H	1.0
7386.22	27.35	39.75	4.06	35.57	9.5	1	27.08	54	-26.92	A	H	1.0
9847.82	44.72	38.52	3.93	35.77	9.5	1	42.90	74	-31.10	P	H	1.0
9847.82	37.86	38.52	3.93	35.77	9.5	1	36.04	54	-17.96	A	H	1.0
14772.06	---	43.40	16.80	34.00	9.5	1	---	---	---	---	H	1.0
17234.08	---	45.20	17.60	34.30	9.5	1	---	---	---	---	H	1.0
19696.1*	---	36.30	18.50	34.30	9.5	1	---	---	---	---	H	1.0
22158.12*	---	36.20	19.20	34.60	9.5	1	---	---	---	---	H	1.0
24620.14	---	36.80	21.00	34.20	9.5	1	---	---	---	---	H	1.0

Note :

- The measurement was searched to 10th harmonic, Remark “---” means that the emissions level is too low to be measured.
- AF: Antenna Factor, Closs: Cable Loss, Pre-Amp: Preamplifier gain, Filter: High Pass Filter Insertion Loss (3.5GHz)
- Analyzer setting P(Peak): RBW=1MHz, VBW=1MHz, A(Average): RBW=1MHz, VBW=10Hz
- Remark “*” means that Restricted band.
- Dist : correction to extra plate reading to 3m specification distance 1m measurement
 distance = -9.5dB
- The result basic equation calculation is as follow:
 $Level = Reading + AF + Closs - Preamp + Filter - Dist, Margin = Level - Limit$
- The other emission levels were very low against the limit
- for wireless 802.11g mode
- Test Distance : at 3M



Ecom Sertech Corp.

Rm. 258, Bldg. 17, NO.195, Sec. 4 Chung Hsing Rd., ChuTung Chen, Hsinchu, Taiwan 310, R.O.C
 TEL:886-3-5918012 FAX : 886-3-5825720

FCC ID : QDWWN360G
 Report No. : ER03-06-079FRF
 Page 35 of 55

Test Requirement: 15.205

The frequency spectrum above 1 GHz was investigated. All emissions not reported below are more than 40 dB below the prescribed limits. Readings are both peak and average values.

Operation Mode:	Transmitting	Test Date :	2003/7/5
Fundamental Frequency:	2462MHz (CH 11)	Test By:	K.P. Pang
Temperature :	30 °C	Humidity :	65%

Freq.	Reading	AF	Closs	Pre-amp	Dist	Filter	Level	Limit	Margin	Mark	Pol.	Height
MHz	dBuV	dBuV	dB	dB	dB	dB	dBuV/m	dBuV/m	dB	P/Q/A	H/V	Meter
2461.11	67.58	31.74	2.49	0.00	9.5	0	92.31	Fundamental frequency		P	V	1.0
2461.11	60.17	31.74	2.49	0.00	9.5	0	84.90			A	V	1.0
4923.86	55.76	35.10	2.83	35.41	9.5	1	49.78	74	-24.22	P	V	1.0
4923.86	53.78	35.10	2.83	35.41	9.5	1	47.80	54	-6.20	A	V	1.0
7386.16	39.64	39.75	4.06	35.57	9.5	1	39.37	74	-34.63	P	V	1.0
7386.16	27.17	39.75	4.06	35.57	9.5	1	26.90	54	-27.10	A	V	1.0
9847.82	45.17	38.52	3.93	35.77	9.5	1	43.35	74	-30.65	P	V	1.0
9847.82	38.62	38.52	3.93	35.77	9.5	1	36.80	54	-17.20	A	V	1.0
12310.04*	---	32.14	4.53	35.24	9.5	1	---	---	---	---	V	1.0
14772.06	---	43.40	16.80	34.00	9.5	1	---	---	---	---	V	1.0
17234.08	---	45.20	17.60	34.30	9.5	1	---	---	---	---	V	1.0
19696.1*	---	36.30	18.50	34.30	9.5	1	---	---	---	---	V	1.0
22158.12*	---	36.20	19.20	34.60	9.5	1	---	---	---	---	V	1.0
24620.14	---	36.80	21.00	34.20	9.5	1	---	---	---	---	V	1.0

Note :

- The measurement was searched to 10th harmonic, Remark “---” means that the emissions level is too low to be measured.
- AF: Antenna Factor, Closs: Cable Loss, Pre-Amp: Preamplifier gain, Filter: High Pass Filter Insertion Loss (3.5GHz)
- Analyzer setting P(Peak): RBW=1MHz, VBW=1MHz, A(Average): RBW=1MHz, VBW=10Hz
- Remark “*” means that Restricted band.
- Dist : correction to extra plate reading to 3m specification distance 1m measurement distance = -9.5dB
- The result basic equation calculation is as follow:
 $Level = Reading + AF + Closs - Preamp + Filter - Dist, Margin = Level - Limit$
- The other emission levels were very low against the limit
- for wireless 802.11g mode
- Test Distance : at 3M

3.7 Photos of Open Site





Ecom Sertech Corp.

Rm. 258, Bldg. 17, NO.195, Sec. 4 Chung Hsing Rd., ChuTung Chen, Hsinchu, Taiwan 310, R.O.C
TEL:886-3-5918012 FAX : 886-3-5825720

FCC ID : QDWWN360G
Report No. : ER03-06-079FRF
Page 37 of 55



4. 6dB BANDWIDTH MEASUREMENT

4.1 Test Equipments

Description & Manufacturer	Model No.	Serial No.	Date of Calibration
ROHDE & SCHWARZ TEST RECEIVER	ESMI	842088/005 841978/008	SEPT. 3, 2002
HP ATTENUATOR	8496B	3247A18505	Cal. on use
HP PLOTTER	7750A	725A 852141	N/A

NOTE :

1. The measurement uncertainty is less than +/- 2.6dB, which is calculated as per the NAMAS document NIS81.
2. The calibration interval of the above test instruments is 12 months and the calibrations are traceable to NML/ROC and NIST/USA.

4.2 Test Setup

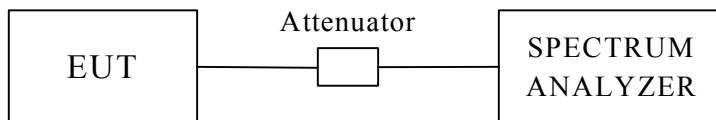

4.3 Limits of 6dB Bandwidth Measurement

The minimum of 6dB Bandwidth Measurement is >500KHz

4.4 Test Procedure

The transmitter output was connected to the spectrum analyzer through an attenuator. The bandwidth of the fundamental frequency was measured by spectrum analyzer with 100 KHz RBW and 100 KHz VBW. The 6dB bandwidth is defined as the total spectrum the power of which is higher than peak power minus 6dB.



4.5 Uncertainty of Conducted Emission

The uncertainty of conducted emission is $\pm 200\text{KHz}$.

4.6 Test Results

Input Power (System)	3.3VDC (From PC)	Environmental Conditions	27°C, 70%RH,
Tested By	K. P. Pang		

Channel	Channel Frequency (MHz)	6dB Bandwidth (MHz)	Minimum Limit (MHz)	Pass / Fail
1	2412	11.54	0.5	PASS
6	2437	12.14	0.5	PASS
11	2462	11.54	0.5	PASS

NOTE: FOR 11Mbps(802.11b Mode)

Channel	Channel Frequency (MHz)	6dB Bandwidth (MHz)	Minimum Limit (MHz)	Pass / Fail
1	2412	15.27	0.5	PASS
6	2437	15.35	0.5	PASS
11	2462	15.31	0.5	PASS

NOTE: FOR 54Mbps(802.11g Mode)



4.7 Photo of 6dB Bandwidth Measurement

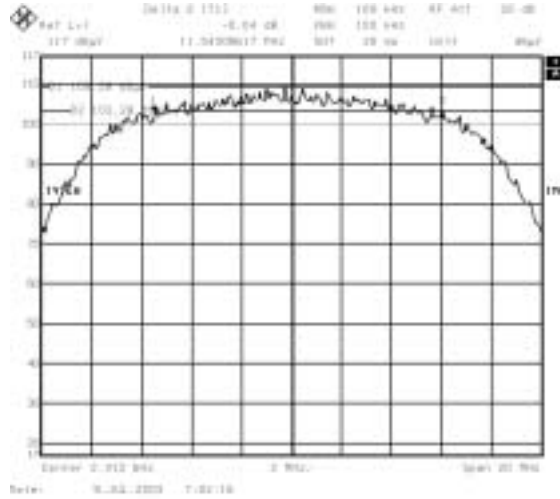

Channel 1

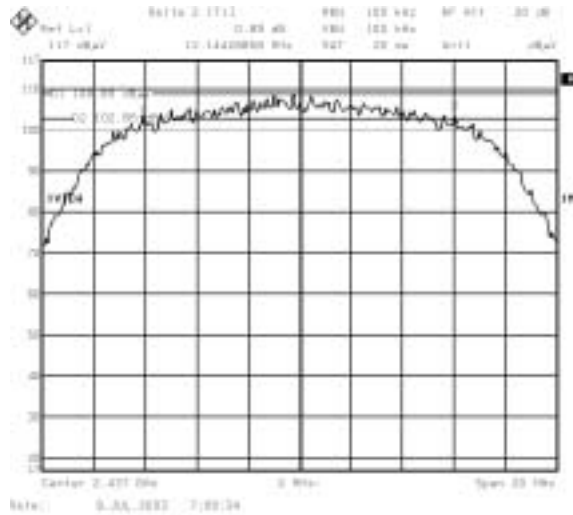

Channel 6

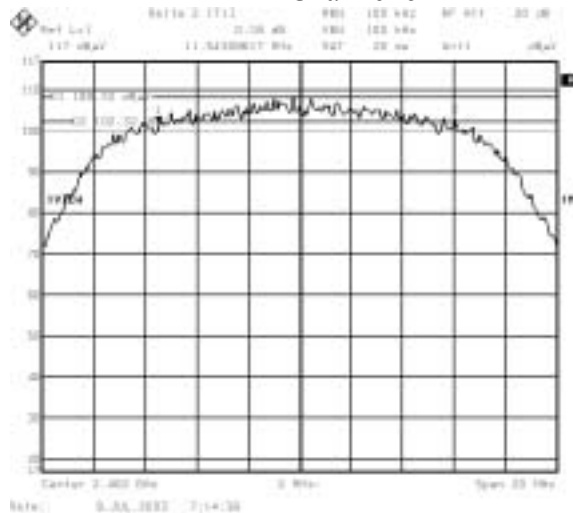

NOTE: FOR 11Mbps(802.11b Mode)



Ecom Sertech Corp.

Rm. 258, Bldg. 17, NO.195, Sec. 4 Chung Hsing Rd., ChuTung Chen, Hsinchu, Taiwan 310, R.O.C
 TEL:886-3-5918012 FAX : 886-3-5825720

FCC ID : QDWWN360G
 Report No. : ER03-06-079FRF
 Page 41 of 55

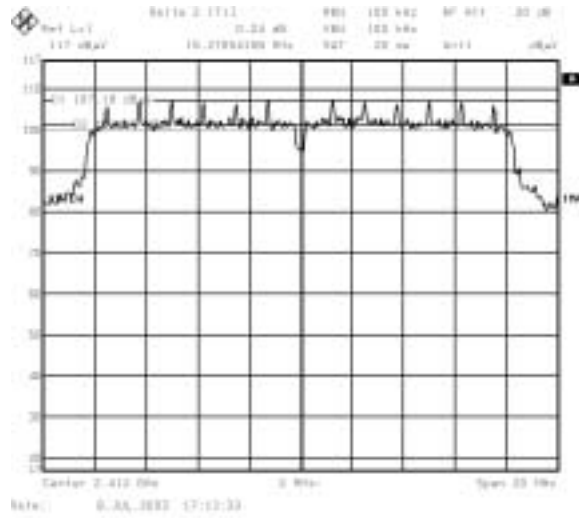

Channel 1

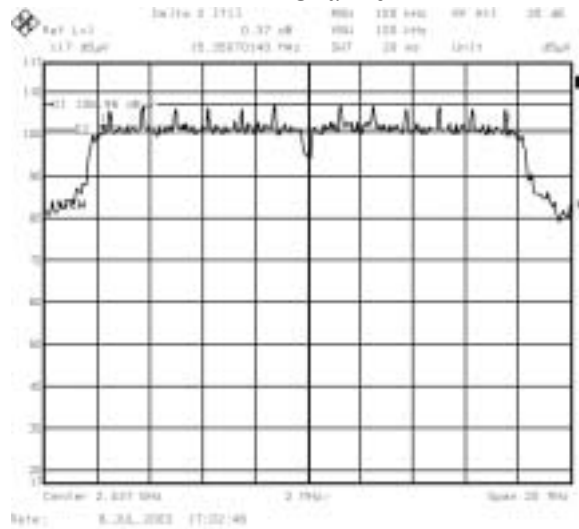

Channel 6

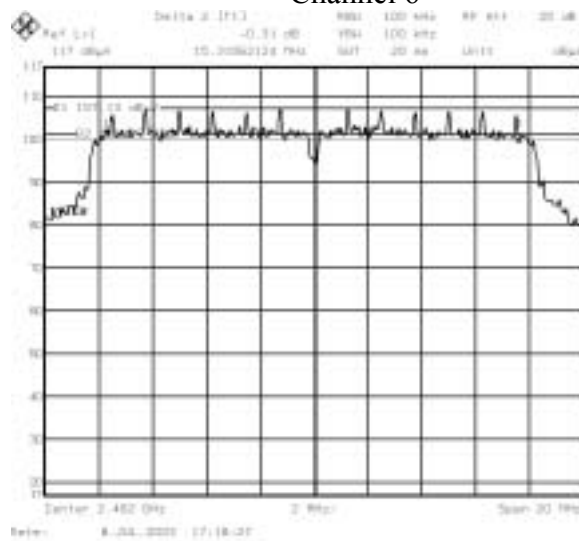

Channel 11

NOTE: FOR 54Mbps(802.11g Mode)

5. MAXIMUM PEAK OUTPUT POWER

5.1 test equipments

Description & Manufacturer	Model No.	Serial No.	Date Of Calibration
ROHDE & SCHWARZ TEST RECEIVER	ESMI	842088/005 841978/008	SEPT. 3, 2002
HP ATTENUATOR	8496B	3247A18505	Cal. on use
HP PLOTTER	7750A	725A 852141	N/A
GIGA-TRONICS Powre meter	8542	1828329	Sept.21,2002

NOTE :

1. The measurement uncertainty is less than +/- 2.6dB, which is calculated as per the NAMAS document NIS81.
2. The calibration interval of the above test instruments is 12 months and the calibrations are traceable to NML/ROC and NIST/USA.

5.2 Test Setup

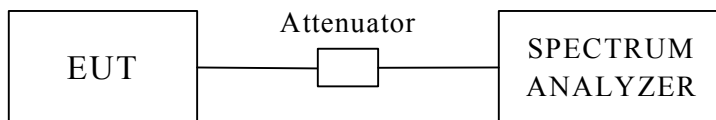

5.3 Limits of Maximum Peak Output Power

The Maximum Peak Output Power Measurement is 30dBm.



5.4 Test Procedure

The RF power output was measured with a Power meter connected to the RF Antenna connector (conducted measurement) while EUT was operating in transmit mode at the appropriate center frequency.

5.5 Uncertainty of Conducted Emission

The uncertainty of conducted emission is ± 1.82 dB.

5.6 Test Results

Input Power (System)	3.3VDC (From PC)	Environmental Conditions	27°C, 70%RH,
Tested By	K. P. Pang		

Channel	Channel Frequency (MHz)	Peak Power Output (dBm)	Peak Power Limit (dBm)	Pass / Fail
1	2412	20.15	30	PASS
6	2437	19.83	30	PASS
11	2462	19.57	30	PASS

NOTE: FOR 11Mbps(802.11b Mode)

Channel	Channel Frequency (MHz)	Peak Power Output (dBm)	Peak Power Limit (dBm)	Pass / Fail
1	2412	19.94	30	PASS
6	2437	19.86	30	PASS
11	2462	19.89	30	PASS

NOTE: FOR 54Mbps(802.11g Mode)

6. POWER SPECTRAL DENSITY MEASUREMENT

6.1 Test Equipments

Description & Manufacturer	Model No.	Serial No.	Date Of Calibration
ROHDE & SCHWARZ TEST RECEIVER	ESMI	842088/005 841978/008	SEPT. 3, 2002
HP ATTENUATOR	8496B	3247A18505	Cal. on use
HP PLOTTER	7750A	725A 852141	N/A

NOTE :

1. The measurement uncertainty is less than +/- 2.6dB, which is calculated as per the NAMAS document NIS81.
2. The calibration interval of the above test instruments is 12 months and the calibrations are traceable to NML/ROC and NIST/USA.

6.2 Test Setup

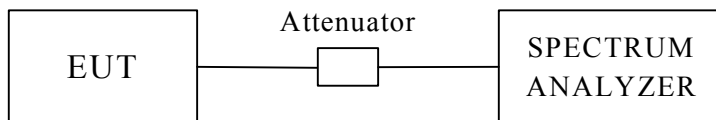

6.3 Limits of Power Spectral Density Measurement

The Maximum Power Spectral Density Measurement is 8dBm.



6.4 Test Procedure

The transmitter output was connected to the spectrum analyzer through an attenuator, the bandwidth of the fundamental frequency was measured with the spectrum analyzer using 3KHz RBW and 30KHz VBW, set sweep time=span / 3KHz.

The power spectral density was measured and recorded.

The sweep time is allowed to be longer than span / 3KHz for a full response of the mixer in the spectrum analyzer.

6.5 Uncertainty of Conducted Emission

The uncertainty of conducted emission is ± 1.82dB.

6.6 Test Results

Input Power (System)	3.3VDC (From PC)	Environmental Conditions	27°C, 70%RH,
Tested By	K. P. Pang		

Channel	Channel Frequency (MHz)	Final Rf Power Level in 3KHz BW (dBm)	Maxmum Limit (dBm)	Pass / Fail
1	2412	-1.80	8	PASS
6	2437	-2.55	8	PASS
11	2462	-3.49	8	PASS

NOTE: 1.FOR 11Mbps(802.11b Mode)

2.The measurement value of RF Power Level + 10dB attenuator=Final RF Power Level

Channel	Channel Frequency (MHz)	Final Rf Power Level in 3KHz BW (dBm)	Maxmum Limit (dBm)	Pass / Fail
1	2412	-14.56	8	PASS
6	2437	-15.12	8	PASS
11	2462	-15.59	8	PASS

NOTE: 1.FOR 54Mbps(802.11g Mode)

2.The measurement value of RF Power Level + 10dB attenuator=Final RF Power Level



6.7 Photo of Power Spectral Density Measurement

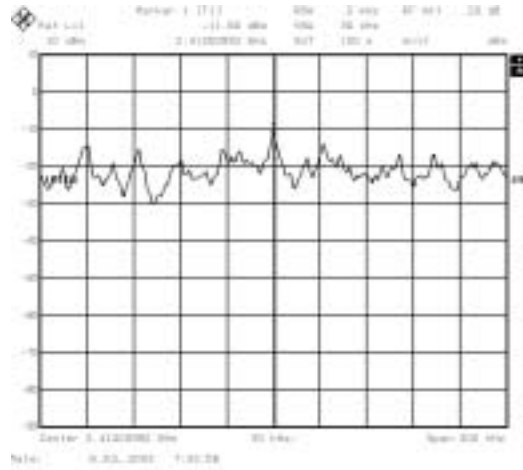

Channel 1

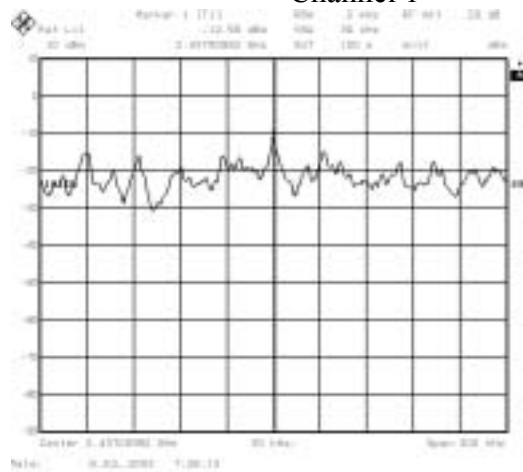

Channel 6

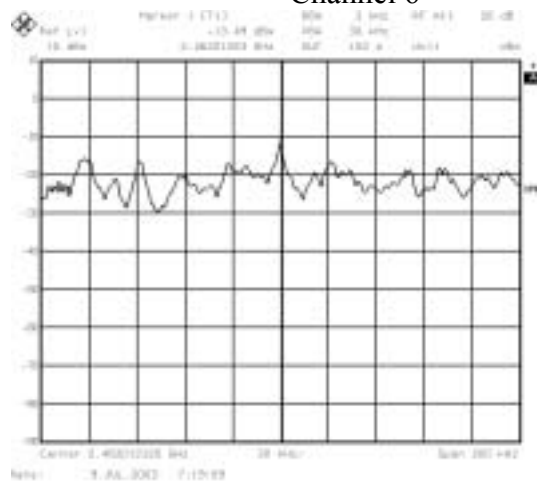

Channel 11

NOTE: FOR 11Mbps(802.11b Mode)



Ecom Sertech Corp.

Rm. 258, Bldg. 17, NO.195, Sec. 4 Chung Hsing Rd., ChuTung Chen, Hsinchu, Taiwan 310, R.O.C
TEL:886-3-5918012 FAX : 886-3-5825720

FCC ID : QDWWN360G
Report No. : ER03-06-079FRF
Page 47 of 55

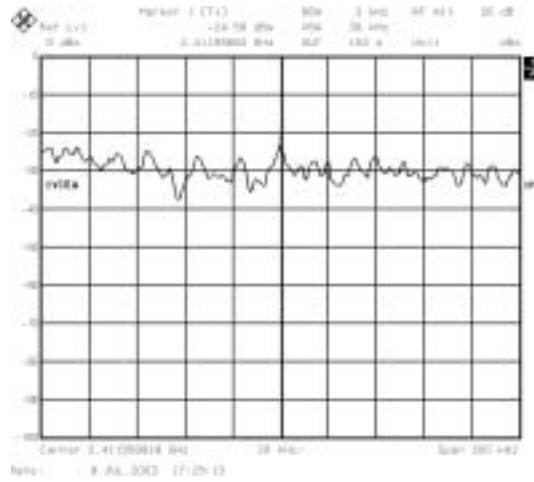

Channel 1

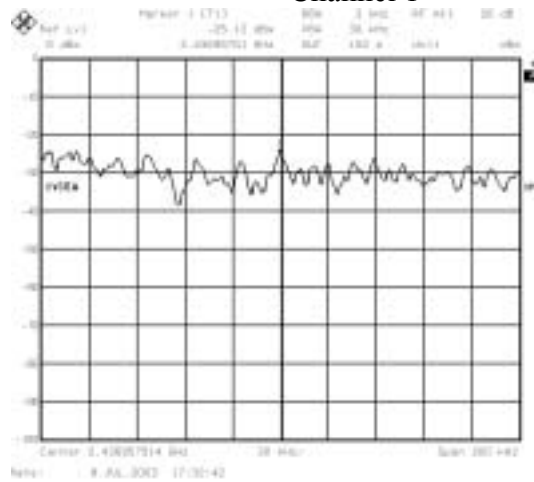

Channel 6

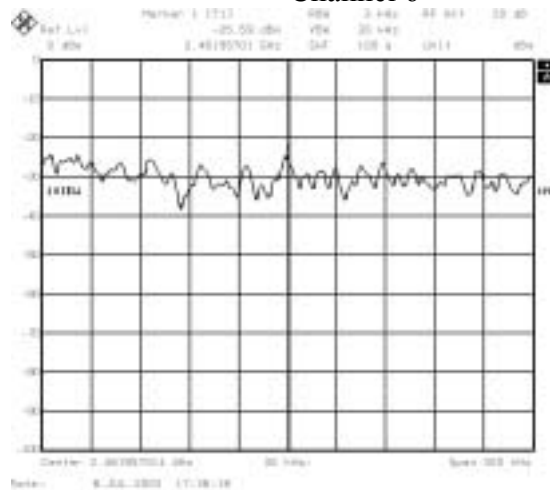

Channel 11

NOTE: FOR 54Mbps(802.11g Mode)

7. OUT OF BAND MEASUREMENT

7.1 Test Equipments

Description & Manufacturer	Model No.	Serial No.	DATE OF CALIBRATION
ROHDE & SCHWARZ TEST RECEIVER	ESMI	842088/005 841978/008	SEPT. 3, 2002
HP ATTENUATOR	8496B	3247A18505	Cal. on use
HP PLOTTER	7750A	725A 852141	N/A

NOTE :

- The measurement uncertainty is less than +/- 2.6dB, which is calculated as per the NAMAS document NIS81.
- The calibration interval of the above test instruments is 12 months and the calibrations are traceable to NML/ROC and NIST/USA.

7.2 Test Setup

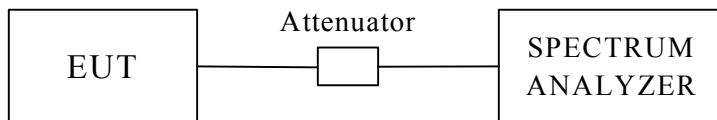

7.3 Limits of Out of Band Emissions Measurement

- Below -20dB of the highest emission level of operating band (in 100KHz Resolution Bandwidth).
- Fall in the restricted bands listed in section 15.205. The maximum permitted average field strength is listed in section 15.209.



7.4 Test Procedure

The transmitter output was connected to the spectrum analyzer via a low lose cable. Set both RBW and VBW of spectrum analyzer to 100KHz with suitable frequency span including 100KHz bandwidth from band edge. The band edges was measured and recorded.

7.5 Uncertainty of Conducted Emission

The uncertainty of conducted emission is ± 1.82 dB.

7.6 Test Results

A. Conducted

Refer to 7.7 photo of out band Emission measurement

B. Radiated

NOTE1: FOR 11Mbps(802.11b Mode)

NOTE2: The band edge emission plot on the following first figure shows 46.90 dBuV/m delta between carrier maximum power and local maximum emission in restrict band (2.3885GHz). The emission of carrier strength list in the test result of channel 1 at the item 3.6 is 98.36 dBuV/m, so the maximum field strength in restrict band is $98.36-46.90=51.46$ dBuV/m under 54 dBuV/m limit.

NOTE3: The band edge emission plot on the following second figure shows 46.61 dBuV/m delta between carrier maximum power and local maximum emission in restrict band (2.4844 GHz). The emission of carrier strength list in the test result of channel 11 at the item 3.6 is 91.21 dBuV/m, so the maximum field strength in restrict band is $95.43-46.61=48.82$ dBuV/m under 54 dBuV/m limit.

Input Power (System)	3.3VDC (From PC)	Environmental Conditions	27°C, 70%RH,
Tested By	K. P. Pang		

Channel Frequency (MHz)	Required Limit (dBc)	Pass / Fail
<2400	>20	PASS
>2483.5	>20	PASS



Ecom Sertech Corp.

Rm. 258, Bldg. 17, NO.195, Sec. 4 Chung Hsing Rd., ChuTung Chen, Hsinchu, Taiwan 310, R.O.C
TEL:886-3-5918012 FAX : 886-3-5825720

FCC ID : QDWWN360G
Report No. : ER03-06-079FRF
Page 50 of 55

B. Radiated

NOTE1: FOR 54Mbps(802.11gMode)

NOTE1: The band edge emission plot on the following first figure shows 43.14 dBuV/m delta between carrier maximum power and local maximum emission in restrict band (2.3895 GHz) The emission of carrier strength list in the test result of channel 1 at the item 3.6 is 93.11 dBuV/m, so the maximum field strength in restrict band is $93.11-43.14=49.97$ dBuV/m under 54 dBuV/m limit.

NOTE2: The band edge emission plot on the following second figure shows 42.35 dBuV/m delta between carrier maximum power and local maximum emission in restrict band (2.4846 GHz) The emission of carrier strength list in the test result of channel 11 at the item 3.6 is 91.21 dBuV/m, so the maximum field strength in restrict band is $91.21-42.35=48.86$ dBuV/m under 54 dBuV/m limit.

Input Power (System)	3.3VDC (From PC)	Environmental Conditions	27°C, 70%RH,
Tested By	K. P. Pang		

Channel Frequency (MHz)	Required Limit (dBc)	Pass / Fail
<2400	>20	PASS
>2483.5	>20	PASS



Ecom Sertech Corp.

Rm. 258, Bldg. 17, NO.195, Sec. 4 Chung Hsing Rd., ChuTung Chen, Hsinchu, Taiwan 310, R.O.C
TEL:886-3-5918012 FAX : 886-3-5825720

FCC ID : QDWWN360G
Report No. : ER03-06-079FRF
Page 51 of 55

7.7 Photo of Out of Band Measurement

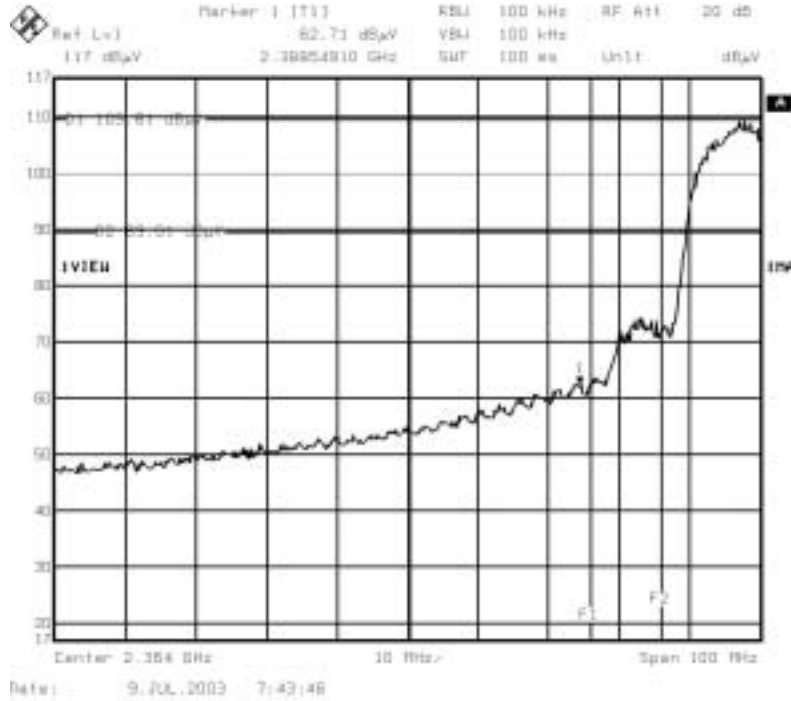

FRONT

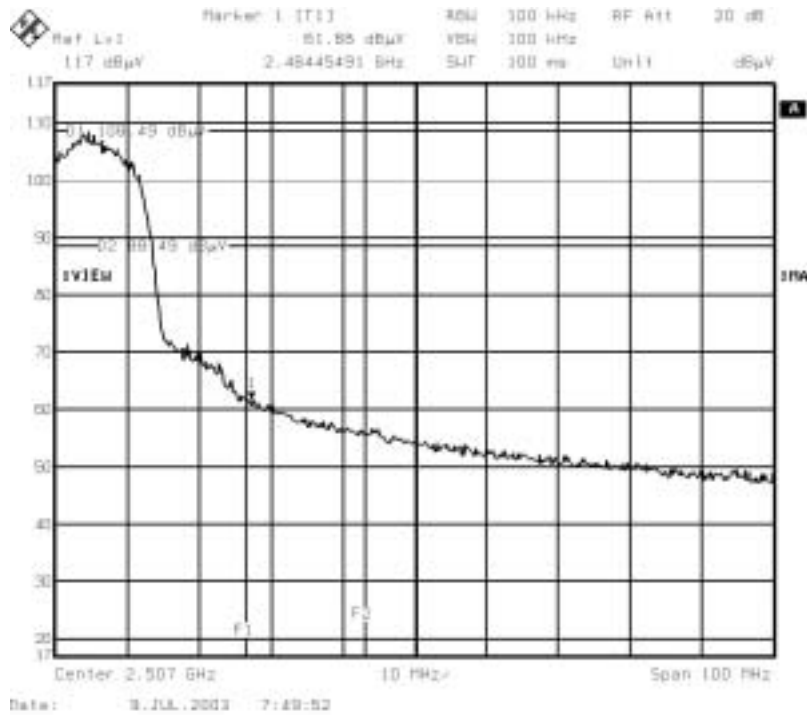

BACK

NOTE: FOR 11Mbps(802.11b Mode)



Ecom Sertech Corp.

Rm. 258, Bldg. 17, NO.195, Sec. 4 Chung Hsing Rd., ChuTung Chen, Hsinchu, Taiwan 310, R.O.C
TEL:886-3-5918012 FAX : 886-3-5825720

FCC ID : QDWWN360G
Report No. : ER03-06-079FRF
Page 52 of 55

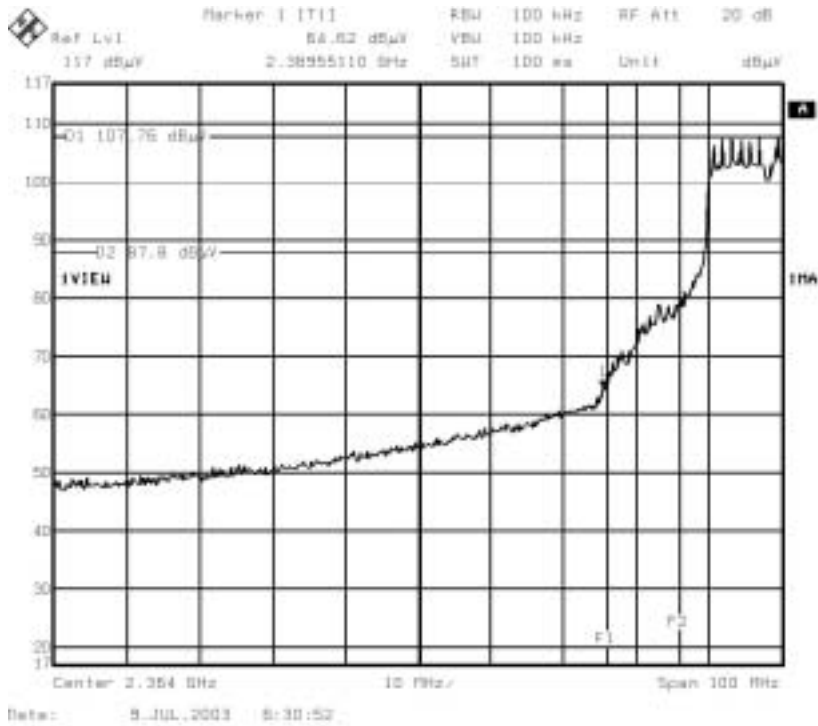

FRONT

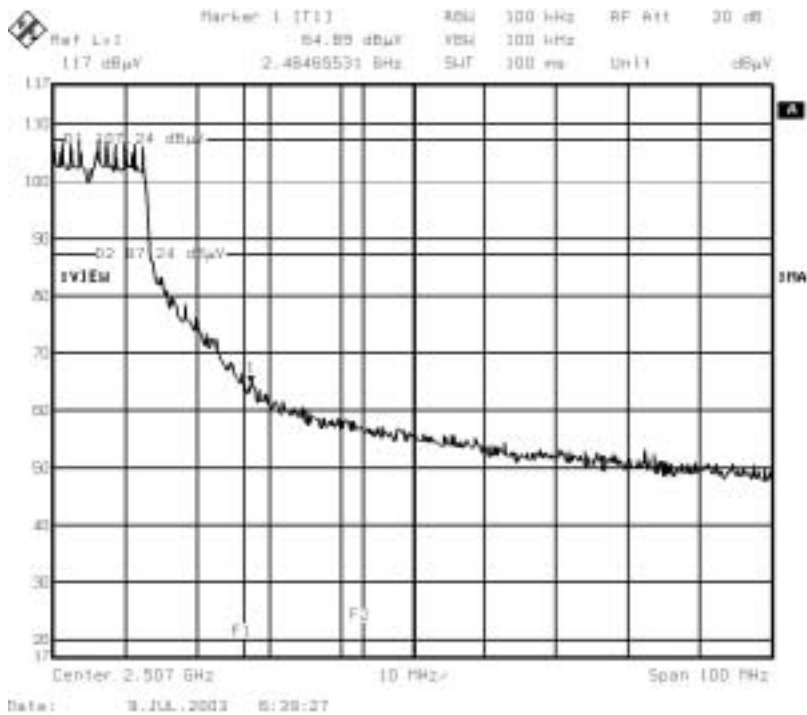

NOTE: FOR 54Mbps(802.11g Mode)



8. ANTENNA REQUIREMENT

8.1 Standard Applicable

For intentional device, according to FCC 47 CFR Section 15.203, an intentional radiator shall be designed to ensure that no antenna other than that furnished by the responsible party shall be used with the device.

And according to FCC 47 CFR Section 15.247 (b), if transmitting antennas of directional gain greater than 6dBi are used, the power shall be reduced by the amount in dB that the directional gain of the antenna exceeds 6dBi.

8.2 Antenna Connected Construction

The antenna used in this product is dipole antenna. The dipole antenna connector is MMCX And the maximum Gain of this antenna is only 2.5dBi.



9. RF EXPOSURE EVALUATION

According to FCC 1.1310 : The criteria listed in the following table shall be used to evaluate the environment impact of human exposure to radio frequency (RF) radiation as specified in 1.1307(b)
LIMITS FOR MAXIMUM PERMISSIBLE EXPOSURE (MPE)

Frequency Range (MHz)	Electric Field Strength (V/m)	Magnetic Field Strength (A/m)	Power Density (mW/cm ²)	Average Time
(A) Limits for Occupational / Control Exposures				
300-1,500	--	--	F/300	6
1,500-100,000	--	--	5	6
(B) Limits for General Population / Uncontrol Exposures				
300-1,500	--	--	F/1500	6
1,500-100,000	--	--	1	30

9.1 Friis Formula

Friis transmission formula : $Pd = (Pout * G) / (4 * \pi * r^2)$

Where

Pd = power density in mW/cm²

Pout = output power to antenna in mW

G = gain of antenna in linear scale

Pi = 3.1416

R = distance between observation point and center of the radiator in cm

Pd is the limit of MPE, 1 mW/cm². If we know the maximum gain of the antenna and the total power input to the antenna, through the calculation, we will know the distance r where the MPE limit is reached.

9.2 EUT Operating Condition

A software provided by client enabled the EUT to transmit and receive data at lowest, middle and highest channel individually.



9.3 Test Result of Rf Exposure Evaluation

Test Item : RF Exposure Evaluation Data

Test Mode : Normal Operation

9.3.1 Antenna Gain

Antenna Gain : The maximum Gain measured in fully anechoic chamber is 2.5dBi linear scale.

9.3.2 Output Power Into Antenna & Rf Exposure Evaluation Distance

Channel	Channel Frequency (MHz)	Output Power to Antenna (dBm)	Power density in mW/cm ² at Friis formula when r=20cm(mW/cm ²)	LIMITS
CH1	2412.00	19.94	0.031098	1
CH6	2437.00	19.86	0.030530	1
CH11	2462.00	19.89	0.030742	1

NOTE1: FOR 11Mbps(802.11b Mode)

Channel	Channel Frequency (MHz)	Output Power to Antenna (dBm)	Power density in mW/cm ² at Friis formula when r=20cm(mW/cm ²)	LIMITS
CH1	2412.00	20.15	0.032638	1
CH6	2437.00	19.83	0.030320	1
CH11	2462.00	19.57	0.028558	1

NOTE1: FOR 54 Mbps (802.11gMode)

The power density Pd (4th column) at a distance of 20cm calculated from the Friis transmission formula is far below the limit of 1 mW/cm². So, RF exposure limit warning or SAR test are not required.