



## Test Report

Product Name : 802.11b WLAN Mini-USB Adaptor

Model No.: WN-210

FCC ID.: QDWWN210

Applicant : AirVast Technology Inc.

Address : 4F-1, No. 1, Ln. 21, Hsin Hua Rd., Kueishan Industrial  
Park, Taoyuan 330, Taiwan, R.O.C.

Date of Receipt : January. 28, 2003

Date of Test : February. 13, 2003

Report No. : 032L201FI

The test results relate only to the samples tested.

The test report shall not be reproduced except in full without the written approval of Quietek Corporation.

This report must not be used to claim product endorsement by NVLAP any agency of the U.S. Government

# Test Report Certification

Test Date : February. 13, 2003

Report No. : 032L201FI



Accredited by NIST (NVLAP)

NVLAP Lab Code: 200533-0

Product Name : 802.11b WLAN Mini-USB Adaptor

Applicant : AirVast Technology Inc.

Address : 4F-1, No. 1, Ln. 21, Hsin Hua Rd., Kueishan Industrial Park, Taoyuan 330, Taiwan, R.O.C.

Manufacturer : AirVast Technology Inc.

Model No. : WN-210

FCC ID. : QDWWN210

Rated Voltage : DC 5.0V

Measurement Standard : FCC Part 15 Subpart C Paragraph 15.247

Measurement Procedure : ANSI C63.4: 1992

Test Result : Complied



The Test Results relate only to the samples tested.

The test report shall not be reproduced except in full without the written approval of Quietek Corporation.

This report must not be used to claim product endorsement by NVLAP any agency of the U.S. Government

Documented By : *Kolistin Wan*  
( Kolistin Wan )

Tested By : *Tony Hsieh*  
( Tony Hsieh )

Approved By : *Gene Chang*  
( Gene Chang )

## TABLE OF CONTENTS

Description	Page
<b>1. GENERAL INFORMATION .....</b>	<b>5</b>
1.1. EUT Description .....	5
1.2. Operational Description .....	6
1.3. Tested System Details .....	7
1.4. Configuration of tested System.....	8
1.5. EUT Exercise Software.....	9
1.6. Test Facility .....	10
<b>2. Conducted Emission.....</b>	<b>11</b>
2.1. Test Equipment .....	11
2.2. Test Setup.....	11
2.3. Limits.....	11
2.4. Test Procedure.....	12
2.5. Test Result of Conducted Emission.....	13
<b>3. Peak Power Output .....</b>	<b>15</b>
3.1. Test Equipment .....	15
3.2. Test Setup.....	15
3.3. Limits.....	15
3.4. Test Result of Peak Power Output.....	16
<b>4. RF Exposure Evaluation.....</b>	<b>17</b>
4.1. Limits.....	17
4.2. Test Procedure.....	17
4.3. Test Result of RF Exposure Evaluation .....	18
<b>5. Radiated Emission.....</b>	<b>19</b>
5.1. Test Equipment .....	19
5.2. Test Setup.....	19
5.3. Limits.....	20
5.4. Test Procedure.....	21
5.5. Test Result of Radiated Emission.....	22
<b>6. Band Edge .....</b>	<b>34</b>
6.1. Test Equipment .....	34
6.2. Test Setup.....	34
6.3. Limits.....	35
6.4. Test Procedure.....	35
6.5. Test Result of Band Edge .....	36
<b>7. Occupied Bandwidth .....</b>	<b>44</b>
7.1. Test Equipment .....	44
7.2. Test Setup.....	44
7.3. Limits.....	44
7.4. Test Result of Occupied Bandwidth .....	45
<b>8. Power Density.....</b>	<b>51</b>

---

8.1.	Test Equipment .....	51
8.2.	Test Setup.....	51
8.3.	Limits.....	51
8.4.	Test Result of Power Density .....	52
<b>9.</b>	<b>EMI Reduction Method During Compliance Testing.....</b>	<b>58</b>

Attachment 1: EUT Test Photographs

Attachment 2: EUT Detailed Photographs

## 1. GENERAL INFORMATION

### 1.1. EUT Description

Product Name : 802.11b WLAN Mini-USB Adaptor  
 FCC ID. : QDWWN210  
 Model No. : WN-210  
 Frequency Range : 2400MHz to 2483.5MHz  
 Channel Number : 11  
 Chip Rate : 11Mbps and 5.5Mbps:CCK; 2Mbps:DQPSK, 1Mbps:DBPSK  
 Type of Modulation : Direct Sequence Spread Spectrum  
 Channel Control : Automatic Switch  
 Antenna type : Printed  
 Antenna Gain : 1.5dBi  
 Operator Selection of : By software  
 Operating Frequency

Frequency of Each Channel:

Channel	Frequency	Channel	Frequency	Channel	Frequency
Channel 1:	2412 MHz	Channel 5:	2432 MHz	Channel 9:	2452 MHz
Channel 2:	2417 MHz	Channel 6:	2437 MHz	Channel 10:	2457 MHz
Channel 3:	2422 MHz	Channel 7:	2442 MHz	Channel 11:	2462 MHz
Channel 4:	2427 MHz	Channel 8:	2447 MHz		

Note:

1. This device is a 2.4GHz 802.11b WLAN Mini-USB Adaptor included a 2.4GHz receiving function, a 2.4GHz transmitting function.
2. Regards to the frequency band operation; two rate that were included the lowest, middle and highest frequency of channel were selected to perform the test, then shown on this report.
3. These tests were conducted on a sample of the equipment for the purpose of demonstrating compliance with Part 15 Subpart C Paragraph 15.247 for spread spectrum devices.
4. This device is a composite device in accordance with Part 15 regulations. The function receiving was measured and made a test report that the report number is 032L201F under Declaration of Conformity.

## 1.2. Operational Description

EUT is a 802.11b WLAN Mini-USB Adaptor with 11 channels. This device provided four kind of transmitting speed 1,2,5.5 and 11Mbps. The device of RF carrier is DQPSK, DB PSK and CCK.

Operation in 2.4GHz Direst Sequence Spread Spectrum (DSSS) radio transmission, the 802.11b WLAN Mini-USB Adaptor transfers data at speeds up to 64/128-bit Wired Equivalent Protection (WEP) algorithm is used. In addition, its standard compliance ensures that it can communicate with any 802.11b network.

**1.3. Tested System Details**

The types for all equipment, plus descriptions of all cables used in the tested system (including inserted cards) are:

	Product	Manufacturer	Model No.	Serial No.	Power Cord
(1)	Notebook	DELL	PP01L	N/A	Non-shielded, 1.8m
(2)	Monitor	ADI	CM703	038054T10203876A	Non-shielded, 1.8m
(3)	Modem	ACEEX	DM-1414	0102027557	Non-shielded, 1.8m
(4)	Microphone & Earphone	TOKTO	SX-MI	N/A	N/A
(5)	Mouse	HITACHI	PC-KM1300	N/A	N/A
(6)	Monitor	SONY	PVM-14M2U	2105742	Non-shielded, 1.8m
(7)	Printer	EPSON	Color 680	023913	Non-shielded, 1.8m
(8)	Notebook	DELL	PP01L	N/A	Non-shielded, 1.8m
(9)	AP	ASUS	AC300	N/A	Non-shielded, 1.8m
(10)	Notebook	DELL	PP01L	N/A	Non-shielded, 1.8m

	Signal Cable Type	Signal Cable Description
A.	Monitor Cable	Shielded, 1.8m, a ferrite core bonded.
B.	Modem Cable	Shielded, 1.5m
C.	Microphone & Earphone Cable	Non-shielded, 1.8m.
D.	Mouse Cable	Non-shielded, 1.0m.
E.	Monitor Cable	Shielded, 1.2m
F.	Printer Cable	Shielded, 1.7m
G.	USB Cable	Shielded, 1.5m, a ferrite core bonded.
H.	Telecom Cable	Non-shielded, 6.0m.
I.	LAN Cable	Non-shielded, 6.0m.
J.	LAN Cable	Non-shielded, 1.0m.

### 1.4. Configuration of tested System

EUT: Tx

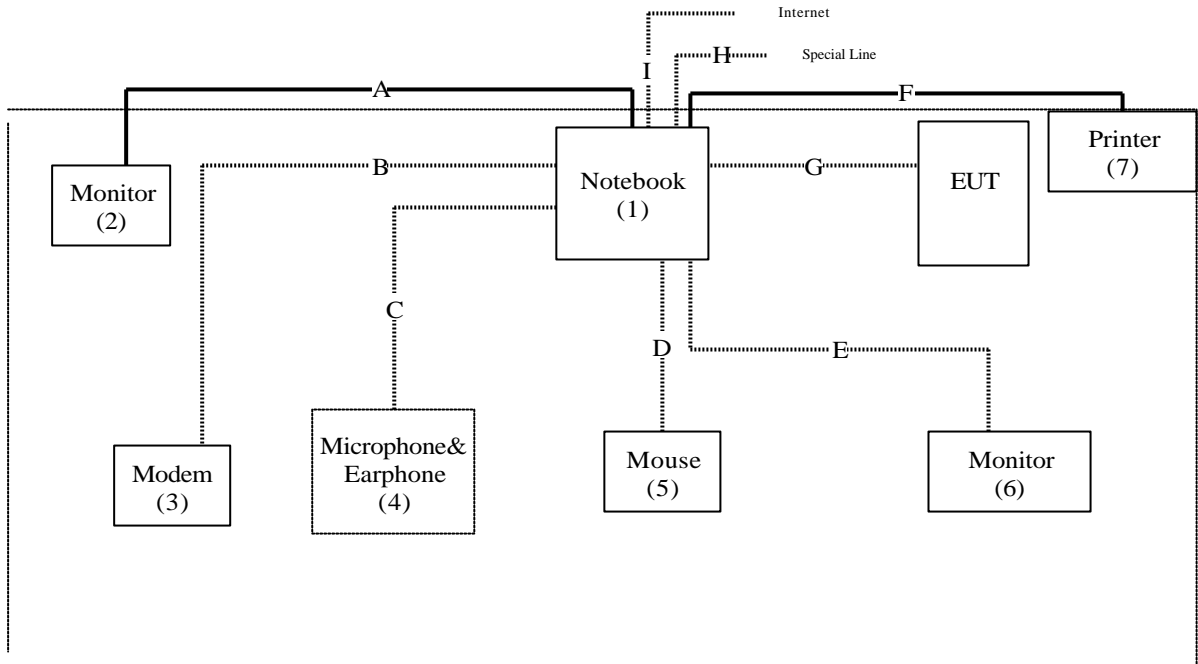

EUT: Rx

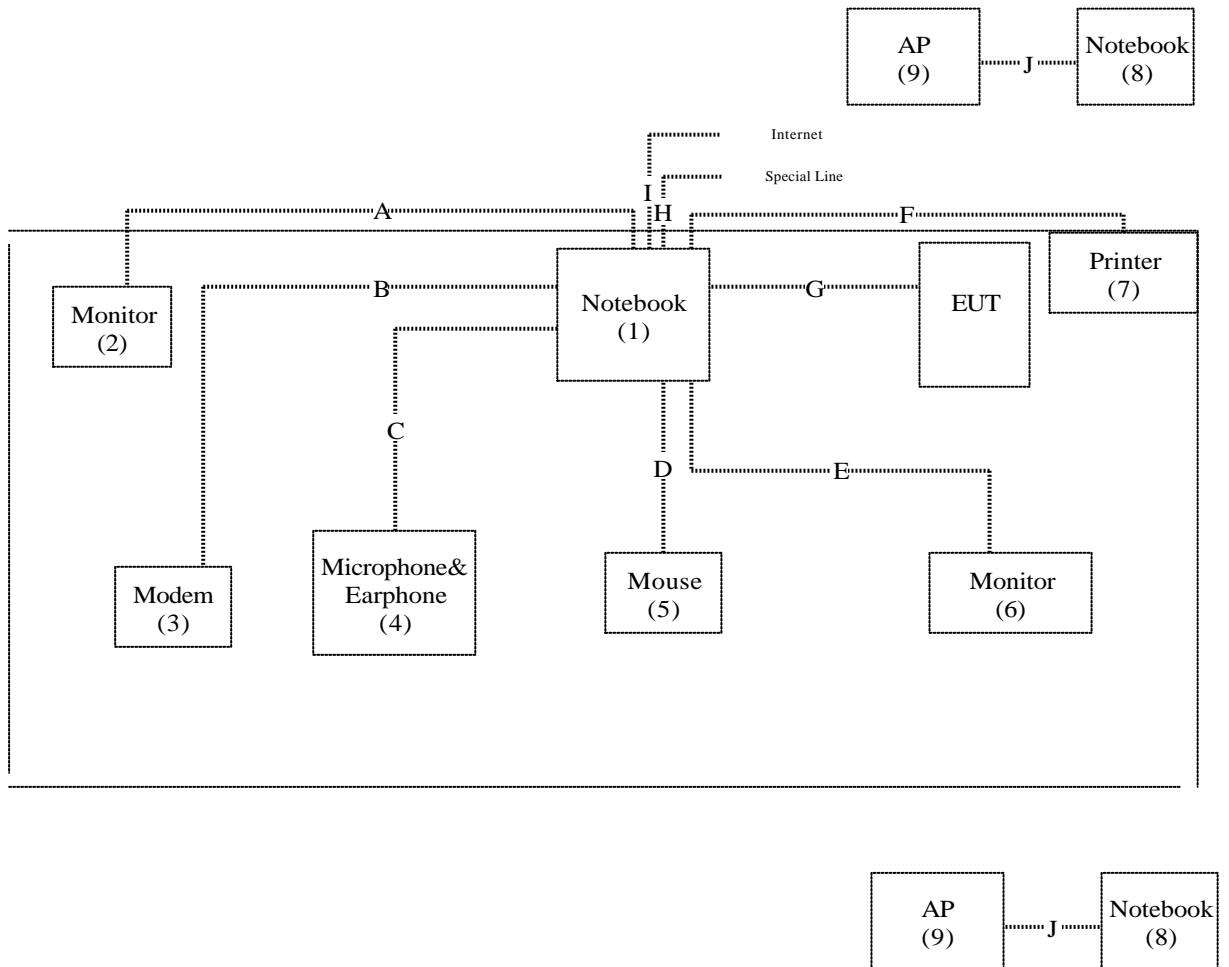



## 1.5. EUT Exercise Software

- 1.4.1 Setup the EUT and simulators as shown on 1.3.
- 1.4.2 Turn on the power of all equipment.
- 1.4.3 Notebook PC reads data from disk.
- 1.4.4 Data will be transmission and receiving through EUT.
- 1.4.5 The transmission and receive status will be shown on the monitor.
- 1.4.6 Repeat the above procedure 1.4.3 to 1.4.5

**1.6. Test Facility**

Ambient conditions in the laboratory:

Items	Required (IEC 68-1)	Actual
Temperature (°C)	15-35	20-35
Humidity (%RH)	25-75	50-65
Barometric pressure (mbar)	860-1060	950-1000

Site Description: June 22, 2001 File on  
 Federal Communications Commission  
 FCC Engineering Laboratory  
 7435 Oakland Mills Road  
 Columbia, MD 21046  
 Reference 31040/SIT1300F2



June 30, 2002 Accreditation on NVLAP  
 NVLAP Lab Code: 200533-0

Site Name: Quietek Corporation

Site Address: No. 5-22, Ruei-Shu Valley, Ruei-Ping Tsuen,  
 Lin Kou Shiang, Taipei 244 Taiwan, R.O.C.  
 TEL : 886-2-8601-3788 / FAX : 886-2-8601-3789  
 E-Mail : [service@quietek.com](mailto:service@quietek.com)

## 2. Conducted Emission

### 2.1. Test Equipment

The following test equipment are used during the conducted emission test:

Item	Instrument	Manufacturer	Type No./Serial No	Last Cal..	Remark
1	Test Receiver	R & S	ESCS 30/838251/0001	May, 2002	
2	L.I.S.N.	R & S	ESH3-Z5/836679/0023	May, 2002	EUT
3	L.I.S.N.	R & S	ENV 4200/833209/0023	May, 2002	Peripherals
4	Pulse Limiter	R & S	ESH3-Z2	May, 2002	
5	No.4 Shielded Room			N/A	

Note: All equipment upon which need to calibrated are with calibration period of 1 year.

### 2.2. Test Setup

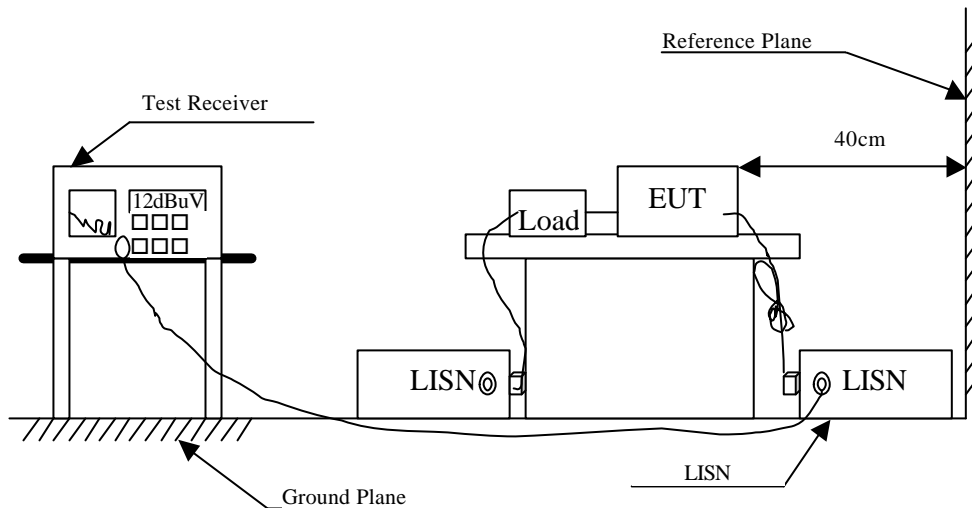

### 2.3. Limit

FCC Part 15 Subpart B Paragraph 15.207 (dBuV) Limit		
Frequency MHz	Limits	
	uV	dBuV
0.15 - 0.50	66-56 <sub>(註)</sub>	56-46 <sub>(註)</sub>
0.50-5.0	56	46
5.0 - 30	60	50

## 2.4. Test Procedure

The EUT and simulators are connected to the main power through a line impedance stabilization network (L.I.S.N.). This provides a 50 ohm /50uH coupling impedance for the measuring equipment. The peripheral devices are also connected to the main power through a LISN that provides a 50ohm/50uH coupling impedance with 50ohm termination. (Please refer to the block diagram of the test setup and photographs.)

Both sides of A.C. line are checked for maximum conducted interference. In order to find the maximum emission, the relative positions of equipment and all of the interface cables must be changed according to ANSI C63.4:1992 on conducted measurement.

Conducted emissions were investigated over the frequency range from 0.15MHz to 30MHz using a receiver bandwidth of 9kHz.

## 2.5. Test Result of Conducted Emission

Product : 802.11b WLAN Mini-USB Adaptor  
 Test Item : Conducted Emission  
 Test Mode : Normal Operation

Frequency MHz	Cable Loss dB	LISN Factor dB	Reading Level dBuV	Emission Level dBuV	Limits dBuV
<b>Line 1</b>					
<b>Quasi-Peak:</b>					
* 0.175	0.21	0.10	53.62	53.93	64.73
0.236	0.21	0.10	48.09	48.40	62.24
0.412	0.21	0.10	33.18	33.49	57.61
3.646	0.23	0.16	28.80	29.18	56.00
16.404	0.35	0.38	27.65	28.38	60.00
21.533	0.26	0.48	33.39	34.13	60.00
<b>Average</b>					
0.175	0.21	0.10	43.90	44.21	54.72
0.236	0.21	0.10	37.30	37.61	52.24
0.412	0.21	0.10	26.70	27.01	47.61
3.646	0.23	0.16	22.30	22.68	46.00
16.404	0.35	0.38	22.20	22.93	50.00
21.533	0.26	0.48	25.40	26.14	50.00

Note:

1. All Reading Levels are Quasi-Peak value.
2. “ \* ”, means this data is the worst emission level.
3. Emission Level = Reading Level + LISN Factor + Cable Loss.

Product : 802.11b WLAN Mini-USB Adaptor  
 Test Item : Conducted Emission  
 Test Mode : Normal Operation

Frequency	Cable	LISN	Reading	Emission	Limits
MHz	Loss	Factor	Level	Level	
	dB	dB	dBuV	dBuV	dBuV
<b>Line 2</b>					
<b>Quasi-Peak:</b>					
* 0.175	0.21	0.10	51.55	51.86	64.73
0.235	0.21	0.10	46.07	46.38	62.29
0.295	0.21	0.10	39.28	39.59	60.40
0.357	0.21	0.10	35.70	36.01	58.80
4.313	0.17	0.16	27.25	27.59	56.00
18.408	0.36	0.42	32.28	33.06	60.00
<b>Average</b>					
0.175	0.21	0.10	40.80	41.11	54.72
0.236	0.21	0.10	35.10	35.41	52.24
0.295	0.21	0.10	29.30	29.61	50.38
0.357	0.21	0.10	28.70	29.01	48.80
4.313	0.17	0.16	21.20	21.54	46.00
18.408	0.36	0.42	26.10	26.88	50.00

Note:

1. All Reading Levels are Quasi-Peak value.
2. “ \* ”, means this data is the worst emission level.
3. Emission Level = Reading Level + LISN Factor + Cable Loss.

### 3. Peak Power Output

#### 3.1. Test Equipment

The following test equipments are used during the radiated emission tests:

	Equipment	Manufacturer	Model No./Serial No.	Last Cal.
X	Spectrum Analyzer	Advantest	R3272 / 72421194	May, 2002

Note: 1. All equipment upon which need to calibrated are with calibration period of 1 year.  
 2. Mark "X" test instruments are used to measure the final test results.

#### 3.2. Test Setup

##### Conduction Power Measurement

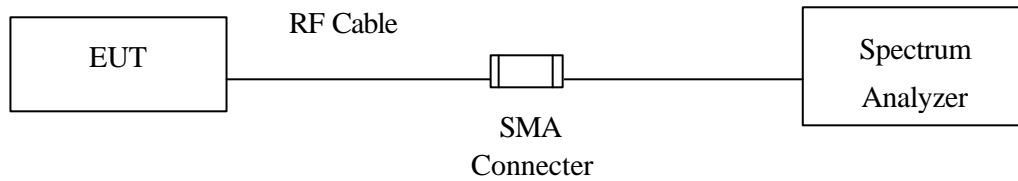

#### 3.3. Limits

The maximum peak power shall be less 1 Watt.

### 3.4. Test Result of Peak Power Output

Product : 802.11b WLAN Mini-USB Adaptor  
 Test Item : Peak Power Output  
 Test Site : No.3 OATS  
 Test Mode : Normal Operation

#### Data Speed: 1Mbps

Channel No.	Frequency(MHz)	Measurement	Required Limit	Result
1	2410.9	16.85dBm	1Watt= 30 dBm	Pass
6	2436.0	16.52dBm	1Watt= 30 dBm	Pass
11	2461.0	17.14dBm	1Watt= 30 dBm	Pass

#### Data Speed: 11Mbps

Channel No.	Frequency (MHz)	Measurement	Required Limit	Result
1	2411.0	16.69dBm	1Watt= 30 dBm	Pass
6	2436.0	16.45dBm	1Watt= 30 dBm	Pass
11	2460.9	16.92dBm	1Watt= 30 dBm	Pass



## 4. RF Exposure Evaluation

### 4.1. Limits

According to FCC 1.1310: The criteria listed in the following table shall be used to evaluate the environment impact of human exposure to radio frequency (RF) radiation as specified in 1.1307(b)

#### LIMITS FOR MAXIMUM PERMISSIBLE EXPOSURE (MPE)

Frequency Range (MHz)	Electric Field Strength (V/m)	Magnetic Field Strength (A/m)	Power Density (mW/cm <sup>2</sup> )	Average Time (Minutes)
(A) Limits for Occupational/ Control Exposures				
300-1500	--	--	F/300	6
1500-100,000	--	--	5	6
(B) Limits for General Population/ Uncontrolled Exposures				
300-1500	--	--	F/1500	6
1500-100,000	--	--	1	30

F= Frequency in MHz

Friis Formula

Friis transmission formula:  $Pd = (Pout * G) / (4 * \pi * r^2)$

Where

Pd = power density in mW/cm<sup>2</sup>

Pout = output power to antenna in mW

G = gain of antenna in linear scale

Pi = 3.1416

R = distance between observation point and center of the radiator in cm

Pd is the limit of MPE, 1 mW/cm<sup>2</sup>. If we know the maximum gain of the antenna and the total power input to the antenna, through the calculation, we will know the distance r where the MPE limit is reached.

### 4.2. Test Procedure

Software provided by client enabled the EUT to transmit and receive data at lowest, middle and highest channel individually.

The temperature and related humidity: 18 and 78% RH.

**4.3. Test Result of RF Exposure Evaluation**

Product : 802.11b WLAN Mini-USB Adaptor  
 Test Item : RF Exposure Evaluation  
 Test Site : No.3 OATS  
 Test Mode : Normal Operation

**Antenna Gain**

Antenna Gain: The maximum Gain measured in fully anechoic chamber is 2.25dBi or 1.51 in linear scale.

**Output Power Into Antenna & RF Exposure Evaluation Distance:**

Channel	Channel Frequency (MHz)	Output Power to Antenna (mW)	Minimum Allowable Distance @From Skin(cm)
1 (1Mbps)	2410.9	48.41724	2.3329
1 (11Mbps)	2411.0	46.66594	2.2903
6 (1Mbps)	2436.0	44.87454	2.2459
6 (11Mbps)	2436.0	44.15704	2.2279
11 (1Mbps)	2461.0	51.76068	2.2412
11 (11Mbps)	2460.9	49.20395	2.3518

The distance r (4<sup>th</sup> column) calculated from the Fries transmission formula is far shorter than 20 cm separation requirement. So, RF exposure limit warning or SAR test are not required.

## 5. Radiated Emission

### 5.1. Test Equipment

The following test equipment are used during the radiated emission test:

Test Site	Equipment	Manufacturer	Model No./Serial No.	Last Cal.
<input type="checkbox"/> Site # 1	Test Receiver	R & S	ESVS 10 / 834468/003	July, 2002
	Spectrum Analyzer	Advantest	R3162/ 00803480	May, 2002
	Pre-Amplifier	Advantest	BB525C/ 3307A01812	May, 2002
	Bilog Antenna	SCHAFFNER	CBL6112B / 2697	Nov., 2002
<input type="checkbox"/> Site # 2	Test Receiver	R & S	ESCS 30 / 836858 / 022	Nov., 2002
	Spectrum Analyzer	Advantest	3162 / 100803466	May, 2002
	Pre-Amplifier	Advantest	BB525C/3307A01814	May, 2002
	Bilog Antenna	SCHAFFNER	CBL6112B / 2705	Oct., 2002
	Horn Antenna	ETS	3115 / 0005-6160	July, 2002
	Pre-Amplifier	QTK	QTK-AMP-01/ 0001	July, 2002
<input checked="" type="checkbox"/> Site # 3	Test Receiver	R & S	ESI 26 / 838786 / 004	May, 2002
	Spectrum Analyzer	Advantest	3162 / 100803480	May, 2002
	Pre-Amplifier	QTK	QTK-AMP-03 / 0003	May, 2002
	Bilog Antenna	SCHAFFNER	CBL6112B / 2697	May, 2002
	Horn Antenna	ETS	3115 / 0005-6160	July, 2002
	Pre-Amplifier	QTK	QTK-AMP-01 / 0001	July, 2002

- Note:
1. All equipments that need to calibrate are with calibration period of 1 year.
  2. Mark "X" test instruments are used to measure the final test results.

### 5.2. Test Setup

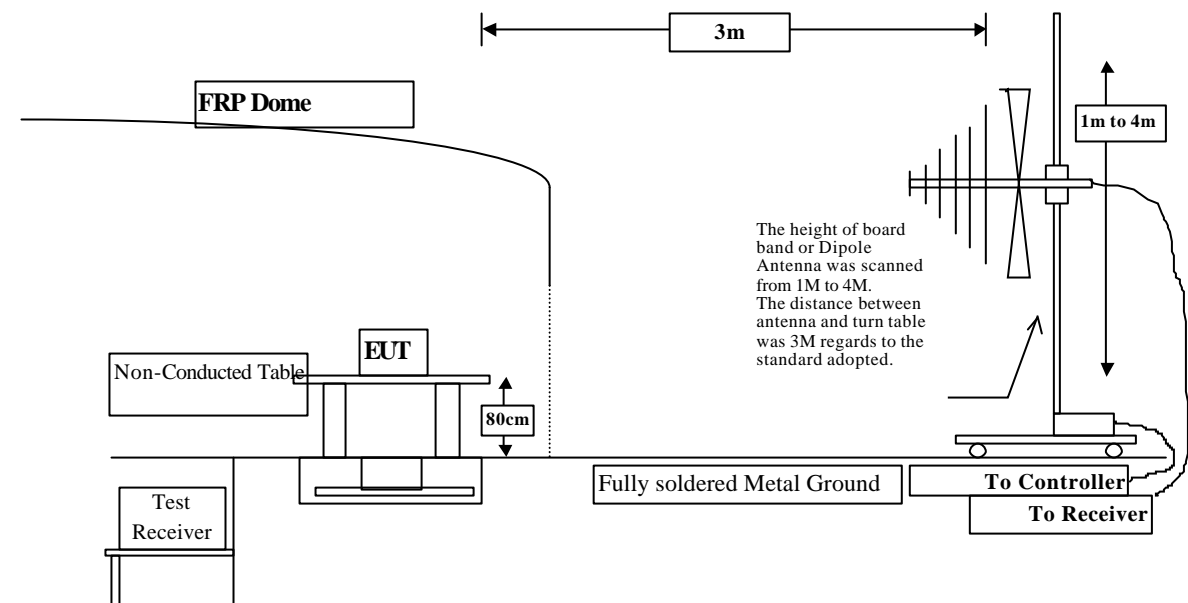

**5.3. Limits**

➤ **General Radiated Emission Limits**

Emissions radiated outside of the specified frequency bands, except for harmonics, shall be attenuated by at least 20dB below the level of the fundamental or to the general radiated emission limits in paragraph 15.209, whichever is the lesser attenuation.

<b>FCC Part 15 Subpart C Paragraph 15.209 Limits</b>		
Frequency MHz	uV/m @3m	dBuV/m@3m
30-88	100	40
88-216	150	43.5
216-960	200	46
Above 960	500	54

- Remarks :
1. RF Voltage (dBuV) = 20 log RF Voltage (uV)
  2. In the Above Table, the tighter limit applies at the band edges.
  3. Distance refers to the distance in meters between the measuring instrument antenna and the closed point of any part of the device or system.

#### 5.4. Test Procedure

The EUT and its simulators are placed on a turn table which is 0.8 meter above ground. The turn table can rotate 360 degrees to determine the position of the maximum emission level.

The EUT was positioned such that the distance from antenna to the EUT was 3 meters.

The antenna can move up and down between 1 meter and 4 meters to find out the maximum emission level.

Both horizontal and vertical polarization of the antenna are set on measurement. In order to find the maximum emission, all of the interface cables must be manipulated according to ANSI C63.4:1992 on radiated measurement.

The additional latch filter below 1GHz was used to measure the level of harmonics radiated emission during field strength of harmonics measurement.

The bandwidth below 1GHz setting on the field strength meter (R&S Test Receiver ESCS 30 )is 120 kHz, above 1GHz are 1 MHz.

The frequency range from 30MHz to 10th harmonics is checked.

**5.5. Test Result of Radiated Emission**

Product : 802.11b WLAN Mini-USB Adaptor  
 Test Item : Harmonic Radiated Emission  
 Test Site : No.3 OATS  
 Test Mode : Channel 1 (1Mbps)

Frequency	Cable	Probe	PreAMP	Reading	Emission	Margin	Limit
MHz	Loss	Factor	dB	Level	Level	dB	dBuV/m
	dB	dB/m		dBuV	dBuV/m		

**Horizontal**

**Peak Detector:**

4824.025	6.17	33.64	28.93	39.37	50.24	23.76	74.00
7236.025	7.33	36.77	28.99	36.52	51.63	22.37	74.00
9648.075	8.73	38.25	28.26	33.74	52.46	21.54	74.00

**Average Detector:**

--

**Vertical**

**Peak Detector:**

4824.068	6.17	33.64	28.93	39.00	49.87	24.13	74.00
7236.068	7.33	36.77	28.99	36.31	51.42	22.58	74.00
9648.070	8.73	38.25	28.26	33.24	51.96	22.04	74.00

**Average Detector:**

--

Note:

1. All Readings below 1GHz are Quasi-Peak, above are performed with peak and/or average measurements as necessary.
2. Receiver setting (Peak Detector) : RBW:1MHz; VBW:1MHz; Span:100MHz.
3. Receiver setting (AVG Detector) : RBW:1MHz; VBW:30Hz; Span:20MHz.
4. Emission Level = Reading Level + Probe Factor + Cable Loss – PreAMP.
5. The average measurement was not performed when the peak measured data under the limit of average detection. If the readings given are average, peak measurement should also be supplied.

Product : 802.11b WLAN Mini-USB Adaptor  
 Test Item : Harmonic Radiated Emission  
 Test Site : No.3 OATS  
 Test Mode : Channel 6 (1Mbps)

Frequency	Cable	Probe	PreAMP	Reading	Emission	Margin	Limit
MHz	Loss	Factor	dB	Level	Level	dB	dBuV/m
	dB	dB/m		dBuV	dBuV/m		

**Horizontal**

**Peak Detector:**

4873.924	6.21	33.77	28.96	40.36	51.39	22.61	74.00
7311.051	7.37	36.98	28.96	36.75	52.14	21.86	74.00
9748.122	8.87	38.35	28.13	34.22	53.31	20.69	74.00

**Average Detector:**

--

**Vertical**

**Peak Detector:**

4874.127	6.21	33.77	28.96	40.78	51.81	22.19	74.00
7311.200	7.37	36.98	28.96	36.19	51.58	22.42	74.00
9748.125	8.87	38.35	28.13	33.66	52.75	21.25	74.00

**Average Detector:**

--

**Note:**

1. All Readings below 1GHz are Quasi-Peak, above are performed with peak and/or average measurements as necessary.
2. Receiver setting (Peak Detector) : RBW:1MHz; VBW:1MHz; Span:100MHz.
3. Receiver setting (AVG Detector) : RBW:1MHz; VBW:30Hz; Span:20MHz.
4. Emission Level = Reading Level + Probe Factor + Cable Loss – PreAMP.
5. The average measurement was not performed when the peak measured data under the limit of average detection. If the readings given are average, peak measurement should also be supplied.

Product : 802.11b WLAN Mini-USB Adaptor  
 Test Item : Harmonic Radiated Emission  
 Test Site : No.3 OATS  
 Test Mode : Channel 11 (1Mbps)

Frequency	Cable	Probe	PreAMP	Reading	Emission	Margin	Limit
MHz	Loss	Factor		Level	Level		
	dB	dB/m	dB	dBuV	dBuV/m	dB	dBuV/m

**Horizontal**

**Peak Detector:**

4924.070	6.23	33.90	28.98	39.36	50.51	23.49	74.00
7386.066	7.42	37.14	28.94	35.93	51.54	22.46	74.00
9848.079	8.97	38.44	28.00	32.87	52.28	21.72	74.00

**Average Detector:**

--

**Vertical**

**Peak Detector:**

4924.079	6.23	33.90	28.98	39.71	50.86	23.14	74.00
7386.061	7.42	37.14	28.94	35.74	51.35	22.65	74.00
9848.067	8.97	38.44	28.00	32.30	51.71	22.29	74.00

**Average Detector:**

--

**Note:**

1. All Readings below 1GHz are Quasi-Peak, above are performed with peak and/or average measurements as necessary.
2. Receiver setting (Peak Detector) : RBW:1MHz; VBW:1MHz; Span:100MHz.
3. Receiver setting (AVG Detector) : RBW:1MHz; VBW:30Hz; Span:20MHz.
4. Emission Level = Reading Level + Probe Factor + Cable Loss – PreAMP.
5. The average measurement was not performed when the peak measured data under the limit of average detection. If the readings given are average, peak measurement should also be supplied.



Product : 802.11b WLAN Mini-USB Adaptor  
 Test Item : Harmonic Radiated Emission  
 Test Site : No.3 OATS  
 Test Mode : Channel 1 (11Mbps)

Frequency	Cable	Probe	PreAMP	Reading	Emission	Margin	Limit
MHz	Loss	Factor		Level	Level		
	dB	dB/m	dB	dBuV	dBuV/m	dB	dBuV/m

**Horizontal**

**Peak Detector:**

4824.031	6.17	33.64	28.93	40.47	51.34	22.66	74.00
7236.024	7.33	36.77	28.99	36.76	51.87	22.13	74.00
9648.075	8.73	38.25	28.26	34.19	52.91	21.09	74.00

**Average Detector:**

--

**Vertical**

**Peak Detector:**

4824.071	6.17	33.64	28.93	39.29	50.16	23.84	74.00
7236.052	7.33	36.77	28.99	35.82	50.93	23.07	74.00
9648.081	8.73	38.25	28.26	33.71	52.43	21.57	74.00

**Average Detector:**

--

Note:

1. All Readings below 1GHz are Quasi-Peak, above are performed with peak and/or average measurements as necessary.
2. Receiver setting (Peak Detector) : RBW:1MHz; VBW:1MHz; Span:100MHz.
3. Receiver setting (AVG Detector) : RBW:1MHz; VBW:30Hz; Span:20MHz.
4. Emission Level = Reading Level + Probe Factor + Cable Loss – PreAMP.
5. The average measurement was not performed when the peak measured data under the limit of average detection. If the readings given are average, peak measurement should also be supplied.

Product : 802.11b WLAN Mini-USB Adaptor  
 Test Item : Harmonic Radiated Emission  
 Test Site : No.3 OATS  
 Test Mode : Channel 6 (11Mbps)

Frequency	Cable	Probe	PreAMP	Reading	Emission	Margin	Limit
MHz	Loss	Factor		Level	Level		
	dB	dB/m	dB	dBuV	dBuV/m	dB	dBuV/m

**Horizontal**

**Peak Detector:**

4873.860	6.21	33.77	28.96	39.72	50.75	23.25	74.00
7311.062	7.37	36.98	28.96	36.53	51.92	22.08	74.00
9748.134	8.87	38.35	28.13	33.52	52.61	21.39	74.00

**Average Detector:**

--

**Vertical**

**Peak Detector:**

4878.264	6.21	33.77	28.96	40.27	51.30	22.70	74.00
7311.267	7.37	36.98	28.96	36.40	51.79	22.21	74.00
9748.118	8.87	38.35	28.13	33.34	52.43	21.57	74.00

**Average Detector:**

--

**Note:**

1. All Readings below 1GHz are Quasi-Peak, above are performed with peak and/or average measurements as necessary.
2. Receiver setting (Peak Detector) : RBW:1MHz; VBW:1MHz; Span:100MHz.
3. Receiver setting (AVG Detector) : RBW:1MHz; VBW:30Hz; Span:20MHz.
4. Emission Level = Reading Level + Probe Factor + Cable Loss - PreAMP.
5. The average measurement was not performed when the peak measured data under the limit of average detection. If the readings given are average, peak measurement should also be supplied.

Product : 802.11b WLAN Mini-USB Adaptor  
 Test Item : Harmonic Radiated Emission  
 Test Site : No.3 OATS  
 Test Mode : Channel 11 (11Mbps)

Frequency	Cable	Probe	PreAMP	Reading	Emission	Margin	Limit
MHz	Loss	Factor		Level	Level		
	dB	dB/m	dB	dBuV	dBuV/m	dB	dBuV/m

**Horizontal**

**Peak Detector:**

4924.051	6.23	33.90	28.98	39.77	50.92	23.08	74.00
7386.029	7.42	37.14	28.94	35.71	51.32	22.68	74.00
9848.051	8.97	38.44	28.00	33.27	52.68	21.32	74.00

**Average Detector:**

--

**Vertical**

**Peak Detector:**

4924.082	6.23	33.90	28.98	39.36	50.51	23.49	74.00
7386.054	7.42	37.14	28.94	36.21	51.82	22.18	74.00
9848.024	8.97	38.44	28.00	32.78	52.19	21.81	74.00

**Average Detector:**

--

**Note:**

1. All Readings below 1GHz are Quasi-Peak, above are performed with peak and/or average measurements as necessary.
2. Receiver setting (Peak Detector) : RBW:1MHz; VBW:1MHz; Span:100MHz.
3. Receiver setting (AVG Detector) : RBW:1MHz; VBW:30Hz; Span:20MHz.
4. Emission Level = Reading Level + Probe Factor + Cable Loss – PreAMP.
5. The average measurement was not performed when the peak measured data under the limit of average detection. If the readings given are average, peak measurement should also be supplied.

Product : 802.11b WLAN Mini-USB Adaptor  
 Test Item : General Radiated Emission  
 Test Site : No.3 OATS  
 Test Mode : Channel 1-1Mbps

Frequency	Cable	Probe	PreAMP	Reading	Emission	Margin	Limit
MHz	Loss	Factor		Level	Level		
	dB	dB/m	dB	dBuV	dBuV/m	dB	dBuV/m

**Horizontal**

62.881	1.04	5.65	0.00	16.89	23.58	16.42	40.00
178.410	1.63	8.40	0.00	24.05	34.09	9.41	43.50
* 300.630	2.26	12.46	0.00	23.12	37.84	8.16	46.00
343.310	2.48	12.97	0.00	21.62	37.08	8.92	46.00
455.830	3.06	16.66	0.00	13.53	33.26	12.74	46.00
576.110	3.69	17.62	0.00	11.55	32.86	13.14	46.00

**Vertical**

112.054	1.29	10.92	0.00	20.30	32.51	10.99	43.50
153.190	1.50	8.93	0.00	23.58	34.02	9.48	43.50
225.940	1.88	9.38	0.00	18.64	29.90	16.10	46.00
362.150	2.58	14.38	0.00	16.37	33.32	12.68	46.00
431.580	2.93	17.33	0.00	15.28	35.55	10.45	46.00
* 589.690	3.75	19.61	0.00	14.20	37.55	8.45	46.00

Note:

1. All Readings below 1GHz are Quasi-Peak, above are performed with peak and/or average measurements as necessary.
2. “ \* ”, means this data is the worst emission level.
3. Emission Level = Reading Level + Probe Factor + Cable Loss.

Product : 802.11b WLAN Mini-USB Adaptor  
 Test Item : General Radiated Emission  
 Test Site : No.3 OATS  
 Test Mode : Channel 6-1Mbps

Frequency	Cable	Probe	PreAMP	Reading	Emission	Margin	Limit
MHz	Loss	Factor		Level	Level		
	dB	dB/m	dB	dBuV	dBuV/m	dB	dBuV/m

**Horizontal**

76.320	1.11	7.32	0.00	20.60	29.03	10.97	40.00
* 175.500	1.62	8.56	0.00	25.02	35.20	8.30	43.50
221.092	1.85	8.63	0.00	18.64	29.13	16.87	46.00
307.420	2.30	12.13	0.00	18.49	32.91	13.09	46.00
483.960	3.21	16.65	0.00	15.27	35.13	10.87	46.00
702.210	4.33	18.30	0.00	12.34	34.98	11.02	46.00

**Vertical**

79.470	1.12	7.12	0.00	20.06	28.31	11.69	40.00
132.514	1.40	10.55	0.00	18.69	30.64	12.86	43.50
195.870	1.72	8.11	0.00	21.30	31.14	12.36	43.50
219.150	1.84	8.99	0.00	18.64	29.47	16.53	46.00
328.120	2.40	12.51	0.00	16.88	31.80	14.20	46.00
* 453.165	3.05	16.73	0.00	15.30	35.08	10.92	46.00

**Note:**

1. All Readings below 1GHz are Quasi-Peak, above are performed with peak and/or average measurements as necessary.
2. “ \* ”, means this data is the worst emission level.
3. Emission Level = Reading Level + Probe Factor + Cable Loss.

Product : 802.11b WLAN Mini-USB Adaptor  
 Test Item : General Radiated Emission  
 Test Site : No.3 OATS  
 Test Mode : Channel 11-1Mbps

Frequency	Cable	Probe	PreAMP	Reading	Emission	Margin	Limit
MHz	Loss	Factor		Level	Level		
	dB	dB/m	dB	dBuV	dBuV/m	dB	dBuV/m

**Horizontal**

*	48.559	0.96	8.36	0.00	21.30	30.62	9.38	40.00
	120.362	1.33	11.84	0.00	17.85	31.02	12.48	43.50
	167.241	1.57	9.09	0.00	19.00	29.66	13.84	43.50
	272.184	2.12	11.73	0.00	18.34	32.19	13.81	46.00
	395.694	2.76	14.46	0.00	15.31	32.53	13.47	46.00
	542.114	3.50	17.68	0.00	13.87	35.06	10.94	46.00

**Vertical**

	50.225	0.97	6.60	0.00	19.54	27.12	12.88	40.00
	144.257	1.46	9.86	0.00	18.57	29.88	13.62	43.50
	178.350	1.63	8.28	0.00	20.14	30.05	13.45	43.50
	240.633	1.95	10.96	0.00	21.39	34.30	11.70	46.00
	300.547	2.26	12.06	0.00	17.42	31.74	14.26	46.00
*	462.315	3.10	16.47	0.00	15.03	34.59	11.41	46.00

Note:

1. All Readings below 1GHz are Quasi-Peak, above are performed with peak and/or average measurements as necessary.
2. “ \* ”, means this data is the worst emission level.
3. Emission Level = Reading Level + Probe Factor + Cable Loss.

Product : 802.11b WLAN Mini-USB Adaptor  
 Test Item : General Radiated Emission  
 Test Site : No.3 OATS  
 Test Mode : Channel 1-11Mbps

Frequency	Cable	Probe	PreAMP	Reading	Emission	Margin	Limit
MHz	Loss	Factor		Level	Level		
	dB	dB/m	dB	dBuV	dBuV/m	dB	dBuV/m

**Horizontal**

86.314	1.16	8.78	0.00	19.64	29.58	10.42	40.00
* 136.245	1.42	11.20	0.00	20.48	33.10	10.40	43.50
226.150	1.88	9.13	0.00	18.24	29.25	16.75	46.00
374.115	2.64	14.20	0.00	15.24	32.08	13.92	46.00
453.760	3.05	16.34	0.00	16.37	35.77	10.23	46.00
586.780	3.74	17.92	0.00	14.22	35.87	10.13	46.00

**Vertical**

82.114	1.14	7.53	0.00	22.70	31.37	8.63	40.00
150.142	1.49	9.13	0.00	18.24	28.86	14.64	43.50
195.226	1.72	8.11	0.00	16.37	26.20	17.30	43.50
306.241	2.29	12.14	0.00	17.42	31.85	14.15	46.00
388.540	2.71	15.53	0.00	16.95	35.20	10.80	46.00
* 582.412	3.72	19.51	0.00	14.20	37.43	8.57	46.00

Note:

1. All Readings below 1GHz are Quasi-Peak, above are performed with peak and/or average measurements as necessary.
2. “ \* ”, means this data is the worst emission level.
3. Emission Level = Reading Level + Probe Factor + Cable Loss.

Product : 802.11b WLAN Mini-USB Adaptor  
 Test Item : General Radiated Emission  
 Test Site : No.3 OATS  
 Test Mode : Channel 6-11Mbps

Frequency	Cable	Probe	PreAMP	Reading	Emission	Margin	Limit
	Loss	Factor		Level	Level		
MHz	dB	dB/m	dB	dBuV	dBuV/m	dB	dBuV/m

**Horizontal**

118.640	1.32	11.74	0.00	18.50	31.56	11.94	43.50
168.650	1.58	8.96	0.00	15.97	26.52	16.98	43.50
236.482	1.93	10.09	0.00	18.67	30.69	15.31	46.00
288.314	2.20	11.91	0.00	16.49	30.60	15.40	46.00
* 359.994	2.57	13.68	0.00	18.21	34.47	11.53	46.00
456.215	3.06	16.66	0.00	14.20	33.93	12.07	46.00

**Vertical**

64.559	1.05	5.93	0.00	18.48	25.46	14.54	40.00
149.968	1.49	9.13	0.00	21.30	31.92	11.58	43.50
208.540	1.79	8.72	0.00	19.34	29.85	13.65	43.50
314.251	2.33	12.36	0.00	16.45	31.14	14.86	46.00
* 396.665	2.76	15.89	0.00	15.86	34.51	11.49	46.00
528.102	3.44	16.93	0.00	12.59	32.96	13.04	46.00

**Note:**

1. All Readings below 1GHz are Quasi-Peak, above are performed with peak and/or average measurements as necessary.
2. “ \* ”, means this data is the worst emission level.
3. Emission Level = Reading Level + Probe Factor + Cable Loss.



Product : 802.11b WLAN Mini-USB Adaptor  
 Test Item : General Radiated Emission  
 Test Site : No.3 OATS  
 Test Mode : Channel 11-11Mbps

Frequency	Cable	Probe	PreAMP	Reading	Emission	Margin	Limit
	Loss	Factor		Level	Level		
MHz	dB	dB/m	dB	dBuV	dBuV/m	dB	dBuV/m

**Horizontal**

56.295	1.00	5.93	0.00	19.74	26.68	13.32	40.00
148.642	1.48	10.54	0.00	20.16	32.18	11.32	43.50
248.957	1.99	11.46	0.00	19.52	32.97	13.03	46.00
325.510	2.39	12.26	0.00	16.49	31.15	14.85	46.00
438.190	2.97	15.79	0.00	15.81	34.57	11.43	46.00
* 562.115	3.61	17.23	0.00	14.02	34.86	11.14	46.00

**Vertical**

* 110.672	1.28	11.12	0.00	20.05	32.45	11.05	43.50
175.425	1.62	8.52	0.00	17.84	27.98	15.52	43.50
262.025	2.06	13.12	0.00	19.34	34.53	11.47	46.00
315.280	2.34	12.36	0.00	17.91	32.60	13.40	46.00
390.051	2.73	15.45	0.00	16.24	34.43	11.57	46.00
464.851	3.11	16.42	0.00	12.50	32.04	13.96	46.00

Note:

1. All Readings below 1GHz are Quasi-Peak, above are performed with peak and/or average measurements as necessary.
2. “ \* ”, means this data is the worst emission level.
3. Emission Level = Reading Level + Probe Factor + Cable Loss.

## 6. Band Edge

### 6.1. Test Equipment

The following test equipments are used during the band edge tests:

Equipment	Manufacturer	Model No./Serial No.	Last Cal.
X Spectrum Analyzer	Advantest	R3272 / 72421194	May, 2002
X Test Receiver	R & S	ESCS 30 / 825442/14	May, 2002
X Spectrum Analyzer	Advantest	R3261C / 71720140	May, 2002
X Pre-Amplifier	HP	8447D/3307A01812	May, 2002
X Bilog Antenna	Chase	CBL6112B / 12452	Sep., 2002
X Horn Antenna	EM	EM6917 / 103325	May, 2002

- Note: 1. All equipments that need to calibrate are with calibration period of 1 year.  
 2. Mark "X" test instruments are used to measure the final test results.

### 6.2. Test Setup

#### RF Conducted Measurement:

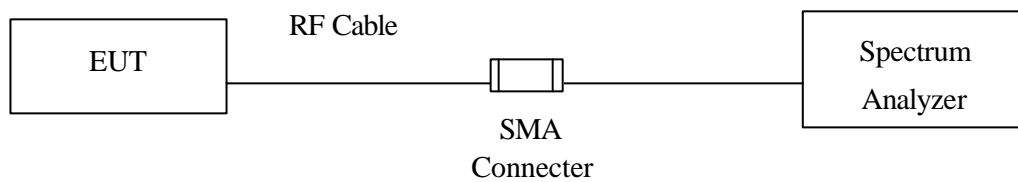

#### RF Radiated Measurement:

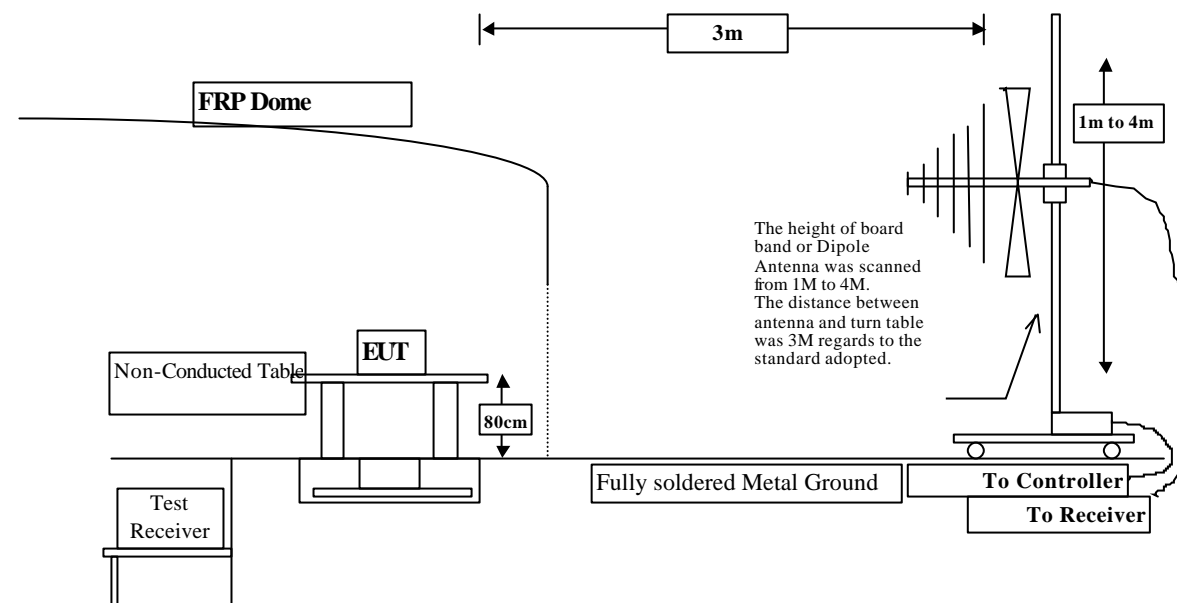

### **6.3. Limits**

In any 100 kHz bandwidth outside the frequency band in which the spread spectrum intentional radiator is operating, the radio frequency power that is produced by the intentional radiator shall be at least 20 dB below that in the 100 kHz bandwidth within the band that contains the highest level of the desired power, based on either an RF conducted or a radiated measurement. Attenuation below the general limits specified in Section 15.209(a) is not required. In addition, radiated emissions which fall in the restricted bands, as defined in Section 15.205(a), must also comply with the radiated emission limits specified in Section 15.209(a) (see Section 15.205(c)).

### **6.4. Test Procedure**

The EUT and its simulators are placed on a turn table which is 0.8 meter above ground. The turn table can rotate 360 degrees to determine the position of the maximum emission level. The EUT was positioned such that the distance from antenna to the EUT was 3 meters.

The antenna can move up and down between 1 meter and 4 meters to find out the maximum emission level.

Both horizontal and vertical polarization of the antenna are set on measurement. In order to find the maximum emission, all of the interface cables must be manipulated according to ANSI C63.4:1992 on radiated measurement.

The bandwidth below 1GHz setting on the field strength meter (R&S Test Receiver ESCS 30 )is 120 kHz, above 1GHz are 1 MHz.

6.5. Test Result of Band Edge

Product : 802.11b WLAN Mini-USB Adaptor  
 Test Item : Band Edge  
 Test Site : No.3 OATS  
 Test Mode : Channel 1 (1Mbps)

RF Radiated Measurement:

Channel No.	Frequency (MHz)	Required Limit (dBc)	Result
1 (Horizontal)	<2400	>20	Pass

Figure Channel 1: (Horizontal)

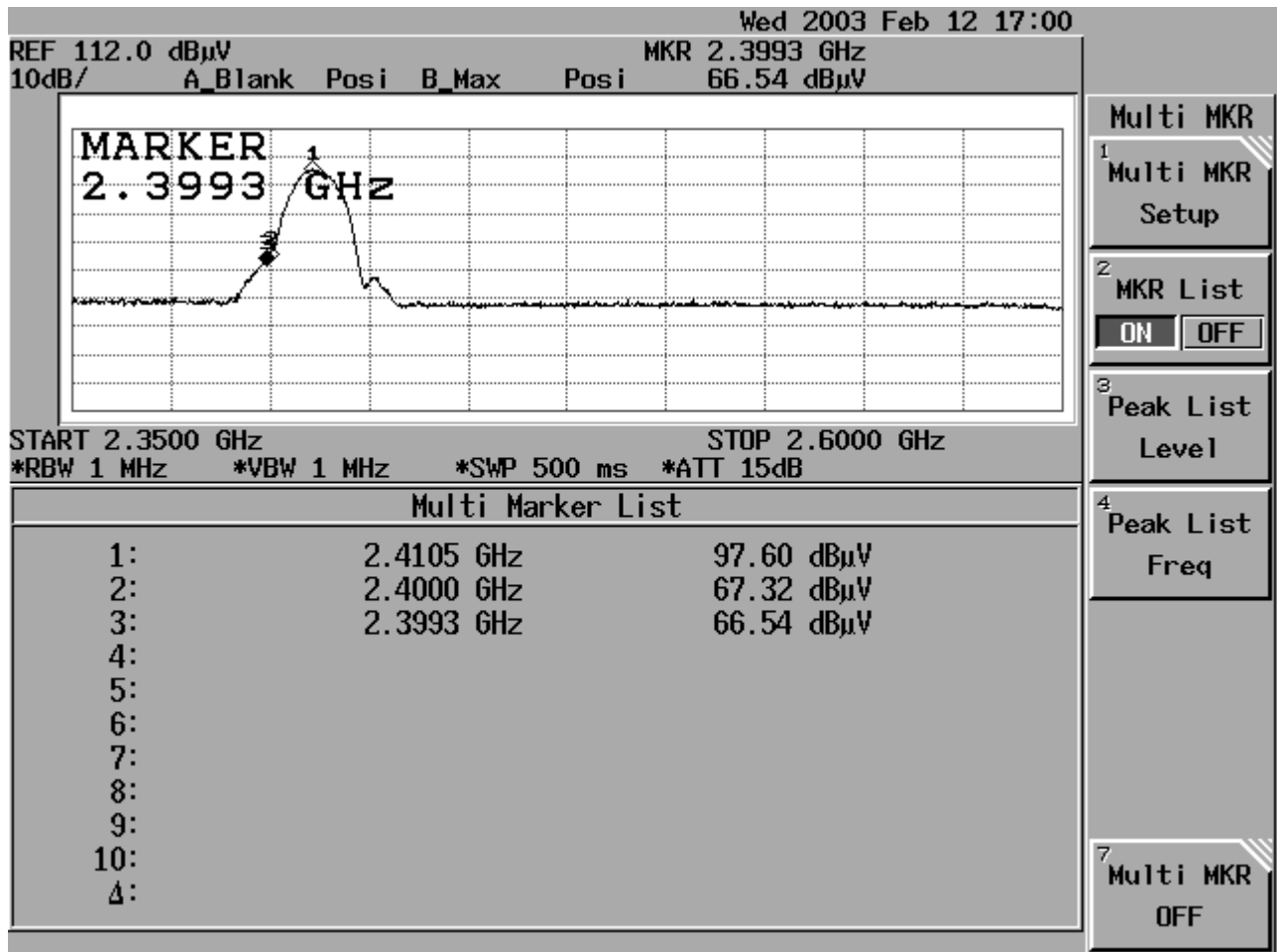

Product : 802.11b WLAN Mini-USB Adaptor  
 Test Item : Band Edge  
 Test Site : No.3 OATS  
 Test Mode : Channel 1 (1Mbps)

**RF Radiated Measurement:**

Channel No.	Frequency (MHz)	Required Limit (dBc)	Result
1 (Vertical)	<2400	>20	Pass

Figure Channel 1: (Vertical)

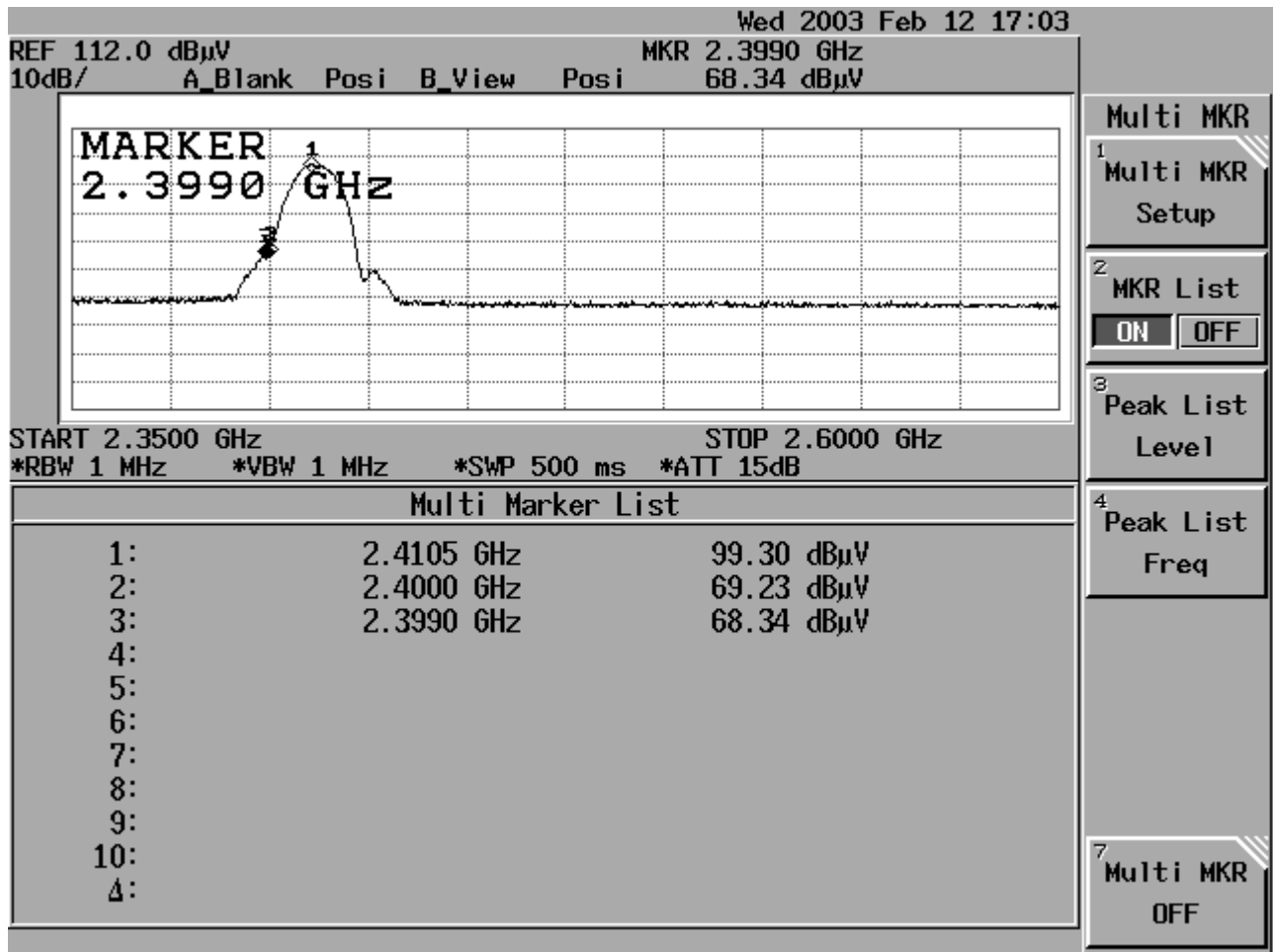

Product : 802.11b WLAN Mini-USB Adaptor  
 Test Item : Band Edge  
 Test Site : No.3 OATS  
 Test Mode : Channel 1 (11Mbps)

**RF Radiated Measurement:**

Channel No.	Frequency (MHz)	Required Limit (dBc)	Result
1 (Horizontal)	<2400	>20	Pass

Figure Channel 1: (Horizontal)

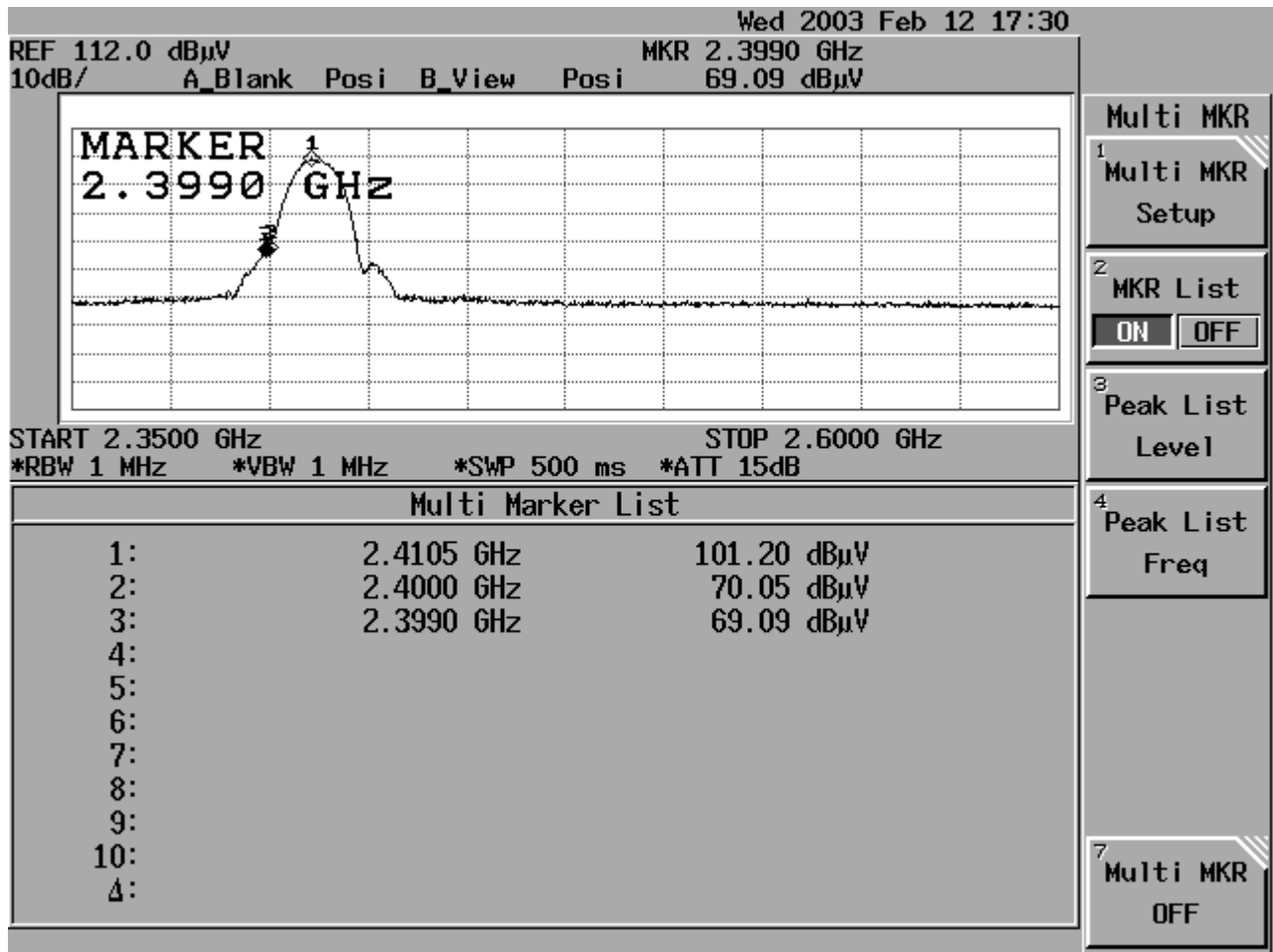

Product : 802.11b WLAN Mini-USB Adaptor  
 Test Item : Band Edge  
 Test Site : No.3 OATS  
 Test Mode : Channel 1 (11Mbps)

**RF Radiated Measurement:**

Channel No.	Frequency (MHz)	Required Limit (dBc)	Result
1 (Vertical)	<2400	>20	Pass

Figure Channel 1: (Vertical)

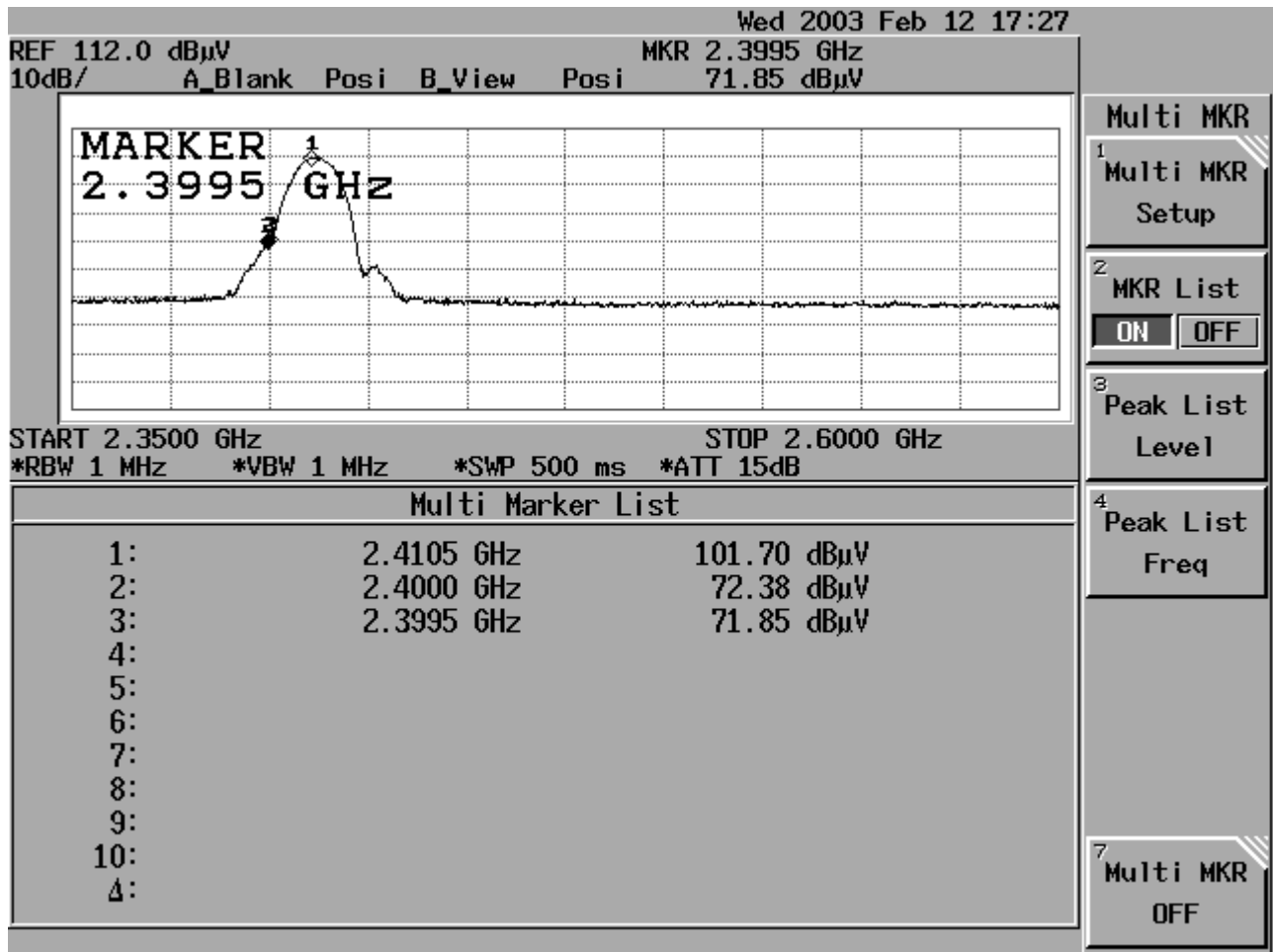

Product : 802.11b WLAN Mini-USB Adaptor  
 Test Item : Band Edge  
 Test Site : No.3 OATS  
 Test Mode : Channel 11 (1Mbps)

**RF Radiated Measurement: (Peak Detector)**

Channel No.	Frequency (MHz)	Reading Level (dBuV)	Probe Factor (dB/m)	Cable Loss (dB)	PreAMP (dB)	Emission Level (dBuV/m)	Peak Limit (dBuV/m)	Average Limit (dBuV/m)	Result
11(Horizontal)	2486.300	52.48	28.66	4.10	29.80	55.43	74	54	Pass

**RF Radiated Measurement: (Average Detector)**

Channel No.	Frequency (MHz)	Reading Level (dBuV)	Probe Factor (dB/m)	Cable Loss (dB)	PreAMP (dB)	Emission Level (dBuV/m)	Peak Limit (dBuV/m)	Average Limit (dBuV/m)	Result
11(Horizontal)	2486.300	42.40	28.66	4.10	29.80	45.35	74	54	Pass

Figure Channel 11: (Horizontal)

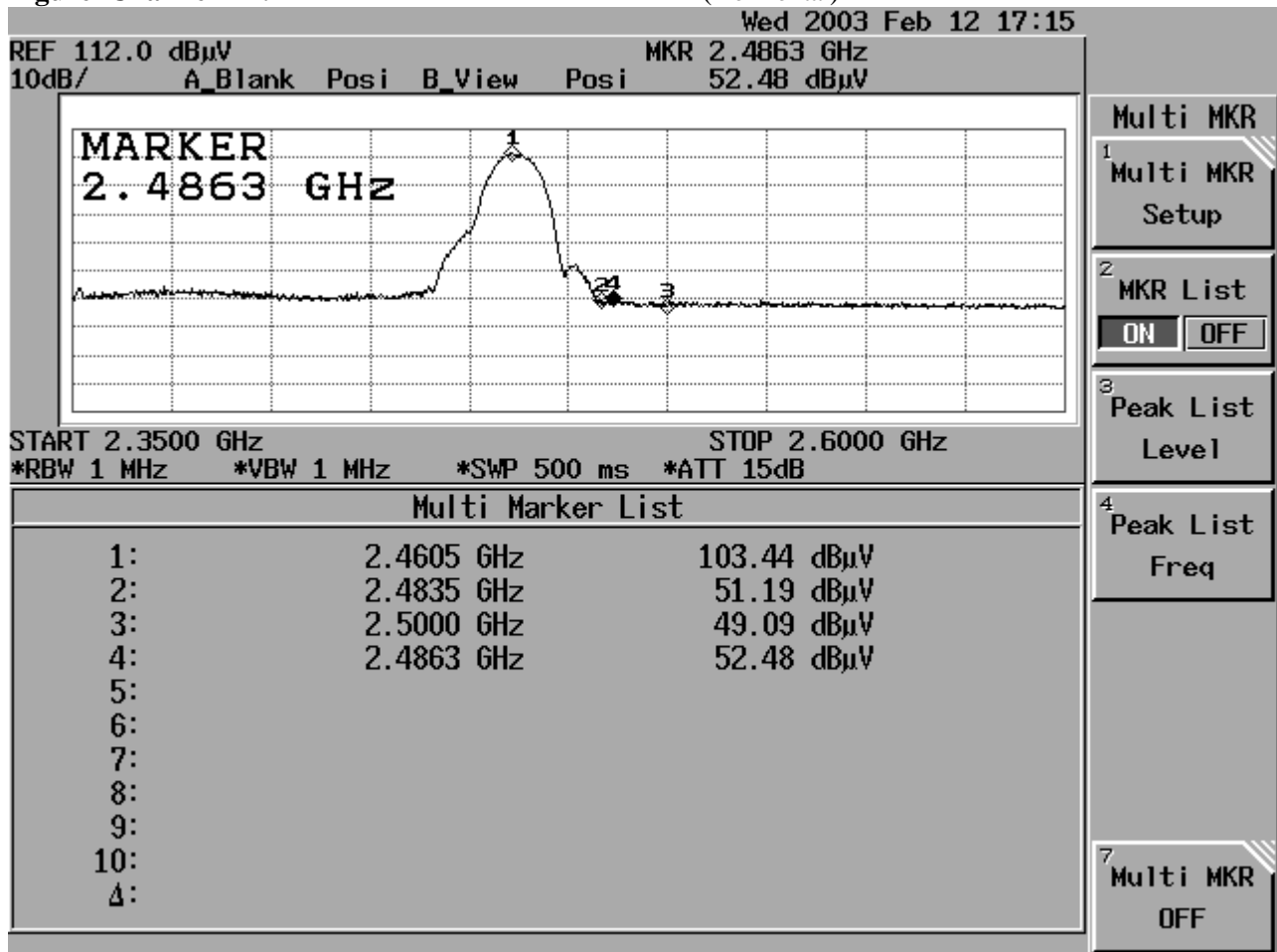

Note: The average measurement was not performed when the peak measured data under the limit of average detection. If the readings given are average, peak measurement should also be supplied.



Product : 802.11b WLAN Mini-USB Adaptor  
 Test Item : Band Edge  
 Test Site : No.3 OATS  
 Test Mode : Channel 11 (1Mbps)

**RF Radiated Measurement: (Peak Detector)**

Channel No.	Frequency (MHz)	Reading Level (dBuV)	Probe Factor (dB/m)	Cable Loss (dB)	PreAMP (dB)	Emission Level (dBuV/m)	Peak Limit (dBuV/m)	Average Limit (dBuV/m)	Result
11 (Vertical)	2489.800	51.34	28.66	4.10	29.80	54.29	74	54	Pass

**RF Radiated Measurement: (Average Detector)**

Channel No.	Frequency (MHz)	Reading Level (dBuV)	Probe Factor (dB/m)	Cable Loss (dB)	PreAMP (dB)	Emission Level (dBuV/m)	Peak Limit (dBuV/m)	Average Limit (dBuV/m)	Result
11 (Vertical)	2489.800	42.80	28.66	4.10	29.80	45.75	74	54	Pass

**Figure Channel 11: (Vertical)**

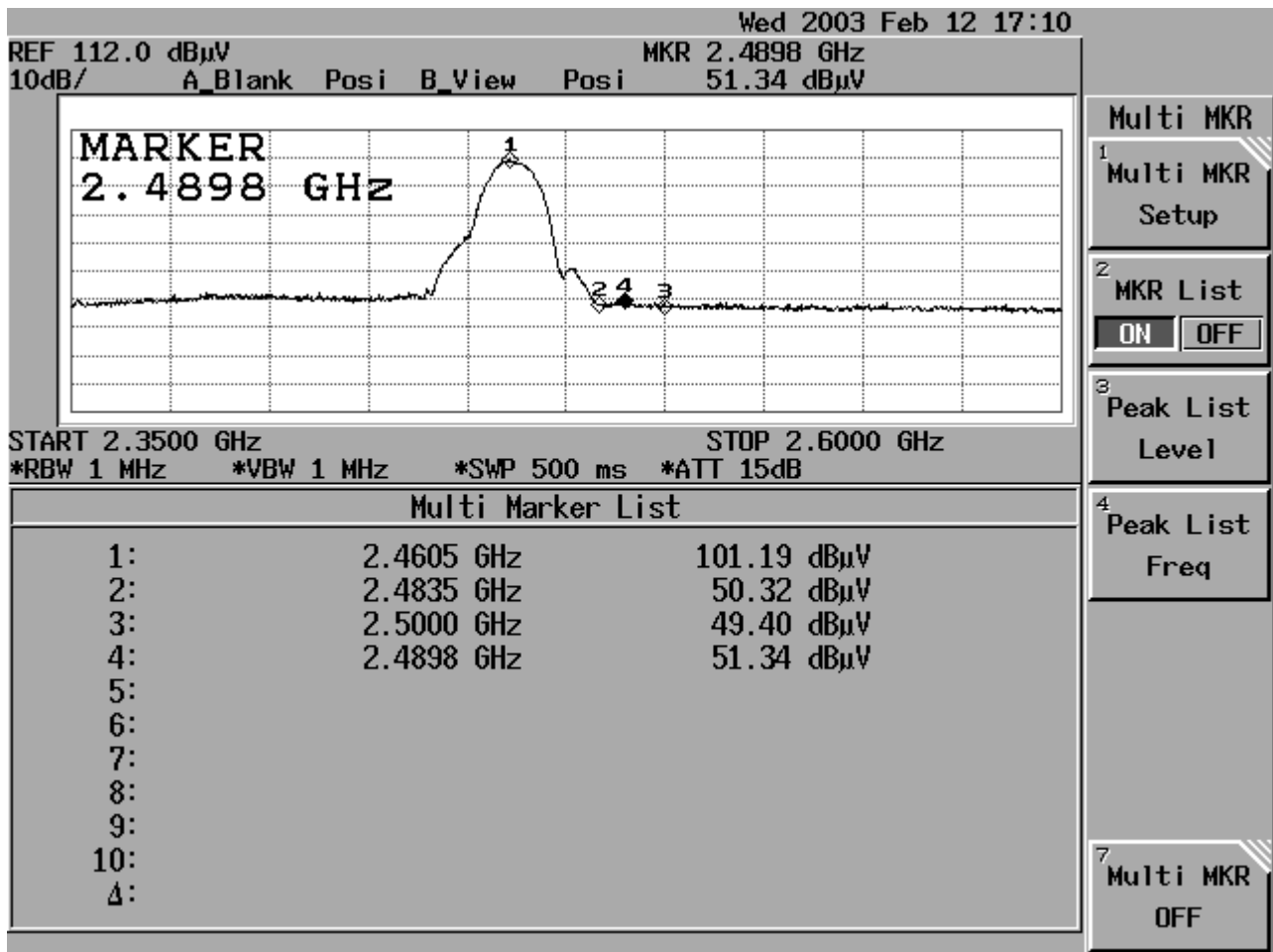

Note: The average measurement was not performed when the peak measured data under the limit of average detection. If the readings given are average, peak measurement should also be supplied.

Product : 802.11b WLAN Mini-USB Adaptor  
 Test Item : Band Edge  
 Test Site : No.3 OATS  
 Test Mode : Channel 11 (11Mbps)

**RF Radiated Measurement: (Peak Detector)**

Channel No.	Frequency (MHz)	Reading Level (dBuV)	Probe Factor (dB/m)	Cable Loss (dB)	PreAMP (dB)	Emission Level (dBuV/m)	Peak Limit (dBuV/m)	Average Limit (dBuV/m)	Result
11(Horizontal)	2488.500	52.63	28.66	4.10	29.80	55.58	74	54	Pass

**RF Radiated Measurement: (Average Detector)**

Channel No.	Frequency (MHz)	Reading Level (dBuV)	Probe Factor (dB/m)	Cable Loss (dB)	PreAMP (dB)	Emission Level (dBuV/m)	Peak Limit (dBuV/m)	Average Limit (dBuV/m)	Result
11(Horizontal)	2488.500	42.90	28.66	4.10	29.80	45.85	74	54	Pass

**Figure Channel 11:** (Horizontal)

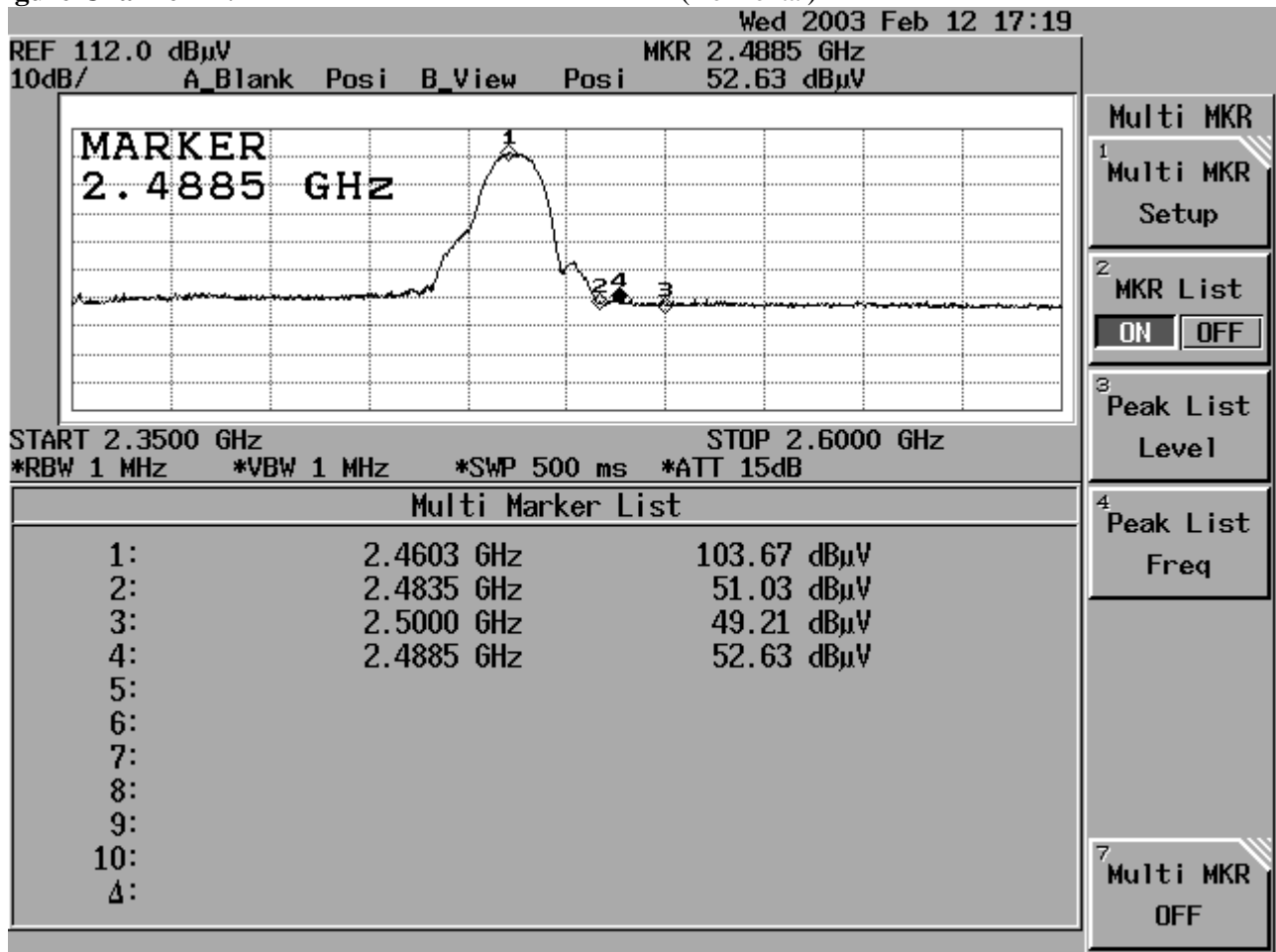

Note: The average measurement was not performed when the peak measured data under the limit of average detection. If the readings given are average, peak measurement should also be supplied.

Product : 802.11b WLAN Mini-USB Adaptor  
 Test Item : Band Edge  
 Test Site : No.3 OATS  
 Test Mode : Channel 11 (11Mbps)

**RF Radiated Measurement: (Peak Detector)**

Channel No.	Frequency (MHz)	Reading Level (dBuV)	Probe Factor (dB/m)	Cable Loss (dB)	PreAMP (dB)	Emission Level (dBuV/m)	Peak Limit (dBuV/m)	Average Limit (dBuV/m)	Result
11 (Vertical)	2488.000	51.62	28.66	4.10	29.80	54.57	74	54	Pass

**RF Radiated Measurement: (Average Detector)**

Channel No.	Frequency (MHz)	Reading Level (dBuV)	Probe Factor (dB/m)	Cable Loss (dB)	PreAMP (dB)	Emission Level (dBuV/m)	Peak Limit (dBuV/m)	Average Limit (dBuV/m)	Result
11 (Vertical)	2488.000	42.60	28.66	4.10	29.80	45.55	74	54	Pass

Figure Channel 11: (Vertical)

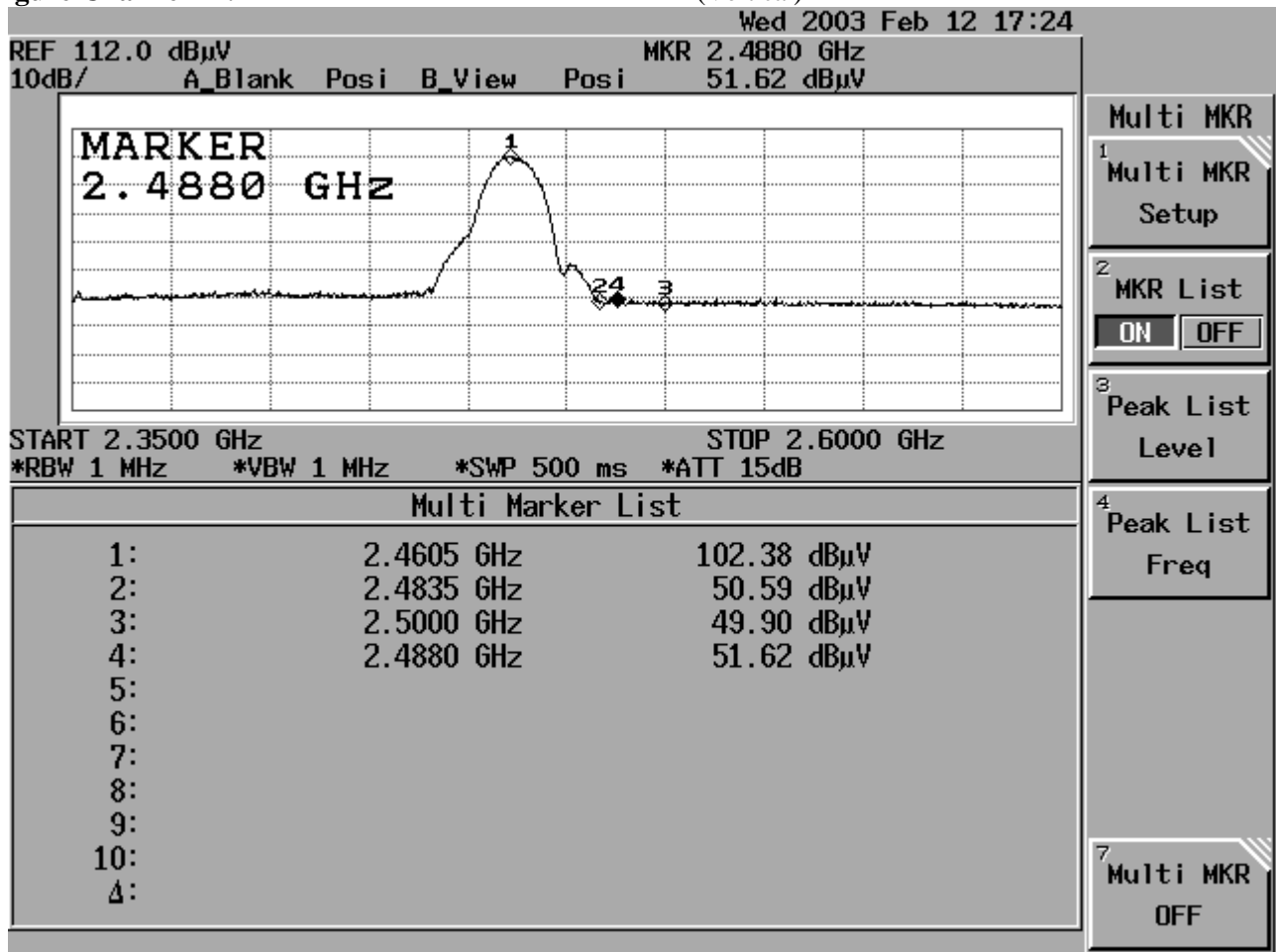

Note: The average measurement was not performed when the peak measured data under the limit of average detection. If the readings given are average, peak measurement should also be supplied.

## 7. Occupied Bandwidth

### 7.1. Test Equipment

The following test equipments are used during the radiated emission tests:

	Equipment	Manufacturer	Model No./Serial No.	Last Cal.
X	Spectrum Analyzer	Advantest	R3272 / 72421194	May, 2002

- Note:
1. All equipment upon which need to calibrated are with calibration period of 1 year.
  2. Mark “X” test instruments are used to measure the final test results.

### 7.2. Test Setup

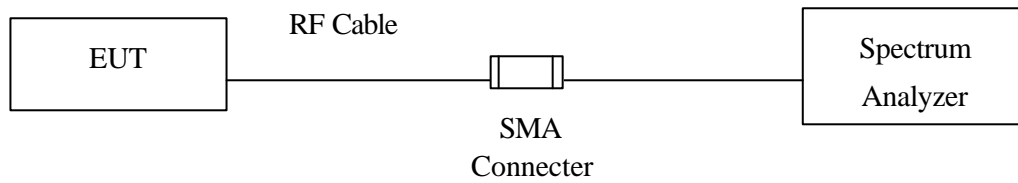

### 7.3. Limits

The minimum 6dB bandwidth shall be at least 500kHz.

### 7.4. Test Result of Occupied Bandwidth

Product : 802.11b WLAN Mini-USB Adaptor  
 Test Item : Occupied Bandwidth  
 Test Site : No.3 OATS  
 Test Mode : Channel 1

Channel No.	Frequency (MHz)	Measurement Level (kHz)	Required Limit (kHz)	Result
1 (1Mbps)	2412.6	10200	>500	Pass

Figure Channel 1: 1Mbps

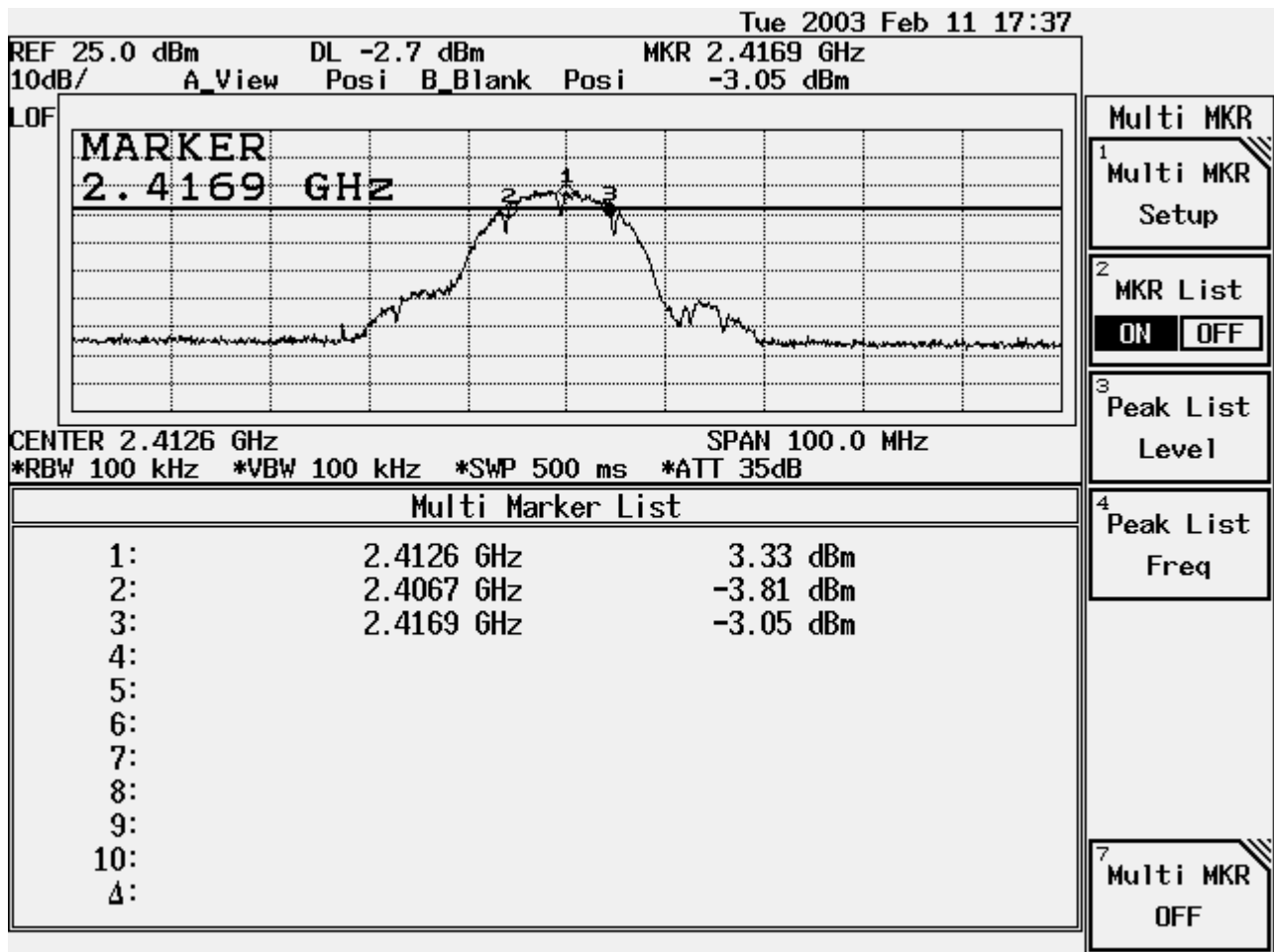

Product : 802.11b WLAN Mini-USB Adaptor  
 Test Item : Occupied Bandwidth  
 Test Site : No.3 OATS  
 Test Mode : Channel 1

Channel No.	Frequency (MHz)	Measurement Level (kHz)	Required Limit (kHz)	Result
1 (11Mbps)	2412.5	10300	>500	Pass

Figure Channel 1: 11Mbps

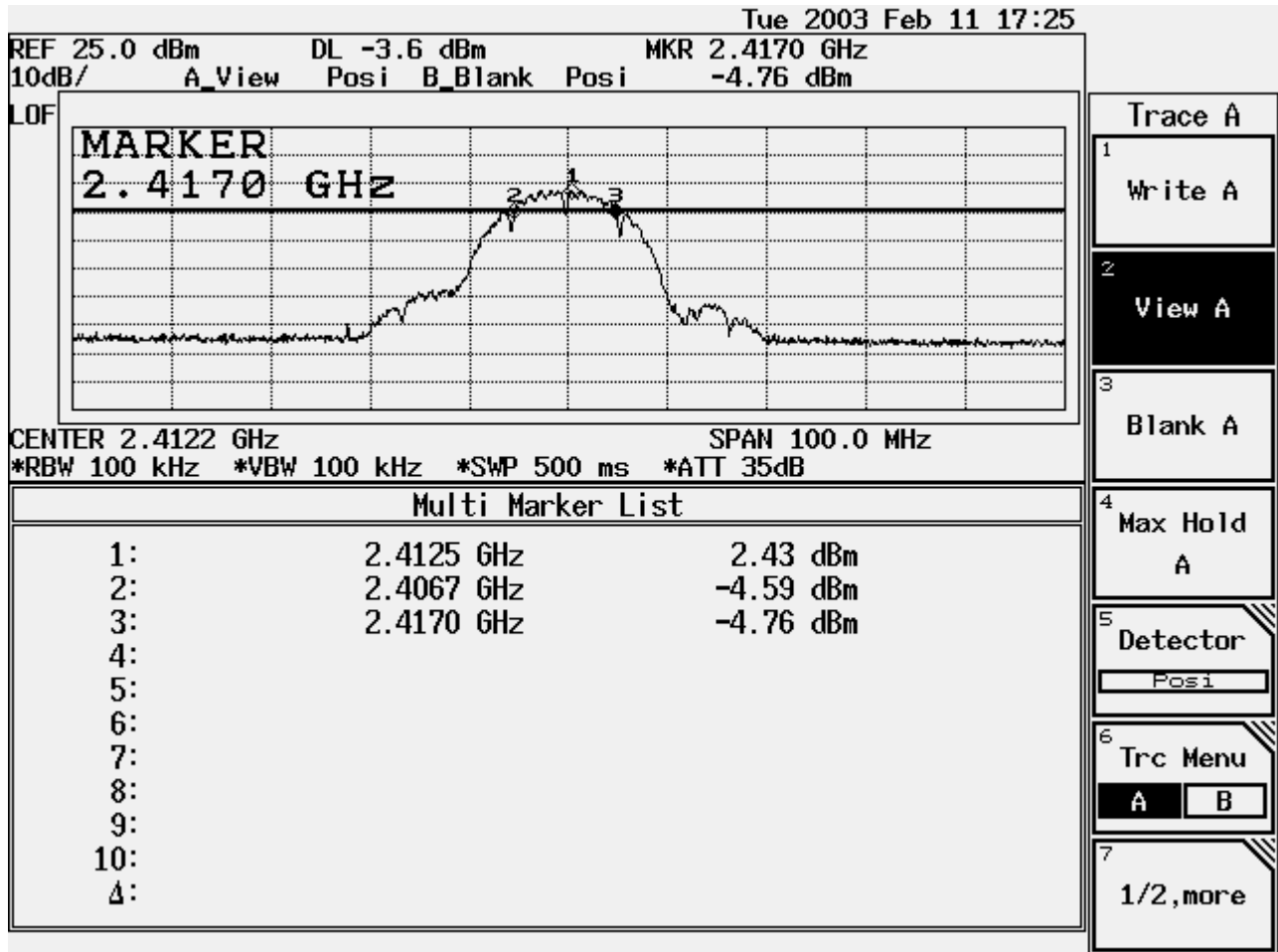

Product : 802.11b WLAN Mini-USB Adaptor  
 Test Item : Occupied Bandwidth  
 Test Site : No.3 OATS  
 Test Mode : Channel 6

Channel No.	Frequency (MHz)	Measurement Level (kHz)	Required Limit (kHz)	Result
6 (1Mbps)	2435.9	10100	>500	Pass

Figure Channel 6: 1Mbps

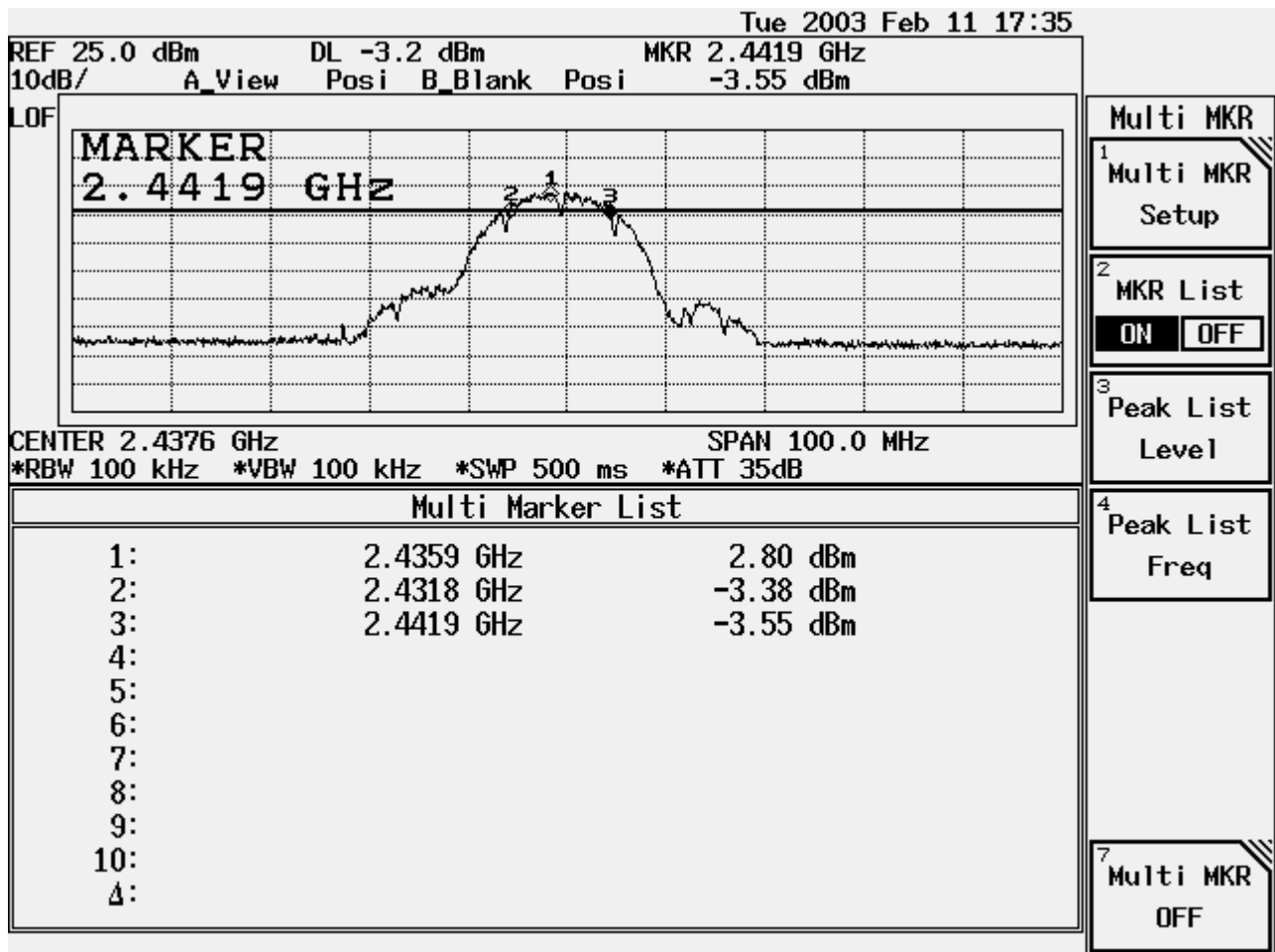

Product : 802.11b WLAN Mini-USB Adaptor  
 Test Item : Occupied Bandwidth  
 Test Site : No.3 OATS  
 Test Mode : Channel 6

Channel No.	Frequency (MHz)	Measurement Level (kHz)	Required Limit (kHz)	Result
6 (11Mbps)	2437.5	10200	>500	Pass

Figure Channel 6: 11Mbps

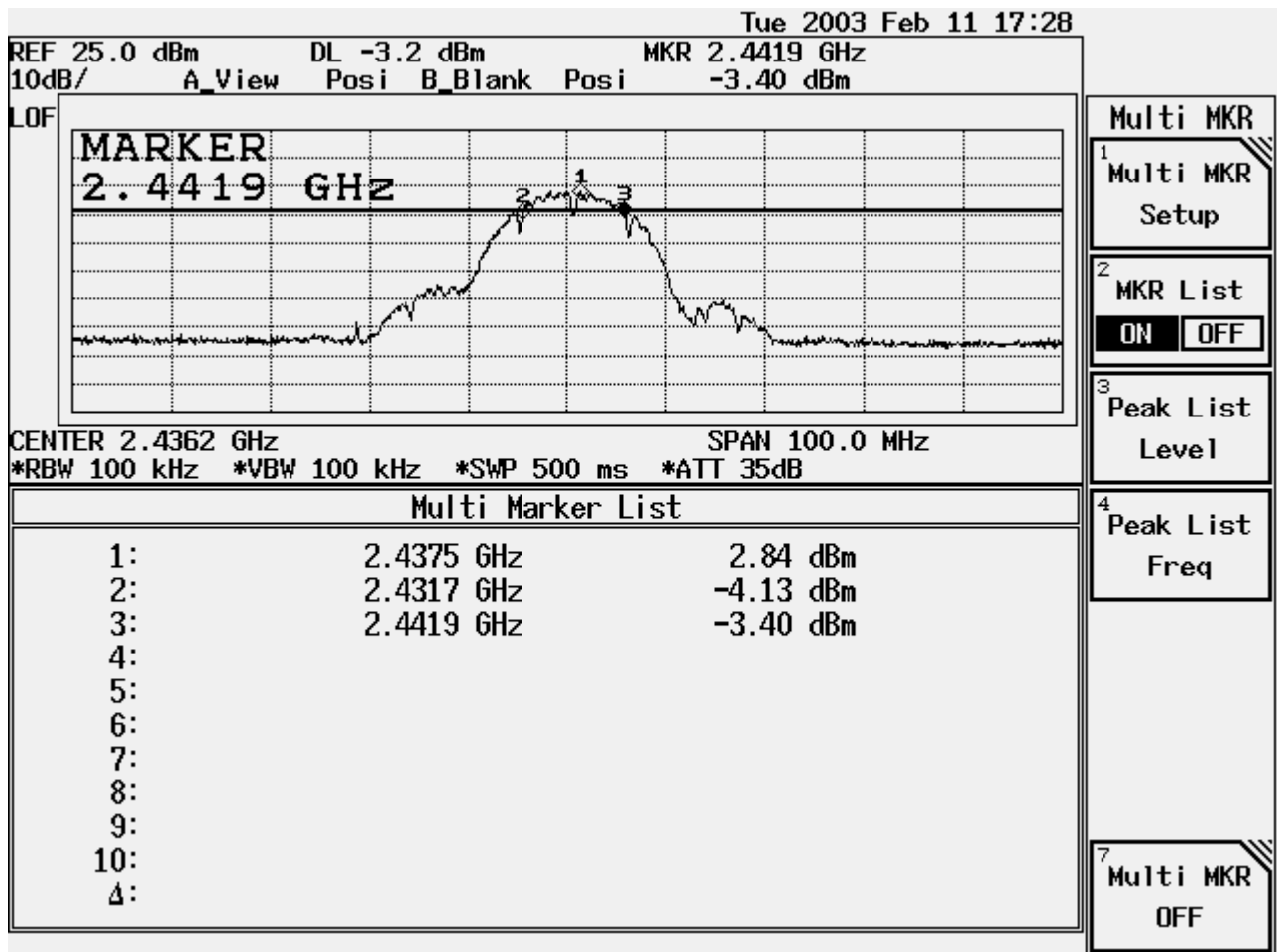



Product : 802.11b WLAN Mini-USB Adaptor  
 Test Item : Occupied Bandwidth  
 Test Site : No.3 OATS  
 Test Mode : Channel 11

Channel No.	Frequency (MHz)	Measurement Level (kHz)	Required Limit (kHz)	Result
11 (1Mbps)	2462.6	10100	>500	Pass

Figure Channel 11: 1Mbps

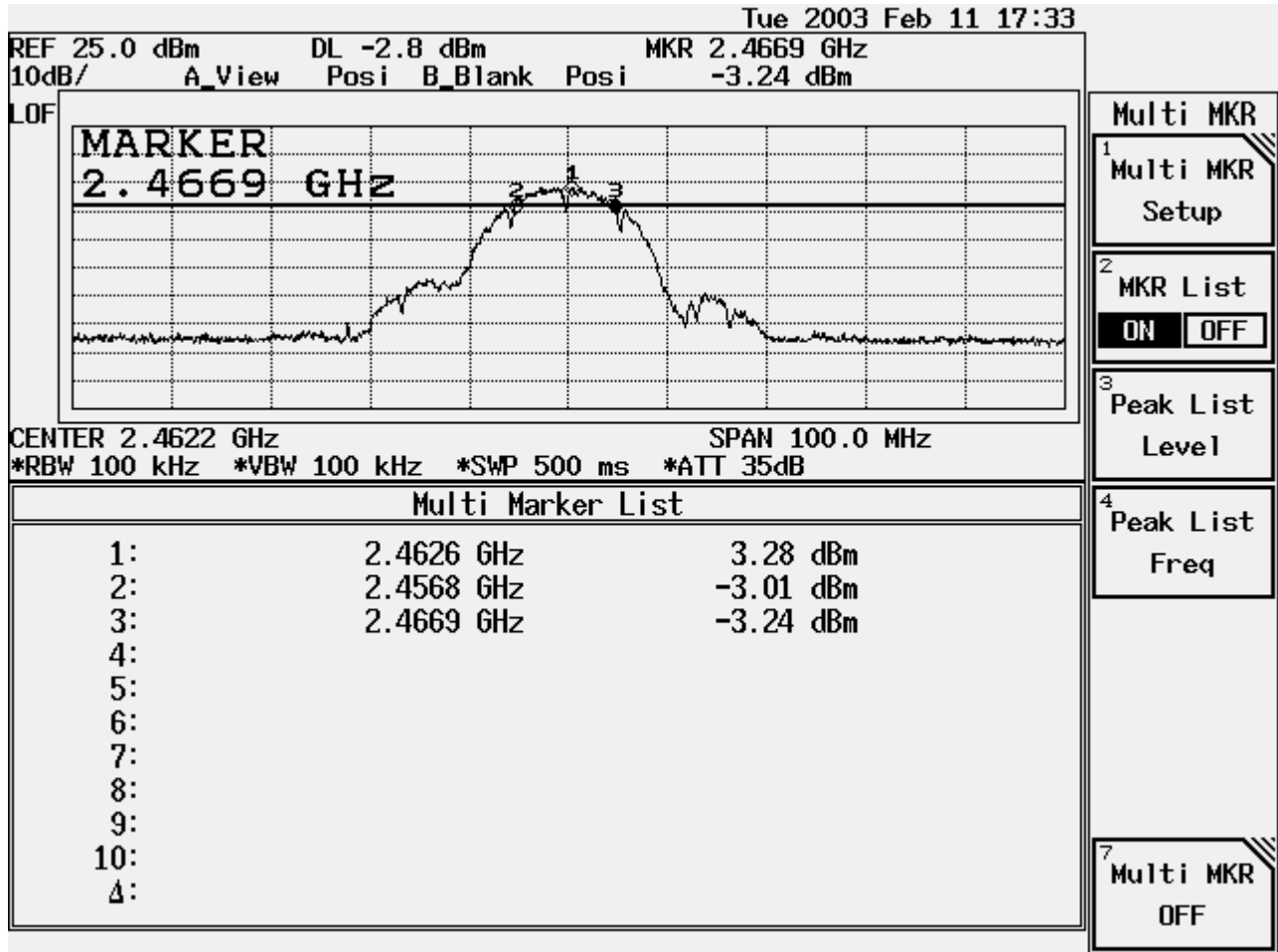

Product : 802.11b WLAN Mini-USB Adaptor  
 Test Item : Occupied Bandwidth  
 Test Site : No.3 OATS  
 Test Mode : Channel 11

Channel No.	Frequency (MHz)	Measurement Level (kHz)	Required Limit (kHz)	Result
11 (11Mbps)	2462.6	10100	>500	Pass

Figure Channel 11: 11Mbps

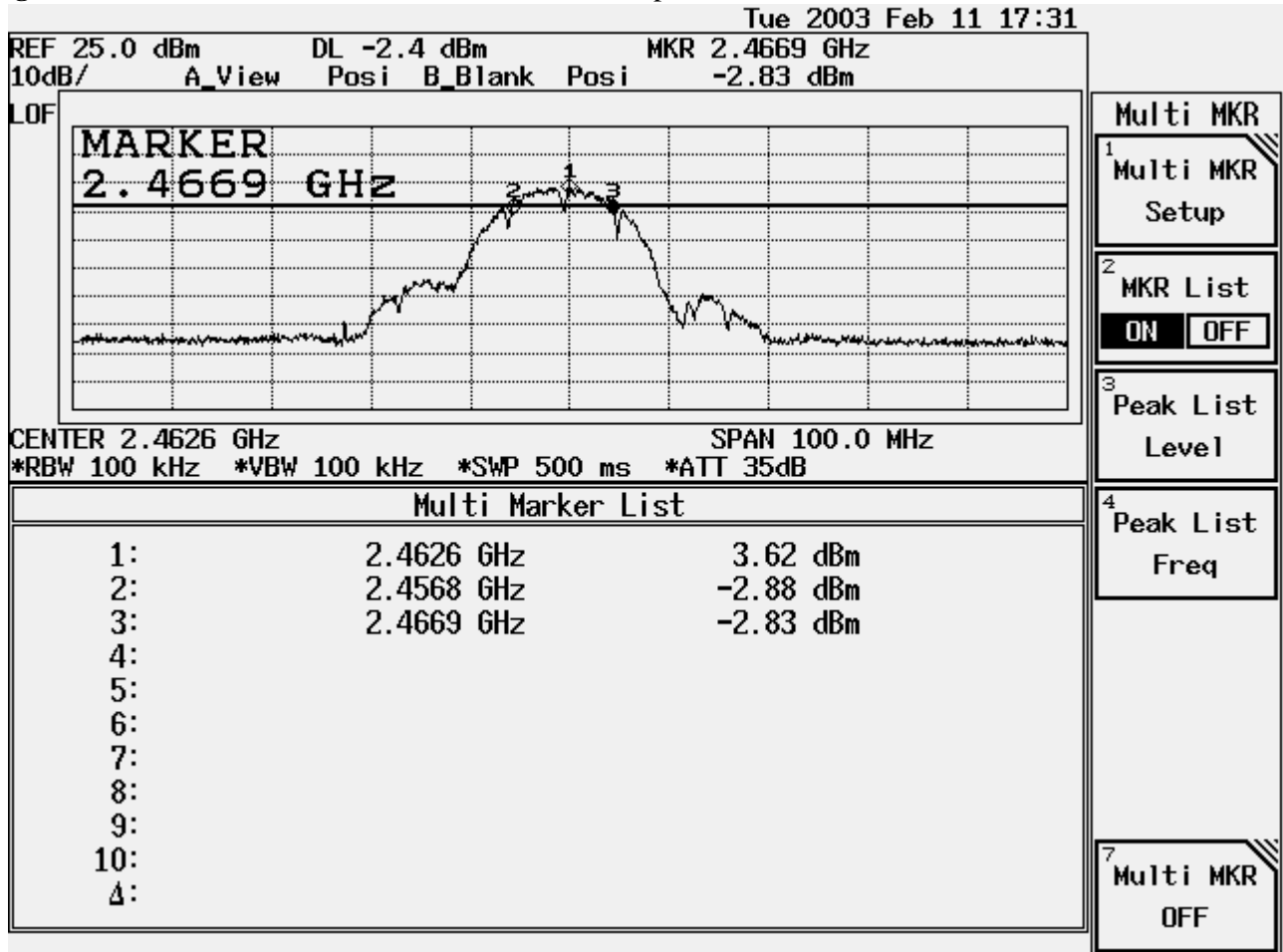

**8. Power Density**

**8.1. Test Equipment**

The following test equipments are used during the radiated emission tests:

	Equipment	Manufacturer	Model No./Serial No.	Last Cal.
X	Spectrum Analyzer	Advantest	R3272 / 72421194	May, 2002

Note: 1. All equipment upon which need to calibrated are with calibration period of 1 year.  
 2. Mark “X” test instruments are used to measure the final test results.

**8.2. Test Setup**

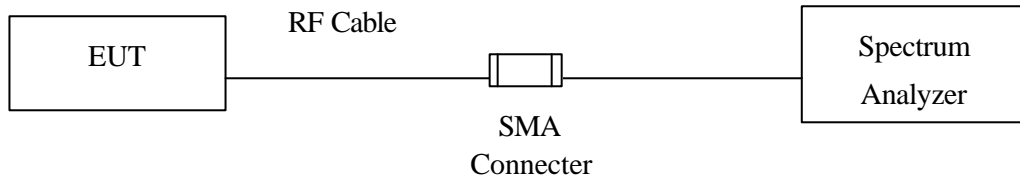

**8.3. Limits**

The transmitted power density averaged over any 1 second interval shall not be greater +8dBm in any 3kHz bandwidth.

### 8.4. Test Result of Power Density

Product : 802.11b WLAN Mini-USB Adaptor  
 Test Item : Power Density  
 Test Site : No.3 OATS  
 Test Mode : Channel 1

Channel No.	Frequency (MHz)	Measurement Level (dBm)	Required Limit (dBm)	Result
1 (1Mbps)	2412.630	-10.94	< 8dBm	Pass

Figure Channel 1:

1Mbps

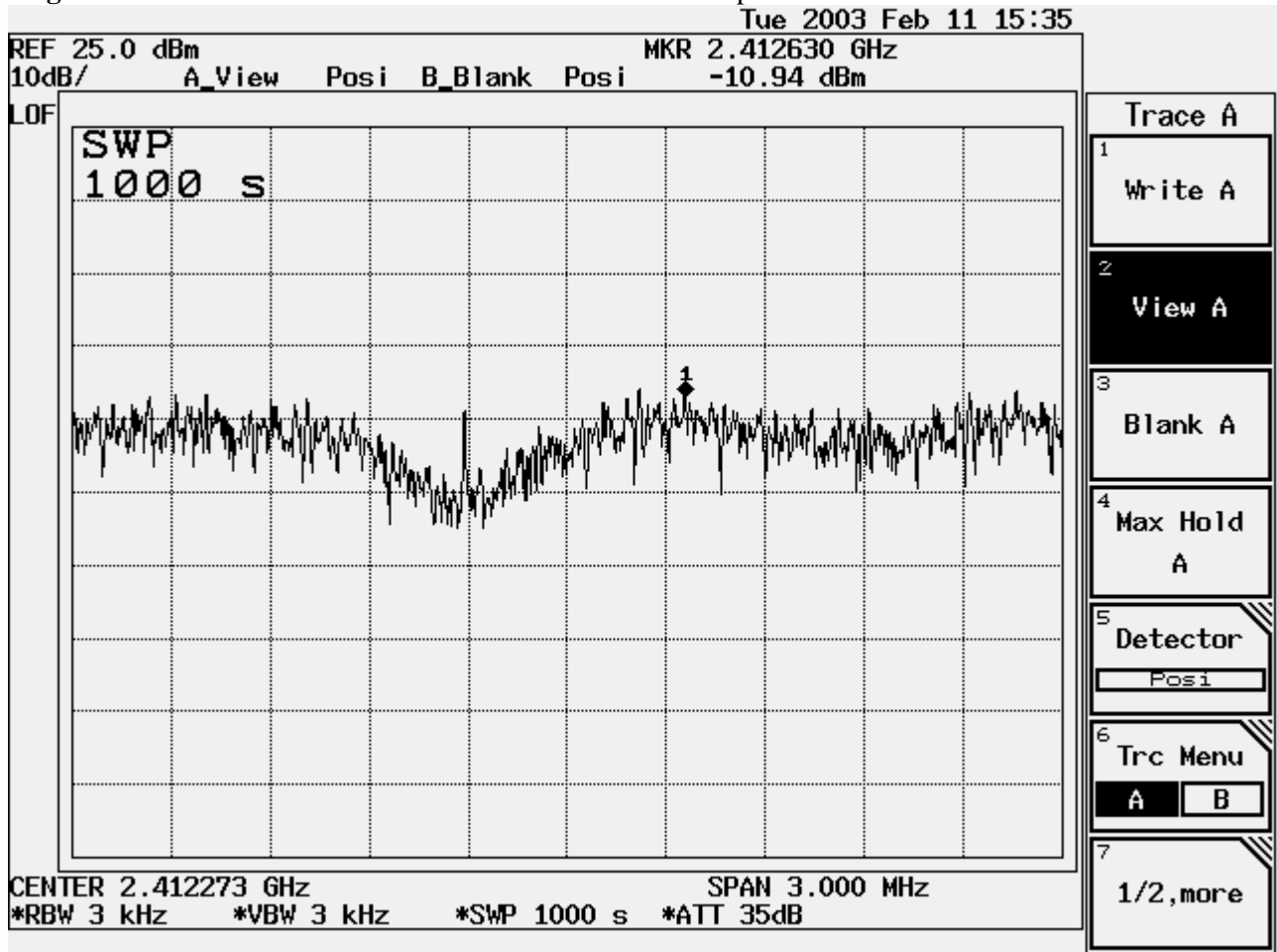

Product : 802.11b WLAN Mini-USB Adaptor  
 Test Item : Power Density  
 Test Site : No.3 OATS  
 Test Mode : Channel 1

Channel No.	Frequency (MHz)	Measurement Level (dBm)	Required Limit (dBm)	Result
1 (11Mbps)	2412.546	-9.71	< 8dBm	Pass

Figure Channel 1:

11Mbps

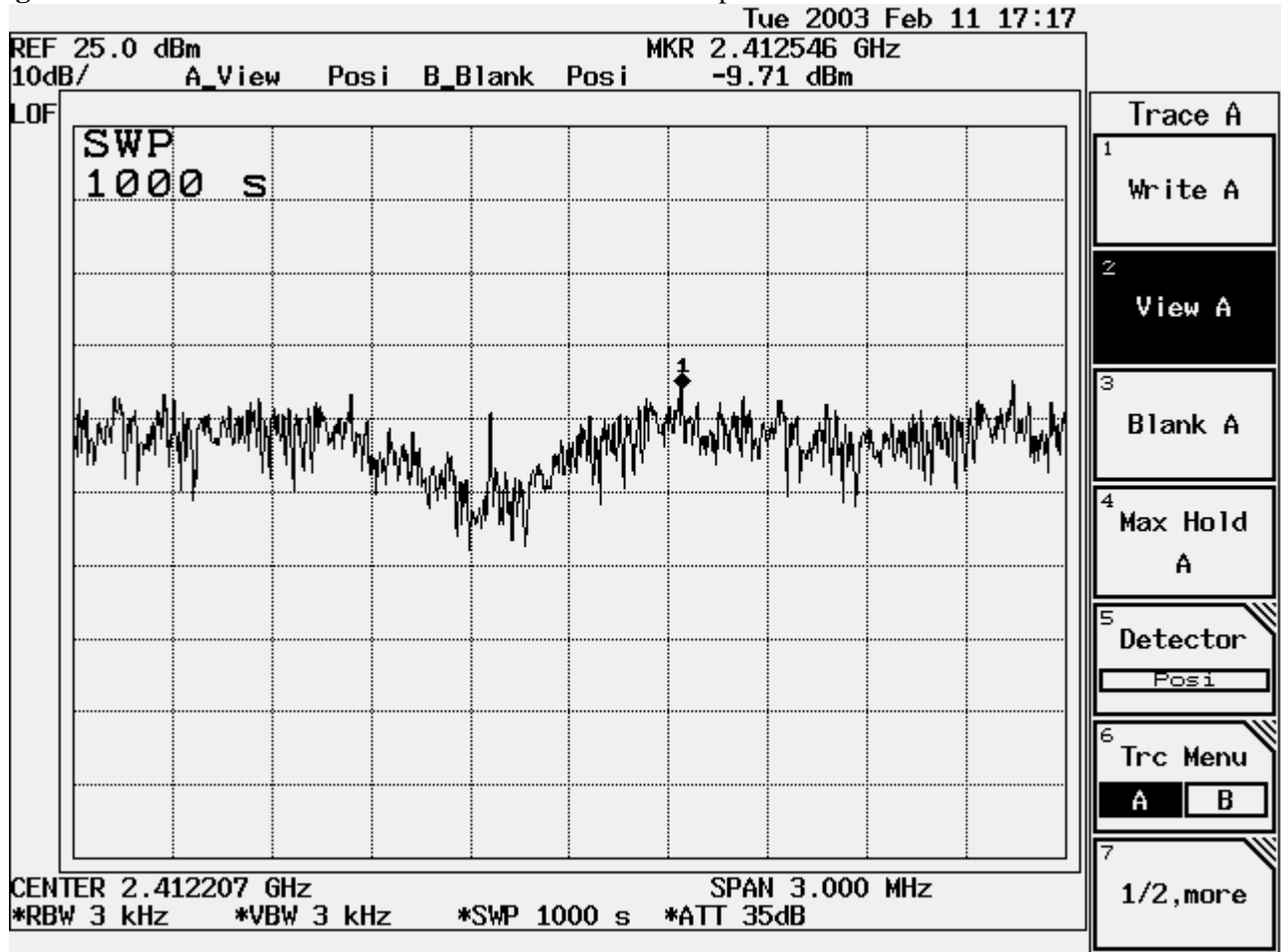

Product : 802.11b WLAN Mini-USB Adaptor  
 Test Item : Power Density  
 Test Site : No.3 OATS  
 Test Mode : Channel 6

Channel No.	Frequency (MHz)	Measurement Level (dBm)	Required Limit (dBm)	Result
6 (1Mbps)	2437.545	-9.80	< 8dBm	Pass

Figure Channel 6: 1Mbps

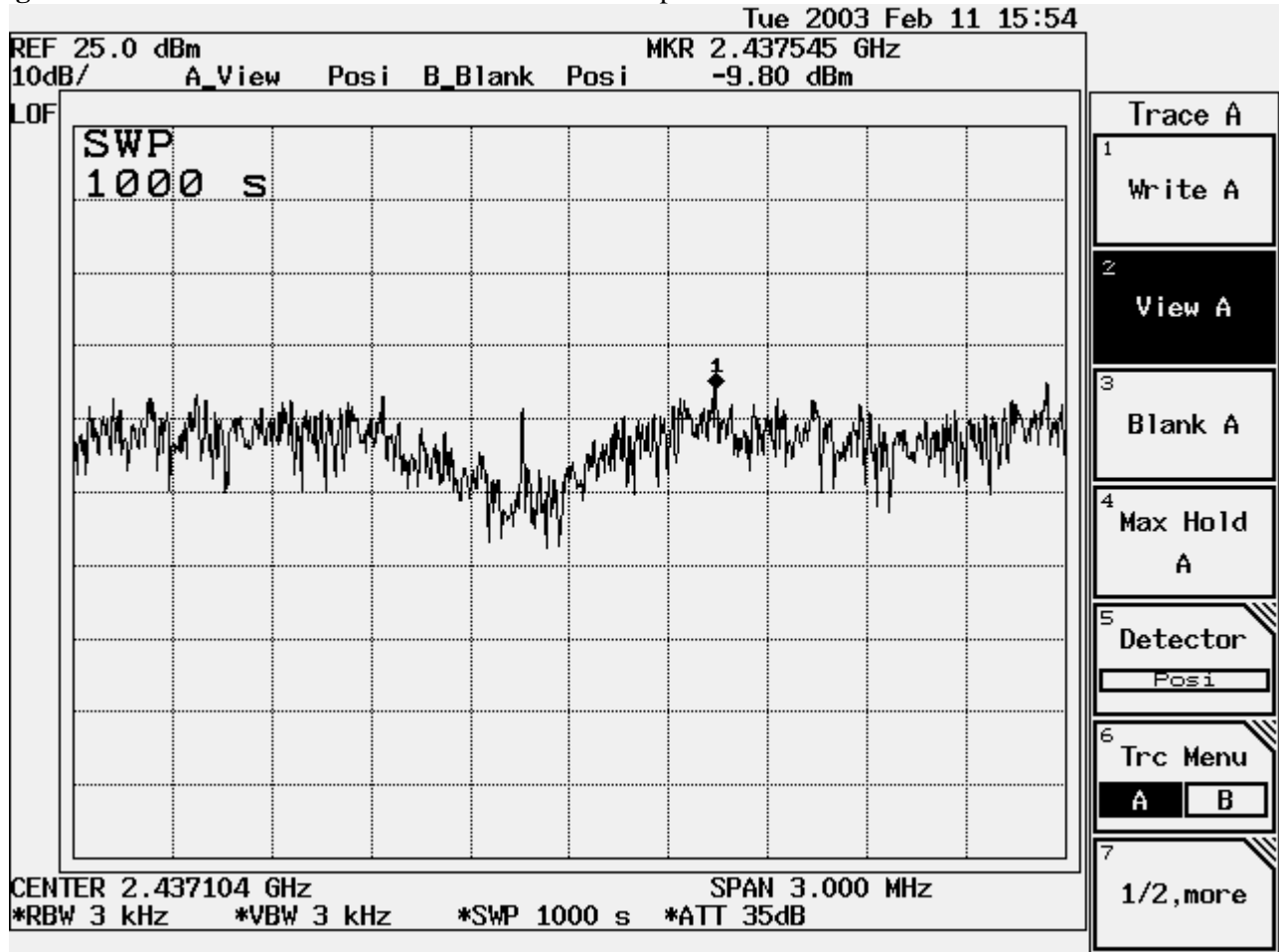

Product : 802.11b WLAN Mini-USB Adaptor  
 Test Item : Power Density  
 Test Site : No.3 OATS  
 Test Mode : Channel 6

Channel No.	Frequency (MHz)	Measurement Level (dBm)	Required Limit (dBm)	Result
6 (11Mbps)	2437.631	-11.48	< 8dBm	Pass

Figure Channel 6: 11Mbps

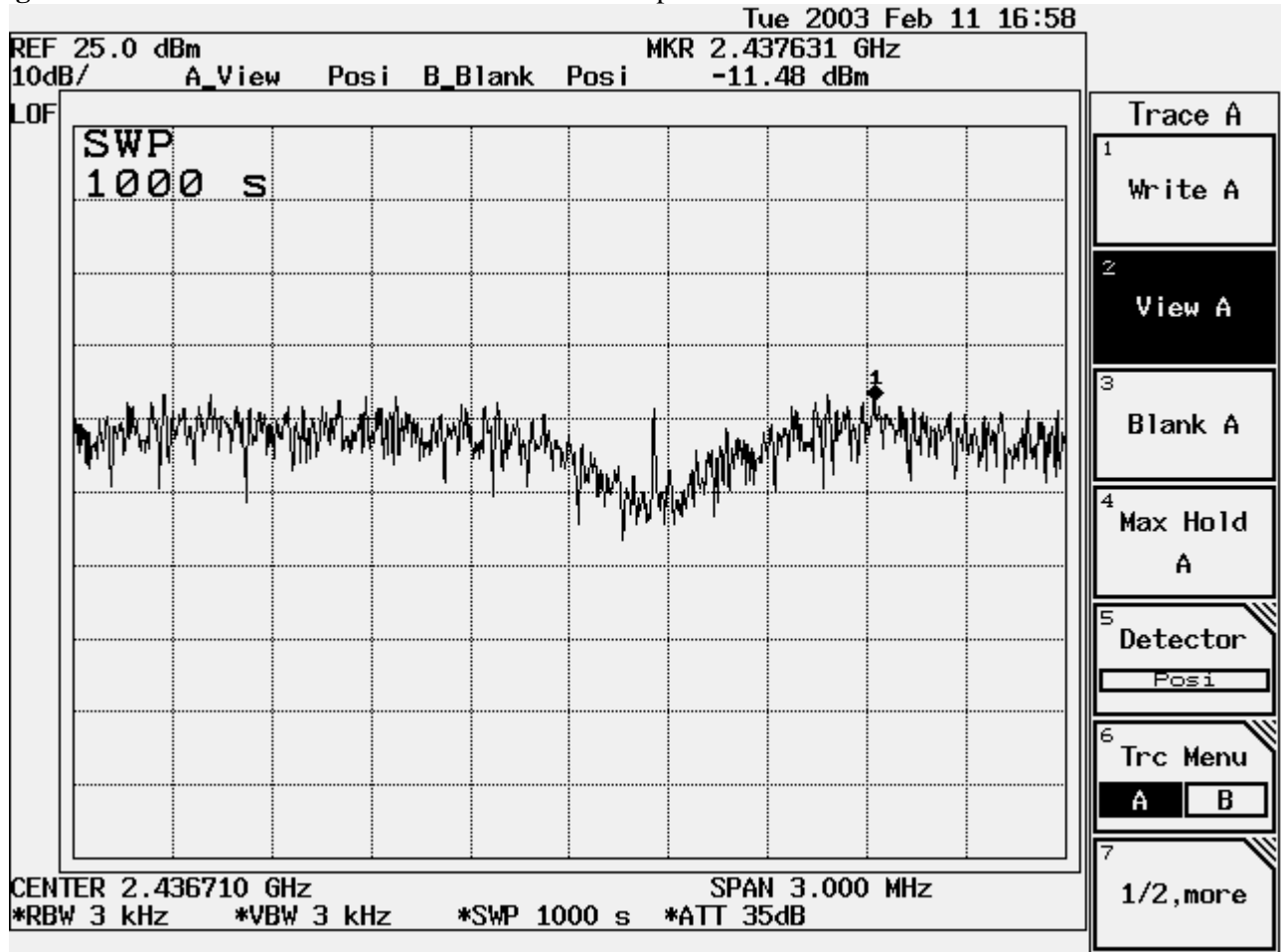

Product : 802.11b WLAN Mini-USB Adaptor  
 Test Item : Power Density  
 Test Site : No.3 OATS  
 Test Mode : Channel 11

Channel No.	Frequency (MHz)	Measurement Level (dBm)	Required Limit (dBm)	Result
11 (1Mbps)	2462.624	-11.05	< 8dBm	Pass

Figure Channel 11: 1Mbps

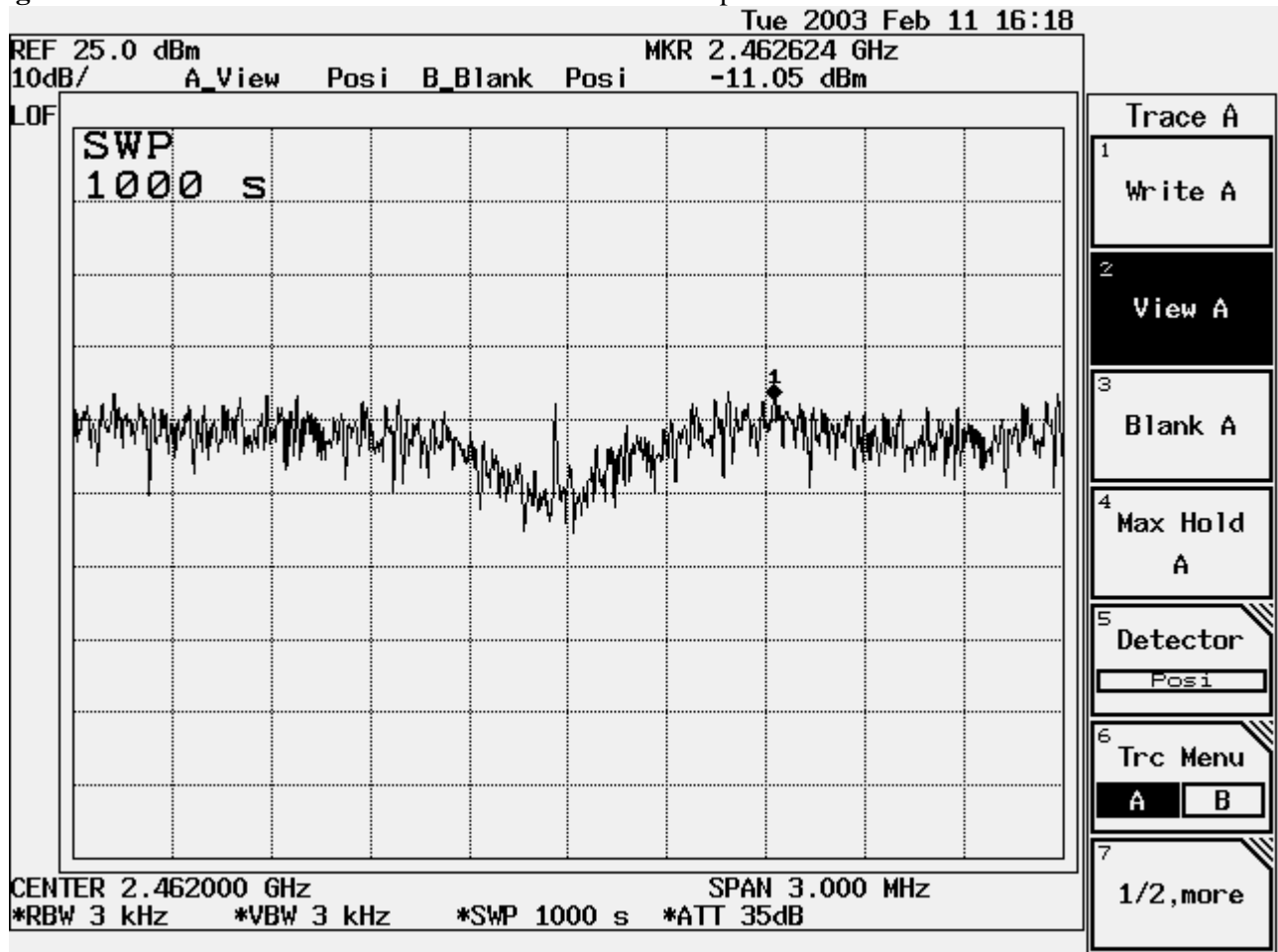



Product : 802.11b WLAN Mini-USB Adaptor  
 Test Item : Power Density  
 Test Site : No.3 OATS  
 Test Mode : Channel 11

Channel No.	Frequency (MHz)	Measurement Level (dBm)	Required Limit (dBm)	Result
11 (11Mbps)	2462.540	-9.42	< 8dBm	Pass

Figure Channel 11:

11Mbps

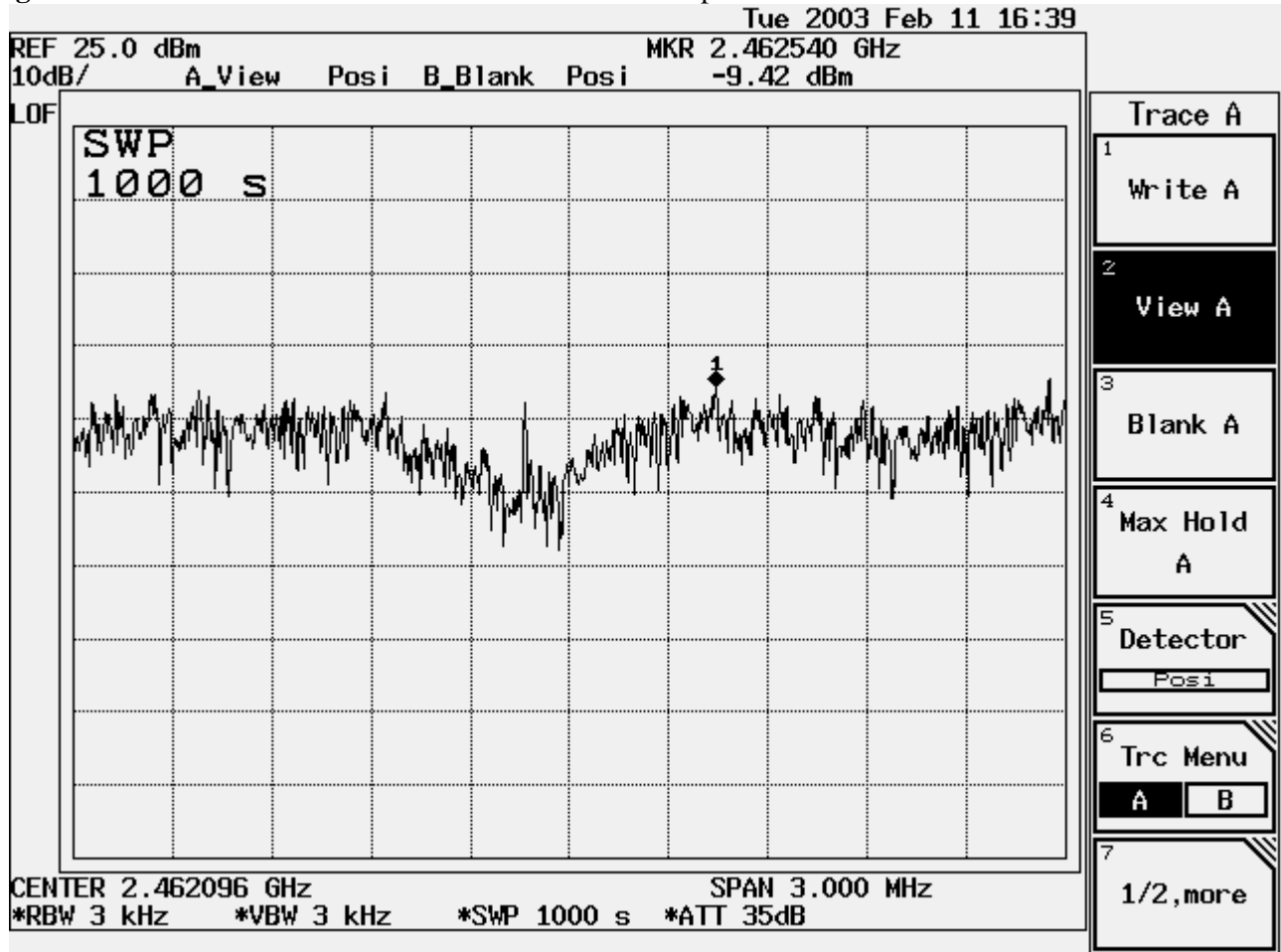

## 9. EMI Reduction Method During Compliance Testing

No modification was made during testing.

## Attachment 1: EUT Test Photographs

## Attachment 2: EUT Detailed Photographs