



TEST REPORT

Product Name : 802.11g WLAN USB Module

Model Number : WM168gi

Brand Name : AirVast

Applicant : AirVast Technology Inc.

Address : 4F, No.1, Ln.21, Hsin Hua Rd., Kueishan Industria Park,
Taoyuan 330, Taiwan, R.O.C.

Received Date : Nov. 27, 2003

Tested Date : Nov. 27~Dec. 24, 2003

Notes :

1. This report will be invalid if duplicated or photocopied in part.
2. This report refers only to the specimen(s) submitted to testing, and be invalid as seperately used.
3. This report is invalid without examination stamp and signature of this institute.
4. The tested specimen(s) will be preserved for thirty days from the data issued.
5. The report must not be used to claim product certification, approval, or endorsement by NVLAP, NIST, or any agency of the federal government.





Ecom Sertech Corp.

Rm. 258, Bldg. 17, NO.195, Sec. 4 Chung Hsing Rd., ChuTung Chen, Hsinchu, Taiwan 310, R.O.C
TEL:886-3-5918012 FAX : 886-3-5825720

FCC ID : QDWWM168GI
Report No. : ER03-11-068FRF
Page 2 of 151

Test Report Certification

Product Name : 802.11g WLAN USB Module
Model Number : WM168gi
Applicant : AirVast Technology Inc.

Measurement Standard :

47 CFR Part 15, Subpart B and Subpart C (Section 15.247),
ANSI C63.4-2001

Tested By :	<u> K. P. Pang </u> (K. P. Pang)	Date:	<u> Dec. 24, 2003 </u>
Reviewed By :	<u> Roger Sheng </u> (Roger Sheng)	Date:	<u> Dec. 24, 2003 </u>
Approved By :	<u> Chieh-De Tsai </u> (Chieh-De Tsai, Manager)	Date:	<u> Dec. 24, 2003 </u>

WE HEREBY CERTIFY THAT: The measurements shown in the attachment were made in accordance with the procedures indicated, and the energy emitted by the equipment was found to be within the limits applicable. We assume full responsibility for the accuracy and completeness of these measurements and vouch for the qualifications of all persons taking them.



TABLE OF CONTENTS

TITLE	PAGE NO.
1. GENERAL INFORMATION	5
1.1 General Statement.....	5
1.2 General Description of EUT & Power.....	5
1.3 Description of Peripherals	6
1.4 EUT & Peripherals Setup Diagram	7
1.5 EUT Operating Condition	7
1.6 Description of Test Site	8
1.7 Summary of Test Results.....	8
2. CONDUCTED POWERLINE TEST	9
2.1 Test Equipments	9
2.2 Test Setup	9
2.3 Conducted Power Line Emission Limit.....	10
2.4 Test Procedure	10
2.5 Uncertainty of Conducted Emission.....	10
2.6 Conducted RF Voltage Measurement.....	11-12
2.7 Photos of Conduction Test	13
3. RADIATED EMISSION TEST	14
3.1 Test Equipments	14
3.2 Test Setup	14
3.3 Radiation Limit.....	15
3.4 Test Procedures.....	16
3.5 Uncertainty of Radiated Emission.....	16
3.6 Radiated RF Noise Measurement	17-120
3.7 Photos of Open Site	121-122
4. 6dB BANDWIDTH MEASUREMENT	123
4.1 Test Equipments	123
4.2 Test Setup	123
4.3 Limits of 6dB Bandwidth Measurement.....	123
4.4 Test Procedure	123
4.5 Uncertainty of Conducted Emission.....	123
4.6 Test Results.....	124
4.7 Photo of 6db Bandwidth Measurement	125-126
5. MAXIMUM PEAK OUTPUT POWER.....	127
5.1 Test Equipments	127
5.2 Test Setup	127
5.3 Limits of Maximum Peak Output Power.....	127
5.4 Test Procedure	128
5.5 Uncertainty of Conducted Emission.....	128
5.6 Test Results.....	128



TABLE OF CONTENTS

TITLE	PAGE NO.
6. POWER SPECTRAL DENSITY MEASUREMENT	129
6.1 Test Equipments	129
6.2 Test Setup	129
6.3 Limits of Power Spectral Density Measurement	129
6.4 Test Procedure	130
6.5 Uncertainty of Conducted Emission	130
6.6 Test Results	130
6.7 Photo of Power Spectral Density Measurement	131-132
7. BANDEDGE MEASUREMENT	133
7.1 Test Equipments	133
7.2 Test Setup	133
7.3 Limits of Out of Band Emissions Measurement	133
7.4 Test Procedure	134
7.5 Uncertainty of Conducted Emission	134
7.6 Test Results	134-141
7.7 Photo of Out of Bandedge Measurement	142-145
8. ANTENNA REQUIREMENT	146
8.1 Standard Applicable	146
8.2 Antenna Connected Construction	146
9. RF EXPOSURE EVALUATION	147
9.1 Friis Formula	147
9.2 EUT Operating Condition	147
9.3 Test Result of RF Exposure Evaluation	148
9.3.1 Antenna Gain	148
9.3.2 Output Power into Antenna & RF Exposure Evaluation Distance	148-151



1. GENERAL INFORMATION

1.1 General Statement

MEASUREMENT DEVIATION : Comply with standard in full

TRACEABILITY : This test result is traceable to national or international std.

1.2 General Description of EUT & Power

MANUFACTURER : AirVast Technology Inc.

SAMPLE NAME : 802.11g WLAN USB Module

MODEL NAME : WM168gi

FREQUENCY RANGE : 2412 MHz to 2462MHz

CHANNEL NUMBER : 11

AIR DATA RATE : 54Mbps (802.11g Mode), 11Mbps(802.11b Mode)

TYPE OF MODULATION : 2.4GHz (Orthogonal Frequency Division Multiplex and Direct Sequence Spread Spectrum) data transceiver for 802.11g WLAN USB Module

FREQUENCY SELECTION : BY SOFTWARE

ANTENNA TYPE : A pair of PIFA Antennae

Each of the Antennae can not be used individually.

Note : The 802.11g WLAN USB Module could use 4 pairs of Antennae.

Antenna 1(A530A531) : Antenna gain is 0.43dBi.

Antenna 2(A535) : Antenna gain is -0.19dBi.

Antenna 3(A800) : Antenna gain is 1.334dBi.

Antenna 4(G736) : Antenna gain is 2.03dBi.

POWER SOURCE : 3.3VDC (From Notebook PC)



Ecom Sertech Corp.

Rm. 258, Bldg. 17, NO.195, Sec. 4 Chung Hsing Rd., ChuTung Chen, Hsinchu, Taiwan 310, R.O.C
TEL:886-3-5918012 FAX: 886-3-5825720

FCC ID : QDWWM168GI
Report No. : ER03-11-068FRF
Page 6 of 151

1.3 Description of Peripherals

(1) Notebook PC

MANUFACTURER : COMPAQ CORP.
MODEL NUMBER : N800V
SERIAL NUMBER : 5Y33KSQZMOYL
FCC : DOC
POWER CORD : Unshielded, Detachable, 1.8m

(2) Printer

MANUFACTURER : HP CORP.
MODEL NUMBER : C6431D
SERIAL NUMBER : CN19T6S011
FCC ID : DOC
POWER SOURCE : 100-240VAC,50/60Hz,0.7A
SIGNAL CABLE : Shielded , Undetachable , 1.8m

(3) Modem

MANUFACTURER : ZYXEL communication Corp.
MODEL NUMBER : Omni 56K
SERIAL NUMBER : S1Z4107729
FCC ID : 1880MN156K
POWER SOURCE : 9VAC(From Power Adapter)
SIGNAL CABLE : Shielded , Undetachable , 1.8m

(4) Notebook PC

MANUFACTURER : COMPAQ CORP.
MODEL NUMBER : N800V
SERIAL NUMBER : 5Y3EKSQZD1TJ
FCC : DOC
POWER CORD : Unshielded, Detachable, 1.8m

1.4 EUT & Peripherals Setup Diagram

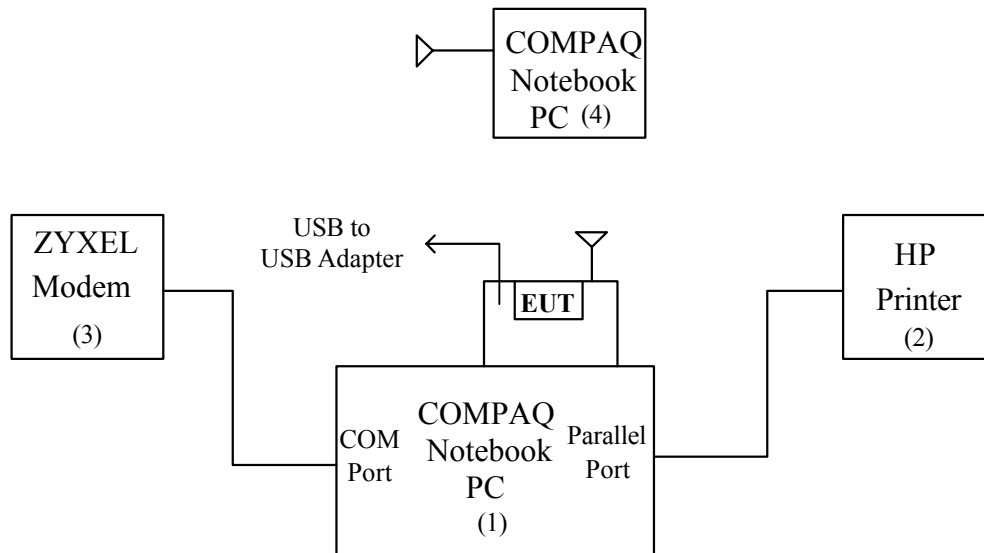

1.5 EUT Operating Condition

1. Set up all computers like the setup diagram.
2. Notebook PC (1) ping 192.168.1.90 -t -l 5000 to EUT.
3. Notebook PC (1) ping 192.168.1.80 -t -l 5000 to Notebook (4).
4. All of the function are under run.
5. Start test.



Ecom Sertech Corp.

Rm. 258, Bldg. 17, NO.195, Sec. 4 Chung Hsing Rd., ChuTung Chen, Hsinchu, Taiwan 310, R.O.C
TEL:886-3-5918012 FAX : 886-3-5825720

FCC ID : QDWWM168GI
Report No. : ER03-11-068FRF
Page 8 of 151

1.6 Description of Test Site

SITE DESCRIPTION : FCC Certificate NO. : 90585
 BSMI Certificate NO. : SL2-IN-E-0002
 NVLAP Lab code : 200118-0
 CNLA Certificate NO. : CNLA-ZL97018
 VCCI Certificate NO. : R-1229, C-1250

NAME OF SITE : Ecom Sertech Corp. Hsinchu
 (Spin-off from ITRI / ERSO on Apr. 01, 2003)

SITE LOCATION : Rm.258, Bldg.17, NO.195 , Sec. 4, Chung Hsing Rd.,
 Chu-Tung Chen. Hsin-Chu, Taiwan 310 R.O.C.

1.7 Summary of Test Results

The EUT has been tested according to the following specifications :

APPLIED STANDARD : 47 CFR Part 15, Subpart B and Subpart C			
Standard Section	Test Type and Limit	Result	REMARK
15.107 15.207	AC Power Conducted Emission Limit : 15.107	PASS	Meet the requirement of limit
15.247(a)(2)	Spectrum Bandwidth of a Orthogonal Frequency Division Multiplex System Limit : 6dB bandwidth > 500KHz	PASS	Meet the requirement of limit
15.247(b)	Maximum Peak Output Power Limit : max. 30dBm	PASS	Meet the requirement of limit
15.109 15.205 15.209	Transmitter Radiated Emissions Limit : Table 15.209	PASS	Meet the requirement of limit
15.247(d)	Power Spectral Density Limit : max. 8dBm	PASS	Meet the requirement of limit
15.247(c)	Out of Band Emission and Restricted Band Radiation Limit:20dB less than peak value of fundamental frequency Restricted band Limit:Table 15.209	PASS	Meet the requirement of limit



2. CONDUCTED POWERLINE TEST

2.1 Test Equipments

The following test equipments are used during the conducted powerline tests :

Manufacturer or Type	Model No	Serial No.	Date of Calibration	Calibration Period	Remark
SPECTRUM ANALYZER & DISPLAY	HP 8568A	2235A02320	APR. 01, 2003	1 Year	PRETEST
QUASI-PEAK ADAPTER	HP 85650 A	2341A00672	APR. 01, 2003	1 Year	PRETEST
ISOLATION TRANSFORMER	SOLAR 7032-1	N/A	N/A	N/A	FINAL
L.I.S.N.	EMCO 3850/2	9311-1025 9401-1028	JAN. 08, 2003 For Characteristic impedance MAY 18, 2003 For Insertion loss	1 Year	FINAL
TEST RECEIVER	R/S ESHS30	838550/003	JUN. 07, 2003	1 Year	FINAL
SHIELDED ROOM	KEENE 5983	NO.1	N/A	N/A	FINAL
PULSE LIMIT	R/S EHS3Z2	357.8810.52	JUL. 10, 2003	1 Year	FINAL
N TYPE COAXIAL CABLE	-----	-----	JUL. 10, 2003	1 Year	FINAL
50Ω TERMINATOR	-----	-----	JUL. 10, 2003	1 Year	FINAL

2.2 Test Setup

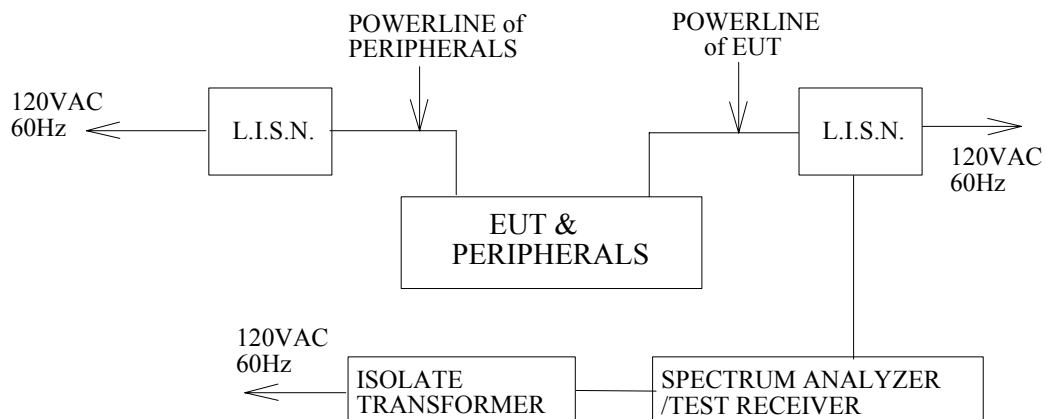



2.3 Conducted Power Line Emission Limit

For unintentional device, according to § 15.107(a) Line Conducted Emission Limits is as following :

Frequency (MHz)	Maximum RF Line Voltage (Db μ v)			
	CLASS A		CLASS B	
	Q.P.	Ave.	Q.P.	Ave.
0.15 - 0.50	79	66	66-56	56-46
0.50 - 5.00	73	60	56	46
5.00 - 30.0	73	60	60	50

For intentional device, according to § 15.207(a) Line Conducted Emission Limit is same as above table.

2.4 Test Procedure

The test procedure is performed in a 12ft×12ft×8ft(L×W×H) shielded room. the EUT along with its peripherals were placed on a 1.0m(W)×1.5m(L) and 0.8m in height wooden table and the EUT was adjusted to maintain a 0.4 meter space from a vertical reference plane. The EUT was connected to power mains through a line impedance stabilization network (LISN) which provides 50 ohm coupling impedance for measuring instrument and the chasis ground was bounded to the horizontal ground plane of shielded room. All peripherals were connected to the second LISN and the chasis ground also bounded to the horizontal ground plane of shielded room. The excess power cable between the EUT and the LISN was bundled. The power cables of peripherals were unbundled. All connecting cables of EUT and peripherals were moved to find the maximum emission.

2.5 Uncertainty of Conducted Emission

The uncertainty of conducted emission is ±1.36dB.



2.6 Conducted RF Voltage Measurement

The frequency spectrum from 0.15 MHz to 30 MHz was investigated. All emissions not reported below are more than 40 dB below the prescribed limits.

Temperature : 26 °C

Humidity : 65 % RH

Frequency (MHz)	Loss(dB)		Measurement				L1 Emission (dBμV)		L2 Emission (dBμV)		Limits (dBμV)	
			L1(dBμV)		L2(dBμV)		Q.P.	A.V.	Q.P.	A.V.	Q.P.	A.V.
	L1	L2	Q.P.	A.V.	Q.P.	A.V.						
0.150	0.10	0.20	*	*	*	*	*	*	*	66.00	56.00	
0.198	0.10	0.20	*	*	49.00	*	*	*	49.20	63.69	53.69	
0.264	0.10	0.20	47.30	*	*	*	47.40	*	*	61.30	51.30	
0.396	0.10	0.20	43.40	*	43.50	*	43.50	*	43.70	57.94	47.94	
0.520	0.10	0.20	*	*	37.50	*	*	*	37.70	56.00	46.00	
0.530	0.10	0.20	38.10	*	*	*	38.20	*	*	56.00	46.00	
1.180	0.10	0.20	27.30	*	*	*	27.40	*	*	56.00	46.00	
1.380	0.10	0.20	*	*	27.70	*	*	*	27.90	56.00	46.00	
4.010	0.20	0.20	32.20	*	31.60	*	32.40	*	31.80	56.00	46.00	
4.340	0.20	0.20	*	*	31.80	*	*	*	32.00	56.00	46.00	
4.470	0.20	0.20	31.60	*	*	*	31.80	*	*	56.00	46.00	
13.550	0.50	0.56	*	*	36.50	*	*	*	37.06	60.00	50.00	
14.850	0.59	0.60	36.00	*	*	*	36.59	*	*	60.00	50.00	
16.700	0.70	0.70	*	*	36.00	*	*	*	36.70	60.00	50.00	
16.800	0.70	0.70	34.50	*	*	*	35.20	*	*	60.00	50.00	
30.000	1.40	1.80	*	*	*	*	*	*	*	60.00	50.00	

- REMARKS : 1. * Undetectable or the Q.P. value is lower than the limits of Ave.
 2. Mode : 802.11b mode.
 3. The EUT can be operated in transmitting, stand-by and receiving mode.
 After preliminary scan, EUT in transmitting mode has highest emission.
 The EUT was set in transmitting mode at final test to get the worst case test results.



Ecom Sertech Corp.

Rm. 258, Bldg. 17, NO.195, Sec. 4 Chung Hsing Rd., ChuTung Chen, Hsinchu, Taiwan 310, R.O.C
 TEL:886-3-5918012 FAX : 886-3-5825720

FCC ID : QDWWM168GI
 Report No. : ER03-11-068FRF
 Page 12 of 151

The frequency spectrum from 0.15 MHz to 30 MHz was investigated. All emissions not reported below are more than 40 dB below the prescribed limits.

Temperature : 26 °C

Humidity : 65 % RH

Frequency (MHz)	Loss(dB)		Measurement				L1 Emission (dBµV)		L2 Emission (dBµV)		Limits (dBµV)	
			L1(dBµV)		L2(dBµV)		Q.P.	A.V.	Q.P.	A.V.	Q.P.	A.V.
	L1	L2	Q.P.	A.V.	Q.P.	A.V.						
0.150	0.10	0.20	*	*	*	*	*	*	*	*	66.00	56.00
0.168	0.10	0.20	51.60	*	*	*	51.70	*	*	*	65.06	55.06
0.174	0.10	0.20	*	*	52.80	*	*	*	53.00	*	64.77	54.77
0.345	0.10	0.20	38.20	*	37.30	*	38.30	*	37.50	*	59.08	49.08
0.520	0.10	0.20	*	*	26.30	*	*	*	26.50	*	56.00	46.00
0.570	0.10	0.20	22.60	*	*	*	22.70	*	*	*	56.00	46.00
1.850	0.10	0.20	*	*	19.40	*	*	*	19.60	*	56.00	46.00
2.010	0.10	0.20	17.90	*	*	*	18.00	*	*	*	56.00	46.00
3.120	0.20	0.20	*	*	24.60	*	*	*	24.80	*	56.00	46.00
3.790	0.20	0.20	31.00	*	*	*	31.20	*	*	*	56.00	46.00
4.360	0.20	0.20	18.70	*	*	*	18.90	*	*	*	56.00	46.00
4.850	0.20	0.20	*	*	22.80	*	*	*	23.00	*	56.00	46.00
13.050	0.50	0.51	*	*	31.80	*	*	*	32.31	*	60.00	50.00
13.600	0.50	0.56	29.60	*	*	*	30.10	*	*	*	60.00	50.00
16.000	0.70	0.70	*	*	31.00	*	*	*	31.70	*	60.00	50.00
16.400	0.70	0.70	33.20	*	*	*	33.90	*	*	*	60.00	50.00
30.000	1.40	1.80	*	*	*	*	*	*	*	*	60.00	50.00

REMARKS : 1. * Undetectable or the Q.P. value is lower than the limits of Ave.

2. Mode : 802.11g mode.

3. The EUT can be operated in transmitting, stand-by and receiving mode.

After preliminary scan, EUT in transmitting mode has highest emission.

The EUT was set in transmitting mode at final test to get the worst case test results.

2.7 Photos of Conduction Test



3. RADIATED EMISSION TEST

3.1 Test Equipments

The following test equipments are utilized in making the measurements contained in this report.

Manufacturer or Type	Model No	Serial No	Date of Calibration	Calibration Period	Remark
CHASE BI-LOG ANTENNA	CBL6112B	2421	MAY 07, 2003	1 Year	FINAL
OPEN SITE	-----	No.2	JAN. 10, 2003	1 Year	FINAL
N TYPE COAXIAL CABLE	CHA9525	4	JUL. 13, 2003	1 Year	FINAL
Horn Antenna	AH-118	10089	FEB. 25, 2003	1 Year	FINAL
HP Pre-amplifier	8449B	3008A01471	OCT. 11, 2003	1 Year	FINAL
HP High pass filter	84300/80038	011	cal. on use	1 Year	FINAL
Horn Antenna	AH-840	03077	FEB. 25, 2003	1 Year	FINAL

3.2 Test Setup

The diagram below shows the test setup that is utilized to make the measurements for emission from 30 to 1GHz.

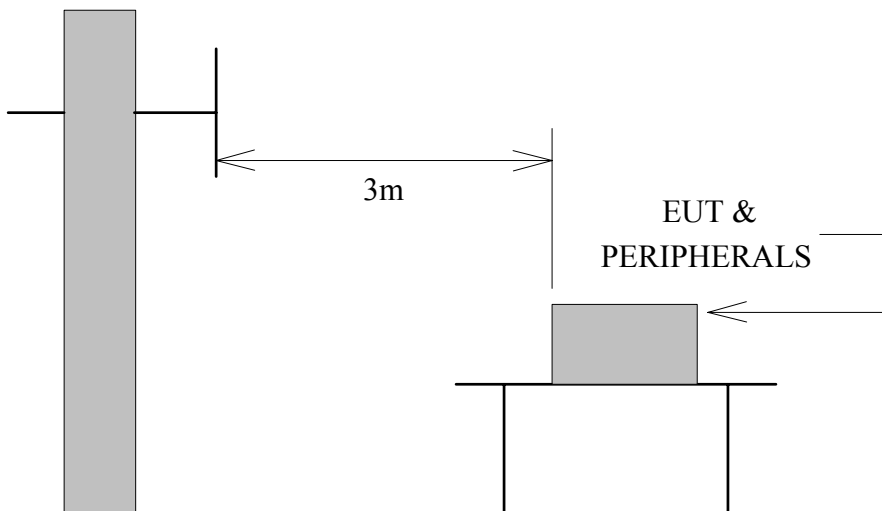

Antenna Elevation Variable

The diagram below shows the test setup that is utilized to make the measurements for emission above 1GHz.

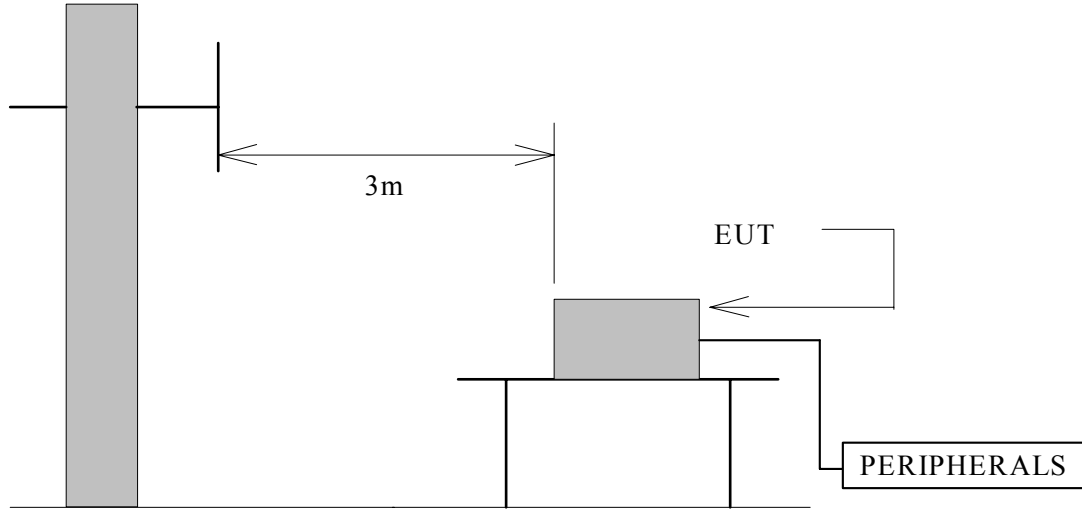

Antenna Elevation Variable

3.3 Radiation Limit

For unintentional device, according to § 15.109(a), except for Class A digital devices, the field strength of radiated emissions from unintentional radiators at a distance of 3 meters shall not exceed the following values :

Frequency (MHz)	Distance (Meters)	Radiated (dB μ V/M)	Radiated (μ V/M)
30-88	3	40.0	100
88-216	3	43.5	150
216-960	3	46.0	200
Above 960	3	54.0	500

For intentional device, according to § 15.209(a), the general requirement of field strength of radiated emissions from intentional radiators at a distance of 3 meters shall not exceed the above table.



3.4 Test Procedures

- a. The EUT was placed on the top of a rotating table 0.8 meters above the ground at a 10 meter open area test site. The table was rotated 360 degrees to determine the position of the highest radiation.
- b. The EUT was set 3 meters away from the interference-receiving antenna, which was mounted on the top of a variable-height antenna tower.
- c. The antenna is a broadband antenna, and its height is varied from one meter to four meters above the ground to determine the maximum value of the field strength. Both horizontal and vertical polarization of the antenna are set to make the measurement.
- d. For each suspected emission, the EUT was arranged to its worst case and then the antenna was tuned to heights from 1 meter to 4 meters and the table was turned from 0 degrees to 360 degrees to find the maximum reading.
- e. The test-receiver system was set to Peak Detect Function and Specified Bandwidth with Maximum Hold Mode.
- f. If the emission level of the EUT in peak mode was 10 dB lower than the limit specified, then testing could be stopped and the peak values of the EUT would be reported. Otherwise the emissions that did not have 10 dB margin would be re-tested one by one using peak, quasi-peak or average method as specified and then reported in a data sheet.

NOTE :

1. The resolution bandwidth and video bandwidth of test receiver/spectrum analyzer is 120 KHz for Peak detection (PK) and Quasi-peak detection (QP) at frequency below 1GHz.
2. The resolution bandwidth and video bandwidth of test receiver/spectrum analyzer is 1 MHz for Peak detection and frequency above 1GHz.
3. The resolution bandwidth of test receiver/spectrum analyzer is 1 MHz and the video bandwidth is 10 Hz for Average detection (AV) at frequency above 1GHz.

3.5 Uncertainty of Radiated Emission

The uncertainty of radiated emission is ± 2.72 dB.



3.6 Radiated RF Noise Measurement

Test Requirement: 15.109, 15.209

The frequency spectrum from 30 MHz to 1000 MHz was investigated. All emissions not reported below are more than 20 dB below the prescribed limits.

All readings are quasi-peak values.

Temperature : 18.3 °C

Humidity : 71 % RH

Frequency (MHz)	Antenna Factor (dB)	Cable Loss (dB)	Meter Reading at 3m(dB μ V/M)		Limits at 3m (dB μ V/M)	Emission Level at 3m(dB μ V/M)	
			Horizontal	Vertical		Horizontal	Vertical
30.00	21.39	0.90	*	*	40.00	*	*
120.00	13.31	2.00	26.50	23.60	43.50	41.81	38.91
159.99	11.26	2.50	18.90	14.10	43.50	32.66	27.86
199.99	10.39	2.80	18.10	14.30	43.50	31.29	27.49
240.01	12.55	3.12	18.10	12.10	46.00	33.77	27.77
279.99	13.34	3.44	15.30	11.60	46.00	32.08	28.38
319.99	14.25	3.72	12.20	12.10	46.00	30.17	30.07
360.02	15.74	3.96	11.10	9.70	46.00	30.80	29.40
399.99	17.24	4.20	9.30	11.70	46.00	30.74	33.14
1000.00	21.58	7.00	*	*	54.00	*	*

REMARKS : 1. * Undetectable

2. Emission level (dB μ V/M) =Antenna Factor (dB/m) + Cable loss (dB) + Meter Reading (dB μ V).

3. According to technical experiences, all spurious emission at channel 1,6,11 are almost the same below 1GHz,so that the channel 1 was chosen as representative in final test.

4. The test data marked in gray background means the EUT emission data is located in the margin uncertainty range of emission limits.

5. Mode : Wireless 802.11b Transmitting test.

6. For Antenna 1 (A530A531).



Ecom Sertech Corp.

Rm. 258, Bldg. 17, NO.195, Sec. 4 Chung Hsing Rd.,ChuTung Chen, Hsinchu, Taiwan 310, R.O.C
TEL:886-3-5918012 FAX : 886-3-5825720

FCC ID : QDWWM168GI
Report No. : ER03-11-068FRF
Page 18 of 151

Test Requirement: 15.109, 15.209

The frequency spectrum from 30 MHz to 1000 MHz was investigated. All emissions not reported below are more than 20 dB below the prescribed limits.

All readings are quasi-peak values.

Temperature : 18.3 °C

Humidity : 71 % RH

Frequency (MHz)	Antenna Factor (dB)	Cable Loss (dB)	Meter Reading at 3m(dBμV/M)		Limits at 3m (dBμV/M)	Emission Level at 3m(dBμV/M)	
			Horizontal	Vertical		Horizontal	Vertical
30.00	21.39	0.90	*	*	40.00	*	*
120.12	13.31	2.00	25.10	23.50	43.50	40.41	38.81
159.84	11.26	2.50	18.10	14.10	43.50	31.86	27.86
199.95	10.39	2.80	19.20	12.90	43.50	32.39	26.09
240.11	12.55	3.12	18.20	10.70	46.00	33.87	26.37
279.93	13.34	3.44	13.10	10.90	46.00	29.88	27.68
319.10	14.25	3.72	14.10	12.10	46.00	32.07	30.07
360.08	15.74	3.96	11.50	8.40	46.00	31.20	28.10
399.94	17.24	4.20	10.60	8.90	46.00	32.04	30.34
1000.00	21.58	7.00	*	*	54.00	*	*

REMARKS : 1. *Undetectable

2. Emission level (dBμV/M) =Antenna Factor (dB/m) + Cable loss (dB) + Meter Reading (dBμV).

3. According to technical experiences, all spurious emission at channel 1,6,11 are almost the same below 1GHz,so that the channel 1 was chosen as representative in finial test.

4. Mode : Wireless 802.11b Transmitting test.

5. For Antenna 2 (A535).



Ecom Sertech Corp.

Rm. 258, Bldg. 17, NO.195, Sec. 4 Chung Hsing Rd.,ChuTung Chen, Hsinchu, Taiwan 310, R.O.C
TEL:886-3-5918012 FAX : 886-3-5825720

FCC ID : QDWWM168GI
Report No. : ER03-11-068FRF
Page 19 of 151

Test Requirement: 15.109, 15.209

The frequency spectrum from 30 MHz to 1000 MHz was investigated. All emissions not reported below are more than 20 dB below the prescribed limits.

All readings are quasi-peak values.

Temperature : 18.3 °C

Humidity : 71 % RH

Frequency (MHz)	Antenna Factor (dB)	Cable Loss (dB)	Meter Reading at 3m(dBμV/M)		Limits at 3m (dBμV/M)	Emission Level at 3m(dBμV/M)	
			Horizontal	Vertical		Horizontal	Vertical
30.00	21.39	0.90	*	*	40.00	*	*
120.36	13.31	2.00	25.30	24.10	43.50	40.61	39.41
160.03	11.26	2.50	18.10	13.20	43.50	31.86	26.96
200.01	10.39	2.80	18.40	13.10	43.50	31.59	26.29
239.98	12.55	3.12	17.10	11.40	46.00	32.77	27.07
279.80	13.34	3.44	14.10	12.80	46.00	30.88	29.58
319.93	14.25	3.72	15.10	13.10	46.00	33.07	31.07
359.99	15.74	3.96	10.30	8.40	46.00	30.00	28.10
400.02	17.24	4.20	11.80	10.60	46.00	33.24	32.04
1000.00	21.58	7.00	*	*	54.00	*	*

REMARKS : 1. *Undetectable

2. Emission level (dBμV/M) =Antenna Factor (dB/m) + Cable loss (dB) + Meter Reading (dBμV).

3. According to technical experiences, all spurious emission at channel 1,6,11 are almost the same below 1GHz,so that the channel 1 was chosen as representative in finial test.

4. Mode : Wireless 802.11b Transmitting test.

5. For Antenna 3 (A800).



Ecom Sertech Corp.

Rm. 258, Bldg. 17, NO.195, Sec. 4 Chung Hsing Rd.,ChuTung Chen, Hsinchu, Taiwan 310, R.O.C
TEL:886-3-5918012 FAX : 886-3-5825720

FCC ID : QDWWM168GI
Report No. : ER03-11-068FRF
Page 20 of 151

Test Requirement: 15.109, 15.209

The frequency spectrum from 30 MHz to 1000 MHz was investigated. All emissions not reported below are more than 20 dB below the prescribed limits.

All readings are quasi-peak values.

Temperature : 18.3 °C

Humidity : 71 % RH

Frequency (MHz)	Antenna Factor (dB)	Cable Loss (dB)	Meter Reading at 3m(dBμV/M)		Limits at 3m (dBμV/M)	Emission Level at 3m(dBμV/M)	
			Horizontal	Vertical		Horizontal	Vertical
30.00	21.39	0.90	*	*	40.00	*	*
120.05	13.31	2.00	25.36	24.70	43.50	40.67	40.01
160.06	11.26	2.50	19.60	15.30	43.50	33.36	29.06
200.05	10.39	2.80	20.10	14.10	43.50	33.29	27.29
240.03	12.55	3.12	19.30	12.30	46.00	34.97	27.97
280.06	13.34	3.44	14.20	11.80	46.00	30.98	28.58
320.03	14.25	3.72	16.10	13.10	46.00	34.07	31.07
359.98	15.74	3.96	12.30	8.60	46.00	32.00	28.30
399.97	17.24	4.20	11.10	10.50	46.00	32.54	31.94
1000.00	21.58	7.00	*	*	54.00	*	*

REMARKS : 1. *Undetectable

2. Emission level (dBμV/M) =Antenna Factor (dB/m) + Cable loss (dB) + Meter Reading (dBμV).

3. According to technical experiences, all spurious emission at channel 1,6,11 are almost the same below 1GHz,so that the channel 1 was chosen as representative in finial test.

4. Mode : Wireless 802.11b Transmitting test.

5. For Antenna 4 (G736).



Ecom Sertech Corp.

Rm. 258, Bldg. 17, NO.195, Sec. 4 Chung Hsing Rd.,ChuTung Chen, Hsinchu, Taiwan 310, R.O.C
TEL:886-3-5918012 FAX : 886-3-5825720

FCC ID : QDWWM168GI
Report No. : ER03-11-068FRF
Page 21 of 151

Test Requirement: 15.109, 15.209

The frequency spectrum from 30 MHz to 1000 MHz was investigated. All emissions not reported below are more than 20 dB below the prescribed limits.

All readings are quasi-peak values.

Temperature : 18.3 °C

Humidity : 71 % RH

Frequency (MHz)	Antenna Factor (dB)	Cable Loss (dB)	Meter Reading at 3m(dBμV/M)		Limits at 3m (dBμV/M)	Emission Level at 3m(dBμV/M)	
			Horizontal	Vertical		Horizontal	Vertical
30.00	21.39	0.90	*	*	40.00	*	*
199.97	13.31	2.00	26.30	22.70	43.50	41.61	38.01
160.03	11.26	2.50	18.60	13.80	43.50	32.36	27.56
200.03	10.39	2.80	17.60	13.40	43.50	30.79	26.59
239.96	12.55	3.12	17.20	11.80	46.00	32.87	27.47
280.03	13.34	3.44	14.30	10.60	46.00	31.08	27.38
320.05	14.25	3.72	13.10	11.30	46.00	31.07	29.27
359.60	15.74	3.96	10.30	8.30	46.00	30.00	28.00
400.12	17.24	4.20	8.20	10.60	46.00	29.64	32.04
1000.00	21.58	7.00	*	*	54.00	*	*

REMARKS : 1. *Undetectable

2. Emission level (dBμV/M) =Antenna Factor (dB/m) + Cable loss (dB) + Meter Reading (dBμV).

3. According to technical experiences, all spurious emission at channel 1,6,11 are almost the same below 1GHz,so that the channel 1 was chosen as representative in finial test.

4. The test data marked in gray background means the EUT emission data is located in the margin uncertainty range of emission limits.

5. Mode : Wireless 802.11g Transmitting test.

6. For Antenna 1 (A530A531).



Ecom Sertech Corp.

Rm. 258, Bldg. 17, NO.195, Sec. 4 Chung Hsing Rd.,ChuTung Chen, Hsinchu, Taiwan 310, R.O.C
TEL:886-3-5918012 FAX : 886-3-5825720

FCC ID : QDWWM168GI
Report No. : ER03-11-068FRF
Page 22 of 151

Test Requirement: 15.109, 15.209

The frequency spectrum from 30 MHz to 1000 MHz was investigated. All emissions not reported below are more than 20 dB below the prescribed limits.

All readings are quasi-peak values.

Temperature : 18.3 °C

Humidity : 71 % RH

Frequency (MHz)	Antenna Factor (dB)	Cable Loss (dB)	Meter Reading at 3m(dBμV/M)		Limits at 3m (dBμV/M)	Emission Level at 3m(dBμV/M)	
			Horizontal	Vertical		Horizontal	Vertical
30.00	21.39	0.90	*	*	40.00	*	*
120.03	13.31	2.00	24.26	22.60	43.50	39.57	37.91
160.12	11.26	2.50	17.16	13.50	43.50	30.92	27.26
200.11	10.39	2.80	18.26	12.10	43.50	31.45	25.29
239.18	12.55	3.12	17.26	10.10	46.00	32.93	25.77
280.12	13.34	3.44	12.20	10.40	46.00	28.98	27.18
320.03	14.25	3.72	13.20	11.50	46.00	31.17	29.47
359.11	15.74	3.96	10.90	6.20	46.00	30.60	25.90
400.09	17.24	4.20	9.70	7.80	46.00	31.14	29.24
1000.00	21.58	7.00	*	*	54.00	*	*

REMARKS : 1. *Undetectable

2. Emission level (dBμV/M) =Antenna Factor (dB/m) + Cable loss (dB) + Meter Reading (dBμV).

3. According to technical experiences, all spurious emission at channel 1,6,11 are almost the same below 1GHz,so that the channel 1 was chosen as representative in finial test.

4. Mode : Wireless 802.11g Transmitting test.

5. For Antenna 2 (A535).



Ecom Sertech Corp.

Rm. 258, Bldg. 17, NO.195, Sec. 4 Chung Hsing Rd.,ChuTung Chen, Hsinchu, Taiwan 310, R.O.C
TEL:886-3-5918012 FAX : 886-3-5825720

FCC ID : QDWWM168GI
Report No. : ER03-11-068FRF
Page 23 of 151

Test Requirement: 15.109, 15.209

The frequency spectrum from 30 MHz to 1000 MHz was investigated. All emissions not reported below are more than 20 dB below the prescribed limits.

All readings are quasi-peak values.

Temperature : 18.3 °C

Humidity : 71 % RH

Frequency (MHz)	Antenna Factor (dB)	Cable Loss (dB)	Meter Reading at 3m(dBμV/M)		Limits at 3m (dBμV/M)	Emission Level at 3m(dBμV/M)	
			Horizontal	Vertical		Horizontal	Vertical
30.00	21.39	0.90	*	*	40.00	*	*
119.97	13.31	2.00	25.10	23.80	43.50	40.41	39.11
159.06	11.26	2.50	17.30	12.90	43.50	31.06	26.66
200.03	10.39	2.80	18.20	12.80	43.50	31.39	25.99
240.03	12.55	3.12	16.80	10.90	46.00	32.47	26.57
280.09	13.34	3.44	13.10	11.10	46.00	29.88	27.88
320.03	14.25	3.72	14.20	12.10	46.00	32.17	30.07
359.97	15.74	3.96	9.80	7.60	46.00	29.50	27.30
400.03	17.24	4.20	10.60	9.80	46.00	32.04	31.24
1000.00	21.58	7.00	*	*	54.00	*	*

REMARKS : 1. *Undetectable

2. Emission level (dBμV/M) =Antenna Factor (dB/m) + Cable loss (dB) + Meter Reading (dBμV).

3. According to technical experiences, all spurious emission at channel 1,6,11 are almost the same below 1GHz,so that the channel 1 was chosen as representative in finial test.

4. Mode : Wireless 802.11g Transmitting test.

5. For Antenna 3 (A800).



Ecom Sertech Corp.

Rm. 258, Bldg. 17, NO.195, Sec. 4 Chung Hsing Rd.,ChuTung Chen, Hsinchu, Taiwan 310, R.O.C
TEL:886-3-5918012 FAX : 886-3-5825720

FCC ID : QDWWM168GI
Report No. : ER03-11-068FRF
Page 24 of 151

Test Requirement: 15.109, 15.209

The frequency spectrum from 30 MHz to 1000 MHz was investigated. All emissions not reported below are more than 20 dB below the prescribed limits.

All readings are quasi-peak values.

Temperature : 18.3 °C

Humidity : 71 % RH

Frequency (MHz)	Antenna Factor (dB)	Cable Loss (dB)	Meter Reading at 3m(dBμV/M)		Limits at 3m (dBμV/M)	Emission Level at 3m(dBμV/M)	
			Horizontal	Vertical		Horizontal	Vertical
30.00	21.39	0.90	*	*	40.00	*	*
119.89	13.31	2.00	26.40	24.10	43.50	41.71	39.41
160.11	11.26	2.50	18.80	14.50	43.50	32.56	28.26
200.03	10.39	2.80	19.30	13.80	43.50	32.49	26.99
239.72	12.55	3.12	18.60	11.10	46.00	34.27	26.77
280.36	13.34	3.44	13.10	11.20	46.00	29.88	27.98
320.79	14.25	3.72	15.60	12.60	46.00	33.57	30.57
359.69	15.74	3.96	11.70	7.90	46.00	31.40	27.60
400.09	17.24	4.20	10.40	9.30	46.00	31.84	30.74
1000.00	21.58	7.00	*	*	54.00	*	*

REMARKS : 1. *Undetectable

2. Emission level (dBμV/M) =Antenna Factor (dB/m) + Cable loss (dB) + Meter Reading (dBμV).

3. According to technical experiences, all spurious emission at channel 1,6,11 are almost the same below 1GHz,so that the channel 1 was chosen as representative in finial test.

4. The test data marked in gray background means the EUT emission data is located in the margin uncertainty range of emission limits.

5. Mode : Wireless 802.11g Transmitting test.

6. For Antenna 4 (G736).



Ecom Sertech Corp.

Rm. 258, Bldg. 17, NO.195, Sec. 4 Chung Hsing Rd., ChuTung Chen, Hsinchu, Taiwan 310, R.O.C
 TEL:886-3-5918012 FAX : 886-3-5825720

FCC ID : QDWWM168GI
 Report No. : ER03-11-068FRF
 Page 25 of 151

Test Requirement: 15.109 ,15.209

The frequency spectrum above 1 GHz was investigated. All emissions not reported below are more than 40 dB below the prescribed limits. Readings are both peak and average values.

Company	AirVast Technology Inc.	Test Date :	2003/12/23
Product Name	802.11g WLAN USB Module	Test By:	K. P. Pang
Model Name	WM168gi	TEMP&Humidity :	23.3°C , 51%

CH1 RX				Measurement Distance at 1m				Horizontal polarity			
Freq.	Reading	AF	Cable	Pre-amp	Dist	Filter	Level	Limit	Margin	Mark	Height
(MHz)	(dBuV)	(dBuV)	(dB)	(dB)	dB	dB	(dBuV/m)	(dBuV/m)	(dB)	(P/Q/A)	(Meter)
4824.01	52.67	34.44	2.82	35.16	9.50	0.00	45.27	74	-28.73	P	1.00
4824.01	49.23	34.44	2.82	35.16	9.50	0.00	41.83	54	-12.17	A	1.00
7236.10	44.49	39.81	4.79	35.65	9.50	0.00	43.94	74	-30.06	P	1.00
7236.10	33.44	39.81	4.79	35.65	9.50	0.00	32.89	54	-21.11	A	1.00
9647.89	47.12	38.54	5.90	36.44	9.50	0.00	45.62	74	-28.38	P	1.00
9647.89	36.45	38.54	5.90	36.44	9.50	0.00	34.95	54	-19.05	A	1.00

1. AF: Antenna Factor, Cable: Cable Loss, Pre-Amp: Preamplifier gain, Filter: High Pass Filter Insertion Loss (3.5GHz)
2. Analyzer setting P(Peak): RBW=1MHz, VBW=1MHz, A(Average): RBW=1MHz,VBW=10Hz
3. Dist : correction to extra plate reading to 3m specification distance 1m measurement distance = -9.5dB
4. The result basic equation calculation as follow :

$$\text{Level} = \text{Reading} + \text{AF} + \text{Cable} - \text{Preamp} + \text{Filter} - \text{Dist}, \text{Margin} = \text{Level} - \text{Limit}$$
5. The test limit is 3M limit.
6. The other emission levels were very low against the limit.
7. For 802.11b mode at 11Mbps.
8. For Antenna 1 (A530A531).



Ecom Sertech Corp.

Rm. 258, Bldg. 17, NO.195, Sec. 4 Chung Hsing Rd.,ChuTung Chen, Hsinchu, Taiwan 310, R.O.C
TEL:886-3-5918012 FAX : 886-3-5825720

FCC ID : QDWWM168GI
Report No. : ER03-11-068FRF
Page 26 of 151

Test Requirement: 15.109 ,15.209

The frequency spectrum above 1 GHz was investigated. All emissions not reported below are more than 40 dB below the prescribed limits. Readings are both peak and average values.

Company	AirVast Technology Inc.	Test Date :	2003/12/23
Product Name	802.11g WLAN USB Module	Test By:	K. P. Pang
Model Name	WM168gi	TEMP&Humidity :	23.3°C , 51%

CH1 RX				Measurement Distance at 1m					Vertical polarity			
Freq.	Reading	AF	Cable	Pre-amp	Dist	Filter	Level	Limit	Margin	Mark	Height	
(MHz)	(dBuV)	(dBuV)	(dB)	(dB)	dB	dB	(dBuV/m)	(dBuV/m)	(dB)	(P/Q/A)	(Meter)	
4824.01	53.99	34.44	2.82	35.16	9.50	0.00	46.59	74	-27.41	P	1.00	
4824.01	51.03	34.44	2.82	35.16	9.50	0.00	43.63	54	-10.37	A	1.00	
7235.90	44.80	39.81	4.79	35.65	9.50	0.00	44.25	74	-29.75	P	1.00	
7235.90	34.13	39.81	4.79	35.65	9.50	0.00	33.58	54	-20.42	A	1.00	
9647.89	47.79	38.54	5.90	36.44	9.50	0.00	46.29	74	-27.71	P	1.00	
9647.89	38.46	38.54	5.90	36.44	9.50	0.00	36.96	54	-17.04	A	1.00	

1. AF: Antenna Factor, Cable: Cable Loss, Pre-Amp: Preamplifier gain, Filter: High Pass Filter Insertion Loss (3.5GHz)
2. Analyzer setting P(Peak): RBW=1MHz, VBW=1MHz, A(Average): RBW=1MHz,VBW=10Hz
3. Dist : correction to extra plate reading to 3m specification distance 1m measurement distance = -9.5dB
4. The result basic equation calculation as follow :
Level = Reading + AF + Cable - Preamp + Filter - Dist, Margin = Level - Limit
5. The test limit is 3M limit.
6. The other emission levels were very low against the limit.
7. For 802.11b mode at 11Mbps.
8. For Antenna 1 (A530A531).



Ecom Sertech Corp.

Rm. 258, Bldg. 17, NO.195, Sec. 4 Chung Hsing Rd., ChuTung Chen, Hsinchu, Taiwan 310, R.O.C
 TEL:886-3-5918012 FAX : 886-3-5825720

FCC ID : QDWWM168GI
 Report No. : ER03-11-068FRF
 Page 27 of 151

Test Requirement: 15.109 ,15.209

The frequency spectrum above 1 GHz was investigated. All emissions not reported below are more than 40 dB below the prescribed limits. Readings are both peak and average values.

Company	AirVast Technology Inc.	Test Date :	2003/12/23
Product Name	802.11g WLAN USB Module	Test By:	K. P. Pang
Model Name	WM168gi	TEMP&Humidity :	23.3°C , 51%

CH6 RX				Measurement Distance at 1m				Horizontal polarity			
Freq.	Reading	AF	Cable	Pre-amp	Dist	Filter	Level	Limit	Margin	Mark	Height
(MHz)	(dBuV)	(dBuV)	(dB)	(dB)	dB	dB	(dBuV/m)	(dBuV/m)	(dB)	(P/Q/A)	(Meter)
4873.98	52.44	34.77	2.73	35.20	9.50	0.00	45.24	74	-28.76	P	1.00
4873.98	48.86	34.77	2.73	35.20	9.50	0.00	41.66	54	-12.34	A	1.00
7311.05	43.75	39.78	4.82	35.64	9.50	0.00	43.21	74	-30.79	P	1.00
7311.05	33.31	39.78	4.82	35.64	9.50	0.00	32.77	54	-21.23	A	1.00
9747.75	47.24	38.53	5.90	36.60	9.50	0.00	45.57	74	-28.43	P	1.00
9747.75	36.13	38.53	5.90	36.60	9.50	0.00	34.46	54	-19.54	A	1.00

1. AF: Antenna Factor, Cable: Cable Loss, Pre-Amp: Preamplifier gain, Filter: High Pass Filter Insertion Loss (3.5GHz)
2. Analyzer setting P(Peak): RBW=1MHz, VBW=1MHz, A(Average): RBW=1MHz,VBW=10Hz
3. Dist : correction to extra plate reading to 3m specification distance 1m measurement distance = -9.5dB
4. The result basic equation calculation as follow :

$$\text{Level} = \text{Reading} + \text{AF} + \text{Cable} - \text{Preamp} + \text{Filter} - \text{Dist}, \text{Margin} = \text{Level} - \text{Limit}$$
5. The test limit is 3M limit.
6. The other emission levels were very low against the limit.
7. For 802.11b mode at 11Mbps.
8. For Antenna 1 (A530A531).



Ecom Sertech Corp.

Rm. 258, Bldg. 17, NO.195, Sec. 4 Chung Hsing Rd., ChuTung Chen, Hsinchu, Taiwan 310, R.O.C
 TEL:886-3-5918012 FAX : 886-3-5825720

FCC ID : QDWWM168GI
 Report No. : ER03-11-068FRF
 Page 28 of 151

Test Requirement: 15.109 ,15.209

The frequency spectrum above 1 GHz was investigated. All emissions not reported below are more than 40 dB below the prescribed limits. Readings are both peak and average values.

Company	AirVast Technology Inc.	Test Date :	2003/12/23
Product Name	802.11g WLAN USB Module	Test By:	K. P. Pang
Model Name	WM168gi	TEMP&Humidity :	23.3°C , 51%

CH6 RX				Measurement Distance at 1m					Vertical polarity		
Freq.	Reading	AF	Cable	Pre-amp	Dist	Filter	Level	Limit	Margin	Mark	Height
(MHz)	(dBuV)	(dBuV)	(dB)	(dB)	dB	dB	(dBuV/m)	(dBuV/m)	(dB)	(P/Q/A)	(Meter)
4874.08	53.10	34.77	2.73	35.20	9.50	0.00	45.90	74	-28.10	P	1.00
4874.08	50.20	34.77	2.73	35.20	9.50	0.00	43.00	54	-11.00	A	1.00
7310.93	45.09	39.78	4.82	35.64	9.50	0.00	44.55	74	-29.45	P	1.00
7310.93	34.33	39.78	4.82	35.64	9.50	0.00	33.79	54	-20.21	A	1.00
9748.06	47.36	38.53	5.90	36.60	9.50	0.00	45.69	74	-28.31	P	1.00
9748.06	37.09	38.53	5.90	36.60	9.50	0.00	35.42	54	-18.58	A	1.00

- | |
|--|
| 1. AF: Antenna Factor, Cable: Cable Loss, Pre-Amp: Preamplifier gain, Filter: High Pass Filter Insertion Loss (3.5GHz) |
| 2. Analyzer setting P(Peak): RBW=1MHz, VBW=1MHz, A(Average): RBW=1MHz,VBW=10Hz |
| 3. Dist : correction to extra plate reading to 3m specification distance 1m measurement distance = -9.5dB |
| 4. The result basic equation calculation as follow : |
| Level = Reading + AF + Cable - Preamp + Filter - Dist, Margin = Level - Limit |
| 5. The test limit is 3M limit. |
| 6. The other emission levels were very low against the limit. |
| 7. For 802.11b mode at 11Mbps. |
| 8. For Antenna 1 (A530A531). |



Ecom Sertech Corp.

Rm. 258, Bldg. 17, NO.195, Sec. 4 Chung Hsing Rd., ChuTung Chen, Hsinchu, Taiwan 310, R.O.C
 TEL:886-3-5918012 FAX : 886-3-5825720

FCC ID : QDWWM168GI
 Report No. : ER03-11-068FRF
 Page 29 of 151

Test Requirement: 15.109 ,15.209

The frequency spectrum above 1 GHz was investigated. All emissions not reported below are more than 40 dB below the prescribed limits. Readings are both peak and average values.

Company	AirVast Technology Inc.	Test Date :	2003/12/23
Product Name	802.11g WLAN USB Module	Test By:	K. P. Pang
Model Name	WM168gi	TEMP&Humidity :	23.3°C , 51%

CH11 RX				Measurement Distance at 1m				Horizontal polarity			
Freq.	Reading	AF	Cable	Pre-amp	Dist	Filter	Level	Limit	Margin	Mark	Height
(MHz)	(dBuV)	(dBuV)	(dB)	(dB)	dB	dB	(dBuV/m)	(dBuV/m)	(dB)	(P/Q/A)	(Meter)
4923.80	52.52	35.10	2.64	35.24	9.50	0.00	45.52	74	-28.48	P	1.00
4923.80	47.97	35.10	2.64	35.24	9.50	0.00	40.97	54	-13.03	A	1.00
7386.13	45.22	39.75	4.85	35.62	9.50	0.00	44.70	74	-29.30	P	1.00
7386.13	34.12	39.75	4.85	35.62	9.50	0.00	33.60	54	-20.40	A	1.00
9847.93	47.38	38.52	5.90	36.76	9.50	0.00	45.54	74	-28.46	P	1.00
9847.93	37.22	38.52	5.90	36.76	9.50	0.00	35.38	54	-18.62	A	1.00

- | |
|--|
| 1. AF: Antenna Factor, Cable: Cable Loss, Pre-Amp: Preamplifier gain, Filter: High Pass Filter Insertion Loss (3.5GHz) |
| 2. Analyzer setting P(Peak): RBW=1MHz, VBW=1MHz, A(Average): RBW=1MHz,VBW=10Hz |
| 3. Dist : correction to extra plate reading to 3m specification distance 1m measurement distance = -9.5dB |
| 4. The result basic equation calculation as follow : |
| Level = Reading + AF + Cable - Preamp + Filter - Dist, Margin = Level - Limit |
| 5. The test limit is 3M limit. |
| 6. The other emission levels were very low against the limit. |
| 7. For 802.11b mode at 11Mbps. |
| 8. For Antenna 1 (A530A531). |



Ecom Sertech Corp.

Rm. 258, Bldg. 17, NO.195, Sec. 4 Chung Hsing Rd., ChuTung Chen, Hsinchu, Taiwan 310, R.O.C
 TEL:886-3-5918012 FAX : 886-3-5825720

FCC ID : QDWWM168GI
 Report No. : ER03-11-068FRF
 Page 30 of 151

Test Requirement: 15.109 ,15.209

The frequency spectrum above 1 GHz was investigated. All emissions not reported below are more than 40 dB below the prescribed limits. Readings are both peak and average values.

Company	AirVast Technology Inc.	Test Date :	2003/12/23
Product Name	802.11g WLAN USB Module	Test By:	K. P. Pang
Model Name	WM168gi	TEMP&Humidity :	23.3°C , 51%

CH11 RX				Measurement Distance at 1m				Vertical polarity			
Freq.	Reading	AF	Cable	Pre-amp	Dist	Filter	Level	Limit	Margin	Mark	Height
(MHz)	(dBuV)	(dBuV)	(dB)	(dB)	dB	dB	(dBuV/m)	(dBuV/m)	(dB)	(P/Q/A)	(Meter)
4923.95	52.79	35.10	2.64	35.24	9.50	0.00	45.79	74	-28.21	P	1.00
4923.95	49.37	35.10	2.64	35.24	9.50	0.00	42.37	54	-11.63	A	1.00
7385.95	43.63	39.75	4.85	35.62	9.50	0.00	43.11	74	-30.89	P	1.00
7385.95	32.86	39.75	4.85	35.62	9.50	0.00	32.34	54	-21.66	A	1.00
9848.03	48.12	38.52	5.90	36.76	9.50	0.00	46.28	74	-27.72	P	1.00
9848.03	38.25	38.52	5.90	36.76	9.50	0.00	36.41	54	-17.59	A	1.00

- | |
|--|
| 1. AF: Antenna Factor, Cable: Cable Loss, Pre-Amp: Preamplifier gain, Filter: High Pass Filter Insertion Loss (3.5GHz) |
| 2. Analyzer setting P(Peak): RBW=1MHz, VBW=1MHz, A(Average): RBW=1MHz,VBW=10Hz |
| 3. Dist : correction to extra plate reading to 3m specification distance 1m measurement distance = -9.5dB |
| 4. The result basic equation calculation as follow : |
| Level = Reading + AF + Cable - Preamp + Filter - Dist, Margin = Level - Limit |
| 5. The test limit is 3M limit. |
| 6. The other emission levels were very low against the limit. |
| 7. For 802.11b mode at 11Mbps. |
| 8. For Antenna 1 (A530A531). |



Ecom Sertech Corp.

Rm. 258, Bldg. 17, NO.195, Sec. 4 Chung Hsing Rd.,ChuTung Chen, Hsinchu, Taiwan 310, R.O.C
 TEL:886-3-5918012 FAX : 886-3-5825720

FCC ID : QDWWM168GI
 Report No. : ER03-11-068FRF
 Page 31 of 151

Test Requirement: 15.109 ,15.209

The frequency spectrum above 1 GHz was investigated. All emissions not reported below are more than 40 dB below the prescribed limits. Readings are both peak and average values.

Company	AirVast Technology Inc.	Test Date :	2003/12/23
Product Name	802.11g WLAN USB Module	Test By:	K. P. Pang
Model Name	WM168gi	TEMP&Humidity :	23.3°C , 51%

CH1 RX				Measurement Distance at 1m					Horizontal polarity		
Freq.	Reading	AF	Cable	Pre-amp	Dist	Filter	Level	Limit	Margin	Mark	Height
(MHz)	(dBuV)	(dBuV)	(dB)	(dB)	dB	dB	(dBuV/m)	(dBuV/m)	(dB)	(P/Q/A)	(Meter)
4823.96	53.80	34.44	2.82	35.16	9.50	0.00	46.40	74	-27.60	P	1.00
4823.96	50.83	34.44	2.82	35.16	9.50	0.00	43.43	54	-10.57	A	1.00
7235.95	44.07	39.81	4.79	35.65	9.50	0.00	43.52	74	-30.48	P	1.00
7235.95	33.46	39.81	4.79	35.65	9.50	0.00	32.91	54	-21.09	A	1.00
9647.86	47.42	38.54	5.90	36.44	9.50	0.00	45.92	74	-28.08	P	1.00
9647.86	35.51	38.54	5.90	36.44	9.50	0.00	34.01	54	-19.99	A	1.00

1. AF: Antenna Factor, Cable: Cable Loss, Pre-Amp: Preamplifier gain, Filter: High Pass Filter Insertion Loss (3.5GHz)
2. Analyzer setting P(Peak): RBW=1MHz, VBW=1MHz, A(Average): RBW=1MHz,VBW=10Hz
3. Dist : correction to extra plate reading to 3m specification distance 1m measurement distance = -9.5dB
4. The result basic equation calculation as follow :

$$\text{Level} = \text{Reading} + \text{AF} + \text{Cable} - \text{Preamp} + \text{Filter} - \text{Dist}, \text{Margin} = \text{Level} - \text{Limit}$$
5. The test limit is 3M limit.
6. The other emission levels were very low against the limit.
7. For 802.11g mode at 6Mbps.
8. For Antenna 1 (A530A531).



Ecom Sertech Corp.

Rm. 258, Bldg. 17, NO.195, Sec. 4 Chung Hsing Rd.,ChuTung Chen, Hsinchu, Taiwan 310, R.O.C
 TEL:886-3-5918012 FAX : 886-3-5825720

FCC ID : QDWWM168GI
 Report No. : ER03-11-068FRF
 Page 32 of 151

Test Requirement: 15.109 ,15.209

The frequency spectrum above 1 GHz was investigated. All emissions not reported below are more than 40 dB below the prescribed limits. Readings are both peak and average values.

Company	AirVast Technology Inc.	Test Date :	2003/12/23
Product Name	802.11g WLAN USB Module	Test By:	K. P. Pang
Model Name	WM168gi	TEMP&Humidity :	25.9°C , 45%

CH1 RX				Measurement Distance at 1m					Vertical polarity		
Freq.	Reading	AF	Cable	Pre-amp	Dist	Filter	Level	Limit	Margin	Mark	Height
(MHz)	(dBuV)	(dBuV)	(dB)	(dB)	dB	dB	(dBuV/m)	(dBuV/m)	(dB)	(P/Q/A)	(Meter)
4823.86	54.73	34.44	2.82	35.16	9.50	0.00	47.33	74	-26.67	P	1.00
4823.86	52.03	34.44	2.82	35.16	9.50	0.00	44.63	54	-9.37	A	1.00
7236.09	44.51	39.81	4.79	35.65	9.50	0.00	43.96	74	-30.04	P	1.00
7236.09	33.38	39.81	4.79	35.65	9.50	0.00	32.83	54	-21.17	A	1.00
9647.64	47.62	38.54	5.90	36.44	9.50	0.00	46.12	74	-27.88	P	1.00
9647.64	37.75	38.54	5.90	36.44	9.50	0.00	36.25	54	-17.75	A	1.00

- | |
|--|
| 1. AF: Antenna Factor, Cable: Cable Loss, Pre-Amp: Preamplifier gain, Filter: High Pass Filter Insertion Loss (3.5GHz) |
| 2. Analyzer setting P(Peak): RBW=1MHz, VBW=1MHz, A(Average): RBW=1MHz,VBW=10Hz |
| 3. Dist : correction to extra plate reading to 3m specification distance 1m measurement distance = -9.5dB |
| 4. The result basic equation calculation as follow : |
| Level = Reading + AF + Cable - Preamp + Filter - Dist, Margin = Level - Limit |
| 5. The test limit is 3M limit. |
| 6. The other emission levels were very low against the limit. |
| 7. For 802.11g mode at 6Mbps. |
| 8. For Antenna 1 (A530A531). |



Ecom Sertech Corp.

Rm. 258, Bldg. 17, NO.195, Sec. 4 Chung Hsing Rd.,ChuTung Chen, Hsinchu, Taiwan 310, R.O.C
 TEL:886-3-5918012 FAX : 886-3-5825720

FCC ID : QDWWM168GI
 Report No. : ER03-11-068FRF
 Page 33 of 151

Test Requirement: 15.109 ,15.209

The frequency spectrum above 1 GHz was investigated. All emissions not reported below are more than 40 dB below the prescribed limits. Readings are both peak and average values.

Company	AirVast Technology Inc.	Test Date :	2003/12/23
Product Name	802.11g WLAN USB Module	Test By:	K. P. Pang
Model Name	WM168gi	TEMP&Humidity :	25.9°C , 45%

CH6 RX				Measurement Distance at 1m					Horizontal polarity			
Freq.	Reading	AF	Cable	Pre-amp	Dist	Filter	Level	Limit	Margin	Mark	Height	
(MHz)	(dBuV)	(dBuV)	(dB)	(dB)	dB	dB	(dBuV/m)	(dBuV/m)	(dB)	(P/Q/A)	(Meter)	
4874.01	53.38	34.77	2.73	35.20	9.50	0.00	46.18	74	-27.82	P	1.00	
4874.01	50.12	34.77	2.73	35.20	9.50	0.00	42.92	54	-11.08	A	1.00	
7310.91	45.21	39.78	4.82	35.64	9.50	0.00	44.67	74	-29.33	P	1.00	
7310.91	33.74	39.78	4.82	35.64	9.50	0.00	33.20	54	-20.80	A	1.00	
9748.04	47.29	38.53	5.90	36.60	9.50	0.00	45.62	74	-28.38	P	1.00	
9748.04	36.77	38.53	5.90	36.60	9.50	0.00	35.10	54	-18.90	A	1.00	

1. AF: Antenna Factor, Cable: Cable Loss, Pre-Amp: Preamplifier gain, Filter: High Pass Filter Insertion Loss (3.5GHz)
2. Analyzer setting P(Peak): RBW=1MHz, VBW=1MHz, A(Average): RBW=1MHz,VBW=10Hz
3. Dist : correction to extra plate reading to 3m specification distance 1m measurement distance = -9.5dB
4. The result basic equation calculation as follow :

$$\text{Level} = \text{Reading} + \text{AF} + \text{Cable} - \text{Preamp} + \text{Filter} - \text{Dist}, \text{Margin} = \text{Level} - \text{Limit}$$
5. The test limit is 3M limit.
6. The other emission levels were very low against the limit.
7. For 802.11g mode at 6Mbps.
8. For Antenna 1 (A530A531).



Ecom Sertech Corp.

Rm. 258, Bldg. 17, NO.195, Sec. 4 Chung Hsing Rd.,ChuTung Chen, Hsinchu, Taiwan 310, R.O.C
 TEL:886-3-5918012 FAX : 886-3-5825720

FCC ID : QDWWM168GI
 Report No. : ER03-11-068FRF
 Page 34 of 151

Test Requirement: 15.109 ,15.209

The frequency spectrum above 1 GHz was investigated. All emissions not reported below are more than 40 dB below the prescribed limits. Readings are both peak and average values.

Company	AirVast Technology Inc.	Test Date :	2003/12/23
Product Name	802.11g WLAN USB Module	Test By:	K. P. Pang
Model Name	WM168gi	TEMP&Humidity :	25.9°C , 45%

CH6 RX				Measurement Distance at 1m					Vertical polarity		
Freq.	Reading	AF	Cable	Pre-amp	Dist	Filter	Level	Limit	Margin	Mark	Height
(MHz)	(dBuV)	(dBuV)	(dB)	(dB)	dB	dB	(dBuV/m)	(dBuV/m)	(dB)	(P/Q/A)	(Meter)
4873.90	54.12	34.77	2.73	35.20	9.50	0.00	46.92	74	-27.08	P	1.00
4873.90	51.25	34.77	2.73	35.20	9.50	0.00	44.05	54	-9.95	A	1.00
7310.90	44.94	39.78	4.82	35.64	9.50	0.00	44.40	74	-29.60	P	1.00
7310.90	34.26	39.78	4.82	35.64	9.50	0.00	33.72	54	-20.28	A	1.00
9748.09	47.42	38.53	5.90	36.60	9.50	0.00	45.75	74	-28.25	P	1.00
9748.09	37.50	38.53	5.90	36.60	9.50	0.00	35.83	54	-18.17	A	1.00

1. AF: Antenna Factor, Cable: Cable Loss, Pre-Amp: Preamplifier gain, Filter: High Pass Filter Insertion Loss (3.5GHz)
2. Analyzer setting P(Peak): RBW=1MHz, VBW=1MHz, A(Average): RBW=1MHz,VBW=10Hz
3. Dist : correction to extra plate reading to 3m specification distance 1m measurement distance = -9.5dB
4. The result basic equation calculation as follow :

$$\text{Level} = \text{Reading} + \text{AF} + \text{Cable} - \text{Preamp} + \text{Filter} - \text{Dist}, \text{Margin} = \text{Level} - \text{Limit}$$
5. The test limit is 3M limit.
6. The other emission levels were very low against the limit.
7. For 802.11g mode at 6Mbps.
8. For Antenna 1 (A530A531).



Ecom Sertech Corp.

Rm. 258, Bldg. 17, NO.195, Sec. 4 Chung Hsing Rd.,ChuTung Chen, Hsinchu, Taiwan 310, R.O.C
 TEL:886-3-5918012 FAX : 886-3-5825720

FCC ID : QDWWM168GI
 Report No. : ER03-11-068FRF
 Page 35 of 151

Test Requirement: 15.109 ,15.209

The frequency spectrum above 1 GHz was investigated. All emissions not reported below are more than 40 dB below the prescribed limits. Readings are both peak and average values.

Company	AirVast Technology Inc.	Test Date :	2003/12/23
Product Name	802.11g WLAN USB Module	Test By:	K. P. Pang
Model Name	WM168gi	TEMP&Humidity :	25.9°C , 45%

CH11 RX				Measurement Distance at 1m					Horizontal polarity		
Freq.	Reading	AF	Cable	Pre-amp	Dist	Filter	Level	Limit	Margin	Mark	Height
(MHz)	(dBuV)	(dBuV)	(dB)	(dB)	dB	dB	(dBuV/m)	(dBuV/m)	(dB)	(P/Q/A)	(Meter)
4924.00	53.26	35.10	2.64	35.24	9.50	0.00	46.26	74	-27.74	P	1.00
4924.00	49.99	35.10	2.64	35.24	9.50	0.00	42.99	54	-11.01	A	1.00
7386.20	45.43	39.75	4.85	35.62	9.50	0.00	44.91	74	-29.09	P	1.00
7386.20	33.98	39.75	4.85	35.62	9.50	0.00	33.46	54	-20.54	A	1.00
9848.08	47.77	38.52	5.90	36.76	9.50	0.00	45.93	74	-28.07	P	1.00
9848.08	37.24	38.52	5.90	36.76	9.50	0.00	35.40	54	-18.60	A	1.00

1. AF: Antenna Factor, Cable: Cable Loss, Pre-Amp: Preamplifier gain, Filter: High Pass Filter Insertion Loss (3.5GHz)
2. Analyzer setting P(Peak): RBW=1MHz, VBW=1MHz, A(Average): RBW=1MHz,VBW=10Hz
3. Dist : correction to extra plate reading to 3m specification distance 1m measurement distance = -9.5dB
4. The result basic equation calculation as follow :

$$\text{Level} = \text{Reading} + \text{AF} + \text{Cable} - \text{Preamp} + \text{Filter} - \text{Dist}, \text{Margin} = \text{Level} - \text{Limit}$$
5. The test limit is 3M limit.
6. The other emission levels were very low against the limit.
7. For 802.11g mode at 6Mbps.
8. For Antenna 1 (A530A531).



Ecom Sertech Corp.

Rm. 258, Bldg. 17, NO.195, Sec. 4 Chung Hsing Rd.,ChuTung Chen, Hsinchu, Taiwan 310, R.O.C
 TEL:886-3-5918012 FAX : 886-3-5825720

FCC ID : QDWWM168GI
 Report No. : ER03-11-068FRF
 Page 36 of 151

Test Requirement: 15.109 ,15.209

The frequency spectrum above 1 GHz was investigated. All emissions not reported below are more than 40 dB below the prescribed limits. Readings are both peak and average values.

Company	AirVast Technology Inc.	Test Date :	2003/12/23
Product Name	802.11g WLAN USB Module	Test By:	K. P. Pang
Model Name	WM168gi	TEMP&Humidity :	25.9°C , 45%

CH11 RX				Measurement Distance at 1m					Vertical polarity		
Freq.	Reading	AF	Cable	Pre-amp	Dist	Filter	Level	Limit	Margin	Mark	Height
(MHz)	(dBuV)	(dBuV)	(dB)	(dB)	dB	dB	(dBuV/m)	(dBuV/m)	(dB)	(P/Q/A)	(Meter)
4923.93	54.33	35.10	2.64	35.24	9.50	0.00	47.33	74	-26.67	P	1.00
4923.93	51.66	35.10	2.64	35.24	9.50	0.00	44.66	54	-9.34	A	1.00
7386.08	44.02	39.75	4.85	35.62	9.50	0.00	43.50	74	-30.50	P	1.00
7386.08	32.86	39.75	4.85	35.62	9.50	0.00	32.34	54	-21.66	A	1.00
9847.79	48.45	38.52	5.90	36.76	9.50	0.00	46.61	74	-27.39	P	1.00
9847.79	38.98	38.52	5.90	36.76	9.50	0.00	37.14	54	-16.86	A	1.00

- | |
|--|
| 1. AF: Antenna Factor, Cable: Cable Loss, Pre-Amp: Preamplifier gain, Filter: High Pass Filter Insertion Loss (3.5GHz) |
| 2. Analyzer setting P(Peak): RBW=1MHz, VBW=1MHz, A(Average): RBW=1MHz,VBW=10Hz |
| 3. Dist : correction to extra plate reading to 3m specification distance 1m measurement distance = -9.5dB |
| 4. The result basic equation calculation as follow : |
| Level = Reading + AF + Cable - Preamp + Filter - Dist, Margin = Level - Limit |
| 5. The test limit is 3M limit. |
| 6. The other emission levels were very low against the limit. |
| 7. For 802.11g mode at 6Mbps. |
| 8. For Antenna 1 (A530A531). |



Ecom Sertech Corp.

Rm. 258, Bldg. 17, NO.195, Sec. 4 Chung Hsing Rd.,ChuTung Chen, Hsinchu, Taiwan 310, R.O.C
 TEL:886-3-5918012 FAX : 886-3-5825720

FCC ID : QDWWM168GI
 Report No. : ER03-11-068FRF
 Page 37 of 151

Test Requirement: 15.109 ,15.209

The frequency spectrum above 1 GHz was investigated. All emissions not reported below are more than 40 dB below the prescribed limits. Readings are both peak and average values.

Company	AirVast Technology Inc.	Test Date :	2003/12/23
Product Name	802.11g WLAN USB Module	Test By:	K. P. Pang
Model Name	WM168gi	TEMP&Humidity :	28.1°C , 39%

CH1 RX				Measurement Distance at 1m				Horizontal polarity			
Freq.	Reading	AF	Cable	Pre-amp	Dist	Filter	Level	Limit	Margin	Mark	Height
(MHz)	(dBuV)	(dBuV)	(dB)	(dB)	dB	dB	(dBuV/m)	(dBuV/m)	(dB)	(P/Q/A)	(Meter)
4823.95	50.67	34.44	2.82	35.16	9.50	0.00	43.27	74	-30.73	P	1.00
4823.95	44.40	34.44	2.82	35.16	9.50	0.00	37.00	54	-17.00	A	1.00
7236.05	44.72	39.81	4.79	35.65	9.50	0.00	44.17	74	-29.83	P	1.00
7236.05	33.42	39.81	4.79	35.65	9.50	0.00	32.87	54	-21.13	A	1.00
9647.81	47.31	38.54	5.90	36.44	9.50	0.00	45.81	74	-28.19	P	1.00
9647.81	38.04	38.54	5.90	36.44	9.50	0.00	36.54	54	-17.46	A	1.00

- | |
|--|
| 1. AF: Antenna Factor, Cable: Cable Loss, Pre-Amp: Preamplifier gain, Filter: High Pass Filter Insertion Loss (3.5GHz) |
| 2. Analyzer setting P(Peak): RBW=1MHz, VBW=1MHz, A(Average): RBW=1MHz,VBW=10Hz |
| 3. Dist : correction to extra plate reading to 3m specification distance 1m measurement distance = -9.5dB |
| 4. The result basic equation calculation as follow : |
| $Level = Reading + AF + Cable - Preamp + Filter - Dist, Margin = Level - Limit$ |
| 5. The test limit is 3M limit. |
| 6. The other emission levels were very low against the limit. |
| 7. For 802.11b mode at 11Mbps. |
| 8. For Antenna 2 (A535). |



Ecom Sertech Corp.

Rm. 258, Bldg. 17, NO.195, Sec. 4 Chung Hsing Rd., ChuTung Chen, Hsinchu, Taiwan 310, R.O.C
 TEL:886-3-5918012 FAX : 886-3-5825720

FCC ID : QDWWM168GI
 Report No. : ER03-11-068FRF
 Page 38 of 151

Test Requirement: 15.109 ,15.209

The frequency spectrum above 1 GHz was investigated. All emissions not reported below are more than 40 dB below the prescribed limits. Readings are both peak and average values.

Company	AirVast Technology Inc.	Test Date :	2003/12/23
Product Name	802.11g WLAN USB Module	Test By:	K. P. Pang
Model Name	WM168gi	TEMP&Humidity :	28.1°C , 39%

CH1 RX				Measurement Distance at 1m					Vertical polarity			
Freq.	Reading	AF	Cable	Pre-amp	Dist	Filter	Level	Limit	Margin	Mark	Height	
(MHz)	(dBuV)	(dBuV)	(dB)	(dB)	dB	dB	(dBuV/m)	(dBuV/m)	(dB)	(P/Q/A)	(Meter)	
4823.93	51.61	34.44	2.82	35.16	9.50	0.00	44.21	74	-29.79	P	1.00	
4823.93	47.56	34.44	2.82	35.16	9.50	0.00	40.16	54	-13.84	A	1.00	
7236.10	45.37	39.81	4.79	35.65	9.50	0.00	44.82	74	-29.18	P	1.00	
7236.10	33.30	39.81	4.79	35.65	9.50	0.00	32.75	54	-21.25	A	1.00	
9647.91	48.43	38.54	5.90	36.44	9.50	0.00	46.93	74	-27.07	P	1.00	
9647.91	39.73	38.54	5.90	36.44	9.50	0.00	38.23	54	-15.77	A	1.00	

1. AF: Antenna Factor, Cable: Cable Loss, Pre-Amp: Preamplifier gain, Filter: High Pass Filter Insertion Loss (3.5GHz)
2. Analyzer setting P(Peak): RBW=1MHz, VBW=1MHz, A(Average): RBW=1MHz,VBW=10Hz
3. Dist : correction to extra plate reading to 3m specification distance 1m measurement distance = -9.5dB
4. The result basic equation calculation as follow :

$$\text{Level} = \text{Reading} + \text{AF} + \text{Cable} - \text{Preamp} + \text{Filter} - \text{Dist}, \text{Margin} = \text{Level} - \text{Limit}$$
5. The test limit is 3M limit.
6. The other emission levels were very low against the limit.
7. For 802.11b mode at 11Mbps.
8. For Antenna 2 (A535).



Ecom Sertech Corp.

Rm. 258, Bldg. 17, NO.195, Sec. 4 Chung Hsing Rd., ChuTung Chen, Hsinchu, Taiwan 310, R.O.C
 TEL:886-3-5918012 FAX : 886-3-5825720

FCC ID : QDWWM168GI
 Report No. : ER03-11-068FRF
 Page 39 of 151

Test Requirement: 15.109 ,15.209

The frequency spectrum above 1 GHz was investigated. All emissions not reported below are more than 40 dB below the prescribed limits. Readings are both peak and average values.

Company	AirVast Technology Inc.	Test Date :	2003/12/23
Product Name	802.11g WLAN USB Module	Test By:	K. P. Pang
Model Name	WM168gi	TEMP&Humidity :	28.1°C , 39%

CH6 RX				Measurement Distance at 1m				Horizontal polarity			
Freq.	Reading	AF	Cable	Pre-amp	Dist	Filter	Level	Limit	Margin	Mark	Height
(MHz)	(dBuV)	(dBuV)	(dB)	(dB)	dB	dB	(dBuV/m)	(dBuV/m)	(dB)	(P/Q/A)	(Meter)
4873.95	50.12	34.77	2.73	35.20	9.50	0.00	42.92	74	-31.08	P	1.00
4873.95	45.06	34.77	2.73	35.20	9.50	0.00	37.86	54	-16.14	A	1.00
7311.01	44.92	39.78	4.82	35.64	9.50	0.00	44.38	74	-29.62	P	1.00
7311.01	33.55	39.78	4.82	35.64	9.50	0.00	33.01	54	-20.99	A	1.00
9747.82	47.68	38.53	5.90	36.60	9.50	0.00	46.01	74	-27.99	P	1.00
9747.82	38.36	38.53	5.90	36.60	9.50	0.00	36.69	54	-17.31	A	1.00

1. AF: Antenna Factor, Cable: Cable Loss, Pre-Amp: Preamplifier gain, Filter: High Pass Filter Insertion Loss (3.5GHz)
2. Analyzer setting P(Peak): RBW=1MHz, VBW=1MHz, A(Average): RBW=1MHz,VBW=10Hz
3. Dist : correction to extra plate reading to 3m specification distance 1m measurement distance = -9.5dB
4. The result basic equation calculation as follow :

$$\text{Level} = \text{Reading} + \text{AF} + \text{Cable} - \text{Preamp} + \text{Filter} - \text{Dist}, \text{Margin} = \text{Level} - \text{Limit}$$
5. The test limit is 3M limit.
6. The other emission levels were very low against the limit.
7. For 802.11b mode at 11Mbps.
8. For Antenna 2 (A535).



Ecom Sertech Corp.

Rm. 258, Bldg. 17, NO.195, Sec. 4 Chung Hsing Rd., ChuTung Chen, Hsinchu, Taiwan 310, R.O.C
 TEL:886-3-5918012 FAX : 886-3-5825720

FCC ID : QDWWM168GI
 Report No. : ER03-11-068FRF
 Page 40 of 151

Test Requirement: 15.109 ,15.209

The frequency spectrum above 1 GHz was investigated. All emissions not reported below are more than 40 dB below the prescribed limits. Readings are both peak and average values.

Company	AirVast Technology Inc.	Test Date :	2003/12/23
Product Name	802.11g WLAN USB Module	Test By:	K. P. Pang
Model Name	WM168gi	TEMP&Humidity :	28.1°C , 39%

CH6 RX				Measurement Distance at 1m					Vertical polarity		
Freq.	Reading	AF	Cable	Pre-amp	Dist	Filter	Level	Limit	Margin	Mark	Height
(MHz)	(dBuV)	(dBuV)	(dB)	(dB)	dB	dB	(dBuV/m)	(dBuV/m)	(dB)	(P/Q/A)	(Meter)
4874.01	50.72	34.77	2.73	35.20	9.50	0.00	43.52	74	-30.48	P	1.00
4874.01	45.82	34.77	2.73	35.20	9.50	0.00	38.62	54	-15.38	A	1.00
7310.93	43.30	39.78	4.82	35.64	9.50	0.00	42.76	74	-31.24	P	1.00
7310.93	32.60	39.78	4.82	35.64	9.50	0.00	32.06	54	-21.94	A	1.00
9747.64	48.08	38.53	5.90	36.60	9.50	0.00	46.41	74	-27.59	P	1.00
9747.64	39.28	38.53	5.90	36.60	9.50	0.00	37.61	54	-16.39	A	1.00

1. AF: Antenna Factor, Cable: Cable Loss, Pre-Amp: Preamplifier gain, Filter: High Pass Filter Insertion Loss (3.5GHz)
2. Analyzer setting P(Peak): RBW=1MHz, VBW=1MHz, A(Average): RBW=1MHz,VBW=10Hz
3. Dist : correction to extra plate reading to 3m specification distance 1m measurement distance = -9.5dB
4. The result basic equation calculation as follow :

$$\text{Level} = \text{Reading} + \text{AF} + \text{Cable} - \text{Preamp} + \text{Filter} - \text{Dist}, \text{Margin} = \text{Level} - \text{Limit}$$
5. The test limit is 3M limit.
6. The other emission levels were very low against the limit.
7. For 802.11b mode at 11Mbps.
8. For Antenna 2 (A535).



Ecom Sertech Corp.

Rm. 258, Bldg. 17, NO.195, Sec. 4 Chung Hsing Rd.,ChuTung Chen, Hsinchu, Taiwan 310, R.O.C
 TEL:886-3-5918012 FAX : 886-3-5825720

FCC ID : QDWWM168GI
 Report No. : ER03-11-068FRF
 Page 41 of 151

Test Requirement: 15.109 ,15.209

The frequency spectrum above 1 GHz was investigated. All emissions not reported below are more than 40 dB below the prescribed limits. Readings are both peak and average values.

Company	AirVast Technology Inc.	Test Date :	2003/12/23
Product Name	802.11g WLAN USB Module	Test By:	K. P. Pang
Model Name	WM168gi	TEMP&Humidity :	28.1°C , 39%

CH11 RX				Measurement Distance at 1m				Horizontal polarity			
Freq.	Reading	AF	Cable	Pre-amp	Dist	Filter	Level	Limit	Margin	Mark	Height
(MHz)	(dBuV)	(dBuV)	(dB)	(dB)	dB	dB	(dBuV/m)	(dBuV/m)	(dB)	(P/Q/A)	(Meter)
4923.80	50.12	35.10	2.64	35.24	9.50	0.00	43.12	74	-30.88	P	1.00
4923.80	45.00	35.10	2.64	35.24	9.50	0.00	38.00	54	-16.00	A	1.00
7386.26	44.07	39.75	4.85	35.62	9.50	0.00	43.55	74	-30.45	P	1.00
7386.26	33.08	39.75	4.85	35.62	9.50	0.00	32.56	54	-21.44	A	1.00
9847.84	47.76	38.52	5.90	36.76	9.50	0.00	45.92	74	-28.08	P	1.00
9847.84	39.13	38.52	5.90	36.76	9.50	0.00	37.29	54	-16.71	A	1.00

1. AF: Antenna Factor, Cable: Cable Loss, Pre-Amp: Preamplifier gain, Filter: High Pass Filter Insertion Loss (3.5GHz)
2. Analyzer setting P(Peak): RBW=1MHz, VBW=1MHz, A(Average): RBW=1MHz,VBW=10Hz
3. Dist : correction to extra plate reading to 3m specification distance 1m measurement distance = -9.5dB
4. The result basic equation calculation as follow :

$$\text{Level} = \text{Reading} + \text{AF} + \text{Cable} - \text{Preamp} + \text{Filter} - \text{Dist}, \text{Margin} = \text{Level} - \text{Limit}$$
5. The test limit is 3M limit.
6. The other emission levels were very low against the limit.
7. For 802.11b mode at 11Mbps.
8. For Antenna 2 (A535).



Ecom Sertech Corp.

Rm. 258, Bldg. 17, NO.195, Sec. 4 Chung Hsing Rd., ChuTung Chen, Hsinchu, Taiwan 310, R.O.C
 TEL:886-3-5918012 FAX : 886-3-5825720

FCC ID : QDWWM168GI
 Report No. : ER03-11-068FRF
 Page 42 of 151

Test Requirement: 15.109 ,15.209

The frequency spectrum above 1 GHz was investigated. All emissions not reported below are more than 40 dB below the prescribed limits. Readings are both peak and average values.

Company	AirVast Technology Inc.	Test Date :	2003/12/23
Product Name	802.11g WLAN USB Module	Test By:	K. P. Pang
Model Name	WM168gi	TEMP&Humidity :	28.1°C , 39%

CH11 RX				Measurement Distance at 1m					Vertical polarity		
Freq.	Reading	AF	Cable	Pre-amp	Dist	Filter	Level	Limit	Margin	Mark	Height
(MHz)	(dBuV)	(dBuV)	(dB)	(dB)	dB	dB	(dBuV/m)	(dBuV/m)	(dB)	(P/Q/A)	(Meter)
4923.78	51.69	35.10	2.64	35.24	9.50	0.00	44.69	74	-29.31	P	1.00
4923.78	47.89	35.10	2.64	35.24	9.50	0.00	40.89	54	-13.11	A	1.00
7386.11	42.51	39.75	4.85	35.62	9.50	0.00	41.99	74	-32.01	P	1.00
7386.11	32.10	39.75	4.85	35.62	9.50	0.00	31.58	54	-22.42	A	1.00
9848.06	48.85	38.52	5.90	36.76	9.50	0.00	47.01	74	-26.99	P	1.00
9848.06	40.10	38.52	5.90	36.76	9.50	0.00	38.26	54	-15.74	A	1.00

1. AF: Antenna Factor, Cable: Cable Loss, Pre-Amp: Preamplifier gain, Filter: High Pass Filter Insertion Loss (3.5GHz)
2. Analyzer setting P(Peak): RBW=1MHz, VBW=1MHz, A(Average): RBW=1MHz,VBW=10Hz
3. Dist : correction to extra plate reading to 3m specification distance 1m measurement distance = -9.5dB
4. The result basic equation calculation as follow :

$$\text{Level} = \text{Reading} + \text{AF} + \text{Cable} - \text{Preamp} + \text{Filter} - \text{Dist}, \text{Margin} = \text{Level} - \text{Limit}$$
5. The test limit is 3M limit.
6. The other emission levels were very low against the limit.
7. For 802.11b mode at 11Mbps.
8. For Antenna 2 (A535).



Ecom Sertech Corp.

Rm. 258, Bldg. 17, NO.195, Sec. 4 Chung Hsing Rd., ChuTung Chen, Hsinchu, Taiwan 310, R.O.C
 TEL:886-3-5918012 FAX : 886-3-5825720

FCC ID : QDWWM168GI
 Report No. : ER03-11-068FRF
 Page 43 of 151

Test Requirement: 15.109 ,15.209

The frequency spectrum above 1 GHz was investigated. All emissions not reported below are more than 40 dB below the prescribed limits. Readings are both peak and average values.

Company	AirVast Technology Inc.	Test Date :	2003/12/23
Product Name	802.11g WLAN USB Module	Test By:	K. P. Pang
Model Name	WM168gi	TEMP&Humidity :	25.9°C , 43%

CH1 RX				Measurement Distance at 1m				Horizontal polarity			
Freq.	Reading	AF	Cable	Pre-amp	Dist	Filter	Level	Limit	Margin	Mark	Height
(MHz)	(dBuV)	(dBuV)	(dB)	(dB)	dB	dB	(dBuV/m)	(dBuV/m)	(dB)	(P/Q/A)	(Meter)
4824.01	50.90	34.44	2.82	35.16	9.50	0.00	43.50	74	-30.50	P	1.00
4824.01	44.87	34.44	2.82	35.16	9.50	0.00	37.47	54	-16.53	A	1.00
7235.85	44.70	39.81	4.79	35.65	9.50	0.00	44.15	74	-29.85	P	1.00
7235.85	33.70	39.81	4.79	35.65	9.50	0.00	33.15	54	-20.85	A	1.00
9648.00	46.69	38.54	5.90	36.44	9.50	0.00	45.19	74	-28.81	P	1.00
9648.00	36.78	38.54	5.90	36.44	9.50	0.00	35.28	54	-18.72	A	1.00

1. AF: Antenna Factor, Cable: Cable Loss, Pre-Amp: Preamplifier gain, Filter: High Pass Filter Insertion Loss (3.5GHz)
2. Analyzer setting P(Peak): RBW=1MHz, VBW=1MHz, A(Average): RBW=1MHz,VBW=10Hz
3. Dist : correction to extra plate reading to 3m specification distance 1m measurement distance = -9.5dB
4. The result basic equation calculation as follow :

$$\text{Level} = \text{Reading} + \text{AF} + \text{Cable} - \text{Preamp} + \text{Filter} - \text{Dist}, \text{Margin} = \text{Level} - \text{Limit}$$
5. The test limit is 3M limit.
6. The other emission levels were very low against the limit.
7. For 802.11g mode at 6Mbps.
8. For Antenna 2 (A535).



Ecom Sertech Corp.

Rm. 258, Bldg. 17, NO.195, Sec. 4 Chung Hsing Rd., ChuTung Chen, Hsinchu, Taiwan 310, R.O.C
 TEL:886-3-5918012 FAX : 886-3-5825720

FCC ID : QDWWM168GI
 Report No. : ER03-11-068FRF
 Page 44 of 151

Test Requirement: 15.109 ,15.209

The frequency spectrum above 1 GHz was investigated. All emissions not reported below are more than 40 dB below the prescribed limits. Readings are both peak and average values.

Company	AirVast Technology Inc.	Test Date :	2003/12/23
Product Name	802.11g WLAN USB Module	Test By:	K. P. Pang
Model Name	WM168gi	TEMP&Humidity :	25.9°C , 43%

CH1 RX				Measurement Distance at 1m					Vertical polarity		
Freq.	Reading	AF	Cable	Pre-amp	Dist	Filter	Level	Limit	Margin	Mark	Height
(MHz)	(dBuV)	(dBuV)	(dB)	(dB)	dB	dB	(dBuV/m)	(dBuV/m)	(dB)	(P/Q/A)	(Meter)
4823.91	50.15	34.44	2.82	35.16	9.50	0.00	42.75	74	-31.25	P	1.00
4823.91	45.08	34.44	2.82	35.16	9.50	0.00	37.68	54	-16.32	A	1.00
7235.86	44.14	39.81	4.79	35.65	9.50	0.00	43.59	74	-30.41	P	1.00
7235.86	32.22	39.81	4.79	35.65	9.50	0.00	31.67	54	-22.33	A	1.00
9647.94	48.04	38.54	5.90	36.44	9.50	0.00	46.54	74	-27.46	P	1.00
9647.94	39.65	38.54	5.90	36.44	9.50	0.00	38.15	54	-15.85	A	1.00

1. AF: Antenna Factor, Cable: Cable Loss, Pre-Amp: Preamplifier gain, Filter: High Pass Filter Insertion Loss (3.5GHz)
2. Analyzer setting P(Peak): RBW=1MHz, VBW=1MHz, A(Average): RBW=1MHz,VBW=10Hz
3. Dist : correction to extra plate reading to 3m specification distance 1m measurement distance = -9.5dB
4. The result basic equation calculation as follow :

$$\text{Level} = \text{Reading} + \text{AF} + \text{Cable} - \text{Preamp} + \text{Filter} - \text{Dist}, \text{Margin} = \text{Level} - \text{Limit}$$
5. The test limit is 3M limit.
6. The other emission levels were very low against the limit.
7. For 802.11g mode at 6Mbps.
8. For Antenna 2 (A535).



Ecom Sertech Corp.

Rm. 258, Bldg. 17, NO.195, Sec. 4 Chung Hsing Rd., ChuTung Chen, Hsinchu, Taiwan 310, R.O.C
 TEL:886-3-5918012 FAX : 886-3-5825720

FCC ID : QDWWM168GI
 Report No. : ER03-11-068FRF
 Page 45 of 151

Test Requirement: 15.109 ,15.209

The frequency spectrum above 1 GHz was investigated. All emissions not reported below are more than 40 dB below the prescribed limits. Readings are both peak and average values.

Company	AirVast Technology Inc.	Test Date :	2003/12/23
Product Name	802.11g WLAN USB Module	Test By:	K. P. Pang
Model Name	WM168gi	TEMP&Humidity :	25.9°C , 43%

CH6 RX				Measurement Distance at 1m					Horizontal polarity		
Freq.	Reading	AF	Cable	Pre-amp	Dist	Filter	Level	Limit	Margin	Mark	Height
(MHz)	(dBuV)	(dBuV)	(dB)	(dB)	dB	dB	(dBuV/m)	(dBuV/m)	(dB)	(P/Q/A)	(Meter)
4874.09	49.91	34.77	2.73	35.20	9.50	0.00	42.71	74	-31.29	P	1.00
4874.09	44.52	34.77	2.73	35.20	9.50	0.00	37.32	54	-16.68	A	1.00
7310.85	43.47	39.78	4.82	35.64	9.50	0.00	42.93	74	-31.07	P	1.00
7310.85	32.79	39.78	4.82	35.64	9.50	0.00	32.25	54	-21.75	A	1.00
9748.03	46.82	38.53	5.90	36.60	9.50	0.00	45.15	74	-28.85	P	1.00
9748.03	36.57	38.53	5.90	36.60	9.50	0.00	34.90	54	-19.10	A	1.00

1. AF: Antenna Factor, Cable: Cable Loss, Pre-Amp: Preamplifier gain, Filter: High Pass Filter Insertion Loss (3.5GHz)
2. Analyzer setting P(Peak): RBW=1MHz, VBW=1MHz, A(Average): RBW=1MHz,VBW=10Hz
3. Dist : correction to extra plate reading to 3m specification distance 1m measurement distance = -9.5dB
4. The result basic equation calculation as follow :

$$\text{Level} = \text{Reading} + \text{AF} + \text{Cable} - \text{Preamp} + \text{Filter} - \text{Dist}, \text{Margin} = \text{Level} - \text{Limit}$$
5. The test limit is 3M limit.
6. The other emission levels were very low against the limit.
7. For 802.11g mode at 6Mbps.
8. For Antenna 2 (A535).



Ecom Sertech Corp.

Rm. 258, Bldg. 17, NO.195, Sec. 4 Chung Hsing Rd.,ChuTung Chen, Hsinchu, Taiwan 310, R.O.C
 TEL:886-3-5918012 FAX : 886-3-5825720

FCC ID : QDWWM168GI
 Report No. : ER03-11-068FRF
 Page 46 of 151

Test Requirement: 15.109 ,15.209

The frequency spectrum above 1 GHz was investigated. All emissions not reported below are more than 40 dB below the prescribed limits. Readings are both peak and average values.

Company	AirVast Technology Inc.	Test Date :	2003/12/23
Product Name	802.11g WLAN USB Module	Test By:	K. P. Pang
Model Name	WM168gi	TEMP&Humidity :	25.9°C , 43%

CH6 RX				Measurement Distance at 1m					Vertical polarity		
Freq.	Reading	AF	Cable	Pre-amp	Dist	Filter	Level	Limit	Margin	Mark	Height
(MHz)	(dBuV)	(dBuV)	(dB)	(dB)	dB	dB	(dBuV/m)	(dBuV/m)	(dB)	(P/Q/A)	(Meter)
4873.84	50.59	34.77	2.73	35.20	9.50	0.00	43.39	74	-30.61	P	1.00
4873.84	46.33	34.77	2.73	35.20	9.50	0.00	39.13	54	-14.87	A	1.00
7310.88	44.82	39.78	4.82	35.64	9.50	0.00	44.28	74	-29.72	P	1.00
7310.88	33.99	39.78	4.82	35.64	9.50	0.00	33.45	54	-20.55	A	1.00
9747.89	48.38	38.53	5.90	36.60	9.50	0.00	46.71	74	-27.29	P	1.00
9747.89	41.22	38.53	5.90	36.60	9.50	0.00	39.55	54	-14.45	A	1.00

- | |
|--|
| 1. AF: Antenna Factor, Cable: Cable Loss, Pre-Amp: Preamplifier gain, Filter: High Pass Filter Insertion Loss (3.5GHz) |
| 2. Analyzer setting P(Peak): RBW=1MHz, VBW=1MHz, A(Average): RBW=1MHz,VBW=10Hz |
| 3. Dist : correction to extra plate reading to 3m specification distance 1m measurement distance = -9.5dB |
| 4. The result basic equation calculation as follow : |
| Level = Reading + AF + Cable - Preamp + Filter - Dist, Margin = Level - Limit |
| 5. The test limit is 3M limit. |
| 6. The other emission levels were very low against the limit. |
| 7. For 802.11g mode at 6Mbps. |
| 8. For Antenna 2 (A535). |



Ecom Sertech Corp.

Rm. 258, Bldg. 17, NO.195, Sec. 4 Chung Hsing Rd., ChuTung Chen, Hsinchu, Taiwan 310, R.O.C
 TEL:886-3-5918012 FAX : 886-3-5825720

FCC ID : QDWWM168GI
 Report No. : ER03-11-068FRF
 Page 47 of 151

Test Requirement: 15.109 ,15.209

The frequency spectrum above 1 GHz was investigated. All emissions not reported below are more than 40 dB below the prescribed limits. Readings are both peak and average values.

Company	AirVast Technology Inc.	Test Date :	2003/12/23
Product Name	802.11g WLAN USB Module	Test By:	K. P. Pang
Model Name	WM168gi	TEMP&Humidity :	25.9°C , 43%

CH11 RX				Measurement Distance at 1m					Horizontal polarity		
Freq.	Reading	AF	Cable	Pre-amp	Dist	Filter	Level	Limit	Margin	Mark	Height
(MHz)	(dBuV)	(dBuV)	(dB)	(dB)	dB	dB	(dBuV/m)	(dBuV/m)	(dB)	(P/Q/A)	(Meter)
4923.96	51.07	35.10	2.64	35.24	9.50	0.00	44.07	74	-29.93	P	1.00
4923.96	46.00	35.10	2.64	35.24	9.50	0.00	39.00	54	-15.00	A	1.00
7385.70	43.15	39.75	4.85	35.62	9.50	0.00	42.63	74	-31.37	P	1.00
7385.70	32.49	39.75	4.85	35.62	9.50	0.00	31.97	54	-22.03	A	1.00
9847.93	47.60	38.52	5.90	36.76	9.50	0.00	45.76	74	-28.24	P	1.00
9847.93	36.19	38.52	5.90	36.76	9.50	0.00	34.35	54	-19.65	A	1.00

- | |
|--|
| 1. AF: Antenna Factor, Cable: Cable Loss, Pre-Amp: Preamplifier gain, Filter: High Pass Filter Insertion Loss (3.5GHz) |
| 2. Analyzer setting P(Peak): RBW=1MHz, VBW=1MHz, A(Average): RBW=1MHz,VBW=10Hz |
| 3. Dist : correction to extra plate reading to 3m specification distance 1m measurement distance = -9.5dB |
| 4. The result basic equation calculation as follow : |
| Level = Reading + AF + Cable - Preamp + Filter - Dist, Margin = Level - Limit |
| 5. The test limit is 3M limit. |
| 6. The other emission levels were very low against the limit. |
| 7. For 802.11g mode at 6Mbps. |
| 8. For Antenna 2 (A535). |



Ecom Sertech Corp.

Rm. 258, Bldg. 17, NO.195, Sec. 4 Chung Hsing Rd.,ChuTung Chen, Hsinchu, Taiwan 310, R.O.C
 TEL:886-3-5918012 FAX : 886-3-5825720

FCC ID : QDWWM168GI
 Report No. : ER03-11-068FRF
 Page 48 of 151

Test Requirement: 15.109 ,15.209

The frequency spectrum above 1 GHz was investigated. All emissions not reported below are more than 40 dB below the prescribed limits. Readings are both peak and average values.

Company	AirVast Technology Inc.	Test Date :	2003/12/23
Product Name	802.11g WLAN USB Module	Test By:	K. P. Pang
Model Name	WM168gi	TEMP&Humidity :	25.9°C , 43%

CH11 RX				Measurement Distance at 1m					Vertical polarity		
Freq.	Reading	AF	Cable	Pre-amp	Dist	Filter	Level	Limit	Margin	Mark	Height
(MHz)	(dBuV)	(dBuV)	(dB)	(dB)	dB	dB	(dBuV/m)	(dBuV/m)	(dB)	(P/Q/A)	(Meter)
4923.96	53.33	35.10	2.64	35.24	9.50	0.00	46.33	74	-27.67	P	1.00
4923.96	50.06	35.10	2.64	35.24	9.50	0.00	43.06	54	-10.94	A	1.00
7386.11	44.51	39.75	4.85	35.62	9.50	0.00	43.99	74	-30.01	P	1.00
7386.11	33.57	39.75	4.85	35.62	9.50	0.00	33.05	54	-20.95	A	1.00
9847.85	49.10	38.52	5.90	36.76	9.50	0.00	47.26	74	-26.74	P	1.00
9847.85	41.57	38.52	5.90	36.76	9.50	0.00	39.73	54	-14.27	A	1.00

- | |
|--|
| 1. AF: Antenna Factor, Cable: Cable Loss, Pre-Amp: Preamplifier gain, Filter: High Pass Filter Insertion Loss (3.5GHz) |
| 2. Analyzer setting P(Peak): RBW=1MHz, VBW=1MHz, A(Average): RBW=1MHz,VBW=10Hz |
| 3. Dist : correction to extra plate reading to 3m specification distance 1m measurement distance = -9.5dB |
| 4. The result basic equation calculation as follow : |
| Level = Reading + AF + Cable - Preamp + Filter - Dist, Margin = Level - Limit |
| 5. The test limit is 3M limit. |
| 6. The other emission levels were very low against the limit. |
| 7. For 802.11g mode at 6Mbps. |
| 8. For Antenna 2 (A535). |



Ecom Sertech Corp.

Rm. 258, Bldg. 17, NO.195, Sec. 4 Chung Hsing Rd.,ChuTung Chen, Hsinchu, Taiwan 310, R.O.C
 TEL:886-3-5918012 FAX : 886-3-5825720

FCC ID : QDWWM168GI
 Report No. : ER03-11-068FRF
 Page 49 of 151

Test Requirement: 15.109 ,15.209

The frequency spectrum above 1 GHz was investigated. All emissions not reported below are more than 40 dB below the prescribed limits. Readings are both peak and average values.

Company	AirVast Technology Inc.	Test Date :	2003/12/20
Product Name	802.11g WLAN USB Module	Test By:	K. P. Pang
Model Name	WM168gi	TEMP&Humidity :	13.8°C , 50%

CH1 RX				Measurement Distance at 1m				Horizontal polarity			
Freq.	Reading	AF	Cable	Pre-amp	Dist	Filter	Level	Limit	Margin	Mark	Height
(MHz)	(dBuV)	(dBuV)	(dB)	(dB)	dB	dB	(dBuV/m)	(dBuV/m)	(dB)	(P/Q/A)	(Meter)
4824.04	52.41	34.44	2.82	35.16	9.50	0.00	45.01	74	-28.99	P	1.00
4824.04	48.54	34.44	2.82	35.16	9.50	0.00	41.14	54	-12.86	A	1.00
7236.08	45.55	39.81	4.79	35.65	9.50	0.00	45.00	74	-29.00	P	1.00
7236.08	34.09	39.81	4.79	35.65	9.50	0.00	33.54	54	-20.46	A	1.00
9647.68	47.46	38.54	5.90	36.44	9.50	0.00	45.96	74	-28.04	P	1.00
9647.68	36.56	38.54	5.90	36.44	9.50	0.00	35.06	54	-18.94	A	1.00

- | |
|--|
| 1. AF: Antenna Factor, Cable: Cable Loss, Pre-Amp: Preamplifier gain, Filter: High Pass Filter Insertion Loss (3.5GHz) |
| 2. Analyzer setting P(Peak): RBW=1MHz, VBW=1MHz, A(Average): RBW=1MHz,VBW=10Hz |
| 3. Dist : correction to extra plate reading to 3m specification distance 1m measurement distance = -9.5dB |
| 4. The result basic equation calculation as follow : |
| $Level = Reading + AF + Cable - Preamp + Filter - Dist, Margin = Level - Limit$ |
| 5. The test limit is 3M limit. |
| 6. The other emission levels were very low against the limit. |
| 7. For 802.11b mode at 11Mbps. |
| 8. For Antenna 3 (A800). |



Ecom Sertech Corp.

Rm. 258, Bldg. 17, NO.195, Sec. 4 Chung Hsing Rd.,ChuTung Chen, Hsinchu, Taiwan 310, R.O.C
 TEL:886-3-5918012 FAX : 886-3-5825720

FCC ID : QDWWM168GI
 Report No. : ER03-11-068FRF
 Page 50 of 151

Test Requirement: 15.109 ,15.209

The frequency spectrum above 1 GHz was investigated. All emissions not reported below are more than 40 dB below the prescribed limits. Readings are both peak and average values.

Company	AirVast Technology Inc.	Test Date :	2003/12/20
Product Name	802.11g WLAN USB Module	Test By:	K. P. Pang
Model Name	WM168gi	TEMP&Humidity :	13.8°C , 50%

CH1 RX				Measurement Distance at 1m					Vertical polarity		
Freq.	Reading	AF	Cable	Pre-amp	Dist	Filter	Level	Limit	Margin	Mark	Height
(MHz)	(dBuV)	(dBuV)	(dB)	(dB)	dB	dB	(dBuV/m)	(dBuV/m)	(dB)	(P/Q/A)	(Meter)
4823.85	54.79	34.44	2.82	35.16	9.50	0.00	47.39	74	-26.61	P	1.00
4823.85	52.00	34.44	2.82	35.16	9.50	0.00	44.60	54	-9.40	A	1.00
7236.01	44.19	39.81	4.79	35.65	9.50	0.00	43.64	74	-30.36	P	1.00
7236.01	33.42	39.81	4.79	35.65	9.50	0.00	32.87	54	-21.13	A	1.00
9647.85	48.16	38.54	5.90	36.44	9.50	0.00	46.66	74	-27.34	P	1.00
9647.85	39.50	38.54	5.90	36.44	9.50	0.00	38.00	54	-16.00	A	1.00

1. AF: Antenna Factor, Cable: Cable Loss, Pre-Amp: Preamplifier gain, Filter: High Pass Filter Insertion Loss (3.5GHz)
2. Analyzer setting P(Peak): RBW=1MHz, VBW=1MHz, A(Average): RBW=1MHz,VBW=10Hz
3. Dist : correction to extra plate reading to 3m specification distance 1m measurement distance = -9.5dB
4. The result basic equation calculation as follow :

$$\text{Level} = \text{Reading} + \text{AF} + \text{Cable} - \text{Preamp} + \text{Filter} - \text{Dist}, \text{Margin} = \text{Level} - \text{Limit}$$
5. The test limit is 3M limit.
6. The other emission levels were very low against the limit.
7. For 802.11b mode at 11Mbps.
8. For Antenna 3 (A800).



Ecom Sertech Corp.

Rm. 258, Bldg. 17, NO.195, Sec. 4 Chung Hsing Rd., ChuTung Chen, Hsinchu, Taiwan 310, R.O.C
 TEL:886-3-5918012 FAX : 886-3-5825720

FCC ID : QDWWM168GI
 Report No. : ER03-11-068FRF
 Page 51 of 151

Test Requirement: 15.109 ,15.209

The frequency spectrum above 1 GHz was investigated. All emissions not reported below are more than 40 dB below the prescribed limits. Readings are both peak and average values.

Company	AirVast Technology Inc.	Test Date :	2003/12/20
Product Name	802.11g WLAN USB Module	Test By:	K. P. Pang
Model Name	WM168gi	TEMP&Humidity :	13.8°C , 50%

CH6 RX				Measurement Distance at 1m				Horizontal polarity			
Freq.	Reading	AF	Cable	Pre-amp	Dist	Filter	Level	Limit	Margin	Mark	Height
(MHz)	(dBuV)	(dBuV)	(dB)	(dB)	dB	dB	(dBuV/m)	(dBuV/m)	(dB)	(P/Q/A)	(Meter)
4873.80	52.27	34.77	2.73	35.20	9.50	0.00	45.07	74	-28.93	P	1.00
4873.80	48.44	34.77	2.73	35.20	9.50	0.00	41.24	54	-12.76	A	1.00
7311.07	44.10	39.78	4.82	35.64	9.50	0.00	43.56	74	-30.44	P	1.00
7311.07	33.31	39.78	4.82	35.64	9.50	0.00	32.77	54	-21.23	A	1.00
9747.76	47.42	38.53	5.90	36.60	9.50	0.00	45.75	74	-28.25	P	1.00
9747.76	37.29	38.53	5.90	36.60	9.50	0.00	35.62	54	-18.38	A	1.00

- | |
|--|
| 1. AF: Antenna Factor, Cable: Cable Loss, Pre-Amp: Preamplifier gain, Filter: High Pass Filter Insertion Loss (3.5GHz) |
| 2. Analyzer setting P(Peak): RBW=1MHz, VBW=1MHz, A(Average): RBW=1MHz,VBW=10Hz |
| 3. Dist : correction to extra plate reading to 3m specification distance 1m measurement distance = -9.5dB |
| 4. The result basic equation calculation as follow : |
| Level = Reading + AF + Cable - Preamp + Filter - Dist, Margin = Level - Limit |
| 5. The test limit is 3M limit. |
| 6. The other emission levels were very low against the limit. |
| 7. For 802.11b mode at 11Mbps. |
| 8. For Antenna 3 (A800). |



Ecom Sertech Corp.

Rm. 258, Bldg. 17, NO.195, Sec. 4 Chung Hsing Rd., ChuTung Chen, Hsinchu, Taiwan 310, R.O.C
 TEL:886-3-5918012 FAX : 886-3-5825720

FCC ID : QDWWM168GI
 Report No. : ER03-11-068FRF
 Page 52 of 151

Test Requirement: 15.109 ,15.209

The frequency spectrum above 1 GHz was investigated. All emissions not reported below are more than 40 dB below the prescribed limits. Readings are both peak and average values.

Company	AirVast Technology Inc.	Test Date :	2003/12/20
Product Name	802.11g WLAN USB Module	Test By:	K. P. Pang
Model Name	WM168gi	TEMP&Humidity :	13.8°C , 50%

CH6 RX				Measurement Distance at 1m					Vertical polarity			
Freq.	Reading	AF	Cable	Pre-amp	Dist	Filter	Level	Limit	Margin	Mark	Height	
(MHz)	(dBuV)	(dBuV)	(dB)	(dB)	dB	dB	(dBuV/m)	(dBuV/m)	(dB)	(P/Q/A)	(Meter)	
4873.88	55.45	34.77	2.73	35.20	9.50	0.00	48.25	74	-25.75	P	1.00	
4873.88	52.83	34.77	2.73	35.20	9.50	0.00	45.63	54	-8.37	A	1.00	
7311.18	46.40	39.78	4.82	35.64	9.50	0.00	45.86	74	-28.14	P	1.00	
7311.18	34.09	39.78	4.82	35.64	9.50	0.00	33.55	54	-20.45	A	1.00	
9747.79	48.63	38.53	5.90	36.60	9.50	0.00	46.96	74	-27.04	P	1.00	
9747.79	39.71	38.53	5.90	36.60	9.50	0.00	38.04	54	-15.96	A	1.00	

1. AF: Antenna Factor, Cable: Cable Loss, Pre-Amp: Preamplifier gain, Filter: High Pass Filter Insertion Loss (3.5GHz)
2. Analyzer setting P(Peak): RBW=1MHz, VBW=1MHz, A(Average): RBW=1MHz,VBW=10Hz
3. Dist : correction to extra plate reading to 3m specification distance 1m measurement distance = -9.5dB
4. The result basic equation calculation as follow :

$$\text{Level} = \text{Reading} + \text{AF} + \text{Cable} - \text{Preamp} + \text{Filter} - \text{Dist}, \text{Margin} = \text{Level} - \text{Limit}$$
5. The test limit is 3M limit.
6. The other emission levels were very low against the limit.
7. For 802.11b mode at 11Mbps.
8. For Antenna 3 (A800).



Ecom Sertech Corp.

Rm. 258, Bldg. 17, NO.195, Sec. 4 Chung Hsing Rd., ChuTung Chen, Hsinchu, Taiwan 310, R.O.C
 TEL:886-3-5918012 FAX : 886-3-5825720

FCC ID : QDWWM168GI
 Report No. : ER03-11-068FRF
 Page 53 of 151

Test Requirement: 15.109 ,15.209

The frequency spectrum above 1 GHz was investigated. All emissions not reported below are more than 40 dB below the prescribed limits. Readings are both peak and average values.

Company	AirVast Technology Inc.	Test Date :	2003/12/20
Product Name	802.11g WLAN USB Module	Test By:	K. P. Pang
Model Name	WM168gi	TEMP&Humidity :	13.8°C , 50%

CH11 RX				Measurement Distance at 1m				Horizontal polarity			
Freq.	Reading	AF	Cable	Pre-amp	Dist	Filter	Level	Limit	Margin	Mark	Height
(MHz)	(dBuV)	(dBuV)	(dB)	(dB)	dB	dB	(dBuV/m)	(dBuV/m)	(dB)	(P/Q/A)	(Meter)
4923.98	52.09	35.10	2.64	35.24	9.50	0.00	45.09	74	-28.91	P	1.00
4923.98	48.33	35.10	2.64	35.24	9.50	0.00	41.33	54	-12.67	A	1.00
7386.07	45.36	39.75	4.85	35.62	9.50	0.00	44.84	74	-29.16	P	1.00
7386.07	34.47	39.75	4.85	35.62	9.50	0.00	33.95	54	-20.05	A	1.00
9847.94	47.66	38.52	5.90	36.76	9.50	0.00	45.82	74	-28.18	P	1.00
9847.94	36.03	38.52	5.90	36.76	9.50	0.00	34.19	54	-19.81	A	1.00

- | |
|--|
| 1. AF: Antenna Factor, Cable: Cable Loss, Pre-Amp: Preamplifier gain, Filter: High Pass Filter Insertion Loss (3.5GHz) |
| 2. Analyzer setting P(Peak): RBW=1MHz, VBW=1MHz, A(Average): RBW=1MHz,VBW=10Hz |
| 3. Dist : correction to extra plate reading to 3m specification distance 1m measurement distance = -9.5dB |
| 4. The result basic equation calculation as follow : |
| Level = Reading + AF + Cable - Preamp + Filter - Dist, Margin = Level - Limit |
| 5. The test limit is 3M limit. |
| 6. The other emission levels were very low against the limit. |
| 7. For 802.11b mode at 11Mbps. |
| 8. For Antenna 3 (A800). |



Ecom Sertech Corp.

Rm. 258, Bldg. 17, NO.195, Sec. 4 Chung Hsing Rd., ChuTung Chen, Hsinchu, Taiwan 310, R.O.C
 TEL:886-3-5918012 FAX : 886-3-5825720

FCC ID : QDWWM168GI
 Report No. : ER03-11-068FRF
 Page 54 of 151

Test Requirement: 15.109 ,15.209

The frequency spectrum above 1 GHz was investigated. All emissions not reported below are more than 40 dB below the prescribed limits. Readings are both peak and average values.

Company	AirVast Technology Inc.	Test Date :	2003/12/20
Product Name	802.11g WLAN USB Module	Test By:	K. P. Pang
Model Name	WM168gi	TEMP&Humidity :	13.8°C , 50%

CH11 RX				Measurement Distance at 1m					Vertical polarity		
Freq.	Reading	AF	Cable	Pre-amp	Dist	Filter	Level	Limit	Margin	Mark	Height
(MHz)	(dBuV)	(dBuV)	(dB)	(dB)	dB	dB	(dBuV/m)	(dBuV/m)	(dB)	(P/Q/A)	(Meter)
4923.95	56.09	35.10	2.64	35.24	9.50	0.00	49.09	74	-24.91	P	1.00
4923.95	53.47	35.10	2.64	35.24	9.50	0.00	46.47	54	-7.53	A	1.00
7386.09	44.43	39.75	4.85	35.62	9.50	0.00	43.91	74	-30.09	P	1.00
7386.09	32.99	39.75	4.85	35.62	9.50	0.00	32.47	54	-21.53	A	1.00
9848.13	48.75	38.52	5.90	36.76	9.50	0.00	46.91	74	-27.09	P	1.00
9848.13	39.23	38.52	5.90	36.76	9.50	0.00	37.39	54	-16.61	A	1.00

1. AF: Antenna Factor, Cable: Cable Loss, Pre-Amp: Preamplifier gain, Filter: High Pass Filter Insertion Loss (3.5GHz)
2. Analyzer setting P(Peak): RBW=1MHz, VBW=1MHz, A(Average): RBW=1MHz,VBW=10Hz
3. Dist : correction to extra plate reading to 3m specification distance 1m measurement distance = -9.5dB
4. The result basic equation calculation as follow :

$$\text{Level} = \text{Reading} + \text{AF} + \text{Cable} - \text{Preamp} + \text{Filter} - \text{Dist}, \text{Margin} = \text{Level} - \text{Limit}$$
5. The test limit is 3M limit.
6. The other emission levels were very low against the limit.
7. For 802.11b mode at 11Mbps.
8. For Antenna 3 (A800).



Ecom Sertech Corp.

Rm. 258, Bldg. 17, NO.195, Sec. 4 Chung Hsing Rd.,ChuTung Chen, Hsinchu, Taiwan 310, R.O.C
 TEL:886-3-5918012 FAX : 886-3-5825720

FCC ID : QDWWM168GI
 Report No. : ER03-11-068FRF
 Page 55 of 151

Test Requirement: 15.109 ,15.209

The frequency spectrum above 1 GHz was investigated. All emissions not reported below are more than 40 dB below the prescribed limits. Readings are both peak and average values.

Company	AirVast Technology Inc.	Test Date :	2003/12/20
Product Name	802.11g WLAN USB Module	Test By:	K. P. Pang
Model Name	WM168gi	TEMP&Humidity :	14.1°C , 48%

CH1 RX				Measurement Distance at 1m				Horizontal polarity			
Freq.	Reading	AF	Cable	Pre-amp	Dist	Filter	Level	Limit	Margin	Mark	Height
(MHz)	(dBuV)	(dBuV)	(dB)	(dB)	dB	dB	(dBuV/m)	(dBuV/m)	(dB)	(P/Q/A)	(Meter)
4823.98	52.36	34.44	2.82	35.16	9.50	0.00	44.96	74	-29.04	P	1.00
4823.98	48.76	34.44	2.82	35.16	9.50	0.00	41.36	54	-12.64	A	1.00
7235.84	44.09	39.81	4.79	35.65	9.50	0.00	43.54	74	-30.46	P	1.00
7235.84	33.52	39.81	4.79	35.65	9.50	0.00	32.97	54	-21.03	A	1.00
9648.33	48.13	38.54	5.90	36.44	9.50	0.00	46.63	74	-27.37	P	1.00
9648.33	37.09	38.54	5.90	36.44	9.50	0.00	35.59	54	-18.41	A	1.00

1. AF: Antenna Factor, Cable: Cable Loss, Pre-Amp: Preamplifier gain, Filter: High Pass Filter Insertion Loss (3.5GHz)
2. Analyzer setting P(Peak): RBW=1MHz, VBW=1MHz, A(Average): RBW=1MHz,VBW=10Hz
3. Dist : correction to extra plate reading to 3m specification distance 1m measurement distance = -9.5dB
4. The result basic equation calculation as follow :

$$\text{Level} = \text{Reading} + \text{AF} + \text{Cable} - \text{Preamp} + \text{Filter} - \text{Dist}, \text{Margin} = \text{Level} - \text{Limit}$$
5. The test limit is 3M limit.
6. The other emission levels were very low against the limit.
7. For 802.11g mode at 6Mbps.
8. For Antenna 3 (A800).



Ecom Sertech Corp.

Rm. 258, Bldg. 17, NO.195, Sec. 4 Chung Hsing Rd.,ChuTung Chen, Hsinchu, Taiwan 310, R.O.C
 TEL:886-3-5918012 FAX : 886-3-5825720

FCC ID : QDWWM168GI
 Report No. : ER03-11-068FRF
 Page 56 of 151

Test Requirement: 15.109 ,15.209

The frequency spectrum above 1 GHz was investigated. All emissions not reported below are more than 40 dB below the prescribed limits. Readings are both peak and average values.

Company	AirVast Technology Inc.	Test Date :	2003/12/20
Product Name	802.11g WLAN USB Module	Test By:	K. P. Pang
Model Name	WM168gi	TEMP&Humidity :	14.1°C , 48%

CH1 RX				Measurement Distance at 1m					Vertical polarity		
Freq.	Reading	AF	Cable	Pre-amp	Dist	Filter	Level	Limit	Margin	Mark	Height
(MHz)	(dBuV)	(dBuV)	(dB)	(dB)	dB	dB	(dBuV/m)	(dBuV/m)	(dB)	(P/Q/A)	(Meter)
4823.97	55.48	34.44	2.82	35.16	9.50	0.00	48.08	74	-25.92	P	1.00
4823.97	52.95	34.44	2.82	35.16	9.50	0.00	45.55	54	-8.45	A	1.00
7236.00	45.74	39.81	4.79	35.65	9.50	0.00	45.19	74	-28.81	P	1.00
7236.00	33.55	39.81	4.79	35.65	9.50	0.00	33.00	54	-21.00	A	1.00
9647.96	48.04	38.54	5.90	36.44	9.50	0.00	46.54	74	-27.46	P	1.00
9647.96	39.13	38.54	5.90	36.44	9.50	0.00	37.63	54	-16.37	A	1.00

- | |
|--|
| 1. AF: Antenna Factor, Cable: Cable Loss, Pre-Amp: Preamplifier gain, Filter: High Pass Filter Insertion Loss (3.5GHz) |
| 2. Analyzer setting P(Peak): RBW=1MHz, VBW=1MHz, A(Average): RBW=1MHz,VBW=10Hz |
| 3. Dist : correction to extra plate reading to 3m specification distance 1m measurement distance = -9.5dB |
| 4. The result basic equation calculation as follow : |
| Level = Reading + AF + Cable - Preamp + Filter - Dist, Margin = Level - Limit |
| 5. The test limit is 3M limit. |
| 6. The other emission levels were very low against the limit. |
| 7. For 802.11g mode at 6Mbps. |
| 8. For Antenna 3 (A800). |



Ecom Sertech Corp.

Rm. 258, Bldg. 17, NO.195, Sec. 4 Chung Hsing Rd.,ChuTung Chen, Hsinchu, Taiwan 310, R.O.C
 TEL:886-3-5918012 FAX : 886-3-5825720

FCC ID : QDWWM168GI
 Report No. : ER03-11-068FRF
 Page 57 of 151

Test Requirement: 15.109 ,15.209

The frequency spectrum above 1 GHz was investigated. All emissions not reported below are more than 40 dB below the prescribed limits. Readings are both peak and average values.

Company	AirVast Technology Inc.	Test Date :	2003/12/20
Product Name	802.11g WLAN USB Module	Test By:	K. P. Pang
Model Name	WM168gi	TEMP&Humidity :	14.1°C , 48%

CH6 RX				Measurement Distance at 1m				Horizontal polarity			
Freq.	Reading	AF	Cable	Pre-amp	Dist	Filter	Level	Limit	Margin	Mark	Height
(MHz)	(dBuV)	(dBuV)	(dB)	(dB)	dB	dB	(dBuV/m)	(dBuV/m)	(dB)	(P/Q/A)	(Meter)
4874.08	53.14	34.77	2.73	35.20	9.50	0.00	45.94	74	-28.06	P	1.00
4874.08	49.85	34.77	2.73	35.20	9.50	0.00	42.65	54	-11.35	A	1.00
7311.02	45.62	39.78	4.82	35.64	9.50	0.00	45.08	74	-28.92	P	1.00
7311.02	33.41	39.78	4.82	35.64	9.50	0.00	32.87	54	-21.13	A	1.00
9748.08	48.08	38.53	5.90	36.60	9.50	0.00	46.41	74	-27.59	P	1.00
9748.08	38.22	38.53	5.90	36.60	9.50	0.00	36.55	54	-17.45	A	1.00

- | |
|--|
| 1. AF: Antenna Factor, Cable: Cable Loss, Pre-Amp: Preamplifier gain, Filter: High Pass Filter Insertion Loss (3.5GHz) |
| 2. Analyzer setting P(Peak): RBW=1MHz, VBW=1MHz, A(Average): RBW=1MHz,VBW=10Hz |
| 3. Dist : correction to extra plate reading to 3m specification distance 1m measurement distance = -9.5dB |
| 4. The result basic equation calculation as follow : |
| Level = Reading + AF + Cable - Preamp + Filter - Dist, Margin = Level - Limit |
| 5. The test limit is 3M limit. |
| 6. The other emission levels were very low against the limit. |
| 7. For 802.11g mode at 6Mbps. |
| 8. For Antenna 3 (A800). |



Ecom Sertech Corp.

Rm. 258, Bldg. 17, NO.195, Sec. 4 Chung Hsing Rd.,ChuTung Chen, Hsinchu, Taiwan 310, R.O.C
 TEL:886-3-5918012 FAX : 886-3-5825720

FCC ID : QDWWM168GI
 Report No. : ER03-11-068FRF
 Page 58 of 151

Test Requirement: 15.109 ,15.209

The frequency spectrum above 1 GHz was investigated. All emissions not reported below are more than 40 dB below the prescribed limits. Readings are both peak and average values.

Company	AirVast Technology Inc.	Test Date :	2003/12/20
Product Name	802.11g WLAN USB Module	Test By:	K. P. Pang
Model Name	WM168gi	TEMP&Humidity :	14.1°C , 48%

CH6 RX				Measurement Distance at 1m					Vertical polarity		
Freq.	Reading	AF	Cable	Pre-amp	Dist	Filter	Level	Limit	Margin	Mark	Height
(MHz)	(dBuV)	(dBuV)	(dB)	(dB)	dB	dB	(dBuV/m)	(dBuV/m)	(dB)	(P/Q/A)	(Meter)
4874.01	55.59	34.77	2.73	35.20	9.50	0.00	48.39	74	-25.61	P	1.00
4874.01	53.25	34.77	2.73	35.20	9.50	0.00	46.05	54	-7.95	A	1.00
7310.93	44.66	39.78	4.82	35.64	9.50	0.00	44.12	74	-29.88	P	1.00
7310.93	34.19	39.78	4.82	35.64	9.50	0.00	33.65	54	-20.35	A	1.00
9747.84	48.88	38.53	5.90	36.60	9.50	0.00	47.21	74	-26.79	P	1.00
9747.84	39.54	38.53	5.90	36.60	9.50	0.00	37.87	54	-16.13	A	1.00

- | |
|--|
| 1. AF: Antenna Factor, Cable: Cable Loss, Pre-Amp: Preamplifier gain, Filter: High Pass Filter Insertion Loss (3.5GHz) |
| 2. Analyzer setting P(Peak): RBW=1MHz, VBW=1MHz, A(Average): RBW=1MHz,VBW=10Hz |
| 3. Dist : correction to extra plate reading to 3m specification distance 1m measurement distance = -9.5dB |
| 4. The result basic equation calculation as follow : |
| Level = Reading + AF + Cable - Preamp + Filter - Dist, Margin = Level - Limit |
| 5. The test limit is 3M limit. |
| 6. The other emission levels were very low against the limit. |
| 7. For 802.11g mode at 6Mbps. |
| 8. For Antenna 3 (A800). |



Ecom Sertech Corp.

Rm. 258, Bldg. 17, NO.195, Sec. 4 Chung Hsing Rd., ChuTung Chen, Hsinchu, Taiwan 310, R.O.C
 TEL:886-3-5918012 FAX : 886-3-5825720

FCC ID : QDWWM168GI
 Report No. : ER03-11-068FRF
 Page 59 of 151

Test Requirement: 15.109 ,15.209

The frequency spectrum above 1 GHz was investigated. All emissions not reported below are more than 40 dB below the prescribed limits. Readings are both peak and average values.

Company	AirVast Technology Inc.	Test Date :	2003/12/20
Product Name	802.11g WLAN USB Module	Test By:	K. P. Pang
Model Name	WM168gi	TEMP&Humidity :	14.1°C , 48%

CH11 RX				Measurement Distance at 1m					Horizontal polarity		
Freq.	Reading	AF	Cable	Pre-amp	Dist	Filter	Level	Limit	Margin	Mark	Height
(MHz)	(dBuV)	(dBuV)	(dB)	(dB)	dB	dB	(dBuV/m)	(dBuV/m)	(dB)	(P/Q/A)	(Meter)
4923.73	52.22	35.10	2.64	35.24	9.50	0.00	45.21	74	-28.79	P	1.00
4923.73	48.81	35.10	2.64	35.24	9.50	0.00	41.80	54	-12.20	A	1.00
7386.13	45.23	39.75	4.85	35.62	9.50	0.00	44.71	74	-29.29	P	1.00
7386.13	34.27	39.75	4.85	35.62	9.50	0.00	33.75	54	-20.25	A	1.00
9847.81	48.17	38.52	5.90	36.76	9.50	0.00	46.33	74	-27.67	P	1.00
9847.81	38.50	38.52	5.90	36.76	9.50	0.00	36.66	54	-17.34	A	1.00

- | |
|--|
| 1. AF: Antenna Factor, Cable: Cable Loss, Pre-Amp: Preamplifier gain, Filter: High Pass Filter Insertion Loss (3.5GHz) |
| 2. Analyzer setting P(Peak): RBW=1MHz, VBW=1MHz, A(Average): RBW=1MHz,VBW=10Hz |
| 3. Dist : correction to extra plate reading to 3m specification distance 1m measurement distance = -9.5dB |
| 4. The result basic equation calculation as follow : |
| Level = Reading + AF + Cable - Preamp + Filter - Dist, Margin = Level - Limit |
| 5. The test limit is 3M limit. |
| 6. The other emission levels were very low against the limit. |
| 7. For 802.11g mode at 6Mbps. |
| 8. For Antenna 3 (A800). |



Ecom Sertech Corp.

Rm. 258, Bldg. 17, NO.195, Sec. 4 Chung Hsing Rd.,ChuTung Chen, Hsinchu, Taiwan 310, R.O.C
 TEL:886-3-5918012 FAX : 886-3-5825720

FCC ID : QDWWM168GI
 Report No. : ER03-11-068FRF
 Page 60 of 151

Test Requirement: 15.109 ,15.209

The frequency spectrum above 1 GHz was investigated. All emissions not reported below are more than 40 dB below the prescribed limits. Readings are both peak and average values.

Company	AirVast Technology Inc.	Test Date :	2003/12/20
Product Name	802.11g WLAN USB Module	Test By:	K. P. Pang
Model Name	WM168gi	TEMP&Humidity :	14.1°C , 48%

CH11 RX				Measurement Distance at 1m					Vertical polarity		
Freq.	Reading	AF	Cable	Pre-amp	Dist	Filter	Level	Limit	Margin	Mark	Height
(MHz)	(dBuV)	(dBuV)	(dB)	(dB)	dB	dB	(dBuV/m)	(dBuV/m)	(dB)	(P/Q/A)	(Meter)
4924.05	55.91	35.10	2.64	35.24	9.50	0.00	48.91	74	-25.09	P	1.00
4924.05	53.63	35.10	2.64	35.24	9.50	0.00	46.63	54	-7.37	A	1.00
7385.84	44.18	39.75	4.85	35.62	9.50	0.00	43.66	74	-30.34	P	1.00
7385.84	32.83	39.75	4.85	35.62	9.50	0.00	32.31	54	-21.69	A	1.00
9848.10	48.86	38.52	5.90	36.76	9.50	0.00	47.02	74	-26.98	P	1.00
9848.10	39.64	38.52	5.90	36.76	9.50	0.00	37.80	54	-16.20	A	1.00

- | |
|--|
| 1. AF: Antenna Factor, Cable: Cable Loss, Pre-Amp: Preamplifier gain, Filter: High Pass Filter Insertion Loss (3.5GHz) |
| 2. Analyzer setting P(Peak): RBW=1MHz, VBW=1MHz, A(Average): RBW=1MHz,VBW=10Hz |
| 3. Dist : correction to extra plate reading to 3m specification distance 1m measurement distance = -9.5dB |
| 4. The result basic equation calculation as follow : |
| Level = Reading + AF + Cable - Preamp + Filter - Dist, Margin = Level - Limit |
| 5. The test limit is 3M limit. |
| 6. The other emission levels were very low against the limit. |
| 7. For 802.11g mode at 6Mbps. |
| 8. For Antenna 3 (A800). |



Ecom Sertech Corp.

Rm. 258, Bldg. 17, NO.195, Sec. 4 Chung Hsing Rd.,ChuTung Chen, Hsinchu, Taiwan 310, R.O.C
 TEL:886-3-5918012 FAX : 886-3-5825720

FCC ID : QDWWM168GI
 Report No. : ER03-11-068FRF
 Page 61 of 151

Test Requirement: 15.109 ,15.209

The frequency spectrum above 1 GHz was investigated. All emissions not reported below are more than 40 dB below the prescribed limits. Readings are both peak and average values.

Company	AirVast Technology Inc.	Test Date :	2003/12/20
Product Name	802.11g WLAN USB Module	Test By:	K. P. Pang
Model Name	WM168gi	TEMP&Humidity :	16.6°C , 42%

CH1 RX				Measurement Distance at 1m				Horizontal polarity			
Freq.	Reading	AF	Cable	Pre-amp	Dist	Filter	Level	Limit	Margin	Mark	Height
(MHz)	(dBuV)	(dBuV)	(dB)	(dB)	dB	dB	(dBuV/m)	(dBuV/m)	(dB)	(P/Q/A)	(Meter)
4824.04	51.62	34.44	2.82	35.16	9.50	0.00	44.22	74	-29.78	P	1.00
4824.04	47.76	34.44	2.82	35.16	9.50	0.00	40.36	54	-13.64	A	1.00
7235.44	45.30	39.81	4.79	35.65	9.50	0.00	44.75	74	-29.25	P	1.00
7235.44	33.67	39.81	4.79	35.65	9.50	0.00	33.12	54	-20.88	A	1.00
9647.92	47.02	38.54	5.90	36.44	9.50	0.00	45.52	74	-28.48	P	1.00
9647.92	35.91	38.54	5.90	36.44	9.50	0.00	34.41	54	-19.59	A	1.00

- | |
|--|
| 1. AF: Antenna Factor, Cable: Cable Loss, Pre-Amp: Preamplifier gain, Filter: High Pass Filter Insertion Loss (3.5GHz) |
| 2. Analyzer setting P(Peak): RBW=1MHz, VBW=1MHz, A(Average): RBW=1MHz,VBW=10Hz |
| 3. Dist : correction to extra plate reading to 3m specification distance 1m measurement distance = -9.5dB |
| 4. The result basic equation calculation as follow : |
| $Level = Reading + AF + Cable - Preamp + Filter - Dist, Margin = Level - Limit$ |
| 5. The test limit is 3M limit. |
| 6. The other emission levels were very low against the limit. |
| 7. For 802.11b mode at 11Mbps. |
| 8. For Antenna 4 (G736). |



Ecom Sertech Corp.

Rm. 258, Bldg. 17, NO.195, Sec. 4 Chung Hsing Rd., ChuTung Chen, Hsinchu, Taiwan 310, R.O.C
 TEL:886-3-5918012 FAX : 886-3-5825720

FCC ID : QDWWM168GI
 Report No. : ER03-11-068FRF
 Page 62 of 151

Test Requirement: 15.109 ,15.209

The frequency spectrum above 1 GHz was investigated. All emissions not reported below are more than 40 dB below the prescribed limits. Readings are both peak and average values.

Company	AirVast Technology Inc.	Test Date :	2003/12/20
Product Name	802.11g WLAN USB Module	Test By:	K. P. Pang
Model Name	WM168gi	TEMP&Humidity :	16.6°C , 42%

CH1 RX				Measurement Distance at 1m					Vertical polarity		
Freq.	Reading	AF	Cable	Pre-amp	Dist	Filter	Level	Limit	Margin	Mark	Height
(MHz)	(dBuV)	(dBuV)	(dB)	(dB)	dB	dB	(dBuV/m)	(dBuV/m)	(dB)	(P/Q/A)	(Meter)
4823.99	54.49	34.44	2.82	35.16	9.50	0.00	47.09	74	-26.91	P	1.00
4823.99	51.60	34.44	2.82	35.16	9.50	0.00	44.20	54	-9.80	A	1.00
7236.29	45.64	39.81	4.79	35.65	9.50	0.00	45.09	74	-28.91	P	1.00
7236.29	33.48	39.81	4.79	35.65	9.50	0.00	32.93	54	-21.07	A	1.00
9647.91	47.81	38.54	5.90	36.44	9.50	0.00	46.31	74	-27.69	P	1.00
9647.91	38.41	38.54	5.90	36.44	9.50	0.00	36.91	54	-17.09	A	1.00

1. AF: Antenna Factor, Cable: Cable Loss, Pre-Amp: Preamplifier gain, Filter: High Pass Filter Insertion Loss (3.5GHz)
2. Analyzer setting P(Peak): RBW=1MHz, VBW=1MHz, A(Average): RBW=1MHz,VBW=10Hz
3. Dist : correction to extra plate reading to 3m specification distance 1m measurement distance = -9.5dB
4. The result basic equation calculation as follow :

$$\text{Level} = \text{Reading} + \text{AF} + \text{Cable} - \text{Preamp} + \text{Filter} - \text{Dist}, \text{Margin} = \text{Level} - \text{Limit}$$
5. The test limit is 3M limit.
6. The other emission levels were very low against the limit.
7. For 802.11b mode at 11Mbps.
8. For Antenna 4 (G736).



Ecom Sertech Corp.

Rm. 258, Bldg. 17, NO.195, Sec. 4 Chung Hsing Rd., ChuTung Chen, Hsinchu, Taiwan 310, R.O.C
 TEL:886-3-5918012 FAX : 886-3-5825720

FCC ID : QDWWM168GI
 Report No. : ER03-11-068FRF
 Page 63 of 151

Test Requirement: 15.109 ,15.209

The frequency spectrum above 1 GHz was investigated. All emissions not reported below are more than 40 dB below the prescribed limits. Readings are both peak and average values.

Company	AirVast Technology Inc.	Test Date :	2003/12/20
Product Name	802.11g WLAN USB Module	Test By:	K. P. Pang
Model Name	WM168gi	TEMP&Humidity :	16.6°C , 42%

CH6 RX				Measurement Distance at 1m				Horizontal polarity			
Freq.	Reading	AF	Cable	Pre-amp	Dist	Filter	Level	Limit	Margin	Mark	Height
(MHz)	(dBuV)	(dBuV)	(dB)	(dB)	dB	dB	(dBuV/m)	(dBuV/m)	(dB)	(P/Q/A)	(Meter)
4874.03	51.88	34.77	2.73	35.20	9.50	0.00	44.68	74	-29.32	P	1.00
4874.03	47.89	34.77	2.73	35.20	9.50	0.00	40.69	54	-13.31	A	1.00
7310.91	43.71	39.78	4.82	35.64	9.50	0.00	43.17	74	-30.83	P	1.00
7310.91	32.80	39.78	4.82	35.64	9.50	0.00	32.26	54	-21.74	A	1.00
9748.19	47.80	38.53	5.90	36.60	9.50	0.00	46.13	74	-27.87	P	1.00
9748.19	37.07	38.53	5.90	36.60	9.50	0.00	35.40	54	-18.60	A	1.00

- | |
|--|
| 1. AF: Antenna Factor, Cable: Cable Loss, Pre-Amp: Preamplifier gain, Filter: High Pass Filter Insertion Loss (3.5GHz) |
| 2. Analyzer setting P(Peak): RBW=1MHz, VBW=1MHz, A(Average): RBW=1MHz,VBW=10Hz |
| 3. Dist : correction to extra plate reading to 3m specification distance 1m measurement distance = -9.5dB |
| 4. The result basic equation calculation as follow : |
| Level = Reading + AF + Cable - Preamp + Filter - Dist, Margin = Level - Limit |
| 5. The test limit is 3M limit. |
| 6. The other emission levels were very low against the limit. |
| 7. For 802.11b mode at 11Mbps. |
| 8. For Antenna 4 (G736). |



Ecom Sertech Corp.

Rm. 258, Bldg. 17, NO.195, Sec. 4 Chung Hsing Rd., ChuTung Chen, Hsinchu, Taiwan 310, R.O.C
 TEL:886-3-5918012 FAX : 886-3-5825720

FCC ID : QDWWM168GI
 Report No. : ER03-11-068FRF
 Page 64 of 151

Test Requirement: 15.109 ,15.209

The frequency spectrum above 1 GHz was investigated. All emissions not reported below are more than 40 dB below the prescribed limits. Readings are both peak and average values.

Company	AirVast Technology Inc.	Test Date :	2003/12/20
Product Name	802.11g WLAN USB Module	Test By:	K. P. Pang
Model Name	WM168gi	TEMP&Humidity :	16.6°C , 42%

CH6 RX				Measurement Distance at 1m					Vertical polarity		
Freq.	Reading	AF	Cable	Pre-amp	Dist	Filter	Level	Limit	Margin	Mark	Height
(MHz)	(dBuV)	(dBuV)	(dB)	(dB)	dB	dB	(dBuV/m)	(dBuV/m)	(dB)	(P/Q/A)	(Meter)
4873.93	54.20	34.77	2.73	35.20	9.50	0.00	47.00	74	-27.00	P	1.00
4873.93	51.39	34.77	2.73	35.20	9.50	0.00	44.19	54	-9.81	A	1.00
7311.24	45.36	39.78	4.82	35.64	9.50	0.00	44.82	74	-29.18	P	1.00
7311.24	33.82	39.78	4.82	35.64	9.50	0.00	33.28	54	-20.72	A	1.00
9748.04	49.23	38.53	5.90	36.60	9.50	0.00	47.56	74	-26.44	P	1.00
9748.04	40.64	38.53	5.90	36.60	9.50	0.00	38.97	54	-15.03	A	1.00

- | |
|--|
| 1. AF: Antenna Factor, Cable: Cable Loss, Pre-Amp: Preamplifier gain, Filter: High Pass Filter Insertion Loss (3.5GHz) |
| 2. Analyzer setting P(Peak): RBW=1MHz, VBW=1MHz, A(Average): RBW=1MHz,VBW=10Hz |
| 3. Dist : correction to extra plate reading to 3m specification distance 1m measurement distance = -9.5dB |
| 4. The result basic equation calculation as follow : |
| Level = Reading + AF + Cable - Preamp + Filter - Dist, Margin = Level - Limit |
| 5. The test limit is 3M limit. |
| 6. The other emission levels were very low against the limit. |
| 7. For 802.11b mode at 11Mbps. |
| 8. For Antenna 4 (G736). |



Ecom Sertech Corp.

Rm. 258, Bldg. 17, NO.195, Sec. 4 Chung Hsing Rd., ChuTung Chen, Hsinchu, Taiwan 310, R.O.C
 TEL:886-3-5918012 FAX : 886-3-5825720

FCC ID : QDWWM168GI
 Report No. : ER03-11-068FRF
 Page 65 of 151

Test Requirement: 15.109 ,15.209

The frequency spectrum above 1 GHz was investigated. All emissions not reported below are more than 40 dB below the prescribed limits. Readings are both peak and average values.

Company	AirVast Technology Inc.	Test Date :	2003/12/20
Product Name	802.11g WLAN USB Module	Test By:	K. P. Pang
Model Name	WM168gi	TEMP&Humidity :	16.6°C , 42%

CH11 RX				Measurement Distance at 1m				Horizontal polarity			
Freq.	Reading	AF	Cable	Pre-amp	Dist	Filter	Level	Limit	Margin	Mark	Height
(MHz)	(dBuV)	(dBuV)	(dB)	(dB)	dB	dB	(dBuV/m)	(dBuV/m)	(dB)	(P/Q/A)	(Meter)
4924.05	52.06	35.10	2.64	35.24	9.50	0.00	45.06	74	-28.94	P	1.00
4924.05	48.39	35.10	2.64	35.24	9.50	0.00	41.39	54	-12.61	A	1.00
7386.07	44.32	39.75	4.85	35.62	9.50	0.00	43.80	74	-30.20	P	1.00
7386.07	33.61	39.75	4.85	35.62	9.50	0.00	33.09	54	-20.91	A	1.00
9847.92	47.51	38.52	5.90	36.76	9.50	0.00	45.67	74	-28.33	P	1.00
9847.92	36.02	38.52	5.90	36.76	9.50	0.00	34.18	54	-19.82	A	1.00

- | |
|--|
| 1. AF: Antenna Factor, Cable: Cable Loss, Pre-Amp: Preamplifier gain, Filter: High Pass Filter Insertion Loss (3.5GHz) |
| 2. Analyzer setting P(Peak): RBW=1MHz, VBW=1MHz, A(Average): RBW=1MHz,VBW=10Hz |
| 3. Dist : correction to extra plate reading to 3m specification distance 1m measurement distance = -9.5dB |
| 4. The result basic equation calculation as follow : |
| Level = Reading + AF + Cable - Preamp + Filter - Dist, Margin = Level - Limit |
| 5. The test limit is 3M limit. |
| 6. The other emission levels were very low against the limit. |
| 7. For 802.11b mode at 11Mbps. |
| 8. For Antenna 4 (G736). |



Ecom Sertech Corp.

Rm. 258, Bldg. 17, NO.195, Sec. 4 Chung Hsing Rd., ChuTung Chen, Hsinchu, Taiwan 310, R.O.C
 TEL:886-3-5918012 FAX : 886-3-5825720

FCC ID : QDWWM168GI
 Report No. : ER03-11-068FRF
 Page 66 of 151

Test Requirement: 15.109 ,15.209

The frequency spectrum above 1 GHz was investigated. All emissions not reported below are more than 40 dB below the prescribed limits. Readings are both peak and average values.

Company	AirVast Technology Inc.	Test Date :	2003/12/20
Product Name	802.11g WLAN USB Module	Test By:	K. P. Pang
Model Name	WM168gi	TEMP&Humidity :	16.6°C , 42%

CH11 RX				Measurement Distance at 1m					Vertical polarity		
Freq.	Reading	AF	Cable	Pre-amp	Dist	Filter	Level	Limit	Margin	Mark	Height
(MHz)	(dBuV)	(dBuV)	(dB)	(dB)	dB	dB	(dBuV/m)	(dBuV/m)	(dB)	(P/Q/A)	(Meter)
4924.03	53.84	35.10	2.64	35.24	9.50	0.00	46.84	74	-27.16	P	1.00
4924.03	50.89	35.10	2.64	35.24	9.50	0.00	43.89	54	-10.11	A	1.00
7386.08	43.19	39.75	4.85	35.62	9.50	0.00	42.67	74	-31.33	P	1.00
7386.08	32.38	39.75	4.85	35.62	9.50	0.00	31.86	54	-22.14	A	1.00
9848.06	49.27	38.52	5.90	36.76	9.50	0.00	47.43	74	-26.57	P	1.00
9848.06	40.85	38.52	5.90	36.76	9.50	0.00	39.01	54	-14.99	A	1.00

- | |
|--|
| 1. AF: Antenna Factor, Cable: Cable Loss, Pre-Amp: Preamplifier gain, Filter: High Pass Filter Insertion Loss (3.5GHz) |
| 2. Analyzer setting P(Peak): RBW=1MHz, VBW=1MHz, A(Average): RBW=1MHz,VBW=10Hz |
| 3. Dist : correction to extra plate reading to 3m specification distance 1m measurement distance = -9.5dB |
| 4. The result basic equation calculation as follow : |
| Level = Reading + AF + Cable - Preamp + Filter - Dist, Margin = Level - Limit |
| 5. The test limit is 3M limit. |
| 6. The other emission levels were very low against the limit. |
| 7. For 802.11b mode at 11Mbps. |
| 8. For Antenna 4 (G736). |



Ecom Sertech Corp.

Rm. 258, Bldg. 17, NO.195, Sec. 4 Chung Hsing Rd.,ChuTung Chen, Hsinchu, Taiwan 310, R.O.C
 TEL:886-3-5918012 FAX : 886-3-5825720

FCC ID : QDWWM168GI
 Report No. : ER03-11-068FRF
 Page 67 of 151

Test Requirement: 15.109 ,15.209

The frequency spectrum above 1 GHz was investigated. All emissions not reported below are more than 40 dB below the prescribed limits. Readings are both peak and average values.

Company	AirVast Technology Inc.	Test Date :	2003/12/20
Product Name	802.11g WLAN USB Module	Test By:	K. P. Pang
Model Name	WM168gi	TEMP&Humidity :	14.1°C , 48%

CH1 RX				Measurement Distance at 1m				Horizontal polarity			
Freq.	Reading	AF	Cable	Pre-amp	Dist	Filter	Level	Limit	Margin	Mark	Height
(MHz)	(dBuV)	(dBuV)	(dB)	(dB)	dB	dB	(dBuV/m)	(dBuV/m)	(dB)	(P/Q/A)	(Meter)
4824.03	51.00	34.44	2.82	35.16	9.50	0.00	43.60	74	-30.40	P	1.00
4824.03	46.60	34.44	2.82	35.16	9.50	0.00	39.20	54	-14.80	A	1.00
7236.43	45.67	39.81	4.79	35.65	9.50	0.00	45.12	74	-28.88	P	1.00
7236.43	33.91	39.81	4.79	35.65	9.50	0.00	33.36	54	-20.64	A	1.00
9647.84	47.35	38.54	5.90	36.44	9.50	0.00	45.85	74	-28.15	P	1.00
9647.84	36.58	38.54	5.90	36.44	9.50	0.00	35.08	54	-18.92	A	1.00

1. AF: Antenna Factor, Cable: Cable Loss, Pre-Amp: Preamplifier gain, Filter: High Pass Filter Insertion Loss (3.5GHz)
2. Analyzer setting P(Peak): RBW=1MHz, VBW=1MHz, A(Average): RBW=1MHz,VBW=10Hz
3. Dist : correction to extra plate reading to 3m specification distance 1m measurement distance = -9.5dB
4. The result basic equation calculation as follow :

$$\text{Level} = \text{Reading} + \text{AF} + \text{Cable} - \text{Preamp} + \text{Filter} - \text{Dist}, \text{Margin} = \text{Level} - \text{Limit}$$
5. The test limit is 3M limit.
6. The other emission levels were very low against the limit.
7. For 802.11g mode at 6Mbps.
8. For Antenna 4 (G736).



Ecom Sertech Corp.

Rm. 258, Bldg. 17, NO.195, Sec. 4 Chung Hsing Rd.,ChuTung Chen, Hsinchu, Taiwan 310, R.O.C
 TEL:886-3-5918012 FAX : 886-3-5825720

FCC ID : QDWWM168GI
 Report No. : ER03-11-068FRF
 Page 68 of 151

Test Requirement: 15.109 ,15.209

The frequency spectrum above 1 GHz was investigated. All emissions not reported below are more than 40 dB below the prescribed limits. Readings are both peak and average values.

Company	AirVast Technology Inc.	Test Date :	2003/12/20
Product Name	802.11g WLAN USB Module	Test By:	K. P. Pang
Model Name	WM168gi	TEMP&Humidity :	14.1°C , 48%

CH1 RX				Measurement Distance at 1m					Vertical polarity		
Freq.	Reading	AF	Cable	Pre-amp	Dist	Filter	Level	Limit	Margin	Mark	Height
(MHz)	(dBuV)	(dBuV)	(dB)	(dB)	dB	dB	(dBuV/m)	(dBuV/m)	(dB)	(P/Q/A)	(Meter)
4823.94	54.94	34.44	2.82	35.16	9.50	0.00	47.54	74	-26.46	P	1.00
4823.94	51.99	34.44	2.82	35.16	9.50	0.00	44.59	54	-9.41	A	1.00
7235.93	44.72	39.81	4.79	35.65	9.50	0.00	44.17	74	-29.83	P	1.00
7235.93	33.97	39.81	4.79	35.65	9.50	0.00	33.42	54	-20.58	A	1.00
9647.69	47.96	38.54	5.90	36.44	9.50	0.00	46.46	74	-27.54	P	1.00
9647.69	37.82	38.54	5.90	36.44	9.50	0.00	36.32	54	-17.68	A	1.00

1. AF: Antenna Factor, Cable: Cable Loss, Pre-Amp: Preamplifier gain, Filter: High Pass Filter Insertion Loss (3.5GHz)
2. Analyzer setting P(Peak): RBW=1MHz, VBW=1MHz, A(Average): RBW=1MHz,VBW=10Hz
3. Dist : correction to extra plate reading to 3m specification distance 1m measurement distance = -9.5dB
4. The result basic equation calculation as follow :

$$\text{Level} = \text{Reading} + \text{AF} + \text{Cable} - \text{Preamp} + \text{Filter} - \text{Dist}, \text{Margin} = \text{Level} - \text{Limit}$$
5. The test limit is 3M limit.
6. The other emission levels were very low against the limit.
7. For 802.11g mode at 6Mbps.
8. For Antenna 4 (G736).



Ecom Sertech Corp.

Rm. 258, Bldg. 17, NO.195, Sec. 4 Chung Hsing Rd.,ChuTung Chen, Hsinchu, Taiwan 310, R.O.C
 TEL:886-3-5918012 FAX : 886-3-5825720

FCC ID : QDWWM168GI
 Report No. : ER03-11-068FRF
 Page 69 of 151

Test Requirement: 15.109 ,15.209

The frequency spectrum above 1 GHz was investigated. All emissions not reported below are more than 40 dB below the prescribed limits. Readings are both peak and average values.

Company	AirVast Technology Inc.	Test Date :	2003/12/20
Product Name	802.11g WLAN USB Module	Test By:	K. P. Pang
Model Name	WM168gi	TEMP&Humidity :	14.1°C , 48%

CH6 RX				Measurement Distance at 1m				Horizontal polarity			
Freq.	Reading	AF	Cable	Pre-amp	Dist	Filter	Level	Limit	Margin	Mark	Height
(MHz)	(dBuV)	(dBuV)	(dB)	(dB)	dB	dB	(dBuV/m)	(dBuV/m)	(dB)	(P/Q/A)	(Meter)
4873.86	53.83	34.77	2.73	35.20	9.50	0.00	46.63	74	-27.37	P	1.00
4873.86	50.33	34.77	2.73	35.20	9.50	0.00	43.13	54	-10.87	A	1.00
7311.13	46.14	39.78	4.82	35.64	9.50	0.00	45.60	74	-28.40	P	1.00
7311.13	34.29	39.78	4.82	35.64	9.50	0.00	33.75	54	-20.25	A	1.00
9748.01	47.90	38.53	5.90	36.60	9.50	0.00	46.23	74	-27.77	P	1.00
9748.01	36.72	38.53	5.90	36.60	9.50	0.00	35.05	54	-18.95	A	1.00

- | |
|--|
| 1. AF: Antenna Factor, Cable: Cable Loss, Pre-Amp: Preamplifier gain, Filter: High Pass Filter Insertion Loss (3.5GHz) |
| 2. Analyzer setting P(Peak): RBW=1MHz, VBW=1MHz, A(Average): RBW=1MHz,VBW=10Hz |
| 3. Dist : correction to extra plate reading to 3m specification distance 1m measurement distance = -9.5dB |
| 4. The result basic equation calculation as follow : |
| Level = Reading + AF + Cable - Preamp + Filter - Dist, Margin = Level - Limit |
| 5. The test limit is 3M limit. |
| 6. The other emission levels were very low against the limit. |
| 7. For 802.11g mode at 6Mbps. |
| 8. For Antenna 4 (G736). |



Ecom Sertech Corp.

Rm. 258, Bldg. 17, NO.195, Sec. 4 Chung Hsing Rd.,ChuTung Chen, Hsinchu, Taiwan 310, R.O.C
 TEL:886-3-5918012 FAX : 886-3-5825720

FCC ID : QDWWM168GI
 Report No. : ER03-11-068FRF
 Page 70 of 151

Test Requirement: 15.109 ,15.209

The frequency spectrum above 1 GHz was investigated. All emissions not reported below are more than 40 dB below the prescribed limits. Readings are both peak and average values.

Company	AirVast Technology Inc.	Test Date :	2003/12/20
Product Name	802.11g WLAN USB Module	Test By:	K. P. Pang
Model Name	WM168gi	TEMP&Humidity :	14.1°C , 48%

CH6 RX				Measurement Distance at 1m					Vertical polarity		
Freq.	Reading	AF	Cable	Pre-amp	Dist	Filter	Level	Limit	Margin	Mark	Height
(MHz)	(dBuV)	(dBuV)	(dB)	(dB)	dB	dB	(dBuV/m)	(dBuV/m)	(dB)	(P/Q/A)	(Meter)
4873.93	54.30	34.77	2.73	35.20	9.50	0.00	47.10	74	-26.90	P	1.00
4873.93	51.18	34.77	2.73	35.20	9.50	0.00	43.98	54	-10.02	A	1.00
7310.70	44.32	39.78	4.82	35.64	9.50	0.00	43.78	74	-30.22	P	1.00
7310.70	33.40	39.78	4.82	35.64	9.50	0.00	32.86	54	-21.14	A	1.00
9747.88	48.79	38.53	5.90	36.60	9.50	0.00	47.12	74	-26.88	P	1.00
9747.88	39.65	38.53	5.90	36.60	9.50	0.00	37.98	54	-16.02	A	1.00

- | |
|--|
| 1. AF: Antenna Factor, Cable: Cable Loss, Pre-Amp: Preamplifier gain, Filter: High Pass Filter Insertion Loss (3.5GHz) |
| 2. Analyzer setting P(Peak): RBW=1MHz, VBW=1MHz, A(Average): RBW=1MHz,VBW=10Hz |
| 3. Dist : correction to extra plate reading to 3m specification distance 1m measurement distance = -9.5dB |
| 4. The result basic equation calculation as follow : |
| Level = Reading + AF + Cable - Preamp + Filter - Dist, Margin = Level - Limit |
| 5. The test limit is 3M limit. |
| 6. The other emission levels were very low against the limit. |
| 7. For 802.11g mode at 6Mbps. |
| 8. For Antenna 4 (G736). |



Ecom Sertech Corp.

Rm. 258, Bldg. 17, NO.195, Sec. 4 Chung Hsing Rd.,ChuTung Chen, Hsinchu, Taiwan 310, R.O.C
 TEL:886-3-5918012 FAX : 886-3-5825720

FCC ID : QDWWM168GI
 Report No. : ER03-11-068FRF
 Page 71 of 151

Test Requirement: 15.109 ,15.209

The frequency spectrum above 1 GHz was investigated. All emissions not reported below are more than 40 dB below the prescribed limits. Readings are both peak and average values.

Company	AirVast Technology Inc.	Test Date :	2003/12/20
Product Name	802.11g WLAN USB Module	Test By:	K. P. Pang
Model Name	WM168gi	TEMP&Humidity :	14.1°C , 48%

CH11 RX				Measurement Distance at 1m					Horizontal polarity		
Freq.	Reading	AF	Cable	Pre-amp	Dist	Filter	Level	Limit	Margin	Mark	Height
(MHz)	(dBuV)	(dBuV)	(dB)	(dB)	dB	dB	(dBuV/m)	(dBuV/m)	(dB)	(P/Q/A)	(Meter)
4924.19	52.07	35.10	2.64	35.24	9.50	0.00	45.07	74	-28.93	P	1.00
4924.19	47.85	35.10	2.64	35.24	9.50	0.00	40.85	54	-13.15	A	1.00
7385.98	43.74	39.75	4.85	35.62	9.50	0.00	43.22	74	-30.78	P	1.00
7385.98	32.97	39.75	4.85	35.62	9.50	0.00	32.45	54	-21.55	A	1.00
9847.61	48.68	38.52	5.90	36.76	9.50	0.00	46.84	74	-27.16	P	1.00
9847.61	38.79	38.52	5.90	36.76	9.50	0.00	36.95	54	-17.05	A	1.00

1. AF: Antenna Factor, Cable: Cable Loss, Pre-Amp: Preamplifier gain, Filter: High Pass Filter Insertion Loss (3.5GHz)
2. Analyzer setting P(Peak): RBW=1MHz, VBW=1MHz, A(Average): RBW=1MHz,VBW=10Hz
3. Dist : correction to extra plate reading to 3m specification distance 1m measurement distance = -9.5dB
4. The result basic equation calculation as follow :

$$\text{Level} = \text{Reading} + \text{AF} + \text{Cable} - \text{Preamp} + \text{Filter} - \text{Dist}, \text{Margin} = \text{Level} - \text{Limit}$$
5. The test limit is 3M limit.
6. The other emission levels were very low against the limit.
7. For 802.11g mode at 6Mbps.
8. For Antenna 4 (G736).



Ecom Sertech Corp.

Rm. 258, Bldg. 17, NO.195, Sec. 4 Chung Hsing Rd.,ChuTung Chen, Hsinchu, Taiwan 310, R.O.C
TEL:886-3-5918012 FAX : 886-3-5825720

FCC ID : QDWWM168GI
Report No. : ER03-11-068FRF
Page 72 of 151

Test Requirement: 15.109 ,15.209

The frequency spectrum above 1 GHz was investigated. All emissions not reported below are more than 40 dB below the prescribed limits. Readings are both peak and average values.

Company	AirVast Technology Inc.	Test Date :	2003/12/20
Product Name	802.11g WLAN USB Module	Test By:	K. P. Pang
Model Name	WM168gi	TEMP&Humidity :	14.1°C , 48%

CH11 RX				Measurement Distance at 1m					Vertical polarity		
Freq.	Reading	AF	Cable	Pre-amp	Dist	Filter	Level	Limit	Margin	Mark	Height
(MHz)	(dBuV)	(dBuV)	(dB)	(dB)	dB	dB	(dBuV/m)	(dBuV/m)	(dB)	(P/Q/A)	(Meter)
4923.86	54.18	35.10	2.64	35.24	9.50	0.00	47.18	74	-26.82	P	1.00
4923.86	51.34	35.10	2.64	35.24	9.50	0.00	44.34	54	-9.66	A	1.00
7386.19	44.72	39.75	4.85	35.62	9.50	0.00	44.20	74	-29.80	P	1.00
7386.19	33.92	39.75	4.85	35.62	9.50	0.00	33.40	54	-20.60	A	1.00
9847.88	49.28	38.52	5.90	36.76	9.50	0.00	47.44	74	-26.56	P	1.00
9847.88	40.52	38.52	5.90	36.76	9.50	0.00	38.68	54	-15.32	A	1.00

1. AF: Antenna Factor, Cable: Cable Loss, Pre-Amp: Preamplifier gain, Filter: High Pass Filter Insertion Loss (3.5GHz)
2. Analyzer setting P(Peak): RBW=1MHz, VBW=1MHz, A(Average): RBW=1MHz,VBW=10Hz
3. Dist : correction to extra plate reading to 3m specification distance 1m measurement distance = -9.5dB
4. The result basic equation calculation as follow :
Level = Reading + AF + Cable - Preamp + Filter - Dist, Margin = Level - Limit
5. The test limit is 3M limit.
6. The other emission levels were very low against the limit.
7. For 802.11g mode at 6Mbps.
8. For Antenna 4 (G736).



Ecom Sertech Corp.

Rm. 258, Bldg. 17, NO.195, Sec. 4 Chung Hsing Rd., ChuTung Chen, Hsinchu, Taiwan 310, R.O.C
 TEL:886-3-5918012 FAX : 886-3-5825720

FCC ID : QDWWM168GI
 Report No. : ER03-11-068FRF
 Page 73 of 151

Test Requirement: 15.205

The frequency spectrum above 1 GHz was investigated. All emissions not reported below are more than 40 dB below the prescribed limits. Readings are both peak and average values.

Company	AirVast Technology Inc.	Test Date :	2003/12/23
Product Name	802.11g WLAN USB Module	Test By:	K. P. Pang
Model Name	WM168gi	TEMP&Humidity :	28.1°C , 39%

CH1 TX				Measurement Distance at 1m				Horizontal polarity			
Freq.	Reading	AF	Cable	Pre-amp	Dist	Filter	Level	Limit	Margin	Mark	Height
(MHz)	(dBuV)	(dBuV)	(dB)	(dB)	dB	dB	(dBuV/m)	(dBuV/m)	(dB)	(P/Q/A)	(Meter)
* 2389.95	29.47	31.81	3.84	0.00	9.50	0.00	55.62	74	-18.38	P	1.00
* 2389.95	15.71	31.81	3.84	0.00	9.50	0.00	41.86	54	-12.14	A	1.00
2413.30	63.36	31.79	3.66	0.00	9.50	0.00	89.31	Fundamental Frequency		P	1.00
2413.30	56.92	31.79	3.66	0.00	9.50	0.00	82.87			A	1.00
* 4823.91	45.11	34.44	2.82	35.16	9.50	2.00	39.71	74	-34.29	P	1.00
* 4823.91	33.08	34.44	2.82	35.16	9.50	2.00	27.68	54	-26.32	A	1.00
7236.19	44.81	39.81	4.79	35.65	9.50	2.00	46.26	74	-27.74	P	1.00
7236.19	33.64	39.81	4.79	35.65	9.50	2.00	35.09	54	-18.91	A	1.00
9647.84	46.92	38.54	5.90	36.44	9.50	0.61	46.03	74	-27.97	P	1.00
9647.84	34.33	38.54	5.90	36.44	9.50	0.61	33.44	54	-20.56	A	1.00
* 12066.50	-----	-----	-----	-----	9.50	0.80	-----	-----	-----	-----	1.00
* 14479.80	-----	-----	-----	-----	0.00	0.68	-----	-----	-----	-----	1.00
16893.10	-----	-----	-----	-----	0.00	0.44	-----	-----	-----	-----	1.00
* 19306.40	-----	-----	-----	-----	0.00	1.97	-----	-----	-----	-----	1.00
21719.70	-----	-----	-----	-----	0.00	0.81	-----	-----	-----	-----	1.00
24133.00	-----	-----	-----	-----	0.00	2.89	-----	-----	-----	-----	1.00

Note :

- The measurement was searched to 10th harmonic, Remark “---” means that the emissions level is too low to be measured.
- AF: Antenna Factor, Cable: Cable Loss, Pre-Amp: Preamplifier gain, Filter: High Pass Filter Insertion Loss (3.5GHz)
- Analyzer setting P(Peak): RBW=1MHz, VBW=1MHz, A(Average): RBW=1MHz, VBW=10Hz
- Remark “*” means that Restricted band.
- Dist : correction to extra plate reading to 3m specification distance 1m measurement distance = -9.5dB
- The result basic equation calculation is as follow:
 Level = Reading + AF + Cable - Preamp + Filter - Dist, Margin = Level - Limit
- The other emission levels were very low against the limit
- The test limit distance is 3M limit.
- For 802.11b mode at 11Mbps.
- For Antenna 1 (A530A531).



Ecom Sertech Corp.

Rm. 258, Bldg. 17, NO.195, Sec. 4 Chung Hsing Rd., ChuTung Chen, Hsinchu, Taiwan 310, R.O.C
 TEL:886-3-5918012 FAX : 886-3-5825720

FCC ID : QDWWM168GI
 Report No. : ER03-11-068FRF
 Page 74 of 151

Test Requirement: 15.205

The frequency spectrum above 1 GHz was investigated. All emissions not reported below are more than 40 dB below the prescribed limits. Readings are both peak and average values.

Company	AirVast Technology Inc.	Test Date :	2003/12/23
Product Name	802.11g WLAN USB Module	Test By:	K. P. Pang
Model Name	WM168gi	TEMP&Humidity :	28.1°C , 39%

CH1 TX				Measurement Distance at 1m					Vertical polarity			
Freq.	Reading	AF	Cable	Pre-amp	Dist	Filter	Level	Limit	Margin	Mark	Height	
(MHz)	(dBuV)	(dBuV)	(dB)	(dB)	dB	dB	(dBuV/m)	(dBuV/m)	(dB)	(P/Q/A)	(Meter)	
* 2389.95	29.52	31.81	3.84	0.00	9.50	0.00	55.67	74	-18.33	P	1.00	
* 2389.95	15.71	31.81	3.84	0.00	9.50	0.00	41.86	54	-12.14	A	1.00	
2413.25	58.42	31.79	3.66	0.00	9.50	0.00	84.37	Fundamental Frequency		P	1.00	
2413.25	51.90	31.79	3.66	0.00	9.50	0.00	77.85			A	1.00	
* 4824.02	44.87	34.44	2.82	35.16	9.50	2.00	39.47	74	-34.53	P	1.00	
* 4824.02	33.83	34.44	2.82	35.16	9.50	2.00	28.43	54	-25.57	A	1.00	
7235.88	46.63	39.81	4.79	35.65	9.50	2.00	48.08	74	-25.92	P	1.00	
7235.88	34.52	39.81	4.79	35.65	9.50	2.00	35.97	54	-18.03	A	1.00	
9648.13	46.28	38.54	5.90	36.44	9.50	0.61	45.39	74	-28.61	P	1.00	
9648.13	35.54	38.54	5.90	36.44	9.50	0.61	34.65	54	-19.35	A	1.00	
* 12066.25	-----	-----	-----	-----	9.50	0.80	-----	-----	-----	-----	1.00	
* 14479.50	-----	-----	-----	-----	0.00	0.68	-----	-----	-----	-----	1.00	
16892.75	-----	-----	-----	-----	0.00	0.44	-----	-----	-----	-----	1.00	
* 19306.00	-----	-----	-----	-----	0.00	1.97	-----	-----	-----	-----	1.00	
21719.25	-----	-----	-----	-----	0.00	0.81	-----	-----	-----	-----	1.00	
24132.50	-----	-----	-----	-----	0.00	2.89	-----	-----	-----	-----	1.00	

Note :

- The measurement was searched to 10th harmonic, Remark “---” means that the emissions level is too low to be measured.
- AF: Antenna Factor, Cable: Cable Loss, Pre-Amp: Preamplifier gain, Filter: High Pass Filter Insertion Loss (3.5GHz)
- Analyzer setting P(Peak): RBW=1MHz, VBW=1MHz, A(Average): RBW=1MHz, VBW=10Hz
- Remark “*” means that Restricted band.
- Dist : correction to extra plate reading to 3m specification distance 1m measurement distance = -9.5dB
- The result basic equation calculation is as follow:

$$\text{Level} = \text{Reading} + \text{AF} + \text{Cable} - \text{Preamp} + \text{Filter} - \text{Dist}, \text{Margin} = \text{Level} - \text{Limit}$$
- The other emission levels were very low against the limit
- The test limit distance is 3M limit.
- For 802.11b mode at 11Mbps.
- For Antenna 1 (A530A531).



Ecom Sertech Corp.

Rm. 258, Bldg. 17, NO.195, Sec. 4 Chung Hsing Rd., ChuTung Chen, Hsinchu, Taiwan 310, R.O.C
 TEL:886-3-5918012 FAX : 886-3-5825720

FCC ID : QDWWM168GI
 Report No. : ER03-11-068FRF
 Page 75 of 151

Test Requirement: 15.205

The frequency spectrum above 1 GHz was investigated. All emissions not reported below are more than 40 dB below the prescribed limits. Readings are both peak and average values.

Company	AirVast Technology Inc.	Test Date :	2003/12/23
Product Name	802.11g WLAN USB Module	Test By:	K. P. Pang
Model Name	WM168gi	TEMP&Humidity :	28.1°C , 39%

CH6 TX				Measurement Distance at 1m				Horizontal polarity			
Freq.	Reading	AF	Cable	Pre-amp	Dist	Filter	Level	Limit	Margin	Mark	Height
(MHz)	(dBuV)	(dBuV)	(dB)	(dB)	dB	dB	(dBuV/m)	(dBuV/m)	(dB)	(P/Q/A)	(Meter)
2438.25	63.14	31.76	3.47	0.00	9.50	0.00	88.87	Fundamental Frequency		P	1.00
2438.25	56.32	31.76	3.47	0.00	9.50	0.00	82.05			A	1.00
* 4874.08	45.32	34.77	2.73	35.20	9.50	1.80	39.92	74	-34.08	P	1.00
* 4874.08	33.18	34.77	2.73	35.20	9.50	1.80	27.78	54	-26.22	A	1.00
* 7311.02	44.75	39.78	4.82	35.64	9.50	2.00	46.21	74	-27.79	P	1.00
* 7311.02	33.73	39.78	4.82	35.64	9.50	2.00	35.19	54	-18.81	A	1.00
9747.93	47.02	38.53	5.90	36.60	9.50	0.55	45.90	74	-28.10	P	1.00
9747.93	35.11	38.53	5.90	36.60	9.50	0.55	33.99	54	-20.01	A	1.00
* 12191.25	-----	-----	-----	-----	9.50	0.80	-----	-----	-----	-----	1.00
14629.50	-----	-----	-----	-----	0.00	0.60	-----	-----	-----	-----	1.00
17067.75	-----	-----	-----	-----	0.00	0.53	-----	-----	-----	-----	1.00
* 19506.00	-----	-----	-----	-----	0.00	2.21	-----	-----	-----	-----	1.00
21944.25	-----	-----	-----	-----	0.00	0.72	-----	-----	-----	-----	1.00
24382.50	-----	-----	-----	-----	0.00	2.49	-----	-----	-----	-----	1.00

Note :

- The measurement was searched to 10th harmonic, Remark “---” means that the emissions level is too low to be measured.
- AF: Antenna Factor, Cable: Cable Loss, Pre-Amp: Preamplifier gain, Filter: High Pass Filter Insertion Loss (3.5GHz)
- Analyzer setting P(Peak): RBW=1MHz, VBW=1MHz, A(Average): RBW=1MHz, VBW=10Hz
- Remark “*” means that Restricted band.
- Dist : correction to extra plate reading to 3m specification distance 1m measurement distance = -9.5dB
- The result basic equation calculation is as follow:
 Level = Reading + AF + Cable - Preamp + Filter - Dist, Margin = Level - Limit
- The other emission levels were very low against the limit
- The test limit distance is 3M limit.
- For 802.11b mode at 11Mbps.
- For Antenna 1 (A530A531).



Ecom Sertech Corp.

Rm. 258, Bldg. 17, NO.195, Sec. 4 Chung Hsing Rd., ChuTung Chen, Hsinchu, Taiwan 310, R.O.C
 TEL:886-3-5918012 FAX : 886-3-5825720

FCC ID : QDWWM168GI
 Report No. : ER03-11-068FRF
 Page 76 of 151

Test Requirement: 15.205

The frequency spectrum above 1 GHz was investigated. All emissions not reported below are more than 40 dB below the prescribed limits. Readings are both peak and average values.

Company	AirVast Technology Inc.	Test Date :	2003/12/23
Product Name	802.11g WLAN USB Module	Test By:	K. P. Pang
Model Name	WM168gi	TEMP&Humidity :	28.1°C , 39%

CH6 TX				Measurement Distance at 1m				Vertical polarity			
Freq.	Reading	AF	Cable	Pre-amp	Dist	Filter	Level	Limit	Margin	Mark	Height
(MHz)	(dBuV)	(dBuV)	(dB)	(dB)	dB	dB	(dBuV/m)	(dBuV/m)	(dB)	(P/Q/A)	(Meter)
2438.30	58.92	31.76	3.47	0.00	9.50	0.00	84.65	Fundamental Frequency		P	1.00
2438.30	52.19	31.76	3.47	0.00	9.50	0.00	77.92			A	1.00
* 4873.97	45.02	34.77	2.73	35.20	9.50	1.80	39.62	74	-34.38	P	1.00
* 4873.97	33.97	34.77	2.73	35.20	9.50	1.80	28.57	54	-25.43	A	1.00
* 7311.08	45.02	39.78	4.82	35.64	9.50	2.00	46.48	74	-27.52	P	1.00
* 7311.08	33.18	39.78	4.82	35.64	9.50	2.00	34.64	54	-19.36	A	1.00
9747.93	46.68	38.53	5.90	36.60	9.50	0.55	45.56	74	-28.44	P	1.00
9747.93	35.75	38.53	5.90	36.60	9.50	0.55	34.63	54	-19.37	A	1.00
* 12191.50	-----	-----	-----	-----	9.50	0.80	-----	-----	-----	-----	1.00
14629.80	-----	-----	-----	-----	0.00	0.60	-----	-----	-----	-----	1.00
17068.10	-----	-----	-----	-----	0.00	0.53	-----	-----	-----	-----	1.00
* 19506.40	-----	-----	-----	-----	0.00	2.21	-----	-----	-----	-----	1.00
21944.70	-----	-----	-----	-----	0.00	0.72	-----	-----	-----	-----	1.00
24383.00	-----	-----	-----	-----	0.00	2.49	-----	-----	-----	-----	1.00

Note :

- The measurement was searched to 10th harmonic, Remark “---” means that the emissions level is too low to be measured.
- AF: Antenna Factor, Cable: Cable Loss, Pre-Amp: Preamplifier gain, Filter: High Pass Filter Insertion Loss (3.5GHz)
- Analyzer setting P(Peak): RBW=1MHz, VBW=1MHz, A(Average): RBW=1MHz, VBW=10Hz
- Remark “*” means that Restricted band.
- Dist : correction to extra plate reading to 3m specification distance 1m measurement distance = -9.5dB
- The result basic equation calculation is as follow:
 $Level = Reading + AF + Cable - Preamp + Filter - Dist$, $Margin = Level - Limit$
- The other emission levels were very low against the limit
- The test limit distance is 3M limit.
- For 802.11b mode at 11Mbps.
- For Antenna 1 (A530A531).



Ecom Sertech Corp.

Rm. 258, Bldg. 17, NO.195, Sec. 4 Chung Hsing Rd., ChuTung Chen, Hsinchu, Taiwan 310, R.O.C
 TEL:886-3-5918012 FAX : 886-3-5825720

FCC ID : QDWWM168GI
 Report No. : ER03-11-068FRF
 Page 77 of 151

Test Requirement: 15.205

The frequency spectrum above 1 GHz was investigated. All emissions not reported below are more than 40 dB below the prescribed limits. Readings are both peak and average values.

Company	AirVast Technology Inc.	Test Date :	2003/12/23
Product Name	802.11g WLAN USB Module	Test By:	K. P. Pang
Model Name	WM168gi	TEMP&Humidity :	28.1°C , 39%

CH11 TX				Measurement Distance at 1m				Horizontal polarity			
Freq.	Reading	AF	Cable	Pre-amp	Dist	Filter	Level	Limit	Margin	Mark	Height
(MHz)	(dBuV)	(dBuV)	(dB)	(dB)	dB	dB	(dBuV/m)	(dBuV/m)	(dB)	(P/Q/A)	(Meter)
2463.25	64.41	31.74	3.28	0.00	9.50	0.00	89.93	Fundamental Frequency		P	1.00
2463.25	57.73	31.74	3.28	0.00	9.50	0.00	83.25			A	1.00
* 2483.60	31.24	31.72	3.12	0.00	9.50	0.00	56.58	74	-17.42	P	1.00
* 2483.60	15.86	31.72	3.12	0.00	9.50	0.00	41.20	54	-12.80	A	1.00
* 4924.06	45.30	35.10	2.64	35.24	9.50	1.60	39.90	74	-34.10	P	1.00
* 4924.06	34.25	35.10	2.64	35.24	9.50	1.60	28.85	54	-25.15	A	1.00
* 7386.02	44.51	39.75	4.85	35.62	9.50	2.00	45.99	74	-28.01	P	1.00
* 7386.02	33.30	39.75	4.85	35.62	9.50	2.00	34.78	54	-19.22	A	1.00
9848.07	46.87	38.52	5.90	36.76	9.50	0.49	45.52	74	-28.48	P	1.00
9848.07	35.27	38.52	5.90	36.76	9.50	0.49	33.92	54	-20.08	A	1.00
* 12316.25	-----	-----	-----	-----	9.50	0.80	-----	-----	-----	-----	1.00
14779.50	-----	-----	-----	-----	0.00	0.48	-----	-----	-----	-----	1.00
17242.75	-----	-----	-----	-----	0.00	0.60	-----	-----	-----	-----	1.00
* 19706.00	-----	-----	-----	-----	0.00	2.41	-----	-----	-----	-----	1.00
* 22169.25	-----	-----	-----	-----	0.00	0.70	-----	-----	-----	-----	1.00
24632.50	-----	-----	-----	-----	0.00	2.11	-----	-----	-----	-----	1.00

Note :

- The measurement was searched to 10th harmonic, Remark “---” means that the emissions level is too low to be measured.
- AF: Antenna Factor, Cable: Cable Loss, Pre-Amp: Preamplifier gain, Filter: High Pass Filter Insertion Loss (3.5GHz)
- Analyzer setting P(Peak): RBW=1MHz, VBW=1MHz, A(Average): RBW=1MHz, VBW=10Hz
- Remark “*” means that Restricted band.
- Dist : correction to extra plate reading to 3m specification distance 1m measurement distance = -9.5dB
- The result basic equation calculation is as follow:
 $Level = Reading + AF + Cable - Preamp + Filter - Dist$, $Margin = Level - Limit$
- The other emission levels were very low against the limit
- The test limit distance is 3M limit.
- For 802.11b mode at 11Mbps.
- For Antenna 1 (A530A531).



Ecom Sertech Corp.

Rm. 258, Bldg. 17, NO.195, Sec. 4 Chung Hsing Rd., ChuTung Chen, Hsinchu, Taiwan 310, R.O.C
 TEL:886-3-5918012 FAX : 886-3-5825720

FCC ID : QDWWM168GI
 Report No. : ER03-11-068FRF
 Page 78 of 151

Test Requirement: 15.205

The frequency spectrum above 1 GHz was investigated. All emissions not reported below are more than 40 dB below the prescribed limits. Readings are both peak and average values.

Company	AirVast Technology Inc.	Test Date :	2003/12/23
Product Name	802.11g WLAN USB Module	Test By:	K. P. Pang
Model Name	WM168gi	TEMP&Humidity :	28.1°C , 39%

CH11 TX				Measurement Distance at 1m				Vertical polarity			
Freq.	Reading	AF	Cable	Pre-amp	Dist	Filter	Level	Limit	Margin	Mark	Height
(MHz)	(dBuV)	(dBuV)	(dB)	(dB)	dB	dB	(dBuV/m)	(dBuV/m)	(dB)	(P/Q/A)	(Meter)
2463.30	61.20	31.74	3.28	0.00	9.50	0.00	86.72	Fundamental Frequency		P	1.00
2463.30	54.38	31.74	3.28	0.00	9.50	0.00	79.90			A	1.00
* 2483.60	28.55	31.72	3.12	0.00	9.50	0.00	53.89	74	-20.11	P	1.00
* 2483.60	15.75	31.72	3.12	0.00	9.50	0.00	41.09	54	-12.91	A	1.00
* 4924.03	45.68	35.10	2.64	35.24	9.50	1.60	40.28	74	-33.72	P	1.00
* 4924.03	34.18	35.10	2.64	35.24	9.50	1.60	28.78	54	-25.22	A	1.00
* 7385.88	44.97	39.75	4.85	35.62	9.50	2.00	46.45	74	-27.55	P	1.00
* 7385.88	33.74	39.75	4.85	35.62	9.50	2.00	35.22	54	-18.78	A	1.00
9847.84	46.50	38.52	5.90	36.76	9.50	0.49	45.15	74	-28.85	P	1.00
9847.84	35.55	38.52	5.90	36.76	9.50	0.49	34.20	54	-19.80	A	1.00
* 12316.50	-----	-----	-----	-----	9.50	0.80	-----	-----	-----	-----	1.00
14779.80	-----	-----	-----	-----	0.00	0.48	-----	-----	-----	-----	1.00
17243.10	-----	-----	-----	-----	0.00	0.60	-----	-----	-----	-----	1.00
* 19706.40	-----	-----	-----	-----	0.00	2.41	-----	-----	-----	-----	1.00
* 22169.70	-----	-----	-----	-----	0.00	0.70	-----	-----	-----	-----	1.00
24633.00	-----	-----	-----	-----	0.00	2.11	-----	-----	-----	-----	1.00

Note :

- The measurement was searched to 10th harmonic, Remark “---” means that the emissions level is too low to be measured.
- AF: Antenna Factor, Cable: Cable Loss, Pre-Amp: Preamplifier gain, Filter: High Pass Filter Insertion Loss (3.5GHz)
- Analyzer setting P(Peak): RBW=1MHz, VBW=1MHz, A(Average): RBW=1MHz, VBW=10Hz
- Remark “*” means that Restricted band.
- Dist : correction to extra plate reading to 3m specification distance 1m measurement distance = -9.5dB
- The result basic equation calculation is as follow:
 $Level = Reading + AF + Cable - Preamp + Filter - Dist$, $Margin = Level - Limit$
- The other emission levels were very low against the limit
- The test limit distance is 3M limit.
- For 802.11b mode at 11Mbps.
- For Antenna 1 (A530A531).



Ecom Sertech Corp.

Rm. 258, Bldg. 17, NO.195, Sec. 4 Chung Hsing Rd., ChuTung Chen, Hsinchu, Taiwan 310, R.O.C
 TEL:886-3-5918012 FAX : 886-3-5825720

FCC ID : QDWWM168GI
 Report No. : ER03-11-068FRF
 Page 79 of 151

Test Requirement: 15.205

The frequency spectrum above 1 GHz was investigated. All emissions not reported below are more than 40 dB below the prescribed limits. Readings are both peak and average values.

Company	AirVast Technology Inc.	Test Date :	2003/12/23
Product Name	802.11g WLAN USB Module	Test By:	K. P. Pang
Model Name	WM168gi	TEMP&Humidity :	24.8°C , 42%

CH1 TX				Measurement Distance at 1m				Horizontal polarity			
Freq.	Reading	AF	Cable	Pre-amp	Dist	Filter	Level	Limit	Margin	Mark	Height
(MHz)	(dBuV)	(dBuV)	(dB)	(dB)	dB	dB	(dBuV/m)	(dBuV/m)	(dB)	(P/Q/A)	(Meter)
* 2389.95	30.33	31.81	3.84	0.00	9.50	0.00	56.48	74	-17.52	P	1.00
* 2389.95	16.87	31.81	3.84	0.00	9.50	0.00	43.02	54	-10.98	A	1.00
2410.34	61.44	31.79	3.68	0.00	9.50	0.00	87.41	Fundamental Frequency		P	1.00
2410.34	53.22	31.79	3.68	0.00	9.50	0.00	79.19			A	1.00
* 4824.10	45.66	34.44	2.82	35.16	9.50	2.00	40.26	74	-33.74	P	1.00
* 4824.10	34.05	34.44	2.82	35.16	9.50	2.00	28.65	54	-25.35	A	1.00
7235.98	44.50	39.81	4.79	35.65	9.50	2.00	45.95	74	-28.05	P	1.00
7235.98	32.62	39.81	4.79	35.65	9.50	2.00	34.07	54	-19.93	A	1.00
9648.06	47.25	38.54	5.90	36.44	9.50	0.61	46.36	74	-27.64	P	1.00
9648.06	36.02	38.54	5.90	36.44	9.50	0.61	35.13	54	-18.87	A	1.00
* 12051.70	-----	-----	-----	-----	9.50	0.80	-----	-----	-----	-----	1.00
14462.04	-----	-----	-----	-----	0.00	0.65	-----	-----	-----	-----	1.00
16872.38	-----	-----	-----	-----	0.00	0.42	-----	-----	-----	-----	1.00
* 19282.72	-----	-----	-----	-----	0.00	1.94	-----	-----	-----	-----	1.00
21693.06	-----	-----	-----	-----	0.00	0.82	-----	-----	-----	-----	1.00
24103.40	-----	-----	-----	-----	0.00	2.93	-----	-----	-----	-----	1.00

Note :

- The measurement was searched to 10th harmonic, Remark “---” means that the emissions level is too low to be measured.
- AF: Antenna Factor, Cable: Cable Loss, Pre-Amp: Preamplifier gain, Filter: High Pass Filter Insertion Loss (3.5GHz)
- Analyzer setting P(Peak): RBW=1MHz, VBW=1MHz, A(Average): RBW=1MHz, VBW=10Hz
- Remark “*” means that Restricted band.
- Dist : correction to extra plate reading to 3m specification distance 1m measurement distance = -9.5dB
- The result basic equation calculation is as follow:
 $Level = Reading + AF + Cable - Preamp + Filter - Dist$, $Margin = Level - Limit$
- The other emission levels were very low against the limit
- The test limit distance is 3M limit.
- For 802.11g mode at 6Mbps.
- For Antenna 1 (A530A531).



Ecom Sertech Corp.

Rm. 258, Bldg. 17, NO.195, Sec. 4 Chung Hsing Rd., ChuTung Chen, Hsinchu, Taiwan 310, R.O.C
 TEL:886-3-5918012 FAX : 886-3-5825720

FCC ID : QDWWM168GI
 Report No. : ER03-11-068FRF
 Page 80 of 151

Test Requirement: 15.205

The frequency spectrum above 1 GHz was investigated. All emissions not reported below are more than 40 dB below the prescribed limits. Readings are both peak and average values.

Company	AirVast Technology Inc.	Test Date :	2003/12/23
Product Name	802.11g WLAN USB Module	Test By:	K. P. Pang
Model Name	WM168gi	TEMP&Humidity :	24.8°C , 42%

CH1 TX				Measurement Distance at 1m				Vertical polarity			
Freq.	Reading	AF	Cable	Pre-amp	Dist	Filter	Level	Limit	Margin	Mark	Height
(MHz)	(dBuV)	(dBuV)	(dB)	(dB)	dB	dB	(dBuV/m)	(dBuV/m)	(dB)	(P/Q/A)	(Meter)
* 2389.95	29.31	31.81	3.84	0.00	9.50	0.00	55.46	74	-18.54	P	1.00
* 2389.95	16.60	31.81	3.84	0.00	9.50	0.00	42.75	54	-11.25	A	1.00
2410.39	59.24	31.79	3.68	0.00	9.50	0.00	85.21	Fundamental Frequency		P	1.00
2410.39	50.94	31.79	3.68	0.00	9.50	0.00	76.91			A	1.00
* 4823.83	45.22	34.44	2.82	35.16	9.50	2.00	39.82	74	-34.18	P	1.00
* 4823.83	34.68	34.44	2.82	35.16	9.50	2.00	29.28	54	-24.72	A	1.00
7236.05	45.51	39.81	4.79	35.65	9.50	2.00	46.96	74	-27.04	P	1.00
7236.05	33.74	39.81	4.79	35.65	9.50	2.00	35.19	54	-18.81	A	1.00
9648.19	46.88	38.54	5.90	36.44	9.50	0.61	45.99	74	-28.01	P	1.00
9648.19	35.98	38.54	5.90	36.44	9.50	0.61	35.09	54	-18.91	A	1.00
* 12051.95	-----	-----	-----	-----	9.50	0.80	-----	-----	-----	-----	1.00
14462.34	-----	-----	-----	-----	0.00	0.65	-----	-----	-----	-----	1.00
16872.73	-----	-----	-----	-----	0.00	0.42	-----	-----	-----	-----	1.00
* 19283.12	-----	-----	-----	-----	0.00	1.94	-----	-----	-----	-----	1.00
21693.51	-----	-----	-----	-----	0.00	0.82	-----	-----	-----	-----	1.00
24103.90	-----	-----	-----	-----	0.00	2.93	-----	-----	-----	-----	1.00

Note :

- The measurement was searched to 10th harmonic, Remark “---” means that the emissions level is too low to be measured.
- AF: Antenna Factor, Cable: Cable Loss, Pre-Amp: Preamplifier gain, Filter: High Pass Filter Insertion Loss (3.5GHz)
- Analyzer setting P(Peak): RBW=1MHz, VBW=1MHz, A(Average): RBW=1MHz, VBW=10Hz
- Remark “*” means that Restricted band.
- Dist : correction to extra plate reading to 3m specification distance 1m measurement distance = -9.5dB
- The result basic equation calculation is as follow:
 $Level = Reading + AF + Cable - Preamp + Filter - Dist$, $Margin = Level - Limit$
- The other emission levels were very low against the limit
- The test limit distance is 3M limit.
- For 802.11g mode at 6Mbps.
- For Antenna 1 (A530A531).



Ecom Sertech Corp.

Rm. 258, Bldg. 17, NO.195, Sec. 4 Chung Hsing Rd., ChuTung Chen, Hsinchu, Taiwan 310, R.O.C
 TEL:886-3-5918012 FAX : 886-3-5825720

FCC ID : QDWWM168GI
 Report No. : ER03-11-068FRF
 Page 81 of 151

Test Requirement: 15.205

The frequency spectrum above 1 GHz was investigated. All emissions not reported below are more than 40 dB below the prescribed limits. Readings are both peak and average values.

Company	AirVast Technology Inc.	Test Date :	2003/12/23
Product Name	802.11g WLAN USB Module	Test By:	K. P. Pang
Model Name	WM168gi	TEMP&Humidity :	24.8°C , 42%

CH6 TX				Measurement Distance at 1m				Horizontal polarity			
Freq.	Reading	AF	Cable	Pre-amp	Dist	Filter	Level	Limit	Margin	Mark	Height
(MHz)	(dBuV)	(dBuV)	(dB)	(dB)	dB	dB	(dBuV/m)	(dBuV/m)	(dB)	(P/Q/A)	(Meter)
2444.06	61.94	31.76	3.43	0.00	9.50	0.00	87.62	Fundamental Frequency		P	1.00
2444.06	53.35	31.76	3.43	0.00	9.50	0.00	79.03			A	1.00
* 4873.94	45.25	34.77	2.73	35.20	9.50	1.80	39.85	74	-34.15	P	1.00
* 4873.94	33.52	34.77	2.73	35.20	9.50	1.80	28.12	54	-25.88	A	1.00
* 7310.91	44.35	39.78	4.82	35.64	9.50	2.00	45.81	74	-28.19	P	1.00
* 7310.91	32.56	39.78	4.82	35.64	9.50	2.00	34.02	54	-19.98	A	1.00
9748.03	46.86	38.53	5.90	36.60	9.50	0.55	45.74	74	-28.26	P	1.00
9748.03	35.28	38.53	5.90	36.60	9.50	0.55	34.16	54	-19.84	A	1.00
* 12220.30	-----	-----	-----	-----	9.50	0.80	-----	-----	-----	-----	1.00
14664.36	-----	-----	-----	-----	0.00	0.57	-----	-----	-----	-----	1.00
17108.42	-----	-----	-----	-----	0.00	0.54	-----	-----	-----	-----	1.00
* 19552.48	-----	-----	-----	-----	0.00	2.25	-----	-----	-----	-----	1.00
21996.54	-----	-----	-----	-----	0.00	0.70	-----	-----	-----	-----	1.00
24440.60	-----	-----	-----	-----	0.00	2.40	-----	-----	-----	-----	1.00

Note :

- The measurement was searched to 10th harmonic, Remark “---” means that the emissions level is too low to be measured.
- AF: Antenna Factor, Cable: Cable Loss, Pre-Amp: Preamplifier gain, Filter: High Pass Filter Insertion Loss (3.5GHz)
- Analyzer setting P(Peak): RBW=1MHz, VBW=1MHz, A(Average): RBW=1MHz, VBW=10Hz
- Remark “*” means that Restricted band.
- Dist : correction to extra plate reading to 3m specification distance 1m measurement distance = -9.5dB
- The result basic equation calculation is as follow:
 $Level = Reading + AF + Cable - Preamp + Filter - Dist$, $Margin = Level - Limit$
- The other emission levels were very low against the limit
- The test limit distance is 3M limit.
- For 802.11g mode at 6Mbps.
- For Antenna 1 (A530A531).



Ecom Sertech Corp.

Rm. 258, Bldg. 17, NO.195, Sec. 4 Chung Hsing Rd., ChuTung Chen, Hsinchu, Taiwan 310, R.O.C
 TEL:886-3-5918012 FAX : 886-3-5825720

FCC ID : QDWWM168GI
 Report No. : ER03-11-068FRF
 Page 82 of 151

Test Requirement: 15.205

The frequency spectrum above 1 GHz was investigated. All emissions not reported below are more than 40 dB below the prescribed limits. Readings are both peak and average values.

Company	AirVast Technology Inc.	Test Date :	2003/12/23
Product Name	802.11g WLAN USB Module	Test By:	K. P. Pang
Model Name	WM168gi	TEMP&Humidity :	24.8°C , 42%

CH6 TX				Measurement Distance at 1m				Vertical polarity			
Freq.	Reading	AF	Cable	Pre-amp	Dist	Filter	Level	Limit	Margin	Mark	Height
(MHz)	(dBuV)	(dBuV)	(dB)	(dB)	dB	dB	(dBuV/m)	(dBuV/m)	(dB)	(P/Q/A)	(Meter)
2443.96	58.82	31.76	3.43	0.00	9.50	0.00	84.50	Fundamental Frequency		P	1.00
2443.96	50.17	31.76	3.43	0.00	9.50	0.00	75.85			A	1.00
* 4873.98	45.36	34.77	2.73	35.20	9.50	1.80	39.96	74	-34.04	P	1.00
* 4873.98	34.75	34.77	2.73	35.20	9.50	1.80	29.35	54	-24.65	A	1.00
* 7311.05	45.19	39.78	4.82	35.64	9.50	2.00	46.65	74	-27.35	P	1.00
* 7311.05	34.20	39.78	4.82	35.64	9.50	2.00	35.66	54	-18.34	A	1.00
9748.04	47.35	38.53	5.90	36.60	9.50	0.55	46.23	74	-27.77	P	1.00
9748.04	36.11	38.53	5.90	36.60	9.50	0.55	34.99	54	-19.01	A	1.00
* 12219.80	-----	-----	-----	-----	9.50	0.80	-----	-----	-----	-----	1.00
14663.76	-----	-----	-----	-----	0.00	0.57	-----	-----	-----	-----	1.00
17107.72	-----	-----	-----	-----	0.00	0.54	-----	-----	-----	-----	1.00
* 19551.68	-----	-----	-----	-----	0.00	2.25	-----	-----	-----	-----	1.00
21995.64	-----	-----	-----	-----	0.00	0.70	-----	-----	-----	-----	1.00
24439.60	-----	-----	-----	-----	0.00	2.40	-----	-----	-----	-----	1.00

Note :

- The measurement was searched to 10th harmonic, Remark “---” means that the emissions level is too low to be measured.
- AF: Antenna Factor, Cable: Cable Loss, Pre-Amp: Preamplifier gain, Filter: High Pass Filter Insertion Loss (3.5GHz)
- Analyzer setting P(Peak): RBW=1MHz, VBW=1MHz, A(Average): RBW=1MHz, VBW=10Hz
- Remark “*” means that Restricted band.
- Dist : correction to extra plate reading to 3m specification distance 1m measurement distance = -9.5dB
- The result basic equation calculation is as follow:
 $Level = Reading + AF + Cable - Preamp + Filter - Dist$, $Margin = Level - Limit$
- The other emission levels were very low against the limit
- The test limit distance is 3M limit.
- For 802.11g mode at 6Mbps.
- For Antenna 1 (A530A531).



Ecom Sertech Corp.

Rm. 258, Bldg. 17, NO.195, Sec. 4 Chung Hsing Rd., ChuTung Chen, Hsinchu, Taiwan 310, R.O.C
 TEL:886-3-5918012 FAX : 886-3-5825720

FCC ID : QDWWM168GI
 Report No. : ER03-11-068FRF
 Page 83 of 151

Test Requirement: 15.205

The frequency spectrum above 1 GHz was investigated. All emissions not reported below are more than 40 dB below the prescribed limits. Readings are both peak and average values.

Company	AirVast Technology Inc.	Test Date :	2003/12/23
Product Name	802.11g WLAN USB Module	Test By:	K. P. Pang
Model Name	WM168gi	TEMP&Humidity :	24.8°C , 42%

CH11 TX				Measurement Distance at 1m				Horizontal polarity			
Freq.	Reading	AF	Cable	Pre-amp	Dist	Filter	Level	Limit	Margin	Mark	Height
(MHz)	(dBuV)	(dBuV)	(dB)	(dB)	dB	dB	(dBuV/m)	(dBuV/m)	(dB)	(P/Q/A)	(Meter)
2464.25	62.68	31.74	3.27	0.00	9.50	0.00	88.19	Fundamental Frequency		P	1.00
2464.25	54.56	31.74	3.27	0.00	9.50	0.00	80.07			A	1.00
* 2483.60	31.25	31.72	3.12	0.00	9.50	0.00	56.59	74	-17.41	P	1.00
* 2483.60	17.36	31.72	3.12	0.00	9.50	0.00	42.70	54	-11.30	A	1.00
* 4924.13	45.12	35.10	2.64	35.24	9.50	1.60	39.72	74	-34.28	P	1.00
* 4924.13	33.42	35.10	2.64	35.24	9.50	1.60	28.02	54	-25.98	A	1.00
* 7386.11	44.27	39.75	4.85	35.62	9.50	2.00	45.75	74	-28.25	P	1.00
* 7386.11	32.23	39.75	4.85	35.62	9.50	2.00	33.71	54	-20.29	A	1.00
9848.04	46.91	38.52	5.90	36.76	9.50	0.49	45.56	74	-28.44	P	1.00
9848.04	35.33	38.52	5.90	36.76	9.50	0.49	33.98	54	-20.02	A	1.00
* 12321.25	-----	-----	-----	-----	9.50	0.80	-----	-----	-----	-----	1.00
14785.50	-----	-----	-----	-----	0.00	0.47	-----	-----	-----	-----	1.00
17249.75	-----	-----	-----	-----	0.00	0.60	-----	-----	-----	-----	1.00
* 19714.00	-----	-----	-----	-----	0.00	2.41	-----	-----	-----	-----	1.00
* 22178.25	-----	-----	-----	-----	0.00	0.70	-----	-----	-----	-----	1.00
24642.50	-----	-----	-----	-----	0.00	2.10	-----	-----	-----	-----	1.00

Note :

- The measurement was searched to 10th harmonic, Remark “---” means that the emissions level is too low to be measured.
- AF: Antenna Factor, Cable: Cable Loss, Pre-Amp: Preamplifier gain, Filter: High Pass Filter Insertion Loss (3.5GHz)
- Analyzer setting P(Peak): RBW=1MHz, VBW=1MHz, A(Average): RBW=1MHz, VBW=10Hz
- Remark “*” means that Restricted band.
- Dist : correction to extra plate reading to 3m specification distance 1m measurement distance = -9.5dB
- The result basic equation calculation is as follow:
 $Level = Reading + AF + Cable - Preamp + Filter - Dist$, $Margin = Level - Limit$
- The other emission levels were very low against the limit
- The test limit distance is 3M limit.
- For 802.11g mode at 6Mbps.
- For Antenna 1 (A530A531).



Ecom Sertech Corp.

Rm. 258, Bldg. 17, NO.195, Sec. 4 Chung Hsing Rd., ChuTung Chen, Hsinchu, Taiwan 310, R.O.C
 TEL:886-3-5918012 FAX : 886-3-5825720

FCC ID : QDWWM168GI
 Report No. : ER03-11-068FRF
 Page 84 of 151

Test Requirement: 15.205

The frequency spectrum above 1 GHz was investigated. All emissions not reported below are more than 40 dB below the prescribed limits. Readings are both peak and average values.

Company	AirVast Technology Inc.	Test Date :	2003/12/23
Product Name	802.11g WLAN USB Module	Test By:	K. P. Pang
Model Name	WM168gi	TEMP&Humidity :	24.8°C , 42%

CH11 TX				Measurement Distance at 1m				Vertical polarity			
Freq.	Reading	AF	Cable	Pre-amp	Dist	Filter	Level	Limit	Margin	Mark	Height
(MHz)	(dBuV)	(dBuV)	(dB)	(dB)	dB	dB	(dBuV/m)	(dBuV/m)	(dB)	(P/Q/A)	(Meter)
2469.26	60.92	31.73	3.23	0.00	9.50	0.00	86.38	Fundamental Frequency		P	1.00
2469.26	52.35	31.73	3.23	0.00	9.50	0.00	77.81			A	1.00
* 2483.60	31.91	31.72	3.12	0.00	9.50	0.00	57.25	74	-16.75	P	1.00
* 2483.60	17.27	31.72	3.12	0.00	9.50	0.00	42.61	54	-11.39	A	1.00
* 4923.87	45.14	35.10	2.64	35.24	9.50	1.60	39.74	74	-34.26	P	1.00
* 4923.87	34.55	35.10	2.64	35.24	9.50	1.60	29.15	54	-24.85	A	1.00
* 7386.16	45.02	39.75	4.85	35.62	9.50	2.00	46.50	74	-27.50	P	1.00
* 7386.16	34.18	39.75	4.85	35.62	9.50	2.00	35.66	54	-18.34	A	1.00
9847.80	48.38	38.52	5.90	36.76	9.50	0.49	47.03	74	-26.97	P	1.00
9847.80	36.67	38.52	5.90	36.76	9.50	0.49	35.32	54	-18.68	A	1.00
* 12346.30	-----	-----	-----	-----	9.50	0.80	-----	-----	-----	-----	1.00
14815.56	-----	-----	-----	-----	0.00	0.45	-----	-----	-----	-----	1.00
17284.82	-----	-----	-----	-----	0.00	0.61	-----	-----	-----	-----	1.00
* 19754.08	-----	-----	-----	-----	0.00	2.45	-----	-----	-----	-----	1.00
* 22223.34	-----	-----	-----	-----	0.00	0.70	-----	-----	-----	-----	1.00
24692.60	-----	-----	-----	-----	0.00	2.03	-----	-----	-----	-----	1.00

Note :

- The measurement was searched to 10th harmonic, Remark “---” means that the emissions level is too low to be measured.
- AF: Antenna Factor, Cable: Cable Loss, Pre-Amp: Preamplifier gain, Filter: High Pass Filter Insertion Loss (3.5GHz)
- Analyzer setting P(Peak): RBW=1MHz, VBW=1MHz, A(Average): RBW=1MHz, VBW=10Hz
- Remark “*” means that Restricted band.
- Dist : correction to extra plate reading to 3m specification distance 1m measurement distance = -9.5dB
- The result basic equation calculation is as follow:
 $Level = Reading + AF + Cable - Preamp + Filter - Dist$, $Margin = Level - Limit$
- The other emission levels were very low against the limit
- The test limit distance is 3M limit.
- For 802.11g mode at 6Mbps.
- For Antenna 1 (A530A531).



Ecom Sertech Corp.

Rm. 258, Bldg. 17, NO.195, Sec. 4 Chung Hsing Rd., ChuTung Chen, Hsinchu, Taiwan 310, R.O.C
 TEL:886-3-5918012 FAX : 886-3-5825720

FCC ID : QDWWM168GI
 Report No. : ER03-11-068FRF
 Page 85 of 151

Test Requirement: 15.205
 The frequency spectrum above 1 GHz was investigated. All emissions not reported below are more than 40 dB below the prescribed limits. Readings are both peak and average values.

Company	AirVast Technology Inc.	Test Date :	2003/12/23
Product Name	802.11g WLAN USB Module	Test By:	K. P. Pang
Model Name	WM168gi	TEMP&Humidity :	28.1°C , 39%

CH1 TX				Measurement Distance at 1m				Horizontal polarity			
Freq.	Reading	AF	Cable	Pre-amp	Dist	Filter	Level	Limit	Margin	Mark	Height
(MHz)	(dBuV)	(dBuV)	(dB)	(dB)	dB	dB	(dBuV/m)	(dBuV/m)	(dB)	(P/Q/A)	(Meter)
* 2389.95	29.08	31.81	3.84	0.00	9.50	0.00	55.23	74	-18.77	P	1.00
* 2389.95	16.77	31.81	3.84	0.00	9.50	0.00	42.92	54	-11.08	A	1.00
2413.30	75.70	31.79	3.66	0.00	9.50	0.00	101.65	Fundamental Frequency		P	1.00
2413.30	68.90	31.79	3.66	0.00	9.50	0.00	94.85			A	1.00
* 4823.89	44.49	34.44	2.82	35.16	9.50	2.00	39.09	74	-34.91	P	1.00
* 4823.89	33.85	34.44	2.82	35.16	9.50	2.00	28.45	54	-25.55	A	1.00
7235.96	43.66	39.81	4.79	35.65	9.50	2.00	45.11	74	-28.89	P	1.00
7235.96	33.01	39.81	4.79	35.65	9.50	2.00	34.46	54	-19.54	A	1.00
9647.95	46.11	38.54	5.90	36.44	9.50	0.61	45.22	74	-28.78	P	1.00
9647.95	34.73	38.54	5.90	36.44	9.50	0.61	33.84	54	-20.16	A	1.00
* 12066.50	-----	-----	-----	-----	9.50	0.80	-----	-----	-----	-----	1.00
* 14479.80	-----	-----	-----	-----	0.00	0.68	-----	-----	-----	-----	1.00
16893.10	-----	-----	-----	-----	0.00	0.44	-----	-----	-----	-----	1.00
* 19306.40	-----	-----	-----	-----	0.00	1.97	-----	-----	-----	-----	1.00
21719.70	-----	-----	-----	-----	0.00	0.81	-----	-----	-----	-----	1.00
24133.00	-----	-----	-----	-----	0.00	2.89	-----	-----	-----	-----	1.00

Note :

- The measurement was searched to 10th harmonic, Remark “---” means that the emissions level is too low to be measured.
- AF: Antenna Factor, Cable: Cable Loss, Pre-Amp: Preamplifier gain, Filter: High Pass Filter Insertion Loss (3.5GHz)
- Analyzer setting P(Peak): RBW=1MHz, VBW=1MHz, A(Average): RBW=1MHz, VBW=10Hz
- Remark “*” means that Restricted band.
- Dist : correction to extra plate reading to 3m specification distance 1m measurement distance = -9.5dB
- The result basic equation calculation is as follow:
 $Level = Reading + AF + Cable - Preamp + Filter - Dist$, $Margin = Level - Limit$
- The other emission levels were very low against the limit
- The test limit distance is 3M limit.
- For 802.11b mode at 11Mbps.
- For Antenna 2 (A535).



Ecom Sertech Corp.

Rm. 258, Bldg. 17, NO.195, Sec. 4 Chung Hsing Rd., ChuTung Chen, Hsinchu, Taiwan 310, R.O.C
 TEL:886-3-5918012 FAX : 886-3-5825720

FCC ID : QDWWM168GI
 Report No. : ER03-11-068FRF
 Page 86 of 151

Test Requirement: 15.205

The frequency spectrum above 1 GHz was investigated. All emissions not reported below are more than 40 dB below the prescribed limits. Readings are both peak and average values.

Company	AirVast Technology Inc.	Test Date :	2003/12/23
Product Name	802.11g WLAN USB Module	Test By:	K. P. Pang
Model Name	WM168gi	TEMP&Humidity :	28.1°C , 39%

CH1 TX				Measurement Distance at 1m				Vertical polarity			
Freq.	Reading	AF	Cable	Pre-amp	Dist	Filter	Level	Limit	Margin	Mark	Height
(MHz)	(dBuV)	(dBuV)	(dB)	(dB)	dB	dB	(dBuV/m)	(dBuV/m)	(dB)	(P/Q/A)	(Meter)
* 2389.95	30.28	31.81	3.84	0.00	9.50	0.00	56.43	74	-17.57	P	1.00
* 2389.95	17.79	31.81	3.84	0.00	9.50	0.00	43.94	54	-10.06	A	1.00
2413.30	76.96	31.79	3.66	0.00	9.50	0.00	102.91	Fundamental Frequency		P	1.00
2413.30	70.16	31.79	3.66	0.00	9.50	0.00	96.11			A	1.00
* 4824.04	44.61	34.44	2.82	35.16	9.50	2.00	39.21	74	-34.79	P	1.00
* 4824.04	33.19	34.44	2.82	35.16	9.50	2.00	27.79	54	-26.21	A	1.00
7235.97	44.30	39.81	4.79	35.65	9.50	2.00	45.75	74	-28.25	P	1.00
7235.97	33.12	39.81	4.79	35.65	9.50	2.00	34.57	54	-19.43	A	1.00
9648.10	47.52	38.54	5.90	36.44	9.50	0.61	46.63	74	-27.37	P	1.00
9648.10	36.14	38.54	5.90	36.44	9.50	0.61	35.25	54	-18.75	A	1.00
* 12066.50	-----	-----	-----	-----	9.50	0.80	-----	-----	-----	-----	1.00
* 14479.80	-----	-----	-----	-----	0.00	0.68	-----	-----	-----	-----	1.00
16893.10	-----	-----	-----	-----	0.00	0.44	-----	-----	-----	-----	1.00
* 19306.40	-----	-----	-----	-----	0.00	1.97	-----	-----	-----	-----	1.00
21719.70	-----	-----	-----	-----	0.00	0.81	-----	-----	-----	-----	1.00
24133.00	-----	-----	-----	-----	0.00	2.89	-----	-----	-----	-----	1.00

Note :

- The measurement was searched to 10th harmonic, Remark “---” means that the emissions level is too low to be measured.
- AF: Antenna Factor, Cable: Cable Loss, Pre-Amp: Preamplifier gain, Filter: High Pass Filter Insertion Loss (3.5GHz)
- Analyzer setting P(Peak): RBW=1MHz, VBW=1MHz, A(Average): RBW=1MHz, VBW=10Hz
- Remark “*” means that Restricted band.
- Dist : correction to extra plate reading to 3m specification distance 1m measurement distance = -9.5dB
- The result basic equation calculation is as follow:

$$\text{Level} = \text{Reading} + \text{AF} + \text{Cable} - \text{Preamp} + \text{Filter} - \text{Dist}, \text{Margin} = \text{Level} - \text{Limit}$$
- The other emission levels were very low against the limit
- The test limit distance is 3M limit.
- For 802.11b mode at 11Mbps.
- For Antenna 2 (A535).



Ecom Sertech Corp.

Rm. 258, Bldg. 17, NO.195, Sec. 4 Chung Hsing Rd., ChuTung Chen, Hsinchu, Taiwan 310, R.O.C
 TEL:886-3-5918012 FAX : 886-3-5825720

FCC ID : QDWWM168GI
 Report No. : ER03-11-068FRF
 Page 87 of 151

Test Requirement: 15.205

The frequency spectrum above 1 GHz was investigated. All emissions not reported below are more than 40 dB below the prescribed limits. Readings are both peak and average values.

Company	AirVast Technology Inc.	Test Date :	2003/12/23
Product Name	802.11g WLAN USB Module	Test By:	K. P. Pang
Model Name	WM168gi	TEMP&Humidity :	28.1°C , 39%

CH6 TX				Measurement Distance at 1m				Horizontal polarity			
Freq.	Reading	AF	Cable	Pre-amp	Dist	Filter	Level	Limit	Margin	Mark	Height
(MHz)	(dBuV)	(dBuV)	(dB)	(dB)	dB	dB	(dBuV/m)	(dBuV/m)	(dB)	(P/Q/A)	(Meter)
2438.30	74.65	31.76	3.47	0.00	9.50	0.00	100.38	Fundamental Frequency		P	1.00
2438.30	67.56	31.76	3.47	0.00	9.50	0.00	93.29			A	1.00
* 4873.88	43.76	34.77	2.73	35.20	9.50	1.80	38.36	74	-35.64	P	1.00
* 4873.88	32.17	34.77	2.73	35.20	9.50	1.80	26.77	54	-27.23	A	1.00
* 7311.25	44.03	39.78	4.82	35.64	9.50	2.00	45.49	74	-28.51	P	1.00
* 7311.25	33.56	39.78	4.82	35.64	9.50	2.00	35.02	54	-18.98	A	1.00
9747.99	46.47	38.53	5.90	36.60	9.50	0.55	45.35	74	-28.65	P	1.00
9747.99	35.40	38.53	5.90	36.60	9.50	0.55	34.28	54	-19.72	A	1.00
* 12191.50	-----	-----	-----	-----	9.50	0.80	-----	-----	-----	-----	1.00
14629.80	-----	-----	-----	-----	0.00	0.60	-----	-----	-----	-----	1.00
17068.10	-----	-----	-----	-----	0.00	0.53	-----	-----	-----	-----	1.00
* 19506.40	-----	-----	-----	-----	0.00	2.21	-----	-----	-----	-----	1.00
21944.70	-----	-----	-----	-----	0.00	0.72	-----	-----	-----	-----	1.00
24383.00	-----	-----	-----	-----	0.00	2.49	-----	-----	-----	-----	1.00

Note :

- The measurement was searched to 10th harmonic, Remark “---” means that the emissions level is too low to be measured.
- AF: Antenna Factor, Cable: Cable Loss, Pre-Amp: Preamplifier gain, Filter: High Pass Filter Insertion Loss (3.5GHz)
- Analyzer setting P(Peak): RBW=1MHz, VBW=1MHz, A(Average): RBW=1MHz, VBW=10Hz
- Remark “*” means that Restricted band.
- Dist : correction to extra plate reading to 3m specification distance 1m measurement distance = -9.5dB
- The result basic equation calculation is as follow:
 $Level = Reading + AF + Cable - Preamp + Filter - Dist$, $Margin = Level - Limit$
- The other emission levels were very low against the limit
- The test limit distance is 3M limit.
- For 802.11b mode at 11Mbps.
- For Antenna 2 (A535).



Ecom Sertech Corp.

Rm. 258, Bldg. 17, NO.195, Sec. 4 Chung Hsing Rd., ChuTung Chen, Hsinchu, Taiwan 310, R.O.C
 TEL:886-3-5918012 FAX : 886-3-5825720

FCC ID : QDWWM168GI
 Report No. : ER03-11-068FRF
 Page 88 of 151

Test Requirement: 15.205

The frequency spectrum above 1 GHz was investigated. All emissions not reported below are more than 40 dB below the prescribed limits. Readings are both peak and average values.

Company	AirVast Technology Inc.	Test Date :	2003/12/23
Product Name	802.11g WLAN USB Module	Test By:	K. P. Pang
Model Name	WM168gi	TEMP&Humidity :	28.1°C ,39%

CH6 TX				Measurement Distance at 1m				Vertical polarity			
Freq.	Reading	AF	Cable	Pre-amp	Dist	Filter	Level	Limit	Margin	Mark	Height
(MHz)	(dBuV)	(dBuV)	(dB)	(dB)	dB	dB	(dBuV/m)	(dBuV/m)	(dB)	(P/Q/A)	(Meter)
2438.30	75.66	31.76	3.47	0.00	9.50	0.00	101.39	Fundamental Frequency		P	1.00
2438.30	68.59	31.76	3.47	0.00	9.50	0.00	94.32			A	1.00
* 4873.94	44.20	34.77	2.73	35.20	9.50	1.80	38.80	74	-35.20	P	1.00
* 4873.94	32.81	34.77	2.73	35.20	9.50	1.80	27.41	54	-26.59	A	1.00
* 7311.01	44.27	39.78	4.82	35.64	9.50	2.00	45.73	74	-28.27	P	1.00
* 7311.01	33.01	39.78	4.82	35.64	9.50	2.00	34.47	54	-19.53	A	1.00
9747.96	47.43	38.53	5.90	36.60	9.50	0.55	46.31	74	-27.69	P	1.00
9747.96	35.89	38.53	5.90	36.60	9.50	0.55	34.77	54	-19.23	A	1.00
* 12191.50	-----	-----	-----	-----	9.50	0.80	-----	-----	-----	-----	1.00
14629.80	-----	-----	-----	-----	0.00	0.60	-----	-----	-----	-----	1.00
17068.10	-----	-----	-----	-----	0.00	0.53	-----	-----	-----	-----	1.00
* 19506.40	-----	-----	-----	-----	0.00	2.21	-----	-----	-----	-----	1.00
21944.70	-----	-----	-----	-----	0.00	0.72	-----	-----	-----	-----	1.00
24383.00	-----	-----	-----	-----	0.00	2.49	-----	-----	-----	-----	1.00

Note :

- The measurement was searched to 10th harmonic, Remark “---” means that the emissions level is too low to be measured.
- AF: Antenna Factor, Cable: Cable Loss, Pre-Amp: Preamplifier gain, Filter: High Pass Filter Insertion Loss (3.5GHz)
- Analyzer setting P(Peak): RBW=1MHz, VBW=1MHz, A(Average): RBW=1MHz, VBW=10Hz
- Remark “*” means that Restricted band.
- Dist : correction to extra plate reading to 3m specification distance 1m measurement distance = -9.5dB
- The result basic equation calculation is as follow:
 $Level = Reading + AF + Cable - Preamp + Filter - Dist$, $Margin = Level - Limit$
- The other emission levels were very low against the limit
- The test limit distance is 3M limit.
- For 802.11b mode at 11Mbps.
- For Antenna 2 (A535).



Ecom Sertech Corp.

Rm. 258, Bldg. 17, NO.195, Sec. 4 Chung Hsing Rd., ChuTung Chen, Hsinchu, Taiwan 310, R.O.C
 TEL:886-3-5918012 FAX : 886-3-5825720

FCC ID : QDWWM168GI
 Report No. : ER03-11-068FRF
 Page 89 of 151

Test Requirement: 15.205

The frequency spectrum above 1 GHz was investigated. All emissions not reported below are more than 40 dB below the prescribed limits. Readings are both peak and average values.

Company	AirVast Technology Inc.	Test Date :	2003/12/23
Product Name	802.11g WLAN USB Module	Test By:	K. P. Pang
Model Name	WM168gi	TEMP&Humidity :	28.1°C , 39%

CH11 TX				Measurement Distance at 1m				Horizontal polarity			
Freq.	Reading	AF	Cable	Pre-amp	Dist	Filter	Level	Limit	Margin	Mark	Height
(MHz)	(dBuV)	(dBuV)	(dB)	(dB)	dB	dB	(dBuV/m)	(dBuV/m)	(dB)	(P/Q/A)	(Meter)
2463.35	75.89	31.74	3.28	0.00	9.50	0.00	101.41	Fundamental Frequency		P	1.00
2463.35	68.87	31.74	3.28	0.00	9.50	0.00	94.39			A	1.00
* 2483.60	31.47	31.72	3.12	0.00	9.50	0.00	56.81	74	-17.19	P	1.00
* 2483.60	18.71	31.72	3.12	0.00	9.50	0.00	44.05	54	-9.95	A	1.00
* 4924.01	45.11	35.10	2.64	35.24	9.50	1.60	39.71	74	-34.29	P	1.00
* 4924.01	33.20	35.10	2.64	35.24	9.50	1.60	27.80	54	-26.20	A	1.00
* 7386.12	43.80	39.75	4.85	35.62	9.50	2.00	45.28	74	-28.72	P	1.00
* 7386.12	33.34	39.75	4.85	35.62	9.50	2.00	34.82	54	-19.18	A	1.00
9847.90	47.01	38.52	5.90	36.76	9.50	0.49	45.66	74	-28.34	P	1.00
9847.90	35.88	38.52	5.90	36.76	9.50	0.49	34.53	54	-19.47	A	1.00
* 12316.75	-----	-----	-----	-----	9.50	0.80	-----	-----	-----	-----	1.00
14780.10	-----	-----	-----	-----	0.00	0.48	-----	-----	-----	-----	1.00
17243.45	-----	-----	-----	-----	0.00	0.60	-----	-----	-----	-----	1.00
* 19706.80	-----	-----	-----	-----	0.00	2.41	-----	-----	-----	-----	1.00
* 22170.15	-----	-----	-----	-----	0.00	0.70	-----	-----	-----	-----	1.00
24633.50	-----	-----	-----	-----	0.00	2.11	-----	-----	-----	-----	1.00

Note :

- The measurement was searched to 10th harmonic, Remark “---” means that the emissions level is too low to be measured.
- AF: Antenna Factor, Cable: Cable Loss, Pre-Amp: Preamplifier gain, Filter: High Pass Filter Insertion Loss (3.5GHz)
- Analyzer setting P(Peak): RBW=1MHz, VBW=1MHz, A(Average): RBW=1MHz, VBW=10Hz
- Remark “*” means that Restricted band.
- Dist : correction to extra plate reading to 3m specification distance 1m measurement distance = -9.5dB
- The result basic equation calculation is as follow:
 $Level = Reading + AF + Cable - Preamp + Filter - Dist$, $Margin = Level - Limit$
- The other emission levels were very low against the limit
- The test limit distance is 3M limit.
- For 802.11b mode at 11Mbps.
- For Antenna 2 (A535).



Ecom Sertech Corp.

Rm. 258, Bldg. 17, NO.195, Sec. 4 Chung Hsing Rd., Chu Tung Chen, Hsinchu, Taiwan 310, R.O.C
 TEL: 886-3-5918012 FAX: 886-3-5825720

FCC ID : QDWWM168GI
 Report No. : ER03-11-068FRF
 Page 90 of 151

Test Requirement: 15.205

The frequency spectrum above 1 GHz was investigated. All emissions not reported below are more than 40 dB below the prescribed limits. Readings are both peak and average values.

Company	AirVast Technology Inc.	Test Date :	2003/12/23
Product Name	802.11g WLAN USB Module	Test By:	K. P. Pang
Model Name	WM168gi	TEMP&Humidity :	28.1°C , 39%

CH11 TX				Measurement Distance at 1m				Vertical polarity			
Freq.	Reading	AF	Cable	Pre-amp	Dist	Filter	Level	Limit	Margin	Mark	Height
(MHz)	(dBuV)	(dBuV)	(dB)	(dB)	dB	dB	(dBuV/m)	(dBuV/m)	(dB)	(P/Q/A)	(Meter)
2463.25	77.25	31.74	3.28	0.00	9.50	0.00	102.77	Fundamental Frequency		P	1.00
2463.25	70.43	31.74	3.28	0.00	9.50	0.00	95.95			A	1.00
* 2483.60	32.56	31.72	3.12	0.00	9.50	0.00	57.90	74	-16.10	P	1.00
* 2483.60	20.29	31.72	3.12	0.00	9.50	0.00	45.63	54	-8.37	A	1.00
* 4924.05	44.37	35.10	2.64	35.24	9.50	1.60	38.97	74	-35.03	P	1.00
* 4924.05	32.94	35.10	2.64	35.24	9.50	1.60	27.54	54	-26.46	A	1.00
* 7385.98	43.57	39.75	4.85	35.62	9.50	2.00	45.05	74	-28.95	P	1.00
* 7385.98	32.89	39.75	4.85	35.62	9.50	2.00	34.37	54	-19.63	A	1.00
9847.86	47.53	38.52	5.90	36.76	9.50	0.49	46.18	74	-27.82	P	1.00
9847.86	36.00	38.52	5.90	36.76	9.50	0.49	34.65	54	-19.35	A	1.00
* 12316.25	-----	-----	-----	-----	9.50	0.80	-----	-----	-----	-----	1.00
14779.50	-----	-----	-----	-----	0.00	0.48	-----	-----	-----	-----	1.00
17242.75	-----	-----	-----	-----	0.00	0.60	-----	-----	-----	-----	1.00
* 19706.00	-----	-----	-----	-----	0.00	2.41	-----	-----	-----	-----	1.00
* 22169.25	-----	-----	-----	-----	0.00	0.70	-----	-----	-----	-----	1.00
24632.50	-----	-----	-----	-----	0.00	2.11	-----	-----	-----	-----	1.00

Note :

- The measurement was searched to 10th harmonic, Remark “---” means that the emissions level is too low to be measured.
- AF: Antenna Factor, Cable: Cable Loss, Pre-Amp: Preamplifier gain, Filter: High Pass Filter Insertion Loss (3.5GHz)
- Analyzer setting P(Peak): RBW=1MHz, VBW=1MHz, A(Average): RBW=1MHz, VBW=10Hz
- Remark “*” means that Restricted band.
- Dist : correction to extra plate reading to 3m specification distance 1m measurement distance = -9.5dB
- The result basic equation calculation is as follow:
 $Level = Reading + AF + Cable - Preamp + Filter - Dist$, $Margin = Level - Limit$
- The other emission levels were very low against the limit
- The test limit distance is 3M limit.
- For 802.11b mode at 11Mbps.
- For Antenna 2 (A535).



Ecom Sertech Corp.

Rm. 258, Bldg. 17, NO.195, Sec. 4 Chung Hsing Rd., ChuTung Chen, Hsinchu, Taiwan 310, R.O.C
 TEL:886-3-5918012 FAX : 886-3-5825720

FCC ID : QDWWM168GI
 Report No. : ER03-11-068FRF
 Page 91 of 151

Test Requirement: 15.205

The frequency spectrum above 1 GHz was investigated. All emissions not reported below are more than 40 dB below the prescribed limits. Readings are both peak and average values.

Company	AirVast Technology Inc.	Test Date :	2003/12/23
Product Name	802.11g WLAN USB Module	Test By:	K. P. Pang
Model Name	WM168gi	TEMP&Humidity :	24.8°C , 42%

CH1 TX				Measurement Distance at 1m				Horizontal polarity			
Freq.	Reading	AF	Cable	Pre-amp	Dist	Filter	Level	Limit	Margin	Mark	Height
(MHz)	(dBuV)	(dBuV)	(dB)	(dB)	dB	dB	(dBuV/m)	(dBuV/m)	(dB)	(P/Q/A)	(Meter)
* 2389.95	34.53	31.81	3.84	0.00	9.50	0.00	60.68	74	-13.32	P	1.00
* 2389.95	20.17	31.81	3.84	0.00	9.50	0.00	46.32	54	-7.68	A	1.00
2410.30	71.85	31.79	3.68	0.00	9.50	0.00	97.82	Fundamental Frequency		P	1.00
2410.30	63.61	31.79	3.68	0.00	9.50	0.00	89.58			A	1.00
* 4823.85	44.28	34.44	2.82	35.16	9.50	2.00	38.88	74	-35.12	P	1.00
* 4823.85	33.06	34.44	2.82	35.16	9.50	2.00	27.66	54	-26.34	A	1.00
7235.59	45.43	39.81	4.79	35.65	9.50	2.00	46.88	74	-27.12	P	1.00
7235.59	33.97	39.81	4.79	35.65	9.50	2.00	35.42	54	-18.58	A	1.00
9648.33	46.84	38.54	5.90	36.44	9.50	0.61	45.95	74	-28.05	P	1.00
9648.33	35.08	38.54	5.90	36.44	9.50	0.61	34.19	54	-19.81	A	1.00
* 12051.50	-----	-----	-----	-----	9.50	0.80	-----	-----	-----	-----	1.00
14461.80	-----	-----	-----	-----	0.00	0.65	-----	-----	-----	-----	1.00
16872.10	-----	-----	-----	-----	0.00	0.42	-----	-----	-----	-----	1.00
* 19282.40	-----	-----	-----	-----	0.00	1.94	-----	-----	-----	-----	1.00
21692.70	-----	-----	-----	-----	0.00	0.82	-----	-----	-----	-----	1.00
24103.00	-----	-----	-----	-----	0.00	2.94	-----	-----	-----	-----	1.00

Note :

- The measurement was searched to 10th harmonic, Remark “---” means that the emissions level is too low to be measured.
- AF: Antenna Factor, Cable: Cable Loss, Pre-Amp: Preamplifier gain, Filter: High Pass Filter Insertion Loss (3.5GHz)
- Analyzer setting P(Peak): RBW=1MHz, VBW=1MHz, A(Average): RBW=1MHz, VBW=10Hz
- Remark “*” means that Restricted band.
- Dist : correction to extra plate reading to 3m specification distance 1m measurement distance = -9.5dB
- The result basic equation calculation is as follow:
 $Level = Reading + AF + Cable - Preamp + Filter - Dist$, $Margin = Level - Limit$
- The other emission levels were very low against the limit
- The test limit distance is 3M limit.
- For 802.11g mode at 6Mbps.
- For Antenna 2 (A535).



Ecom Sertech Corp.

Rm. 258, Bldg. 17, NO.195, Sec. 4 Chung Hsing Rd., ChuTung Chen, Hsinchu, Taiwan 310, R.O.C
 TEL:886-3-5918012 FAX : 886-3-5825720

FCC ID : QDWWM168GI
 Report No. : ER03-11-068FRF
 Page 92 of 151

Test Requirement: 15.205

The frequency spectrum above 1 GHz was investigated. All emissions not reported below are more than 40 dB below the prescribed limits. Readings are both peak and average values.

Company	AirVast Technology Inc.	Test Date :	2003/12/23
Product Name	802.11g WLAN USB Module	Test By:	K. P. Pang
Model Name	WM168gi	TEMP&Humidity :	24.8°C , 42%

CH1 TX				Measurement Distance at 1m					Vertical polarity			
Freq.	Reading	AF	Cable	Pre-amp	Dist	Filter	Level	Limit	Margin	Mark	Height	
(MHz)	(dBuV)	(dBuV)	(dB)	(dB)	dB	dB	(dBuV/m)	(dBuV/m)	(dB)	(P/Q/A)	(Meter)	
* 2389.95	35.27	31.81	3.84	0.00	9.50	0.00	61.42	74	-12.58	P	1.00	
* 2389.95	20.29	31.81	3.84	0.00	9.50	0.00	46.44	54	-7.56	A	1.00	
2410.35	73.18	31.79	3.68	0.00	9.50	0.00	99.15	Fundamental Frequency		P	1.00	
2410.35	64.82	31.79	3.68	0.00	9.50	0.00	90.79			A	1.00	
* 4824.08	45.06	34.44	2.82	35.16	9.50	2.00	39.66	74	-34.34	P	1.00	
* 4824.08	33.98	34.44	2.82	35.16	9.50	2.00	28.58	54	-25.42	A	1.00	
7236.13	44.69	39.81	4.79	35.65	9.50	2.00	46.14	74	-27.86	P	1.00	
7236.13	33.76	39.81	4.79	35.65	9.50	2.00	35.21	54	-18.79	A	1.00	
9647.98	46.72	38.54	5.90	36.44	9.50	0.61	45.83	74	-28.17	P	1.00	
9647.98	34.64	38.54	5.90	36.44	9.50	0.61	33.75	54	-20.25	A	1.00	
* 12051.75	-----	-----	-----	-----	9.50	0.80	-----	-----	-----	-----	1.00	
14462.10	-----	-----	-----	-----	0.00	0.65	-----	-----	-----	-----	1.00	
16872.45	-----	-----	-----	-----	0.00	0.42	-----	-----	-----	-----	1.00	
* 19282.80	-----	-----	-----	-----	0.00	1.94	-----	-----	-----	-----	1.00	
21693.15	-----	-----	-----	-----	0.00	0.82	-----	-----	-----	-----	1.00	
24103.50	-----	-----	-----	-----	0.00	2.93	-----	-----	-----	-----	1.00	

Note :

- The measurement was searched to 10th harmonic, Remark “---” means that the emissions level is too low to be measured.
- AF: Antenna Factor, Cable: Cable Loss, Pre-Amp: Preamplifier gain, Filter: High Pass Filter Insertion Loss (3.5GHz)
- Analyzer setting P(Peak): RBW=1MHz, VBW=1MHz, A(Average): RBW=1MHz, VBW=10Hz
- Remark “*” means that Restricted band.
- Dist : correction to extra plate reading to 3m specification distance 1m measurement distance = -9.5dB
- The result basic equation calculation is as follow:
 $Level = Reading + AF + Cable - Preamp + Filter - Dist$, $Margin = Level - Limit$
- The other emission levels were very low against the limit
- The test limit distance is 3M limit.
- For 802.11g mode at 6Mbps.
- For Antenna 2 (A535).



Ecom Sertech Corp.

Rm. 258, Bldg. 17, NO.195, Sec. 4 Chung Hsing Rd., ChuTung Chen, Hsinchu, Taiwan 310, R.O.C
 TEL:886-3-5918012 FAX : 886-3-5825720

FCC ID : QDWWM168GI
 Report No. : ER03-11-068FRF
 Page 93 of 151

Test Requirement: 15.205

The frequency spectrum above 1 GHz was investigated. All emissions not reported below are more than 40 dB below the prescribed limits. Readings are both peak and average values.

Company	AirVast Technology Inc.	Test Date :	2003/12/23
Product Name	802.11g WLAN USB Module	Test By:	K. P. Pang
Model Name	WM168gi	TEMP&Humidity :	24.8°C , 42%

CH6 TX				Measurement Distance at 1m				Horizontal polarity			
Freq.	Reading	AF	Cable	Pre-amp	Dist	Filter	Level	Limit	Margin	Mark	Height
(MHz)	(dBuV)	(dBuV)	(dB)	(dB)	dB	dB	(dBuV/m)	(dBuV/m)	(dB)	(P/Q/A)	(Meter)
2439.21	70.85	31.76	3.46	0.00	9.50	0.00	96.57	Fundamental Frequency		P	1.00
2439.21	62.59	31.76	3.46	0.00	9.50	0.00	88.31			A	1.00
* 4873.93	44.55	34.77	2.73	35.20	9.50	1.80	39.15	74	-34.85	P	1.00
* 4873.93	32.50	34.77	2.73	35.20	9.50	1.80	27.10	54	-26.90	A	1.00
* 7310.91	44.29	39.78	4.82	35.64	9.50	2.00	45.75	74	-28.25	P	1.00
* 7310.91	33.50	39.78	4.82	35.64	9.50	2.00	34.96	54	-19.04	A	1.00
9748.03	47.09	38.53	5.90	36.60	9.50	0.55	45.97	74	-28.03	P	1.00
9748.03	36.02	38.53	5.90	36.60	9.50	0.55	34.90	54	-19.10	A	1.00
* 12196.05	-----	-----	-----	-----	9.50	0.80	-----	-----	-----	-----	1.00
14635.26	-----	-----	-----	-----	0.00	0.59	-----	-----	-----	-----	1.00
17074.47	-----	-----	-----	-----	0.00	0.53	-----	-----	-----	-----	1.00
* 19513.68	-----	-----	-----	-----	0.00	2.21	-----	-----	-----	-----	1.00
21952.89	-----	-----	-----	-----	0.00	0.72	-----	-----	-----	-----	1.00
24392.10	-----	-----	-----	-----	0.00	2.47	-----	-----	-----	-----	1.00

Note :

- The measurement was searched to 10th harmonic, Remark “---” means that the emissions level is too low to be measured.
- AF: Antenna Factor, Cable: Cable Loss, Pre-Amp: Preamplifier gain, Filter: High Pass Filter Insertion Loss (3.5GHz)
- Analyzer setting P(Peak): RBW=1MHz, VBW=1MHz, A(Average): RBW=1MHz, VBW=10Hz
- Remark “*” means that Restricted band.
- Dist : correction to extra plate reading to 3m specification distance 1m measurement distance = -9.5dB
- The result basic equation calculation is as follow:
 $Level = Reading + AF + Cable - Preamp + Filter - Dist$, $Margin = Level - Limit$
- The other emission levels were very low against the limit
- The test limit distance is 3M limit.
- For 802.11g mode at 6Mbps.
- For Antenna 2 (A535).



Ecom Sertech Corp.

Rm. 258, Bldg. 17, NO.195, Sec. 4 Chung Hsing Rd., ChuTung Chen, Hsinchu, Taiwan 310, R.O.C
 TEL:886-3-5918012 FAX : 886-3-5825720

FCC ID : QDWWM168GI
 Report No. : ER03-11-068FRF
 Page 94 of 151

Test Requirement: 15.205

The frequency spectrum above 1 GHz was investigated. All emissions not reported below are more than 40 dB below the prescribed limits. Readings are both peak and average values.

Company	AirVast Technology Inc.	Test Date :	2003/12/23
Product Name	802.11g WLAN USB Module	Test By:	K. P. Pang
Model Name	WM168gi	TEMP&Humidity :	24.8°C , 42%

CH6 TX				Measurement Distance at 1m				Vertical polarity			
Freq.	Reading	AF	Cable	Pre-amp	Dist	Filter	Level	Limit	Margin	Mark	Height
(MHz)	(dBuV)	(dBuV)	(dB)	(dB)	dB	dB	(dBuV/m)	(dBuV/m)	(dB)	(P/Q/A)	(Meter)
2439.31	71.82	31.76	3.46	0.00	9.50	0.00	97.54	Fundamental Frequency		P	1.00
2439.31	63.48	31.76	3.46	0.00	9.50	0.00	89.20			A	1.00
* 4873.88	45.21	34.77	2.73	35.20	9.50	1.80	39.81	74	-34.19	P	1.00
* 4873.88	34.11	34.77	2.73	35.20	9.50	1.80	28.71	54	-25.29	A	1.00
* 7310.84	45.15	39.78	4.82	35.64	9.50	2.00	46.61	74	-27.39	P	1.00
* 7310.84	33.73	39.78	4.82	35.64	9.50	2.00	35.19	54	-18.81	A	1.00
9748.09	47.35	38.53	5.90	36.60	9.50	0.55	46.23	74	-27.77	P	1.00
9748.09	36.12	38.53	5.90	36.60	9.50	0.55	35.00	54	-19.00	A	1.00
* 12196.55	-----	-----	-----	-----	9.50	0.80	-----	-----	-----	-----	1.00
14635.86	-----	-----	-----	-----	0.00	0.59	-----	-----	-----	-----	1.00
17075.17	-----	-----	-----	-----	0.00	0.53	-----	-----	-----	-----	1.00
* 19514.48	-----	-----	-----	-----	0.00	2.21	-----	-----	-----	-----	1.00
21953.79	-----	-----	-----	-----	0.00	0.72	-----	-----	-----	-----	1.00
24393.10	-----	-----	-----	-----	0.00	2.47	-----	-----	-----	-----	1.00

Note :

- The measurement was searched to 10th harmonic, Remark “---” means that the emissions level is too low to be measured.
- AF: Antenna Factor, Cable: Cable Loss, Pre-Amp: Preamplifier gain, Filter: High Pass Filter Insertion Loss (3.5GHz)
- Analyzer setting P(Peak): RBW=1MHz, VBW=1MHz, A(Average): RBW=1MHz, VBW=10Hz
- Remark “*” means that Restricted band.
- Dist : correction to extra plate reading to 3m specification distance 1m measurement distance = -9.5dB
- The result basic equation calculation is as follow:
 $Level = Reading + AF + Cable - Preamp + Filter - Dist$, $Margin = Level - Limit$
- The other emission levels were very low against the limit
- The test limit distance is 3M limit.
- For 802.11g mode at 6Mbps.
- For Antenna 2 (A535).



Ecom Sertech Corp.

Rm. 258, Bldg. 17, NO.195, Sec. 4 Chung Hsing Rd., ChuTung Chen, Hsinchu, Taiwan 310, R.O.C
 TEL:886-3-5918012 FAX : 886-3-5825720

FCC ID : QDWWM168GI
 Report No. : ER03-11-068FRF
 Page 95 of 151

Test Requirement: 15.205

The frequency spectrum above 1 GHz was investigated. All emissions not reported below are more than 40 dB below the prescribed limits. Readings are both peak and average values.

Company	AirVast Technology Inc.	Test Date :	2003/12/23
Product Name	802.11g WLAN USB Module	Test By:	K. P. Pang
Model Name	WM168gi	TEMP&Humidity :	24.8°C , 42%

CH11 TX				Measurement Distance at 1m				Horizontal polarity			
Freq.	Reading	AF	Cable	Pre-amp	Dist	Filter	Level	Limit	Margin	Mark	Height
(MHz)	(dBuV)	(dBuV)	(dB)	(dB)	dB	dB	(dBuV/m)	(dBuV/m)	(dB)	(P/Q/A)	(Meter)
2464.31	71.59	31.74	3.27	0.00	9.50	0.00	97.10	Fundamental Frequency		P	1.00
2464.31	63.44	31.74	3.27	0.00	9.50	0.00	88.95			A	1.00
* 2483.60	35.76	31.72	3.12	0.00	9.50	0.00	61.10	74	-12.90	P	1.00
* 2483.60	22.23	31.72	3.12	0.00	9.50	0.00	47.57	54	-6.43	A	1.00
* 4924.05	44.16	35.10	2.64	35.24	9.50	1.60	38.76	74	-35.24	P	1.00
* 4924.05	32.52	35.10	2.64	35.24	9.50	1.60	27.12	54	-26.88	A	1.00
* 7385.98	45.13	39.75	4.85	35.62	9.50	2.00	46.61	74	-27.39	P	1.00
* 7385.98	34.47	39.75	4.85	35.62	9.50	2.00	35.95	54	-18.05	A	1.00
9848.05	47.50	38.52	5.90	36.76	9.50	0.49	46.15	74	-27.85	P	1.00
9848.05	36.24	38.52	5.90	36.76	9.50	0.49	34.89	54	-19.11	A	1.00
* 12321.55	-----	-----	-----	-----	9.50	0.80	-----	-----	-----	-----	1.00
14785.86	-----	-----	-----	-----	0.00	0.47	-----	-----	-----	-----	1.00
17250.17	-----	-----	-----	-----	0.00	0.60	-----	-----	-----	-----	1.00
* 19714.48	-----	-----	-----	-----	0.00	2.41	-----	-----	-----	-----	1.00
* 22178.79	-----	-----	-----	-----	0.00	0.70	-----	-----	-----	-----	1.00
24643.10	-----	-----	-----	-----	0.00	2.10	-----	-----	-----	-----	1.00

Note :

- The measurement was searched to 10th harmonic, Remark “---” means that the emissions level is too low to be measured.
- AF: Antenna Factor, Cable: Cable Loss, Pre-Amp: Preamplifier gain, Filter: High Pass Filter Insertion Loss (3.5GHz)
- Analyzer setting P(Peak): RBW=1MHz, VBW=1MHz, A(Average): RBW=1MHz, VBW=10Hz
- Remark “*” means that Restricted band.
- Dist : correction to extra plate reading to 3m specification distance 1m measurement distance = -9.5dB
- The result basic equation calculation is as follow:
 $Level = Reading + AF + Cable - Preamp + Filter - Dist$, $Margin = Level - Limit$
- The other emission levels were very low against the limit
- The test limit distance is 3M limit.
- For 802.11g mode at 6Mbps.
- For Antenna 2 (A535).



Ecom Sertech Corp.

Rm. 258, Bldg. 17, NO.195, Sec. 4 Chung Hsing Rd., ChuTung Chen, Hsinchu, Taiwan 310, R.O.C
 TEL:886-3-5918012 FAX : 886-3-5825720

FCC ID : QDWWM168GI
 Report No. : ER03-11-068FRF
 Page 96 of 151

Test Requirement: 15.205

The frequency spectrum above 1 GHz was investigated. All emissions not reported below are more than 40 dB below the prescribed limits. Readings are both peak and average values.

Company	AirVast Technology Inc.	Test Date :	2003/12/23
Product Name	802.11g WLAN USB Module	Test By:	K. P. Pang
Model Name	WM168gi	TEMP&Humidity :	24.8°C , 42%

CH11 TX				Measurement Distance at 1m				Vertical polarity			
Freq.	Reading	AF	Cable	Pre-amp	Dist	Filter	Level	Limit	Margin	Mark	Height
(MHz)	(dBuV)	(dBuV)	(dB)	(dB)	dB	dB	(dBuV/m)	(dBuV/m)	(dB)	(P/Q/A)	(Meter)
2464.21	73.30	31.74	3.27	0.00	9.50	0.00	98.81	Fundamental Frequency		P	1.00
2464.21	64.90	31.74	3.27	0.00	9.50	0.00	90.41			A	1.00
* 2483.60	37.69	31.72	3.12	0.00	9.50	0.00	63.03	74	-10.97	P	1.00
* 2483.60	24.28	31.72	3.12	0.00	9.50	0.00	49.62	54	-4.38	A	1.00
* 4923.81	43.80	35.10	2.64	35.24	9.50	1.60	38.40	74	-35.60	P	1.00
* 4923.81	32.41	35.10	2.64	35.24	9.50	1.60	27.01	54	-26.99	A	1.00
* 7386.05	45.28	39.75	4.85	35.62	9.50	2.00	46.76	74	-27.24	P	1.00
* 7386.05	34.19	39.75	4.85	35.62	9.50	2.00	35.67	54	-18.33	A	1.00
9848.09	47.27	38.52	5.90	36.76	9.50	0.49	45.92	74	-28.08	P	1.00
9848.09	35.61	38.52	5.90	36.76	9.50	0.49	34.26	54	-19.74	A	1.00
* 12321.05	-----	-----	-----	-----	9.50	0.80	-----	-----	-----	-----	1.00
14785.26	-----	-----	-----	-----	0.00	0.47	-----	-----	-----	-----	1.00
17249.47	-----	-----	-----	-----	0.00	0.60	-----	-----	-----	-----	1.00
* 19713.68	-----	-----	-----	-----	0.00	2.41	-----	-----	-----	-----	1.00
* 22177.89	-----	-----	-----	-----	0.00	0.70	-----	-----	-----	-----	1.00
24642.10	-----	-----	-----	-----	0.00	2.10	-----	-----	-----	-----	1.00

Note :

- The measurement was searched to 10th harmonic, Remark “---” means that the emissions level is too low to be measured.
- AF: Antenna Factor, Cable: Cable Loss, Pre-Amp: Preamplifier gain, Filter: High Pass Filter Insertion Loss (3.5GHz)
- Analyzer setting P(Peak): RBW=1MHz, VBW=1MHz, A(Average): RBW=1MHz, VBW=10Hz
- Remark “*” means that Restricted band.
- Dist : correction to extra plate reading to 3m specification distance 1m measurement distance = -9.5dB
- The result basic equation calculation is as follow:
 $Level = Reading + AF + Cable - Preamp + Filter - Dist$, $Margin = Level - Limit$
- The other emission levels were very low against the limit
- The test limit distance is 3M limit.
- For 802.11g mode at 6Mbps.
- For Antenna 2 (A535).



Ecom Sertech Corp.

Rm. 258, Bldg. 17, NO.195, Sec. 4 Chung Hsing Rd., ChuTung Chen, Hsinchu, Taiwan 310, R.O.C
 TEL:886-3-5918012 FAX : 886-3-5825720

FCC ID : QDWWM168GI
 Report No. : ER03-11-068FRF
 Page 97 of 151

Test Requirement: 15.205

The frequency spectrum above 1 GHz was investigated. All emissions not reported below are more than 40 dB below the prescribed limits. Readings are both peak and average values.

Company	AirVast Technology Inc.	Test Date :	2003/12/20
Product Name	802.11g WLAN USB Module	Test By:	K. P. Pang
Model Name	WM168gi	TEMP&Humidity :	13.5°C , 45%

CH1 TX				Measurement Distance at 1m				Horizontal polarity			
Freq.	Reading	AF	Cable	Pre-amp	Dist	Filter	Level	Limit	Margin	Mark	Height
(MHz)	(dBuV)	(dBuV)	(dB)	(dB)	dB	dB	(dBuV/m)	(dBuV/m)	(dB)	(P/Q/A)	(Meter)
* 2389.95	33.66	31.81	3.84	0.00	9.50	0.00	59.81	74	-14.19	P	1.00
* 2389.95	21.63	31.81	3.84	0.00	9.50	0.00	47.78	54	-6.22	A	1.00
2413.30	83.65	31.79	3.66	0.00	9.50	0.00	109.60	Fundamental Frequency		P	1.00
2413.30	76.75	31.79	3.66	0.00	9.50	0.00	102.70			A	1.00
* 4823.99	45.68	34.44	2.82	35.16	9.50	2.00	40.28	74	-33.72	P	1.00
* 4823.99	33.38	34.44	2.82	35.16	9.50	2.00	27.98	54	-26.02	A	1.00
7235.91	44.52	39.81	4.79	35.65	9.50	2.00	45.97	74	-28.03	P	1.00
7235.91	33.85	39.81	4.79	35.65	9.50	2.00	35.30	54	-18.70	A	1.00
9647.96	47.62	38.54	5.90	36.44	9.50	0.61	46.73	74	-27.27	P	1.00
9647.96	35.58	38.54	5.90	36.44	9.50	0.61	34.69	54	-19.31	A	1.00
* 12066.50	-----	-----	-----	-----	9.50	0.80	-----	-----	-----	-----	1.00
* 14479.80	-----	-----	-----	-----	0.00	0.68	-----	-----	-----	-----	1.00
16893.10	-----	-----	-----	-----	0.00	0.44	-----	-----	-----	-----	1.00
* 19306.40	-----	-----	-----	-----	0.00	1.97	-----	-----	-----	-----	1.00
21719.70	-----	-----	-----	-----	0.00	0.81	-----	-----	-----	-----	1.00
24133.00	-----	-----	-----	-----	0.00	2.89	-----	-----	-----	-----	1.00

Note :

- The measurement was searched to 10th harmonic, Remark “---” means that the emissions level is too low to be measured.
- AF: Antenna Factor, Cable: Cable Loss, Pre-Amp: Preamplifier gain, Filter: High Pass Filter Insertion Loss (3.5GHz)
- Analyzer setting P(Peak): RBW=1MHz, VBW=1MHz, A(Average): RBW=1MHz, VBW=10Hz
- Remark “*” means that Restricted band.
- Dist : correction to extra plate reading to 3m specification distance 1m measurement distance = -9.5dB
- The result basic equation calculation is as follow:
 $Level = Reading + AF + Cable - Preamp + Filter - Dist$, $Margin = Level - Limit$
- The other emission levels were very low against the limit
- The test limit distance is 3M limit.
- For 802.11b mode at 11Mbps.
- For Antenna 3 (A800).



Ecom Sertech Corp.

Rm. 258, Bldg. 17, NO.195, Sec. 4 Chung Hsing Rd., ChuTung Chen, Hsinchu, Taiwan 310, R.O.C
 TEL:886-3-5918012 FAX : 886-3-5825720

FCC ID : QDWWM168GI
 Report No. : ER03-11-068FRF
 Page 98 of 151

Test Requirement: 15.205

The frequency spectrum above 1 GHz was investigated. All emissions not reported below are more than 40 dB below the prescribed limits. Readings are both peak and average values.

Company	AirVast Technology Inc.	Test Date :	2003/12/20
Product Name	802.11g WLAN USB Module	Test By:	K. P. Pang
Model Name	WM168gi	TEMP&Humidity :	13.5°C , 45%

CH1 TX				Measurement Distance at 1m					Vertical polarity			
Freq.	Reading	AF	Cable	Pre-amp	Dist	Filter	Level	Limit	Margin	Mark	Height	
(MHz)	(dBuV)	(dBuV)	(dB)	(dB)	dB	dB	(dBuV/m)	(dBuV/m)	(dB)	(P/Q/A)	(Meter)	
* 2389.95	31.17	31.81	3.84	0.00	9.50	0.00	57.32	74	-16.68	P	1.00	
* 2389.95	20.29	31.81	3.84	0.00	9.50	0.00	46.44	54	-7.56	A	1.00	
2413.30	85.29	31.79	3.66	0.00	9.50	0.00	111.24	Fundamental Frequency		P	1.00	
2413.30	78.59	31.79	3.66	0.00	9.50	0.00	104.54			A	1.00	
* 4824.08	46.24	34.44	2.82	35.16	9.50	2.00	40.84	74	-33.16	P	1.00	
* 4824.08	35.40	34.44	2.82	35.16	9.50	2.00	30.00	54	-24.00	A	1.00	
7235.89	46.23	39.81	4.79	35.65	9.50	2.00	47.68	74	-26.32	P	1.00	
7235.89	34.45	39.81	4.79	35.65	9.50	2.00	35.90	54	-18.10	A	1.00	
9647.95	48.55	38.54	5.90	36.44	9.50	0.61	47.66	74	-26.34	P	1.00	
9647.95	37.28	38.54	5.90	36.44	9.50	0.61	36.39	54	-17.61	A	1.00	
* 12066.50	-----	-----	-----	-----	9.50	0.80	-----	-----	-----	-----	1.00	
* 14479.80	-----	-----	-----	-----	0.00	0.68	-----	-----	-----	-----	1.00	
16893.10	-----	-----	-----	-----	0.00	0.44	-----	-----	-----	-----	1.00	
* 19306.40	-----	-----	-----	-----	0.00	1.97	-----	-----	-----	-----	1.00	
21719.70	-----	-----	-----	-----	0.00	0.81	-----	-----	-----	-----	1.00	
24133.00	-----	-----	-----	-----	0.00	2.89	-----	-----	-----	-----	1.00	

Note :

- The measurement was searched to 10th harmonic, Remark “---” means that the emissions level is too low to be measured.
- AF: Antenna Factor, Cable: Cable Loss, Pre-Amp: Preamplifier gain, Filter: High Pass Filter Insertion Loss (3.5GHz)
- Analyzer setting P(Peak): RBW=1MHz, VBW=1MHz, A(Average): RBW=1MHz, VBW=10Hz
- Remark “*” means that Restricted band.
- Dist : correction to extra plate reading to 3m specification distance 1m measurement distance = -9.5dB
- The result basic equation calculation is as follow:

$$\text{Level} = \text{Reading} + \text{AF} + \text{Cable} - \text{Preamp} + \text{Filter} - \text{Dist}, \text{Margin} = \text{Level} - \text{Limit}$$
- The other emission levels were very low against the limit
- The test limit distance is 3M limit.
- For 802.11b mode at 11Mbps.
- For Antenna 3 (A800).



Ecom Sertech Corp.

Rm. 258, Bldg. 17, NO.195, Sec. 4 Chung Hsing Rd., ChuTung Chen, Hsinchu, Taiwan 310, R.O.C
 TEL:886-3-5918012 FAX : 886-3-5825720

FCC ID : QDWWM168GI
 Report No. : ER03-11-068FRF
 Page 99 of 151

Test Requirement: 15.205

The frequency spectrum above 1 GHz was investigated. All emissions not reported below are more than 40 dB below the prescribed limits. Readings are both peak and average values.

Company	AirVast Technology Inc.	Test Date :	2003/12/20
Product Name	802.11g WLAN USB Module	Test By:	K. P. Pang
Model Name	WM168gi	TEMP&Humidity :	13.5°C , 45%

CH6 TX				Measurement Distance at 1m				Horizontal polarity			
Freq.	Reading	AF	Cable	Pre-amp	Dist	Filter	Level	Limit	Margin	Mark	Height
(MHz)	(dBuV)	(dBuV)	(dB)	(dB)	dB	dB	(dBuV/m)	(dBuV/m)	(dB)	(P/Q/A)	(Meter)
2438.30	84.41	31.76	3.47	0.00	9.50	0.00	110.14	Fundamental Frequency		P	1.00
2438.30	77.39	31.76	3.47	0.00	9.50	0.00	103.12			A	1.00
* 4874.03	46.17	34.77	2.73	35.20	9.50	1.80	40.77	74	-33.23	P	1.00
* 4874.03	33.75	34.77	2.73	35.20	9.50	1.80	28.35	54	-25.65	A	1.00
* 7311.34	44.37	39.78	4.82	35.64	9.50	2.00	45.83	74	-28.17	P	1.00
* 7311.34	33.82	39.78	4.82	35.64	9.50	2.00	35.28	54	-18.72	A	1.00
9748.02	48.10	38.53	5.90	36.60	9.50	0.55	46.98	74	-27.02	P	1.00
9748.02	36.42	38.53	5.90	36.60	9.50	0.55	35.30	54	-18.70	A	1.00
* 12191.50	-----	-----	-----	-----	9.50	0.80	-----	-----	-----	-----	1.00
14629.80	-----	-----	-----	-----	0.00	0.60	-----	-----	-----	-----	1.00
17068.10	-----	-----	-----	-----	0.00	0.53	-----	-----	-----	-----	1.00
* 19506.40	-----	-----	-----	-----	0.00	2.21	-----	-----	-----	-----	1.00
21944.70	-----	-----	-----	-----	0.00	0.72	-----	-----	-----	-----	1.00
24383.00	-----	-----	-----	-----	0.00	2.49	-----	-----	-----	-----	1.00

Note :

- The measurement was searched to 10th harmonic, Remark “---” means that the emissions level is too low to be measured.
- AF: Antenna Factor, Cable: Cable Loss, Pre-Amp: Preamplifier gain, Filter: High Pass Filter Insertion Loss (3.5GHz)
- Analyzer setting P(Peak): RBW=1MHz, VBW=1MHz, A(Average): RBW=1MHz, VBW=10Hz
- Remark “*” means that Restricted band.
- Dist : correction to extra plate reading to 3m specification distance 1m measurement distance = -9.5dB
- The result basic equation calculation is as follow:
 $Level = Reading + AF + Cable - Preamp + Filter - Dist$, $Margin = Level - Limit$
- The other emission levels were very low against the limit
- The test limit distance is 3M limit.
- For 802.11b mode at 11Mbps.
- For Antenna 3 (A800).



Ecom Sertech Corp.

Rm. 258, Bldg. 17, NO.195, Sec. 4 Chung Hsing Rd., ChuTung Chen, Hsinchu, Taiwan 310, R.O.C
 TEL:886-3-5918012 FAX : 886-3-5825720

FCC ID : QDWWM168GI
 Report No. : ER03-11-068FRF
 Page 100 of 151

Test Requirement: 15.205

The frequency spectrum above 1 GHz was investigated. All emissions not reported below are more than 40 dB below the prescribed limits. Readings are both peak and average values.

Company	AirVast Technology Inc.	Test Date :	2003/12/20
Product Name	802.11g WLAN USB Module	Test By:	K. P. Pang
Model Name	WM168gi	TEMP&Humidity :	13.5°C , 45%

CH6 TX				Measurement Distance at 1m				Vertical polarity			
Freq.	Reading	AF	Cable	Pre-amp	Dist	Filter	Level	Limit	Margin	Mark	Height
(MHz)	(dBuV)	(dBuV)	(dB)	(dB)	dB	dB	(dBuV/m)	(dBuV/m)	(dB)	(P/Q/A)	(Meter)
2438.30	85.00	31.76	3.47	0.00	9.50	0.00	110.73	Fundamental Frequency		P	1.00
2438.30	78.06	31.76	3.47	0.00	9.50	0.00	103.79			A	1.00
* 4874.09	46.52	34.77	2.73	35.20	9.50	1.80	41.12	74	-32.88	P	1.00
* 4874.09	35.58	34.77	2.73	35.20	9.50	1.80	30.18	54	-23.82	A	1.00
* 7311.14	45.84	39.78	4.82	35.64	9.50	2.00	47.30	74	-26.70	P	1.00
* 7311.14	34.42	39.78	4.82	35.64	9.50	2.00	35.88	54	-18.12	A	1.00
9747.85	48.57	38.53	5.90	36.60	9.50	0.55	47.45	74	-26.55	P	1.00
9747.85	37.22	38.53	5.90	36.60	9.50	0.55	36.10	54	-17.90	A	1.00
* 12191.50	-----	-----	-----	-----	9.50	0.80	-----	-----	-----	-----	1.00
14629.80	-----	-----	-----	-----	0.00	0.60	-----	-----	-----	-----	1.00
17068.10	-----	-----	-----	-----	0.00	0.53	-----	-----	-----	-----	1.00
* 19506.40	-----	-----	-----	-----	0.00	2.21	-----	-----	-----	-----	1.00
21944.70	-----	-----	-----	-----	0.00	0.72	-----	-----	-----	-----	1.00
24383.00	-----	-----	-----	-----	0.00	2.49	-----	-----	-----	-----	1.00

Note :

- The measurement was searched to 10th harmonic, Remark “---” means that the emissions level is too low to be measured.
- AF: Antenna Factor, Cable: Cable Loss, Pre-Amp: Preamplifier gain, Filter: High Pass Filter Insertion Loss (3.5GHz)
- Analyzer setting P(Peak): RBW=1MHz, VBW=1MHz, A(Average): RBW=1MHz, VBW=10Hz
- Remark “*” means that Restricted band.
- Dist : correction to extra plate reading to 3m specification distance 1m measurement distance = -9.5dB
- The result basic equation calculation is as follow:
 $Level = Reading + AF + Cable - Preamp + Filter - Dist$, $Margin = Level - Limit$
- The other emission levels were very low against the limit
- The test limit distance is 3M limit.
- For 802.11b mode at 11Mbps.
- For Antenna 3 (A800).



Ecom Sertech Corp.

Rm. 258, Bldg. 17, NO.195, Sec. 4 Chung Hsing Rd., ChuTung Chen, Hsinchu, Taiwan 310, R.O.C
 TEL:886-3-5918012 FAX : 886-3-5825720

FCC ID : QDWWM168GI
 Report No. : ER03-11-068FRF
 Page 101 of 151

Test Requirement: 15.205

The frequency spectrum above 1 GHz was investigated. All emissions not reported below are more than 40 dB below the prescribed limits. Readings are both peak and average values.

Company	AirVast Technology Inc.	Test Date :	2003/12/20
Product Name	802.11g WLAN USB Module	Test By:	K. P. Pang
Model Name	WM168gi	TEMP&Humidity :	13.5°C , 45%

CH11 TX				Measurement Distance at 1m				Horizontal polarity			
Freq.	Reading	AF	Cable	Pre-amp	Dist	Filter	Level	Limit	Margin	Mark	Height
(MHz)	(dBuV)	(dBuV)	(dB)	(dB)	dB	dB	(dBuV/m)	(dBuV/m)	(dB)	(P/Q/A)	(Meter)
2463.35	85.56	31.74	3.28	0.00	9.50	0.00	111.08	Fundamental Frequency		P	1.00
2463.35	78.80	31.74	3.28	0.00	9.50	0.00	104.32			A	1.00
* 2483.60	34.14	31.72	3.12	0.00	9.50	0.00	59.48	74	-14.52	P	1.00
* 2483.60	21.63	31.72	3.12	0.00	9.50	0.00	46.97	54	-7.03	A	1.00
* 4924.05	45.80	35.10	2.64	35.24	9.50	1.60	40.40	74	-33.60	P	1.00
* 4924.05	33.58	35.10	2.64	35.24	9.50	1.60	28.18	54	-25.82	A	1.00
* 7386.15	44.26	39.75	4.85	35.62	9.50	2.00	45.74	74	-28.26	P	1.00
* 7386.15	33.71	39.75	4.85	35.62	9.50	2.00	35.19	54	-18.81	A	1.00
9848.36	48.02	38.52	5.90	36.76	9.50	0.49	46.67	74	-27.33	P	1.00
9848.36	36.36	38.52	5.90	36.76	9.50	0.49	35.01	54	-18.99	A	1.00
* 12316.75	-----	-----	-----	-----	9.50	0.80	-----	-----	-----	-----	1.00
14780.10	-----	-----	-----	-----	0.00	0.48	-----	-----	-----	-----	1.00
17243.45	-----	-----	-----	-----	0.00	0.60	-----	-----	-----	-----	1.00
* 19706.80	-----	-----	-----	-----	0.00	2.41	-----	-----	-----	-----	1.00
* 22170.15	-----	-----	-----	-----	0.00	0.70	-----	-----	-----	-----	1.00
24633.50	-----	-----	-----	-----	0.00	2.11	-----	-----	-----	-----	1.00

Note :

- The measurement was searched to 10th harmonic, Remark “---” means that the emissions level is too low to be measured.
- AF: Antenna Factor, Cable: Cable Loss, Pre-Amp: Preamplifier gain, Filter: High Pass Filter Insertion Loss (3.5GHz)
- Analyzer setting P(Peak): RBW=1MHz, VBW=1MHz, A(Average): RBW=1MHz, VBW=10Hz
- Remark “*” means that Restricted band.
- Dist : correction to extra plate reading to 3m specification distance 1m measurement distance = -9.5dB
- The result basic equation calculation is as follow:
 Level = Reading + AF + Cable - Preamp + Filter - Dist, Margin = Level - Limit
- The other emission levels were very low against the limit
- The test limit distance is 3M limit.
- For 802.11b mode at 11Mbps.
- For Antenna 3 (A800).



Ecom Sertech Corp.

Rm. 258, Bldg. 17, NO.195, Sec. 4 Chung Hsing Rd., Chu Tung Chen, Hsinchu, Taiwan 310, R.O.C
 TEL: 886-3-5918012 FAX: 886-3-5825720

FCC ID : QDWWM168GI
 Report No. : ER03-11-068FRF
 Page 102 of 151

Test Requirement: 15.205

The frequency spectrum above 1 GHz was investigated. All emissions not reported below are more than 40 dB below the prescribed limits. Readings are both peak and average values.

Company	AirVast Technology Inc.	Test Date :	2003/12/20
Product Name	802.11g WLAN USB Module	Test By:	K. P. Pang
Model Name	WM168gi	TEMP&Humidity :	13.5°C , 45%

CH11 TX				Measurement Distance at 1m				Vertical polarity			
Freq.	Reading	AF	Cable	Pre-amp	Dist	Filter	Level	Limit	Margin	Mark	Height
(MHz)	(dBuV)	(dBuV)	(dB)	(dB)	dB	dB	(dBuV/m)	(dBuV/m)	(dB)	(P/Q/A)	(Meter)
2463.20	84.70	31.74	3.28	0.00	9.50	0.00	110.22	Fundamental Frequency		P	1.00
2463.20	78.03	31.74	3.28	0.00	9.50	0.00	103.55			A	1.00
* 2483.60	34.76	31.72	3.12	0.00	9.50	0.00	60.10	74	-13.90	P	1.00
* 2483.60	22.23	31.72	3.12	0.00	9.50	0.00	47.57	54	-6.43	A	1.00
* 4924.12	46.07	35.10	2.64	35.24	9.50	1.60	40.67	74	-33.33	P	1.00
* 4924.12	35.34	35.10	2.64	35.24	9.50	1.60	29.94	54	-24.06	A	1.00
* 7386.28	45.32	39.75	4.85	35.62	9.50	2.00	46.80	74	-27.20	P	1.00
* 7386.28	33.15	39.75	4.85	35.62	9.50	2.00	34.63	54	-19.37	A	1.00
9847.75	48.81	38.52	5.90	36.76	9.50	0.49	47.46	74	-26.54	P	1.00
9847.75	37.34	38.52	5.90	36.76	9.50	0.49	35.99	54	-18.01	A	1.00
* 12316.00	-----	-----	-----	-----	9.50	0.80	-----	-----	-----	-----	1.00
14779.20	-----	-----	-----	-----	0.00	0.48	-----	-----	-----	-----	1.00
17242.40	-----	-----	-----	-----	0.00	0.60	-----	-----	-----	-----	1.00
* 19705.60	-----	-----	-----	-----	0.00	2.41	-----	-----	-----	-----	1.00
* 22168.80	-----	-----	-----	-----	0.00	0.70	-----	-----	-----	-----	1.00
24632.00	-----	-----	-----	-----	0.00	2.12	-----	-----	-----	-----	1.00

Note :

- The measurement was searched to 10th harmonic, Remark “---” means that the emissions level is too low to be measured.
- AF: Antenna Factor, Cable: Cable Loss, Pre-Amp: Preamplifier gain, Filter: High Pass Filter Insertion Loss (3.5GHz)
- Analyzer setting P(Peak): RBW=1MHz, VBW=1MHz, A(Average): RBW=1MHz, VBW=10Hz
- Remark “*” means that Restricted band.
- Dist : correction to extra plate reading to 3m specification distance 1m measurement distance = -9.5dB
- The result basic equation calculation is as follow:
 $Level = Reading + AF + Cable - Preamp + Filter - Dist$, $Margin = Level - Limit$
- The other emission levels were very low against the limit
- The test limit distance is 3M limit.
- For 802.11b mode at 11Mbps.
- For Antenna 3 (A800).



Ecom Sertech Corp.

Rm. 258, Bldg. 17, NO.195, Sec. 4 Chung Hsing Rd., ChuTung Chen, Hsinchu, Taiwan 310, R.O.C
 TEL:886-3-5918012 FAX: 886-3-5825720

FCC ID : QDWWM168GI
 Report No. : ER03-11-068FRF
 Page 103 of 151

Test Requirement: 15.205

The frequency spectrum above 1 GHz was investigated. All emissions not reported below are more than 40 dB below the prescribed limits. Readings are both peak and average values.

Company	AirVast Technology Inc.	Test Date :	2003/12/20
Product Name	802.11g WLAN USB Module	Test By:	K. P. Pang
Model Name	WM168gi	TEMP&Humidity :	14.6°C , 47%

CH1 TX				Measurement Distance at 1m				Horizontal polarity			
Freq.	Reading	AF	Cable	Pre-amp	Dist	Filter	Level	Limit	Margin	Mark	Height
(MHz)	(dBuV)	(dBuV)	(dB)	(dB)	dB	dB	(dBuV/m)	(dBuV/m)	(dB)	(P/Q/A)	(Meter)
* 2389.95	41.16	31.81	3.84	0.00	9.50	0.00	67.31	74	-6.69	P	1.00
* 2389.95	23.38	31.81	3.84	0.00	9.50	0.00	49.53	54	-4.47	A	1.00
2414.20	79.32	31.79	3.65	0.00	9.50	0.00	105.26	Fundamental Frequency		P	1.00
2414.20	69.36	31.79	3.65	0.00	9.50	0.00	95.30			A	1.00
* 4824.08	44.34	34.44	2.82	35.16	9.50	2.00	38.94	74	-35.06	P	1.00
* 4824.08	32.81	34.44	2.82	35.16	9.50	2.00	27.41	54	-26.59	A	1.00
7236.06	45.32	39.81	4.79	35.65	9.50	2.00	46.77	74	-27.23	P	1.00
7236.06	34.16	39.81	4.79	35.65	9.50	2.00	35.61	54	-18.39	A	1.00
9648.05	47.08	38.54	5.90	36.44	9.50	0.61	46.19	74	-27.81	P	1.00
9648.05	34.96	38.54	5.90	36.44	9.50	0.61	34.07	54	-19.93	A	1.00
* 12071.00	-----	-----	-----	-----	9.50	0.80	-----	-----	-----	-----	1.00
* 14485.20	-----	-----	-----	-----	0.00	0.68	-----	-----	-----	-----	1.00
16899.40	-----	-----	-----	-----	0.00	0.44	-----	-----	-----	-----	1.00
* 19313.60	-----	-----	-----	-----	0.00	1.98	-----	-----	-----	-----	1.00
21727.80	-----	-----	-----	-----	0.00	0.81	-----	-----	-----	-----	1.00
24142.00	-----	-----	-----	-----	0.00	2.87	-----	-----	-----	-----	1.00

Note :

- The measurement was searched to 10th harmonic, Remark “---” means that the emissions level is too low to be measured.
- AF: Antenna Factor, Cable: Cable Loss, Pre-Amp: Preamplifier gain, Filter: High Pass Filter Insertion Loss (3.5GHz)
- Analyzer setting P(Peak): RBW=1MHz, VBW=1MHz, A(Average): RBW=1MHz, VBW=10Hz
- Remark “*” means that Restricted band.
- Dist : correction to extra plate reading to 3m specification distance 1m measurement distance = -9.5dB
- The result basic equation calculation is as follow:
 $Level = Reading + AF + Cable - Preamp + Filter - Dist$, $Margin = Level - Limit$
- The other emission levels were very low against the limit
- The test limit distance is 3M limit.
- For 802.11g mode at 6Mbps.
- For Antenna 3 (A800).



Ecom Sertech Corp.

Rm. 258, Bldg. 17, NO.195, Sec. 4 Chung Hsing Rd., Chu Tung Chen, Hsinchu, Taiwan 310, R.O.C
 TEL: 886-3-5918012 FAX: 886-3-5825720

FCC ID : QDWWM168GI
 Report No. : ER03-11-068FRF
 Page 104 of 151

Test Requirement: 15.205

The frequency spectrum above 1 GHz was investigated. All emissions not reported below are more than 40 dB below the prescribed limits. Readings are both peak and average values.

Company	AirVast Technology Inc.	Test Date :	2003/12/23
Product Name	802.11g WLAN USB Module	Test By:	K. P. Pang
Model Name	WM168gi	TEMP&Humidity :	14.6°C , 47%

CH1 TX				Measurement Distance at 1m				Vertical polarity			
Freq.	Reading	AF	Cable	Pre-amp	Dist	Filter	Level	Limit	Margin	Mark	Height
(MHz)	(dBuV)	(dBuV)	(dB)	(dB)	dB	dB	(dBuV/m)	(dBuV/m)	(dB)	(P/Q/A)	(Meter)
* 2389.95	38.91	31.81	3.84	0.00	9.50	0.00	65.06	74	-8.94	P	1.00
* 2389.95	22.18	31.81	3.84	0.00	9.50	0.00	48.33	54	-5.67	A	1.00
2410.34	81.34	31.79	3.68	0.00	9.50	0.00	107.31	Fundamental Frequency		P	1.00
2410.34	70.98	31.79	3.68	0.00	9.50	0.00	96.95			A	1.00
* 4824.16	44.97	34.44	2.82	35.16	9.50	2.00	39.57	74	-34.43	P	1.00
* 4824.16	33.81	34.44	2.82	35.16	9.50	2.00	28.41	54	-25.59	A	1.00
7235.88	45.11	39.81	4.79	35.65	9.50	2.00	46.56	74	-27.44	P	1.00
7235.88	34.33	39.81	4.79	35.65	9.50	2.00	35.78	54	-18.22	A	1.00
9647.78	47.04	38.54	5.90	36.44	9.50	0.61	46.15	74	-27.85	P	1.00
9647.78	36.06	38.54	5.90	36.44	9.50	0.61	35.17	54	-18.83	A	1.00
* 12051.70	-----	-----	-----	-----	9.50	0.80	-----	-----	-----	-----	1.00
14462.04	-----	-----	-----	-----	0.00	0.65	-----	-----	-----	-----	1.00
16872.38	-----	-----	-----	-----	0.00	0.42	-----	-----	-----	-----	1.00
* 19282.72	-----	-----	-----	-----	0.00	1.94	-----	-----	-----	-----	1.00
21693.06	-----	-----	-----	-----	0.00	0.82	-----	-----	-----	-----	1.00
24103.40	-----	-----	-----	-----	0.00	2.93	-----	-----	-----	-----	1.00

Note :

- The measurement was searched to 10th harmonic, Remark “---” means that the emissions level is too low to be measured.
- AF: Antenna Factor, Cable: Cable Loss, Pre-Amp: Preamplifier gain, Filter: High Pass Filter Insertion Loss (3.5GHz)
- Analyzer setting P(Peak): RBW=1MHz, VBW=1MHz, A(Average): RBW=1MHz, VBW=10Hz
- Remark “*” means that Restricted band.
- Dist : correction to extra plate reading to 3m specification distance 1m measurement distance = -9.5dB
- The result basic equation calculation is as follow:

$$\text{Level} = \text{Reading} + \text{AF} + \text{Cable} - \text{Preamp} + \text{Filter} - \text{Dist}, \text{Margin} = \text{Level} - \text{Limit}$$
- The other emission levels were very low against the limit
- The test limit distance is 3M limit.
- For 802.11g mode at 6Mbps.
- For Antenna 3 (A800).



Ecom Sertech Corp.

Rm. 258, Bldg. 17, NO.195, Sec. 4 Chung Hsing Rd., ChuTung Chen, Hsinchu, Taiwan 310, R.O.C
 TEL:886-3-5918012 FAX : 886-3-5825720

FCC ID : QDWWM168GI
 Report No. : ER03-11-068FRF
 Page 105 of 151

Test Requirement: 15.205

The frequency spectrum above 1 GHz was investigated. All emissions not reported below are more than 40 dB below the prescribed limits. Readings are both peak and average values.

Company	AirVast Technology Inc.	Test Date :	2003/12/23
Product Name	802.11g WLAN USB Module	Test By:	K. P. Pang
Model Name	WM168gi	TEMP&Humidity :	14.6°C , 47%

CH6 TX				Measurement Distance at 1m				Horizontal polarity			
Freq.	Reading	AF	Cable	Pre-amp	Dist	Filter	Level	Limit	Margin	Mark	Height
(MHz)	(dBuV)	(dBuV)	(dB)	(dB)	dB	dB	(dBuV/m)	(dBuV/m)	(dB)	(P/Q/A)	(Meter)
2439.30	80.15	31.76	3.46	0.00	9.50	0.00	105.87	Fundamental Frequency		P	1.00
2439.30	70.33	31.76	3.46	0.00	9.50	0.00	96.05			A	1.00
* 4874.11	44.51	34.77	2.73	35.20	9.50	1.80	39.11	74	-34.89	P	1.00
* 4874.11	33.57	34.77	2.73	35.20	9.50	1.80	28.17	54	-25.83	A	1.00
* 7310.76	45.62	39.78	4.82	35.64	9.50	2.00	47.08	74	-26.92	P	1.00
* 7310.76	34.34	39.78	4.82	35.64	9.50	2.00	35.80	54	-18.20	A	1.00
9748.01	46.82	38.53	5.90	36.60	9.50	0.55	45.70	74	-28.30	P	1.00
9748.01	34.67	38.53	5.90	36.60	9.50	0.55	33.55	54	-20.45	A	1.00
* 12196.50	-----	-----	-----	-----	9.50	0.80	-----	-----	-----	-----	1.00
14635.80	-----	-----	-----	-----	0.00	0.59	-----	-----	-----	-----	1.00
17075.10	-----	-----	-----	-----	0.00	0.53	-----	-----	-----	-----	1.00
* 19514.40	-----	-----	-----	-----	0.00	2.21	-----	-----	-----	-----	1.00
21953.70	-----	-----	-----	-----	0.00	0.72	-----	-----	-----	-----	1.00
24393.00	-----	-----	-----	-----	0.00	2.47	-----	-----	-----	-----	1.00

Note :

- The measurement was searched to 10th harmonic, Remark “---” means that the emissions level is too low to be measured.
- AF: Antenna Factor, Cable: Cable Loss, Pre-Amp: Preamplifier gain, Filter: High Pass Filter Insertion Loss (3.5GHz)
- Analyzer setting P(Peak): RBW=1MHz, VBW=1MHz, A(Average): RBW=1MHz, VBW=10Hz
- Remark “*” means that Restricted band.
- Dist : correction to extra plate reading to 3m specification distance 1m measurement distance = -9.5dB
- The result basic equation calculation is as follow:
 $Level = Reading + AF + Cable - Preamp + Filter - Dist$, $Margin = Level - Limit$
- The other emission levels were very low against the limit
- The test limit distance is 3M limit.
- For 802.11g mode at 6Mbps.
- For Antenna 3 (A800).



Ecom Sertech Corp.

Rm. 258, Bldg. 17, NO.195, Sec. 4 Chung Hsing Rd., ChuTung Chen, Hsinchu, Taiwan 310, R.O.C
 TEL:886-3-5918012 FAX : 886-3-5825720

FCC ID : QDWWM168GI
 Report No. : ER03-11-068FRF
 Page 106 of 151

Test Requirement: 15.205

The frequency spectrum above 1 GHz was investigated. All emissions not reported below are more than 40 dB below the prescribed limits. Readings are both peak and average values.

Company	AirVast Technology Inc.	Test Date :	2003/12/23
Product Name	802.11g WLAN USB Module	Test By:	K. P. Pang
Model Name	WM168gi	TEMP&Humidity :	14.6°C , 47%

CH6 TX				Measurement Distance at 1m				Vertical polarity			
Freq.	Reading	AF	Cable	Pre-amp	Dist	Filter	Level	Limit	Margin	Mark	Height
(MHz)	(dBuV)	(dBuV)	(dB)	(dB)	dB	dB	(dBuV/m)	(dBuV/m)	(dB)	(P/Q/A)	(Meter)
2439.30	80.86	31.76	3.46	0.00	9.50	0.00	106.58	Fundamental Frequency		P	1.00
2439.30	70.99	31.76	3.46	0.00	9.50	0.00	96.71			A	1.00
* 4874.07	46.24	34.77	2.73	35.20	9.50	1.80	40.84	74	-33.16	P	1.00
* 4874.07	34.32	34.77	2.73	35.20	9.50	1.80	28.92	54	-25.08	A	1.00
* 7310.96	44.18	39.78	4.82	35.64	9.50	2.00	45.64	74	-28.36	P	1.00
* 7310.96	33.29	39.78	4.82	35.64	9.50	2.00	34.75	54	-19.25	A	1.00
9748.03	47.15	38.53	5.90	36.60	9.50	0.55	46.03	74	-27.97	P	1.00
9748.03	37.08	38.53	5.90	36.60	9.50	0.55	35.96	54	-18.04	A	1.00
* 12196.50	-----	-----	-----	-----	9.50	0.80	-----	-----	-----	-----	1.00
14635.80	-----	-----	-----	-----	0.00	0.59	-----	-----	-----	-----	1.00
17075.10	-----	-----	-----	-----	0.00	0.53	-----	-----	-----	-----	1.00
* 19514.40	-----	-----	-----	-----	0.00	2.21	-----	-----	-----	-----	1.00
21953.70	-----	-----	-----	-----	0.00	0.72	-----	-----	-----	-----	1.00
24393.00	-----	-----	-----	-----	0.00	2.47	-----	-----	-----	-----	1.00

Note :

- The measurement was searched to 10th harmonic, Remark “---” means that the emissions level is too low to be measured.
- AF: Antenna Factor, Cable: Cable Loss, Pre-Amp: Preamplifier gain, Filter: High Pass Filter Insertion Loss (3.5GHz)
- Analyzer setting P(Peak): RBW=1MHz, VBW=1MHz, A(Average): RBW=1MHz, VBW=10Hz
- Remark “*” means that Restricted band.
- Dist : correction to extra plate reading to 3m specification distance 1m measurement distance = -9.5dB
- The result basic equation calculation is as follow:
 $Level = Reading + AF + Cable - Preamp + Filter - Dist$, $Margin = Level - Limit$
- The other emission levels were very low against the limit
- The test limit distance is 3M limit.
- For 802.11g mode at 6Mbps.
- For Antenna 3 (A800).



Ecom Sertech Corp.

Rm. 258, Bldg. 17, NO.195, Sec. 4 Chung Hsing Rd., ChuTung Chen, Hsinchu, Taiwan 310, R.O.C
 TEL:886-3-5918012 FAX : 886-3-5825720

FCC ID : QDWWM168GI
 Report No. : ER03-11-068FRF
 Page 107 of 151

Test Requirement: 15.205

The frequency spectrum above 1 GHz was investigated. All emissions not reported below are more than 40 dB below the prescribed limits. Readings are both peak and average values.

Company	AirVast Technology Inc.	Test Date :	2003/12/23
Product Name	802.11g WLAN USB Module	Test By:	K. P. Pang
Model Name	WM168gi	TEMP&Humidity :	14.6°C , 47%

CH11 TX				Measurement Distance at 1m				Horizontal polarity			
Freq.	Reading	AF	Cable	Pre-amp	Dist	Filter	Level	Limit	Margin	Mark	Height
(MHz)	(dBuV)	(dBuV)	(dB)	(dB)	dB	dB	(dBuV/m)	(dBuV/m)	(dB)	(P/Q/A)	(Meter)
2460.34	81.08	31.74	3.30	0.00	9.50	0.00	106.62	Fundamental Frequency		P	1.00
2460.34	71.15	31.74	3.30	0.00	9.50	0.00	96.69			A	1.00
* 2483.60	39.45	31.72	3.12	0.00	9.50	0.00	64.79	74	-9.21	P	1.00
* 2483.60	25.55	31.72	3.12	0.00	9.50	0.00	50.89	54	-3.11	A	1.00
* 4923.79	46.15	35.10	2.64	35.24	9.50	1.60	40.75	74	-33.25	P	1.00
* 4923.79	34.46	35.10	2.64	35.24	9.50	1.60	29.06	54	-24.94	A	1.00
* 7386.34	45.60	39.75	4.85	35.62	9.50	2.00	47.08	74	-26.92	P	1.00
* 7386.34	33.27	39.75	4.85	35.62	9.50	2.00	34.75	54	-19.25	A	1.00
9847.80	48.39	38.52	5.90	36.76	9.50	0.49	47.04	74	-26.96	P	1.00
9847.80	36.67	38.52	5.90	36.76	9.50	0.49	35.32	54	-18.68	A	1.00
* 12301.70	-----	-----	-----	-----	9.50	0.80	-----	-----	-----	-----	1.00
14762.04	-----	-----	-----	-----	0.00	0.49	-----	-----	-----	-----	1.00
17222.38	-----	-----	-----	-----	0.00	0.59	-----	-----	-----	-----	1.00
* 19682.72	-----	-----	-----	-----	0.00	2.38	-----	-----	-----	-----	1.00
* 22143.06	-----	-----	-----	-----	0.00	0.70	-----	-----	-----	-----	1.00
24603.40	-----	-----	-----	-----	0.00	2.16	-----	-----	-----	-----	1.00

Note :

- The measurement was searched to 10th harmonic, Remark “---” means that the emissions level is too low to be measured.
- AF: Antenna Factor, Cable: Cable Loss, Pre-Amp: Preamplifier gain, Filter: High Pass Filter Insertion Loss (3.5GHz)
- Analyzer setting P(Peak): RBW=1MHz, VBW=1MHz, A(Average): RBW=1MHz, VBW=10Hz
- Remark “*” means that Restricted band.
- Dist : correction to extra plate reading to 3m specification distance 1m measurement distance = -9.5dB
- The result basic equation calculation is as follow:
 Level = Reading + AF + Cable - Preamp + Filter - Dist, Margin = Level - Limit
- The other emission levels were very low against the limit
- The test limit distance is 3M limit.
- For 802.11g mode at 6Mbps.
- For Antenna 3 (A800).



Ecom Sertech Corp.

Rm. 258, Bldg. 17, NO.195, Sec. 4 Chung Hsing Rd., ChuTung Chen, Hsinchu, Taiwan 310, R.O.C
 TEL:886-3-5918012 FAX : 886-3-5825720

FCC ID : QDWWM168GI
 Report No. : ER03-11-068FRF
 Page 108 of 151

Test Requirement: 15.205

The frequency spectrum above 1 GHz was investigated. All emissions not reported below are more than 40 dB below the prescribed limits. Readings are both peak and average values.

Company	AirVast Technology Inc.	Test Date :	2003/12/23
Product Name	802.11g WLAN USB Module	Test By:	K. P. Pang
Model Name	WM168gi	TEMP&Humidity :	14.6°C , 47%

CH11 TX				Measurement Distance at 1m				Vertical polarity			
Freq.	Reading	AF	Cable	Pre-amp	Dist	Filter	Level	Limit	Margin	Mark	Height
(MHz)	(dBuV)	(dBuV)	(dB)	(dB)	dB	dB	(dBuV/m)	(dBuV/m)	(dB)	(P/Q/A)	(Meter)
2460.24	81.01	31.74	3.30	0.00	9.50	0.00	106.55	Fundamental Frequency		P	1.00
2460.24	71.04	31.74	3.30	0.00	9.50	0.00	96.58			A	1.00
* 2483.60	39.25	31.72	3.12	0.00	9.50	0.00	64.59	74	-9.41	P	1.00
* 2483.60	23.90	31.72	3.12	0.00	9.50	0.00	49.24	54	-4.76	A	1.00
* 4924.03	46.44	35.10	2.64	35.24	9.50	1.60	41.04	74	-32.96	P	1.00
* 4924.03	36.38	35.10	2.64	35.24	9.50	1.60	30.98	54	-23.02	A	1.00
* 7386.14	43.26	39.75	4.85	35.62	9.50	2.00	44.74	74	-29.26	P	1.00
* 7386.14	33.06	39.75	4.85	35.62	9.50	2.00	34.54	54	-19.46	A	1.00
9847.86	47.85	38.52	5.90	36.76	9.50	0.49	46.50	74	-27.50	P	1.00
9847.86	37.22	38.52	5.90	36.76	9.50	0.49	35.87	54	-18.13	A	1.00
* 12301.20	-----	-----	-----	-----	9.50	0.80	-----	-----	-----	-----	1.00
14761.44	-----	-----	-----	-----	0.00	0.49	-----	-----	-----	-----	1.00
17221.68	-----	-----	-----	-----	0.00	0.59	-----	-----	-----	-----	1.00
* 19681.92	-----	-----	-----	-----	0.00	2.38	-----	-----	-----	-----	1.00
* 22142.16	-----	-----	-----	-----	0.00	0.70	-----	-----	-----	-----	1.00
24602.40	-----	-----	-----	-----	0.00	2.16	-----	-----	-----	-----	1.00

Note :

- The measurement was searched to 10th harmonic, Remark “---” means that the emissions level is too low to be measured.
- AF: Antenna Factor, Cable: Cable Loss, Pre-Amp: Preamplifier gain, Filter: High Pass Filter Insertion Loss (3.5GHz)
- Analyzer setting P(Peak): RBW=1MHz, VBW=1MHz, A(Average): RBW=1MHz, VBW=10Hz
- Remark “*” means that Restricted band.
- Dist : correction to extra plate reading to 3m specification distance 1m measurement distance = -9.5dB
- The result basic equation calculation is as follow:
 $Level = Reading + AF + Cable - Preamp + Filter - Dist$, $Margin = Level - Limit$
- The other emission levels were very low against the limit
- The test limit distance is 3M limit.
- For 802.11g mode at 6Mbps.
- For Antenna 3 (A800).



Ecom Sertech Corp.

Rm. 258, Bldg. 17, NO.195, Sec. 4 Chung Hsing Rd., ChuTung Chen, Hsinchu, Taiwan 310, R.O.C
 TEL:886-3-5918012 FAX : 886-3-5825720

FCC ID : QDWWM168GI
 Report No. : ER03-11-068FRF
 Page 109 of 151

Test Requirement: 15.205

The frequency spectrum above 1 GHz was investigated. All emissions not reported below are more than 40 dB below the prescribed limits. Readings are both peak and average values.

Company	AirVast Technology Inc.	Test Date :	2003/12/20
Product Name	802.11g WLAN USB Module	Test By:	K. P. Pang
Model Name	WM168gi	TEMP&Humidity :	19.4°C , 40%

CH1 TX				Measurement Distance at 1m				Horizontal polarity			
Freq.	Reading	AF	Cable	Pre-amp	Dist	Filter	Level	Limit	Margin	Mark	Height
(MHz)	(dBuV)	(dBuV)	(dB)	(dB)	dB	dB	(dBuV/m)	(dBuV/m)	(dB)	(P/Q/A)	(Meter)
* 2389.95	38.61	31.81	3.84	0.00	9.50	0.00	64.76	74	-9.24	P	1.00
* 2389.95	15.61	31.81	3.84	0.00	9.50	0.00	41.76	54	-12.24	A	1.00
2413.25	71.08	31.79	3.66	0.00	9.50	0.00	97.03	Fundamental Frequency		P	1.00
2413.25	64.61	31.79	3.66	0.00	9.50	0.00	90.56			A	1.00
* 4823.85	44.40	34.44	2.82	35.16	9.50	2.00	39.00	74	-35.00	P	1.00
* 4823.85	34.06	34.44	2.82	35.16	9.50	2.00	28.66	54	-25.34	A	1.00
7236.05	45.10	39.81	4.79	35.65	9.50	2.00	46.55	74	-27.45	P	1.00
7236.05	34.28	39.81	4.79	35.65	9.50	2.00	35.73	54	-18.27	A	1.00
9647.85	46.04	38.54	5.90	36.44	9.50	0.61	45.15	74	-28.85	P	1.00
9647.85	34.34	38.54	5.90	36.44	9.50	0.61	33.45	54	-20.55	A	1.00
* 12066.25	-----	-----	-----	-----	9.50	0.80	-----	-----	-----	-----	1.00
* 14479.50	-----	-----	-----	-----	0.00	0.68	-----	-----	-----	-----	1.00
16892.75	-----	-----	-----	-----	0.00	0.44	-----	-----	-----	-----	1.00
* 19306.00	-----	-----	-----	-----	0.00	1.97	-----	-----	-----	-----	1.00
21719.25	-----	-----	-----	-----	0.00	0.81	-----	-----	-----	-----	1.00
24132.50	-----	-----	-----	-----	0.00	2.89	-----	-----	-----	-----	1.00

Note :

- The measurement was searched to 10th harmonic, Remark “---” means that the emissions level is too low to be measured.
- AF: Antenna Factor, Cable: Cable Loss, Pre-Amp: Preamplifier gain, Filter: High Pass Filter Insertion Loss (3.5GHz)
- Analyzer setting P(Peak): RBW=1MHz, VBW=1MHz, A(Average): RBW=1MHz, VBW=10Hz
- Remark “*” means that Restricted band.
- Dist : correction to extra plate reading to 3m specification distance 1m measurement distance = -9.5dB
- The result basic equation calculation is as follow:
 $Level = Reading + AF + Cable - Preamp + Filter - Dist$, $Margin = Level - Limit$
- The other emission levels were very low against the limit
- The test limit distance is 3M limit.
- For 802.11b mode at 11Mbps.
- For Antenna 4 (G736).



Ecom Sertech Corp.

Rm. 258, Bldg. 17, NO.195, Sec. 4 Chung Hsing Rd., Chu Tung Chen, Hsinchu, Taiwan 310, R.O.C
 TEL: 886-3-5918012 FAX: 886-3-5825720

FCC ID : QDWWM168GI
 Report No. : ER03-11-068FRF
 Page 110 of 151

Test Requirement: 15.205

The frequency spectrum above 1 GHz was investigated. All emissions not reported below are more than 40 dB below the prescribed limits. Readings are both peak and average values.

Company	AirVast Technology Inc.	Test Date :	2003/12/20
Product Name	802.11g WLAN USB Module	Test By:	K. P. Pang
Model Name	WM168gi	TEMP&Humidity :	19.4°C , 40%

CH1 TX				Measurement Distance at 1m					Vertical polarity			
Freq.	Reading	AF	Cable	Pre-amp	Dist	Filter	Level	Limit	Margin	Mark	Height	
(MHz)	(dBuV)	(dBuV)	(dB)	(dB)	dB	dB	(dBuV/m)	(dBuV/m)	(dB)	(P/Q/A)	(Meter)	
* 2389.95	37.25	31.81	3.84	0.00	9.50	0.00	63.40	74	-10.60	P	1.00	
* 2389.95	15.61	31.81	3.84	0.00	9.50	0.00	41.76	54	-12.24	A	1.00	
2413.25	70.36	31.79	3.66	0.00	9.50	0.00	96.31	Fundamental Frequency		P	1.00	
2413.25	63.85	31.79	3.66	0.00	9.50	0.00	89.80			A	1.00	
* 4824.02	45.53	34.44	2.82	35.16	9.50	2.00	40.13	74	-33.87	P	1.00	
* 4824.02	36.56	34.44	2.82	35.16	9.50	2.00	31.16	54	-22.84	A	1.00	
7236.08	44.57	39.81	4.79	35.65	9.50	2.00	46.02	74	-27.98	P	1.00	
7236.08	33.41	39.81	4.79	35.65	9.50	2.00	34.86	54	-19.14	A	1.00	
9647.81	47.14	38.54	5.90	36.44	9.50	0.61	46.25	74	-27.75	P	1.00	
9647.81	36.87	38.54	5.90	36.44	9.50	0.61	35.98	54	-18.02	A	1.00	
* 12066.25	-----	-----	-----	-----	9.50	0.80	-----	-----	-----	-----	1.00	
* 14479.50	-----	-----	-----	-----	0.00	0.68	-----	-----	-----	-----	1.00	
16892.75	-----	-----	-----	-----	0.00	0.44	-----	-----	-----	-----	1.00	
* 19306.00	-----	-----	-----	-----	0.00	1.97	-----	-----	-----	-----	1.00	
21719.25	-----	-----	-----	-----	0.00	0.81	-----	-----	-----	-----	1.00	
24132.50	-----	-----	-----	-----	0.00	2.89	-----	-----	-----	-----	1.00	

Note :

- The measurement was searched to 10th harmonic, Remark “---” means that the emissions level is too low to be measured.
- AF: Antenna Factor, Cable: Cable Loss, Pre-Amp: Preamplifier gain, Filter: High Pass Filter Insertion Loss (3.5GHz)
- Analyzer setting P(Peak): RBW=1MHz, VBW=1MHz, A(Average): RBW=1MHz, VBW=10Hz
- Remark “*” means that Restricted band.
- Dist : correction to extra plate reading to 3m specification distance 1m measurement distance = -9.5dB
- The result basic equation calculation is as follow:

$$\text{Level} = \text{Reading} + \text{AF} + \text{Cable} - \text{Preamp} + \text{Filter} - \text{Dist}, \text{Margin} = \text{Level} - \text{Limit}$$
- The other emission levels were very low against the limit
- The test limit distance is 3M limit.
- For 802.11b mode at 11Mbps.
- For Antenna 4 (G736).



Ecom Sertech Corp.

Rm. 258, Bldg. 17, NO.195, Sec. 4 Chung Hsing Rd., ChuTung Chen, Hsinchu, Taiwan 310, R.O.C
 TEL:886-3-5918012 FAX : 886-3-5825720

FCC ID : QDWWM168GI
 Report No. : ER03-11-068FRF
 Page 111 of 151

Test Requirement: 15.205

The frequency spectrum above 1 GHz was investigated. All emissions not reported below are more than 40 dB below the prescribed limits. Readings are both peak and average values.

Company	AirVast Technology Inc.	Test Date :	2003/12/20
Product Name	802.11g WLAN USB Module	Test By:	K. P. Pang
Model Name	WM168gi	TEMP&Humidity :	19.4°C , 40%

CH6 TX				Measurement Distance at 1m				Horizontal polarity			
Freq.	Reading	AF	Cable	Pre-amp	Dist	Filter	Level	Limit	Margin	Mark	Height
(MHz)	(dBuV)	(dBuV)	(dB)	(dB)	dB	dB	(dBuV/m)	(dBuV/m)	(dB)	(P/Q/A)	(Meter)
2438.35	70.67	31.76	3.47	0.00	9.50	0.00	96.40	Fundamental Frequency		P	1.00
2438.35	63.95	31.76	3.47	0.00	9.50	0.00	89.68			A	1.00
* 4873.94	45.12	34.77	2.73	35.20	9.50	1.80	39.72	74	-34.28	P	1.00
* 4873.94	33.82	34.77	2.73	35.20	9.50	1.80	28.42	54	-25.58	A	1.00
* 7311.18	46.05	39.78	4.82	35.64	9.50	2.00	47.51	74	-26.49	P	1.00
* 7311.18	33.98	39.78	4.82	35.64	9.50	2.00	35.44	54	-18.56	A	1.00
9748.15	46.73	38.53	5.90	36.60	9.50	0.55	45.61	74	-28.39	P	1.00
9748.15	35.89	38.53	5.90	36.60	9.50	0.55	34.77	54	-19.23	A	1.00
* 12191.75	-----	-----	-----	-----	9.50	0.80	-----	-----	-----	-----	1.00
14630.10	-----	-----	-----	-----	0.00	0.60	-----	-----	-----	-----	1.00
17068.45	-----	-----	-----	-----	0.00	0.53	-----	-----	-----	-----	1.00
* 19506.80	-----	-----	-----	-----	0.00	2.21	-----	-----	-----	-----	1.00
21945.15	-----	-----	-----	-----	0.00	0.72	-----	-----	-----	-----	1.00
24383.50	-----	-----	-----	-----	0.00	2.49	-----	-----	-----	-----	1.00

Note :

- The measurement was searched to 10th harmonic, Remark “---” means that the emissions level is too low to be measured.
- AF: Antenna Factor, Cable: Cable Loss, Pre-Amp: Preamplifier gain, Filter: High Pass Filter Insertion Loss (3.5GHz)
- Analyzer setting P(Peak): RBW=1MHz, VBW=1MHz, A(Average): RBW=1MHz, VBW=10Hz
- Remark “*” means that Restricted band.
- Dist : correction to extra plate reading to 3m specification distance 1m measurement distance = -9.5dB
- The result basic equation calculation is as follow:
 $Level = Reading + AF + Cable - Preamp + Filter - Dist$, $Margin = Level - Limit$
- The other emission levels were very low against the limit
- The test limit distance is 3M limit.
- For 802.11b mode at 11Mbps.
- For Antenna 4 (G736).



Ecom Sertech Corp.

Rm. 258, Bldg. 17, NO.195, Sec. 4 Chung Hsing Rd., ChuTung Chen, Hsinchu, Taiwan 310, R.O.C
 TEL:886-3-5918012 FAX : 886-3-5825720

FCC ID : QDWWM168GI
 Report No. : ER03-11-068FRF
 Page 112 of 151

Test Requirement: 15.205

The frequency spectrum above 1 GHz was investigated. All emissions not reported below are more than 40 dB below the prescribed limits. Readings are both peak and average values.

Company	AirVast Technology Inc.	Test Date :	2003/12/20
Product Name	802.11g WLAN USB Module	Test By:	K. P. Pang
Model Name	WM168gi	TEMP&Humidity :	19.4°C , 40%

CH6 TX				Measurement Distance at 1m				Vertical polarity			
Freq.	Reading	AF	Cable	Pre-amp	Dist	Filter	Level	Limit	Margin	Mark	Height
(MHz)	(dBuV)	(dBuV)	(dB)	(dB)	dB	dB	(dBuV/m)	(dBuV/m)	(dB)	(P/Q/A)	(Meter)
2438.25	70.34	31.76	3.47	0.00	9.50	0.00	96.07	Fundamental Frequency		P	1.00
2438.25	63.47	31.76	3.47	0.00	9.50	0.00	89.20			A	1.00
* 4874.01	45.59	34.77	2.73	35.20	9.50	1.80	40.19	74	-33.81	P	1.00
* 4874.01	35.05	34.77	2.73	35.20	9.50	1.80	29.65	54	-24.35	A	1.00
* 7310.58	45.49	39.78	4.82	35.64	9.50	2.00	46.95	74	-27.05	P	1.00
* 7310.58	33.95	39.78	4.82	35.64	9.50	2.00	35.41	54	-18.59	A	1.00
9747.95	46.90	38.53	5.90	36.60	9.50	0.55	45.78	74	-28.22	P	1.00
9747.95	36.16	38.53	5.90	36.60	9.50	0.55	35.04	54	-18.96	A	1.00
* 12191.25	-----	-----	-----	-----	9.50	0.80	-----	-----	-----	-----	1.00
14629.50	-----	-----	-----	-----	0.00	0.60	-----	-----	-----	-----	1.00
17067.75	-----	-----	-----	-----	0.00	0.53	-----	-----	-----	-----	1.00
* 19506.00	-----	-----	-----	-----	0.00	2.21	-----	-----	-----	-----	1.00
21944.25	-----	-----	-----	-----	0.00	0.72	-----	-----	-----	-----	1.00
24382.50	-----	-----	-----	-----	0.00	2.49	-----	-----	-----	-----	1.00

Note :

- The measurement was searched to 10th harmonic, Remark “---” means that the emissions level is too low to be measured.
- AF: Antenna Factor, Cable: Cable Loss, Pre-Amp: Preamplifier gain, Filter: High Pass Filter Insertion Loss (3.5GHz)
- Analyzer setting P(Peak): RBW=1MHz, VBW=1MHz, A(Average): RBW=1MHz, VBW=10Hz
- Remark “*” means that Restricted band.
- Dist : correction to extra plate reading to 3m specification distance 1m measurement distance = -9.5dB
- The result basic equation calculation is as follow:
 $Level = Reading + AF + Cable - Preamp + Filter - Dist$, $Margin = Level - Limit$
- The other emission levels were very low against the limit
- The test limit distance is 3M limit.
- For 802.11b mode at 11Mbps.
- For Antenna 4 (G736).



Ecom Sertech Corp.

Rm. 258, Bldg. 17, NO.195, Sec. 4 Chung Hsing Rd., ChuTung Chen, Hsinchu, Taiwan 310, R.O.C
 TEL:886-3-5918012 FAX : 886-3-5825720

FCC ID : QDWWM168GI
 Report No. : ER03-11-068FRF
 Page 113 of 151

Test Requirement: 15.205
 The frequency spectrum above 1 GHz was investigated. All emissions not reported below are more than 40 dB below the prescribed limits. Readings are both peak and average values.

Company	AirVast Technology Inc.	Test Date :	2003/12/20
Product Name	802.11g WLAN USB Module	Test By:	K. P. Pang
Model Name	WM168gi	TEMP&Humidity :	19.4°C , 40%

CH11 TX				Measurement Distance at 1m				Horizontal polarity			
Freq.	Reading	AF	Cable	Pre-amp	Dist	Filter	Level	Limit	Margin	Mark	Height
(MHz)	(dBuV)	(dBuV)	(dB)	(dB)	dB	dB	(dBuV/m)	(dBuV/m)	(dB)	(P/Q/A)	(Meter)
2463.25	71.97	31.74	3.28	0.00	9.50	0.00	97.49	Fundamental Frequency		P	1.00
2463.25	63.53	31.74	3.28	0.00	9.50	0.00	89.05			A	1.00
* 2483.60	36.10	31.72	3.12	0.00	9.50	0.00	61.44	74	-12.56	P	1.00
* 2483.60	16.77	31.72	3.12	0.00	9.50	0.00	42.11	54	-11.89	A	1.00
* 4923.96	45.93	35.10	2.64	35.24	9.50	1.60	40.53	74	-33.47	P	1.00
* 4923.96	35.22	35.10	2.64	35.24	9.50	1.60	29.82	54	-24.18	A	1.00
* 7386.30	44.04	39.75	4.85	35.62	9.50	2.00	45.52	74	-28.48	P	1.00
* 7386.30	32.62	39.75	4.85	35.62	9.50	2.00	34.10	54	-19.90	A	1.00
9848.06	48.03	38.52	5.90	36.76	9.50	0.49	46.68	74	-27.32	P	1.00
9848.06	37.15	38.52	5.90	36.76	9.50	0.49	35.80	54	-18.20	A	1.00
* 12316.25	-----	-----	-----	-----	9.50	0.80	-----	-----	-----	-----	1.00
14779.50	-----	-----	-----	-----	0.00	0.48	-----	-----	-----	-----	1.00
17242.75	-----	-----	-----	-----	0.00	0.60	-----	-----	-----	-----	1.00
* 19706.00	-----	-----	-----	-----	0.00	2.41	-----	-----	-----	-----	1.00
* 22169.25	-----	-----	-----	-----	0.00	0.70	-----	-----	-----	-----	1.00
24632.50	-----	-----	-----	-----	0.00	2.11	-----	-----	-----	-----	1.00

- Note :
- The measurement was searched to 10th harmonic, Remark “---” means that the emissions level is too low to be measured.
 - AF: Antenna Factor, Cable: Cable Loss, Pre-Amp: Preamplifier gain, Filter: High Pass Filter Insertion Loss (3.5GHz)
 - Analyzer setting P(Peak): RBW=1MHz, VBW=1MHz, A(Average): RBW=1MHz, VBW=10Hz
 - Remark “*” means that Restricted band.
 - Dist : correction to extra plate reading to 3m specification distance 1m measurement distance = -9.5dB
 - The result basic equation calculation is as follow:
 $Level = Reading + AF + Cable - Preamp + Filter - Dist$, $Margin = Level - Limit$
 - The other emission levels were very low against the limit
 - The test limit distance is 3M limit.
 - For 802.11b mode at 11Mbps.
 - For Antenna 4 (G736).



Ecom Sertech Corp.

Rm. 258, Bldg. 17, NO.195, Sec. 4 Chung Hsing Rd., ChuTung Chen, Hsinchu, Taiwan 310, R.O.C
 TEL:886-3-5918012 FAX : 886-3-5825720

FCC ID : QDWWM168GI
 Report No. : ER03-11-068FRF
 Page 114 of 151

Test Requirement: 15.205

The frequency spectrum above 1 GHz was investigated. All emissions not reported below are more than 40 dB below the prescribed limits. Readings are both peak and average values.

Company	AirVast Technology Inc.	Test Date :	2003/12/20
Product Name	802.11g WLAN USB Module	Test By:	K. P. Pang
Model Name	WM168gi	TEMP&Humidity :	19.4°C , 40%

CH11 TX				Measurement Distance at 1m				Vertical polarity			
Freq.	Reading	AF	Cable	Pre-amp	Dist	Filter	Level	Limit	Margin	Mark	Height
(MHz)	(dBuV)	(dBuV)	(dB)	(dB)	dB	dB	(dBuV/m)	(dBuV/m)	(dB)	(P/Q/A)	(Meter)
2463.30	72.07	31.74	3.28	0.00	9.50	0.00	97.59	Fundamental Frequency		P	1.00
2463.30	65.18	31.74	3.28	0.00	9.50	0.00	90.70			A	1.00
* 2483.60	37.83	31.72	3.12	0.00	9.50	0.00	63.17	74	-10.83	P	1.00
* 2483.60	16.77	31.72	3.12	0.00	9.50	0.00	42.11	54	-11.89	A	1.00
* 4924.19	46.40	35.10	2.64	35.24	9.50	1.60	41.00	74	-33.00	P	1.00
* 4924.19	35.17	35.10	2.64	35.24	9.50	1.60	29.77	54	-24.23	A	1.00
* 7386.24	44.04	39.75	4.85	35.62	9.50	2.00	45.52	74	-28.48	P	1.00
* 7386.24	32.59	39.75	4.85	35.62	9.50	2.00	34.07	54	-19.93	A	1.00
9847.63	47.80	38.52	5.90	36.76	9.50	0.49	46.45	74	-27.55	P	1.00
9847.63	37.43	38.52	5.90	36.76	9.50	0.49	36.08	54	-17.92	A	1.00
* 12316.50	-----	-----	-----	-----	9.50	0.80	-----	-----	-----	-----	1.00
14779.80	-----	-----	-----	-----	0.00	0.48	-----	-----	-----	-----	1.00
17243.10	-----	-----	-----	-----	0.00	0.60	-----	-----	-----	-----	1.00
* 19706.40	-----	-----	-----	-----	0.00	2.41	-----	-----	-----	-----	1.00
* 22169.70	-----	-----	-----	-----	0.00	0.70	-----	-----	-----	-----	1.00
24633.00	-----	-----	-----	-----	0.00	2.11	-----	-----	-----	-----	1.00

Note :

- The measurement was searched to 10th harmonic, Remark “---” means that the emissions level is too low to be measured.
- AF: Antenna Factor, Cable: Cable Loss, Pre-Amp: Preamplifier gain, Filter: High Pass Filter Insertion Loss (3.5GHz)
- Analyzer setting P(Peak): RBW=1MHz, VBW=1MHz, A(Average): RBW=1MHz, VBW=10Hz
- Remark “*” means that Restricted band.
- Dist : correction to extra plate reading to 3m specification distance 1m measurement distance = -9.5dB
- The result basic equation calculation is as follow:
 $Level = Reading + AF + Cable - Preamp + Filter - Dist$, $Margin = Level - Limit$
- The other emission levels were very low against the limit
- The test limit distance is 3M limit.
- For 802.11b mode at 11Mbps.
- For Antenna 4 (G736).



Ecom Sertech Corp.

Rm. 258, Bldg. 17, NO.195, Sec. 4 Chung Hsing Rd., ChuTung Chen, Hsinchu, Taiwan 310, R.O.C
 TEL:886-3-5918012 FAX : 886-3-5825720

FCC ID : QDWWM168GI
 Report No. : ER03-11-068FRF
 Page 115 of 151

Test Requirement: 15.205

The frequency spectrum above 1 GHz was investigated. All emissions not reported below are more than 40 dB below the prescribed limits. Readings are both peak and average values.

Company	AirVast Technology Inc.	Test Date :	2003/12/20
Product Name	802.11g WLAN USB Module	Test By:	K. P. Pang
Model Name	WM168gi	TEMP&Humidity :	14.6°C , 47%

CH1 TX				Measurement Distance at 1m				Horizontal polarity			
Freq.	Reading	AF	Cable	Pre-amp	Dist	Filter	Level	Limit	Margin	Mark	Height
(MHz)	(dBuV)	(dBuV)	(dB)	(dB)	dB	dB	(dBuV/m)	(dBuV/m)	(dB)	(P/Q/A)	(Meter)
* 2389.95	38.85	31.81	3.84	0.00	9.50	0.00	65.00	74	-9.00	P	1.00
* 2389.95	20.29	31.81	3.84	0.00	9.50	0.00	46.44	54	-7.56	A	1.00
2410.30	69.51	31.79	3.68	0.00	9.50	0.00	95.48	Fundamental Frequency		P	1.00
2410.30	61.14	31.79	3.68	0.00	9.50	0.00	87.11			A	1.00
* 4823.97	45.67	34.44	2.82	35.16	9.50	2.00	40.27	74	-33.73	P	1.00
* 4823.97	33.56	34.44	2.82	35.16	9.50	2.00	28.16	54	-25.84	A	1.00
7236.10	45.33	39.81	4.79	35.65	9.50	2.00	46.78	74	-27.22	P	1.00
7236.10	33.25	39.81	4.79	35.65	9.50	2.00	34.70	54	-19.30	A	1.00
9648.07	47.21	38.54	5.90	36.44	9.50	0.61	46.32	74	-27.68	P	1.00
9648.07	35.18	38.54	5.90	36.44	9.50	0.61	34.29	54	-19.71	A	1.00
* 12051.50	-----	-----	-----	-----	9.50	0.80	-----	-----	-----	-----	1.00
14461.80	-----	-----	-----	-----	0.00	0.65	-----	-----	-----	-----	1.00
16872.10	-----	-----	-----	-----	0.00	0.42	-----	-----	-----	-----	1.00
* 19282.40	-----	-----	-----	-----	0.00	1.94	-----	-----	-----	-----	1.00
21692.70	-----	-----	-----	-----	0.00	0.82	-----	-----	-----	-----	1.00
24103.00	-----	-----	-----	-----	0.00	2.94	-----	-----	-----	-----	1.00

Note :

- The measurement was searched to 10th harmonic, Remark “---” means that the emissions level is too low to be measured.
- AF: Antenna Factor, Cable: Cable Loss, Pre-Amp: Preamplifier gain, Filter: High Pass Filter Insertion Loss (3.5GHz)
- Analyzer setting P(Peak): RBW=1MHz, VBW=1MHz, A(Average): RBW=1MHz, VBW=10Hz
- Remark “*” means that Restricted band.
- Dist : correction to extra plate reading to 3m specification distance 1m measurement distance = -9.5dB
- The result basic equation calculation is as follow:
 $Level = Reading + AF + Cable - Preamp + Filter - Dist$, $Margin = Level - Limit$
- The other emission levels were very low against the limit
- The test limit distance is 3M limit.
- For 802.11g mode at 6Mbps.
- For Antenna 4 (G736).



Ecom Sertech Corp.

Rm. 258, Bldg. 17, NO.195, Sec. 4 Chung Hsing Rd., Chu Tung Chen, Hsinchu, Taiwan 310, R.O.C
 TEL: 886-3-5918012 FAX: 886-3-5825720

FCC ID : QDWWM168GI
 Report No. : ER03-11-068FRF
 Page 116 of 151

Test Requirement: 15.205

The frequency spectrum above 1 GHz was investigated. All emissions not reported below are more than 40 dB below the prescribed limits. Readings are both peak and average values.

Company	AirVast Technology Inc.	Test Date :	2003/12/20
Product Name	802.11g WLAN USB Module	Test By:	K. P. Pang
Model Name	WM168gi	TEMP&Humidity :	14.6°C , 47%

CH1 TX				Measurement Distance at 1m				Vertical polarity			
Freq.	Reading	AF	Cable	Pre-amp	Dist	Filter	Level	Limit	Margin	Mark	Height
(MHz)	(dBuV)	(dBuV)	(dB)	(dB)	dB	dB	(dBuV/m)	(dBuV/m)	(dB)	(P/Q/A)	(Meter)
* 2389.95	40.07	31.81	3.84	0.00	9.50	0.00	66.22	74	-7.78	P	1.00
* 2389.95	20.98	31.81	3.84	0.00	9.50	0.00	47.13	54	-6.87	A	1.00
2410.40	70.07	31.79	3.68	0.00	9.50	0.00	96.04	Fundamental Frequency		P	1.00
2410.40	61.76	31.79	3.68	0.00	9.50	0.00	87.73			A	1.00
* 4823.96	44.92	34.44	2.82	35.16	9.50	2.00	39.52	74	-34.48	P	1.00
* 4823.96	33.83	34.44	2.82	35.16	9.50	2.00	28.43	54	-25.57	A	1.00
7235.95	46.38	39.81	4.79	35.65	9.50	2.00	47.83	74	-26.17	P	1.00
7235.95	34.59	39.81	4.79	35.65	9.50	2.00	36.04	54	-17.96	A	1.00
9647.61	47.30	38.54	5.90	36.44	9.50	0.61	46.41	74	-27.59	P	1.00
9647.61	35.36	38.54	5.90	36.44	9.50	0.61	34.47	54	-19.53	A	1.00
* 12052.00	-----	-----	-----	-----	9.50	0.80	-----	-----	-----	-----	1.00
14462.40	-----	-----	-----	-----	0.00	0.65	-----	-----	-----	-----	1.00
16872.80	-----	-----	-----	-----	0.00	0.42	-----	-----	-----	-----	1.00
* 19283.20	-----	-----	-----	-----	0.00	1.94	-----	-----	-----	-----	1.00
21693.60	-----	-----	-----	-----	0.00	0.82	-----	-----	-----	-----	1.00
24104.00	-----	-----	-----	-----	0.00	2.93	-----	-----	-----	-----	1.00

Note :

- The measurement was searched to 10th harmonic, Remark “---” means that the emissions level is too low to be measured.
- AF: Antenna Factor, Cable: Cable Loss, Pre-Amp: Preamplifier gain, Filter: High Pass Filter Insertion Loss (3.5GHz)
- Analyzer setting P(Peak): RBW=1MHz, VBW=1MHz, A(Average): RBW=1MHz, VBW=10Hz
- Remark “*” means that Restricted band.
- Dist : correction to extra plate reading to 3m specification distance 1m measurement distance = -9.5dB
- The result basic equation calculation is as follow:

$$\text{Level} = \text{Reading} + \text{AF} + \text{Cable} - \text{Preamp} + \text{Filter} - \text{Dist}, \text{Margin} = \text{Level} - \text{Limit}$$
- The other emission levels were very low against the limit
- The test limit distance is 3M limit.
- For 802.11g mode at 6Mbps.
- For Antenna 4 (G736).



Ecom Sertech Corp.

Rm. 258, Bldg. 17, NO.195, Sec. 4 Chung Hsing Rd., ChuTung Chen, Hsinchu, Taiwan 310, R.O.C
 TEL:886-3-5918012 FAX : 886-3-5825720

FCC ID : QDWWM168GI
 Report No. : ER03-11-068FRF
 Page 117 of 151

Test Requirement: 15.205

The frequency spectrum above 1 GHz was investigated. All emissions not reported below are more than 40 dB below the prescribed limits. Readings are both peak and average values.

Company	AirVast Technology Inc.	Test Date :	2003/12/20
Product Name	802.11g WLAN USB Module	Test By:	K. P. Pang
Model Name	WM168gi	TEMP&Humidity :	14.6°C , 47%

CH6 TX				Measurement Distance at 1m				Horizontal polarity			
Freq.	Reading	AF	Cable	Pre-amp	Dist	Filter	Level	Limit	Margin	Mark	Height
(MHz)	(dBuV)	(dBuV)	(dB)	(dB)	dB	dB	(dBuV/m)	(dBuV/m)	(dB)	(P/Q/A)	(Meter)
2439.30	68.66	31.76	3.46	0.00	9.50	0.00	94.38	Fundamental Frequency		P	1.00
2439.30	60.43	31.76	3.46	0.00	9.50	0.00	86.15			A	1.00
* 4874.08	45.18	34.77	2.73	35.20	9.50	1.80	39.78	74	-34.22	P	1.00
* 4874.08	34.37	34.77	2.73	35.20	9.50	1.80	28.97	54	-25.03	A	1.00
* 7311.27	44.98	39.78	4.82	35.64	9.50	2.00	46.44	74	-27.56	P	1.00
* 7311.27	33.34	39.78	4.82	35.64	9.50	2.00	34.80	54	-19.20	A	1.00
9748.05	47.34	38.53	5.90	36.60	9.50	0.55	46.22	74	-27.78	P	1.00
9748.05	35.51	38.53	5.90	36.60	9.50	0.55	34.39	54	-19.61	A	1.00
* 12196.50	-----	-----	-----	-----	9.50	0.80	-----	-----	-----	-----	1.00
14635.80	-----	-----	-----	-----	0.00	0.59	-----	-----	-----	-----	1.00
17075.10	-----	-----	-----	-----	0.00	0.53	-----	-----	-----	-----	1.00
* 19514.40	-----	-----	-----	-----	0.00	2.21	-----	-----	-----	-----	1.00
21953.70	-----	-----	-----	-----	0.00	0.72	-----	-----	-----	-----	1.00
24393.00	-----	-----	-----	-----	0.00	2.47	-----	-----	-----	-----	1.00

Note :

- The measurement was searched to 10th harmonic, Remark “---” means that the emissions level is too low to be measured.
- AF: Antenna Factor, Cable: Cable Loss, Pre-Amp: Preamplifier gain, Filter: High Pass Filter Insertion Loss (3.5GHz)
- Analyzer setting P(Peak): RBW=1MHz, VBW=1MHz, A(Average): RBW=1MHz, VBW=10Hz
- Remark “*” means that Restricted band.
- Dist : correction to extra plate reading to 3m specification distance 1m measurement distance = -9.5dB
- The result basic equation calculation is as follow:
 $Level = Reading + AF + Cable - Preamp + Filter - Dist$, $Margin = Level - Limit$
- The other emission levels were very low against the limit
- The test limit distance is 3M limit.
- For 802.11g mode at 6Mbps.
- For Antenna 4 (G736).



Ecom Sertech Corp.

Rm. 258, Bldg. 17, NO.195, Sec. 4 Chung Hsing Rd., ChuTung Chen, Hsinchu, Taiwan 310, R.O.C
 TEL:886-3-5918012 FAX : 886-3-5825720

FCC ID : QDWWM168GI
 Report No. : ER03-11-068FRF
 Page 118 of 151

Test Requirement: 15.205

The frequency spectrum above 1 GHz was investigated. All emissions not reported below are more than 40 dB below the prescribed limits. Readings are both peak and average values.

Company	AirVast Technology Inc.	Test Date :	2003/12/20
Product Name	802.11g WLAN USB Module	Test By:	K. P. Pang
Model Name	WM168gi	TEMP&Humidity :	14.6°C , 47%

CH6 TX				Measurement Distance at 1m				Vertical polarity			
Freq.	Reading	AF	Cable	Pre-amp	Dist	Filter	Level	Limit	Margin	Mark	Height
(MHz)	(dBuV)	(dBuV)	(dB)	(dB)	dB	dB	(dBuV/m)	(dBuV/m)	(dB)	(P/Q/A)	(Meter)
2439.20	69.60	31.76	3.46	0.00	9.50	0.00	95.32	Fundamental Frequency		P	1.00
2439.20	61.25	31.76	3.46	0.00	9.50	0.00	86.97			A	1.00
* 4874.10	44.59	34.77	2.73	35.20	9.50	1.80	39.19	74	-34.81	P	1.00
* 4874.10	33.21	34.77	2.73	35.20	9.50	1.80	27.81	54	-26.19	A	1.00
* 7310.74	45.54	39.78	4.82	35.64	9.50	2.00	47.00	74	-27.00	P	1.00
* 7310.74	34.59	39.78	4.82	35.64	9.50	2.00	36.05	54	-17.95	A	1.00
9748.28	47.53	38.53	5.90	36.60	9.50	0.55	46.41	74	-27.59	P	1.00
9748.28	35.70	38.53	5.90	36.60	9.50	0.55	34.58	54	-19.42	A	1.00
* 12196.00	-----	-----	-----	-----	9.50	0.80	-----	-----	-----	-----	1.00
14635.20	-----	-----	-----	-----	0.00	0.59	-----	-----	-----	-----	1.00
17074.40	-----	-----	-----	-----	0.00	0.53	-----	-----	-----	-----	1.00
* 19513.60	-----	-----	-----	-----	0.00	2.21	-----	-----	-----	-----	1.00
21952.80	-----	-----	-----	-----	0.00	0.72	-----	-----	-----	-----	1.00
24392.00	-----	-----	-----	-----	0.00	2.47	-----	-----	-----	-----	1.00

Note :

- The measurement was searched to 10th harmonic, Remark “---” means that the emissions level is too low to be measured.
- AF: Antenna Factor, Cable: Cable Loss, Pre-Amp: Preamplifier gain, Filter: High Pass Filter Insertion Loss (3.5GHz)
- Analyzer setting P(Peak): RBW=1MHz, VBW=1MHz, A(Average): RBW=1MHz, VBW=10Hz
- Remark “*” means that Restricted band.
- Dist : correction to extra plate reading to 3m specification distance 1m measurement distance = -9.5dB
- The result basic equation calculation is as follow:
 $Level = Reading + AF + Cable - Preamp + Filter - Dist$, $Margin = Level - Limit$
- The other emission levels were very low against the limit
- The test limit distance is 3M limit.
- For 802.11g mode at 6Mbps.
- For Antenna 4 (G736).



Ecom Sertech Corp.

Rm. 258, Bldg. 17, NO.195, Sec. 4 Chung Hsing Rd., ChuTung Chen, Hsinchu, Taiwan 310, R.O.C
 TEL:886-3-5918012 FAX : 886-3-5825720

FCC ID : QDWWM168GI
 Report No. : ER03-11-068FRF
 Page 119 of 151

Test Requirement: 15.205

The frequency spectrum above 1 GHz was investigated. All emissions not reported below are more than 40 dB below the prescribed limits. Readings are both peak and average values.

Company	AirVast Technology Inc.	Test Date :	2003/12/20
Product Name	802.11g WLAN USB Module	Test By:	K. P. Pang
Model Name	WM168gi	TEMP&Humidity :	14.6°C , 47%

CH11 TX				Measurement Distance at 1m				Horizontal polarity			
Freq.	Reading	AF	Cable	Pre-amp	Dist	Filter	Level	Limit	Margin	Mark	Height
(MHz)	(dBuV)	(dBuV)	(dB)	(dB)	dB	dB	(dBuV/m)	(dBuV/m)	(dB)	(P/Q/A)	(Meter)
2460.30	69.97	31.74	3.30	0.00	9.50	0.00	95.51	Fundamental Frequency		P	1.00
2460.30	61.42	31.74	3.30	0.00	9.50	0.00	86.96			A	1.00
* 2483.60	38.69	31.72	3.12	0.00	9.50	0.00	64.03	74	-9.97	P	1.00
* 2483.60	22.23	31.72	3.12	0.00	9.50	0.00	47.57	54	-6.43	A	1.00
* 4923.88	46.18	35.10	2.64	35.24	9.50	1.60	40.78	74	-33.22	P	1.00
* 4923.88	34.12	35.10	2.64	35.24	9.50	1.60	28.72	54	-25.28	A	1.00
* 7386.12	44.94	39.75	4.85	35.62	9.50	2.00	46.42	74	-27.58	P	1.00
* 7386.12	33.54	39.75	4.85	35.62	9.50	2.00	35.02	54	-18.98	A	1.00
9847.98	47.39	38.52	5.90	36.76	9.50	0.49	46.04	74	-27.96	P	1.00
9847.98	35.89	38.52	5.90	36.76	9.50	0.49	34.54	54	-19.46	A	1.00
* 12301.50	-----	-----	-----	-----	9.50	0.80	-----	-----	-----	-----	1.00
14761.80	-----	-----	-----	-----	0.00	0.49	-----	-----	-----	-----	1.00
17222.10	-----	-----	-----	-----	0.00	0.59	-----	-----	-----	-----	1.00
* 19682.40	-----	-----	-----	-----	0.00	2.38	-----	-----	-----	-----	1.00
* 22142.70	-----	-----	-----	-----	0.00	0.70	-----	-----	-----	-----	1.00
24603.00	-----	-----	-----	-----	0.00	2.16	-----	-----	-----	-----	1.00

Note :

- The measurement was searched to 10th harmonic, Remark “---” means that the emissions level is too low to be measured.
- AF: Antenna Factor, Cable: Cable Loss, Pre-Amp: Preamplifier gain, Filter: High Pass Filter Insertion Loss (3.5GHz)
- Analyzer setting P(Peak): RBW=1MHz, VBW=1MHz, A(Average): RBW=1MHz, VBW=10Hz
- Remark “*” means that Restricted band.
- Dist : correction to extra plate reading to 3m specification distance 1m measurement distance = -9.5dB
- The result basic equation calculation is as follow:
 $Level = Reading + AF + Cable - Preamp + Filter - Dist$, $Margin = Level - Limit$
- The other emission levels were very low against the limit
- The test limit distance is 3M limit.
- For 802.11g mode at 6Mbps.
- For Antenna 4 (G736).



Ecom Sertech Corp.

Rm. 258, Bldg. 17, NO.195, Sec. 4 Chung Hsing Rd., ChuTung Chen, Hsinchu, Taiwan 310, R.O.C
 TEL:886-3-5918012 FAX : 886-3-5825720

FCC ID : QDWWM168GI
 Report No. : ER03-11-068FRF
 Page 120 of 151

Test Requirement: 15.205

The frequency spectrum above 1 GHz was investigated. All emissions not reported below are more than 40 dB below the prescribed limits. Readings are both peak and average values.

Company	AirVast Technology Inc.	Test Date :	2003/12/20
Product Name	802.11g WLAN USB Module	Test By:	K. P. Pang
Model Name	WM168gi	TEMP&Humidity :	14.6°C , 47%

CH11 TX				Measurement Distance at 1m				Vertical polarity			
Freq.	Reading	AF	Cable	Pre-amp	Dist	Filter	Level	Limit	Margin	Mark	Height
(MHz)	(dBuV)	(dBuV)	(dB)	(dB)	dB	dB	(dBuV/m)	(dBuV/m)	(dB)	(P/Q/A)	(Meter)
2460.30	70.37	31.74	3.30	0.00	9.50	0.00	95.91	Fundamental Frequency		P	1.00
2460.30	62.31	31.74	3.30	0.00	9.50	0.00	87.85			A	1.00
* 2483.60	39.50	31.72	3.12	0.00	9.50	0.00	64.84	74	-9.16	P	1.00
* 2483.60	22.79	31.72	3.12	0.00	9.50	0.00	48.13	54	-5.87	A	1.00
* 4923.95	46.14	35.10	2.64	35.24	9.50	1.60	40.74	74	-33.26	P	1.00
* 4923.95	34.03	35.10	2.64	35.24	9.50	1.60	28.63	54	-25.37	A	1.00
* 7386.00	44.71	39.75	4.85	35.62	9.50	2.00	46.19	74	-27.81	P	1.00
* 7386.00	33.27	39.75	4.85	35.62	9.50	2.00	34.75	54	-19.25	A	1.00
9847.79	47.86	38.52	5.90	36.76	9.50	0.49	46.51	74	-27.49	P	1.00
9847.79	36.37	38.52	5.90	36.76	9.50	0.49	35.02	54	-18.98	A	1.00
* 12301.50	-----	-----	-----	-----	9.50	0.80	-----	-----	-----	-----	1.00
14761.80	-----	-----	-----	-----	0.00	0.49	-----	-----	-----	-----	1.00
17222.10	-----	-----	-----	-----	0.00	0.59	-----	-----	-----	-----	1.00
* 19682.40	-----	-----	-----	-----	0.00	2.38	-----	-----	-----	-----	1.00
* 22142.70	-----	-----	-----	-----	0.00	0.70	-----	-----	-----	-----	1.00
24603.00	-----	-----	-----	-----	0.00	2.16	-----	-----	-----	-----	1.00

Note :

- The measurement was searched to 10th harmonic, Remark “---” means that the emissions level is too low to be measured.
- AF: Antenna Factor, Cable: Cable Loss, Pre-Amp: Preamplifier gain, Filter: High Pass Filter Insertion Loss (3.5GHz)
- Analyzer setting P(Peak): RBW=1MHz, VBW=1MHz, A(Average): RBW=1MHz, VBW=10Hz
- Remark “*” means that Restricted band.
- Dist : correction to extra plate reading to 3m specification distance 1m measurement distance = -9.5dB
- The result basic equation calculation is as follow:
 $Level = Reading + AF + Cable - Preamp + Filter - Dist$, $Margin = Level - Limit$
- The other emission levels were very low against the limit
- The test limit distance is 3M limit.
- For 802.11g mode at 6Mbps.
- For Antenna 4 (G736).

3.7 Photos of Open Site





4. 6dB BANDWIDTH MEASUREMENT

4.1 Test Equipments

Description & Manufacturer	Model No.	Serial No.	Date Of Calibration
ROHDE & SCHWARZ SPECTRUM ANALYZER	FSEK30	835253/002	JUN. 17, 2003
HP ATTENUATOR	8496B	3247A18505	Cal. on use
HP PLOTTER	7750A	725A 852141	N/A

Note :

1. The measurement uncertainty is less than +/- 2.6dB, which is calculated as per the NAMAS document NIS81.
2. The calibration interval of the above test instruments is 12 months and the calibrations are traceable to NML/ROC and NIST/USA.

4.2 Test Setup

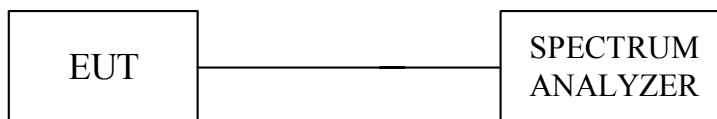

4.3 Limits of 6dB Bandwidth Measurement

The minimum of 6dB Bandwidth Measurement is >500KHz

4.4 Test Procedure

The transmitter output was connected to the spectrum analyzer through an attenuator. The bandwidth of the fundamental frequency was measured by spectrum analyzer with 100 KHz RBW and 100 KHz VBW. The 6dB bandwidth is defined as the total spectrum the power of which is higher than peak power minus 6dB.

4.5 Uncertainty of Conducted Emission

The uncertainty of conducted emission is ± 200KHz.

**Ecom Sertech Corp.**

Rm. 258, Bldg. 17, NO.195, Sec. 4 Chung Hsing Rd., ChuTung Chen, Hsinchu, Taiwan 310, R.O.C
TEL:886-3-5918012 FAX : 886-3-5825720

FCC ID : QDWWM168GI
Report No. : ER03-11-068FRF
Page 124 of 151

4.6 Test Results

Input Power (System)	3.3VDC (From Notebook PC)	Environmental Conditions	17.9°C, 72%RH
Tested By	K. P. Pang		

Channel	Channel Frequency (MHz)	6dB Bandwidth (MHz)	Minimum Limit (MHz)	Pass / Fail
1	2412	12.66	0.5	PASS
6	2437	12.70	0.5	PASS
11	2462	12.66	0.5	PASS

Note: For 802.11b Mode

Channel	Channel Frequency (MHz)	6dB Bandwidth (MHz)	Minimum Limit (MHz)	Pass / Fail
1	2412	16.99	0.5	PASS
6	2437	16.99	0.5	PASS
11	2462	16.99	0.5	PASS

Note: For 802.11g Mode



Ecom Sertech Corp.

Rm. 258, Bldg. 17, NO.195, Sec. 4 Chung Hsing Rd., ChuTung Chen, Hsinchu, Taiwan 310, R.O.C
TEL:886-3-5918012 FAX : 886-3-5825720

FCC ID : QDWWM168GI
Report No. : ER03-11-068FRF
Page 125 of 151

4.7 Photo of 6db Bandwidth Measurement

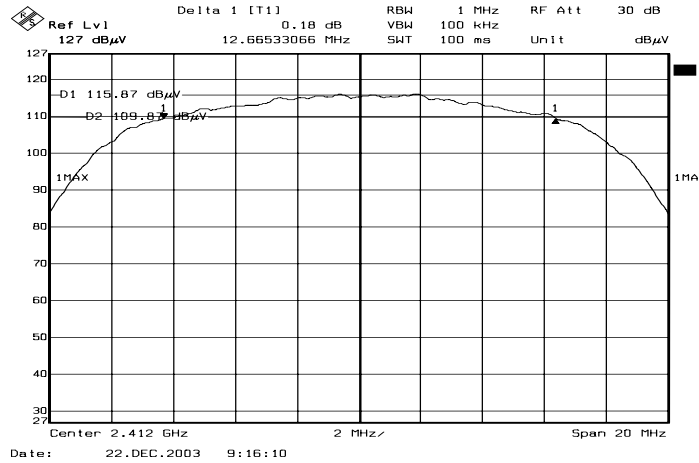

Channel 1

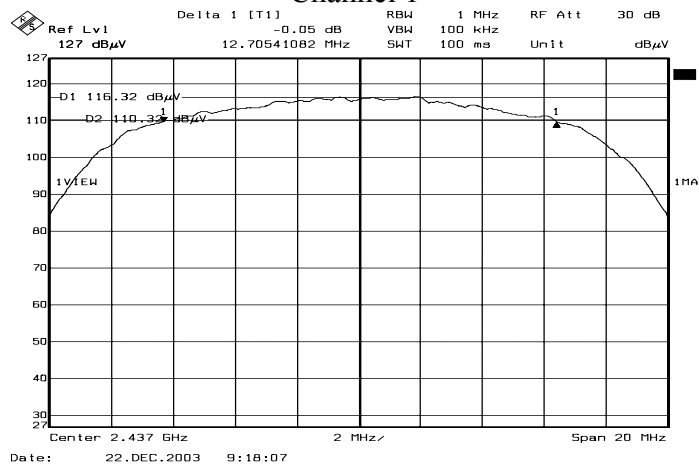

Channel 6

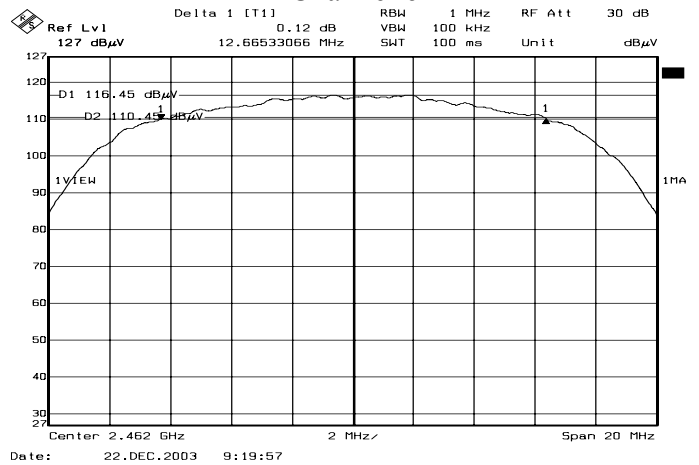

Channel 11

Note: For 802.11b Mode



Ecom Sertech Corp.

Rm. 258, Bldg. 17, NO.195, Sec. 4 Chung Hsing Rd., ChuTung Chen, Hsinchu, Taiwan 310, R.O.C
TEL:886-3-5918012 FAX : 886-3-5825720

FCC ID : QDWWM168GI

Report No. : ER03-11-068FRF

Page 126 of 151

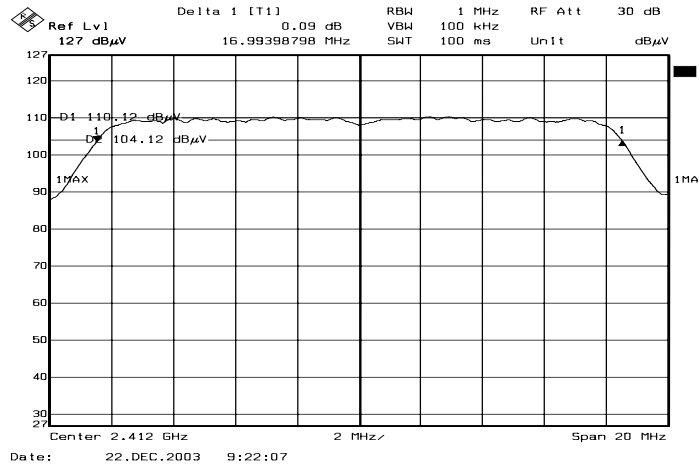

Channel 1

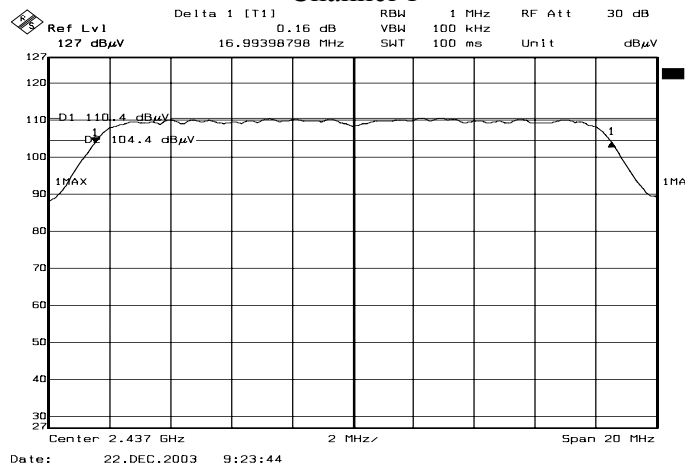

Channel 6

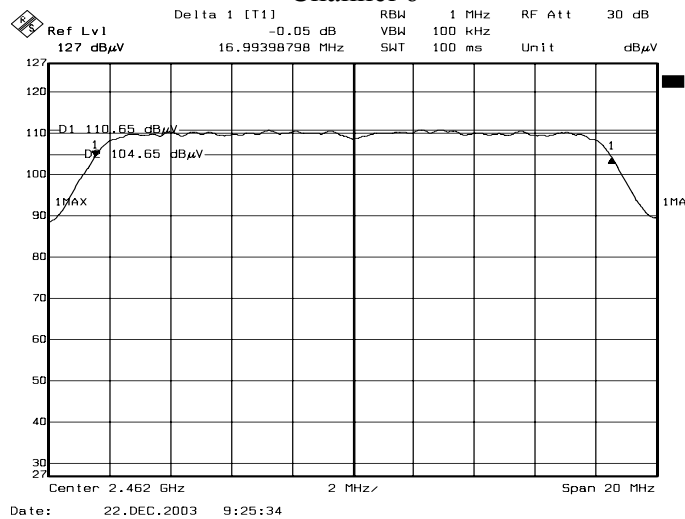

Channel 11

Note: For 802.11g Mode

5. MAXIMUM PEAK OUTPUT POWER

5.1 Test Equipments

Description & Manufacturer	Model No.	Serial No.	Date Of Calibration
ROHDE & SCHWARZ SPECTRUM ANALYZER	FSEK30	835253/002	JUN. 17, 2003
HP ATTENUATOR	8496B	3247A18505	Cal. on use
HP PLOTTER	7750A	725A 852141	N/A
GIGASTRONICS POWER METER	8542	1828329	SEPT.19, 2003

Note :

1. The measurement uncertainty is less than +/- 2.6dB, which is calculated as per the NAMAS document NIS81.
2. The calibration interval of the above test instruments is 12 months and the calibrations are traceable to NML/ROC and NIST/USA.

5.2 Test Setup

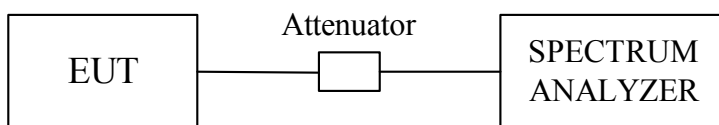

5.3 Limits of Maximum Peak Output Power

The Maximum Peak Output Power Measurement is 30dBm.



5.4 Test Procedure

The RF power output was measured with a Power meter connected to the RF Antenna connector (conducted measurement) while EUT was operating in transmit mode at the appropriate center frequency.

5.5 Uncertainty of Conducted Emission

The uncertainty of conducted emission is ± 1.82 dB.

5.6 Test Results

Input Power (System)	3.3VDC (From Notebook PC)	Environmental Conditions	17.9°C, 72%RH
Tested By	K. P. Pang		

Channel	Channel Frequency (MHz)	Peak Power Output (dBm)	Peak Power Limit (dBm)	Pass / Fail
1	2412	18.46	30	PASS
6	2437	18.78	30	PASS
11	2462	18.80	30	PASS

Note : 1. For 802.11b Mode
 2. At final test to get the worst-case emission at 11Mbps.
 3. The result basic equation calculation as follow :
 $Peak\ Power\ Output = Peak\ Power\ Reading + Cable\ loss + Attenuator$

Channel	Channel Frequency (MHz)	Peak Power Output (dBm)	Peak Power Limit (dBm)	Pass / Fail
1	2412	18.02	30	PASS
6	2437	18.36	30	PASS
11	2462	18.52	30	PASS

Note : 1. For 802.11g Mode
 2. At final test to get the worst-case emission at 6Mbps.
 3. The result basic equation calculation as follow :
 $Peak\ Power\ Output = Peak\ Power\ Reading + Cable\ loss + Attenuator$



6. POWER SPECTRAL DENSITY MEASUREMENT

6.1 Test Equipments

Description & Manufacturer	Model No.	Serial No.	Date Of Calibration
ROHDE & SCHWARZ SPECTRUM ANALYZER	FSEK30	835253/002	JUN. 17, 2003
HP ATTENUATOR	8496B	3247A18505	Cal. on use
HP PLOTTER	7750A	725A 852141	N/A

Note :

1. The measurement uncertainty is less than +/- 2.6dB, which is calculated as per the NAMAS document NIS81.
2. The calibration interval of the above test instruments is 12 months and the calibrations are traceable to NML/ROC and NIST/USA.

6.2 Test Setup

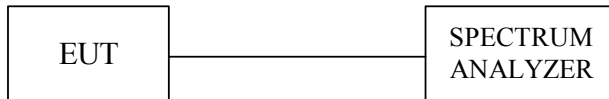

6.3 Limits of Power Spectral Density Measurement

The Maximum Power Spectral Density Measurement is 8dBm.



6.4 Test Procedure

The transmitter output was connected to the spectrum analyzer through an attenuator, the bandwidth of the fundamental frequency was measured with the spectrum analyzer using 3KHz RBW and 30KHz VBW, set sweep time=span / 3KHz.

The power spectral density was measured and recorded.

The sweep time is allowed to be longer than span / 3KHz for a full response of the mixer in the spectrum analyzer.

6.5 Uncertainty of Conducted Emission

The uncertainty of conducted emission is ± 1.82dB.

6.6 Test Results

Input Power (System)	3.3VDC (From Notebook PC)	Environmental Conditions	17.9°C, 72%RH,
Tested By	K. P. Pang		

Channel	Channel Frequency (MHz)	Final RF Power Level in 3KHz BW (dBm)	Maximum Limit (dBm)	Pass / Fail
1	2412	-8.51	8	PASS
6	2437	-7.94	8	PASS
11	2462	-8.29	8	PASS

Note: For 11Mbps (802.11b mode) at final test to get the worst-case emission at 11Mbps.

Channel	Channel Frequency (MHz)	Final RF Power Level in 3KHz BW (dBm)	Maximum Limit (dBm)	Pass / Fail
1	2412	-16.23	8	PASS
6	2437	-16.03	8	PASS
11	2462	-15.70	8	PASS

Note: For 54Mbps (802.11g mode) at final test to get the worst-case emission at 6Mbps.



6.7 Photo of Power Spectral Density Measurement

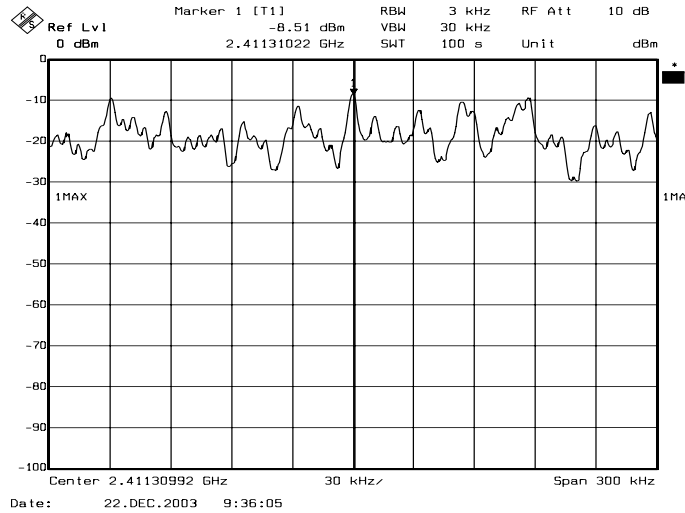

Channel 1

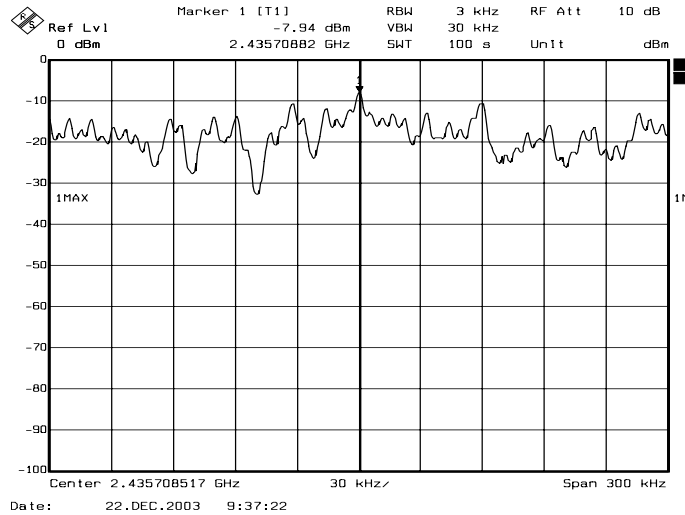

Channel 6

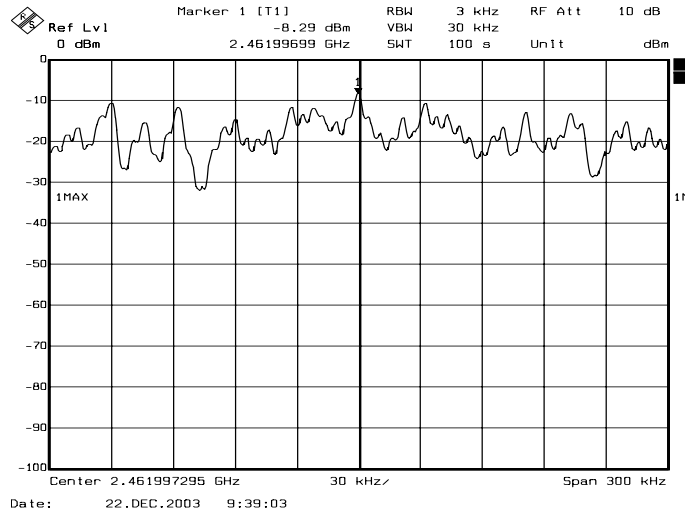

Channel 11

Note: For 802.11b Mode



Ecom Sertech Corp.

Rm. 258, Bldg. 17, NO.195, Sec. 4 Chung Hsing Rd., ChuTung Chen, Hsinchu, Taiwan 310, R.O.C
TEL:886-3-5918012 FAX: 886-3-5825720

FCC ID : QDWWM168GI
Report No. : ER03-11-068FRF
Page 132 of 151

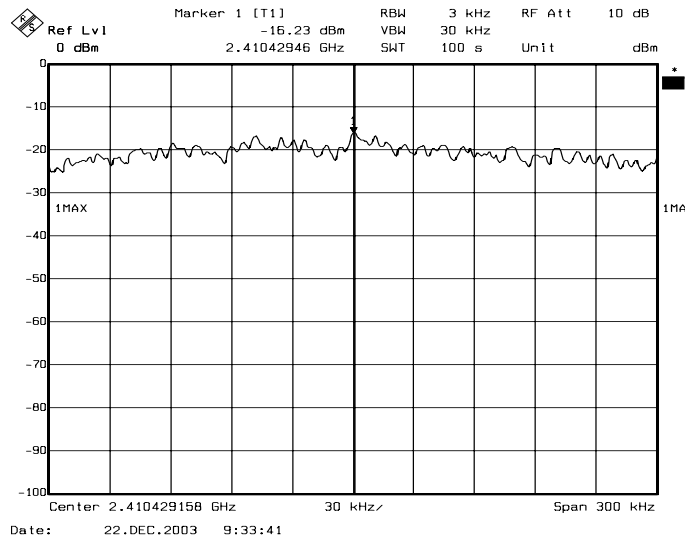

Channel 1

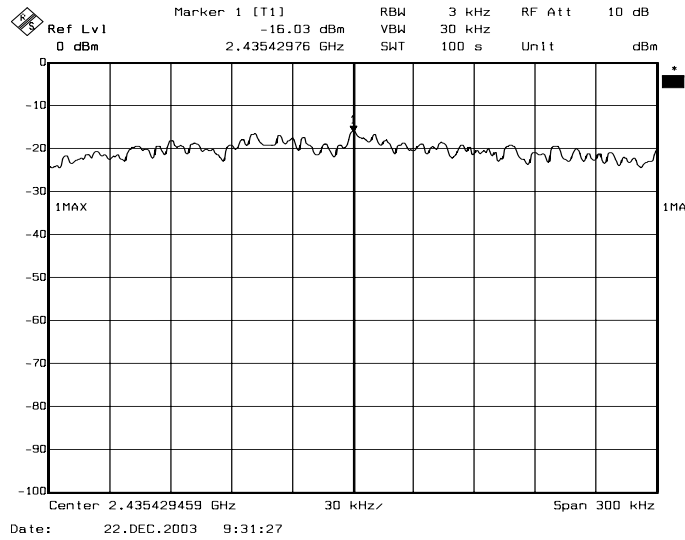

Channel 6

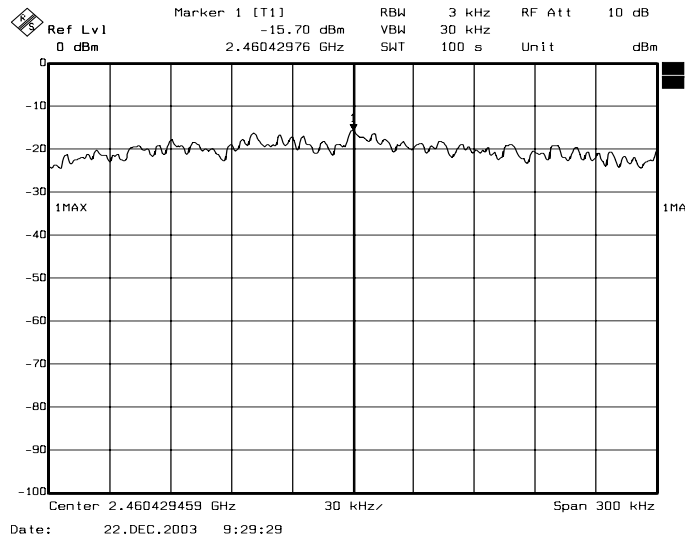

Channel 11

Note: For 802.11g Mode



7. BANDEDGE MEASUREMENT

7.1 Test Equipments

Description & Manufacturer	Model No.	Serial No.	Date Of Calibration
ROHDE & SCHWARZ SPECTRUM ANALYZER	FSEK30	835253/002	JUN. 17, 2003
HP ATTENUATOR	8496B	3247A18505	Cal. on use
HP PLOTTER	7750A	725A 852141	N/A

Note :

1. The measurement uncertainty is less than +/- 2.6dB, which is calculated as per the NAMAS document NIS81.
2. The calibration interval of the above test instruments is 12 months and the calibrations are traceable to NML/ROC and NIST/USA.

7.2 Test Setup

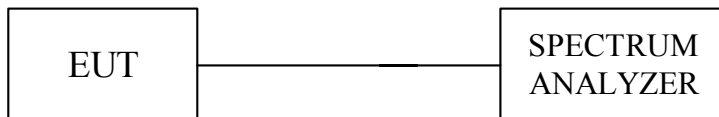

7.3 Limits of Out of Band Emissions Measurement

1. Below -20dB of the highest emission level of operating band (in 100KHz Resolution Bandwidth).
2. Fall in the restricted bands listed in section 15.205. The maximum permitted average field strength is listed in section 15.209.



7.4 Test Procedure

The transmitter output was connected to the spectrum analyzer via a low lose cable. Set both RBW and VBW of spectrum analyzer to 100KHz with suitable frequency span including 100KHz bandwidth from band edge. The band edges was measured and recorded.

7.5 Uncertainty of Conducted Emission

The uncertainty of conducted emission is ± 1.82 dB.

7.6 Test Results

A. Conducted

Refer to 7.7 photo of out band Emission measurement

B. Radiated

For 802.11b Mode

For Antenna 1 (A530A531)

Refer to the section 3.6, the measured radiated band edge emissions are listed below :

Input Power (System)	3.3VDC (From Notebook PC)	Environmental Conditions	17.9°C, 72%RH
Tested By	K. P. Pang		

Band edge		Measured radiated band edge field strength (dBuV/m)		Radiated band edge field strength limit (dBuV/m)		Test result
		Horizontal	Vertical	Horizontal	Vertical	
2399.90	PK	55.45	50.51	69.31	64.37	pass
	AVG	48.15	43.13	62.87	57.85	
2483.50	PK	40.68	37.47	74.00	74.00	pass
	AVG	27.89	24.54	54.00	54.00	

Note : Radiated front band edge field strength is measured with FCC recommended mark-delta method.
Measured radiated band edge field strength Test Results = Radiated fundamental emission field strength - DELTA.
DELTA = Relative measurement between conducted measured peak level of fundamental emission and relevant band edge emission. Please refer to 7.7 photo of out of Band Measurement.



**For 802.11g Mode
For Antenna 1 (A530A531)**

Refer to the section 3.6, the measured radiated band edge emissions are listed below :

Input Power (System)	3.3VDC (From Notebook PC)	Environmental Conditions	17.9°C, 72%RH
Tested By	K. P. Pang		

Band edge		Measured radiated band edge field strength (dBuV/m)		Radiated band edge field strength limit (dBuV/m)		Test result
		Horizontal	Vertical	Horizontal	Vertical	
2399.90	PK	62.22	60.02	67.41	65.21	pass
	AVG	49.31	47.03	59.19	56.91	
2483.50	PK	48.34	46.53	74.00	74.00	pass
	AVG	34.38	32.12	54.00	54.00	

Note : Radiated front band edge field strength is measured with FCC recommended mark-delta method.
 Measured radiated band edge field strength Test Results = Radiated fundamental emission field strength - DELTA.
 DELTA = Relative measurement between conducted measured peak level of fundamental emission and relevant band edge emission. Please refer to 7.7 photo of out of Band Measurement.



**For 802.11b Mode
 For Antenna 2 (A535)**

Refer to the section 3.6, the measured radiated band edge emissions are listed below :

Input Power (System)	3.3VDC (From Notebook PC)	Environmental Conditions	17.9°C, 72%RH
Tested By	K. P. Pang		

Band edge		Measured radiated band edge field strength (dBuV/m)		Radiated band edge field strength limit (dBuV/m)		Test result
		Horizontal	Vertical	Horizontal	Vertical	
2399.90	PK	67.79	69.05	81.65	82.91	pass
	AVG	60.13	61.39	74.85	76.11	
2483.50	PK	52.16	53.52	74.00	74.00	pass
	AVG	39.03	40.59	54.00	54.00	

Note : Radiated front band edge field strength is measured with FCC recommended mark-delta method.
 Measured radiated band edge field strength Test Results = Radiated fundamental emission field strength - DELTA.
 DELTA = Relative measurement between conducted measured peak level of fundamental emission and relevant band edge emission. Please refer to 7.7 photo of out of Band Measurement.



**For 802.11g Mode
 For Antenna 2 (A535)**

Refer to the section 3.6, the measured radiated band edge emissions are listed below :

Input Power (System)	3.3VDC (From Notebook PC)	Environmental Conditions	17.9°C, 72%RH
Tested By	K. P. Pang		

Band edge		Measured radiated band edge field strength (dBuV/m)		Radiated band edge field strength limit (dBuV/m)		Test result
		Horizontal	Vertical	Horizontal	Vertical	
		2399.90	PK	72.63	73.96	
	AVG	59.70	60.91	69.58	70.79	
2483.50	PK	57.25	58.96	74.00	74.00	pass
	AVG	43.26	44.70	54.00	54.00	

Note : Radiated front band edge field strength is measured with FCC recommended mark-delta method.
 Measured radiated band edge field strength Test Results = Radiated fundamental emission field strength - DELTA.
 DELTA = Relative measurement between conducted measured peak level of fundamental emission and relevant band edge emission. Please refer to 7.7 photo of out of Band Measurement.



**For 802.11b Mode
For Antenna 3 (A800)**

Refer to the section 3.6, the measured radiated band edge emissions are listed below :

Input Power (System)	3.3VDC (From Notebook PC)	Environmental Conditions	17.9°C, 72%RH
Tested By	K. P. Pang		

Band edge		Measured radiated band edge field strength (dBuV/m)		Radiated band edge field strength limit (dBuV/m)		Test result
		Horizontal	Vertical	Horizontal	Vertical	
2399.90	PK	75.74	77.38	89.60	91.24	pass
	AVG	67.98	69.82	82.70	84.54	
2483.50	PK	61.83	60.97	74.00	74.00	pass
	AVG	48.96	48.19	54.00	54.00	

Note : Radiated front band edge field strength is measured with FCC recommended mark-delta method.
Measured radiated band edge field strength Test Results = Radiated fundamental emission field strength - DELTA.
DELTA = Relative measurement between conducted measured peak level of fundamental emission and relevant band edge emission. Please refer to 7.7 photo of out of Band Measurement.



**For 802.11g Mode
 For Antenna 3 (A800)**

Refer to the section 3.6, the measured radiated band edge emissions are listed below :

Input Power (System)	3.3VDC (From Notebook PC)	Environmental Conditions	17.9°C, 72%RH
Tested By	K. P. Pang		

Band edge		Measured radiated band edge field strength (dBuV/m)		Radiated band edge field strength limit (dBuV/m)		Test result
		Horizontal	Vertical	Horizontal	Vertical	
2399.90	PK	80.07	82.12	85.26	87.31	pass
	AVG	65.42	67.07	75.30	76.95	
2483.50	PK	66.77	66.70	74.00	74.00	pass
	AVG	51.00	50.89	54.00	54.00	

Note : Radiated front band edge field strength is measured with FCC recommended mark-delta method.
 Measured radiated band edge field strength Test Results = Radiated fundamental emission field strength - DELTA.
 DELTA = Relative measurement between conducted measured peak level of fundamental emission and relevant band edge emission. Please refer to 7.7 photo of out of Band Measurement.



Ecom Sertech Corp.

Rm. 258, Bldg. 17, NO.195, Sec. 4 Chung Hsing Rd., ChuTung Chen, Hsinchu, Taiwan 310, R.O.C
TEL:886-3-5918012 FAX : 886-3-5825720

FCC ID : QDWWM168GI
Report No. : ER03-11-068FRF
Page 140 of 151

**For 802.11b Mode
For Antenna 4 (G736)**

Refer to the section 3.6, the measured radiated band edge emissions are listed below :

Input Power (System)	3.3VDC (From Notebook PC)	Environmental Conditions	17.9°C, 72%RH
Tested By	K. P. Pang		

Band edge		Measured radiated band edge field strength (dBuV/m)		Radiated band edge field strength limit (dBuV/m)		Test result
		Horizontal	Vertical	Horizontal	Vertical	
2399.90	PK	63.17	62.45	77.03	76.31	pass
	AVG	55.84	55.08	70.56	69.80	
2483.50	PK	48.24	48.47	74.00	74.00	pass
	AVG	33.69	35.34	54.00	54.00	

Note : Radiated front band edge field strength is measured with FCC recommended mark-delta method.
 Measured radiated band edge field strength Test Results = Radiated fundamental emission field strength - DELTA.
 DELTA = Relative measurement between conducted measured peak level of fundamental emission and relevant band edge emission. Please refer to 7.7 photo of out of Band Measurement.



**For 802.11g Mode
For Antenna 4 (G736)**

Refer to the section 3.6, the measured radiated band edge emissions are listed below :

Input Power (System)	3.3VDC (From Notebook PC)	Environmental Conditions	17.9°C, 72%RH
Tested By	K. P. Pang		

Band edge		Measured radiated band edge field strength (dBuV/m)		Radiated band edge field strength limit (dBuV/m)		Test result
		Horizontal	Vertical	Horizontal	Vertical	
		2399.90	PK	70.29	70.85	
	AVG	57.23	57.85	67.11	67.73	
2483.50	PK	55.66	56.06	74.00	74.00	pass
	AVG	41.27	42.16	54.00	54.00	

Note : Radiated front band edge field strength is measured with FCC recommended mark-delta method.
 Measured radiated band edge field strength Test Results = Radiated fundamental emission field strength - DELTA.
 DELTA = Relative measurement between conducted measured peak level of fundamental emission and relevant band edge emission. Please refer to 7.7 photo of out of Band Measurement.



7.7 Photo of Out of Bandedge Measurement

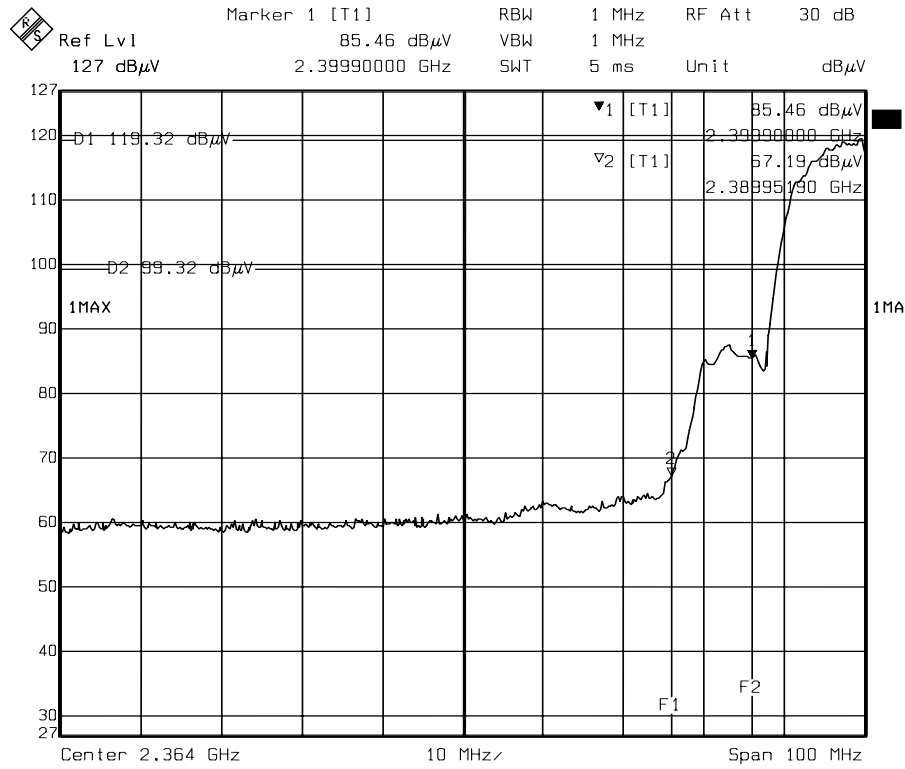

Date: 22.DEC.2003 10:05:07

FRONT (Peak)

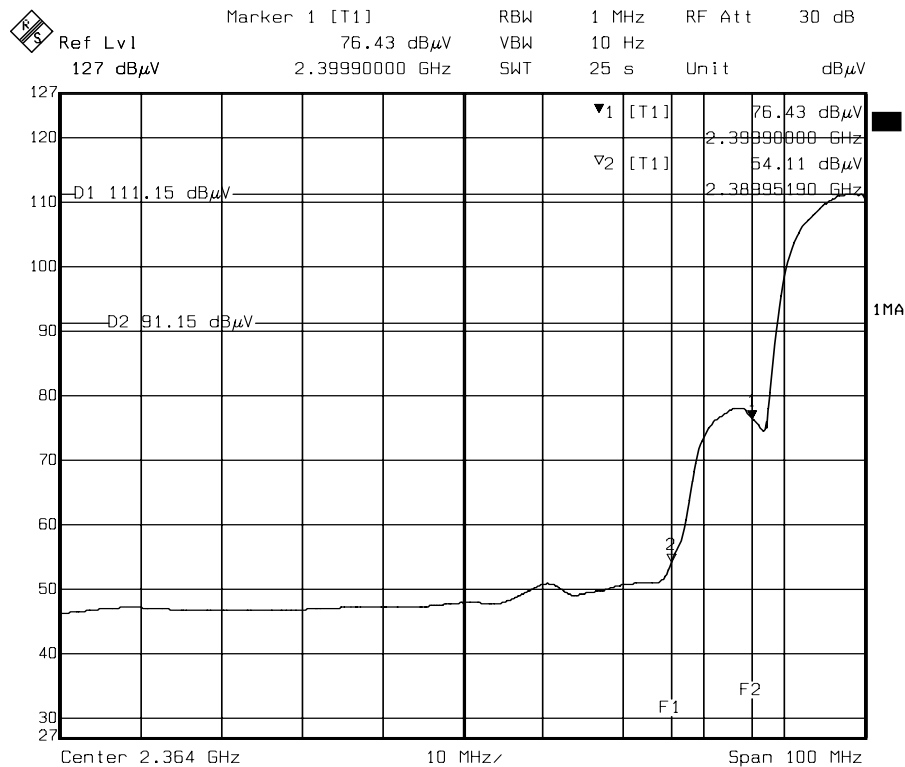

Date: 22.DEC.2003 10:08:04

FRONT (AVG)

Note: For 802.11b Mode



Ecom Sertech Corp.

Rm. 258, Bldg. 17, NO.195, Sec. 4 Chung Hsing Rd., ChuTung Chen, Hsinchu, Taiwan 310, R.O.C
 TEL:886-3-5918012 FAX: 886-3-5825720

FCC ID : QDWWM168GI
 Report No. : ER03-11-068FRF
 Page 143 of 151

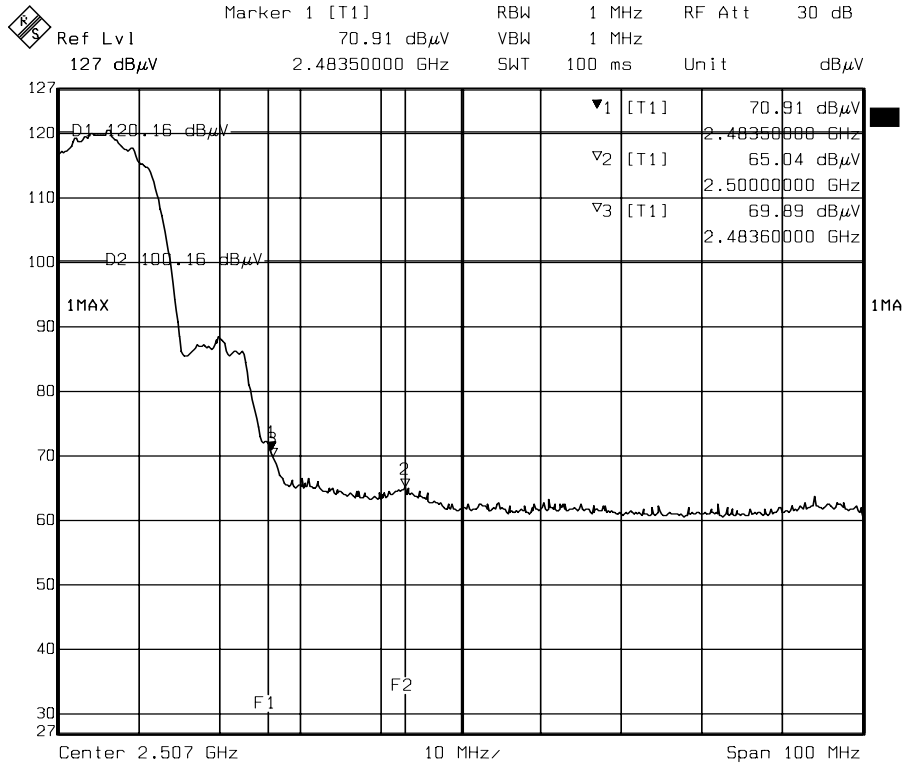

Date: 22.DEC.2003 9:44:04

BACK (Peak)

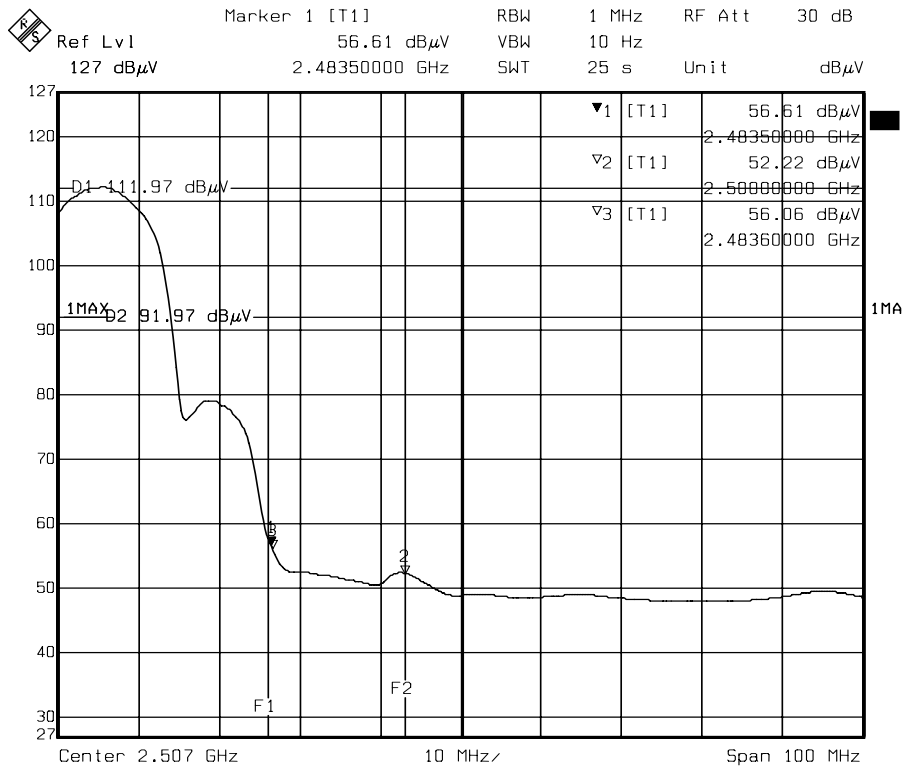

Date: 22.DEC.2003 9:45:26

BACK (AVG)

Note: For 802.11b Mode



Ecom Sertech Corp.

Rm. 258, Bldg. 17, NO.195, Sec. 4 Chung Hsing Rd., ChuTung Chen, Hsinchu, Taiwan 310, R.O.C
TEL:886-3-5918012 FAX: 886-3-5825720

FCC ID : QDWWM168GI
Report No. : ER03-11-068FRF
Page 144 of 151

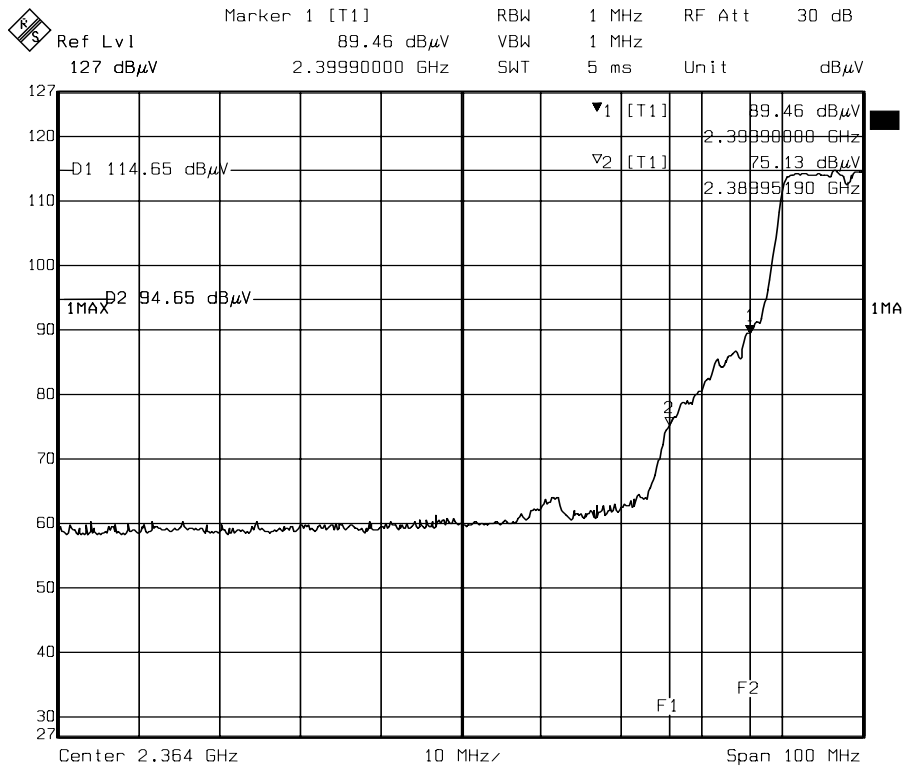

Date: 22.DEC.2003 9:57:17

FRONT (Peak)

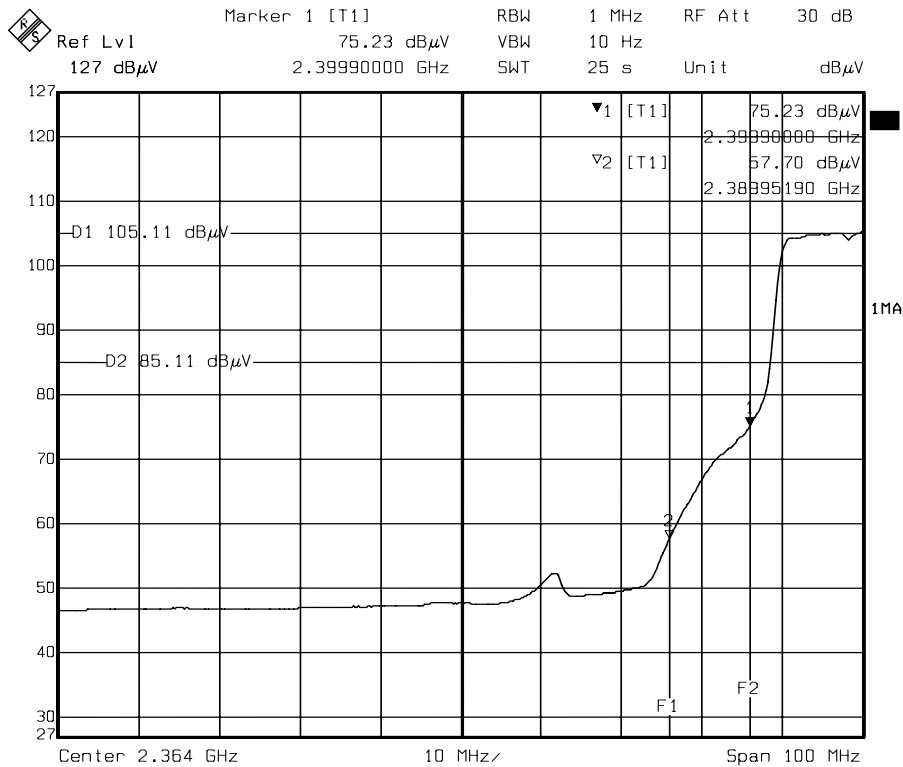

Date: 22.DEC.2003 10:10:38

FRONT (AVG)

Note: For 802.11g Mode



Ecom Sertech Corp.

Rm. 258, Bldg. 17, NO.195, Sec. 4 Chung Hsing Rd., ChuTung Chen, Hsinchu, Taiwan 310, R.O.C
 TEL:886-3-5918012 FAX : 886-3-5825720

FCC ID : QDWWM168GI
 Report No. : ER03-11-068FRF
 Page 145 of 151

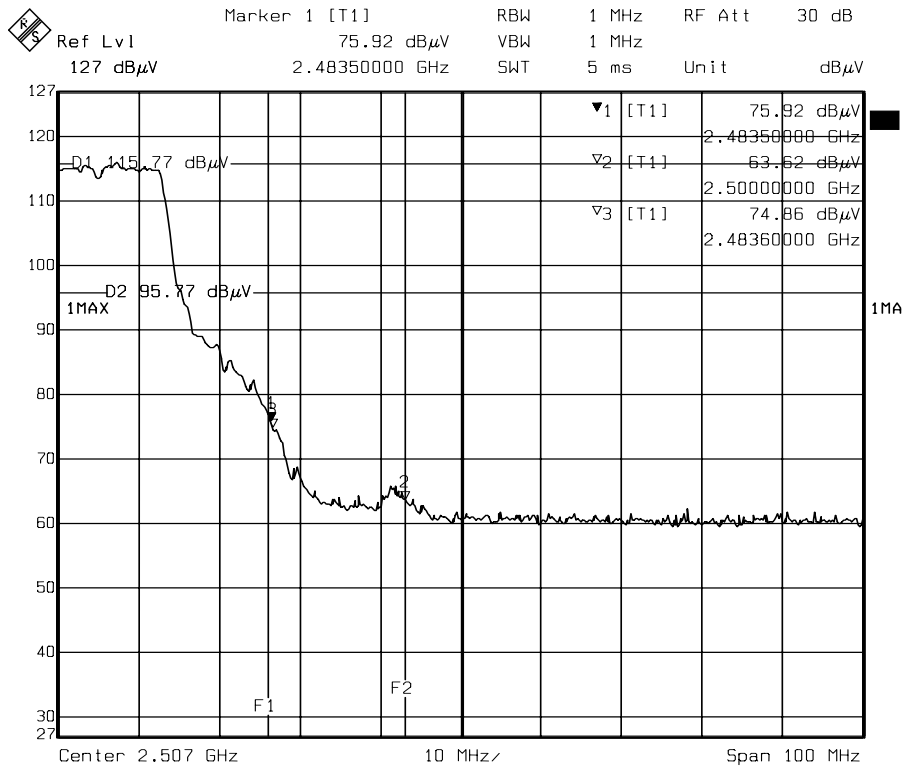

Date: 22.DEC.2003 9:53:05

BACK (Peak)

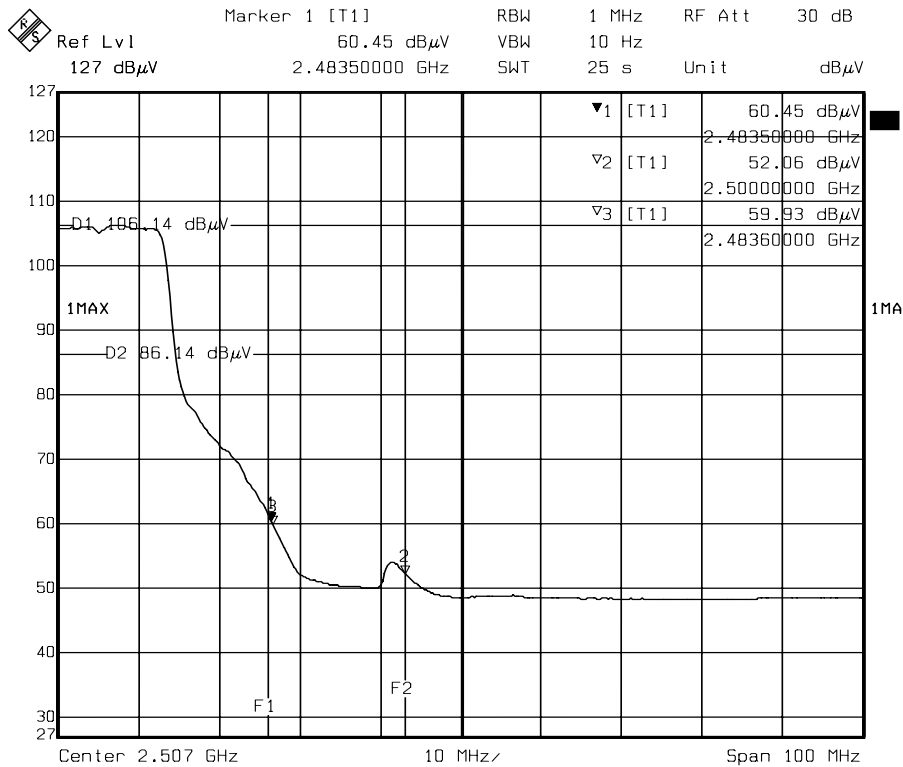

Date: 22.DEC.2003 9:47:15

BACK (AVG)

Note: For 802.11g Mode



8. ANTENNA REQUIREMENT

8.1 Standard Applicable

For intentional device, according to FCC 47 CFR Section 15.203, an intentional radiator shall be designed to ensure that no antenna other than that furnished by the responsible party shall be used with the device.

And according to FCC 47 CFR Section 15.247 (b), if transmitting antennas of directional gain greater than 6dBi are used, the power shall be reduced by the amount in dB that the directional gain of the antenna exceeds 6dBi.

8.2 Antenna Connected Construction

The antennae used for the EUT are 4 pair of PIFA antennae. The maximum gains of each pair of the antennae are listed below, the internal connector is MMCX connector and each of the antennae can not be used individually. The model name and antenna gain of each pair of antennae are :

Antenna 1 : A530A531, Antenna gain = 0.43dBi.

Antenna 2 : A535, Antenna gain = -0.19dBi.

Antenna 3 : A800, Antenna gain = 1.334dBi.

Antenna 4 : G736, Antenna gain = 2.03dBi.



9. RF EXPOSURE EVALUATION

According to FCC 1.1310 : The criteria listed in the following table shall be used to evaluate the environment impact of human exposure to radio frequency (RF) radiation as specified in 1.1307(b)
LIMITS FOR MAXIMUM PERMISSIBLE EXPOSURE (MPE)

Frequency Range (MHz)	Electric Field Strength (V/m)	Magnetic Field Strength (A/m)	Power Density (mW/cm ²)	Average Time
(A) Limits for Occupational / Control Exposures				
300-1,500	--	--	F/300	6
1,500-100,000	--	--	5	6
(B) Limits for General Population / Uncontrol Exposures				
300-1,500	--	--	F/1500	6
1,500-100,000	--	--	1	30

9.1 Friis Formula

Friis transmission formula : $Pd = (Pout * G) / (4 * pi * r^2)$

Where

Pd = power density in mW/cm²

Pout = output power to antenna in mW

G = gain of antenna in linear scale

Pi = 3.1416

R = distance between observation point and center of the radiator in cm

Pd is the limit of MPE, 1 mW/cm². If we know the maximum gain of the antenna and the total power input to the antenna, through the calculation, we will know the distance r where the MPE limit is reached.

9.2 EUT Operating Condition

A software provided by client enabled the EUT to transmit and receive data at lowest, middle and highest channel individually.



9.3 Test Result of RF Exposure Evaluation

Test Item : RF Exposure Evaluation Data
Test Mode : Normal Operation

9.3.1 Antenna Gain

Antenna Gain : The maximum Gain measured in fully anechoic chamber is 2dBi linear scale.

9.3.2 Output Power into Antenna & RF Exposure Evaluation Distance

For Antenna 1 (A530A531), Antenna Gain : 0.43dBi.

Channel	Channel Frequency (MHz)	Output Power to Antenna (dBm)	Power Density at 20cm (mW/cm ²)	LIMITS (mW/cm ²)
CH1	2412.00	18.89	0.015407	1
CH6	2437.00	19.21	0.016586	1
CH11	2462.00	19.23	0.016662	1

Note : 1. For Antenna 1 802.11b Mode (11Mbps).

- The power density Pd (4th column) at a distance of 20cm calculated from the Friis transmission formula is far below the limit of 1 mW/cm². The EUT is classified as mobile product. So, RF exposure limit warning or SAR test are not required.

For Antenna 1 (A530A531), Antenna Gain : 0.43dBi.

Channel	Channel Frequency (MHz)	Output Power to Antenna (dBm)	Power Density at 20cm (mW/cm ²)	LIMITS (mW/cm ²)
CH1	2412.00	18.45	0.013923	1
CH6	2437.00	18.79	0.015057	1
CH11	2462.00	18.95	0.015622	1

Note : 1. For Antenna 1 802.11g Mode (6Mbps).

- The power density Pd (4th column) at a distance of 20cm calculated from the Friis transmission formula is far below the limit of 1 mW/cm². The EUT is classified as mobile product. So, RF exposure limit warning or SAR test are not required.

**Ecom Sertech Corp.**

Rm. 258, Bldg. 17, NO.195, Sec. 4 Chung Hsing Rd., ChuTung Chen, Hsinchu, Taiwan 310, R.O.C
TEL:886-3-5918012 FAX : 886-3-5825720

FCC ID : QDWWM168GI
Report No. : ER03-11-068FRF
Page 149 of 151

For Antenna 2 (A535), Antenna Gain : -0.19dBi.

Channel	Channel Frequency (MHz)	Output Power to Antenna (dBm)	Power Density at 20cm (mW/cm ²)	LIMITS (mW/cm ²)
CH1	2412.00	18.46	0.013358	1
CH6	2437.00	18.78	0.014379	1
CH11	2462.00	18.80	0.014445	1

Note : 1. For Antenna 2 802.11b Mode (11Mbps).

2. The power density Pd (4th column) at a distance of 20cm calculated from the Friis transmission formula is far below the limit of 1 mW/cm². The EUT is classified as mobile product. So, RF exposure limit warning or SAR test are not required.

For Antenna 2 (A535), Antenna Gain : -0.19dBi.

Channel	Channel Frequency (MHz)	Output Power to Antenna (dBm)	Power Density at 20cm (mW/cm ²)	LIMITS (mW/cm ²)
CH1	2412.00	18.02	0.012071	1
CH6	2437.00	18.36	0.013054	1
CH11	2462.00	18.52	0.013543	1

Note : 1. For Antenna 2 802.11g Mode (6Mbps).

2. The power density Pd (4th column) at a distance of 20cm calculated from the Friis transmission formula is far below the limit of 1 mW/cm². The EUT is classified as mobile product. So, RF exposure limit warning or SAR test are not required.

**Ecom Sertech Corp.**

Rm. 258, Bldg. 17, NO.195, Sec. 4 Chung Hsing Rd., ChuTung Chen, Hsinchu, Taiwan 310, R.O.C
TEL:886-3-5918012 FAX : 886-3-5825720

FCC ID : QDWWM168GI
Report No. : ER03-11-068FRF
Page 150 of 151

For Antenna 3 (A800), Antenna Gain : 1.334dBi.

Channel	Channel Frequency (MHz)	Output Power to Antenna (dBm)	Power Density at 20cm (mW/cm ²)	LIMITS (mW/cm ²)
CH1	2412.00	19.794	0.018973	1
CH6	2437.00	20.114	0.020423	1
CH11	2462.00	20.134	0.020518	1

Note : 1. For Antenna 3 802.11b Mode (11Mbps).

- The power density Pd (4th column) at a distance of 20cm calculated from the Friis transmission formula is far below the limit of 1 mW/cm². The EUT is classified as mobile product. So, RF exposure limit warning or SAR test are not required.

For Antenna 3 (A800), Antenna Gain : 1.334dBi.

Channel	Channel Frequency (MHz)	Output Power to Antenna (dBm)	Power Density at 20cm (mW/cm ²)	LIMITS (mW/cm ²)
CH1	2412.00	19.354	0.017145	1
CH6	2437.00	19.694	0.018541	1
CH11	2462.00	19.854	0.019237	1

Note : 1. For Antenna 3 802.11g Mode (6Mbps).

- The power density Pd (4th column) at a distance of 20cm calculated from the Friis transmission formula is far below the limit of 1 mW/cm². The EUT is classified as mobile product. So, RF exposure limit warning or SAR test are not required.

**Ecom Sertech Corp.**

Rm. 258, Bldg. 17, NO.195, Sec. 4 Chung Hsing Rd., ChuTung Chen, Hsinchu, Taiwan 310, R.O.C
TEL:886-3-5918012 FAX : 886-3-5825720

FCC ID : QDWWM168GI
Report No. : ER03-11-068FRF
Page 151 of 151

For Antenna 4 (G736), Antenna Gain : 2.03dBi.

Channel	Channel Frequency (MHz)	Output Power to Antenna (dBm)	Power Density at 20cm (mW/cm ²)	LIMITS (mW/cm ²)
CH1	2412.00	20.49	0.022271	1
CH6	2437.00	20.81	0.023973	1
CH11	2462.00	20.83	0.024084	1

Note : 1. For Antenna 4 802.11b Mode (11Mbps).

- The power density Pd (4th column) at a distance of 20cm calculated from the Friis transmission formula is far below the limit of 1 mW/cm². The EUT is classified as mobile product. So, RF exposure limit warning or SAR test are not required.

For Antenna 4 (G736), Antenna Gain : 2.03dBi.

Channel	Channel Frequency (MHz)	Output Power to Antenna (dBm)	Power Density at 20cm (mW/cm ²)	LIMITS (mW/cm ²)
CH1	2412.00	20.05	0.020125	1
CH6	2437.00	20.39	0.021764	1
CH11	2462.00	20.55	0.022580	1

Note : 1. For Antenna 4 802.11g Mode (6Mbps).

- The power density Pd (4th column) at a distance of 20cm calculated from the Friis transmission formula is far below the limit of 1 mW/cm². The EUT is classified as mobile product. So, RF exposure limit warning or SAR test are not required.