



ELECTROMAGNETIC COMPATIBILITY TEST REPORT

Company : AirVast Technology Inc.
Address : 4F, No.1, Lu.21, HSIN Hua Rd, Kueishan Industria Park, Taoyuan
330, Taiwan, R.O.C.
Product name : 802.11b WLAN USB Module
Model name : WM168b
Date Received : MAR. 20, 2003
Date Tested : MAR. 20~APR. 7,2003

MEASUREMENT REQUIREMENT USED :

47 CFR Part 15, Subpart B and Subpart C (Section 15.247),
ANSI C63.4-2001

WE HEREBY CERTIFY THAT: The measurements shown in the attachment were made in accordance with the procedures indicated, and the energy emitted by the equipment was found to be within the limits applicable. We assume full responsibility for the accuracy and completeness of these measurements and vouch for the qualifications of all persons taking them.

	Name	Signature	Date
Testing Engineer	M. C. Huang / NVLAP	<i>M.C. Huang</i>	<i>APR. 8, 2003</i>
Approving Manager	Chieh-De Tsai / NVLAP	<i>Chieh-De Tsai</i>	<i>APR. 08, 2003</i>

Notes :

1. This report will be invalid if duplicated or photocopied in part.
2. This report refers only to the specimen(s) submitted to test, and is invalid as seperately used.
3. This report is invalid without examination stamp and signature of this institute.
4. The tested specimen(s) will be preserved for thirty days from the data issued.
5. The report must not be used to claim product certification, approval, or endorsement by NVLAP, NIST, or any agency of the federal government.



TABLE OF CONTENTS

TITLE	PAGE NO.
1. GENERAL INFORMATION.....	4
1.1 GENERAL STATEMENT.....	4
1.2 GENERAL DESCRIPTION OF EUT & POWER.....	4
1.3 DESCRIPTION OF PERIPHERALS.....	5
1.4 EUT & PERIPHERALS SETUP DIAGRAM.....	6
1.5 EUT OPERATING CONDITION.....	6
1.6 DESCRIPTION OF TEST SITE.....	7
1.7 SUMMARY OF TEST RESULTS.....	7
2. CONDUCTED POWERLINE TEST.....	8
2.1 TEST EQUIPMENTS.....	8
2.2 TEST SETUP.....	8
2.3 CONDUCTED POWER LINE EMISSION LIMIT.....	9
2.4 TEST PROCEDURE.....	9
2.5 UNCERTAINTY OF CONDUCTED EMISSION.....	9
2.6 CONDUCTED RF VOLTAGE MEASUREMENT.....	10
2.7 PHOTOS OF CONDUCTION TEST.....	11
3. RADIATED EMISSION TEST.....	12
3.1 TEST EQUIPMENTS.....	12
3.2 TEST SETUP.....	12
3.3 RADIATION LIMIT.....	13
3.4 TEST PROCEDURES.....	14
3.5 UNCERTAINTY OF RADIATED EMISSION.....	14
3.6 RADIATED RF NOISE MEASUREMENT.....	15-50
3.7 PHOTOS OF OPEN SITE.....	51-53
4. 6dB BANDWIDTH MEASUREMENT.....	54
4.1 TEST EQUIPMENTS.....	54
4.2 TEST SETUP.....	54
4.3 LIMITS OF 6dB BANDWIDTH MEASUREMENT.....	54
4.4 TEST PROCEDURE.....	54
4.5 UNCERTAINTY OF CONDUCTED EMISSION.....	55
4.6 TEST RESULTS.....	55
4.7 PHOTO OF 6DB BANDWIDTH MEASUREMENT.....	56
5. MAXIMUM PEAK OUTPUT POWER.....	57
5.1 TEST EQUIPMENTS.....	57
5.2 TEST SETUP.....	57
5.3 LIMITS OF MAXIMUM PEAK OUTPUT POWER.....	57
5.4 TEST PROCEDURE.....	58
5.5 UNCERTAINTY OF CONDUCTED EMISSION.....	58
5.6 TEST RESULTS.....	58
6. POWER SPECTRAL DENSITY MEASUREMENT.....	59
6.1 TEST EQUIPMENTS.....	59
6.2 TEST SETUP.....	59
6.3 LIMITS OF POWER SPECTRAL DENSITY MEASUREMENT.....	59
6.4 TEST PROCEDURE.....	60
6.5 UNCERTAINTY OF CONDUCTED EMISSION.....	60
6.6 TEST RESULTS.....	60
6.7 PHOTO OF POWER SPECTRAL DENSITY MEASUREMENT.....	61



Ecom Sertech Corp.

Rm. 258, Bldg. 17, 195 Sec. 4 Chung Hsing Rd.,
Chu-Tung Chen, Taiwan 310, R.O.C
TEL:886-3-5918012 FAX : 886-3-5825720

FCC ID : QDWWM168B

Report No. : ER03-04-030

Page 3 of 68

TABLE OF CONTENTS

TITLE	PAGE NO.
7. OUT OF BAND MEASUREMENT	62
7.1 TEST EQUIPMENTS.....	62
7.2 TEST SETUP.....	62
7.3 LIMITS OF OUT OF BAND EMISSIONS MEASUREMENT	62
7.4 TEST PROCEDURE	63
7.5 UNCERTAINTY OF CONDUCTED EMISSION.....	63
7.6 TEST RESULTS.....	63
7.7 PHOTO OF OUT OF BAND MEASUREMENT	64
8. ANTENNA REQUIREMENT.....	65
8.1 STANDARD APPLICABLE.....	65
8.2 ANTENNA CONNECTED CONSTRUCTION	65
9. RF EXPOSURE EVALUATION	66
9.1 FRIIS FORMULA	66
9.2 EUT OPERATING CONDITION	66
9.3 TEST RESULT OF RF EXPOSURE EVALUATION	67
9.3.1 ANTENNA GAIN	67
9.3.2 OUTPUT POWER INTO ANTENNA & RF EXPOSURE EVALUATION DISTANCE.....	67-68



1. GENERAL INFORMATION

1.1 GENERAL STATEMENT

MEASUREMENT DEVIATION : Comply with standard in full

TRACEABILITY : This test result is traceable to national or international std.

1.2 GENERAL DESCRIPTION OF EUT & POWER

MANUFACTURER : AirVast Technology Inc.

SAMPLE NAME : 802.11b WLAN USB Module

MODEL NAME : WM168b

FREQUENCY RANGE : 2412 MHz TO 2462MHz

CHANNEL NUMBER : 11

AIR DATA RATE : 11Mbps (Highest Mode)

TYPE OF MODULATION : Direct Sequence Spread Spectrum

FREQUENCY SELECTION : BY SOFTWARE

EUT Description : 2.4GHz (Direct Sequence Spread Spectrum) Data Transceiver
for 802.11b WLAN USB Module

ANTENNA TYPE : PIFA ANTENNA

POWER SOURCE : 5VDC(From PC)

NOTE:The 802.11b WLAN USB Module have four antenna . A982 antenna . antenna gain is -3.289.A530 antenna . antenna gain is 2.45. G736 antenna . antenna gain is 2.626. G530 antenna . antenna gain is -0.995. The G736 Antenna is worse case than the A982 A530 G530. So some test items are only listed the G736 Antenna in test result.



Ecom Sertech Corp.

Rm. 258, Bldg. 17, 195 Sec. 4 Chung Hsing Rd.,
Chu-Tung Chen, Taiwan 310, R.O.C
TEL:886-3-5918012 FAX : 886-3-5825720

FCC ID : QDWWM168B

Report No. : ER03-04-030

Page 5 of 68

1.3 DESCRIPTION OF PERIPHERALS

(1) Notebook PC

MANUFACTURER : DELL CORP.
MODEL NUMBER : PP01L
SERIAL NUMBER : CN-09C748-48155-1AP-6081
F.C.C. : DOC
POWER CORD : Unshielded, Detachable, 1.8m

(2) PRINT

MANUFACTURER : Hp Corp.
MODEL NUMBER : C6431D
SERIAL NUMBER : CN19T6S011
F.C.C. ID : DOC
POWER SOURCE : 100-240VAC,50/60Hz,0.7A
SIGNAL CABLE : Shielded , Undetachable , 1.8m

(3) MODEM

MANUFACTURER : ZYXEL communication Corp.
MODEL NUMBER : Omni 56K
SERIAL NUMBER : S1Z4107729
F.C.C. ID : 1880MN156K
POWER SOURCE : 9VAC(From Power Adapter)
SIGNAL CABLE : Shielded , Undetachable , 1.8m

(4) Notebook PC

MANUFACTURER : DELL CORP.
MODEL NUMBER : PP01L
SERIAL NUMBER : CN-09C748-48155-1AP-6630
F.C.C. : DOC
POWER CORD : Unshielded, Detachable, 1.8m

1.4 EUT & PERIPHERALS SETUP DIAGRAM

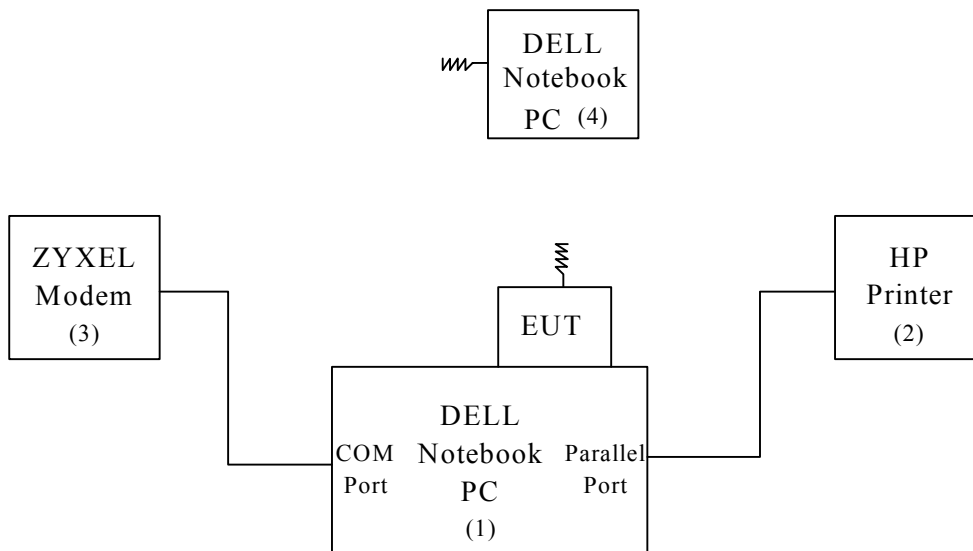

1.5 EUT OPERATING CONDITION

1. Set up all computers like the setup diagram.
2. Notebook (4) ping 192.168.1.90 -t to EUT
3. Notebook (1) contained EUT ping 192.168.1.80 -t to NB(4)
4. All of the function are under run.
5. Start test.



Ecom Sertech Corp.

Rm. 258, Bldg. 17, 195 Sec. 4 Chung Hsing Rd.,
Chu-Tung Chen, Taiwan 310, R.O.C
TEL:886-3-5918012 FAX : 886-3-5825720

FCC ID : QDWWM168B

Report No. : ER03-04-030

Page 7 of 68

1.6 DESCRIPTION OF TEST SITE

SITE DESCRIPTION : FCC certificate NO. : 31040/SIT
TUV certificate NO. : I9664582-9911
BSMI certificate NO. : SL2-IN-E-0002
NVLAP Lab code : 200118-0
CNLA certificate NO. : CNLA-ZL97018
VCCI certificate NO. : R-1189, C-1250

NAME OF SITE : Electronics Research & Service Organization
Industrial Technology Research Institute

SITE LOCATION : R1500, 195-4 , sec. 4, Chung Hsing Rd.,Chu-Tung Chen.
Hsin-Chu, Taiwan 310 R.O.C.

1.7 SUMMARY OF TEST RESULTS

The EUT has been tested according to the following specifications :

APPLIED STANDARD : 47 CFR Part 15, Subpart B and Subpart C			
Standard Section	Test Type and Limit	Result	REMARK
15.107 15.207	AC Power Conducted Emission Limit : 15.107	PASS	Meet the requirement of limit
15.247(a)(2)	Spectrum Bandwidth of a Direct Sequence Spread Spectrum System Limit : 6dB bandwidth > 500KHz	PASS	Meet the requirement of limit
15.247(b)	Maximum Peak Output Power Limit : max. 30dBm	PASS	Meet the requirement of limit
15.109 15.205 15.209	Transmitter Radiated Emissions Limit : Table 15.209	PASS	Meet the requirement of limit
15.247(d)	Power Spectral Density Limit : max. 8dBm	PASS	Meet the requirement of limit
15.247(c)	Out of Band Emission and Restricted Band Radiation Limit:20dB less than peak value of fundamental frequency Restricted band Limit:Table 15.209	PASS	Meet the requirement of limit



2. CONDUCTED POWERLINE TEST

2.1 TEST EQUIPMENTS

The following test equipments are used during the conducted powerline tests :

MANUFACTURER OR TYPE	MODEL No	SERIAL NO.	DATE OF CALIBRATION	CALIBRATION PERIOD	REMARK
SPECTRUM ANALYZER & DISPLAY	HP 8568A	2235A02320	APR. 01, 2002	1 Year	PRETEST
QUASI-PEAK ADAPTER	HP 85650 A	2341A00672	APR. 01, 2002	1 Year	PRETEST
ISOLATION TRANSFORMER	SOLAR 7032-1	N/A	N/A	N/A	FINAL
L.I.S.N.	EMCO 3850/2	9311-1025 9401-1028	JAN. 08, 2002 For Characteristic impedance MAY 18, 2002 For Insertion loss	1 Year	FINAL
TEST RECEIVER	R/S ESHS30	838550/003	JUN. 07, 2002	1 Year	FINAL
SHIELDED ROOM	KEENE 5983	NO.1	N/A	N/A	FINAL
PULSE LIMIT	R/S EHS3Z2	357.8810.52	JUL. 10, 2002	1 Year	FINAL
N TYPE COAXIAL CABLE	-----	-----	JUL. 10, 2002	1 Year	FINAL
50Ω TERMINATOR	-----	-----	JUL. 10, 2002	1 Year	FINAL

2.2 TEST SETUP

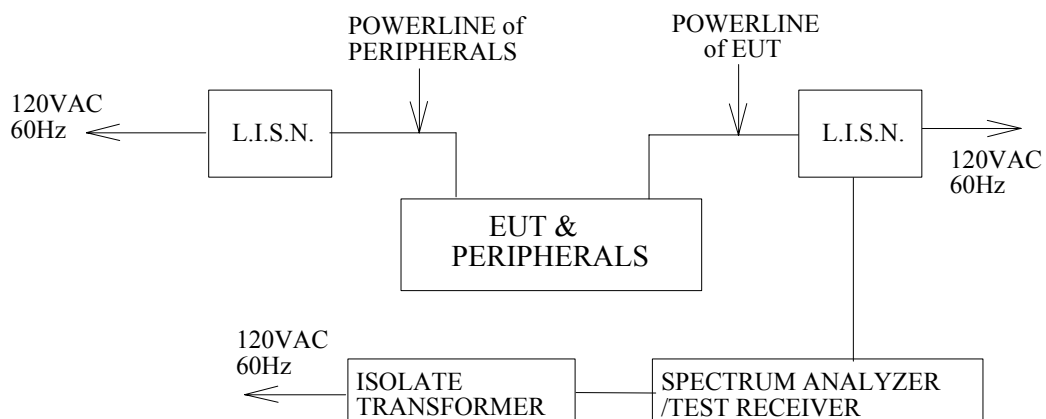



2.3 CONDUCTED POWER LINE EMISSION LIMIT

For unintentional device, according to § 15.107(a) Line Conducted Emission Limits is as following :

FREQUENCY (MHz)	MAXIMUM RF LINE VOLTAGE (dB μ V)			
	CLASS A		CLASS B	
	Q.P.	Ave.	Q.P.	Ave.
0.15 - 0.50	79	66	66-56	56-46
0.50 - 5.00	73	60	56	46
5.00 - 30.0	73	60	60	50

For intentional device, according to § 15.207(a) Line Conducted Emission Limit is same as above table.

2.4 TEST PROCEDURE

The test procedure is performed in a 12ft×12ft×8ft(L×W×H) shielded room. the EUT along with its peripherals were placed on a 1.0m(W)× 1.5m(L) and 0.8m in height wooden table and the EUT was adjusted to maintain a 0.4 meter space from a vertical reference plane. The EUT was connected to power mains through a line impedance stabilization network (LISN) which provides 50 ohm coupling impedance for measuring instrument and the chasis ground was bounded to the horizontal ground plane of shielded room. All peripherals were connected to the second LISN and the chasis ground also bounded to the horizontal ground plane of shielded room. The excess power cable between the EUT and the LISN was bundled. The power cables of peripherals were unbundled. All connecting cables of EUT and peripherals were moved to find the maximum emission.

2.5 UNCERTAINTY OF CONDUCTED EMISSION

The uncertainty of conducted emission is ± 1.36 dB.



2.6 CONDUCTED RF VOLTAGE MEASUREMENT

The frequency spectrum from 0.15 MHz to 30 MHz was investigated. All emissions not reported below are more than 20 dB below the prescribed limits.

Temperature : 26 °C

Humidity : 65 % RH

FREQUENCY (MHz)	READING(dB μ V)				LIMITS	
	ONE END & GRD'D		THE OTHER END & GRD'D		(dB μ V)	
	Q.P.	Ave.	Q.P.	Ave.	Q.P.	Ave.
0.150	*	*	*	*	66.00	56.00
0.168	37.8	*	*	*	65.10	55.10
0.174	*	*	45.8	*	64.70	54.70
0.291	*	*	33.4	*	60.50	50.50
0.525	23.9	*	*	*	56.00	46.00
1.047	15.2	*	17.1	*	56.00	46.00
1.281	14.8	*	*	*	56.00	46.00
1.458	*	*	17.8	*	56.00	46.00
3.735	*	*	28.0	*	56.00	46.00
3.738	32.2	*	*	*	56.00	46.00
4.140	*	*	21.1	*	56.00	46.00
4.260	25.2	*	*	*	56.00	46.00
15.258	33.2	*	30.7	*	60.00	50.00
24.000	41.3	38.6	40.8	*	60.00	50.00
30.000	*	*	*	*	60.00	50.00

REMARKS : 1. * Undetectable or the Q.P. value is lower than the limits of Ave.
2.For G736 Antenna, Antenna Gain is 2.626dBi.

2.7 PHOTOS OF CONDUCTION TEST



3. RADIATED EMISSION TEST

3.1 TEST EQUIPMENTS

The following test equipments are utilized in making the measurements contained in this report.

MANUFACTURER OR TYPE	MODEL NO	SERIAL NO	DATE OF CALIBRATION	CALIBRATION PERIOD	REMARK
CHASE BI-LOG ANTENNA	CBL6112B	2421	MAY 07, 2002	1 Year	FINAL
R/S TEST RECEIVER	ESMI	842088/005 841978/008	SEPT. 3, 2002	1 Year	FINAL
OPEN SITE	-----	No.1	JUL. 10~12, 2002	1 Year	FINAL
N TYPE COAXIAL CABLE	CHA9525	4	JUL. 13, 2002	1 Year	FINAL
Horn Antenna	AH-118	10089	FEB. 25, 2003	1 Year	FINAL
HP Pre-amplifier	8449B	3008A01471	OCT. 11, 2002	1 Year	FINAL
HP High pass filter	84300/80038	011	cal. on use	1 Year	FINAL
Horn Antenna	AH-840	03077	FEB. 25, 2003	1 Year	FINAL

3.2 TEST SETUP

The diagram below shows the test setup which is utilized to make these measurements.

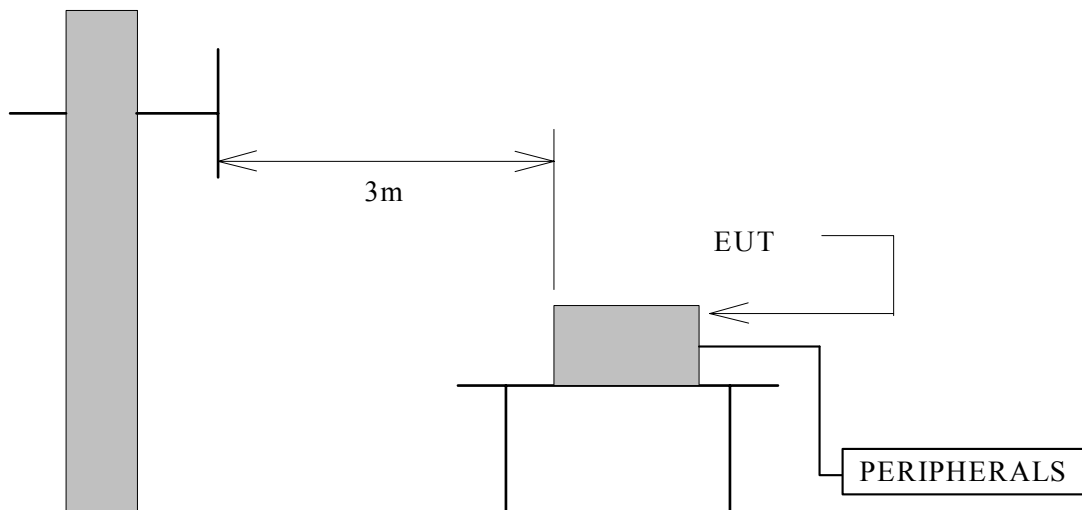

Antenna Elevation Variable



3.3 RADIATION LIMIT

For unintentional device, according to § 15.109(a), except for Class A digital devices, the field strength of radiated emissions from unintentional radiators at a distance of 3 meters shall not exceed the following values :

FREQUENCY (MHz)	DISTANCE (METERS)	Radiated (dB μ V/M)	Radiated (μ V/M)
30-88	3	40.0	100
88-216	3	43.5	150
216-960	3	46.0	200
Above 960	3	54.0	500

For intentional device, according to § 15.209(a), the general requirement of field strength of radiated emissions from intentional radiators at a distance of 3 meters shall not exceed the above table.



3.4 TEST PROCEDURES

- a. The EUT was placed on the top of a rotating table 0.8 meters above the ground at a 10 meter open area test site. The table was rotated 360 degrees to determine the position of the highest radiation.
- b. The EUT was set 3 meters away from the interference-receiving antenna, which was mounted on the top of a variable-height antenna tower.
- c. The antenna is a broadband antenna, and its height is varied from one meter to four meters above the ground to determine the maximum value of the field strength. Both horizontal and vertical polarization of the antenna are set to make the measurement.
- d. For each suspected emission, the EUT was arranged to its worst case and then the antenna was tuned to heights from 1 meter to 4 meters and the rotatable table was turned from 0 degrees to 360 degrees to find the maximum reading.
- e. The test-receiver system was set to Peak Detect Function and Specified Bandwidth with Maximum Hold Mode.
- f. If the emission level of the EUT in peak mode was 10 dB lower than the limit specified, then testing could be stopped and the peak values of the EUT would be reported. Otherwise the emissions that did not have 10 dB margin would be re-tested one by one using peak, quasi-peak or average method as specified and then reported in a data sheet.

NOTE :

1. The resolution bandwidth and video bandwidth of test receiver/spectrum analyzer is 120 KHz for Peak detection (PK) and Quasi-peak detection (QP) at frequency below 1GHz.
2. The resolution bandwidth and video bandwidth of test receiver/spectrum analyzer is 1 MHz for Peak detection and frequency above 1GHz.
3. The resolution bandwidth of test receiver/spectrum analyzer is 1 MHz and the video bandwidth is 10 Hz for Average detection (AV) at frequency above 1GHz.

3.5 UNCERTAINTY OF RADIATED EMISSION

The uncertainty of radiated emission is ± 2.72 dB.



3.6 RADIATED RF NOISE MEASUREMENT

Test Requirement: 15.109, 15.209

The frequency spectrum from 30 MHz to 1000 MHz was investigated. All emissions not reported below are more than 20 dB below the prescribed limits.

All readings are quasi-peak values.

Temperature : 25 °C

Humidity : 65 % RH

FREQ- UENCY (MHz)	ANTENNA FACTOR (dB)	CABLE LOSS (dB)	METER READING AT3m(dB μ V/M)		LIMITS (dB μ V/M)	EMISSION LEVEL AT3m(dB μ V/M)	
			HORIZON- TAL	VERTICAL		HORIZON- TAL	VERTICAL
30.00	21.39	0.90	*	*	40.00	*	*
38.69	16.26	1.07	17.21	13.54	40.00	34.55	30.88
47.98	10.80	1.20	16.28	26.68	40.00	28.28	38.68
60.00	5.97	1.40	21.35	20.87	40.00	28.72	28.24
83.21	9.84	1.66	20.19	22.62	40.00	31.69	34.12
119.97	13.31	2.00	21.48	13.42	43.50	36.79	28.73
131.97	13.23	2.15	16.82	8.92	43.50	32.20	24.30
155.98	11.59	2.42	19.98	11.25	43.50	33.99	25.26
167.97	10.87	2.55	18.67	14.20	43.50	32.10	27.63
265.15	13.21	3.32	8.73	5.92	46.00	25.27	22.46
307.15	13.77	3.64	18.58	17.83	46.00	35.99	35.24
1000.00	21.58	7.00	*	*	54.00	*	*

REMARKS : 1. * Undetectable

2. Emission level (dB μ V/M) = Antenna Factor (dB/m) + Cable loss (dB)
+ Meter Reading (dB μ V).

3. According to technical experiences, all spurious emission at channel 1,6,11 are almost the same below 1GHz,so that the channel 1 was chosen as representation for the test.

4.for A982 Antenna ,Antenna Gain is -3.289dBi.



Ecom Sertech Corp.

Rm. 258, Bldg. 17, 195 Sec. 4 Chung Hsing Rd.,
Chu-Tung Chen, Taiwan 310, R.O.C
TEL:886-3-5918012 FAX : 886-3-5825720

FCC ID : QDWWM168B

Report No. : ER03-04-030

Page 16 of 68

Test Requirement: 15.109, 15.209

The frequency spectrum from 30 MHz to 1000 MHz was investigated. All emissions not reported below are more than 20 dB below the prescribed limits.

All readings are quasi-peak values.

Temperature : 25 °C

Humidity : 65 % RH

FREQ- UENCY (MHz)	ANTENNA FACTOR (dB)	CABLE LOSS (dB)	METER READING AT3m(dB μ V/M)		LIMITS (dB μ V/M)	EMISSION LEVEL AT3m(dB μ V/M)	
			HORIZON- TAL	VERTICAL		HORIZON- TAL	VERTICAL
30.00	21.39	0.90	*	*	40.00	*	*
38.69	16.26	1.07	19.22	12.89	40.00	36.56	30.23
60.00	5.97	1.40	19.98	18.54	40.00	27.35	25.91
83.21	9.84	1.66	21.98	20.81	40.00	33.48	32.31
119.97	13.31	2.00	17.39	15.69	43.50	32.70	31.00
131.97	13.23	2.15	18.42	11.02	43.50	33.80	26.40
155.98	11.59	2.42	21.28	13.49	43.50	35.29	27.50
167.97	10.87	2.55	20.67	16.84	43.50	34.10	30.27
265.15	13.21	3.32	11.07	6.98	46.00	27.61	23.52
307.15	13.77	3.64	17.11	15.81	46.00	34.52	33.22
1000.00	21.58	7.00	*	*	54.00	*	*

REMARKS : 1. * Undetectable

2. Emission level (dB μ V/M) = Antenna Factor (dB/m) + Cable loss (dB)
+ Meter Reading (dB μ V).

3. According to technical experiences, all spurious emission at channel 1,6,11 are almost the same below 1GHz, so that the channel 1 was chosen as representation for the test.

4. for A530 Antenna, Antenna Gain is 2.45dBi.



Ecom Sertech Corp.

Rm. 258, Bldg. 17, 195 Sec. 4 Chung Hsing Rd.,
Chu-Tung Chen, Taiwan 310, R.O.C
TEL:886-3-5918012 FAX : 886-3-5825720

FCC ID : QDWWM168B

Report No. : ER03-04-030

Page 17 of 68

Test Requirement: 15.109, 15.209

The frequency spectrum from 30 MHz to 1000 MHz was investigated. All emissions not reported below are more than 20 dB below the prescribed limits.

All readings are quasi-peak values.

Temperature : 25 °C

Humidity : 65 % RH

FREQ- UENCY (MHz)	ANTENNA FACTOR (dB)	CABLE LOSS (dB)	METER READING AT3m(dB μ V/M)		LIMITS (dB μ V/M)	EMISSION LEVEL AT3m(dB μ V/M)	
			HORIZON- TAL	VERTICAL		HORIZON- TAL	VERTICAL
30.00	21.39	0.90	*	*	40.00	*	*
38.69	16.26	1.07	20.13	14.25	40.00	37.47	31.59
60.00	5.97	1.40	20.03	17.95	40.00	27.40	25.32
83.21	9.84	1.66	22.98	18.46	40.00	34.48	29.96
119.97	13.31	2.00	20.36	17.24	43.50	35.67	32.55
131.97	13.23	2.15	20.56	13.58	43.50	35.94	28.96
155.98	11.59	2.42	22.88	15.62	43.50	36.89	29.63
167.97	10.87	2.55	21.89	18.42	43.50	35.32	31.85
265.15	13.21	3.32	14.02	8.22	46.00	30.56	24.76
307.15	13.77	3.64	18.39	17.24	46.00	35.80	34.65
1000.00	21.58	7.00	*	*	54.00	*	*

REMARKS : 1. * Undetectable

2. Emission level (dB μ V/M) = Antenna Factor (dB/m) + Cable loss (dB)
+ Meter Reading (dB μ V).

3. According to technical experiences, all spurious emission at channel 1,6,11 are almost the same below 1GHz,so that the channel 1 was chosen as representation for the test.

4. for G736 Antenna, Antenna Gain is 2.626dBi.



Ecom Sertech Corp.

Rm. 258, Bldg. 17, 195 Sec. 4 Chung Hsing Rd.,
Chu-Tung Chen, Taiwan 310, R.O.C
TEL:886-3-5918012 FAX : 886-3-5825720

FCC ID : QDWWM168B

Report No. : ER03-04-030

Page 18 of 68

Test Requirement: 15.109, 15.209

The frequency spectrum from 30 MHz to 1000 MHz was investigated. All emissions not reported below are more than 20 dB below the prescribed limits.

All readings are quasi-peak values.

Temperature : 25 °C

Humidity : 65 % RH

FREQ- UENCY (MHz)	ANTENNA FACTOR (dB)	CABLE LOSS (dB)	METER READING AT3m(dB μ V/M)		LIMITS (dB μ V/M)	EMISSION LEVEL AT3m(dB μ V/M)	
			HORIZON- TAL	VERTICAL		HORIZON- TAL	VERTICAL
30.00	21.39	0.90	*	*	40.00	*	*
38.69	16.26	1.07	16.00	14.78	40.00	33.34	32.12
60.00	5.97	1.40	22.04	21.56	40.00	29.41	28.93
83.21	9.84	1.66	21.54	19.45	40.00	33.04	30.95
119.97	13.31	2.00	19.86	15.63	43.50	35.17	30.94
131.97	13.23	2.15	17.88	10.02	43.50	33.26	25.40
155.98	11.59	2.42	20.47	12.69	43.50	34.48	26.70
167.97	10.87	2.55	18.02	14.53	43.50	31.45	27.96
265.15	13.21	3.32	9.21	6.44	46.00	25.75	22.98
307.15	13.77	3.64	19.54	18.25	46.00	36.95	35.66
1000.00	21.58	7.00	*	*	54.00	*	*

REMARKS : 1. * Undetectable

2. Emission level (dB μ V/M) = Antenna Factor (dB/m) + Cable loss (dB)
+ Meter Reading (dB μ V).

3. According to technical experiences, all spurious emission at channel 1,6,11 are almost the same below 1GHz,so that the channel 1 was chosen as representation for the test.

4. for G530 Antenna, Antenna Gain is -0.995dBi



Ecom Sertech Corp.

Rm. 258, Bldg. 17, 195 Sec. 4 Chung Hsing Rd.,
Chu-Tung Chen, Taiwan 310, R.O.C
TEL:886-3-5918012 FAX : 886-3-5825720

FCC ID : QDWWM168B

Report No. : ER03-04-030

Page 19 of 68

Test Requirement: 15.109 ,15.209

The frequency spectrum above 1 GHz was investigated. All emissions not reported below are more than 40 dB below the prescribed limits. Readings are both peak and average values.

Company	AirVast	Test Date :	2003/3/27
Product Name	802.11b WLAN USB Module	Test By:	M.C. Huang
Model Name	WM168b	TEMP&Humidity :	27C,65%

CH1-RX MODE

Freq.	Reading	AF	Closs	Pre-amp	Dist	Filter	Level	Limit	Margin	Mark	Pol.	Height
MHz	dBuV	dBuV	dB	dB	dB	dB	dBuV/m	dBuV/m	dB	P/Q/A	H/V	Meter
4824	47.03	34.4	2.77	35.38	9.5	0	39.36	74	-34.64	P	H	1.0
7236	41.02	39.8	3.94	35.56	9.5	0	39.71	74	-34.29	P	H	1.0
9648	47.92	38.5	4.10	35.67	9.5	0	45.38	74	-28.62	P	H	1.0
4824	49.37	34.4	2.77	35.38	9.5	0	41.70	74	-32.30	P	V	1.0
7236	42.51	39.8	3.94	35.56	9.5	0	41.20	74	-32.80	P	V	1.0
9648	49.99	38.5	4.10	35.67	9.5	0	47.45	74	-26.55	P	V	1.0

CH6-RX MODE

Freq.	Reading	AF	Closs	Pre-amp	Dist	Filter	Level	Limit	Margin	Mark	Pol.	Height
MHz	dBuV	dBuV	dB	dB	dB	dB	dBuV/m	dBuV/m	dB	P/Q/A	H/V	Meter
4874	49.67	34.8	2.80	35.40	9.5	0	42.34	74	-31.66	P	H	1.0
7309	41.26	39.8	4.00	35.57	9.5	0	39.97	74	-34.03	P	H	1.0
9748	48.48	38.5	4.02	35.72	9.5	0	45.80	74	-28.20	P	H	1.0
4874	51.42	34.8	2.80	35.40	9.5	0	44.09	74	-29.91	P	V	1.0
7309	42.16	39.8	4.00	35.57	9.5	0	40.87	74	-33.13	P	V	1.0
9748	49.86	38.5	4.02	35.72	9.5	0	47.18	74	-26.82	P	V	1.0

Note :

1. Measurement was up to 18GHz harmonic,“---” means that the emissions level is too low to be measured.
2. AF: Antenna Factor, Closs: Cable Loss,
3. Analyzer setting P(Peak): RBW=1MHz, VBW=1MHz, A(Average): RBW=1MHz,VBW=10Hz
4. The other emission levels were very low against the limit
- 5.for A982 ANTENNA



Ecom Sertech Corp.

Rm. 258, Bldg. 17, 195 Sec. 4 Chung Hsing Rd.,
 Chu-Tung Chen, Taiwan 310, R.O.C
 TEL:886-3-5918012 FAX : 886-3-5825720

FCC ID : QDWWM168B

Report No. : ER03-04-030

Page 20 of 68

Test Requirement: 15.109 ,15.209

The frequency spectrum above 1 GHz was investigated. All emissions not reported below are more than 40 dB below the prescribed limits. Readings are both peak and average values.

Company				AirVast				Test Date :		2003/3/27		
Product Name				802.11b WLAN USB Module				Test By:		M.C. Huang		
Model Name				WM168b				TEMP&Humidity :		27C,65%		
CH11-RX-MODE												
Freq.	Reading	AF	Closs	Pre-amp	Dist	Filter	Level	Limit	Margin	Mark	Pol.	Height
MHz	dBuV	dBuV	dB	dB	dB	dB	dBuV/m	dBuV/m	dB	P/Q/A	H/V	Meter
4924	53.20	35.1	2.83	35.41	9.5	0	46.22	74	-27.78	P	H	1.0
7386	41.54	39.7	4.06	35.57	9.5	0	40.27	74	-33.73	P	H	1.0
9848	49.34	38.5	3.93	35.77	9.5	0	46.52	74	-27.48	P	H	1.0
4924	53.85	35.1	2.83	35.41	9.5	0	46.87	74	-27.13	P	V	1.0
7386	42.84	39.7	4.06	35.57	9.5	0	41.57	74	-32.43	P	V	1.0
9848	50.31	38.5	3.93	35.77	9.5	0	47.49	74	-26.51	P	V	1.0

Note :

1. Measurement was up to 18GHz harmonic,“---” means that the emissions level is too low to be measured.
2. AF: Antenna Factor, Closs: Cable Loss,
3. Analyzer setting P(Peak): RBW=1MHz, VBW=1MHz, A(Average): RBW=1MHz,VBW=10Hz
4. The other emission levels were very low against the limit
- 5.for A982 ANTENNA



Ecom Sertech Corp.

Rm. 258, Bldg. 17, 195 Sec. 4 Chung Hsing Rd.,
Chu-Tung Chen, Taiwan 310, R.O.C
TEL:886-3-5918012 FAX : 886-3-5825720

FCC ID : QDWWM168B

Report No. : ER03-04-030

Page 21 of 68

Test Requirement: 15.205

The frequency spectrum above 1 GHz was investigated. All emissions not reported below are more than 40 dB below the prescribed limits. Readings are both peak and average values.

Operation Mode:	Transmitting	Test Date :	2003/3/27
Fundamental Frequency:	2412MHz (CH 1)	Test By:	M.C. Huang
Temperature :	30 °C	Humidity :	65%

Freq.	Reading	AF	Closs	Pre-amp	Dist	Filter	Level	Limit	Margin	Mark	Pol.	Height
MHz	dBuV	dBuV	dB	dB	dB	dB	dBuV/m	dBuV/m	(dB)	(P/Q/A)	(H/V)	(Meter)
2390.25	47.62	31.81	2.30	35.31	9.5	0	36.92	74	-37.08	P	H	1.0
2390.25	41.09	31.81	2.30	35.31	9.5	0	30.39	54	-23.61	A	H	1.0
2412**	99.07	31.79	2.36	35.31	9.5	0	88.40			P	H	1.0
2412**	91.06	31.79	2.36	35.31	9.5	0	80.39			A	H	1.0
4824.63	43.76	34.44	2.77	35.38	9.5	1	37.09	74	-36.91	P	H	1.0
7236.18	44.59	39.81	3.94	35.56	9.5	1	44.28	74	-29.72	P	H	1.0
9648.71	45.32	38.54	4.10	35.67	9.5	1	43.78	74	-30.22	P	H	1.0
12059.93*	---	42.60	15.20	35.30	9.5	1	---	---	---	---	H	1.0
14471.97*	---	43.40	16.80	34.00	9.5	1	---	---	---	---	H	1.0
16884.01	---	45.20	17.60	34.30	9.5	1	---	---	---	---	H	1.0
19296.05*	---	36.30	18.50	34.30	9.5	1	---	---	---	---	H	1.0
21708.09	---	36.20	19.20	34.60	9.5	1	---	---	---	---	H	1.0
24120.13	---	36.80	21.00	34.20	9.5	1	---	---	---	---	H	1.0

Note :

1. The measurement was searched to 10th harmonic, Remark “---” means that the emissions level is too low to be measured.
2. AF: Antenna Factor, Closs: Cable Loss, Pre-Amp: Preamp gain, Filter: High Pass Filter Insertion Loss (3.5GHz)
3. Analyzer setting P(Peak): RBW=1MHz, VBW=1MHz, A(Average): RBW=1MHz, VBW=10Hz
4. Remark “**” means that Restricted band.
5. The result basic equation calculation is as follow:
Level=Reading+AF+Closs-Preamp+Filter-Dist, Margin=Level-Limit
6. The other emission levels were very low against the limit
7. “ * * “ : Fundamental frequency
8. for A982 ANTENNA



Ecom Sertech Corp.

Rm. 258, Bldg. 17, 195 Sec. 4 Chung Hsing Rd.,
Chu-Tung Chen, Taiwan 310, R.O.C
TEL:886-3-5918012 FAX : 886-3-5825720

FCC ID : QDWWM168B

Report No. : ER03-04-030

Page 22 of 68

Test Requirement: 15.205

The frequency spectrum above 1 GHz was investigated. All emissions not reported below are more than 40 dB below the prescribed limits. Readings are both peak and average values.

Operation Mode:	Transmitting	Test Date :	2003/3/27
Fundamental Frequency:	2412MHz (CH 1)	Test By:	M.C. Huang
Temperature :	30 °C	Humidity :	65%

Freq.	Reading	AF	Closs	Pre-amp	Dist	Filter	Level	Limit	Margin	Mark	Pol.	Height
MHz	dBuV	dBuV	dB	dB	dB	dB	dBuV/m	dBuV/m	dB	P/Q/A	H/V	Meter
2390.25	48.06	31.81	2.30	35.31	9.5	0	37.36	74	-36.64	P	V	1.0
2390.25	43.26	31.81	2.30	35.31	9.5	0	32.56	54	-21.44	A	V	1.0
2412**	100.08	31.79	2.36	35.31	9.5	0	89.41			P	V	1.0
2412**	91.06	31.79	2.36	35.31	9.5	0	80.39			A	V	1.0
4824.63	51.73	34.44	2.77	35.38	9.5	1	45.06	74	-28.94	P	V	1.0
7236.18	55.66	39.81	3.94	35.56	9.5	1	55.35	74	-18.65	P	V	1.0
7236.18	55.66	39.81	3.94	35.56	9.5	1	50.12	54	-3.88	A	V	2.0
9648.71	47.79	38.54	4.10	35.67	9.5	1	46.25	74	-27.75	P	V	1.0
12059.93*	---	42.60	15.20	35.30	9.5	1	---	---	---	---	V	1.0
14471.97*	---	43.40	16.80	34.00	9.5	1	---	---	---	---	V	1.0
16884.01	---	45.20	17.60	34.30	9.5	1	---	---	---	---	V	1.0
19296.05*	---	36.30	18.50	34.30	9.5	1	---	---	---	---	V	1.0
21708.09	---	36.20	19.20	34.60	9.5	1	---	---	---	---	V	1.0
24120.13	---	36.80	21.00	34.20	9.5	1	---	---	---	---	V	1.0

Note :

1. The measurement was searched to 10th harmonic, Remark “---” means that the emissions level is too low to be measured.
2. AF: Antenna Factor, Closs: Cable Loss, Pre-Amp: Preamp gain, Filter: High Pass Filter Insertion Loss (3.5GHz)
3. Analyzer setting P(Peak): RBW=1MHz, VBW=1MHz, A(Average): RBW=1MHz, VBW=10Hz
4. Remark “**” means that Restricted band.
5. The result basic equation calculation is as follow:
Level=Reading+AF+Closs-Preamp+Filter-Dist, Margin=Level-Limit
6. The other emission levels were very low against the limit
7. “* * *”: Fundamental frequency



Ecom Sertech Corp.

Rm. 258, Bldg. 17, 195 Sec. 4 Chung Hsing Rd.,
Chu-Tung Chen, Taiwan 310, R.O.C
TEL:886-3-5918012 FAX : 886-3-5825720

FCC ID : QDWWM168B

Report No. : ER03-04-030

Page 23 of 68

Test Requirement: 15.205

The frequency spectrum above 1 GHz was investigated. All emissions not reported below are more than 40 dB below the prescribed limits. Readings are both peak and average values.

Operation Mode:	Transmitting	Test Date :	2003/3/27
Fundamental Frequency:	2437MHz (CH 6)	Test By:	M.C. Huang
Temperature :	30 °C	Humidity :	65%

Freq.	Reading	AF	Closs	Pre-amp	Dist	Filter	Level	Limit	Margin	Mark	Pol.	Height
MHz	dBuV	dBuV	dB	dB	dB	dB	dBuV/m	dBuV/m	dB	P/Q/A	H/V	Meter
2437**	97.42	31.76	2.42	35.32	9.5	0	86.79			P	H	1.0
2437**	92.06	31.76	2.42	35.32	9.5	0	81.43			A	H	1.0
4874.24	49.75	34.77	2.80	35.40	9.5	1	43.42	74	-30.58	P	H	1.0
7309.51	51.42	39.78	4.00	35.57	9.5	1	51.13	74	-22.87	P	H	1.0
7309.51	51.21	39.78	4.00	35.57	9.5	1	46.12	54	-7.88	A	H	1.0
9748.73	48.81	38.53	4.02	35.72	9.5	1	47.13	74	-26.87	P	H	1.0
12185.10*	---	32.14	4.53	35.24	9.5	1	---	---	---	---	H	1.0
14622.12	---	43.40	16.80	34.00	9.5	1	---	---	---	---	H	1.0
17059.14	---	45.20	17.60	34.30	9.5	1	---	---	---	---	H	1.0
19496.16*	---	36.30	18.50	34.30	9.5	1	---	---	---	---	H	1.0
21933.18	---	36.20	19.20	34.60	9.5	1	---	---	---	---	H	1.0
24370.20	---	36.80	21.00	34.20	9.5	1	---	---	---	---	H	1.0

Note :

1. The measurement was searched to 10th harmonic, Remark "---" means that the emissions level is too low to be measured.
2. AF: Antenna Factor, Closs: Cable Loss, Pre-Amp: Preamp gain, Filter: High Pass Filter Insertion Loss (3.5GHz)
3. Analyzer setting P(Peak): RBW=1MHz, VBW=1MHz, A(Average): RBW=1MHz, VBW=10Hz
4. Remark "*" means that Restricted band.
5. The result basic equation calculation is as follow:
Level=Reading+AF+Closs-Preamp+Filter-Dist, Margin=Level-Limit
6. The other emission levels were very low against the limit
7. " * * * " : Fundamental frequency
8. FOR A982 ANTENNA



Ecom Sertech Corp.

Rm. 258, Bldg. 17, 195 Sec. 4 Chung Hsing Rd.,
Chu-Tung Chen, Taiwan 310, R.O.C
TEL:886-3-5918012 FAX : 886-3-5825720

FCC ID : QDWWM168B

Report No. : ER03-04-030

Page 24 of 68

Test Requirement: 15.205

The frequency spectrum above 1 GHz was investigated. All emissions not reported below are more than 40 dB below the prescribed limits. Readings are both peak and average values.

Operation Mode:	Transmitting	Test Date :	2003/3/27
Fundamental Frequency:	2437MHz (CH 6)	Test By:	M.C. Huang
Temperature :	30 °C	Humidity :	65%

Freq.	Reading	AF	Closs	Pre-amp	Dist	Filter	Level	Limit	Margin	Mark	Pol.	Height
MHz	dBuV	dBuV	dB	dB	dB	dB	dBuV/m	dBuV/m	dB	P/Q/A	H/V	Meter
2437**	99.58	31.76	2.42	35.32	9.5	0	88.95			P	V	1.0
2437**	93.18	31.76	2.42	35.32	9.5	0	82.55			A	V	1.0
4874.24	48.69	34.77	2.80	35.40	9.5	1	42.36	74	-31.64	P	V	1.0
7309.51	51.02	39.78	4.00	35.57	9.5	1	50.73	74	-23.27	P	V	1.0
7309.51	51.02	39.78	4.00	35.57	9.5	1	46.12	54	-7.88	A	V	1.0
9748.73	49.32	38.53	4.02	35.72	9.5	1	47.64	74	-26.36	P	V	1.0
12185.10*	---	32.14	4.53	35.24	9.5	1	---	---	---	---	V	1.0
14622.12	---	43.40	16.80	34.00	9.5	1	---	---	---	---	V	1.0
17059.14	---	45.20	17.60	34.30	9.5	1	---	---	---	---	V	1.0
19496.16*	---	36.30	18.50	34.30	9.5	1	---	---	---	---	V	1.0
21933.18	---	36.20	19.20	34.60	9.5	1	---	---	---	---	V	1.0
24370.20	---	36.80	21.00	34.20	9.5	1	---	---	---	---	V	1.0

Note :

- The measurement was searched to 10th harmonic, Remark “---” means that the emissions level is too low to be measured.
- AF: Antenna Factor, Closs: Cable Loss, Pre-Amp: Preamp gain, Filter: High Pass Filter Insertion Loss (3.5GHz)
- Analyzer setting P(Peak): RBW=1MHz, VBW=1MHz, A(Average): RBW=1MHz, VBW=10Hz
- Remark “*” means that Restricted band.
- The result basic equation calculation is as follow:
Level=Reading+AF+Closs-Preamp+Filter-Dist, Margin=Level-Limit
- The other emission levels were very low against the limit
- “ * * ” : Fundamental frequency
- FOR A982 ANTENNA



Ecom Sertech Corp.

Rm. 258, Bldg. 17, 195 Sec. 4 Chung Hsing Rd.,
Chu-Tung Chen, Taiwan 310, R.O.C
TEL:886-3-5918012 FAX : 886-3-5825720

FCC ID : QDWWM168B

Report No. : ER03-04-030

Page 25 of 68

Test Requirement: 15.205

The frequency spectrum above 1 GHz was investigated. All emissions not reported below are more than 40 dB below the prescribed limits. Readings are both peak and average values.

Operation Mode:	Transmitting	Test Date :	2003/3/27
Fundamental Frequency:	2462MHz (CH 11)	Test By:	M.C. Huang
Temperature :	30 °C	Humidity :	65%

Freq.	Reading	AF	Closs	Pre-amp	Dist	Filter	Level	Limit	Margin	Mark	Pol.	Height
MHz	dBuV	dBuV	dB	dB	dB	dB	dBuV/m	dBuV/m	dB	P/Q/A	H/V	Meter
2462**	96.00	31.74	2.49	35.32	9.5	0	85.41			P	H	1.0
2462**	91.13	31.74	2.49	35.32	9.5	0	80.54			A	H	1.0
2483.70	50.16	31.72	2.55	35.33	9.5	0	39.60	74	-34.40	P	H	1.0
2483.70	45.41	31.72	2.55	35.33	9.5	0	34.85	54	-19.15	A	H	1.0
4924.16	49.86	35.10	2.83	35.41	9.5	1	43.88	74	-30.12	P	H	1.0
7386.42	51.73	39.75	4.06	35.57	9.5	1	51.46	74	-22.54	P	H	1.0
7386.42	51.73	39.75	4.06	35.57	9.5	1	47.25	54	-6.75	A	H	1.0
9848.64	47.63	38.52	3.93	35.77	9.5	1	45.81	74	-28.19	P	H	1.0
12310.04*	---	32.14	4.53	35.24	9.5	1	---	---	---	---	H	1.0
14772.06	---	43.40	16.80	34.00	9.5	1	---	---	---	---	H	1.0
17234.08	---	45.20	17.60	34.30	9.5	1	---	---	---	---	H	1.0
19696.1*	---	36.30	18.50	34.30	9.5	1	---	---	---	---	H	1.0
22158.12*	---	36.20	19.20	34.60	9.5	1	---	---	---	---	H	1.0
24620.14	---	36.80	21.00	34.20	9.5	1	---	---	---	---	H	1.0

Note :

1. The measurement was searched to 10th harmonic, Remark “---” means that the emissions level is too low to be measured.
2. AF: Antenna Factor, Closs: Cable Loss, Pre-Amp: Preamp gain, Filter: High Pass Filter Insertion Loss (3.5GHz)
3. Analyzer setting P(Peak): RBW=1MHz, VBW=1MHz, A(Average): RBW=1MHz, VBW=10Hz
4. Remark “**” means that Restricted band.
5. The result basic equation calculation is as follow:
Level=Reading+AF+Closs-Preamp+Filter-Dist, Margin=Level-Limit
6. The other emission levels were very low against the limit
7. “* * *”: Fundamental frequency
8. FOR A982 ANTENNA



Ecom Sertech Corp.

Rm. 258, Bldg. 17, 195 Sec. 4 Chung Hsing Rd.,
Chu-Tung Chen, Taiwan 310, R.O.C
TEL:886-3-5918012 FAX : 886-3-5825720

FCC ID : QDWWM168B

Report No. : ER03-04-030

Page 26 of 68

Test Requirement: 15.205

The frequency spectrum above 1 GHz was investigated. All emissions not reported below are more than 40 dB below the prescribed limits. Readings are both peak and average values.

Operation Mode:	Transmitting	Test Date :	2003/3/27
Fundamental Frequency:	2462MHz (CH 11)	Test By:	M.C. Huang
Temperature :	30 °C	Humidity :	65%

Freq.	Reading	AF	Closs	Pre-amp	Dist	Filter	Level	Limit	Margin	Mark	Pol.	Height
MHz	dBuV	dBuV	dB	dB	dB	dB	dBuV/m	dBuV/m	dB	P/Q/A	H/V	Meter
2462**	99.36	31.74	2.49	35.32	9.5	0	88.77			P	V	1.0
2462**	93.41	31.74	2.49	35.32	9.5	0	82.82			A	V	1.0
2483.7	51.06	31.72	2.55	35.33	9.5	0	40.50	74	-33.50	P	V	1.0
2483.7	45.89	31.72	2.55	35.33	9.5	0	35.33	54	-18.67	A	V	1.0
4924.16	49.25	35.10	2.83	35.41	9.5	1	43.27	74	-30.73	P	V	1.0
7386.42	52.72	39.75	4.06	35.57	9.5	1	52.45	74	-21.55	P	V	1.0
7386.42	52.72	39.75	4.06	35.57	9.5	1	48.32	54	-5.68	P	V	1.0
9848.64	48.63	38.52	3.93	35.77	9.5	1	46.81	74	-27.19	P	V	1.0
12310.04*	---	32.14	4.53	35.24	9.5	1	---	---	---	---	V	1.0
14772.06	---	43.40	16.80	34.00	9.5	1	---	---	---	---	V	1.0
17234.08	---	45.20	17.60	34.30	9.5	1	---	---	---	---	V	1.0
19696.1*	---	36.30	18.50	34.30	9.5	1	---	---	---	---	V	1.0
22158.12*	---	36.20	19.20	34.60	9.5	1	---	---	---	---	V	1.0
24620.14	---	36.80	21.00	34.20	9.5	1	---	---	---	---	V	1.0

Note :

1. The measurement was searched to 10th harmonic, Remark “---” means that the emissions level is too low to be measured.
2. AF: Antenna Factor, Closs: Cable Loss, Pre-Amp: Preamp gain, Filter: High Pass Filter Insertion Loss (3.5GHz)
3. Analyzer setting P(Peak): RBW=1MHz, VBW=1MHz, A(Average): RBW=1MHz, VBW=10Hz
4. Remark “**” means that Restricted band.
5. The result basic equation calculation is as follow:
Level=Reading+AF+Closs-Preamp+Filter-Dist, Margin=Level-Limit
6. The other emission levels were very low against the limit
7. “ * * ” : Fundamental frequency
8. FOR A982 ANTENNA



Ecom Sertech Corp.

Rm. 258, Bldg. 17, 195 Sec. 4 Chung Hsing Rd.,
 Chu-Tung Chen, Taiwan 310, R.O.C
 TEL:886-3-5918012 FAX : 886-3-5825720

FCC ID : QDWWM168B

Report No. : ER03-04-030

Page 27 of 68

Test Requirement: 15.109 ,15.209

The frequency spectrum above 1 GHz was investigated. All emissions not reported below are more than 40 dB below the prescribed limits. Readings are both peak and average values.

Company	AirVast	Test Date :	2003/3/27
Product Name	802.11b WLAN USB Module	Test By:	M.C. Huang
Model Name	WM168b	TEMP&Humidity	27C,65%

CH1-RX MODE

Freq.	Reading	AF	Closs	Pre-amp	Dist	Filter	Level	Limit	Margin	Mark	Pol.	Height
MHz	dBuV	dBuV	dB	dB	dB	dB	dBuV/m	dBuV/m	dB	P/Q/A	H/V	Meter
4824	47.46	34.4	2.77	35.38	9.5	0	39.79	74	-34.21	P	H	1.0
7236	41.56	39.8	3.94	35.56	9.5	0	40.25	74	-33.75	P	H	1.0
9648	47.97	38.5	4.10	35.67	9.5	0	45.43	74	-28.57	P	H	1.0
4824	47.39	34.4	2.77	35.38	9.5	0	39.72	74	-34.28	P	V	1.0
7236	40.26	39.8	3.94	35.56	9.5	0	38.95	74	-35.05	P	V	1.0
9648	49.77	38.5	4.10	35.67	9.5	0	47.23	74	-26.77	P	V	1.0

CH6-RX MODE

Freq.	Reading	AF	Closs	Pre-amp	Dist	Filter	Level	Limit	Margin	Mark	Pol.	Height
MHz	dBuV	dBuV	dB	dB	dB	dB	dBuV/m	dBuV/m	dB	P/Q/A	H/V	Meter
4874	49.81	34.8	2.80	35.40	9.5	0	42.48	74	-31.52	P	H	1.0
7309	39.89	39.8	4.00	35.57	9.5	0	38.60	74	-35.40	P	H	1.0
9748	47.62	38.5	4.02	35.72	9.5	0	44.94	74	-29.06	P	H	1.0
4874	49.21	34.8	2.80	35.40	9.5	0	41.88	74	-32.12	P	V	1.0
7309	40.52	39.8	4.00	35.57	9.5	0	39.23	74	-34.77	P	V	1.0
9748	50.16	38.5	4.02	35.72	9.5	0	47.48	74	-26.52	P	V	1.0

Note :

1. Measurement was up to 18GHz harmonic,“---” means that the emissions level is too low to be measured.
2. AF: Antenna Factor, Closs: Cable Loss,
3. Analyzer setting P(Peak): RBW=1MHz, VBW=1MHz, A(Average): RBW=1MHz,VBW=10Hz
4. The other emission levels were very low against the limit
- 5.for A530 ANTENNA



Ecom Sertech Corp.

Rm. 258, Bldg. 17, 195 Sec. 4 Chung Hsing Rd.,
 Chu-Tung Chen, Taiwan 310, R.O.C
 TEL:886-3-5918012 FAX : 886-3-5825720

FCC ID : QDWWM168B

Report No. : ER03-04-030

Page 28 of 68

Test Requirement: 15.109 ,15.209

The frequency spectrum above 1 GHz was investigated. All emissions not reported below are more than 40 dB below the prescribed limits. Readings are both peak and average values.

Company				AirVast				Test Date :		2003/3/27		
Product Name				802.11b WLAN USB Module				Test By:		M.C. Huang		
Model Name				WM168b				TEMP&Humidity :		27C,65%		
CH11-RX-MODE												
Freq.	Reading	AF	Closs	Pre-amp	Dist	Filter	Level	Limit	Margin	Mark	Pol.	Height
MHz	dBuV	dBuV	dB	dB	dB	dB	dBuV/m	dBuV/m	dB	P/Q/A	H/V	Meter
4924	49.11	35.1	2.83	35.41	9.5	0	42.13	74	-31.87	P	H	1.0
7386	40.68	39.7	4.06	35.57	9.5	0	39.41	74	-34.59	P	H	1.0
9848	46.91	38.5	3.93	35.77	9.5	0	44.09	74	-29.91	P	H	1.0
4924	50.76	35.1	2.83	35.41	9.5	0	43.78	74	-30.22	P	V	1.0
7386	39.69	39.7	4.06	35.57	9.5	0	38.42	74	-35.58	P	V	1.0
9848	50.57	38.5	3.93	35.77	9.5	0	47.75	74	-26.25	P	V	1.0

Note :

1. Measurement was up to 18GHz harmonic,“---” means that the emissions level is too low to be measured.
2. AF: Antenna Factor, Closs: Cable Loss,
3. Analyzer setting P(Peak): RBW=1MHz, VBW=1MHz, A(Average): RBW=1MHz,VBW=10Hz
4. The other emission levels were very low against the limit
- 5.for A530 ANTENNA



Ecom Sertech Corp.

Rm. 258, Bldg. 17, 195 Sec. 4 Chung Hsing Rd.,
Chu-Tung Chen, Taiwan 310, R.O.C
TEL:886-3-5918012 FAX : 886-3-5825720

FCC ID : QDWWM168B

Report No. : ER03-04-030

Page 29 of 68

Test Requirement: 15.205

The frequency spectrum above 1 GHz was investigated. All emissions not reported below are more than 40 dB below the prescribed limits. Readings are both peak and average values.

Operation Mode:	Transmitting	Test Date :	2003/3/27
Fundamental Frequency:	2412MHz (CH 1)	Test By:	M.C. Huang
Temperature :	30 °C	Humidity :	65%

Freq.	Reading	AF	Closs	Pre-amp	Dist	Filter	Level	Limit	Margin	Mark	Pol.	Height
MHz	dBuV	dBuV	dB	dB	dB	dB	dBuV/m	dBuV/m	dB	P/Q/A	H/V	Meter
2390.25	47.21	31.81	2.30	35.31	9.5	0	36.51	74	-37.49	P	H	1.0
2390.25	41.05	31.81	2.30	35.31	9.5	0	30.35	54	-23.65	A	H	1.0
2412**	95.96	31.79	2.36	35.31	9.5	0	85.29			P	H	1.0
2412**	89.62	31.79	2.36	35.31	9.5	0	78.95			A	H	1.0
4824.63	46.69	34.44	2.77	35.38	9.5	1	40.02	74	-33.98	P	H	1.0
7236.18	40.19	39.81	3.94	35.56	9.5	1	39.88	74	-34.12	P	H	1.0
9648.71	47.34	38.54	4.10	35.67	9.5	1	45.80	74	-28.20	P	H	1.0
12059.93*	---	42.60	15.20	35.30	9.5	1	---	---	---	---	H	1.0
14471.97*	---	43.40	16.80	34.00	9.5	1	---	---	---	---	H	1.0
16884.01	---	45.20	17.60	34.30	9.5	1	---	---	---	---	H	1.0
19296.05*	---	36.30	18.50	34.30	9.5	1	---	---	---	---	H	1.0
21708.09	---	36.20	19.20	34.60	9.5	1	---	---	---	---	H	1.0
24120.13	---	36.80	21.00	34.20	9.5	1	---	---	---	---	H	1.0

Note :

1. The measurement was searched to 10th harmonic, Remark “---” means that the emissions level is too low to be measured.
2. AF: Antenna Factor, Closs: Cable Loss, Pre-Amp: Preamp gain, Filter: High Pass Filter Insertion Loss (3.5GHz)
3. Analyzer setting P(Peak): RBW=1MHz, VBW=1MHz, A(Average): RBW=1MHz, VBW=10Hz
4. Remark “*” means that Restricted band.
5. The result basic equation calculation is as follow:
Level=Reading+AF+Closs-Preamp+Filter-Dist, Margin=Level-Limit
6. The other emission levels were very low against the limit
7. “ * * ” : Fundamental frequency
8. for A530 ANTENNA



Ecom Sertech Corp.

Rm. 258, Bldg. 17, 195 Sec. 4 Chung Hsing Rd.,
Chu-Tung Chen, Taiwan 310, R.O.C
TEL:886-3-5918012 FAX : 886-3-5825720

FCC ID : QDWWM168B

Report No. : ER03-04-030

Page 30 of 68

Test Requirement: 15.205

The frequency spectrum above 1 GHz was investigated. All emissions not reported below are more than 40 dB below the prescribed limits. Readings are both peak and average values.

Operation Mode:	Transmitting	Test Date :	2003/3/27
Fundamental Frequency:	2412MHz (CH 1)	Test By:	M.C. Huang
Temperature :	30 °C	Humidity :	65%

Freq.	Reading	AF	Closs	Pre-amp	Dist	Filter	Level	Limit	Margin	Mark	Pol.	Height
MHz	dBuV	dBuV	dB	dB	dB	dB	dBuV/m	dBuV/m	dB	P/Q/A	H/V	Meter
2390.25	48.29	31.81	2.30	35.31	9.5	0	59.00	74	-15.00	P	V	1.0
2390.25	40.27	31.81	2.30	35.31	9.5	0	29.57	54	-24.43	A	V	1.0
2412**	100.06	31.79	2.36	35.31	9.5	0	89.39			P	V	1.0
2412**	94.26	31.79	2.36	35.31	9.5	0	83.59			A	V	1.0
4824.63	47.81	34.44	2.77	35.38	9.5	1	41.14	74	-32.86	P	V	1.0
7236.18	40.89	39.81	3.94	35.56	9.5	1	40.58	74	-33.42	P	V	1.0
9648.71	49.86	38.54	4.10	35.67	9.5	1	48.32	74	-25.68	P	V	1.0
12059.93*	---	42.60	15.20	35.30	9.5	1	---	---	---	---	V	1.0
14471.97*	---	43.40	16.80	34.00	9.5	1	---	---	---	---	V	1.0
16884.01	---	45.20	17.60	34.30	9.5	1	---	---	---	---	V	1.0
19296.05*	---	36.30	18.50	34.30	9.5	1	---	---	---	---	V	1.0
21708.09	---	36.20	19.20	34.60	9.5	1	---	---	---	---	V	1.0
24120.13	---	36.80	21.00	34.20	9.5	1	---	---	---	---	V	1.0

Note :

1. The measurement was searched to 10th harmonic, Remark “---” means that the emissions level is too low to be measured.
2. AF: Antenna Factor, Closs: Cable Loss, Pre-Amp: Preamp gain, Filter: High Pass Filter Insertion Loss (3.5GHz)
3. Analyzer setting P(Peak): RBW=1MHz, VBW=1MHz, A(Average): RBW=1MHz, VBW=10Hz
4. Remark “**” means that Restricted band.
5. The result basic equation calculation is as follow:
Level=Reading+AF+Closs-Preamp+Filter-Dist, Margin=Level-Limit
6. The other emission levels were very low against the limit
7. “ * * “: Fundamental frequency
8. for A530 ANTENNA



Ecom Sertech Corp.

Rm. 258, Bldg. 17, 195 Sec. 4 Chung Hsing Rd.,
Chu-Tung Chen, Taiwan 310, R.O.C
TEL:886-3-5918012 FAX : 886-3-5825720

FCC ID : QDWWM168B

Report No. : ER03-04-030

Page 31 of 68

Test Requirement: 15.205

The frequency spectrum above 1 GHz was investigated. All emissions not reported below are more than 40 dB below the prescribed limits. Readings are both peak and average values.

Operation Mode:	Transmitting	Test Date :	2003/3/27
Fundamental Frequency:	2437MHz (CH 6)	Test By:	M.C. Huang
Temperature :	30 °C	Humidity :	65%

Freq.	Reading	AF	Closs	Pre-amp	Dist	Filter	Level	Limit	Margin	Mark	Pol.	Height
MHz	dBuV	dBuV	dB	dB	dB	dB	dBuV/m	dBuV/m	dB	P/Q/A	H/V	Meter
2437**	98.51	31.76	2.42	35.32	9.5	0	87.88			P	H	1.0
2437**	91.20	31.76	2.42	35.32	9.5	0	80.57			A	H	1.0
4874.24	47.64	34.77	2.80	35.40	9.5	1	41.31	74	-32.69	P	H	1.0
7309.51	41.62	39.78	4.00	35.57	9.5	1	41.33	74	-32.67	P	H	1.0
9748.73	46.73	38.53	4.02	35.72	9.5	1	45.05	74	-28.95	P	H	1.0
12185.10*	---	32.14	4.53	35.24	9.5	1	---	---	---	---	H	1.0
14622.12	---	43.40	16.80	34.00	9.5	1	---	---	---	---	H	1.0
17059.14	---	45.20	17.60	34.30	9.5	1	---	---	---	---	H	1.0
19496.16*	---	36.30	18.50	34.30	9.5	1	---	---	---	---	H	1.0
21933.18	---	36.20	19.20	34.60	9.5	1	---	---	---	---	H	1.0
24370.20	---	36.80	21.00	34.20	9.5	1	---	---	---	---	H	1.0

Note :

1. The measurement was searched to 10th harmonic, Remark "---" means that the emissions level is too low to be measured.
2. AF: Antenna Factor, Closs: Cable Loss, Pre-Amp: Preamp gain, Filter: High Pass Filter Insertion Loss (3.5GHz)
3. Analyzer setting P(Peak): RBW=1MHz, VBW=1MHz, A(Average): RBW=1MHz, VBW=10Hz
4. Remark "*" means that Restricted band.
5. The result basic equation calculation is as follow:
Level=Reading+AF+Closs-Preamp+Filter-Dist, Margin=Level-Limit
6. The other emission levels were very low against the limit
7. " * * " : Fundamental frequency
8. FOR A530 ANTENNA



Ecom Sertech Corp.

Rm. 258, Bldg. 17, 195 Sec. 4 Chung Hsing Rd.,
Chu-Tung Chen, Taiwan 310, R.O.C
TEL:886-3-5918012 FAX : 886-3-5825720

FCC ID : QDWWM168B

Report No. : ER03-04-030

Page 32 of 68

Test Requirement: 15.205

The frequency spectrum above 1 GHz was investigated. All emissions not reported below are more than 40 dB below the prescribed limits. Readings are both peak and average values.

Operation Mode:	Transmitting	Test Date :	2003/3/27
Fundamental Frequency:	2437MHz (CH 6)	Test By:	M.C. Huang
Temperature :	30 °C	Humidity :	65%

Freq.	Reading	AF	Closs	Pre-amp	Dist	Filter	Level	Limit	Margin	Mark	Pol.	Height
MHz	dBuV	dBuV	dB	dB	dB	dB	dBuV/m	dBuV/m	dB	P/Q/A	H/V	Meter
2437**	100.08	31.76	2.42	35.32	9.5	0	89.45			P	V	1.0
2437**	92.07	31.76	2.42	35.32	9.5	0	81.44			A	V	1.0
4874.24	49.51	34.77	2.80	35.40	9.5	1	43.18	74	-30.82	P	V	1.0
7309.51	45.62	39.78	4.00	35.57	9.5	1	45.33	74	-28.67	P	V	1.0
48.73	50.03	38.53	4.02	35.72	9.5	1	48.35	74	-25.65	P	V	1.0
12185.10*	---	32.14	4.53	35.24	9.5	1	---	---	---	---	V	1.0
14622.12	---	43.40	16.80	34.00	9.5	1	---	---	---	---	V	1.0
17059.14	---	45.20	17.60	34.30	9.5	1	---	---	---	---	V	1.0
19496.16*	---	36.30	18.50	34.30	9.5	1	---	---	---	---	V	1.0
21933.18	---	36.20	19.20	34.60	9.5	1	---	---	---	---	V	1.0
24370.20	---	36.80	21.00	34.20	9.5	1	---	---	---	---	V	1.0

Note :

1. The measurement was searched to 10th harmonic, Remark “---” means that the emissions level is too low to be measured.
2. AF: Antenna Factor, Closs: Cable Loss, Pre-Amp: Preamp gain, Filter: High Pass Filter Insertion Loss (3.5GHz)
3. Analyzer setting P(Peak): RBW=1MHz, VBW=1MHz, A(Average): RBW=1MHz, VBW=10Hz
4. Remark “*” means that Restricted band.
5. The result basic equation calculation is as follow:
Level=Reading+AF+Closs-Preamp+Filter-Dist, Margin=Level-Limit
6. The other emission levels were very low against the limit
7. “ * * “ : Fundamental frequency
8. FOR A530 ANTENNA



Ecom Sertech Corp.

Rm. 258, Bldg. 17, 195 Sec. 4 Chung Hsing Rd.,
Chu-Tung Chen, Taiwan 310, R.O.C
TEL:886-3-5918012 FAX : 886-3-5825720

FCC ID : QDWWM168B

Report No. : ER03-04-030

Page 33 of 68

Test Requirement: 15.205

The frequency spectrum above 1 GHz was investigated. All emissions not reported below are more than 40 dB below the prescribed limits. Readings are both peak and average values.

Operation Mode:	Transmitting	Test Date :	2003/3/27
Fundamental Frequency:	2462MHz (CH 11)	Test By:	M.C. Huang
Temperature :	30 °C	Humidity :	65%

Freq.	Reading	AF	Closs	Pre-amp	Dist	Filter	Level	Limit	Margin	Mark	Pol.	Height
MHz	dBuV	dBuV	dB	dB	dB	dB	dBuV/m	dBuV/m	dB	P/Q/A	H/V	Meter
2462**	98.91	31.74	2.49	35.32	9.5	0	88.32			P	H	1.0
2462**	91.06	31.74	2.49	35.32	9.5	0	80.47			A	H	1.0
2483.7	50.21	31.72	2.55	35.33	9.5	0	39.65	74	-34.35	P	H	1.0
2483.7	44.15	31.72	2.55	35.33	9.5	0	33.59	54	-20.41	A	H	1.0
4924.16	48.03	35.10	2.83	35.41	9.5	1	42.05	74	-31.95	P	H	1.0
7386.42	40.76	39.75	4.06	35.57	9.5	1	40.49	74	-33.51	P	H	1.0
9848.64	47.68	38.52	3.93	35.77	9.5	1	45.86	74	-28.14	P	H	1.0
12310.04*	---	32.14	4.53	35.24	9.5	1	---	---	---	---	H	1.0
14772.06	---	43.40	16.80	34.00	9.5	1	---	---	---	---	H	1.0
17234.08	---	45.20	17.60	34.30	9.5	1	---	---	---	---	H	1.0
19696.1*	---	36.30	18.50	34.30	9.5	1	---	---	---	---	H	1.0
22158.12*	---	36.20	19.20	34.60	9.5	1	---	---	---	---	H	1.0
24620.14	---	36.80	21.00	34.20	9.5	1	---	---	---	---	H	1.0

Note :

1. The measurement was searched to 10th harmonic, Remark “---” means that the emissions level is too low to be measured.
2. AF: Antenna Factor, Closs: Cable Loss, Pre-Amp: Preamp gain, Filter: High Pass Filter Insertion Loss (3.5GHz)
3. Analyzer setting P(Peak): RBW=1MHz, VBW=1MHz, A(Average): RBW=1MHz, VBW=10Hz
4. Remark “*” means that Restricted band.
5. The result basic equation calculation is as follow:
Level=Reading+AF+Closs-Preamp+Filter-Dist, Margin=Level-Limit
6. The other emission levels were very low against the limit
7. “ * * * ” : Fundamental frequency
8. FOR A530 ANTENNA



Ecom Sertech Corp.

Rm. 258, Bldg. 17, 195 Sec. 4 Chung Hsing Rd.,
Chu-Tung Chen, Taiwan 310, R.O.C
TEL:886-3-5918012 FAX : 886-3-5825720

FCC ID : QDWWM168B

Report No. : ER03-04-030

Page 34 of 68

Test Requirement: 15.205

The frequency spectrum above 1 GHz was investigated. All emissions not reported below are more than 40 dB below the prescribed limits. Readings are both peak and average values.

Operation Mode:	Transmitting	Test Date :	2003/3/27
Fundamental Frequency:	2462MHz (CH 11)	Test By:	M.C. Huang
Temperature :	30 °C	Humidity :	65%

Freq.	Reading	AF	Closs	Pre-amp	Dist	Filter	Level	Limit	Margin	Mark	Pol.	Height
MHz	dBuV	dBuV	dB	dB	dB	dB	dBuV/m	dBuV/m	dB	P/Q/A	H/V	Meter
2462**	100.08	31.74	2.49	35.32	9.5	0	89.49			P	V	1.0
2462**	91.87	31.74	2.49	35.32	9.5	0	81.28			A	V	1.0
2483.7	51.84	31.72	2.55	35.33	9.5	0	41.28	74	-32.72	P	V	1.0
2483.7	46.19	31.72	2.55	35.33	9.5	0	35.63	54	-18.37	A	V	1.0
4924.16	49.77	35.10	2.83	35.41	9.5	1	43.79	74	-30.21	P	V	1.0
7386.42	40.88	39.75	4.06	35.57	9.5	1	40.61	74	-33.39	P	V	1.0
9848.64	50.95	38.52	3.93	35.77	9.5	1	49.13	74	-24.87	P	V	1.0
9848.64	50.95	38.52	3.93	35.77	9.5	1	45.20	54	-8.80	A	V	2.0
12310.04*	---	32.14	4.53	35.24	9.5	1	---	---	---	---	V	1.0
14772.06	---	43.40	16.80	34.00	9.5	1	---	---	---	---	V	1.0
17234.08	---	45.20	17.60	34.30	9.5	1	---	---	---	---	V	1.0
19696.1*	---	36.30	18.50	34.30	9.5	1	---	---	---	---	V	1.0
22158.12*	---	36.20	19.20	34.60	9.5	1	---	---	---	---	V	1.0
24620.14	---	36.80	21.00	34.20	9.5	1	---	---	---	---	V	1.0

Note :

1. The measurement was searched to 10th harmonic, Remark “---” means that the emissions level is too low to be measured.
2. AF: Antenna Factor, Closs: Cable Loss, Pre-Amp: Preamp gain, Filter: High Pass Filter Insertion Loss (3.5GHz)
3. Analyzer setting P(Peak): RBW=1MHz, VBW=1MHz, A(Average): RBW=1MHz, VBW=10Hz
4. Remark “**” means that Restricted band.
5. The result basic equation calculation is as follow:
Level=Reading+AF+Closs+Preamp+Filter-Dist, Margin=Level-Limit
6. The other emission levels were very low against the limit
7. “ * * “ : Fundamental frequency
8. FOR A530 ANTENNA



Ecom Sertech Corp.

Rm. 258, Bldg. 17, 195 Sec. 4 Chung Hsing Rd.,
 Chu-Tung Chen, Taiwan 310, R.O.C
 TEL:886-3-5918012 FAX : 886-3-5825720

FCC ID : QDWWM168B

Report No. : ER03-04-030

Page 35 of 68

Test Requirement: 15.109 ,15.209

The frequency spectrum above 1 GHz was investigated. All emissions not reported below are more than 40 dB below the prescribed limits. Readings are both peak and average values.

Company	AirVast	Test Date :	2003/3/27
Product Name	802.11b WLAN USB Module	Test By:	M.C. Huang
Model Name	WM168b	TEMP&Humidity	27C,65%

CH1-RX MODE

Freq.	Reading	AF	Closs	Pre-amp	Dist	Filter	Level	Limit	Margin	Mark	Pol.	Height
MHz	dBuV	dBuV	dB	dB	dB	dB	dBuV/m	dBuV/m	dB	P/Q/A	H/V	Meter
4824	47.95	34.4	2.77	35.38	9.5	0	40.28	74	-33.72	P	H	1.0
7236	43.11	39.8	3.94	35.56	9.5	0	41.80	74	-32.20	P	H	1.0
9648	47.12	38.5	4.10	35.67	9.5	0	44.58	74	-29.42	P	H	1.0
4824	47.62	34.4	2.77	35.38	9.5	0	39.95	74	-34.05	P	V	1.0
7236	43.41	39.8	3.94	35.56	9.5	0	42.10	74	-31.90	P	V	1.0
9648	50.93	38.5	4.10	35.67	9.5	0	48.39	74	-25.61	P	V	1.0
9648	50.93	38.5	4.10	35.67	9.5	0	44.35	54	-9.65	A	V	1.0

CH6-RX MODE

Freq.	Reading	AF	Closs	Pre-amp	Dist	Filter	Level	Limit	Margin	Mark	Pol.	Height
MHz	dBuV	dBuV	dB	dB	dB	dB	dBuV/m	dBuV/m	dB	P/Q/A	H/V	Meter
4874	48.17	34.8	2.80	35.40	9.5	0	40.84	74	-33.16	P	H	1.0
7309	42.91	39.8	4.00	35.57	9.5	0	41.62	74	-32.38	P	H	1.0
9748	44.69	38.5	4.02	35.72	9.5	0	42.01	74	-31.99	P	H	1.0
4874	49.19	34.8	2.80	35.40	9.5	0	41.86	74	-32.14	P	V	1.0
7309	43.71	39.8	4.00	35.57	9.5	0	42.42	74	-31.58	P	V	1.0
9748	50.69	38.5	4.02	35.72	9.5	0	48.01	74	-25.99	P	V	1.0
9748	50.69	38.5	4.02	35.72	9.5	0	45.24	54	-8.76	A	V	1.0

Note :

1. Measurement was up to 18GHz harmonic,“---” means that the emissions level is too low to be measured.
2. AF: Antenna Factor, Closs: Cable Loss,
3. Analyzer setting P(Peak): RBW=1MHz, VBW=1MHz, A(Average): RBW=1MHz,VBW=10Hz
4. The other emission levels were very low against the limit
- 5.for G736 ANTENNA



Ecom Sertech Corp.

Rm. 258, Bldg. 17, 195 Sec. 4 Chung Hsing Rd.,
Chu-Tung Chen, Taiwan 310, R.O.C
TEL:886-3-5918012 FAX : 886-3-5825720

FCC ID : QDWWM168B

Report No. : ER03-04-030

Page 36 of 68

Test Requirement: 15.109 ,15.209

The frequency spectrum above 1 GHz was investigated. All emissions not reported below are more than 40 dB below the prescribed limits. Readings are both peak and average values.

Company				AirVast				Test Date :		2003/3/27		
Product Name				802.11b WLAN USB Module				Test By:		M.C. Huang		
Model Name				WM168b				TEMP&Humidity :		27C,65%		
CH11-RX-MODE												
Freq.	Reading	AF	Closs	Pre-amp	Dist	Filter	Level	Limit	Margin	Mark	Pol.	Height
MHz	dBuV	dBuV	dB	dB	dB	dB	dBuV/m	dBuV/m	dB	P/Q/A	H/V	Meter
4924	49.48	35.1	2.83	35.41	9.5	0	42.50	74	-31.50	P	H	1.0
7386	42.66	39.7	4.06	35.57	9.5	0	41.39	74	-32.61	P	H	1.0
9848	47.63	38.5	3.93	35.77	9.5	0	44.81	74	-29.19	P	H	1.0
4924	50.92	35.1	2.83	35.41	9.5	0	43.94	74	-30.06	P	V	1.0
7386	43.02	39.7	4.06	35.57	9.5	0	41.75	74	-32.25	P	V	1.0
9848	51.79	38.5	3.93	35.77	9.5	0	48.97	74	-25.03	P	V	1.0
9848	51.79	38.5	3.93	35.77	9.5	0	45.12	54	-8.88	A	V	1.0

Note :

1. Measurement was up to 18GHz harmonic,“---” means that the emissions level is too low to be measured.
2. AF: Antenna Factor, Closs: Cable Loss,
3. Analyzer setting P(Peak): RBW=1MHz, VBW=1MHz, A(Average): RBW=1MHz,VBW=10Hz
4. The other emission levels were very low against the limit
- 5.for G736 ANTENNA



Ecom Sertech Corp.

Rm. 258, Bldg. 17, 195 Sec. 4 Chung Hsing Rd.,
Chu-Tung Chen, Taiwan 310, R.O.C
TEL:886-3-5918012 FAX : 886-3-5825720

FCC ID : QDWWM168B

Report No. : ER03-04-030

Page 37 of 68

Test Requirement: 15.205

The frequency spectrum above 1 GHz was investigated. All emissions not reported below are more than 40 dB below the prescribed limits. Readings are both peak and average values.

Operation Mode:	Transmitting	Test Date :	2003/3/27
Fundamental Frequency:	2412MHz (CH 1)	Test By:	M.C. Huang
Temperature :	30 °C	Humidity :	65%

Freq.	Reading	AF	Closs	Pre-amp	Dist	Filter	Level	Limit	Margin	Mark	Pol.	Height
MHz	dBuV	dBuV	dB	dB	dB	dB	dBuV/m	dBuV/m	dB	P/Q/A	H/V	Meter
2390.25	48.15	31.81	2.30	35.31	9.5	0	37.45	74	-36.55	P	H	1.0
2390.25	40.29	31.81	2.30	35.31	9.5	0	29.59	54	-24.41	A	H	1.0
2412**	104.33	31.79	2.36	35.31	9.5	0	93.66			P	H	1.0
2412**	95.26	31.79	2.36	35.31	9.5	0	84.59			A	H	1.0
4824.63	42.96	34.44	2.77	35.38	9.5	1	36.29	74	-37.71	P	H	1.0
7236.18	42.83	39.81	3.94	35.56	9.5	1	42.52	74	-31.48	P	H	1.0
9648.71	48.99	38.54	4.10	35.67	9.5	1	47.45	74	-26.55	P	H	1.0
12059.93*	---	42.60	15.20	35.30	9.5	1	---	---	---	---	H	1.0
14471.97*	---	43.40	16.80	34.00	9.5	1	---	---	---	---	H	1.0
16884.01	---	45.20	17.60	34.30	9.5	1	---	---	---	---	H	1.0
19296.05*	---	36.30	18.50	34.30	3	1	---	---	---	---	H	1.0
21708.09	---	36.20	19.20	34.60	9.5	1	---	---	---	---	H	1.0
24120.13	---	36.80	21.00	34.20	9.5	1	---	---	---	---	H	1.0

Note :

1. The measurement was searched to 10th harmonic, Remark “---” means that the emissions level is too low to be measured.
2. AF: Antenna Factor, Closs: Cable Loss, Pre-Amp: Preamp gain, Filter: High Pass Filter Insertion Loss (3.5GHz)
3. Analyzer setting P(Peak): RBW=1MHz, VBW=1MHz, A(Average): RBW=1MHz, VBW=10Hz
4. Remark “*” means that Restricted band.
5. The result basic equation calculation is as follow:
Level=Reading+AF+Closs-Preamp+Filter-Dist, Margin=Level-Limit
6. The other emission levels were very low against the limit
7. “ * * ” : Fundamental frequency
8. for G736 ANTENNA



Ecom Sertech Corp.

Rm. 258, Bldg. 17, 195 Sec. 4 Chung Hsing Rd.,
Chu-Tung Chen, Taiwan 310, R.O.C
TEL:886-3-5918012 FAX : 886-3-5825720

FCC ID : QDWWM168B

Report No. : ER03-04-030

Page 38 of 68

Test Requirement: 15.205

The frequency spectrum above 1 GHz was investigated. All emissions not reported below are more than 40 dB below the prescribed limits. Readings are both peak and average values.

Operation Mode:	Transmitting	Test Date :	2003/3/27
Fundamental Frequency:	2412MHz (CH 1)	Test By:	M.C. Huang
Temperature :	30 °C	Humidity :	65%

Freq.	Reading	AF	Closs	Pre-amp	Dist	Filter	Level	Limit	Margin	Mark	Pol.	Height
MHz	dBuV	dBuV	dB	dB	dB	dB	dBuV/m	dBuV/m	dB	P/Q/A	H/V	Meter
2390.25	48.26	31.81	2.30	35.31	9.5	0	37.56	74	-36.44	P	V	1.0
2390.25	42.05	31.81	2.30	35.31	9.5	0	31.35	54	-22.65	A	V	1.0
2412**	101.51	31.79	2.36	35.31	9.5	0	90.84			P	V	1.0
2412**	93.74	31.79	2.36	35.31	9.5	0	83.07			A	V	1.0
4824.63	45.87	34.44	2.77	35.38	9.5	1	39.20	74	-34.80	P	V	1.0
7236.18	43.56	39.81	3.94	35.56	9.5	1	43.25	74	-30.75	P	V	1.0
9648.71	50.69	38.54	4.10	35.67	9.5	1	49.15	74	-24.85	P	V	1.0
9648.71	50.69	38.54	4.10	35.67	9.5	1	44.53	54	-9.47	A	V	1.0
12059.93*	---	42.60	15.20	35.30	9.5	1	---	---	---	---	V	1.0
14471.97*	---	43.40	16.80	34.00	9.5	1	---	---	---	---	V	1.0
16884.0	---	45.20	17.60	34.30	9.5	1	---	---	---	---	V	1.0
19296.05*	---	36.30	18.50	34.30	3	1	---	---	---	---	V	1.0
21708.1	---	36.20	19.20	34.60	9.5	1	---	---	---	---	V	1.0
24120.1	---	36.80	21.00	34.20	9.5	1	---	---	---	---	V	1.0

Note :

1. The measurement was searched to 10th harmonic, Remark “---” means that the emissions level is too low to be measured.
2. AF: Antenna Factor, Closs: Cable Loss, Pre-Amp: Preamp gain, Filter: High Pass Filter Insertion Loss (3.5GHz)
3. Analyzer setting P(Peak): RBW=1MHz, VBW=1MHz, A(Average): RBW=1MHz, VBW=10Hz
4. Remark “**” means that Restricted band.
5. The result basic equation calculation is as follow:
Level=Reading+AF+Closs-Preamp+Filter-Dist, Margin=Level-Limit
6. The other emission levels were very low against the limit
7. “* * *”: Fundamental frequency



Ecom Sertech Corp.

Rm. 258, Bldg. 17, 195 Sec. 4 Chung Hsing Rd.,
Chu-Tung Chen, Taiwan 310, R.O.C
TEL:886-3-5918012 FAX : 886-3-5825720

FCC ID : QDWWM168B

Report No. : ER03-04-030

Page 39 of 68

Test Requirement: 15.205

The frequency spectrum above 1 GHz was investigated. All emissions not reported below are more than 40 dB below the prescribed limits. Readings are both peak and average values.

Operation Mode:	Transmitting	Test Date :	2003/3/27
Fundamental Frequency:	2437MHz (CH 6)	Test By:	M.C. Huang
Temperature :	30 °C	Humidity :	65%

Freq.	Reading	AF	Closs	Pre-amp	Dist	Filter	Level	Limit	Margin	Mark	Pol.	Height
MHz	dBuV	dBuV	dB	dB	dB	dB	dBuV/m	dBuV/m	dB	P/Q/A	H/V	Meter
2437**	103.58	31.76	2.42	35.32	9.5	0	92.95			P	H	1.0
2437**	93.75	31.76	2.42	35.32	9.5	0	83.12			A	H	1.0
4874.24	48.96	34.77	2.80	35.40	9.5	1	42.63	74	-31.37	P	H	1.0
7309.51	43.08	39.78	4.00	35.57	9.5	1	42.79	74	-31.21	P	H	1.0
9748.73	46.09	38.53	4.02	35.72	9.5	1	44.41	74	-29.59	P	H	1.0
9748.73	46.09	38.53	4.02	35.72	9.5	1	44.41	54	-9.59	A	H	1.0
12185.10*	---	32.14	4.53	35.24	9.5	1	---	---	---	---	H	1.0
14622.12	---	43.40	16.80	34.00	9.5	1	---	---	---	---	H	1.0
17059.14	---	45.20	17.60	34.30	9.5	1	---	---	---	---	H	1.0
19496.16*	---	36.30	18.50	34.30	9.5	1	---	---	---	---	H	1.0
21933.18	---	36.20	19.20	34.60	9.5	1	---	---	---	---	H	1.0
24370.20	---	36.80	21.00	34.20	9.5	1	---	---	---	---	H	1.0

Note :

1. The measurement was searched to 10th harmonic, Remark “---” means that the emissions level is too low to be measured.
2. AF: Antenna Factor, Closs: Cable Loss, Pre-Amp: Preamp gain, Filter: High Pass Filter Insertion Loss (3.5GHz)
3. Analyzer setting P(Peak): RBW=1MHz, VBW=1MHz, A(Average): RBW=1MHz, VBW=10Hz
4. Remark “*” means that Restricted band.
5. The result basic equation calculation is as follow:
Level=Reading+AF+Closs-Preamp+Filter-Dist, Margin=Level-Limit
6. The other emission levels were very low against the limit
7. “ * * * ” : Fundamental frequency



Ecom Sertech Corp.

Rm. 258, Bldg. 17, 195 Sec. 4 Chung Hsing Rd.,
Chu-Tung Chen, Taiwan 310, R.O.C
TEL:886-3-5918012 FAX : 886-3-5825720

FCC ID : QDWWM168B

Report No. : ER03-04-030

Page 40 of 68

Test Requirement: 15.205

The frequency spectrum above 1 GHz was investigated. All emissions not reported below are more than 40 dB below the prescribed limits. Readings are both peak and average values.

Operation Mode:	Transmitting	Test Date :	2003/3/27
Fundamental Frequency:	2437MHz (CH 6)	Test By:	M.C. Huang
Temperature :	30 °C	Humidity :	65%

Freq.	Reading	AF	Closs	Pre-amp	Dist	Filter	Level	Limit	Margin	Mark	Pol.	Height
MHz	dBuV	dBuV	dB	dB	dB	dB	dBuV/m	dBuV/m	dB	P/Q/A	H/V	Meter
2437**	101.44	31.76	2.42	35.32	9.5	0	90.81			P	V	1.0
2437**	91.86	31.76	2.42	35.32	9.5	0	81.23			A	V	1.0
4874.24	49.51	34.77	2.80	35.40	9.5	1	43.18	74	-30.82	P	V	1.0
7309.51	43.62	39.78	4.00	35.57	9.5	1	43.33	74	-30.67	P	V	1.0
9748.73	50.43	38.53	4.02	35.72	9.5	1	48.75	74	-25.25	P	V	1.0
9748.73	50.43	38.53	4.02	35.72	9.5	1	45.32	54	-8.68	P	V	1.0
12185.10*	---	32.14	4.53	35.24	9.5	1	---	---	---	---	V	1.0
14622.12	---	43.40	16.80	34.00	9.5	1	---	---	---	---	V	1.0
17059.14	---	45.20	17.60	34.30	9.5	1	---	---	---	---	V	1.0
19496.16*	---	36.30	18.50	34.30	9.5	1	---	---	---	---	V	1.0
21933.18	---	36.20	19.20	34.60	9.5	1	---	---	---	---	V	1.0
24370.20	---	36.80	21.00	34.20	9.5	1	---	---	---	---	V	1.0

Note :

- The measurement was searched to 10th harmonic, Remark “---” means that the emissions level is too low to be measured.
- AF: Antenna Factor, Closs: Cable Loss, Pre-Amp: Preamp gain, Filter: High Pass Filter Insertion Loss (3.5GHz)
- Analyzer setting P(Peak): RBW=1MHz, VBW=1MHz, A(Average): RBW=1MHz, VBW=10Hz
- Remark “*” means that Restricted band.
- The result basic equation calculation is as follow:
Level=Reading+AF+Closs-Preamp+Filter-Dist, Margin=Level-Limit
- The other emission levels were very low against the limit
- “ * * ” : Fundamental frequency
- FOR G736 ANTENNA



Ecom Sertech Corp.

Rm. 258, Bldg. 17, 195 Sec. 4 Chung Hsing Rd.,
 Chu-Tung Chen, Taiwan 310, R.O.C
 TEL:886-3-5918012 FAX : 886-3-5825720

FCC ID : QDWWM168B

Report No. : ER03-04-030

Page 41 of 68

Test Requirement: 15.205

The frequency spectrum above 1 GHz was investigated. All emissions not reported below are more than 40 dB below the prescribed limits. Readings are both peak and average values.

Operation Mode:	Transmitting	Test Date :	2003/3/27
Fundamental Frequency:	2462MHz (CH 11)	Test By:	M.C. Huang
Temperature :	30 °C	Humidity :	65%

Freq.	Reading	AF	Closs	Pre-amp	Dist	Filter	Level	Limit	Margin	Mark	Pol.	Height
MHz	dBuV	dBuV	dB	dB	dB	dB	dBuV/m	dBuV/m	dB	P/Q/A	H/V	Meter
2462**	102.96	31.74	2.49	35.32	9.5	0	92.37			P	H	1.0
2462**	92.48	31.74	2.49	35.32	9.5	0	81.89			A	H	1.0
2483.7	49.58	31.72	2.55	35.33	9.5	0	39.02	74	-34.98	P	H	1.0
2483.7	43.85	31.72	2.55	35.33	9.5	0	33.29	54	-20.71	A	H	1.0
4924.16	48.07	35.10	2.83	35.41	9.5	1	42.09	74	-31.91	P	H	1.0
7386.42	43.15	39.75	4.06	35.57	9.5	1	42.88	74	-31.12	P	H	1.0
9848.64	46.69	38.52	3.93	35.77	9.5	1	44.87	74	-29.13	P	H	1.0
12310.04*	---	32.14	4.53	35.24	9.5	1	---	---	---	---	H	1.0
14772.06	---	43.40	16.80	34.00	9.5	1	---	---	---	---	H	1.0
17234.08	---	45.20	17.60	34.30	9.5	1	---	---	---	---	H	1.0
19696.1*	---	36.30	18.50	34.30	9.5	1	---	---	---	---	H	1.0
22158.12*	---	36.20	19.20	34.60	9.5	1	---	---	---	---	H	1.0
24620.14	---	36.80	21.00	34.20	9.5	1	---	---	---	---	H	1.0

Note :

1. The measurement was searched to 10th harmonic, Remark “---” means that the emissions level is too low to be measured.
2. AF: Antenna Factor, Closs: Cable Loss, Pre-Amp: Preamp gain, Filter: High Pass Filter Insertion Loss (3.5GHz)
3. Analyzer setting P(Peak): RBW=1MHz, VBW=1MHz, A(Average): RBW=1MHz, VBW=10Hz
4. Remark “*” means that Restricted band.
5. The result basic equation calculation is as follow:
 $Level = Reading + AF + Closs - Preamp + Filter - Dist, Margin = Level - Limit$
6. The other emission levels were very low against the limit
7. “ * * * ” : Fundamental frequency
8. FOR G736 ANTENNA



Ecom Sertech Corp.

Rm. 258, Bldg. 17, 195 Sec. 4 Chung Hsing Rd.,
Chu-Tung Chen, Taiwan 310, R.O.C
TEL:886-3-5918012 FAX : 886-3-5825720

FCC ID : QDWWM168B

Report No. : ER03-04-030

Page 42 of 68

Test Requirement: 15.205

The frequency spectrum above 1 GHz was investigated. All emissions not reported below are more than 40 dB below the prescribed limits. Readings are both peak and average values.

Operation Mode:	Transmitting	Test Date :	2003/3/27
Fundamental Frequency:	2462MHz (CH 11)	Test By:	M.C. Huang
Temperature :	30 °C	Humidity :	65%

Freq.	Reading	AF	Closs	Pre-amp	Dist	Filter	Level	Limit	Margin	Mark	Pol.	Height
MHz	dBuV	dBuV	dB	dB	dB	dB	dBuV/m	dBuV/m	dB	P/Q/A	H/V	Meter
2462**	102.68	31.74	2.49	35.32	9.5	0	92.09			P	V	1.0
2462**	91.95	31.74	2.49	35.32	9.5	0	81.36			A	V	1.0
2483.7	50.49	31.72	2.55	35.33	9.5	0	39.93	74	-34.07	P	V	1.0
2483.7	43.87	31.72	2.55	35.33	9.5	0	33.31	54	-20.69	A	V	1.0
4924.16	48.53	35.10	2.83	35.41	9.5	1	42.55	74	-31.45	P	V	1.0
7386.42	42.56	39.75	4.06	35.57	9.5	1	42.29	74	-31.71	P	V	1.0
9848.64	50.99	38.52	3.93	35.77	9.5	1	49.17	74	-24.83	P	V	1.0
12310.04*	---	32.14	4.53	35.24	9.5	1	---	---	---	---	V	1.0
14772.06	---	43.40	16.80	34.00	9.5	1	---	---	---	---	V	1.0
17234.08	---	45.20	17.60	34.30	9.5	1	---	---	---	---	V	1.0
19696.1*	---	36.30	18.50	34.30	9.5	1	---	---	---	---	V	1.0
22158.12*	---	36.20	19.20	34.60	9.5	1	---	---	---	---	V	1.0
24620.14	---	36.80	21.00	34.20	9.5	1	---	---	---	---	V	1.0

Note :

1. The measurement was searched to 10th harmonic, Remark “---” means that the emissions level is too low to be measured.
 2. AF: Antenna Factor, Closs: Cable Loss, Pre-Amp: Preamp gain, Filter: High Pass Filter Insertion Loss (3.5GHz)
 3. Analyzer setting P(Peak): RBW=1MHz, VBW=1MHz, A(Average): RBW=1MHz, VBW=10Hz
 4. Remark “*” means that Restricted band.
 5. The result basic equation calculation is as follow:
Level=Reading+AF+Closs-Preamp+Filter-Dist, Margin=Level-Limit
 6. The other emission levels were very low against the limit
 7. “ * * ” : Fundamental frequency
5. for G736 ANTENNA



Ecom Sertech Corp.

Rm. 258, Bldg. 17, 195 Sec. 4 Chung Hsing Rd.,
 Chu-Tung Chen, Taiwan 310, R.O.C
 TEL:886-3-5918012 FAX : 886-3-5825720

FCC ID : QDWWM168B

Report No. : ER03-04-030

Page 43 of 68

Test Requirement: 15.109 ,15.209

The frequency spectrum above 1 GHz was investigated. All emissions not reported below are more than 40 dB below the prescribed limits. Readings are both peak and average values.

Company		AirVast					Test Date :	2003/3/27				
Product Name		802.11b WLAN USB Module					Test By:	M.C. Huang				
Model Name		WM168b					TEMP&Humidity :	27C ,65%				
CH1-RX MODE												
Freq.	Reading	AF	Closs	Pre-amp	Dist	Filter	Level	Limit	Margin	Mark	Pol.	Height
MHz	dBuV	dBuV	dB	dB	dB	dB	dBuV/m	dBuV/m	dB	P/Q/A	H/V	Meter
4824	46.92	34.44	2.77	35.38	9.5	0	39.25	74	-34.75	P	H	1.0
7236	42.48	39.81	3.94	35.56	9.5	0	41.17	74	-32.83	P	H	1.0
9648	46.73	38.54	4.10	35.67	9.5	0	44.19	74	-29.81	P	H	1.0
4824	47.93	34.44	2.77	35.38	9.5	0	40.26	74	-33.74	P	V	1.0
7236	43.04	39.81	3.94	35.56	9.5	0	41.73	74	-32.27	P	V	1.0
9648	43.55	38.54	4.10	35.67	9.5	0	41.01	74	-32.99	P	V	1.0
9649	42.62	38.54	4.10	35.67	9.5	0	40.08	54	-13.92	A	V	1.0
CH6-RX MODE												
Freq.	Reading	AF	Closs	Pre-amp	Dist	Filter	Level	Limit	Margin	Mark	Pol.	Height
MHz	dBuV	dBuV	dB	dB	dB	dB	dBuV/m	dBuV/m	dB	P/Q/A	H/V	Meter
4874	48.99	34.77	2.80	35.40	9.5	0	41.66	74	-32.34	P	H	1.0
7309	42.66	39.78	4.00	35.57	9.5	0	41.37	74	-32.63	P	H	1.0
9748	46.23	38.53	4.02	35.72	9.5	0	43.55	74	-30.45	P	H	1.0
4874	49.44	34.77	2.80	35.40	9.5	0	42.11	74	-31.89	P	V	1.0
7309	43.21	39.78	4.00	35.57	9.5	0	41.92	74	-32.08	P	V	1.0
9748	49.81	38.53	4.02	35.72	9.5	0	47.13	74	-26.87	P	V	1.0
9749	48.84	38.53	4.02	35.72	9.5	0	46.16	54	-7.84	A	V	1.0
Note :												
1. Measurement was up to 18GHz harmonic,“---” means that the emissions level is too low to be measured.												
2. AF: Antenna Factor, Closs: Cable Loss,												
3. A nalyzer setting P(Peak): RBW =1MHz, VBW =1MHz, A (Average): RBW =1MHz,VBW =10Hz												
4. The other emission levels were very low against the limit												
5.for G530 ANTENNA												



Ecom Sertech Corp.

Rm. 258, Bldg. 17, 195 Sec. 4 Chung Hsing Rd.,
Chu-Tung Chen, Taiwan 310, R.O.C
TEL:886-3-5918012 FAX : 886-3-5825720

FCC ID : QDWWM168B

Report No. : ER03-04-030

Page 44 of 68

Test Requirement: 15.109 ,15.209

The frequency spectrum above 1 GHz was investigated. All emissions not reported below are more than 40 dB below the prescribed limits. Readings are both peak and average values.

Company				AirVast				Test Date :		2003/3/27		
Product Name				802.11b WLAN USB Module				Test By:		M.C. Huang		
Model Name				WM168b				TEMP&Humidity :		27C,65%		
CH11-RX-MODE												
Freq.	Reading	AF	Closs	Pre-amp	Dist	Filter	Level	Limit	Margin	Mark	Pol.	Height
MHz	dBuV	dBuV	dB	dB	dB	dB	dBuV/m	dBuV/m	dB	P/Q/A	H/V	Meter
4924	49.61	35.1	2.83	35.41	9.5	0	42.63	74	-31.37	P	H	1.0
7386	43.21	39.7	4.06	35.57	9.5	0	41.94	74	-32.06	P	H	1.0
9848	46.17	38.5	3.93	35.77	9.5	0	43.35	74	-30.65	P	H	1.0
4924	50.15	35.1	2.83	35.41	9.5	0	43.17	74	-30.83	P	V	1.0
7386	42.21	39.7	4.06	35.57	9.5	0	40.94	74	-33.06	P	V	1.0
9848	46.80	38.5	3.93	35.77	9.5	0	43.98	74	-30.02	P	V	1.0
9849	46.21	38.5	3.93	35.77	9.5	0	43.38	54	-10.62	P	A	1.0

Note :

1. Measurement was up to 18GHz harmonic,“---” means that the emissions level is too low to be measured.
2. AF: Antenna Factor, Closs: Cable Loss,
3. Analyzer setting P(Peak): RBW=1MHz, VBW=1MHz, A(Average): RBW=1MHz,VBW=10Hz
4. The other emission levels were very low against the limit
- 5.for G530 ANTENNA



Ecom Sertech Corp.

Rm. 258, Bldg. 17, 195 Sec. 4 Chung Hsing Rd.,
Chu-Tung Chen, Taiwan 310, R.O.C
TEL:886-3-5918012 FAX : 886-3-5825720

FCC ID : QDWWM168B

Report No. : ER03-04-030

Page 45 of 68

Test Requirement: 15.205

The frequency spectrum above 1 GHz was investigated. All emissions not reported below are more than 40 dB below the prescribed limits. Readings are both peak and average values.

Operation Mode:	Transmitting	Test Date :	2003/3/27
Fundamental Frequency:	2412MHz (CH 1)	Test By:	M.C. Huang
Temperature :	30 °C	Humidity :	65%

Freq.	Reading	AF	Closs	Pre-amp	Dist	Filter	Level	Limit	Margin	Mark	Pol.	Height
MHz	dBuV	dBuV	dB	dB	dB	dB	dBuV/m	dBuV/m	dB	P/Q/A	H/V	Meter
2390.25	49.26	31.81	2.30	35.31	9.5	0	38.56	74	-35.44	P	H	1.0
2390.25	41.25	31.81	2.30	35.31	9.5	0	30.55	54	-23.45	A	H	1.0
2412**	100.98	31.79	2.36	35.31	9.5	0	90.31			P	H	1.0
2412**	91.26	31.79	2.36	35.31	9.5	0	80.59			A	H	1.0
4824.63	46.69	34.44	2.77	35.38	9.5	1	40.02	74	-33.98	P	H	1.0
7236.18	43.17	39.81	3.94	35.56	9.5	1	42.86	74	-31.14	P	H	1.0
9648.71	48.12	38.54	4.10	35.67	9.5	1	46.58	74	-27.42	P	H	1.0
12059.93*	---	42.60	15.20	35.30	9.5	1	---	---	---	---	H	1.0
14471.97*	---	43.40	16.80	34.00	9.5	1	---	---	---	---	H	1.0
16884.01	---	45.20	17.60	34.30	9.5	1	---	---	---	---	H	1.0
19296.05*	---	36.30	18.50	34.30	3	1	---	---	---	---	H	1.0
21708.09	---	36.20	19.20	34.60	9.5	1	---	---	---	---	H	1.0
24120.13	---	36.80	21.00	34.20	9.5	1	---	---	---	---	H	1.0

Note :

1. The measurement was searched to 10th harmonic, Remark “---” means that the emissions level is too low to be measured.
2. AF: Antenna Factor, Closs: Cable Loss, Pre-Amp: Preamp gain, Filter: High Pass Filter Insertion Loss (3.5GHz)
3. Analyzer setting P(Peak): RBW=1MHz, VBW=1MHz, A(Average): RBW=1MHz, VBW=10Hz
4. Remark “*” means that Restricted band.
5. The result basic equation calculation is as follow:
Level=Reading+AF+Closs-Preamp+Filter-Dist, Margin=Level-Limit
6. The other emission levels were very low against the limit
7. “ * * ” : Fundamental frequency
8. for G530 ANTENNA



Ecom Sertech Corp.

Rm. 258, Bldg. 17, 195 Sec. 4 Chung Hsing Rd.,
Chu-Tung Chen, Taiwan 310, R.O.C
TEL:886-3-5918012 FAX : 886-3-5825720

FCC ID : QDWWM168B

Report No. : ER03-04-030

Page 46 of 68

Test Requirement: 15.205

The frequency spectrum above 1 GHz was investigated. All emissions not reported below are more than 40 dB below the prescribed limits. Readings are both peak and average values.

Operation Mode:	Transmitting	Test Date :	2003/3/27
Fundamental Frequency:	2412MHz (CH 1)	Test By:	M.C. Huang
Temperature :	30 °C	Humidity :	65%

Freq.	Reading	AF	Closs	Pre-amp	Dist	Filter	Level	Limit	Margin	Mark	Pol.	Height
MHz	dBuV	dBuV	dB	dB	dB	dB	dBuV/m	dBuV/m	dB	P/Q/A	H/V	Meter
2390.25	47.59	31.81	2.30	35.31	9.5	0	36.89	74	-37.11	P	V	1.0
2390.25	41.82	31.81	2.30	35.31	9.5	0	31.12	54	-22.88	A	V	1.0
2412**	100.90	31.79	2.36	35.31	9.5	0	90.24			P	V	1.0
2412**	94.75	31.79	2.36	35.31	9.5	0	84.08			A	V	1.0
4824.63	48.55	34.44	2.77	35.38	9.5	1	41.88	74	-32.12	P	V	1.0
7236.18	44.05	39.81	3.94	35.56	9.5	1	43.74	74	-30.26	P	V	1.0
9648.71	49.02	38.54	4.10	35.67	9.5	1	47.48	74	-26.52	P	V	1.0
12059.93*	---	42.60	15.20	35.30	9.5	1	---	---	---	---	V	1.0
14471.97*	---	43.40	16.80	34.00	9.5	1	---	---	---	---	V	1.0
16884.01	---	45.20	17.60	34.30	9.5	1	---	---	---	---	V	1.0
19296.05*	---	36.30	18.50	34.30	3	1	---	---	---	---	V	1.0
21708.09	---	36.20	19.20	34.60	9.5	1	---	---	---	---	V	1.0
24120.13	---	36.80	21.00	34.20	9.5	1	---	---	---	---	V	1.0

Note :

- The measurement was searched to 10th harmonic, Remark “---” means that the emissions level is too low to be measured.
- AF: Antenna Factor, Closs: Cable Loss, Pre-Amp: Preamp gain, Filter: High Pass Filter Insertion Loss (3.5GHz)
- Analyzer setting P(Peak): RBW=1MHz, VBW=1MHz, A(Average): RBW=1MHz, VBW=10Hz
- Remark “**” means that Restricted band.
- The result basic equation calculation is as follow:
Level=Reading+AF+Closs-Preamp+Filter-Dist, Margin=Level-Limit
- The other emission levels were very low against the limit
- “* * *”: Fundamental frequency
- for G530 ANTENNA



Ecom Sertech Corp.

Rm. 258, Bldg. 17, 195 Sec. 4 Chung Hsing Rd.,
Chu-Tung Chen, Taiwan 310, R.O.C
TEL:886-3-5918012 FAX : 886-3-5825720

FCC ID : QDWWM168B

Report No. : ER03-04-030

Page 47 of 68

Test Requirement: 15.205

The frequency spectrum above 1 GHz was investigated. All emissions not reported below are more than 40 dB below the prescribed limits. Readings are both peak and average values.

Operation Mode:	Transmitting	Test Date :	2003/3/27
Fundamental Frequency:	2437MHz (CH 6)	Test By:	M.C. Huang
Temperature :	30 °C	Humidity :	65%

Freq.	Reading	AF	Closs	Pre-amp	Dist	Filter	Level	Limit	Margin	Mark	Pol.	Height
MHz	dBuV	dBuV	dB	dB	dB	dB	dBuV/m	dBuV/m	dB	P/Q/A	H/V	Meter
2437**	98.37	31.76	2.42	35.32	9.5	0	87.74			P	H	1.0
2437**	92.26	31.76	2.42	35.32	9.5	0	81.63			A	H	1.0
4874.24	47.63	34.77	2.80	35.40	9.5	1	41.30	74	-32.70	P	H	1.0
7309.51	43.66	39.78	4.00	35.57	9.5	1	43.37	74	-30.63	P	H	1.0
9748.73	48.99	38.53	4.02	35.72	9.5	1	47.31	74	-26.69	P	H	1.0
12185.10*	---	32.14	4.53	35.24	9.5	1	---	---	---	---	H	1.0
14622.12	---	43.40	16.80	34.00	9.5	1	---	---	---	---	H	1.0
17059.14	---	45.20	17.60	34.30	9.5	1	---	---	---	---	H	1.0
19496.16*	---	36.30	18.50	34.30	9.5	1	---	---	---	---	H	1.0
21933.18	---	36.20	19.20	34.60	9.5	1	---	---	---	---	H	1.0
24370.20	---	36.80	21.00	34.20	9.5	1	---	---	---	---	H	1.0

Note :

1. The measurement was searched to 10th harmonic, Remark "---" means that the emissions level is too low to be measured.
2. AF: Antenna Factor, Closs: Cable Loss, Pre-Amp: Preamp gain, Filter: High Pass Filter Insertion Loss (3.5GHz)
3. Analyzer setting P(Peak): RBW=1MHz, VBW=1MHz, A(Average): RBW=1MHz, VBW=10Hz
4. Remark "*" means that Restricted band.
5. The result basic equation calculation is as follow:
Level=Reading+AF+Closs-Preamp+Filter-Dist, Margin=Level-Limit
6. The other emission levels were very low against the limit
7. " * * " : Fundamental frequency
8. FOR G530 ANTENNA



Ecom Sertech Corp.

Rm. 258, Bldg. 17, 195 Sec. 4 Chung Hsing Rd.,
Chu-Tung Chen, Taiwan 310, R.O.C
TEL:886-3-5918012 FAX : 886-3-5825720

FCC ID : QDWWM168B

Report No. : ER03-04-030

Page 48 of 68

Test Requirement: 15.205

The frequency spectrum above 1 GHz was investigated. All emissions not reported below are more than 40 dB below the prescribed limits. Readings are both peak and average values.

Operation Mode:	Transmitting	Test Date :	2003/3/27
Fundamental Frequency:	2437MHz (CH 6)	Test By:	M.C. Huang
Temperature :	30 °C	Humidity :	65%

Freq.	Reading	AF	Closs	Pre-amp	Dist	Filter	Level	Limit	Margin	Mark	Pol.	Height
MHz	dBuV	dBuV	dB	dB	dB	dB	dBuV/m	dBuV/m	dB	P/Q/A	H/V	Meter
2437**	100.68	31.763	2.42	35.32	9.5	0	90.05			P	V	1.0
2437**	93.48	31.763	2.42	35.32	9.5	0	82.85			A	V	1.0
4874.24	50.08	34.77	2.80	35.40	9.5	1	43.75	74	-30.25	P	V	1.0
7309.51	43.70	39.78	4.00	35.57	9.5	1	43.41	74	-30.59	P	V	1.0
9748.73	50.01	38.53	4.02	35.72	9.5	1	48.33	74	-25.67	P	V	1.0
12185.10*	---	32.14	4.53	35.24	9.5	1	---	---	---	---	V	1.0
14622.12	---	43.40	16.80	34.00	9.5	1	---	---	---	---	V	1.0
17059.14	---	45.20	17.60	34.30	9.5	1	---	---	---	---	V	1.0
19496.16*	---	36.30	18.50	34.30	9.5	1	---	---	---	---	V	1.0
21933.18	---	36.20	19.20	34.60	9.5	1	---	---	---	---	V	1.0
24370.20	---	36.80	21.00	34.20	9.5	1	---	---	---	---	V	1.0

Note :

1. The measurement was searched to 10th harmonic, Remark “---” means that the emissions level is too low to be measured.
2. AF: Antenna Factor, Closs: Cable Loss, Pre-Amp: Preamp gain, Filter: High Pass Filter Insertion Loss (3.5GHz)
3. Analyzer setting P(Peak): RBW=1MHz, VBW=1MHz, A(Average): RBW=1MHz, VBW=10Hz
4. Remark “*” means that Restricted band.
5. The result basic equation calculation is as follow:
Level=Reading+AF+Closs-Preamp+Filter-Dist, Margin=Level-Limit
6. The other emission levels were very low against the limit
7. “ * * “ : Fundamental frequency
8. FOR G530 ANTENNA



Ecom Sertech Corp.

Rm. 258, Bldg. 17, 195 Sec. 4 Chung Hsing Rd.,
 Chu-Tung Chen, Taiwan 310, R.O.C
 TEL:886-3-5918012 FAX : 886-3-5825720

FCC ID : QDWWM168B

Report No. : ER03-04-030

Page 49 of 68

Test Requirement: 15.205

The frequency spectrum above 1 GHz was investigated. All emissions not reported below are more than 40 dB below the prescribed limits. Readings are both peak and average values.

Operation Mode:	Transmitting	Test Date :	2003/3/27
Fundamental Frequency:	2462MHz (CH 11)	Test By:	M.C. Huang
Temperature :	30 °C	Humidity :	65%

Freq.	Reading	AF	Closs	Pre-amp	Dist	Filter	Level	Limit	Margin	Mark	Pol.	Height
MHz	dBuV	dBuV	dB	dB	dB	dB	dBuV/m	dBuV/m	dB	P/Q/A	H/V	Meter
2462**	99.76	31.74	2.49	35.32	9.5	0	89.17			P	H	1.0
2462**	91.52	31.74	2.49	35.32	9.5	0	80.93			A	H	1.0
2483.7	48.74	31.72	2.55	35.33	9.5	0	38.18	74	-35.82	P	H	1.0
2483.7	43.12	31.72	2.55	35.33	9.5	0	32.56	54	-21.44	A	H	1.0
4924.16	49.28	35.10	2.83	35.41	9.5	1	43.30	74	-30.70	P	H	1.0
7386.42	43.93	39.75	4.06	35.57	9.5	1	43.66	74	-30.34	P	H	1.0
9848.64	49.32	38.52	3.93	35.77	9.5	1	47.50	74	-26.50	P	H	1.0
12310.04*	---	32.14	4.53	35.24	9.5	1	---	---	---	---	H	1.0
14772.06	---	43.40	16.80	34.00	9.5	1	---	---	---	---	H	1.0
17234.08	---	45.20	17.60	34.30	9.5	1	---	---	---	---	H	1.0
19696.1*	---	36.30	18.50	34.30	9.5	1	---	---	---	---	H	1.0
22158.12*	---	36.20	19.20	34.60	9.5	1	---	---	---	---	H	1.0
24620.14	---	36.80	21.00	34.20	9.5	1	---	---	---	---	H	1.0

Note :

1. The measurement was searched to 10th harmonic, Remark “---” means that the emissions level is too low to be measured.
2. AF: Antenna Factor, Closs: Cable Loss, Pre-Amp: Preamp gain, Filter: High Pass Filter Insertion Loss (3.5GHz)
3. Analyzer setting P(Peak): RBW=1MHz, VBW=1MHz, A(Average): RBW=1MHz, VBW=10Hz
4. Remark “*” means that Restricted band.
5. The result basic equation calculation is as follow:
 $Level = Reading + AF + Closs - Preamp + Filter - Dist$, $Margin = Level - Limit$
6. The other emission levels were very low against the limit
7. “ * * * ” : Fundamental frequency
8. FOR G530 ANTENNA



Ecom Sertech Corp.

Rm. 258, Bldg. 17, 195 Sec. 4 Chung Hsing Rd.,
Chu-Tung Chen, Taiwan 310, R.O.C
TEL:886-3-5918012 FAX : 886-3-5825720

FCC ID : QDWWM168B

Report No. : ER03-04-030

Page 50 of 68

Test Requirement: 15.205

The frequency spectrum above 1 GHz was investigated. All emissions not reported below are more than 40 dB below the prescribed limits. Readings are both peak and average values.

Operation Mode:	Transmitting	Test Date :	2003/3/27
Fundamental Frequency:	2462MHz (CH 11)	Test By:	M.C. Huang
Temperature :	30 °C	Humidity :	65%

Freq.	Reading	AF	Closs	Pre-amp	Dist	Filter	Level	Limit	Margin	Mark	Pol.	Height
MHz	dBuV	dBuV	dB	dB	dB	dB	dBuV/m	dBuV/m	dB	P/Q/A	H/V	Meter
2462**	100.85	31.74	2.49	35.32	9.5	0	90.26			P	V	1.0
2462**	93.45	31.74	2.49	35.32	9.5	0	82.86			A	V	1.0
2483.7	49.74	31.72	2.55	35.33	9.5	0	39.18	74	-34.82	P	V	1.0
2483.7	44.52	31.72	2.55	35.33	9.5	0	33.96	54	-20.04	A	V	1.0
4924.16	50.38	35.10	2.83	35.41	9.5	1	44.40	74	-29.60	P	V	1.0
7386.42	46.12	39.75	4.06	35.57	9.5	1	45.85	74	-28.15	P	V	1.0
9848.64	50.10	38.52	3.93	35.77	9.5	1	48.28	74	-25.72	P	V	1.0
12310.04*	---	32.14	4.53	35.24	9.5	1	---	---	---	---	V	1.0
14772.06	---	43.40	16.80	34.00	9.5	1	---	---	---	---	V	1.0
17234.08	---	45.20	17.60	34.30	9.5	1	---	---	---	---	V	1.0
19696.1*	---	36.30	18.50	34.30	9.5	1	---	---	---	---	V	1.0
22158.12*	---	36.20	19.20	34.60	9.5	1	---	---	---	---	V	1.0
24620.14	---	36.80	21.00	34.20	9.5	1	---	---	---	---	V	1.0

Note :

1. The measurement was searched to 10th harmonic, Remark “---” means that the emissions level is too low to be measured.
2. AF: Antenna Factor, Closs: Cable Loss, Pre-Amp: Preamp gain, Filter: High Pass Filter Insertion Loss (3.5GHz)
3. Analyzer setting P(Peak): RBW=1MHz, VBW=1MHz, A(Average): RBW=1MHz, VBW=10Hz
4. Remark “*” means that Restricted band.
5. The result basic equation calculation is as follow:
Level=Reading+AF+Closs-Preamp+Filter-Dist, Margin=Level-Limit
6. The other emission levels were very low against the limit
7. “ * * “ : Fundamental frequency
8. FOR G530 ANTENNA



Ecom Sertech Corp.

Rm. 258, Bldg. 17, 195 Sec. 4 Chung Hsing Rd.,
Chu-Tung Chen, Taiwan 310, R.O.C
TEL:886-3-5918012 FAX : 886-3-5825720

FCC ID : QDWWM168B
Report No. : ER03-04-030
Page 51 of 68

3.7 PHOTOS OF OPEN SITE

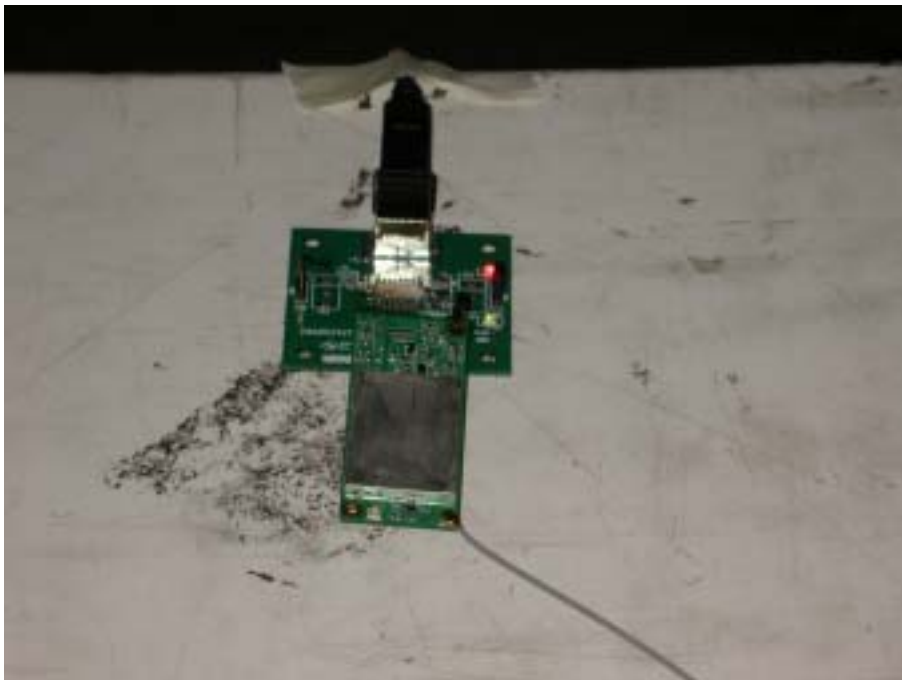

3.7 PHOTOS OF OPEN SITE





Ecom Sertech Corp.

Rm. 258, Bldg. 17, 195 Sec. 4 Chung Hsing Rd.,
Chu-Tung Chen, Taiwan 310, R.O.C
TEL:886-3-5918012 FAX : 886-3-5825720

FCC ID : QDWWM168B

Report No. : ER03-04-030

Page 53 of 68

3.7 PHOTOS OF OPEN SITE



4. 6dB BANDWIDTH MEASUREMENT

4.1 TEST EQUIPMENTS

Description & Manufacturer	Model No.	Serial No.	DATE OF CALIBRATION
ROHDE & SCHWARZ TEST RECEIVER	ESMI	842088/005 841978/008	SEPT. 3, 2002
HP ATTENUATOR	8496B	3247A18505	Cal. on use
HP PLOTTER	7750A	725A 852141	N/A

NOTE :

1. The measurement uncertainty is less than +/- 2.6dB, which is calculated as per the NAMAS document NIS81.
2. The calibration interval of the above test instruments is 12 months and the calibrations are traceable to NML/ROC and NIST/USA.

4.2 TEST SETUP

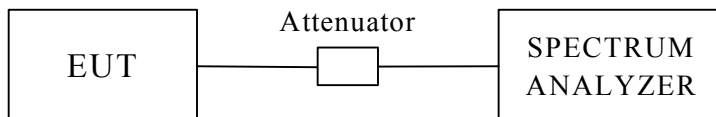

4.3 LIMITS OF 6dB BANDWIDTH MEASUREMENT

The minimum of 6dB Bandwidth Measurement is >500KHz

4.4 TEST PROCEDURE

The transmitter output was connected to the spectrum analyzer through an attenuator. The bandwidth of the fundamental frequency was measured by spectrum analyzer with 100 KHz RBW and 100 KHz VBW. The 6dB bandwidth is defined as the total spectrum the power of which is higher than peak power minus 6dB.



Ecom Sertech Corp.

Rm. 258, Bldg. 17, 195 Sec. 4 Chung Hsing Rd.,
Chu-Tung Chen, Taiwan 310, R.O.C
TEL:886-3-5918012 FAX : 886-3-5825720

FCC ID : QDWWM168B

Report No. : ER03-04-030

Page 55 of 68

4.5 UNCERTAINTY OF CONDUCTED EMISSION

The uncertainty of conducted emission is $\pm 200\text{KHz}$.

4.6 TEST RESULTS

EUT	802.11b WLAN USB Module	MODEL	WM168b
INPUT POWER (SYSTEM)	5VDC(From PC)	ENVIRONMENTAL CONDITIONS	27°C, 70%RH,
TESTED BY : M. C. Huang			

CHANNEL	CHANNEL FREQUENCY (MHz)	6dB BANDWIDTH (MHz)	MINIMUM LIMIT (MHz)	PASS / FAIL
1	2412	11.60	0.5	PASS
6	2437	12.13	0.5	PASS
11	2462	12.08	0.5	PASS



4.7 PHOTO OF 6DB BANDWIDTH MEASUREMENT

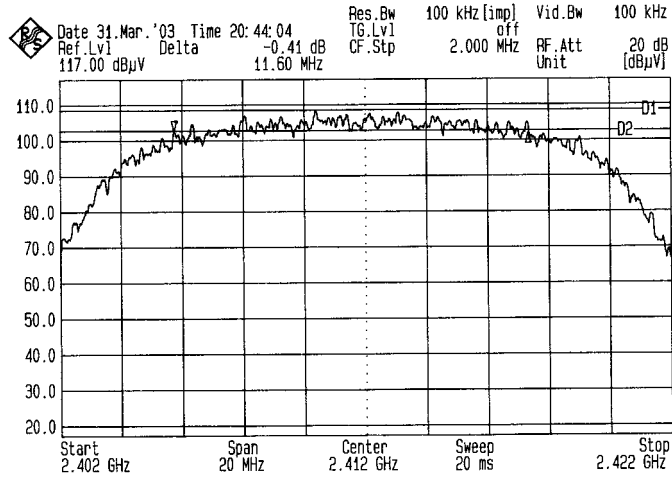

Channel 1

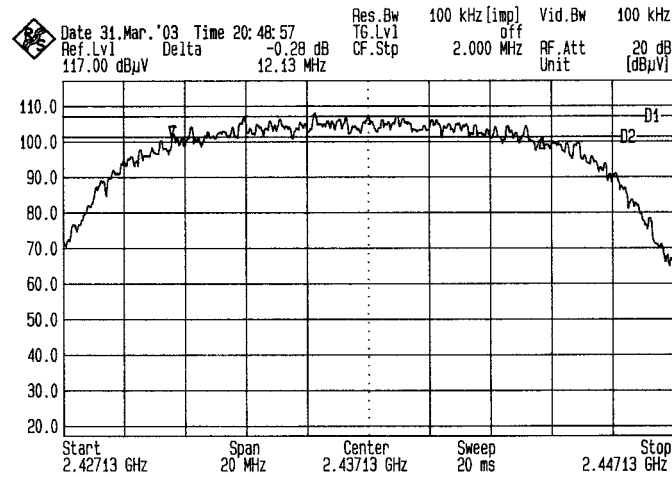

Channel 6

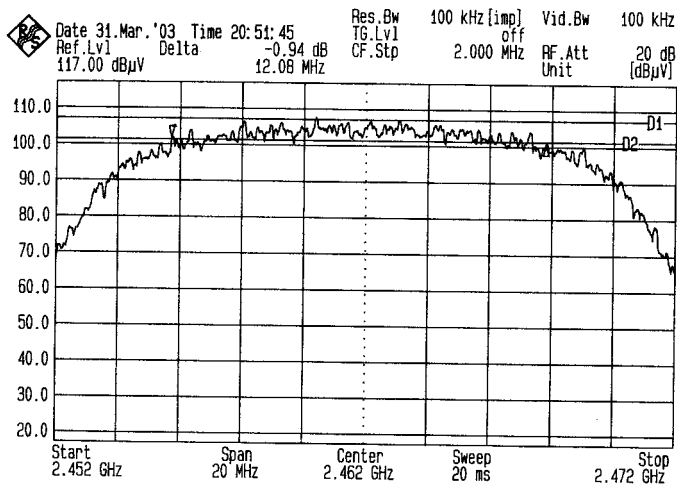

Channel 11

5. MAXIMUM PEAK OUTPUT POWER

5.1 TEST EQUIPMENTS

Description & Manufacturer	Model No.	Serial No.	DATE OF CALIBRATION
ROHDE & SCHWARZ TEST RECEIVER	ESMI	842088/005 841978/008	SEPT. 3, 2002
HP ATTENUATOR	8496B	3247A18505	Cal. on use
HP PLOTTER	7750A	725A 852141	N/A

NOTE :

1. The measurement uncertainty is less than +/- 2.6dB, which is calculated as per the NAMAS document NIS81.
2. The calibration interval of the above test instruments is 12 months and the calibrations are traceable to NML/ROC and NIST/USA.

5.2 TEST SETUP

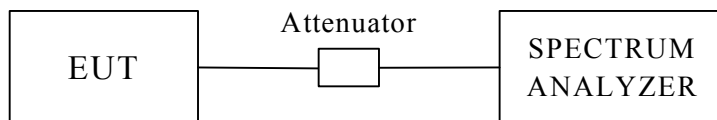

5.3 LIMITS OF MAXIMUM PEAK OUTPUT POWER

The Maximum Peak Output Power Measurement is 30dBm.



Ecom Sertech Corp.

Rm. 258, Bldg. 17, 195 Sec. 4 Chung Hsing Rd.,
Chu-Tung Chen, Taiwan 310, R.O.C
TEL:886-3-5918012 FAX : 886-3-5825720

FCC ID : QDWWM168B

Report No. : ER03-04-030

Page 58 of 68

5.4 TEST PROCEDURE

The RF power output was measured with a Power meter connected to the RF Antenna connector (conducted measurement) while EUT was operating in transmit mode at the appropriate center frequency.

5.5 UNCERTAINTY OF CONDUCTED EMISSION

The uncertainty of conducted emission is $\pm 1.82\text{dB}$.

5.6 TEST RESULTS

EUT	802.11b WLAN USB Module	MODEL	WM168b
INPUT POWER (SYSTEM)	5VDC(From PC)	ENVIRONMENTAL CONDITIONS	27°C, 70%RH,
TESTED BY : M. C. Huang			

CHANNEL	CHANNEL FREQUENCY (MHz)	PEAK POWER OUTPUT (dBm)	PEAK POWER LIMIT (dBm)	PASS / FAIL
1	2412	18.18	30	PASS
6	2437	18.02	30	PASS
11	2462	18.33	30	PASS

6. POWER SPECTRAL DENSITY MEASUREMENT

6.1 TEST EQUIPMENTS

Description & Manufacturer	Model No.	Serial No.	DATE OF CALIBRATION
ROHDE & SCHWARZ TEST RECEIVER	ESMI	842088/005 841978/008	SEPT. 3, 2002
HP ATTENUATOR	8496B	3247A18505	Cal. on use
HP PLOTTER	7750A	725A 852141	N/A

NOTE :

1. The measurement uncertainty is less than +/- 2.6dB, which is calculated as per the NAMAS document NIS81.
2. The calibration interval of the above test instruments is 12 months and the calibrations are traceable to NML/ROC and NIST/USA.

6.2 TEST SETUP

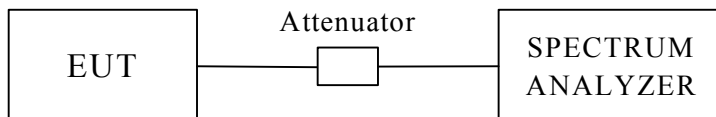

6.3 LIMITS OF POWER SPECTRAL DENSITY MEASUREMENT

The Maximum Power Spectral Density Measurement is 8dBm.



6.4 TEST PROCEDURE

The transmitter output was connected to the spectrum analyzer through an attenuator, the bandwidth of the fundamental frequency was measured with the spectrum analyzer using 3KHz RBW and 30KHz VBW, set sweep time=span / 3KHz.

The power spectral density was measured and recorded.

The sweep time is allowed to be longer than span / 3KHz for a full response of the mixer in the spectrum analyzer.

6.5 UNCERTAINTY OF CONDUCTED EMISSION

The uncertainty of conducted emission is ± 1.82 dB.

6.6 TEST RESULTS

EUT	802.11b WLAN USB Module	MODEL	WM168b
INPUT POWER (SYSTEM)	5VDC(From PC)	ENVIRONMENTAL CONDITIONS	27°C, 70%RH,
TESTED BY : M. C. Huang			

CHANNEL	CHANNEL FREQUENCY (MHz)	Final RF Power Level IN 3KHz BW (dBm)	MAXIMUM LIMIT (dBm)	PASS / FAIL
1	2412	-3.99	8	PASS
6	2437	-2.29	8	PASS
11	2462	-2.34	8	PASS

Note:

- 1.The measurement value of RF Power Level + 10dB attenuator=Final RF Power Level



Ecom Sertech Corp.

Rm. 258, Bldg. 17, 195 Sec. 4 Chung Hsing Rd.,
Chu-Tung Chen, Taiwan 310, R.O.C
TEL:886-3-5918012 FAX : 886-3-5825720

FCC ID : QDWWM168B

Report No. : ER03-04-030

Page 61 of 68

6.7 PHOTO OF POWER SPECTRAL DENSITY MEASUREMENT

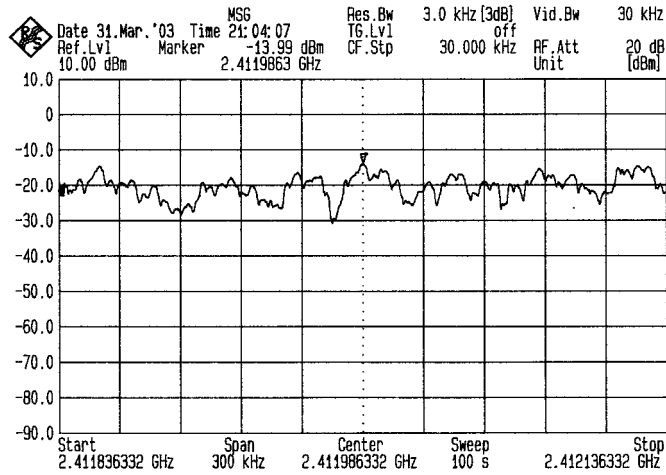

Channel 1

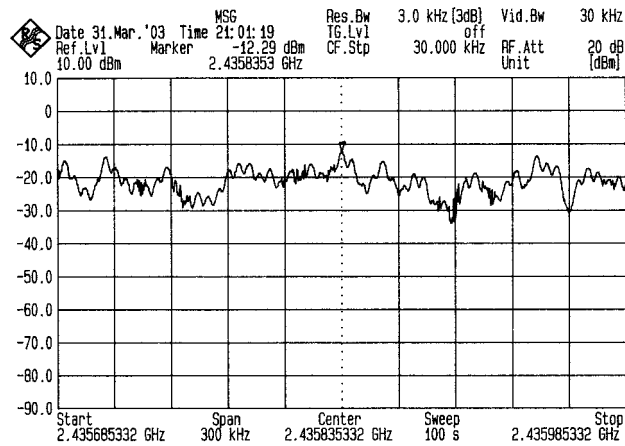

Channel 6

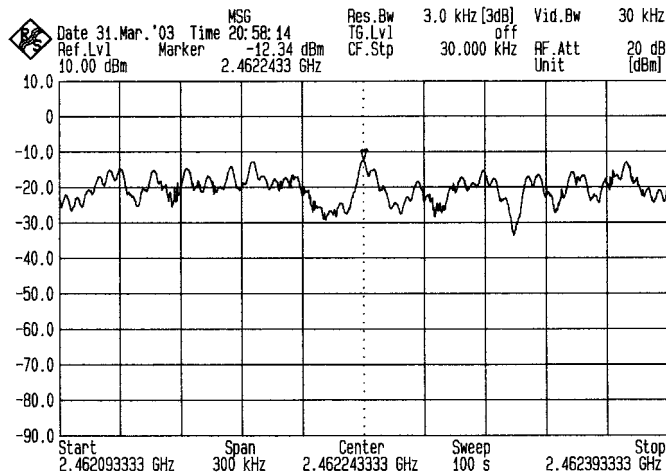

Channel 11

7. OUT OF BAND MEASUREMENT

7.1 TEST EQUIPMENTS

Description & Manufacturer	Model No.	Serial No.	DATE OF CALIBRATION
ROHDE & SCHWARZ TEST RECEIVER	ESMI	842088/005 841978/008	SEPT. 3, 2002
HP ATTENUATOR	8496B	3247A18505	Cal. on use
HP PLOTTER	7750A	725A 852141	N/A

NOTE :

- The measurement uncertainty is less than +/- 2.6dB, which is calculated as per the NAMAS document NIS81.
- The calibration interval of the above test instruments is 12 months and the calibrations are traceable to NML/ROC and NIST/USA.

7.2 TEST SETUP

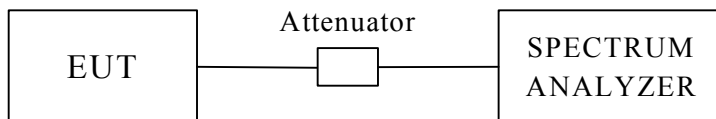

7.3 LIMITS OF OUT OF BAND EMISSIONS MEASUREMENT

- Below -20dB of the highest emission level of operating band (in 100KHz Resolution Bandwidth).
- Fall in the restricted bands listed in section 15.205. The maximum permitted average field strength is listed in section 15.209.



7.4 TEST PROCEDURE

The transmitter output was connected to the spectrum analyzer via a low lose cable. Set both RBW and VBW of spectrum analyzer to 100KHz with suitable frequency span including 100KHz bandwidth from band edge. The band edges was measured and recorded.

7.5 UNCERTAINTY OF CONDUCTED EMISSION

The uncertainty of conducted emission is ± 1.82 dB.

7.6 TEST RESULTS

A. Conducted

Refer to 7.7 photo of out band Emission measurement

B. Radiated

NOTE1: The band edge emission plot on the following first figure shows 52.87dB delta between carrier maximum power and local maximum emission in restrict band (2.3762GHz). The emission of carrier strength list in the test result of channel 1 at the item 3.6 is 84.59dBuV/m, so the maximum field strength in restrict band is $84.59-52.87=31.72$ dBuV/m which is under 54 dBuV/m limit.

NOTE2: The band edge emission plot on the following second figure shows 56.05dB delta between carrier maximum power and local maximum emission in restrict band (2.4824GHz). The emission of carrier strength list in the test result of channel 11 at the item 3.6 is 81.36dBuV/m, so the maximum field strength in restrict band is $81.36-56.05=25.31$ dBuV/m which is under 54 dBuV/m limit.

NOTE3:Antenna G736 is worse case. So it is only listed the G736 antenna in the test result.

EUT	802.11b WLAN USB Module	MODEL	WM168b
INPUT POWER (SYSTEM)	5VDC(From PC)	ENVIRONMENTAL CONDITIONS	27°C, 70%RH,
TESTED BY : M. C. Huang			

CHANNEL FREQUENCY (MHz)	Required Limit (dBc)	PASS / FAIL
<2400	>20	PASS
>2483.5	>20	PASS



7.7 PHOTO OF OUT OF BAND MEASUREMENT

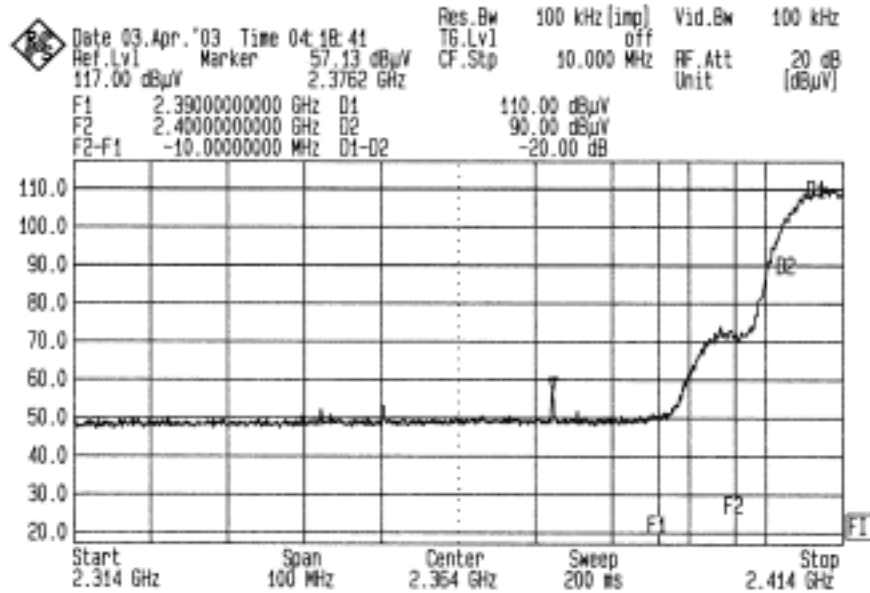

FRONT

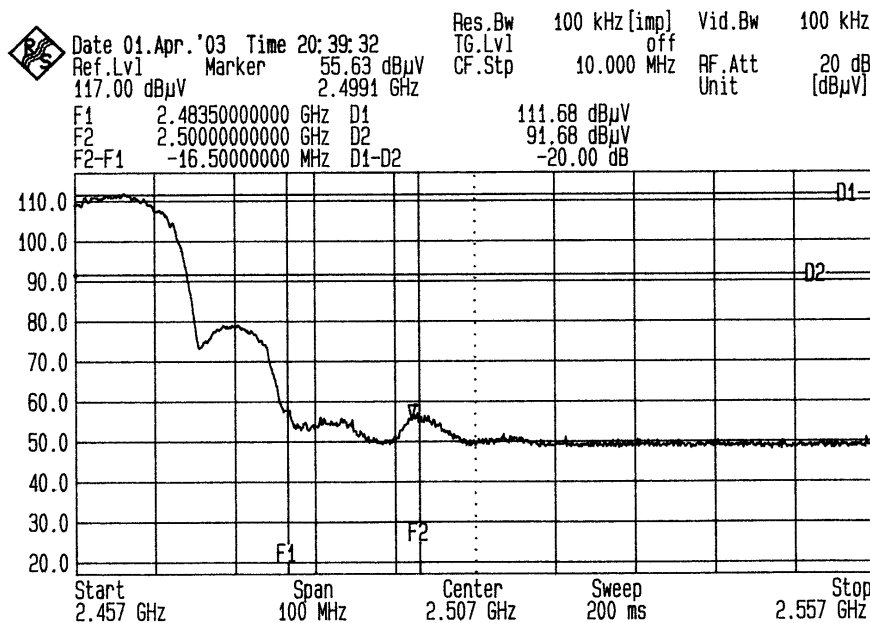

BACK



8. ANTENNA REQUIREMENT

8.1 STANDARD APPLICABLE

For intentional device, according to FCC 47 CFR Section 15.203, an intentional radiator shall be designed to ensure that no antenna other than that furnished by the responsible party shall be used with the device.

And according to FCC 47 CFR Section 15.247 (b), if transmitting antennas of directional gain greater than 6dBi are used, the power shall be reduced by the amount in dB that the directional gain of the antenna exceeds 2dBi.

8.2 ANTENNA CONNECTED CONSTRUCTION

The antenna used in this product is PIFA Antenna. The PIFA Antenna connector is MCXX
And the maximum Gain of these antennas are only 2.626dBi.

NOTE3:Antenna G736 is worse case. So some test items are only listed the G736 antenna in the test result.



9. RF EXPOSURE EVALUATION

According to FCC 1.1310 : The criteria listed in the following table shall be used to evaluate the environment impact of human exposure to radio frequency (RF) radiation as specified in 1.1307(b)
LIMITS FOR MAXIMUM PERMISSIBLE EXPOSURE (MPE)

Frequency Range (MHz)	Electric Field Strength (V/m)	Magnetic Field Strength (A/m)	Power Density (mW/cm ²)	Average Time
(A) Limits for Occupational / Control Exposures				
300-1,500	--	--	F/300	6
1,500-100,000	--	--	5	6
(B) Limits for General Population / Uncontrol Exposures				
300-1,500	--	--	F/1500	6
1,500-100,000	--	--	1	30

9.1 FRIIS FORMULA

Friis transmission formula : $Pd = (Pout * G) / (4 * \pi * r^2)$

Where

Pd = power density in mW/cm²

Pout = output power to antenna in mW

G = gain of antenna in linear scale

Pi = 3.1416

R = distance between observation point and center of the radiator in cm

Pd is the limit of MPE, 1 mW/cm². If we know the maximum gain of the antenna and the total power input to the antenna, through the calculation, we will know the distance r where the MPE limit is reached.

9.2 EUT OPERATING CONDITION

A software provided by client enabled the EUT to transmit and receive data at lowest, middle and highest channel individually.



9.3 TEST RESULT OF RF EXPOSURE EVALUATION

Test Item : RF Exposure Evaluation Data

Test Mode : Normal Operation

9.3.1 ANTENNA GAIN

Antenna Gain : The maximum Gain measured in fully anechoic chamber is 2dBi linear scale.

9.3.2 OUTPUT POWER INTO ANTENNA & RF EXPOSURE EVALUATION DISTANCE

Channel	Channel Frequency (MHz)	Output Power to Antenna (dBm)	Power density in mW/cm ² at Friis formula when r=20cm(mW/cm ²)	LIMITS
CH1	2412.00	18.18	0.006135	1
CH6	2437.00	18.02	0.005913	1
CH11	2462.00	18.33	0.006351	1

NOTE:FOR A982 Antenna , Antenna Gain is -3.289 dBi

Channel	Channel Frequency (MHz)	Output Power to Antenna (dBm)	Power density in mW/cm ² at Friis formula when r=20cm(mW/cm ²)	LIMITS
CH1	2412.00	18.18	0.010405	1
CH6	2437.00	18.02	0.010028	1
CH11	2462.00	18.33	0.010770	1

NOTE:FOR G530 Antenna , Antenna Gain is -0.995 dBi

Channel	Channel Frequency (MHz)	Output Power to Antenna (dBm)	Power density in mW/cm ² at Friis formula when r=20cm(mW/cm ²)	LIMITS
CH1	2412.00	18.18	0.023951	1
CH6	2437.00	18.02	0.023085	1
CH11	2462.00	18.33	0.022947	1

NOTE:FOR G736 Antenna , Antenna Gain is 2.626 dBi



Ecom Sertech Corp.

Rm. 258, Bldg. 17, 195 Sec. 4 Chung Hsing Rd.,
Chu-Tung Chen, Taiwan 310, R.O.C
TEL:886-3-5918012 FAX : 886-3-5825720

FCC ID : QDWWM168B

Report No. : ER03-04-030

Page 68 of 68

Channel	Channel Frequency (MHz)	Output Power to Antenna (dBm)	Power density in mW/cm ² at Friis formula when r=20cm(mW/cm ²)	LIMITS
CH1	2412.00	18.18	0.023000	1
CH6	2437.00	18.02	0.022168	1
CH11	2462.00	18.33	0.023808	1

NOTE:FOR A530 Antenna , Antenna Gain is 2.45 dBi

The power density Pd (4th column) at a distance of 20cm calculated from the Friis transmission formula is far below the limit of 1 mW/cm² . So, RF exposure limit warning or SAR test are not required.