



## ELECTROMAGNETIC COMPATIBILITY TEST REPORT

Company : AirVast Technology Inc.  
Address : 4F-1, No. 1, Ln. 21, Hsin Hua Rd., Kueishan Industrial Park,  
Taoyuan 330, Taiwan, R.O.C.  
Product name : 802.11b WLAN Router  
Model name : WR2000  
Date Received : DEC. 25, 2002  
Date Tested : DEC. 27-31, 2002

### MEASUREMENT REQUIREMENT USED :

47 CFR Part 15, Subpart B and Subpart C (Section 15.247),  
ANSI C63.4-1992

WE HEREBY CERTIFY THAT: The measurements shown in the attachment were made in accordance with the procedures indicated, and the energy emitted by the equipment was found to be within the limits applicable. We assume full responsibility for the accuracy and completeness of these measurements and vouch for the qualifications of all persons taking them.

	Name	Signature	Date
Testing Engineer	M. C. Huang/NVLAP	<i>M. C. Huang</i>	<i>Dec. 31, 2002</i>
Approving Manager	C. F. Wu/NVLAP	<i>C. F. Wu</i>	<i>Dec. 31, 2002</i>

### Notes :

1. This report will be invalid if duplicated or photocopied in part.
2. This report refers only to the specimen(s) submitted to test, and is invalid as separately used.
3. This report is invalid without examination stamp and signature of this institute.
4. The tested specimen(s) will be preserved for thirty days from the data issued.
5. The report must not be used to claim product certification, approval, or endorsement by NVLAP, NIST, or any agency of the federal government.



## TABLE OF CONTENTS

TITLE	PAGE NO.
1. GENERAL INFORMATION .....	4
1.1 GENERAL STATEMENT .....	4
1.2 GENERAL DESCRIPTION OF EUT & POWER .....	4
1.3 DESCRIPTION OF PERIPHERALS .....	5-6
1.4 EUT & PERIPHERALS SETUP DIAGRAM .....	7
1.5 EUT OPERATING CONDITION .....	7
1.6 DESCRIPTION OF TEST SITE .....	8
1.7 SUMMARY OF TEST RESULTS .....	8
2. CONDUCTED POWERLINE TEST .....	9
2.1 TEST EQUIPMENTS .....	9
2.2 TEST SETUP .....	9
2.3 CONDUCTED POWER LINE EMISSION LIMIT .....	10
2.4 TEST PROCEDURE .....	10
2.5 UNCERTAINTY OF CONDUCTED EMISSION .....	10
2.6 CONDUCTED RF VOLTAGE MEASUREMENT .....	11-12
2.7 PHOTOS OF CONDUCTION TEST .....	13
3. RADIATED EMISSION TEST .....	14
3.1 TEST EQUIPMENTS .....	14
3.2 TEST SETUP .....	14
3.3 RADIATION LIMIT .....	15
3.4 TEST PROCEDURES .....	16
3.5 UNCERTAINTY OF RADIATED EMISSION .....	16
3.6 RADIATED RF NOISE MEASUREMENT .....	17-25
3.7 PHOTOS OF OPEN SITE .....	26-27
4. 6dB BANDWIDTH MEASUREMENT .....	28
4.1 TEST EQUIPMENTS .....	28
4.2 TEST SETUP .....	28
4.3 LIMITS OF 6dB BANDWIDTH MEASUREMENT .....	28
4.4 TEST PROCEDURE .....	28
4.5 UNCERTAINTY OF CONDUCTED EMISSION .....	28
4.6 TEST RESULTS .....	29
4.7 PHOTO OF 6DB BANDWIDTH MEASUREMENT .....	30
5. MAXIMUM PEAK OUTPUT POWER .....	31
5.1 TEST EQUIPMENTS .....	31
5.2 TEST SETUP .....	31
5.3 LIMITS OF MAXIMUM PEAK OUTPUT POWER .....	31
5.4 TEST PROCEDURE .....	32
5.5 UNCERTAINTY OF CONDUCTED EMISSION .....	32
5.6 TEST RESULTS .....	32



---

6. POWER SPECTRAL DENSITY MEASUREMENT .....	33
6.1 TEST EQUIPMENTS .....	33
6.2 TEST SETUP .....	33
6.3 LIMITS OF POWER SPECTRAL DENSITY MEASUREMENT .....	33
6.4 TEST PROCEDURE .....	34
6.5 UNCERTAINTY OF CONDUCTED EMISSION .....	34
6.6 TEST RESULTS .....	34
6.7 PHOTO OF POWER SPECTRAL DENSITY MEASUREMENT .....	35
7. OUT OF BAND MEASUREMENT .....	36
7.1 TEST EQUIPMENTS .....	36
7.2 TEST SETUP .....	36
7.3 LIMITS OF OUT OF BAND EMISSIONS MEASUREMENT .....	36
7.4 TEST PROCEDURE .....	37
7.5 UNCERTAINTY OF CONDUCTED EMISSION .....	37
7.6 TEST RESULTS .....	37
7.7 PHOTO OF OUT OF BAND MEASUREMENT .....	38
8. ANTENNA REQUIREMENT .....	39
8.1 STANDARD APPLICABLE .....	39
8.2 ANTENNA CONNECTED CONSTRUCTION .....	39
9. RF EXPOSURE EVALUATION .....	40
9.1 FRIIS FORMULA .....	40
9.2 EUT OPERATING CONDITION .....	40
9.3 TEST RESULT OF RF EXPOSURE EVALUATION .....	41
9.3.1 ANTENNA GAIN .....	41
9.3.2 OUTPUT POWER INTO ANTENNA & RF EXPOSURE EVALUATION DISTANCE .....	41



## 1. GENERAL INFORMATION

### 1.1 GENERAL STATEMENT

MEASUREMENT DEVIATION : Comply with standard in full

TRACEABILITY : This test result is traceable to national or international std.

### 1.2 GENERAL DESCRIPTION OF EUT & POWER

MANUFACTURER : AirVast Technology Inc.

SAMPLE NAME : 802.11b WLAN Router

MODEL NAME : WR2000

FREQUENCY RANGE : 2412 MHz TO 2462MHz

CHANNEL NUMBER : 11

AIR DATA RATE : 11Mbps (Highest Mode)

TYPE OF MODULATION : DIRECT SEQUENCE SPREAD SPECTRUM

FEQUENCY SELECTION : BY SOFTWARE

EUT Description : 2.4GHz Direct Sequence Spread Spectrum Data Transceiver  
for 11Mbps 802.11b WLAN Router

ANTENNA TYPE : 1/2 $\lambda$  Dipole ANTENNA

POWER ADAPTER :

#### Adapter(1)

Manufacturer : FAIRWAY ELECTRONICS CO.,LTD.

Model Number : TC10A-050

Input Power : 100-240VAC / 50~60Hz

Output Power : 5VDC / 2A

#### Adapter(2)

Manufacturer : LEI ELECTRONICS CO.,LTD.

Model Number : MU15-050200-A1

Input Power : 100-240VAC / 50~60Hz

Output Power : 5VDC / 2A



### 1.3 DESCRIPTION OF PERIPHERALS

#### (1) PC

MANUFACTURER : HP CORP.  
MODEL NUMBER : VECTRA VEI8DT  
SERIAL NUMBER : SG1202412  
F.C.C. : DOC

#### (2) PC

MANUFACTURER : HP CORP.  
MODEL NUMBER : VECTRA VEI8DT  
SERIAL NUMBER : SG1202415  
F.C.C. : DOC

#### (3) Notebook PC

MANUFACTURER : DELL CORP.  
MODEL NUMBER : PP01L  
SERIAL NUMBER : CN-09C748-48155-1AP-6081  
F.C.C. : DOC  
POWER CORD : Unshielded, Detachable, 1.8m

#### (4) Notebook PC

MANUFACTURER : DELL CORP.  
MODEL NUMBER : PP01L  
SERIAL NUMBER : CN-09C748-48155-1AP-6630  
F.C.C. : DOC  
POWER CORD : Unshielded, Detachable, 1.8m

#### (5) MONITOR

MODEL NUMBER : D8894A  
SERIAL NUMBER : CN00905269  
MANUFACTURER : HP CORP.  
F.C.C. ID : ARSCM356N  
POWER CORD : Unshielded , Detachable , 1.8m

#### (6) KEYBOARD

MODEL NUMBER : K288  
SERIAL NUMBER : 206628619  
MANUFACTURER : Genuine Company INC.  
F.C.C. ID : FKD46AK288  
SIGNAL CABLE : Shielded , Undetachable , 1.8m  
POWER SOURCE : 5VDC (from PC)



**(7) MOUSE**

MODEL NUMBER : M-S34  
SERIAL NUMBER : LZE95050431  
MANUFACTURER : HP CORP.  
FCC ID : DZL211029  
SIGNAL CABLE : Shielded , Undetachable , 1.8m  
POWER SOURCE : 5VDC (from PC)

**(8) MONITOR**

MODEL NUMBER : D8894A  
SERIAL NUMBER : CN00905251  
MANUFACTURER : HP CORP.  
F.C.C. ID : ARSCM356N  
POWER CORD : Unshielded , Detachable , 1.8m

**(9) KEYBOARD**

MODEL NUMBER : K288  
SERIAL NUMBER : 206628620  
MANUFACTURER : Genuine Company INC.  
F.C.C. ID : FKD46AK288  
SIGNAL CABLE : Shielded , Undetachable , 1.8m  
POWER SOURCE : 5VDC (from PC)

**(10) MOUSE**

MODEL NUMBER : M-S34  
SERIAL NUMBER : LZE95050437  
MANUFACTURER : HP CORP.  
FCC ID : DZL211029  
SIGNAL CABLE : Shielded , Undetachable , 1.8m  
POWER SOURCE : 5VDC (from PC)

**(11) CABLE**

	Type	Connector	shielded	Length
(A)	Cat5 twisted-pair	RJ-45,Plastic	NO	15m



## 1.4 EUT & PERIPHERALS SETUP DIAGRAM

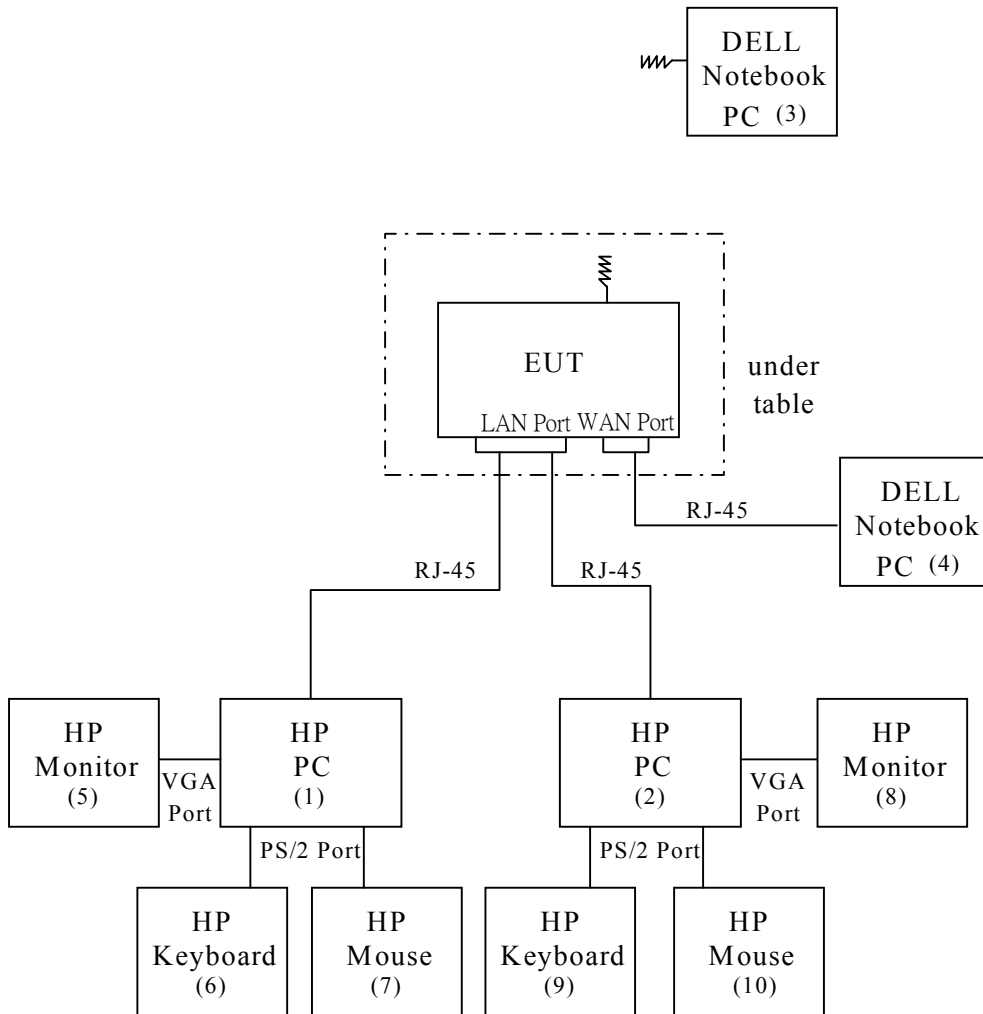

## 1.5 EUT OPERATING CONDITION

1. Set up all computers like the setup diagram.
2. NB(4) ping 192.168.62.1 -t to EUT
3. PC(1) contained EUT ping 192.168.1.80 -t to PC(2)
4. NB(3) contained EUT ping 192.168.1.80 -t to EUT
5. All of the function are under run.
6. Start test.



## 1.6 DESCRIPTION OF TEST SITE

SITE DESCRIPTION : FCC certificate NO. : 31040/SIT  
 TUV certificate NO. : I9664582-9911  
 BSMI certificate NO. : SL2-IN-E-0002  
 NVLAP Lab code : 200118-0  
 CNLA certificate NO. : CNLA-ZL97018  
 VCCI certificate NO. : R-1189, C-1250

NAME OF SITE : Electronics Research & Service Organization  
 Industrial Technology Research Institute

SITE LOCATION : R1500, 195-4 , sec. 4, Chung Hsing Rd., Chu-Tung Chen.  
 Hsin-Chu, Taiwan 310 R.O.C.

## 1.7 SUMMARY OF TEST RESULTS

The EUT has been tested according to the following specifications :

APPLIED STANDARD : 47 CFR Part 15, Subpart B and Subpart C			
Standard Section	Test Type and Limit	Result	REMARK
15.107 15.207	AC Power Conducted Emission Limit : 48dBuV	PASS	Meet the requirement of limit
15.247(a)(2)	Spectrum Bandwidth of a Direct Sequence Spread Spectrum System Limit : 6dB bandwidth > 500KHz	PASS	Meet the requirement of limit
15.247(b)	Maximum Peak Output Power Limit : max. 30dBm	PASS	Meet the requirement of limit
15.109 15.205 15.209	Transmitter Radiated Emissions Limit : Table 15.209	PASS	Meet the requirement of limit
15.247(d)	Power Spectral Density Limit : max. 8dBm	PASS	Meet the requirement of limit
15.247(c)	Out of Band Emission and Restricted Band Radiation Limit:20dB less than peak value of fundamental frequency Restricted band Limit:Table 15.209	PASS	Meet the requirement of limit





## 2. CONDUCTED POWERLINE TEST

### 2.1 TEST EQUIPMENTS

The following test equipments are used during the conducted powerline tests :

MANUFACTURER OR TYPE	MODEL No	SERIAL NO.	DATE OF CALIBRATION	CALIBRATION PERIOD	REMARK
SPECTRUM ANALYZER & DISPLAY	HP 8568A	2235A02320	APR. 01, 2002	1 Year	PRETEST
QUASI-PEAK ADAPTER	HP 85650 A	2341A00672	APR. 01, 2002	1 Year	PRETEST
ISOLATION TRANSFORMER	SOLAR 7032-1	N/A	N/A	N/A	FINAL
L.I.S.N.	EMCO 3850/2	9311-1025 9401-1028	JAN. 08, 2002 For Characteristic impedance MAY 18, 2002 For Insertion loss	1 Year	FINAL
TEST RECEIVER	R/S ESHS30	838550/003	JUN. 07, 2002	1 Year	FINAL
SHIELDED ROOM	KEENE 5983	NO.1	N/A	N/A	FINAL
PULSE LIMIT	R/S EHS3Z2	357.8810.52	JUL. 10, 2002	1 Year	FINAL
N TYPE COAXIAL CABLE	-----	-----	JUL. 10, 2002	1 Year	FINAL
50Ω TERMINATOR	-----	-----	JUL. 10, 2002	1 Year	FINAL

### 2.2 TEST SETUP

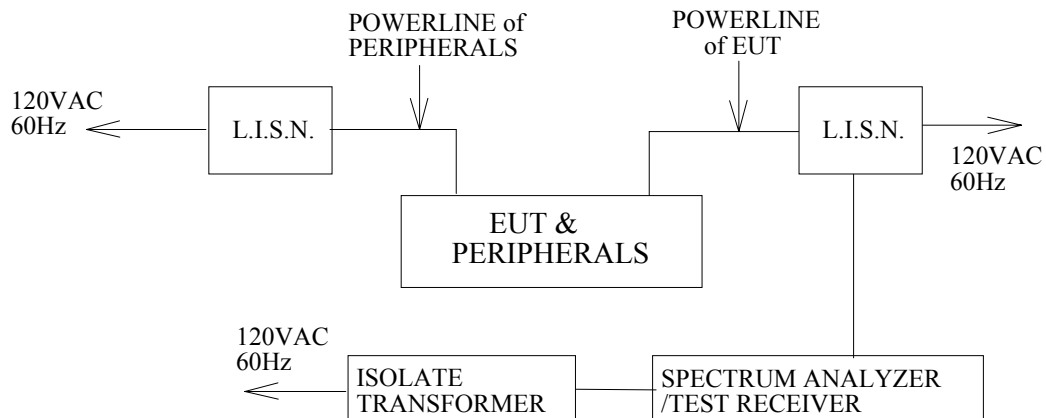



## 2.3 CONDUCTED POWER LINE EMISSION LIMIT

For unintentional device, according to § 15.107(a) Line Conducted Emission Limits is as following :

FREQUENCY (MHz)	MAXIMUM RF LINE VOLTAGE (dB $\mu$ V)			
	CLASS A		CLASS B	
	Q.P.	Ave.	Q.P.	Ave.
0.15 - 0.50	79	66	66-56	56-46
0.50 - 5.00	73	60	56	46
5.00 - 30.0	73	60	60	50

For intentional device, according to § 15.207(a) Line Conducted Emission Limit is same as above table.

## 2.4 TEST PROCEDURE

The test procedure is performed in a 12ft $\times$  12ft $\times$  8ft(L $\times$  W $\times$  H) shielded room. the EUT along with its peripherals were placed on a 1.0m(W) $\times$  1.5m(L) and 0.8m in height wooden table and the EUT was adjusted to maintain a 0.4 meter space from a vertical reference plane. The EUT was connected to power mains through a line impedance stabilization network (LISN) which provides 50 ohm coupling impedance for measuring instrument and the chasis ground was bounded to the horizontal ground plane of shielded room. All peripherals were connected to the second LISN and the chasis ground also bounded to the horizontal ground plane of shielded room. The excess power cable between the EUT and the LISN was bundled. The power cables of peripherals were unbundled. All connecting cables of EUT and peripherals were moved to find the maximum emission.

## 2.5 UNCERTAINTY OF CONDUCTED EMISSION

The uncertainty of conducted emission is  $\pm 1.36$ dB.



## 2.6 CONDUCTED RF VOLTAGE MEASUREMENT

The frequency spectrum from 0.15 MHz to 30 MHz was investigated. All emissions not reported below are more than 20 dB below the prescribed limits.

Temperature : 26 °C

Humidity : 65 % RH

FREQUENCY (MHz)	READING(dB $\mu$ V)				LIMITS (dB $\mu$ V)	
	ONE END & GRD'D		THE OTHER END & GRD'D		Q.P.	Ave.
	Q.P.	Ave.	Q.P.	Ave.		
0.150	*	*	*	*	66.00	56.00
0.171	48.5	*	*	*	64.80	54.80
0.174	*	*	50.3	*	60.20	50.20
0.309	42.8	*	44.1	*	58.20	48.20
0.573	*	*	32.5	*	56.00	46.00
1.056	30.6	*	*	*	56.00	46.00
1.185	32.1	*	*	*	56.00	46.00
1.581	*	*	33.8	*	56.00	46.00
2.481	*	*	33.5	*	56.00	46.00
2.484	*	*	35.6	*	56.00	46.00
4.305	*	*	27.4	*	56.00	46.00
7.917	34.3	*	*	*	60.00	50.00
11.952	*	*	39.2	*	60.00	50.00
12.015	40.2	*	*	*	60.00	50.00
16.497	*	*	37.1	*	60.00	50.00
16.824	41.7	*	*	*	60.00	50.00
30.000	*	*	*	*	60.00	50.00

REMARKS : 1. \* Undetectable or the Q.P. value is lower than the limits of Ave.

2. From Adapter(1)



## 2.6 CONDUCTED RF VOLTAGE MEASUREMENT

The frequency spectrum from 0.15 MHz to 30 MHz was investigated. All emissions not reported below are more than 20 dB below the prescribed limits.

Temperature : 26 °C

Humidity : 65 % RH

FREQUENCY (MHz)	READING(dB $\mu$ V)				LIMITS	
	ONE END & GRD'D		THE OTHER END & GRD'D		(dB $\mu$ V)	
	Q.P.	Ave.	Q.P.	Ave.	Q.P.	Ave.
0.150	*	*	*	*	66.00	56.00
0.159	43.4	*	*	*	64.80	54.80
0.162	*	*	44.9	*	60.20	50.20
0.381	40.9	*	*	*	58.20	48.20
0.546	41.4	*	*	*	56.00	46.00
1.047	*	*	28.0	*	56.00	46.00
1.236	41.0	*	*	*	56.00	46.00
1.251	*	*	41.1	*	56.00	46.00
2.439	35.8	*	*	*	56.00	46.00
2.454	*	*	37.8	*	56.00	46.00
4.179	*	*	33.0	*	56.00	46.00
4.599	29.1	*	*	*	56.00	46.00
8.022	26.9	*	*	*	60.00	50.00
8.259	*	*	19.6	*	60.00	50.00
16.737	*	*	22.5	*	60.00	50.00
22.449	22.5	*	*	*	60.00	50.00
16.815	*	*	32.1	*	60.00	50.00

REMARKS : 1. \* Undetectable or the Q.P. value is lower than the limits of Ave.

2. From Adapter(2)



## 2.7 PHOTOS OF CONDUCTION TEST





### 3. RADIATED EMISSION TEST

#### 3.1 TEST EQUIPMENTS

The following test equipments are utilized in making the measurements contained in this report.

MANUFACTURER OR TYPE	MODEL NO	SERIAL NO	DATE OF CALIBRATION	CALIBRATION PERIOD	REMARK
CHASE BI-LOG ANTENNA	CBL6112B	2421	MAY 07, 2002	1 Year	FINAL
R/S TEST RECEIVER	ESMI	842088/005 841978/008	SEPT. 3, 2002	1 Year	FINAL
OPEN SITE	-----	No.1	JUL. 10~12, 2002	1 Year	FINAL
N TYPE COAXIAL CABLE	CHA9525	4	JUL. 13, 2002	1 Year	FINAL
Horn Antenna	AH-118	10089	FEB. 25, 2002	1 Year	FINAL
HP Pre-amplifier	8449B	3008A01471	OCT. 11, 2002	1 Year	FINAL
HP High pass filter	84300/80038	011	cal. on use	1 Year	FINAL
Horn Antenna	AH-840	03077	FEB. 25, 2002	1 Year	FINAL

#### 3.2 TEST SETUP

The diagram below shows the test setup which is utilized to make these measurements.

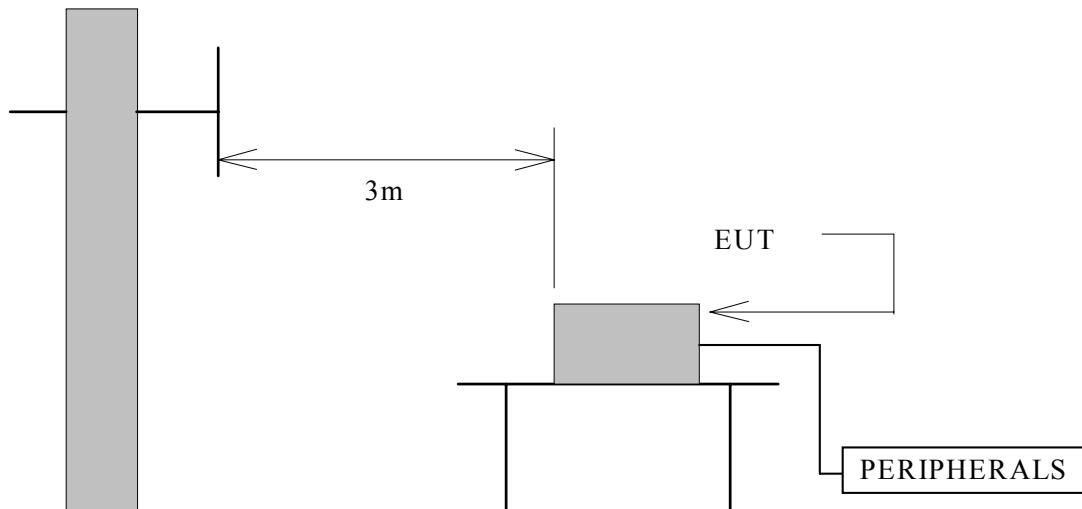

Antenna Elevation Variable



### 3.3 RADIATION LIMIT

For unintentional device, according to § 15.109(a), except for Class A digital devices, the field strength of radiated emissions from unintentional radiators at a distance of 3 meters shall not exceed the following values :

FREQUENCY (MHz)	DISTANCE (METERS)	Radiated (dB $\mu$ V/M)	Radiated ( $\mu$ V/M)
30-88	3	40.0	100
88-216	3	43.5	150
216-960	3	46.0	200
Above 960	3	54.0	500

For intentional device, according to § 15.209(a), the general requirement of field strength of radiated emissions from intentional radiators at a distance of 3 meters shall not exceed the above table.



### 3.4 TEST PROCEDURES

- a. The EUT was placed on the top of a rotating table 0.8 meters above the ground at a 10 meter open area test site. The table was rotated 360 degrees to determine the position of the highest radiation.
- b. The EUT was set 3 meters away from the interference-receiving antenna, which was mounted on the top of a variable-height antenna tower.
- c. The antenna is a broadband antenna, and its height is varied from one meter to four meters above the ground to determine the maximum value of the field strength. Both horizontal and vertical polarization of the antenna are set to make the measurement.
- d. For each suspected emission, the EUT was arranged to its worst case and then the antenna was tuned to heights from 1 meter to 4 meters and the rotatable table was turned from 0 degrees to 360 degrees to find the maximum reading.
- e. The test-receiver system was set to Peak Detect Function and Specified Bandwidth with Maximum Hold Mode.
- f. If the emission level of the EUT in peak mode was 10 dB lower than the limit specified, then testing could be stopped and the peak values of the EUT would be reported. Otherwise the emissions that did not have 10 dB margin would be re-tested one by one using peak, quasi-peak or average method as specified and then reported in a data sheet.

NOTE :

1. The resolution bandwidth and video bandwidth of test receiver/spectrum analyzer is 120 KHz for Peak detection (PK) and Quasi-peak detection (QP) at frequency below 1GHz.
2. The resolution bandwidth and video bandwidth of test receiver/spectrum analyzer is 1 MHz for Peak detection and frequency above 1GHz.
3. The resolution bandwidth of test receiver/spectrum analyzer is 1 MHz and the video bandwidth is 10 Hz for Average detection (AV) at frequency above 1GHz.

### 3.5 UNCERTAINTY OF RADIATED EMISSION

The uncertainty of radiated emission is  $\pm 2.72$ dB.





### 3.6 RADIATED RF NOISE MEASUREMENT

Test Requirement: 15.109, 15.209

The frequency spectrum from 30 MHz to 1000 MHz was investigated. All emissions not reported below are more than 20 dB below the prescribed limits.

All readings are quasi-peak values.

Temperature : 25 °C

Humidity : 65 % RH

FREQ- UENCY (MHz)	ANTENNA FACTOR (dB)	CABLE LOSS (dB)	METER READING AT3m(dB $\mu$ V/M)		LIMITS (dB $\mu$ V/M)	EMISSION LEVEL AT3m(dB $\mu$ V/M)	
			HORIZON- TAL	VERTICA- L		HORIZON- TAL	VERTICA- L
30.00	18.96	0.90	*	*	40.00	*	*
125.00	12.61	2.20	19.50	20.20	43.50	34.31	35.01
149.99	11.85	2.40	25.80	27.60	43.50	40.05	41.85
199.99	10.85	2.60	23.20	30.00	43.50	36.65	43.45
249.99	13.22	3.10	25.80	27.20	46.00	42.12	43.52
299.99	15.68	3.30	27.80	19.20	46.00	44.32	35.72
349.99	17.41	3.60	22.70	18.70	46.00	41.98	37.98
399.99	18.58	3.90	20.70	15.10	46.00	42.01	36.41
499.99	19.42	4.30	18.90	16.90	46.00	41.78	39.78
599.99	19.45	4.50	18.90	21.80	46.00	42.82	45.72
649.99	20.58	4.95	14.30	12.90	46.00	38.70	37.30
699.99	19.80	5.40	22.00	20.20	46.00	44.81	43.01
749.99	20.12	5.45	14.30	11.60	46.00	38.33	35.63
799.99	20.35	5.50	16.20	16.30	46.00	41.12	41.22
849.99	20.58	5.55	19.80	19.20	46.00	44.80	44.20
899.99	21.18	5.60	15.70	12.70	46.00	41.88	38.88
949.99	21.79	6.00	17.80	17.20	46.00	44.98	44.38
1000.00	21.79	6.40	*	*	54.00	*	*

REMARKS : 1. \* Undetectable

2. Emission level (dB  $\mu$  V/M) = Antenna Factor (dB/m) + Cable loss (dB)  
 + Meter Reading (dB  $\mu$  V).

3. According to technical experiences, all spurious emission at channel 1,6,11 are almost the same below 1GHz, so that the channel 1 was chosen as representation for the test.

4. Power adapter(1) is the worse case of all power adapter.



Test Requirement: 15.109 ,15.209

The frequency spectrum above 1 GHz was investigated. All emissions not reported below are more than 40 dB below the prescribed limits. Readings are both peak and average values.

RX		Test Date : 2002/9/26										
		Test By: M.C. Huang										
Temperature:		Humidity : 27C,65%										
CH1-RX MODE												
Freq.	Reading	AF	Closs	Pre-amp	Dist	Filter	Level	Limit	Margin	Mark	Pol	Height
(MHz)	(dBuV)	(dBuV)	(dB)	(dB)	dB	dB	(dBuV/m)	FCC_B	(dB)	(P/Q/A)	(H/V)	(Meter)
2037.84	46.5	32.16	1.37	35.24	9.5	1	36.29	54	-17.71	A	H	1.0
4075.4	56.4	32.55	2.98	35.19	9.5	1	48.25	74	-25.75	P	H	1.0
4075.4	50.8	32.55	2.98	35.19	9.5	1	42.65	54	-11.35	A	H	1.0
6114.5	42.3	37.33	4.93	35.53	9.5	1	40.53	54	-13.47	A	H	1.0
2037.84	42.5	32.16	1.37	35.24	9.5	1	32.29	54	-21.71	A	V	1.0
4075.4	55.4	32.55	2.98	35.19	9.5	1	47.25	74	-26.75	P	V	1.0
4075.4	51.7	32.55	2.98	35.19	9.5	1	43.55	54	-10.45	A	V	1.0
6114.5	42.5	37.33	4.93	35.53	9.5	1	40.73	54	-13.27	A	V	1.0
CH6-RX MODE												
Freq.	Reading	AF	Closs	Pre-amp	Dist	Filter	Level	Limit	Margin	Mark	Pol	Height
(MHz)	(dBuV)	(dBuV)	(dB)	(dB)	dB	dB	(dBuV/m)	FCC_B	(dB)	(P/Q/A)	(H/V)	(Meter)
2062.97	46.35	32.14	1.44	35.24	9.5	1	36.18	74	-37.82	P	H	1.0
2062.97	41.5	32.14	1.44	35.24	9.5	1	31.33	54	-22.67	A	H	1.0
4125.94	58.24	32.52	2.94	35.20	9.5	1	50.00	74	-24.00	P	H	1.0
4125.94	46.25	32.52	2.94	35.20	9.5	1	38.01	54	-15.99	A	H	1.0
2062.97	46.58	32.14	1.44	35.24	9.5	1	36.41	74	-37.59	P	V	1.0
2062.97	42.35	32.14	1.44	35.24	9.5	1	32.18	54	-21.82	A	V	1.0
4125.94	56.48	32.52	2.94	35.20	9.5	1	48.24	74	-25.76	P	V	1.0
4125.94	43.56	32.52	2.94	35.20	9.5	1	35.32	54	-18.68	A	V	1.0
Note :												
1. Measurement was up to 6GHz harmonic,“---” means that the emissions level is too low to be measured.												
2. AF: Antenna Factor, Closs: Cable Loss,												
3. Analyzer setting P(Peak): RBW=1MHz, VBW=1MHz, A(Average): RBW=1MHz,VBW=10Hz												

Note: Power adapter(1) is the worse case of all power adapter.



Test Requirement: 15.109 ,15.209

The frequency spectrum above 1 GHz was investigated. All emissions not reported below are more than 40 dB below the prescribed limits. Readings are both peak and average values.

CH11-RX-MODE												
Freq.	Reading	AF	Closs	Pre-amp	Dist	Filter	Level	Limit	Margin	Mark	Pol	Height
(MHz)	(dBuV)	(dBuV)	(dB)	(dB)	dB	dB	(dBuV/m)	FCC_B	(dB)	(P/Q/A)	(H/V)	(Meter)
2087.91	45.35	32.11	1.50	35.25	9.5	1	35.22	74	-38.78	P	H	1.0
2087.91	42.5	32.11	1.50	35.25	9.5	1	32.37	54	-21.63	A	H	1.0
4175.82	58.24	32.49	2.89	35.22	9.5	1	49.91	74	-24.09	P	H	1.0
4175.82	46.25	32.49	2.89	35.22	9.5	1	37.92	54	-16.08	A	H	1.0
2087.91	46.58	32.11	1.50	35.25	9.5	1	36.45	74	-37.55	P	V	1.0
2087.91	43.52	32.11	1.50	35.25	9.5	1	33.39	54	-20.61	A	V	1.0
4175.82	56.48	32.49	2.89	35.22	9.5	1	48.15	74	-25.85	P	V	1.0
4175.82	43.56	32.49	2.89	35.22	9.5	1	35.23	54	-18.77	A	V	1.0
Note :												
1. Measurement was up to 6GHz harmonic,“---” means that the emissions level is too low to be measured.												
2. AF: Antenna Factor, Closs: Cable Loss,												
3. Analyzer setting P(Peak): RBW=1MHz, VBW=1MHz, A(Average): RBW=1MHz,VBW=10Hz												

Note: Power adapter(1) is the worse case of all power adapter.



**Test Requirement: 15.205**

The frequency spectrum above 1 GHz was investigated. All emissions not reported below are more than 40 dB below the prescribed limits. Readings are both peak and average values.

Operation Mode:	Transmitting	Test Date :	2002/12/25
Fundamental Frequency:	2412MHz (CH 1 )	Test By:	M.C. Huang
Temperature :	30 °C	Humidity :	65%

Freq. (MHz)	Reading (dBuV)	AF (dBuV)	Closs (dB)	Pre-amp (dB)	Dist dB	Filter dB	Level (dBuV/m)	Limit FCC B	Margin (dB)	Mark (P/Q/A)	Pol (H/V)	Height (Meter)
4824.29	43.08	34.44	2.78	35.38	9.5	1	36.41	74	-37.59	P	H	1.0
7234.66	44.32	39.81	3.94	35.56	9.5	1	44.01	74	-29.99	P	H	1.0
9647.89	53.17	38.54	4.10	35.67	9.5	1	51.63	74	-22.37	P	H	1.0
9648.89	48.12	38.54	4.10	35.67	9.5	1	46.58	54	-7.42	A	H	1.0
12059.93*	---	42.60	15.20	35.30	9.5	1	---	---	---	---	H	1.0
14471.97*	---	43.40	16.80	34.00	9.5	1	---	---	---	---	H	1.0
16884.01	---	45.20	17.60	34.30	9.5	1	---	---	---	---	H	1.0
19296.05*	---	36.30	18.50	34.30	9.5	1	---	---	---	---	H	1.0
21708.09	---	36.20	19.20	34.60	9.5	1	---	---	---	---	H	1.0
24120.13	---	36.80	21.00	34.20	9.5	1	---	---	---	---	H	1.0

Note :

1. The measurement was searched to 10th harmonic, Remark “---” means that the emissions level is too low to be measured.
2. AF: Antenna Factor, Closs: Cable Loss, Pre-Amp: Preamp gain, Filter: High Pass Filter Insertion Loss (3.5GHz)
3. Analyzer setting P(Peak): RBW=1MHz, VBW=1MHz, A(Average): RBW=1MHz, VBW=10Hz
4. Remark “\*” means that Restricted band.
5. The result basic equation calculation is as follow:

$$\text{Level} = \text{Reading} + \text{AF} + \text{Closs} - \text{Preamp} + \text{Filter} - \text{Dist}, \text{Margin} = \text{Level} - \text{Limit}$$

Note: Power adapter(1) is the worse case of all power adapter.



Test Requirement: 15.205

The frequency spectrum above 1 GHz was investigated. All emissions not reported below are more than 40 dB below the prescribed limits. Readings are both peak and average values.

Operation Mode:	Transmitting	Test Date :	2002/12/25
Fundamental Frequency:	2412MHz (CH 1 )	Test By:	M.C. Huang
Temperature :	30 °C	Humidity :	65%

Freq. (MHz)	Reading (dBuV)	AF (dBuV)	Closs (dB)	Pre-amp (dB)	Dist dB	Filter dB	Level (dBuV/m)	Limit FCC_B	Margin (dB)	Mark (P/Q/A)	Pol (H/V)	Height (Meter)
4824.29	46.00	34.44	2.78	35.38	9.50	1	39.33	74	-34.67	P	V	1.0
7234.66	45.30	39.81	3.94	35.56	9.50	1	44.99	74	-29.01	P	V	1.0
9647.89	55.30	38.54	4.10	35.67	9.50	1	53.76	74	-20.24	P	V	1.0
9648.89	50.80	38.54	4.10	35.67	9.50	1	49.26	54	-4.74	A	V	1.0
12059.93*	---	42.60	15.20	35.30	9.50	1	---	---	---	---	V	1.0
14471.97*	---	43.40	16.80	34.00	9.50	1	---	---	---	---	V	1.0
16884.01	---	45.20	17.60	34.30	9.50	1	---	---	---	---	V	1.0
19296.05*	---	36.30	18.50	34.30	9.50	1	---	---	---	---	V	1.0
21708.09	---	36.20	19.20	34.60	9.50	1	---	---	---	---	V	1.0
24120.13	---	36.80	21.00	34.20	9.50	1	---	---	---	---	V	1.0

Note :

1. The measurement was searched to 10th harmonic, Remark “---” means that the emissions level is too low to be measured.
2. AF: Antenna Factor, Closs: Cable Loss, Pre-Amp: Preamp gain, Filter: High Pass Filter Insertion Loss (3.5GHz)
3. Analyzer setting P(Peak): RBW=1MHz, VBW=1MHz, A(Average): RBW=1MHz, VBW=10Hz
4. Remark “\*” means that Restricted band.
5. The result basic equation calculation is as follow.

$$\text{Level} = \text{Reading} + \text{AF} + \text{Closs} - \text{Preamp} + \text{Filter} - \text{Dist}, \text{Margin} = \text{Level} - \text{Limit}$$

Note: Power adapter(1) is the worse case of all power adapter.



Test Requirement: 15.205

The frequency spectrum above 1 GHz was investigated. All emissions not reported below are more than 40 dB below the prescribed limits. Readings are both peak and average values.

Operation Mode:	Transmitting	Test Date :	2002/12/25
Fundamental Frequency:	2437MHz (CH 6)	Test By:	M.C. Huang
Temperature :	30 °C	Humidity :	65%

Freq. (MHz)	Reading (dBuV)	AF (dBuV)	Closs (dB)	Pre-amp (dB)	Dist dB	Filter dB	Level (dBuV/m)	Limit FCC_B	Margin (dB)	Mark (P/Q/A)	Pol (H/V)	Height (Meter)
4874.25	47.58	34.77	2.80	35.40	9.5	1	41.25	74	-32.75	P	H	1.0
7309.85	42.13	39.78	4.00	35.57	9.5	1	41.84	74	-32.16	P	H	1.0
9748.08	52.36	38.53	4.02	35.72	9.5	1	50.68	74	-23.32	P	H	1.0
9749.08	45.68	38.53	4.02	35.72	9.5	1	44.00	54	-10.00	A	H	1.0
12185.10*	---	32.14	4.53	35.24	9.5	1	---	---	---	---	H	1.0
14622.12	---	43.40	16.80	34.00	9.5	1	---	---	---	---	H	1.0
17059.14	---	45.20	17.60	34.30	9.5	1	---	---	---	---	H	1.0
19496.16*	---	36.30	18.50	34.30	9.5	1	---	---	---	---	H	1.0
21933.18	---	36.20	19.20	34.60	9.5	1	---	---	---	---	H	1.0
24370.20	---	36.80	21.00	34.20	9.5	1	---	---	---	---	H	1.0

Note :

1. The measurement was searched to 10th harmonic, Remark “---” means that the emissions level is too low to be measured.
2. AF: Antenna Factor, Closs: Cable Loss, Pre-Amp: Preamp gain, Filter: High Pass Filter Insertion Loss (3.5GHz)
3. Analyzer setting P(Peak): RBW=1MHz, VBW=1MHz, A(Average): RBW=1MHz, VBW=10Hz
4. Remark “\*” means that Restricted band.
5. The result basic equation calculation is as follow:  
 $Level = Reading + AF + Closs - Preamp + Filter - Dist$ ,  $Margin = Level - Limit$

Note: Power adapter(1) is the worse case of all power adapter.



Test Requirement: 15.205

The frequency spectrum above 1 GHz was investigated. All emissions not reported below are more than 40 dB below the prescribed limits. Readings are both peak and average values.

Operation Mode:	Transmitting	Test Date :	2002/12/25
Fundamental Frequency:	2437MHz (CH 6)	Test By:	M.C. Huang
Temperature :	30 °C	Humidity :	65%

Freq. (MHz)	Reading (dBuV)	AF (dBuV)	Closs (dB)	Pre-amp (dB)	Dist dB	Filter dB	Level (dBuV/m)	Limit FCC_B	Margin (dB)	Mark (P/Q/A)	Pol (H/V)	Height (Meter)
4874.25	50.25	34.77	2.80	35.40	9.5	1	43.92	74	-30.08	P	V	1.0
4874.25	37.25	34.77	2.80	35.40	9.5	1	30.92	54	-23.08	A	V	1.0
7309.85	46.20	39.78	4.00	35.57	9.5	1	45.91	74	-28.09	P	V	1.0
9748.08	52.60	38.53	4.02	35.72	9.5	1	50.92	74	-23.08	P	V	1.0
9749.08	47.50	38.53	4.02	35.72	9.5	1	45.82	54	-8.18	A	V	1.0
12185.10*	---	32.14	4.53	35.24	9.5	1	---	---	---	---	V	1.0
14622.12	---	43.40	16.80	34.00	9.5	1	---	---	---	---	V	1.0
17059.14	---	45.20	17.60	34.30	9.5	1	---	---	---	---	V	1.0
19496.16*	---	36.30	18.50	34.30	9.5	1	---	---	---	---	V	1.0
21933.18	---	36.20	19.20	34.60	9.5	1	---	---	---	---	V	1.0
24370.20	---	36.80	21.00	34.20	9.5	1	---	---	---	---	V	1.0

Note :

1. The measurement was searched to 10th harmonic, Remark “---” means that the emissions level is too low to be measured.
2. AF: Antenna Factor, Closs: Cable Loss, Pre-Amp: Preamp gain, Filter: High Pass Filter Insertion Loss (3.5GHz)
3. Analyzer setting P(Peak): RBW=1MHz, VBW=1MHz, A(Average): RBW=1MHz, VBW=10Hz
4. Remark “\*” means that Restricted band.
5. The result basic equation calculation is as follow:  
 $Level = Reading + AF + Closs - Preamp + Filter - Dist$ ,  $Margin = Level - Limit$

Note: Power adapter(1) is the worse case of all power adapter.



**Test Requirement: 15.205**

The frequency spectrum above 1 GHz was investigated. All emissions not reported below are more than 40 dB below the prescribed limits. Readings are both peak and average values.

Operation Mode:	Transmitting	Test Date :	2002/12/25
Fundamental Frequency:	2462MHz (CH 11 )	Test By:	M.C. Huang
Temperature :	30 °C	Humidity :	65%

Freq. (MHz)	Reading (dBuV)	AF (dBuV)	Closs (dB)	Pre-amp (dB)	Dist dB	Filter dB	Level (dBuV/m)	Limit FCC_B	Margin (dB)	Mark (P/Q/A)	Pol (H/V)	Height (Meter)
4924.05	45.23	35.10	2.83	35.41	9.5	1	39.25	74	-34.75	P	H	1.0
7386.00	43.56	39.75	4.06	35.57	9.5	1	43.29	74	-30.71	P	H	1.0
9848.02	52.34	38.52	3.93	35.77	9.5	1	50.52	74	-23.48	P	H	1.0
12310.04*	---	32.14	4.53	35.24	9.5	1	---	---	---	---	H	1.0
14772.06	---	43.40	16.80	34.00	9.5	1	---	---	---	---	H	1.0
17234.08	---	45.20	17.60	34.30	9.5	1	---	---	---	---	H	1.0
19696.1*	---	36.30	18.50	34.30	9.5	1	---	---	---	---	H	1.0
22158.12*	---	36.20	19.20	34.60	9.5	1	---	---	---	---	H	1.0
24620.14	---	36.80	21.00	34.20	9.5	1	---	---	---	---	H	1.0

Note :

1. The measurement was searched to 10th harmonic, Remark “---” means that the emissions level is too low to be measured.
2. AF: Antenna Factor, Closs: Cable Loss, Pre-Amp: Preamp gain, Filter: High Pass Filter Insertion Loss (3.5GHz)
3. Analyzer setting P(Peak): RBW=1MHz, VBW=1MHz, A(Average): RBW=1MHz, VBW=10Hz
4. Remark “\*” means that Restricted band.
5. The result basic equation calculation is as follow:

$$\text{Level} = \text{Reading} + \text{AF} + \text{Closs} - \text{Preamp} + \text{Filter} - \text{Dist}, \text{Margin} = \text{Level} - \text{Limit}$$

Note: Power adapter(1) is the worse case of all power adapter.





**Test Requirement: 15.205**

The frequency spectrum above 1 GHz was investigated. All emissions not reported below are more than 40 dB below the prescribed limits. Readings are both peak and average values.

Operation Mode:	Transmitting	Test Date :	2002/12/25
Fundamental Frequency:	2462MHz (CH 11 )	Test By:	M.C. Huang
Temperature :	30 °C	Humidity :	65%

Freq. (MHz)	Reading (dBuV)	AF (dBuV)	Closs (dB)	Pre-amp (dB)	Dist dB	Filter dB	Level (dBuV/m)	Limit FCC_B	Margin (dB)	Mark (P/Q/A)	Pol (H/V)	Height (Meter)
4924.05	48.57	35.10	2.83	35.41	9.5	1	42.59	74	-31.41	P	V	1.0
4924.05	42.50	35.10	2.83	35.41	9.5	1	36.52	54	-17.48	A	V	1.0
7387.05	42.13	39.75	4.06	35.57	9.5	1	41.86	74	-32.14	P	V	1.0
9848.02	48.56	38.52	3.93	35.77	9.5	1	46.74	74	-27.26	P	V	1.0
9849.02	44.50	38.52	3.93	35.77	9.5	1	42.67	54	-11.33	A	V	1.0
12310.04*	---	32.14	4.53	35.24	9.5	1	---	---	---	---	V	1.0
14772.06	---	43.40	16.80	34.00	9.5	1	---	---	---	---	V	1.0
17234.08	---	45.20	17.60	34.30	9.5	1	---	---	---	---	V	1.0
19696.1*	---	36.30	18.50	34.30	9.5	1	---	---	---	---	V	1.0
22158.12*	---	36.20	19.20	34.60	9.5	1	---	---	---	---	V	1.0
24620.14	---	36.80	21.00	34.20	9.5	1	---	---	---	---	V	1.0

Note :

1. The measurement was searched to 10th harmonic, Remark “---” means that the emissions level is too low to be measured.
2. AF: Antenna Factor, Closs: Cable Loss, Pre-Amp: Preamp gain, Filter: High Pass Filter Insertion Loss (3.5GHz)
3. Analyzer setting P(Peak): RBW=1MHz, VBW=1MHz, A(Average): RBW=1MHz, VBW=10Hz
4. Remark “\*” means that Restricted band.
5. The result basic equation calculation is as follow:  
 $Level = Reading + AF + Closs - Preamp + Filter - Dist, Margin = Level - Limit$

Note: Power adapter(1) is the worse case of all power adapter.



### 3.7 PHOTOS OF OPEN SITE





### 3.7 PHOTOS OF OPEN SITE

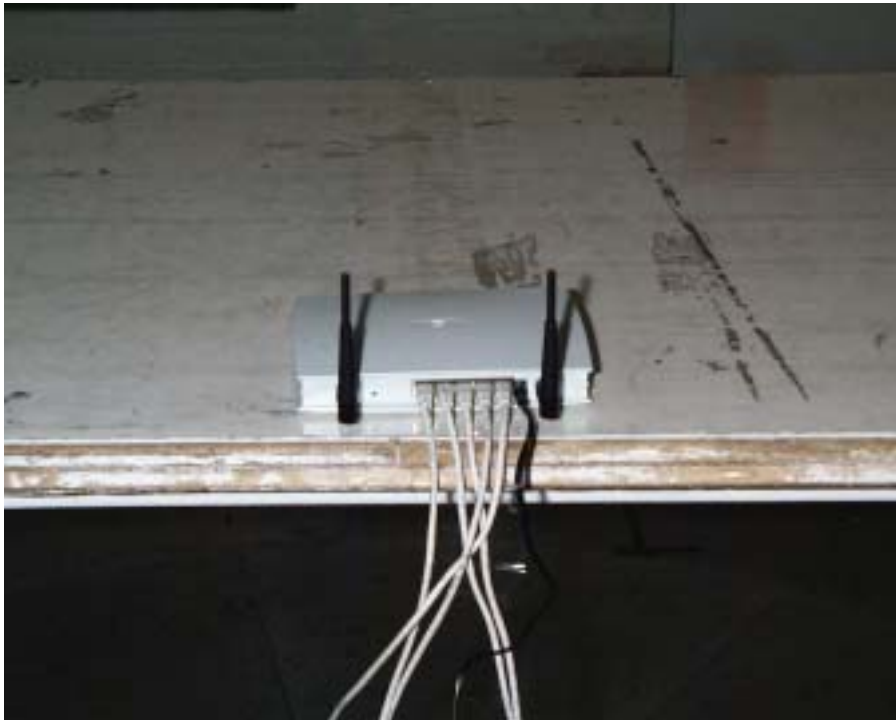



## 4. 6dB BANDWIDTH MEASUREMENT

### 4.1 TEST EQUIPMENTS

Description & Manufacturer	Model No.	Serial No.	DATE OF CALIBRATION
ROHDE & SCHWARZ TEST RECEIVER	ESMI	842088/005 841978/008	SEPT. 3, 2002
HP ATTENUATOR	8496B	3247A18505	Cal. on use
HP PLOTTER	7750A	725A 852141	N/A

NOTE :

1. The measurement uncertainty is less than +/- 2.6dB, which is calculated as per the NAMAS document NIS81.
2. The calibration interval of the above test instruments is 12 months and the calibrations are traceable to NML/ROC and NIST/USA.

### 4.2 TEST SETUP

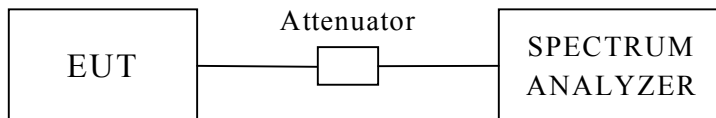

### 4.3 LIMITS OF 6dB BANDWIDTH MEASUREMENT

The minimum of 6dB Bandwidth Measurement is >500KHz

### 4.4 TEST PROCEDURE

The transmitter output was connected to the spectrum analyzer through an attenuator. The bandwidth of the fundamental frequency was measured by spectrum analyzer with 100 KHz RBW and 100 KHz VBW. The 6dB bandwidth is defined as the total spectrum the power of which is higher than peak power minus 6dB.

### 4.5 UNCERTAINTY OF CONDUCTED EMISSION

The uncertainty of conducted emission is  $\pm 200$ KHz.



#### 4.6 TEST RESULTS

<b>EUT</b>	802.11b WLAN Router	<b>MODEL</b>	WR2000
<b>INPUT POWER (SYSTEM)</b>	5VDC(From Adapter)	<b>ENVIRONMENTAL CONDITIONS</b>	27°C, 70%RH,
<b>TESTED BY : M. C. Huang</b>			

<b>CHANNEL</b>	<b>CHANNEL FREQUENCY (MHz)</b>	<b>6dB BANDWIDTH (MHz)</b>	<b>MINIMUM LIMIT (MHz)</b>	<b>PASS / FAIL</b>
1	2412	6.46	0.5	PASS
6	2437	6.44	0.5	PASS
11	2462	8.35	0.5	PASS



## 4.7 PHOTO OF 6DB BANDWIDTH MEASUREMENT

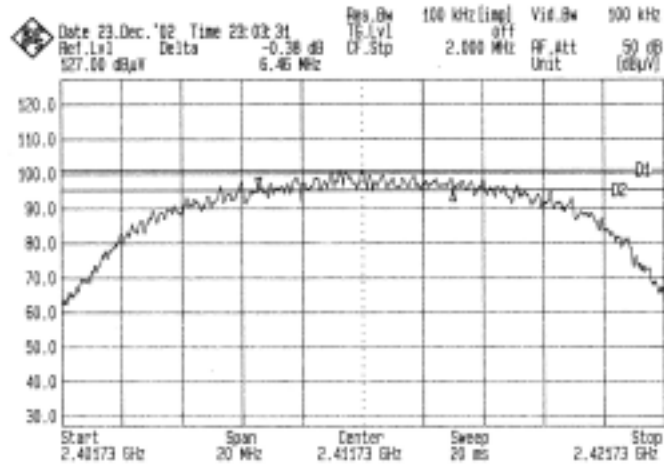

Channel 1

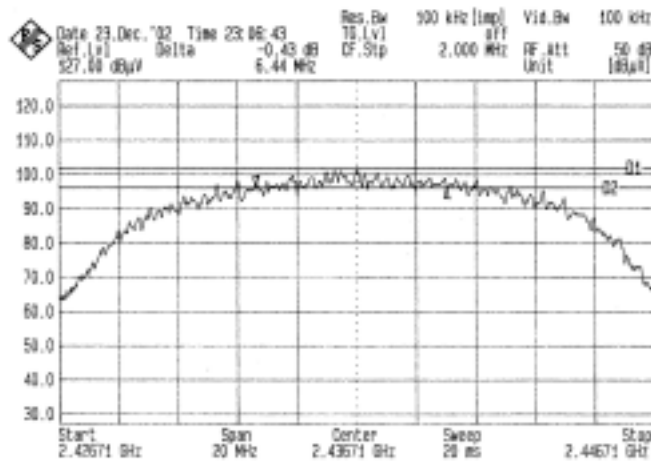

Channel 6

Channel 11



## 5. MAXIMUM PEAK OUTPUT POWER

### 5.1 TEST EQUIPMENTS

Description & Manufacturer	Model No.	Serial No.	DATE OF CALIBRATION
ROHDE & SCHWARZ TEST RECEIVER	ESMI	842088/005 841978/008	SEPT. 3, 2002
HP ATTENUATOR	8496B	3247A18505	Cal. on use
HP PLOTTER	7750A	725A 852141	N/A

NOTE :

1. The measurement uncertainty is less than +/- 2.6dB, which is calculated as per the NAMAS document NIS81.
2. The calibration interval of the above test instruments is 12 months and the calibrations are traceable to NML/ROC and NIST/USA.

### 5.2 TEST SETUP

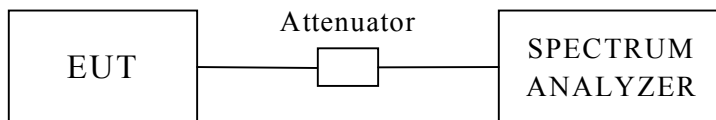

### 5.3 LIMITS OF MAXIMUM PEAK OUTPUT POWER

The Maximum Peak Output Power Measurement is 30dBm.



## 5.4 TEST PROCEDURE

The RF power output was measured with a Power meter connected to the RF Antenna connector ( conducted measurement ) while EUT was operating in transmit mode at the appropriate center frequency.

## 5.5 UNCERTAINTY OF CONDUCTED EMISSION

The uncertainty of conducted emission is  $\pm 1.82$ dB.

## 5.6 TEST RESULTS

<b>EUT</b>	802.11b WLAN Router	<b>MODEL</b>	WR2000
<b>INPUT POWER (SYSTEM)</b>	5VDC(From Adapter)	<b>ENVIRONMENTAL CONDITIONS</b>	27°C, 70%RH,
<b>TESTED BY</b> : M. C. Huang			

<b>CHANNEL</b>	<b>CHANNEL FREQUENCY (MHz)</b>	<b>PEAK POWER OUTPUT (dBm)</b>	<b>PEAK POWER LIMIT (dBm)</b>	<b>PASS / FAIL</b>
1	2412	18.56	30	PASS
6	2437	19.02	30	PASS
11	2462	18.50	30	PASS





## 6. POWER SPECTRAL DENSITY MEASUREMENT

### 6.1 TEST EQUIPMENTS

Description & Manufacturer	Model No.	Serial No.	DATE OF CALIBRATION
ROHDE & SCHWARZ TEST RECEIVER	ESMI	842088/005 841978/008	SEPT. 3, 2002
HP ATTENUATOR	8496B	3247A18505	Cal. on use
HP PLOTTER	7750A	725A 852141	N/A

NOTE :

1. The measurement uncertainty is less than +/- 2.6dB, which is calculated as per the NAMAS document NIS81.
2. The calibration interval of the above test instruments is 12 months and the calibrations are traceable to NML/ROC and NIST/USA.

### 6.2 TEST SETUP

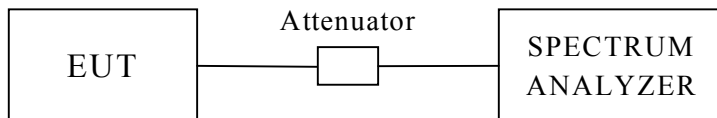

### 6.3 LIMITS OF POWER SPECTRAL DENSITY MEASUREMENT

The Maximum Power Spectral Density Measurement is 8dBm.



## 6.4 TEST PROCEDURE

The transmitter output was connected to the spectrum analyzer through an attenuator, the bandwidth of the fundamental frequency was measured with the spectrum analyzer using 3KHz RBW and 30KHz VBW, set sweep time=span / 3KHz.

The power spectral density was measured and recorded.

The sweep time is allowed to be longer than span / 3KHz for a full response of the mixer in the spectrum analyzer.

## 6.5 UNCERTAINTY OF CONDUCTED EMISSION

The uncertainty of conducted emission is  $\pm 1.82$ dB.

## 6.6 TEST RESULTS

<b>EUT</b>	802.11b WLAN Router	<b>MODEL</b>	WR2000
<b>INPUT POWER (SYSTEM)</b>	5VDC(From Adapter)	<b>ENVIRONMENTAL CONDITIONS</b>	27°C, 70%RH,
<b>TESTED BY : M. C. Huang</b>			

<b>CHANNEL</b>	<b>CHANNEL FREQUENCY (MHz)</b>	<b>Final RF Power Level IN 3KHz BW (dBm)</b>	<b>MAXIMUM LIMIT (dBm)</b>	<b>PASS / FAIL</b>
1	2412	-11.99	8	PASS
6	2437	-12.07	8	PASS
11	2462	-10.95	8	PASS

Note:

- 1.The measurement value of RF Power Level + 10dB attenuator=Final RF Power Level



## 6.7 PHOTO OF POWER SPECTRAL DENSITY MEASUREMENT

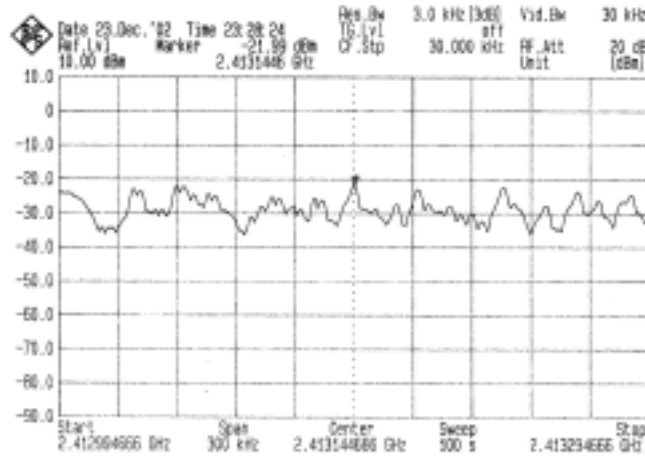

Channel 1

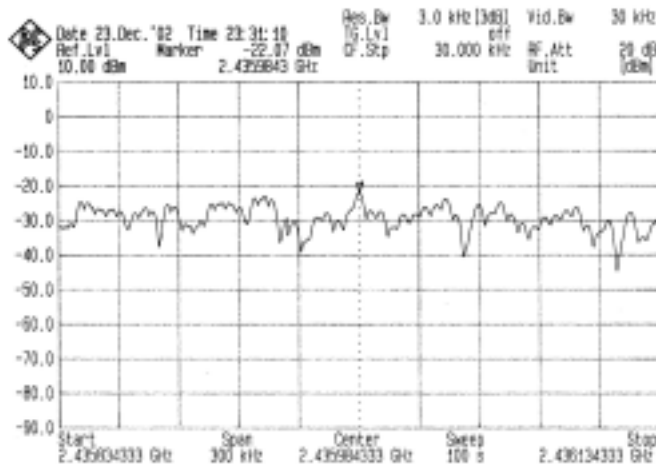

Channel 6

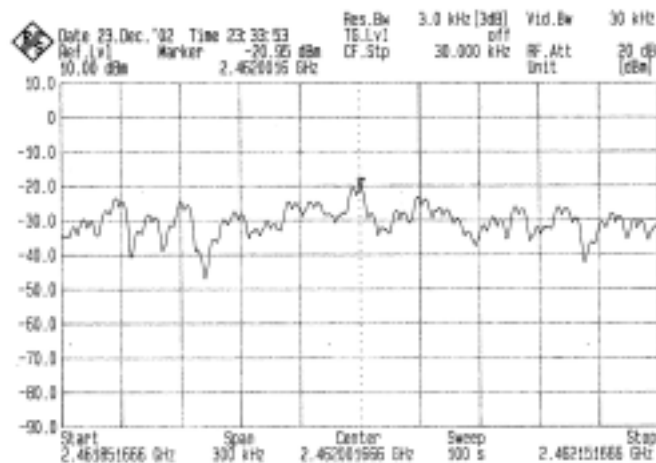

Channel 11



## 7. OUT OF BAND MEASUREMENT

### 7.1 TEST EQUIPMENTS

Description & Manufacturer	Model No.	Serial No.	DATE OF CALIBRATION
ROHDE & SCHWARZ TEST RECEIVER	ESMI	842088/005 841978/008	SEPT. 3, 2002
HP ATTENUATOR	8496B	3247A18505	Cal. on use
HP PLOTTER	7750A	725A 852141	N/A

NOTE :

3. The measurement uncertainty is less than +/- 2.6dB, which is calculated as per the NAMAS document NIS81.
4. The calibration interval of the above test instruments is 12 months and the calibrations are traceable to NML/ROC and NIST/USA.

### 7.2 TEST SETUP

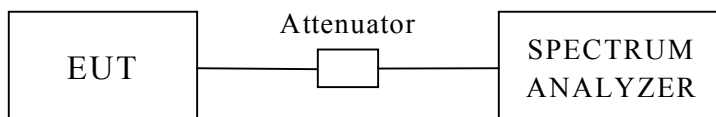

### 7.3 LIMITS OF OUT OF BAND EMISSIONS MEASUREMENT

1. Below -20dB of the highest emission level of operating band (in 100KHz Resolution Bandwidth).
2. Fall in the restricted bands listed in section 15.205. The maximum permitted average field strength is listed in section 15.209.



## 7.4 TEST PROCEDURE

1. The transmitter output was connected to the spectrum analyzer via a low loss cable. Set both RBW and VBW of spectrum analyzer to 100KHz with suitable frequency span including 100KHz bandwidth from band edge. The band edges was measured and recorded.
2. Radiated emission test: Applies to harmonics/spurs that fall in the restricted bands listed in Section 15.205. The maximum permitted average field strength is listed in Section 15.209. A pre-amp (and possibly a high-pass filter) is necessary for this measurement. For measurements above 1 GHz, set RBW= 1MHz, VBW= 10Hz, Sweep: Auto. If the emission is pulsed, modify the unit for continuous operation, use the setting shown above, then correct the reading by subtracting the peak-average correction factor, derived from the appropriate duty cycle calculation.

## 7.5 UNCERTAINTY OF CONDUCTED EMISSION

The uncertainty of conducted emission is  $\pm 1.82$ dB.

## 7.6 TEST RESULTS

### A. Conducted

Refer to 7.7 photo of out band Emission measurement

### B. Radiated

Refer to the section of Radiation Emission ; Test requirement 15.205 from P19 to P24 of the measurement data.

<b>EUT</b>	802.11b WLAN Router	<b>MODEL</b>	WR2000
<b>INPUT POWER (SYSTEM)</b>	5VDC(From Adapter)	<b>ENVIRONMENTAL CONDITIONS</b>	27°C , 70%RH,
<b>TESTED BY : M. C. Huang</b>			

<b>CHANNEL FREQUENCY (MHz)</b>	<b>Required Limit (dBc)</b>	<b>PASS / FAIL</b>
<2400	>20	PASS
>2483.5	>20	PASS



## 7.7 PHOTO OF OUT OF BAND MEASUREMENT

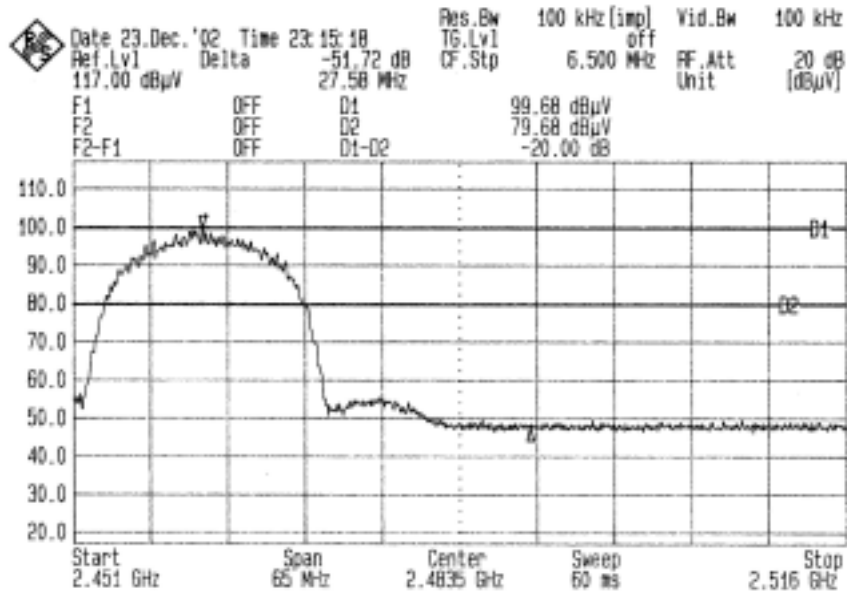

BACK

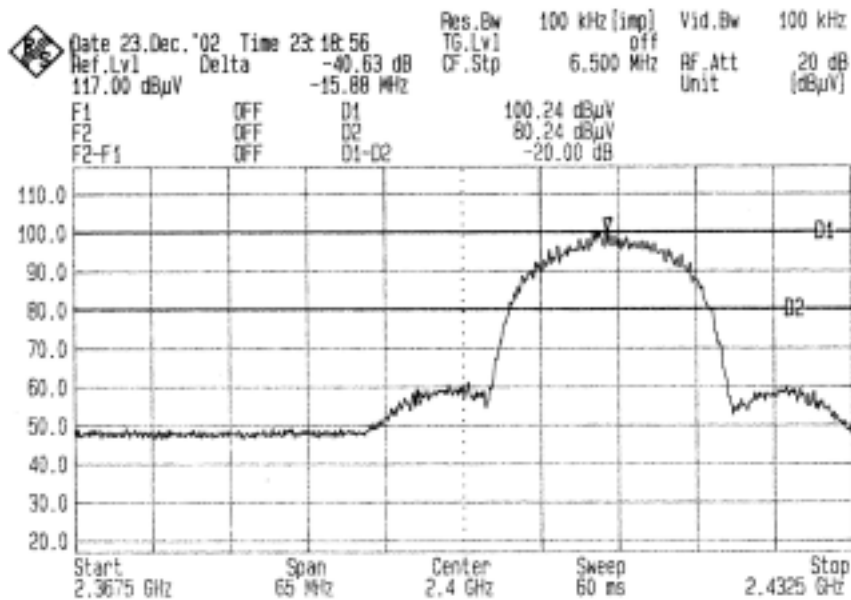

FRONT



## **8. ANTENNA REQUIREMENT**

### **8.1 STANDARD APPLICABLE**

For intentional device, according to FCC 47 CFR Section 15.203, an intentional radiator shall be designed to ensure that no antenna other than that furnished by the responsible party shall be used with the device.

And according to FCC 47 CFR Section 15.247 (b), if transmitting antennas of directional gain greater than 6dBi are used, the power shall be reduced by the amount in dB that the directional gain of the antenna exceeds 6dBi.

### **8.2 ANTENNA CONNECTED CONSTRUCTION**

The antenna used in this product is  $1/2\lambda$  Dipole antenna. The  $1/2\lambda$  Dipole antenna connector is MMCX And the maximum Gain of these antennas are only 2dBi.



## 9. RF EXPOSURE EVALUATION

According to FCC 1.1310 : The criteria listed in the following table shall be used to evaluate the environment impact of human exposure to radio frequency (RF) radiation as specified in 1.1307(b)  
 LIMITS FOR MAXIMUM PERMISSIBLE EXPOSURE (MPE)

Frequency Range (MHz)	Electric Field Strength (V/m)	Magnetic Field Strength (A/m)	Power Density (mW/cm <sup>2</sup> )	Average Time
(A) Limits for Occupational / Control Exposures				
300-1,500	--	--	F/300	6
1,500-100,000	--	--	5	6
(B) Limits for General Population / Uncontrol Exposures				
300-1,500	--	--	F/1500	6
1,500-100,000	--	--	1	30

### 9.1 FRIIS FORMULA

Friis transmission formula :  $Pd = (Pout * G) / (4 * pi * r^2)$

Where

Pd = power density in mW/cm<sup>2</sup>

Pout = output power to antenna in mW

G = gain of antenna in linear scale

Pi = 3.1416

R = distance between observation point and center of the radiator in cm

Pd is the limit of MPE, 1 mW/cm<sup>2</sup>. If we know the maximum gain of the antenna and the total power input to the antenna, through the calculation, we will know the distance r where the MPE limit is reached.

### 9.2 EUT OPERATING CONDITION

A software provided by client enabled the EUT to transmit and receive data at lowest, middle and highest channel individually.





## 9.3 TEST RESULT OF RF EXPOSURE EVALUATION

Test Item : RF Exposure Evaluation Data

Test Mode : Normal Operation

### 9.3.1 ANTENNA GAIN

Antenna Gain : The maximum Gain measured in fully anechoic chamber is 2dBi linear scale.

### 9.3.2 OUTPUT POWER INTO ANTENNA & RF EXPOSURE EVALUATION DISTANCE

Channel	Channel Frequency (MHz)	Output Power to Antenna (dBm)	EIRP at Friis formula when r=20cm	Limit
CH1	2412.00	18.56	0.022632	1
CH6	2437.00	19.02	0.025161	1
CH11	2462.00	18.50	0.022322	1

The distance r (4<sup>th</sup> column) calculated from the Friis transmission formula is far lower than the limit 1 mW/cm<sup>2</sup>. So, RF exposure limit warning or SAR test are not required.