

**DELL CONFIDENTIAL**

# Latitude 7370

---

## Setup and Features Information

**Language:** ENGLISH

Regulatory Model: P67G series

**Regulatory Type:** P67G001

This document is for regulatory purpose only.

## Warnings



**WARNING:** A WARNING indicates a potential for property damage, personal injury, or death.

Information in this document is subject to change without notice.

© 2015 Dell Inc. All rights reserved.

Reproduction of these materials in any manner whatsoever without the written permission of Dell Inc. is strictly forbidden.

Trademarks used in this text: Dell™, the DELL logo, Dell Precision™, OptiPlex™, Latitude™, PowerEdge™, PowerVault™, PowerConnect™, OpenManage™, EqualLogic™, KACE™, FlexAddress™ and Vostro™ are trademarks of Dell Inc. Intel®, Pentium®, Xeon®, Core™ and Celeron® are registered trademarks of Intel Corporation in the U.S. and other countries. AMD® is a registered trademark and AMD Opteron™, AMD Phenom™, and AMD Sempron™ are trademarks of Advanced Micro Devices, Inc. Microsoft®, Windows®, Windows Server®, MS-DOS® and Windows Vista® are either trademarks or registered trademarks of Microsoft Corporation in the United States and/or other countries. Red Hat Enterprise Linux® and Enterprise Linux® are registered trademarks of Red Hat, Inc. in the United States and/or other countries. Novell® is a registered trademark and SUSE™ is a trademark of Novell Inc. in the United States and other countries. Oracle® is a registered trademark of Oracle Corporation and/or its affiliates. Citrix®, Xen®, XenServer® and XenMotion® are either registered trademarks or trademarks of Citrix Systems, Inc. in the United States and/or other countries. VMware®, Virtual SMP®, vMotion®, vCenter®, and vSphere® are registered trademarks or trademarks of VMWare, Inc. in the United States or other countries.

Other trademarks and trade names may be used in this publication to refer to either the entities claiming the marks and names or their products. Dell Inc. disclaims any proprietary interest in trademarks and trade names other than its own.

# Features

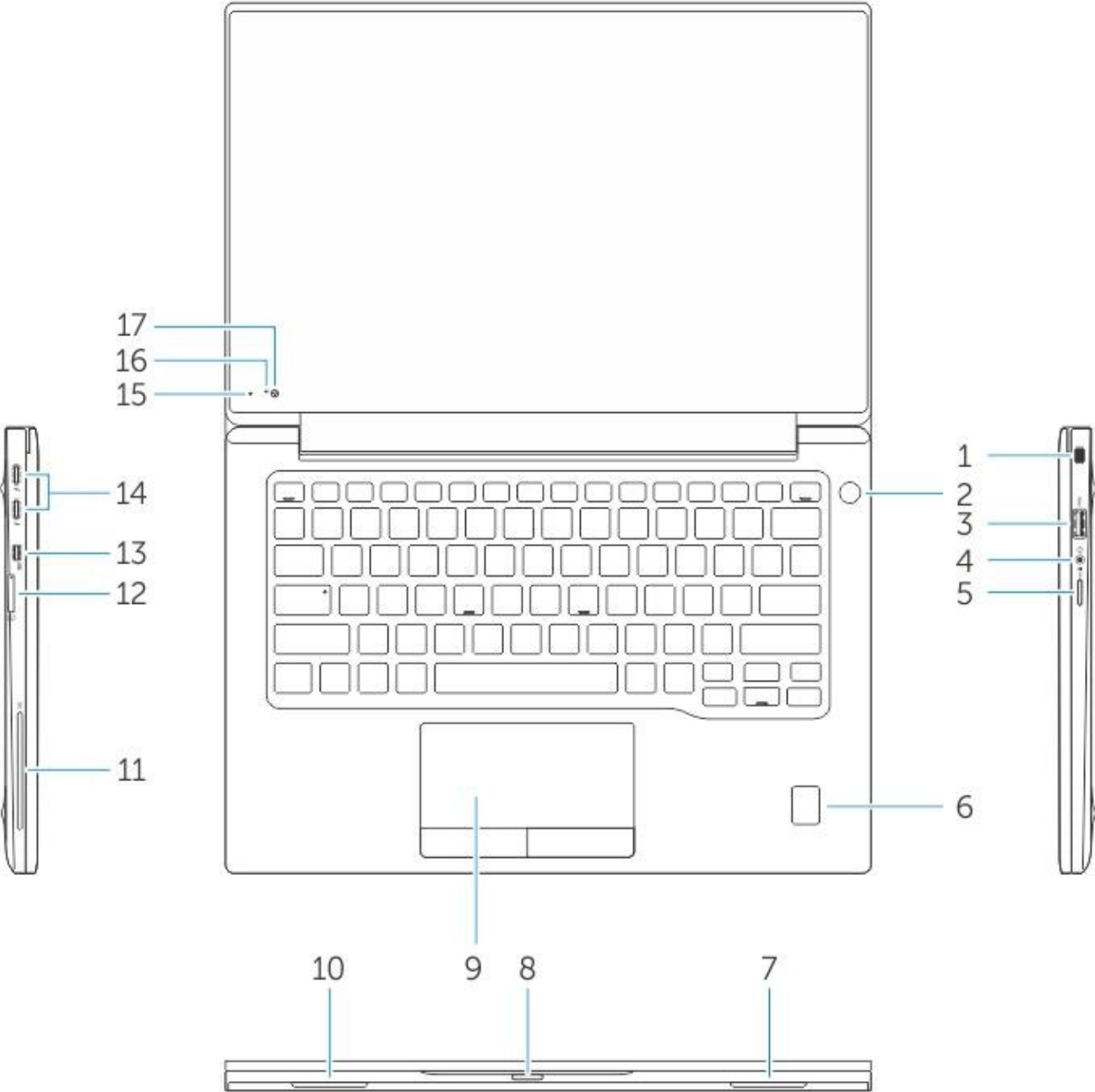

1. Security cable slot
2. Power button
3. USB 3.0 connector
4. Headset connector
5. SD card reader
6. Fingerprint reader
7. Speaker
8. Status light
9. Touchpad
10. Speaker
11. Smartcard reader
12. SIM card reader
13. Mini DisplayPort connector
14. USB Type C connectors (2)
15. Microphone
16. Camera status light
17. Camera

## Setting up Your Computer

This section provides information about setting up your Dell computer.

### Before Setting up Your Computer

When positioning your computer, ensure that you allow easy access to a power source, adequate ventilation, and a level surface to place your computer.















Restricting airflow around your computer may cause it to overheat. To prevent overheating ensure that you leave at least 10.2 cm (4 inches) at the back of the computer and a minimum of 5.1 cm (2 inches) on all other sides. You should never place your computer in an enclosed space, such as a cabinet or drawer when it is powered on.











 **WARNING:** Do not block, push objects into, or allow dust to accumulate in the air vents. Do not store your Dell™ computer in a low-airflow environment, such as a closed briefcase, while it is powered on. Restricting the airflow can damage the computer or cause a fire. The computer turns on the fan when the computer gets hot. Fan noise is normal and does not indicate a problem with the fan or the computer.

 **CAUTION:** Placing or stacking heavy or sharp objects on the computer may result in permanent damage to the computer.

## Icons, Status Lights and Indicators

Icons are used to label all connectors and buttons on Dell computers. Check the following table for a description of those found on your computer.

	<b>Power/battery status light</b> – Indicates the power state and battery status.
	<b>AC adapter connector</b> - Connects to the AC adapter to power the computer and charge the battery when the computer is not in use.
	<b>Battery status light</b> – if the power status light does not provide information on battery charge status, this light provides information on charge status.
	Wireless <b>switch</b> - used to either turn wireless communication on or off. -Or- used to scan the local area for available wireless signals.
	<b>Network connector</b> – Connects your computer to a network or a broadband device if you are using a wired network.
	<b>VGA connector</b> – Connects to a monitor or projector.
	<b>USB 2.0 connector</b> – Connects to USB devices, such as a mouse, keyboard, printer, external drive, or MP3 player.
	Eject the disc
	<b>Audio out/Headphone connector</b> – Connects one pair of headphones, or sends audio to a powered speaker or sound system.
	<b>Audio in/Microphone connector</b> – Connects to a microphone or input signal for use with audio programs.
	Turn up the volume
	Mute the sound
	Turn down the volume
	Play or pause
	Play the next track or chapter

	Play the previous track or chapter
	<b>HDMI connector</b> – connects to a monitor, projector, or television.
	<b>eSATA</b> – connects to external devices such as hard drives and media bays, this connector also supports standard USB devices.
	<b>ExpressCard slot</b> – Supports one 34 mm wide ExpressCard. The computer ships with a plastic blank installed in the slot. <b>NOTE:</b> Blanks protect unused slots from dust and other particles. Save the blank for use when no ExpressCard is installed in the slot; blanks from other computers may not fit your computer.
	<b>Display Port</b> - connects to a monitor or projector
<b>SD•MS/MMC</b> or <b>SD/MMC - MS/Pro - xD</b>	Provides a fast and convenient way to view and share digital photos, music, videos, and documents stored on digital memory cards.
<b>1394</b>	<b>1394 Firewire</b> – used for high-speed data connections to external storage and digital media devices, such as still- and video cameras.
	<b>Line in</b> – connects to audio devices such as receivers and MP3 players
	<b>Line out</b> – connects to audio devices such as stereos and speakers
	<b>USB connector</b> – connects to peripheral devices such as printers, mice, and keyboards.
	<b>Wireless sync</b> – used to synchronize connections with wireless input devices such as keyboards and mice (for select systems only).
	<b>DVI connector</b> – used to connect monitors, projectors, and televisions.
	<b>HD activity light</b> – lights when the hard drive is writing or reading data.

## Removing and Replacing a Laptop Computer Battery

If your Dell laptop computer is shipped without the battery, install the battery before you proceed.

 **WARNING:** Before you begin any of the procedures in this section, follow the safety instructions that shipped with your computer.

 **WARNING:** Using an incompatible battery may increase the risk of fire or explosion. This computer should only use a battery purchased from Dell. Do not use batteries from other computers.

 **WARNING:** Before removing the battery, shut down the computer, and remove external cables (including the AC adapter).

### To install the battery

1. Slide the battery into the battery bay until it clicks into place.  
For some computers, this requires that the battery be inserted at a 45-degree angle.

### To remove the battery

1. Turn off the computer and turn it over.
2. Slide the battery release latch or latches to the unlock position until it clicks into place.
3. Slide the battery out.

## Connecting the Power Supply

### Computers With External AC Adapters (Notebooks and All-in-One Models)

Connect the AC adapter to the computer and then plug it into an electrical outlet or surge protector. Be sure to leave your AC adapter connected throughout the setup process to ensure consistent power for your operating system to complete all configurations, and to charge your battery.

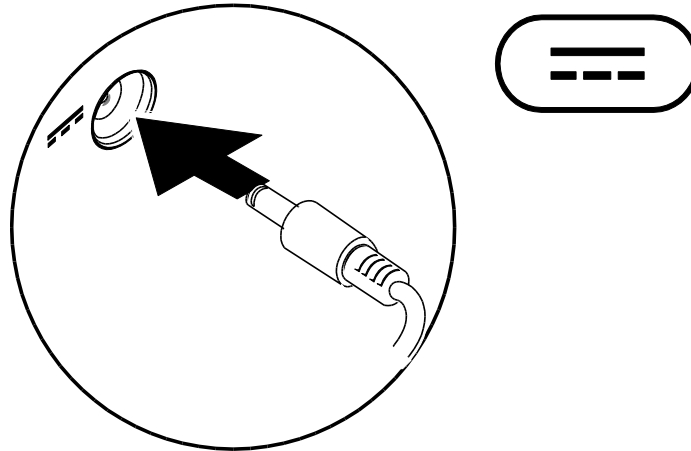

 **WARNING:** The AC adapter works with electrical outlets worldwide. However, power connectors and power strips vary among countries. Using an incompatible cable or improperly connecting the cable to a power strip or electrical outlet may cause fire or permanent damage to your computer.

### Computers With an Internal Power Supply (Desktops)

Connect the power cables for your display and computer and plug them into a surge protector or wall outlet. See your display documentation for more information on connecting power cables.

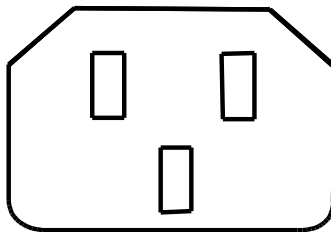



## Connect the Network Cable (Optional)

To use a wired network connection, connect the network cable.

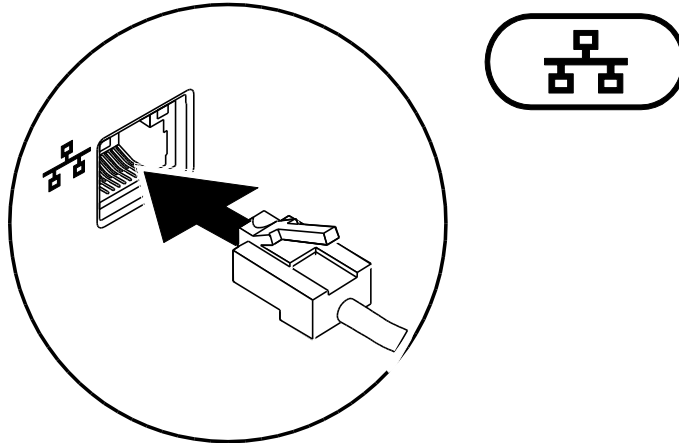

## Connect an External Display (Only for Desktops)

Read the instructions that came with the display for more information.

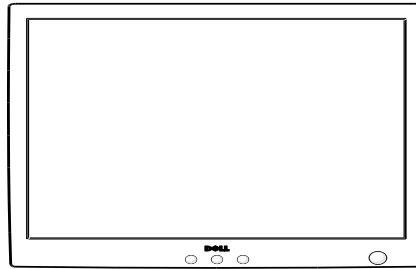

**Press the Power Button on the Computer (and Display if Connected).**



## Specifications

This section provides information that you may need when setting up, updating drivers for, and upgrading your computer.



**NOTE:** Offerings may vary by region. For more information regarding the configuration of your computer, click **Start** → **Help and Support** and select the option to view information about your computer.

### AC Adapter

Adapter Rating	60 w
Input Voltage	100 VAC-240 VAC
Input Frequency	50 Hz-60 Hz
Input Current	1.3A
Output Current	2.25 A
Rated Output Voltage	20 Vdc

# Appendix

## Rovi Product Notice

This item incorporates copy protection technology that is protected by U.S. patents and other intellectual property rights to Rovi Corporation. Reverse engineering and disassembly are prohibited.

## Information for NOM, or Official Mexican Standard (Only for Mexico)

The following information is provided in the device(s) described in this document in accordance with the requirements of the Official Mexican Standard (NOM):

### Importer:

Dell México S.A. de C.V.

Paseo de la Reforma 2620 – Flat 11°

Col. Lomas Altas

11950 México, D.F.

For details, read the safety information that shipped with your computer.

**For additional safety best practices information, see the Regulatory Compliance Homepage at [www.dell.com/regulatory\\_compliance](http://www.dell.com/regulatory_compliance).**