



SPORTON International Inc.

No. 52, Hwa Ya 1st Rd., Hwa Ya Technology Park, Kwei-Shan Hsiang, Tao Yuan Hsien, Taiwan, R.O.C.
Ph: 886-3-327-3456 / FAX: 886-3-327-0973 / www.sporton.com.tw

FCC RADIO TEST REPORT

Applicant's company	Broadcom Corporation
Applicant Address	190 Mathilda Place Sunnyvale CA 94086 U.S.A.
FCC ID	QDS-BRCM1082
Manufacturer's company	Broadcom Corporation
Manufacturer Address	190 Mathilda Place Sunnyvale CA 94086 U.S.A.

Product Name	802.11abgn/11ac WLAN + Bluetooth PCI-E Mini Card
Brand Name	Broadcom
Model Name	BCM94360HMB
Test Rule	47 CFR FCC Part 15 Subpart C § 15.247
Test Freq. Range	2402 ~ 2480MHz
Received Date	Mar. 12, 2014
Final Test Date	May 05, 2014
Submission Type	Original Equipment

Statement

Test result included is only for the Bluetooth BR/EDR of the product.

The test result in this report refers exclusively to the presented test model / sample.

Without written approval of SPORTON International Inc., the test report shall not be reproduced except in full.

The measurements and test results shown in this test report were made in accordance with the procedures and found in compliance with the limit given in **ANSI C63.10-2009** and **47 CFR FCC Part 15 Subpart C**.

The test equipment used to perform the test is calibrated and traceable to NML/ROC.



Table of Contents

1. CERTIFICATE OF COMPLIANCE	1
2. SUMMARY OF THE TEST RESULT	2
3. GENERAL INFORMATION	3
3.1. Product Details.....	3
3.2. Accessories.....	3
3.3. Table for Filed Antenna.....	4
3.4. Table for Carrier Frequencies	5
3.5. Table for Test Modes.....	5
3.6. Table for Testing Locations.....	6
3.7. Table for Supporting Units	7
3.8. Table for Parameters of Test Software Setting	8
3.9. EUT Operation during Test	8
3.10. Duty Cycle.....	9
3.11. Test Configurations	11
4. TEST RESULT	14
4.1. AC Power Line Conducted Emissions Measurement.....	14
4.2. Maximum Conducted Output Power Measurement.....	18
4.3. Hopping Channel Separation Measurement	20
4.4. Number of Hopping Frequency Measurement.....	31
4.5. Dwell Time Measurement.....	33
4.6. Radiated Emissions Measurement	40
4.7. Emissions Measurement	53
4.8. Antenna Requirements	67
5. LIST OF MEASURING EQUIPMENTS	68
6. MEASUREMENT UNCERTAINTY.....	70
APPENDIX A. TEST PHOTOS	A1 ~ A8
APPENDIX B. MAXIMUM PERMISSIBLE EXPOSURE	B1 ~ B4
APPENDIX C. RADIATED EMISSION CO-LOCATION REPORT	C1 ~ C5

History of This Test Report

REPORT NO.	VERSION	DESCRIPTION	ISSUED DATE
FR431243AC	Rev. 01	Initial issue of report	May 15, 2014

1. CERTIFICATE OF COMPLIANCE

Product Name : 802.11 abgn/11ac WLAN + Bluetooth PCI-E Mini Card
Brand Name : Broadcom
Model No. : BCM94360HMB
Applicant : Broadcom Corporation
Test Rule Part(s) : 47 CFR FCC Part 15 Subpart C § 15.247

Sporton International as requested by the applicant to evaluate the EMC performance of the product sample received on Mar. 12, 2014 would like to declare that the tested sample has been evaluated and found to be in compliance with the tested rule parts. The data recorded as well as the test configuration specified is true and accurate for showing the sample's EMC nature.

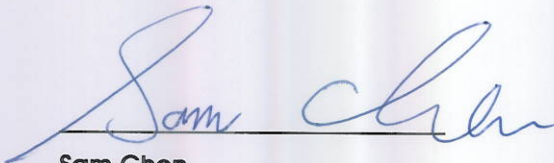

Sam Chen

SPORTON INTERNATIONAL INC.

2. SUMMARY OF THE TEST RESULT

Applied Standard: 47 CFR FCC Part 15 Subpart C				
Part	Rule Section	Description of Test	Result	Under Limit
4.1	15.207	AC Power Line Conducted Emissions	Complies	14.49 dB
4.2	15.247(b)(1)	Maximum Conducted Output Power	Complies	22.10 dB
4.3	15.247(a)(1)	Hopping Channel Separation	Complies	-
4.4	15.247(b)(1)	Number of Hopping Frequency	Complies	-
4.5	15.247(a)(1)	Dwell Time	Complies	-
4.6	15.247(d)	Radiated Emissions	Complies	4.50 dB
4.7	15.247(d)	Band Edge Emissions	Complies	12.72 dB
4.8	15.203	Antenna Requirements	Complies	-

3. GENERAL INFORMATION

3.1. Product Details

Items	Description
Power Type	From host system
Modulation	FHSS (GFSK / $\pi/4$ -DQPSK / 8DPSK)
Data Rate (Mbps)	GFSK: 1 ; $\pi/4$ -DQPSK: 2 ; 8DPSK: 3
Frequency Range	2402 ~ 2480MHz
Channel Number	79
Channel Band Width (99%)	BR (GFSK) 1 Mbps: 0.8920 MHz EDR ($\pi/4$ -DQPSK) 2 Mbps: 1.1840 MHz EDR (8DPSK) 3 Mbps: 1.1960 MHz
Maximum Conducted Output Power	BR (GFSK) 1 Mbps: -1.42 dBm EDR ($\pi/4$ -DQPSK) 2 Mbps: -2.63 dBm EDR (8DPSK) 3 Mbps: -1.10 dBm
Carrier Frequencies	Please refer to section 3.4
Antenna	Please refer to section 3.3
Note 1: Bluetooth BR uses a combination of GFSK (1Mbps).	
Note 2: Bluetooth EDR uses a combination of $\pi/4$ -DQPSK (2Mbps) and 8DPSK (3Mbps).	

3.2. Accessories

N/A

3.3. Table for Filed Antenna

Set	Ant.	Brand	Model Name	Antenna Type	Connector	Gain (dBi)				
						2.4G	5G B1	5G B2	5G B3	5G B4
1	1	Hitachi	HMT05/HFT17-DL07	WLAN/BT antenna	IPEX A13	3.9	3.9	5.6	5.8	5.8
	2	Hitachi	HMT05/HFT17-DL07	WLAN/BT antenna	IPEX A13	3.9	3.9	5.6	5.8	5.8
	3	Hitachi	HMT05/HFT17-DL07	WLAN/BT antenna	IPEX A13	3.9	3.9	5.6	5.8	5.8

Note: There are three antennas for this set.

<For 2.4GHz Band>

For IEEE 802.11b/g/n mode (3TX/3RX)

Chain 1, Chain 2 and Chain 3 can be used as transmitting/receiving antenna.

Chain 1, Chain 2 and Chain 3 could transmit/receive simultaneously.

<For 5GHz Band>

For IEEE 802.11a/n/ac mode (3TX/3RX)

Chain 1, Chain 2 and Chain 3 can be used as transmitting/receiving antenna.

Chain 1, Chain 2 and Chain 3 could transmit/receive simultaneously.

For Bluetooth mode (1TX/1RX)

Only Chain 2 can be used as transmitting/receiving antenna.

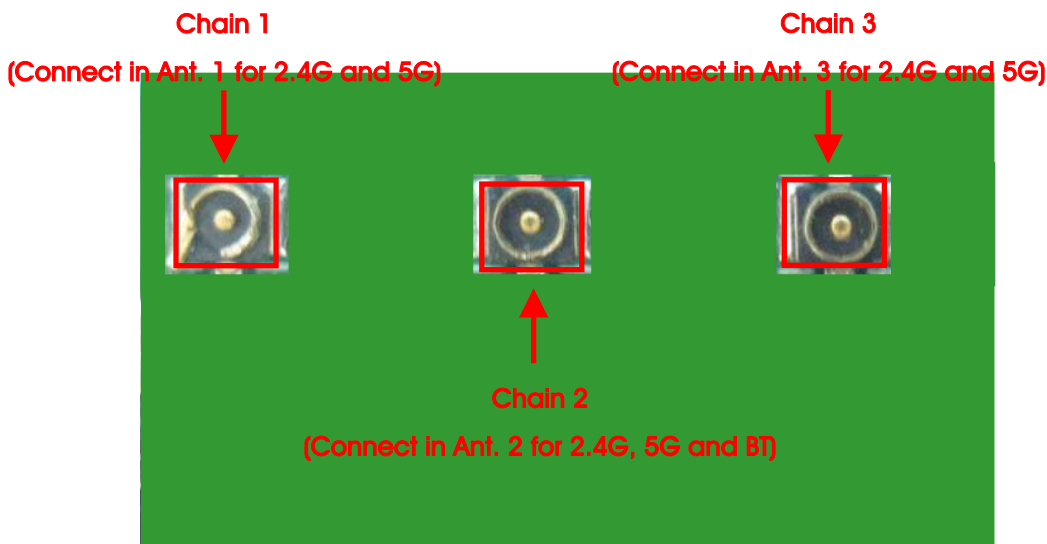

3.4. Table for Carrier Frequencies

Frequency Band	Channel No.	Frequency	Channel No.	Frequency
2400~2483.5MHz	0	2402 MHz	40	2442 MHz
	1	2403 MHz	:	:
	:	:	77	2479 MHz
	38	2440 MHz	78	2480 MHz
	39	2441 MHz	-	-

3.5. Table for Test Modes

Preliminary tests were performed in different data rate to find the worst radiated emission. The data rate shown in the table below is the worst-case rate with respect to the specific test item. Investigation has been done on all the possible configurations for searching the worst cases. The following table is a list of the test modes shown in this test report.

Test Items	Mode	Data Rate	Channel	Chain
AC Power Conducted Emissions	Normal Link	-	-	-
Maximum Conducted Output Power	BR (GFSK)	1 Mbps	0/39/78	2
	EDR ($\pi/4$ -DQPSK)	2 Mbps	0/39/78	2
	EDR (8DPSK)	3 Mbps	0/39/78	2
Hopping Channel Separation	BR (GFSK)	1 Mbps	0~1 39~40 77~78	2
	EDR ($\pi/4$ -DQPSK)	2 Mbps	0~1 39~40 77~78	2
	EDR (8DPSK)	3 Mbps	0~1 39~40 77~78	2
Number of Hopping Frequency	BR (GFSK)	1 Mbps	0~78	2
Dwell Time	BR (GFSK) (DH1, DH3, DH5)	1 Mbps	0/39/78	2
Radiated Emissions Below 1GHz	Normal Link	-	-	-
Radiated Emissions Above 1GHz	BR (GFSK)	1 Mbps	0/39/78	2
	EDR (8DPSK)	3 Mbps	0/39/78	2
Band Edge Emissions	BR (GFSK)	1 Mbps	0/39/78	2
	EDR (8DPSK)	3 Mbps	0/39/78	2

The following test modes were performed for all tests:

For Conducted Emission test:

Mode 1. 2.4GHz WLAN Function + Bluetooth Function

Mode 2. 5GHz WLAN Function + Bluetooth Function

Mode 2 is the worst case, so it was selected to record in this test report

For Radiated Emission test <Below 1GHz>:

Mode 1. 2.4GHz WLAN Function + Bluetooth Function

Mode 2. 5GHz WLAN Function + Bluetooth Function

Mode 2 is the worst case, so it was selected to record in this test report

For Radiated Emission test <Above 1GHz>:

Mode 1. CTX-EUT

For Co-location test:

Mode 1. 2.4GHz WLAN Function + Bluetooth Function

Mode 2. 5GHz WLAN Function + Bluetooth Function

For Co-location MPE and Radiated Emission Co-location Test:

The EUT could be applied 2.4GHz / 5GHz with WLAN function and Bluetooth function; therefore Co-location Maximum Permissible Exposure (please refer to Appendix B) and Radiated Emission Co-location (please refer to Appendix C) tests are added for simultaneously transmit between 2.4GHz / 5GHz WLAN function and Bluetooth function.

3.6. Table for Testing Locations

Test Site Location					
Address:	No.8, Lane 724, Bo-ai St., Jhubei City, Hsinchu County 302, Taiwan, R.O.C.				
TEL:	886-3-656-9065				
FAX:	886-3-656-9085				
Test Site No.	Site Category	Location	FCC Reg. No.	IC File No.	VCCI Reg. No
03CH01-CB	SAC	Hsin Chu	262045	IC 4086D	-
CO01-CB	Conduction	Hsin Chu	262045	IC 4086D	-
TH01-CB	OVEN Room	Hsin Chu	-	-	-

Open Area Test Site (OATS); Semi Anechoic Chamber (SAC).

3.7. Table for Supporting Units

For Test Site No: CO01-CB

Support Unit	Brand	Model	FCC ID
AP Router	Planex	GW-AP54SGX	KA220030603014-1
NB	DELL	E6430	DoC
802.11abgn/11ac WLAN + Bluetooth PCI-E Mini Card (Device)	Broadcom	BCM94360HMB	QDS-BRCM1082
NB	DELL	E6510	N/A
Mouse	Logitech	M-U0026	DoC
Earphone	SHYARO CHI	MIC-04	N/A
Test Fixture*2	Broadcom	BCM9MC2EC	N/A

For Test Site No: 03CH01-CB<Below 1GHz>

Support Unit	Brand	Model	FCC ID
NB	DELL	E4300	RSE-TG233
Mouse	Logitech	M-B0001	HC238HR00XY
Earphone	E-BOOKI	E-EPC040	N/A
NB	DELL	M1340	E2K4965AGNM
Wireless AP	Netgear	R7000	PY313200233
802.11abgn/11ac WLAN + Bluetooth PCI-E Mini Card (Device)	Broadcom	BCM94360HMB	QDS-BRCM1082
Test Fixture*2	Broadcom	BCM9MC2EC	N/A

For Test Site No: 03CH01-CB<Abvoe 1GHz>

Support Unit	Brand	Model	FCC ID
NB	DELL	E4300	RSE-TG233
Test Fixture*2	Broadcom	BCM9MC2EC	N/A

For Test Site No: TH01-CB

Support Unit	Brand	Model	FCC ID
NB	DELL	E6430	DoC

3.8. Table for Parameters of Test Software Setting

During testing, Channel and Power Controlling Software provided by the customer was used to control the operating channel as well as the output power level. The RF output power selection is for the setting of RF output power expected by the customer and is going to be fixed on the firmware of the final end product.

Power Parameters of Bluetooth

For BR (GFSK) 1 Mbps:

Test Software Version	Broadcom BlueTool v1.8.4.8		
Frequency	2402 MHz	2441 MHz	2480 MHz
Power Parameters	0	0	0

For EDR ($\pi/4$ -DQPSK) 2 Mbps:

Test Software Version	Broadcom BlueTool v1.8.4.8		
Frequency	2402 MHz	2441 MHz	2480 MHz
Power Parameters	0	0	0

For EDR (8DPSK) 3 Mbps:

Test Software Version	Broadcom BlueTool v1.8.4.8		
Frequency	2402 MHz	2441 MHz	2480 MHz
Power Parameters	0	0	0

3.9. EUT Operation during Test

The EUT was programmed to be in continuously transmitting mode.

3.10. Duty Cycle

Mode	TX-on (ms)	TX-on+TX-off (ms)	TX-on/(TX-on+TX-off)x100= Duty cycle (%)	Duty Factor (dB)
BR (GFSK)	2.90	3.68	78.80%	1.03
EDR ($\pi/4$ -DQPSK)	2.90	3.66	79.23%	1.01
EDR (8DPSK)	2.90	3.68	78.80%	1.03

BR (GFSK)

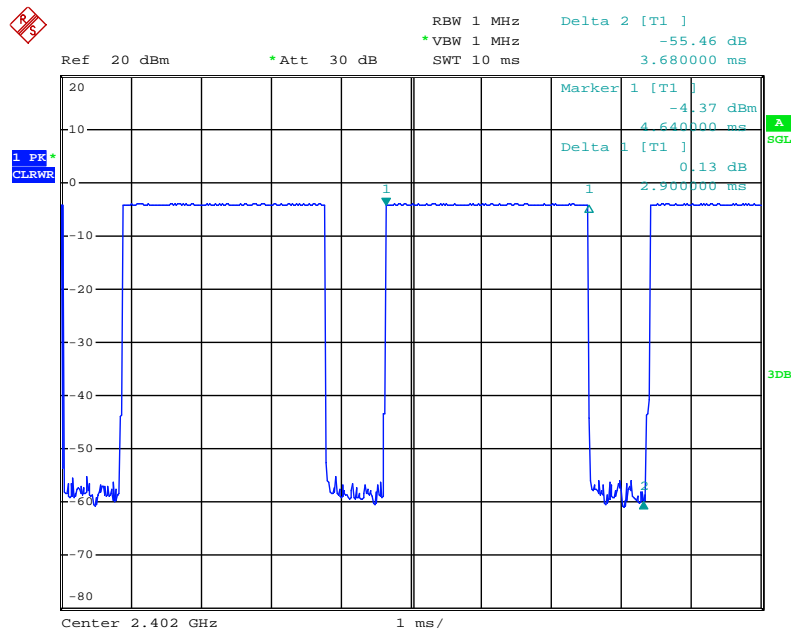

Date: 5.MAY.2014 21:03:37

EDR ($\pi/4$ -DQPSK)

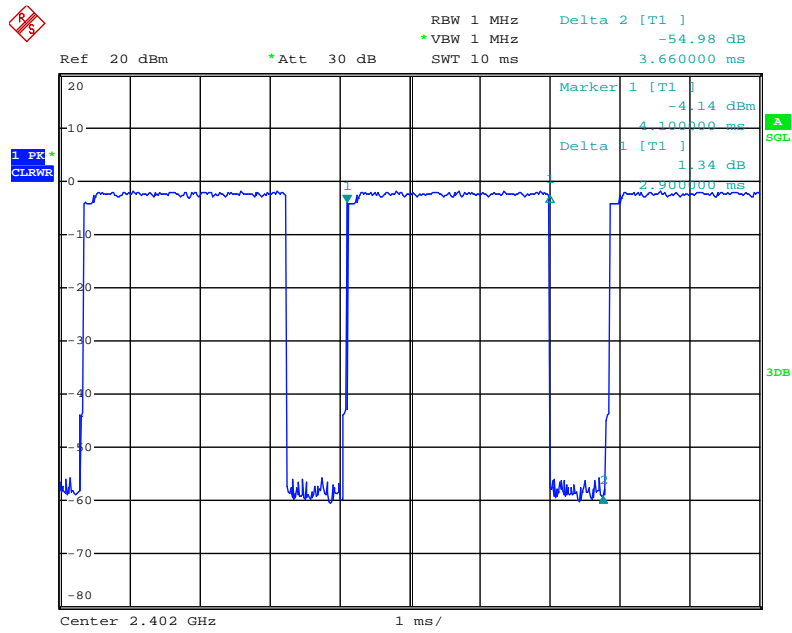

Date: 5.MAY.2014 21:02:36

EDR (8DPSK)

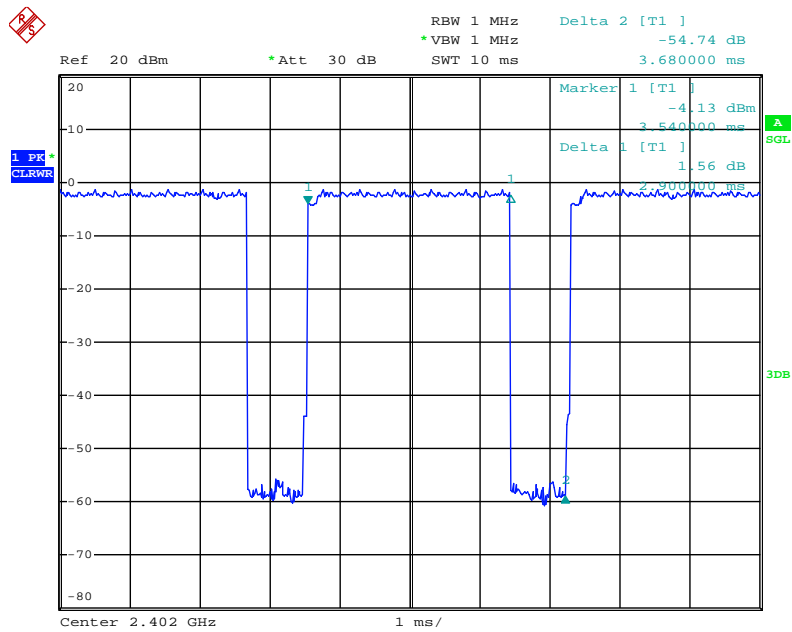

Date: 5.MAY.2014 20:15:14

3.11. Test Configurations

3.11.1. AC Power Line Conduction Emissions Test Configuration

Test Mode: Mode 2

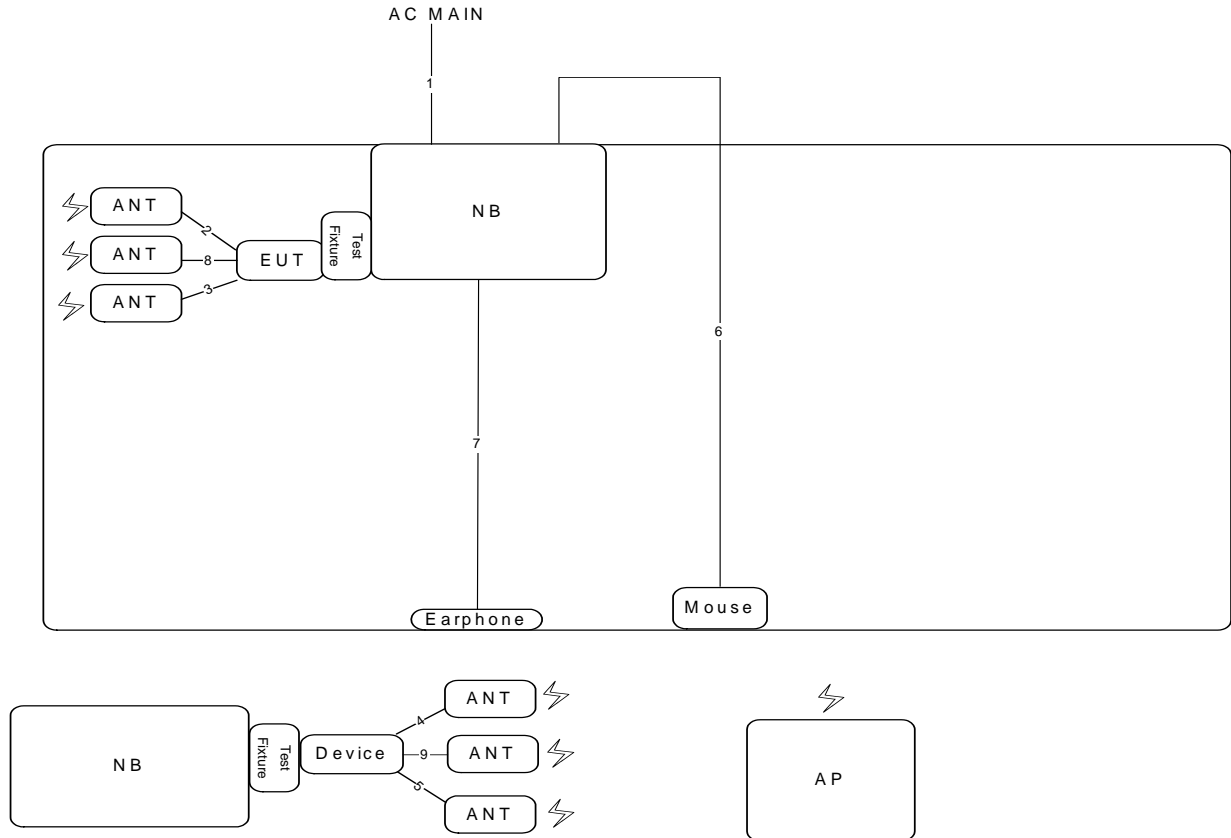

Item	Connection	Shield	Length
1	Power cable	No	2.6m
2	ANT cable	Yes	0.2m
3	ANT cable	Yes	0.2m
4	ANT cable	Yes	0.2m
5	ANT cable	Yes	0.2m
6	USB cable	Yes	1.8m
7	Audio cable	No	1.5m
8	ANT cable	Yes	0.2m
9	ANT cable	Yes	0.2m

3.11.2. Radiation Emissions Test Configuration

Test Configuration: 30MHz~1GHz / Test Mode 2

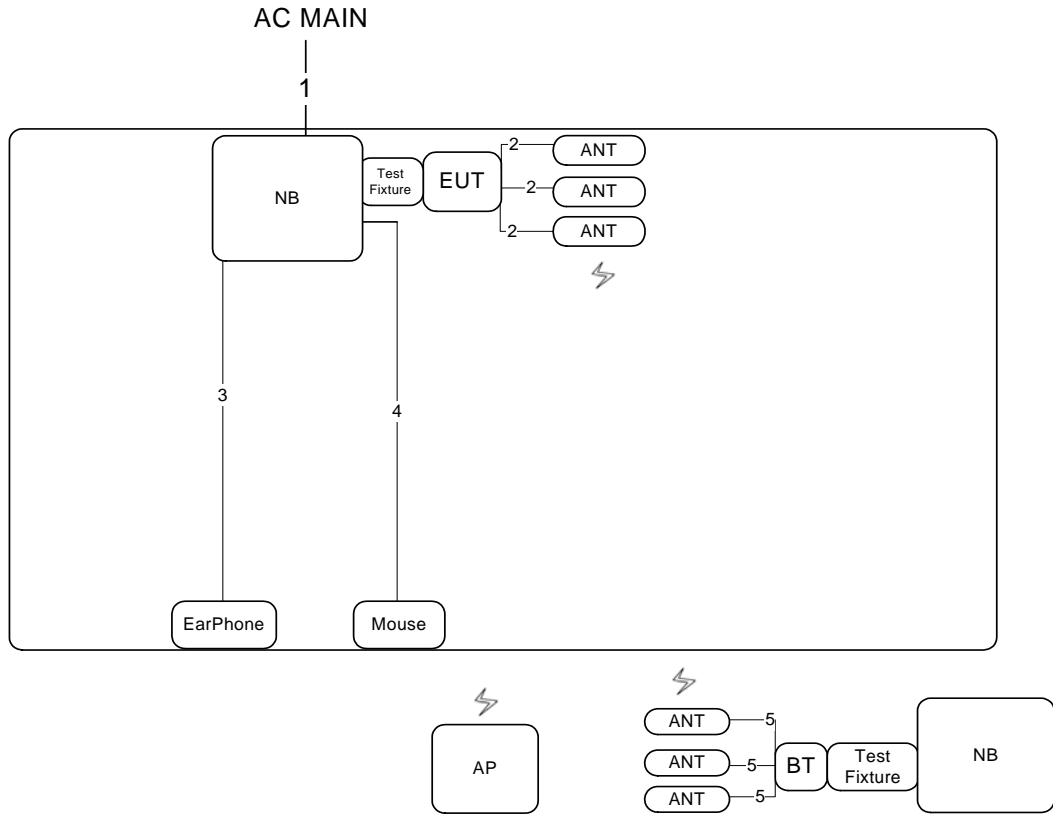

Item	Connection	Shield	Length
1	Power cable	No	2.6m
2	ANT cable*3	Yes	0.2m
3	Audio cable	No	1.1m
4	USB cable	Yes	1.8m
5	ANT cable*3	Yes	0.2m

Test Configuration: above 1GHz

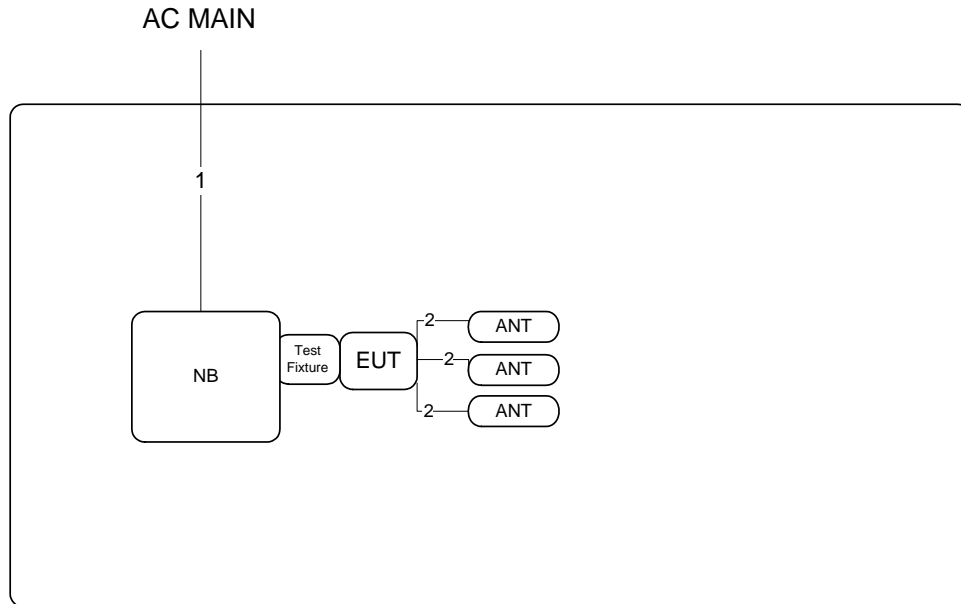

Item	Connection	Shield	Length
1	Power cable	No	1.8m
2	ANT cable*3	Yes	0.2m

4. TEST RESULT

4.1. AC Power Line Conducted Emissions Measurement

4.1.1. Limit

For a Low-power Radio-frequency Device which is designed to be connected to the AC power line, the radio frequency voltage that is conducted back onto the AC power line on any frequency or frequencies within the band 150 kHz to 30 MHz shall not exceed below limits table.

Frequency (MHz)	QP Limit (dBuV)	AV Limit (dBuV)
0.15~0.5	66~56	56~46
0.5~5	56	46
5~30	60	50

4.1.2. Measuring Instruments and Setting

Please refer to section 5 of equipments list in this report. The following table is the setting of the receiver.

Receiver Parameters	Setting
Attenuation	10 dB
Start Frequency	0.15 MHz
Stop Frequency	30 MHz
IF Bandwidth	9 kHz

4.1.3. Test Procedures

1. Configure the EUT according to ANSI C63.10. The EUT or host of EUT has to be placed 0.4 meter far from the conducting wall of the shielding room and at least 80 centimeters from any other grounded conducting surface.
2. Connect EUT or host of EUT to the power mains through a line impedance stabilization network (LISN).
3. All the support units are connected to the other LISNs. The LISN should provide 50uH/50ohms coupling impedance.
4. The frequency range from 150 kHz to 30 MHz was searched.
5. Set the test-receiver system to Peak Detect Function and Specified Bandwidth with Maximum Hold Mode.
6. The measurement has to be done between each power line and ground at the power terminal.

4.1.4. Test Setup Layout

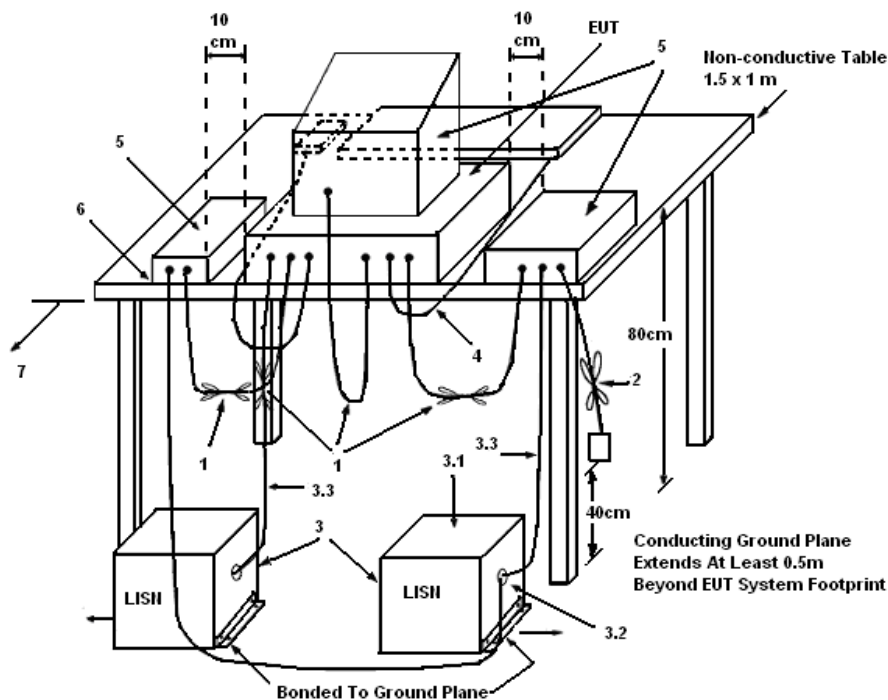

LEGEND:

- (1) Interconnecting cables that hang closer than 40 cm to the ground plane shall be folded back and forth in the center forming a bundle 30 to 40 cm long.
- (2) I/O cables that are not connected to a peripheral shall be bundled in the center. The end of the cable may be terminated, if required, using the correct terminating impedance. The overall length shall not exceed 1 m.
- (3) EUT connected to one LISN. Unused LISN measuring port connectors shall be terminated in 50 Ω. LISN can be placed on top of, or immediately beneath, reference ground plane.
 - (3.1) All other equipment powered from additional LISN(s).
 - (3.2) Multiple outlet strip can be used for multiple power cords of non-EUT equipment.
 - (3.3) LISN at least 80 cm from nearest part of EUT chassis.
- (4) Cables of hand-operated devices, such as keyboards, mice, etc., shall be placed as for normal use.
- (5) Non-EUT components of EUT system being tested.
- (6) Rear of EUT, including peripherals, shall all be aligned and flush with rear of tabletop.
- (7) Rear of tabletop shall be 40 cm removed from a vertical conducting plane that is bonded to the ground plane.

4.1.5. Test Deviation

There is no deviation with the original standard.

4.1.6. EUT Operation during Test

The EUT was placed on the test table and programmed in normal function.

4.1.7. Results of AC Power Line Conducted Emissions Measurement

Temperature	20°C	Humidity	52%
Test Engineer	Parody Lin	Phase	Line
Configuration	Normal Link	Test Mode	Mode 2

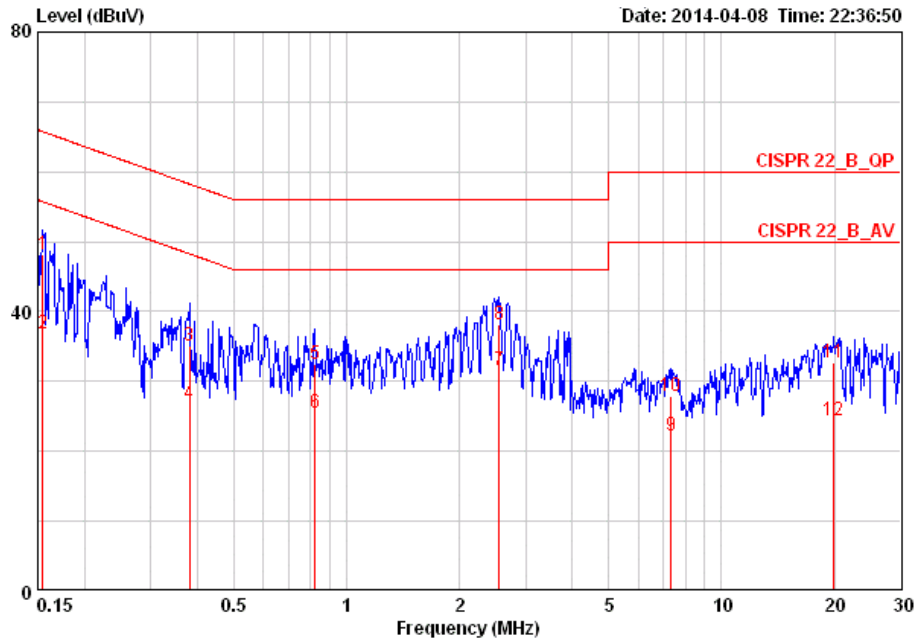

	Freq	Level	Over Limit	Limit Line	LISN Factor	Read Level	Cable Loss	Pol/Phase	Remark
	MHz	dBuV	dB	dBuV	dB	dBuV	dB		
1	0.15485	48.09	-17.64	65.74	0.15	47.76	0.18	LINE	QP
2	0.15485	36.89	-18.84	55.74	0.15	36.56	0.18	LINE	AVERAGE
3	0.38113	35.03	-23.22	58.25	0.15	34.68	0.20	LINE	QP
4	0.38113	26.72	-21.53	48.25	0.15	26.37	0.20	LINE	AVERAGE
5	0.82172	32.46	-23.54	56.00	0.16	32.10	0.20	LINE	QP
6	0.82172	25.51	-20.49	46.00	0.16	25.15	0.20	LINE	AVERAGE
7	2.554	31.51	-14.49	46.00	0.22	31.05	0.24	LINE	AVERAGE
8	2.554	38.06	-17.94	56.00	0.22	37.60	0.24	LINE	QP
9	7.329	22.32	-27.68	50.00	0.33	21.69	0.30	LINE	AVERAGE
10	7.329	27.94	-32.06	60.00	0.33	27.31	0.30	LINE	QP
11	19.950	32.76	-27.24	60.00	0.60	31.66	0.50	LINE	QP
12	19.950	24.41	-25.59	50.00	0.60	23.31	0.50	LINE	AVERAGE

Temperature	20°C	Humidity	52%
Test Engineer	Parody Lin	Phase	Neutral
Configuration	Normal Link	Test Mode	Mode 2

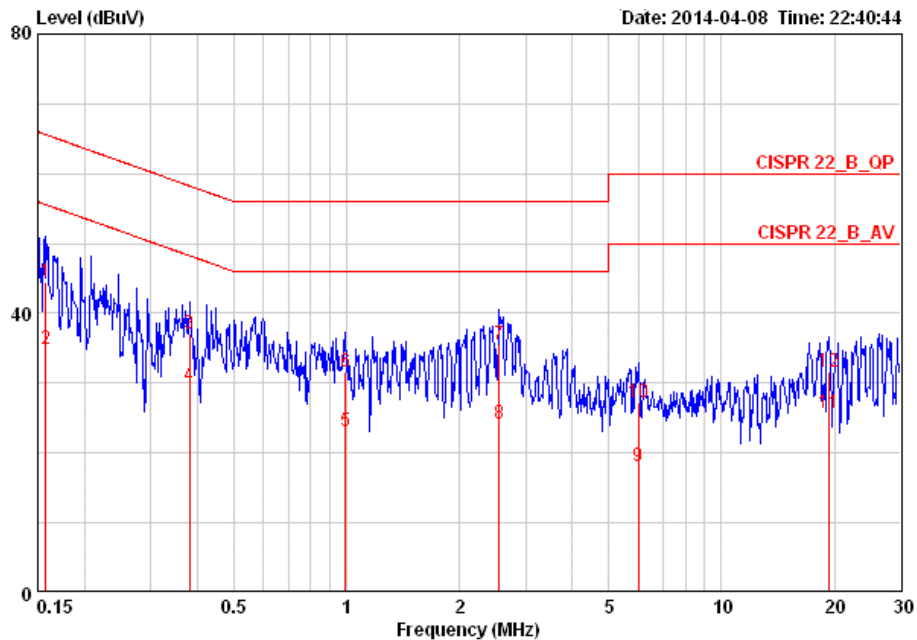

	Freq	Level	Over Limit	Limit Line	LISN Factor	Read Level	Cable Loss	Pol/Phase	Remark
	MHz	dBuV	dB	dBuV	dB	dBuV	dB		
1	0.15733	44.53	-21.07	65.60	0.07	44.28	0.18	NEUTRAL	QP
2	0.15733	34.81	-20.79	55.60	0.07	34.56	0.18	NEUTRAL	AVERAGE
3	0.38113	37.11	-21.14	58.25	0.07	36.84	0.20	NEUTRAL	QP
4	0.38113	29.57	-18.68	48.25	0.07	29.30	0.20	NEUTRAL	AVERAGE
5	0.99440	23.06	-22.94	46.00	0.08	22.83	0.15	NEUTRAL	AVERAGE
6	0.99440	31.53	-24.47	56.00	0.08	31.30	0.15	NEUTRAL	QP
7	2.554	35.64	-20.36	56.00	0.12	35.28	0.24	NEUTRAL	QP
8	2.554	24.29	-21.71	46.00	0.12	23.93	0.24	NEUTRAL	AVERAGE
9	5.993	18.15	-31.85	50.00	0.18	17.64	0.33	NEUTRAL	AVERAGE
10	5.993	27.20	-32.80	60.00	0.18	26.69	0.33	NEUTRAL	QP
11	19.326	25.76	-24.24	50.00	0.44	24.82	0.50	NEUTRAL	AVERAGE
12	19.326	31.65	-28.35	60.00	0.44	30.71	0.50	NEUTRAL	QP

Note: Level = Read Level + LISN Factor + Cable Loss.

4.2. Maximum Conducted Output Power Measurement

4.2.1. Limit

For frequency hopping systems operating in the 2400-2483.5 MHz band employing at least 75 non-overlapping hopping channels, the limit for peak output power is 1Watt (30dBm). For all other frequency hopping systems in the 2400-2483.5 MHz band: 0.125 watts (21dBm). The limited has to be reduced by the amount in dB that the gain of the antenna exceed 6dBi. In case of point-to-point operation, the limit has to be reduced by 1dB for every 3dB that the directional gain of the antenna exceeds 6dBi.

4.2.2. Measuring Instruments and Setting

Please refer to section 5 of equipments list in this report. The following table is the setting of the power meter.

Power Meter Parameter	Setting
Bandwidth	50MHz bandwidth is greater than the EUT emission bandwidth
Detector	Peak and Average

4.2.3. Test Procedures

This procedure provides an alternative for determining the RMS output power using a broadband RF average power meter with a thermocouple detector.

4.2.4. Test Setup Layout

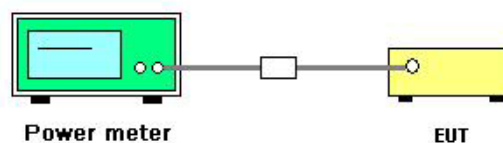

4.2.5. Test Deviation

There is no deviation with the original standard.

4.2.6. EUT Operation during Test

The EUT was programmed to be in continuously transmitting mode.

4.2.7. Test Result of Maximum Conducted Output Power

Temperature	20°C	Humidity	52%
Test Engineer	David Tseng	Configurations	GFSK, $\pi/4$ -DQPSK, 8DPSK
Test Date	May 05, 2014		

For BR (GFSK) 1 Mbps:

Channel	Frequency	Conducted Average Power (dBm)	Conducted Peak Power (dBm)	Max. Limit (dBm)	Result
0	2402 MHz	-1.73	-1.54	21.00	Complies
39	2441 MHz	-1.68	-1.42	21.00	Complies
78	2480 MHz	-1.60	-1.57	21.00	Complies

For EDR ($\pi/4$ -DQPSK) 2 Mbps:

Channel	Frequency	Conducted Average Power (dBm)	Conducted Peak Power (dBm)	Max. Limit (dBm)	Result
0	2402 MHz	-3.02	-2.63	21.00	Complies
39	2441 MHz	-3.01	-2.75	21.00	Complies
78	2480 MHz	-2.72	-2.65	21.00	Complies

For EDR (8DPSK) 3 Mbps:

Channel	Frequency	Conducted Average Power (dBm)	Conducted Peak Power (dBm)	Max. Limit (dBm)	Result
0	2402 MHz	-1.45	-1.18	21.00	Complies
39	2441 MHz	-1.41	-1.23	21.00	Complies
78	2480 MHz	-1.35	-1.10	21.00	Complies

4.3. Hopping Channel Separation Measurement

4.3.1. Limit

Frequency hopping systems shall have hopping channel carrier frequencies separated by a minimum of 25 kHz or the 20 dB bandwidth of the hopping channel, whichever is greater. Alternatively, frequency hopping systems operating in the 2400-2483.5 MHz band may have hopping channel carrier frequencies that are separated by 25 kHz or two-thirds of the 20 dB bandwidth of the hopping channel, whichever is greater.

4.3.2. Measuring Instruments and Setting

Please refer to section 5 of equipments list in this report. The following table is the setting of spectrum analyzer.

Spectrum Parameter	Setting
Attenuation	Auto
Span Frequency	> Measurement Bandwidth or Channel Separation
RBW	30 kHz (20dB Bandwidth) / 100 kHz (Channel Separation)
VBW	100 kHz (20dB Bandwidth) / 100 kHz (Channel Separation)
Detector	Peak
Trace	Max Hold
Sweep Time	Auto

4.3.3. Test Procedures

1. The transmitter output (antenna port) was connected to the spectrum analyzer in peak hold mode.
2. The resolution bandwidth of 30 kHz and the video bandwidth of 100 kHz were utilized for 20 dB bandwidth measurement.
3. The resolution bandwidth of 100 kHz and the video bandwidth of 100 kHz were utilized for channel separation measurement.

4.3.4. Test Setup Layout

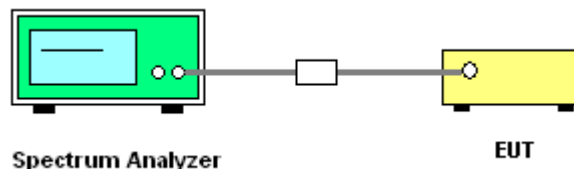

4.3.5. Test Deviation

There is no deviation with the original standard.

4.3.6. EUT Operation during Test

The EUT was programmed to be in continuously transmitting mode.

4.3.7. Test Result of Hopping Channel Separation

Temperature	20°C	Humidity	52%
Test Engineer	David Tseng	Configurations	GFSK, $\pi/4$ -DQPSK, 8DPSK

For BR (GFSK) 1 Mbps:

Frequency	20dB Bandwidth (MHz)	99% Occupied Bandwidth (MHz)	Ch. Separation (MHz)	Two-Thirds of 20dB Bandwidth (MHz)	Result
2402 MHz	0.9280	0.8680	1.00	0.619	Complies
2441 MHz	1.0040	0.8920	1.00	0.669	Complies
2480 MHz	0.9400	0.8600	1.00	0.627	Complies

Ch. Separation Limits: >20dB bandwidth or > Two-Thirds of 20dB bandwidth

For EDR ($\pi/4$ -DQPSK) 2 Mbps:

Frequency	20dB Bandwidth (MHz)	99% Occupied Bandwidth (MHz)	Ch. Separation (MHz)	Two-Thirds of 20dB Bandwidth (MHz)	Result
2402 MHz	1.3200	1.1800	1.00	0.880	Complies
2441 MHz	1.3160	1.1840	1.00	0.877	Complies
2480 MHz	1.3120	1.1840	1.00	0.875	Complies

Ch. Separation Limits: >20dB bandwidth or > Two-Thirds of 20dB bandwidth

For EDR (8DPSK) 3 Mbps:

Frequency	20dB Bandwidth (MHz)	99% Occupied Bandwidth (MHz)	Ch. Separation (MHz)	Two-Thirds of 20dB Bandwidth (MHz)	Result
2402 MHz	1.3040	1.1840	1.00	0.869	Complies
2441 MHz	1.3360	1.1960	1.00	0.891	Complies
2480 MHz	1.2880	1.1920	1.00	0.859	Complies

Ch. Separation Limits: >20dB bandwidth or > Two-Thirds of 20dB bandwidth

20 dB Bandwidth Plot on BR (GFSK) 1 Mbps / Channel 0 / 2402 MHz

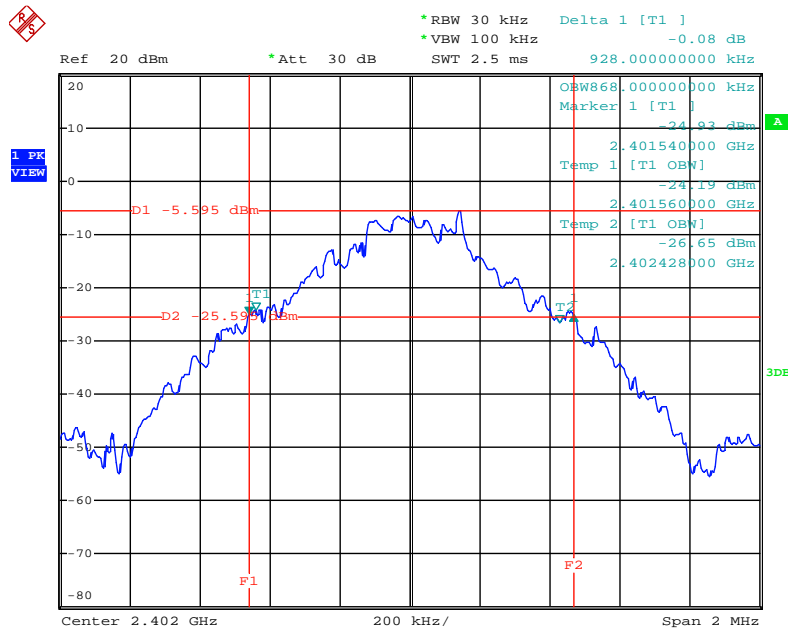

Date: 5.MAY.2014 20:28:58

20 dB Bandwidth Plot on BR (GFSK) 1 Mbps / Channel 39 / 2441 MHz

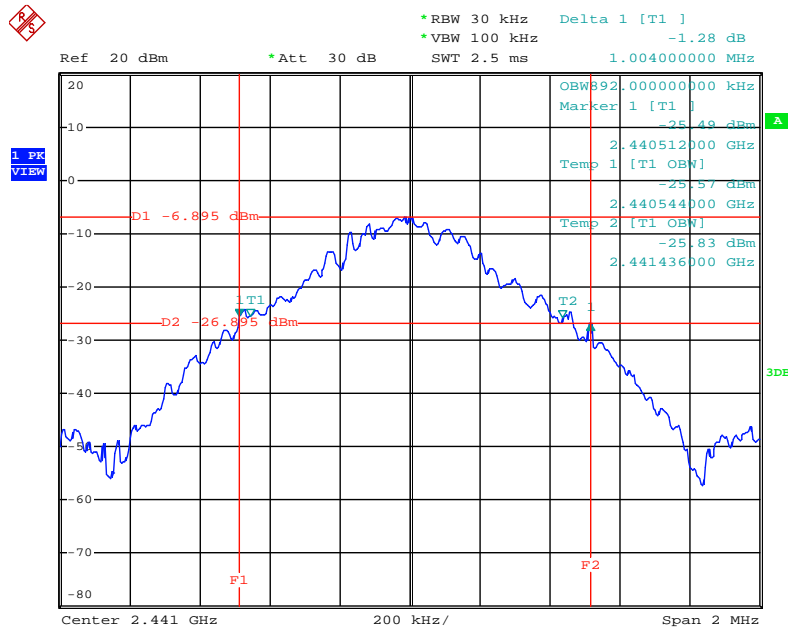

Date: 5.MAY.2014 20:32:17

20 dB Bandwidth Plot on BR (GFSK) 1 Mbps / Channel 78 / 2480 MHz

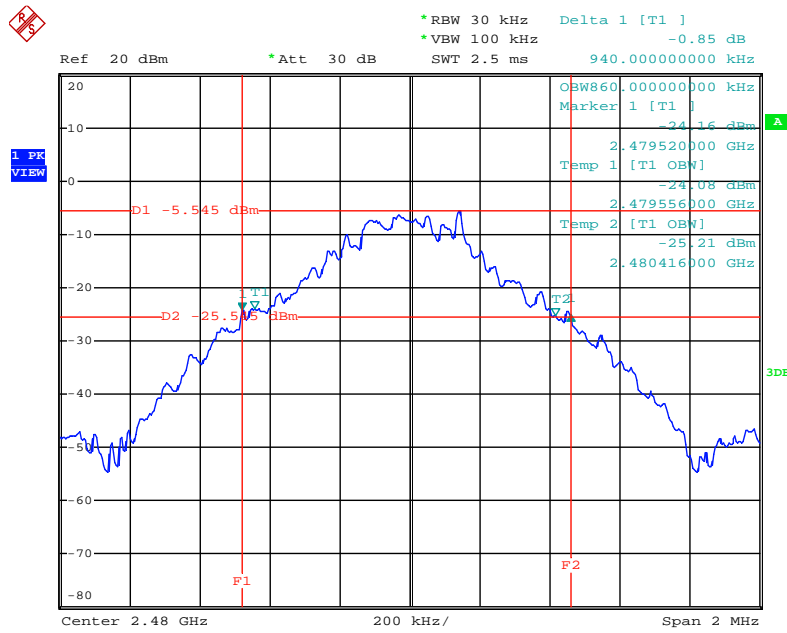

Date: 5.MAY.2014 20:32:51

Channel Separation Plot on BR (GFSK) 1 Mbps / Channel 0~1 / 2402 MHz ~ 2403 MHz

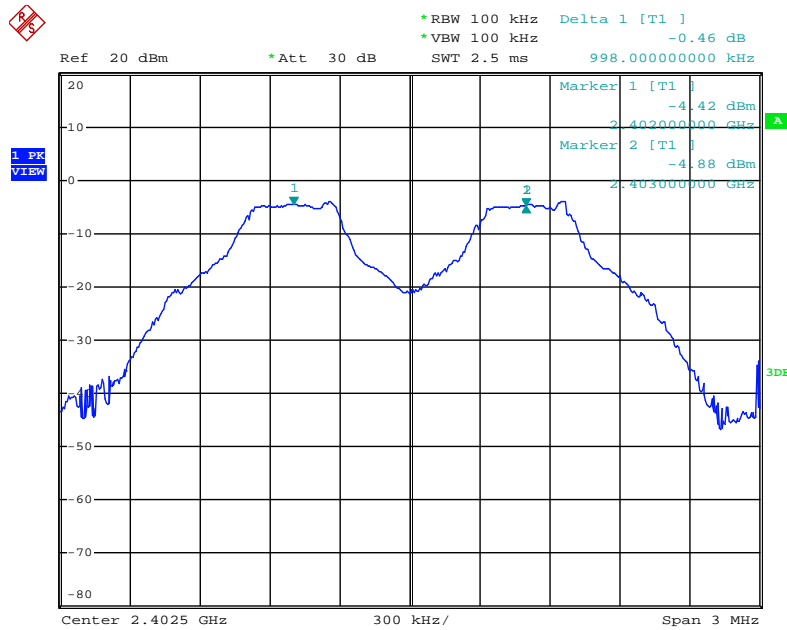

Date: 5.MAY.2014 21:07:44

Channel Separation Plot on BR (GFSK) 1 Mbps / Channel 39~40 / 2441 MHz ~ 2442 MHz

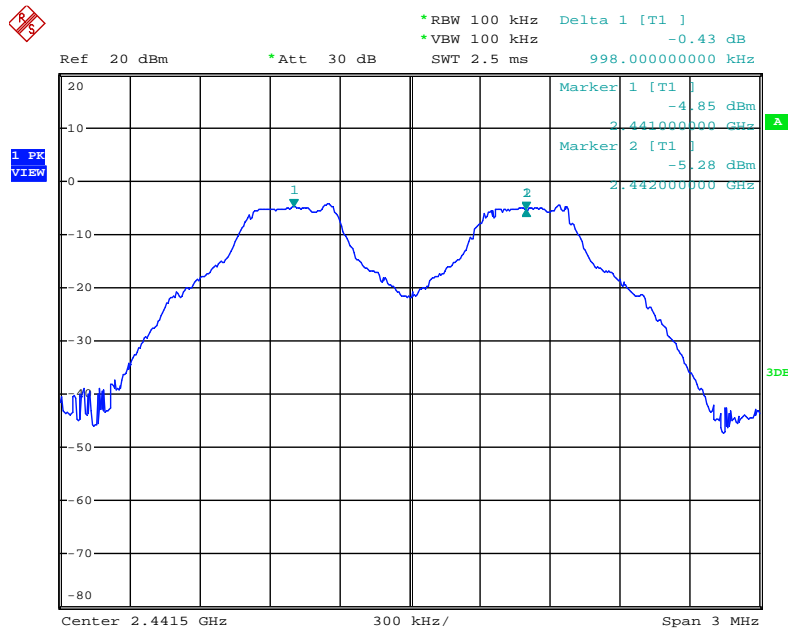

Date: 5.MAY.2014 21:09:17

Channel Separation Plot on BR (GFSK) 1 Mbps / Channel 77~78 / 2479 MHz ~ 2480 MHz

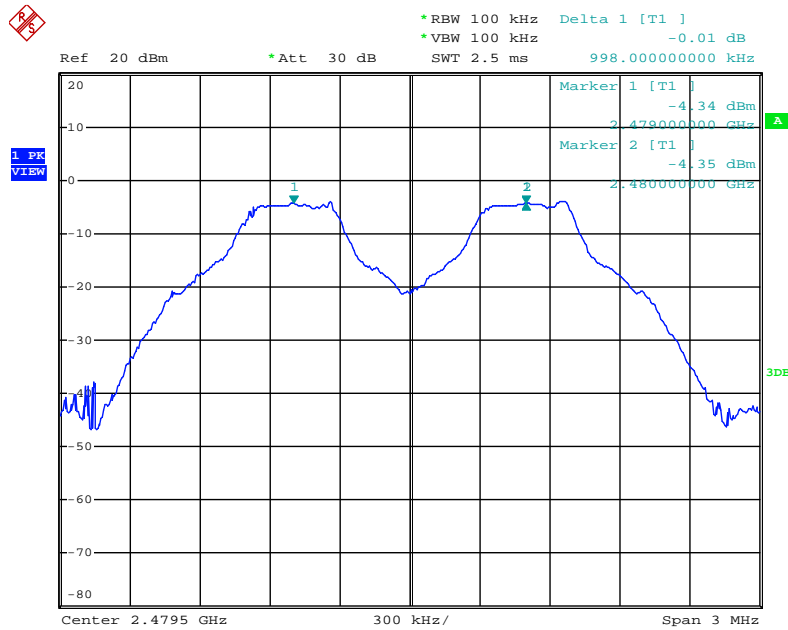

Date: 5.MAY.2014 21:10:34

20 dB Bandwidth Plot on EDR ($\pi/4$ -DQPSK) 2 Mbps / Channel 0 / 2402 MHz

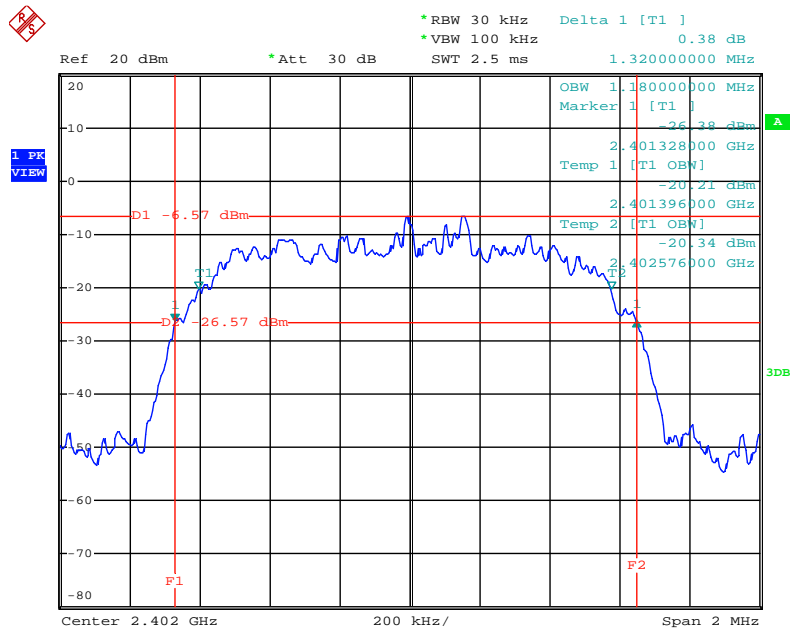

Date: 5.MAY.2014 20:25:17

20 dB Bandwidth Plot on EDR ($\pi/4$ -DQPSK) 2 Mbps / Channel 39 / 2441 MHz

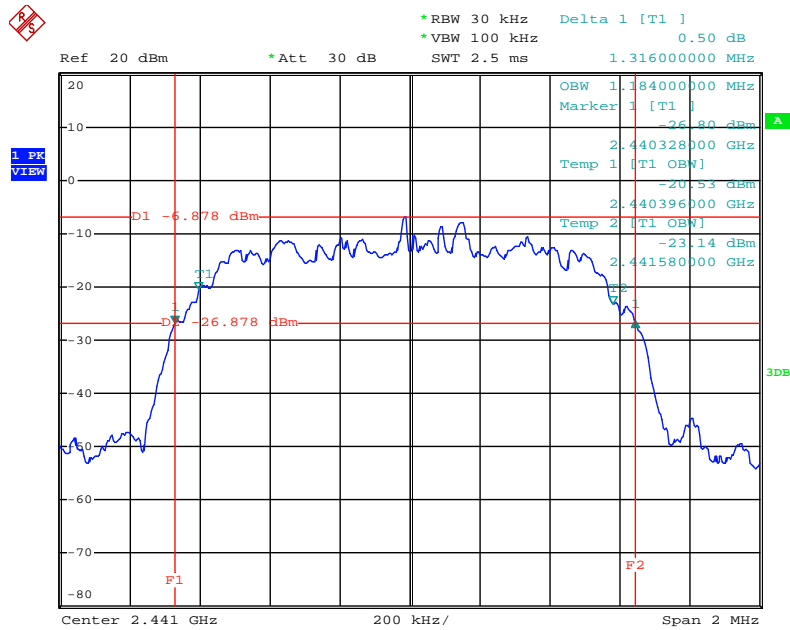

Date: 5.MAY.2014 20:23:56

20 dB Bandwidth Plot on EDR ($\pi/4$ -DQPSK) 2 Mbps / Channel 78 / 2480 MHz

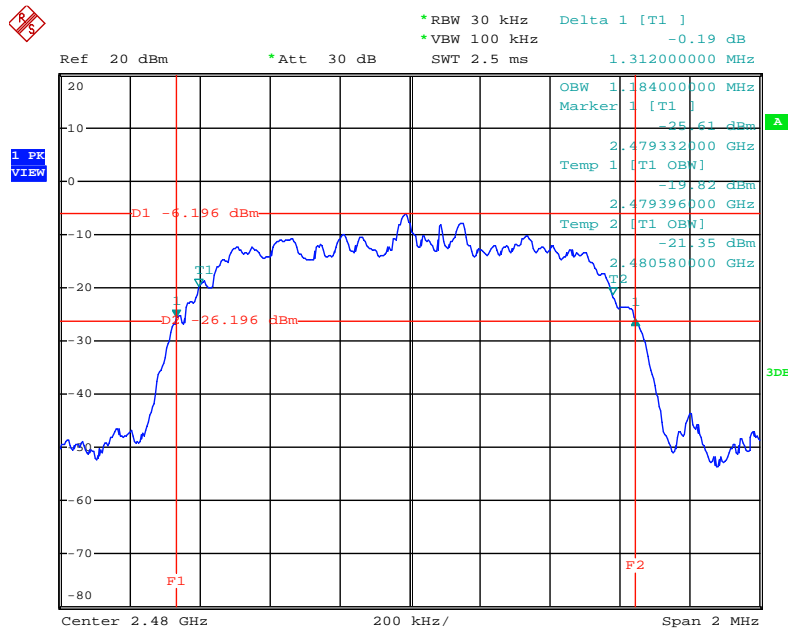

Date: 5.MAY.2014 20:22:25

Channel Separation Plot on EDR ($\pi/4$ -DQPSK) 2 Mbps / Channel 0~1 / 2402 MHz ~ 2403 MHz

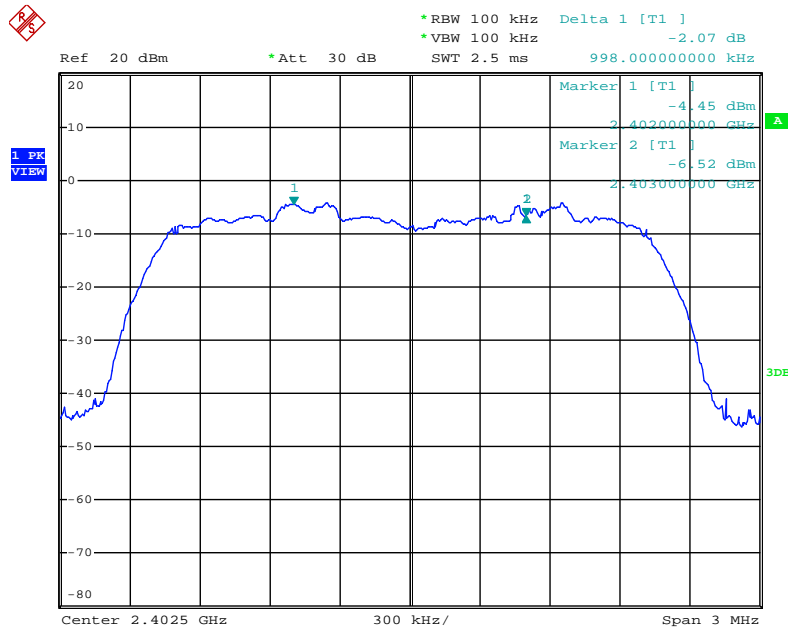

Date: 5.MAY.2014 21:12:44

Channel Separation Plot on EDR ($\pi/4$ -DQPSK) 2 Mbps / Channel 39~40 / 2441 MHz ~ 2442 MHz

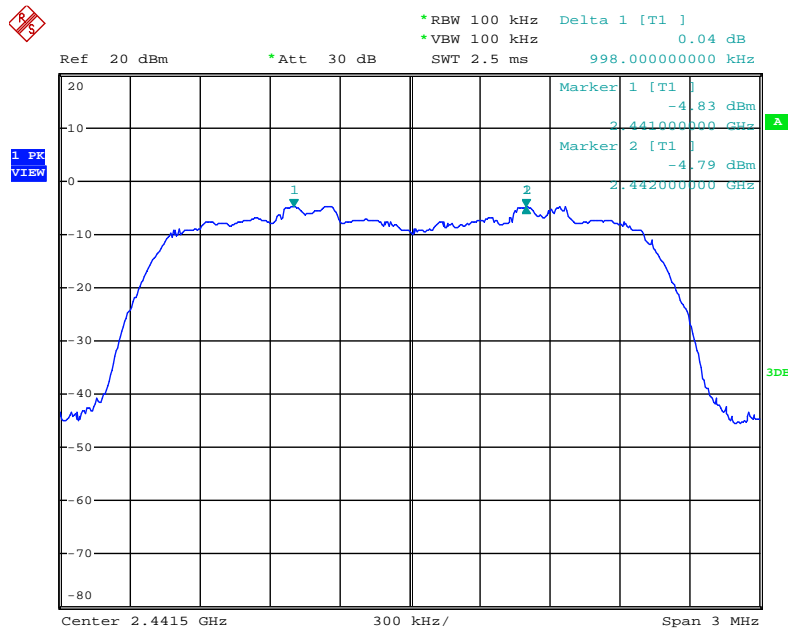

Date: 5.MAY.2014 21:14:00

Channel Separation Plot on EDR ($\pi/4$ -DQPSK) 2 Mbps / Channel 77~78 / 2479 MHz ~ 2480 MHz

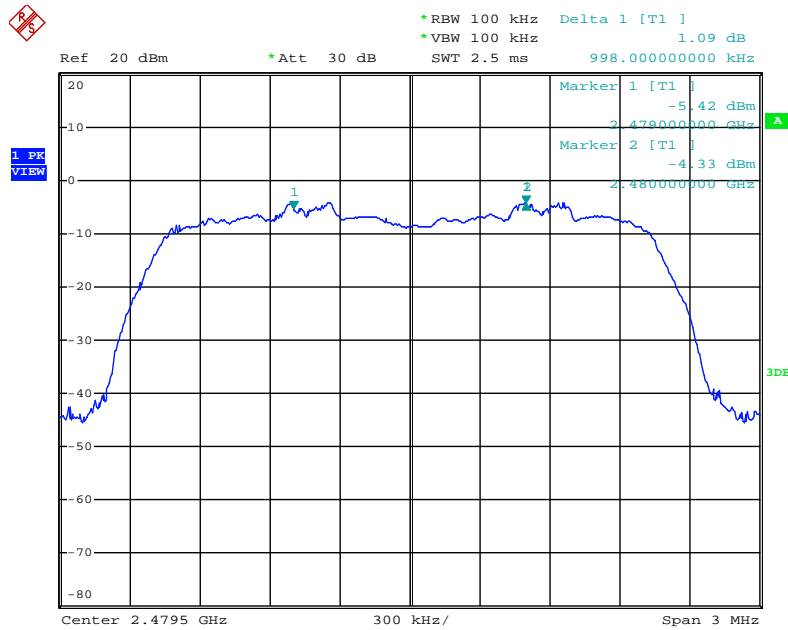

Date: 5.MAY.2014 21:14:48

20 dB Bandwidth Plot on EDR (8DPSK) 3 Mbps / Channel 0 / 2402 MHz

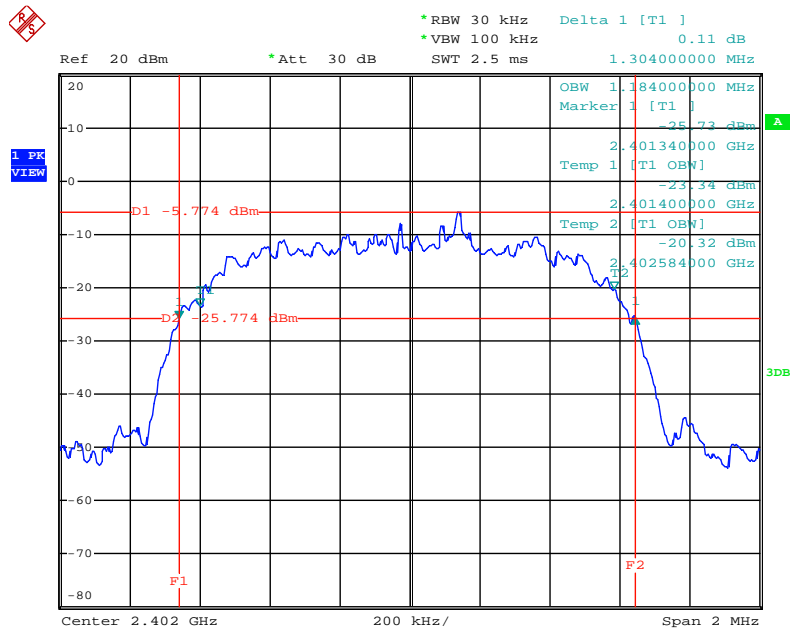

Date: 5.MAY.2014 20:26:03

20 dB Bandwidth Plot on EDR (8DPSK) 3 Mbps / Channel 39 / 2441 MHz

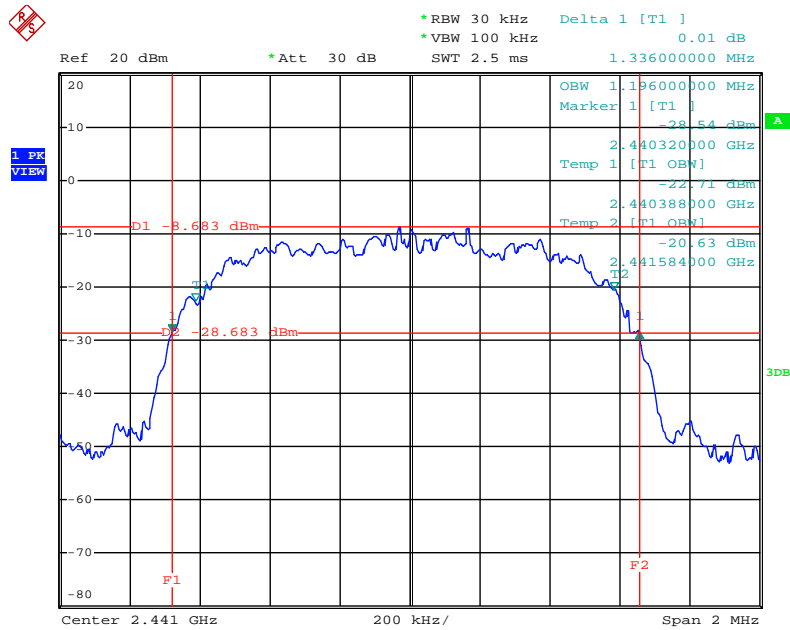

Date: 5.MAY.2014 20:26:58

20 dB Bandwidth Plot on EDR (8DPSK) 3 Mbps / Channel 78 / 2480 MHz

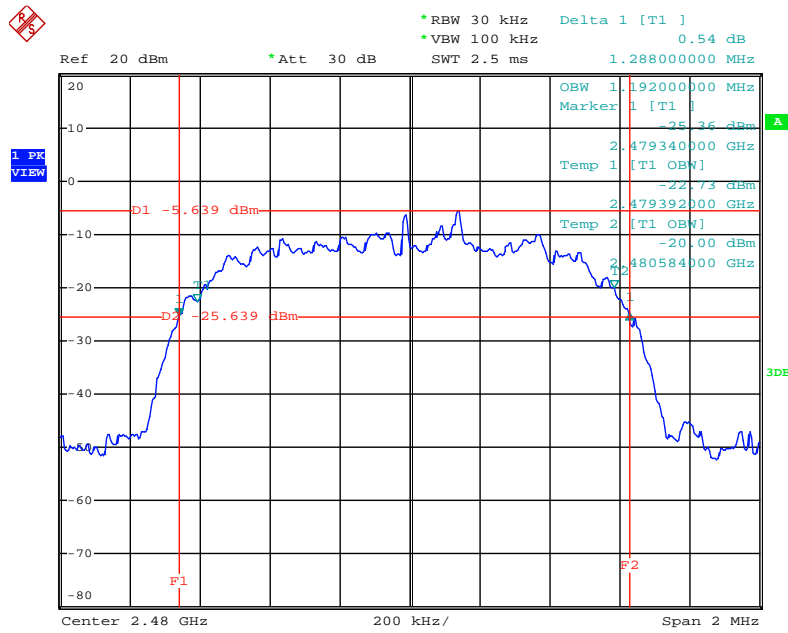

Date: 5.MAY.2014 20:27:42

Channel Separation Plot on EDR (8DPSK) 3 Mbps / Channel 0~1 / 2402 MHz ~ 2403 MHz

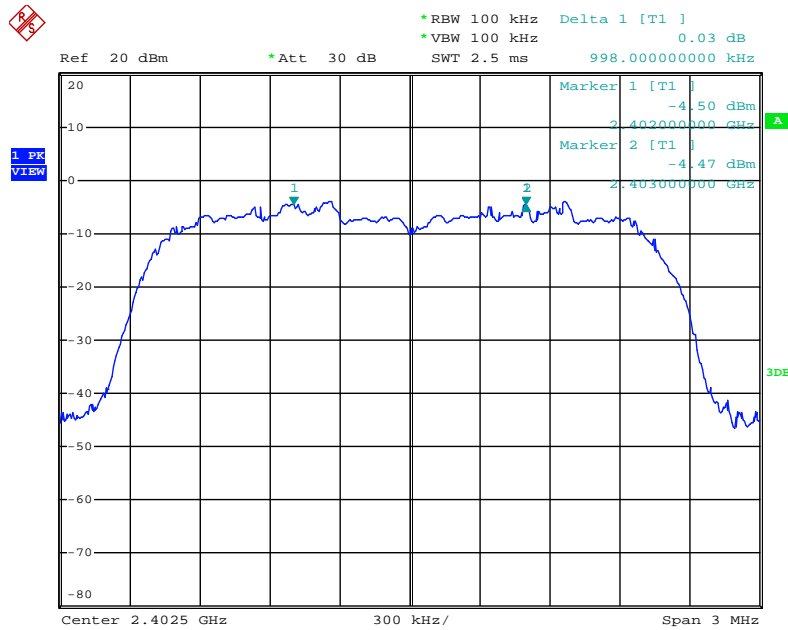

Date: 5.MAY.2014 21:17:38

Channel Separation Plot on EDR (8DPSK) 3 Mbps / Channel 39~40 / 2441 MHz ~ 2442 MHz

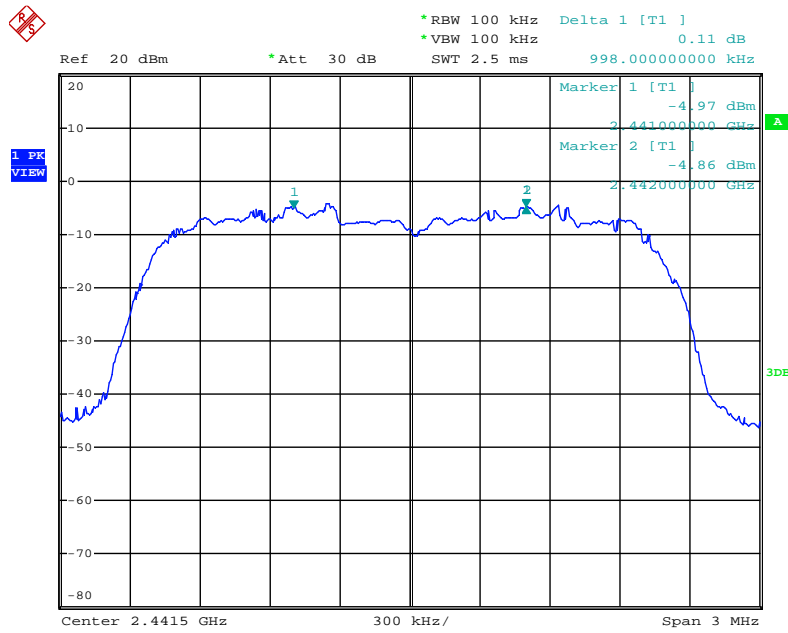

Date: 5.MAY.2014 21:16:46

Channel Separation Plot on EDR (8DPSK) 3 Mbps / Channel 77~78 / 2479 MHz ~ 2480 MHz

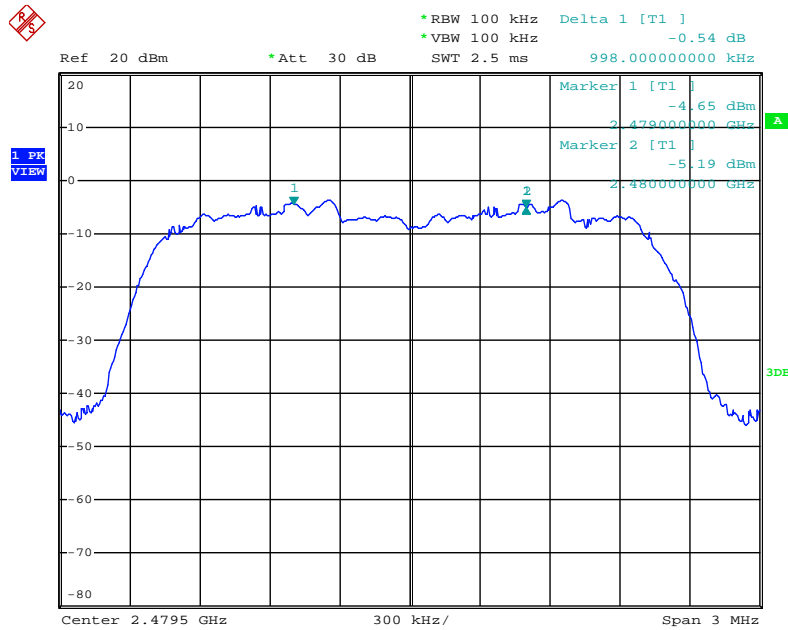

Date: 5.MAY.2014 21:15:57

4.4. Number of Hopping Frequency Measurement

4.4.1. Limit

At least 15 hopping frequencies, and should be equally spaced.

4.4.2. Measuring Instruments and Setting

Please refer to section 5 of equipments list in this report. The following table is the setting of spectrum analyzer.

Spectrum Parameters	Setting
Attenuation	Auto
Span Frequency	> Operating Frequency Range
RBW	1000 kHz
VBW	1000 kHz
Detector	Peak
Trace	Max Hold
Sweep Time	Auto

4.4.3. Test Procedures

1. The transmitter output (antenna port) was connected to the spectrum analyzer in peak hold mode.
2. The resolution bandwidth of 1000 kHz and the video bandwidth of 1000 kHz were utilized.
3. Observe frequency hopping in 2400MHz~2483.5MHz, there are at least 75 non-overlapping channels.

4.4.4. Test Setup Layout

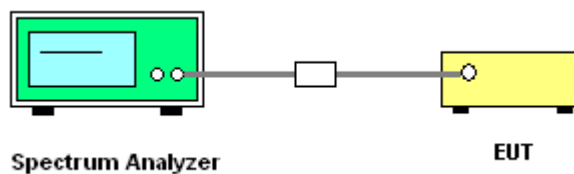

4.4.5. Test Deviation

There is no deviation with the original standard.

4.4.6. EUT Operation during Test

The EUT was programmed to be in continuously transmitting mode.

4.4.7. Test Result of Number of Hopping Frequency

Temperature	20°C	Humidity	52%
Test Engineer	David Tseng	Configurations	BR (GFSK)

Modulation Type	Channel No.	Frequency (MHz)	Hopping Ch. (Channels)		Min. Limit (Channels)	Test Result
			Max.	Min. (Note)		
EDR (8DPSK)	0 ~ 78	2402 ~ 2480MHz	79	20	15	Complies

Number of Hopping Channel Plot on BR (GFSK) / Channel 0~78 / 2402 MHz ~ 2480 MHz

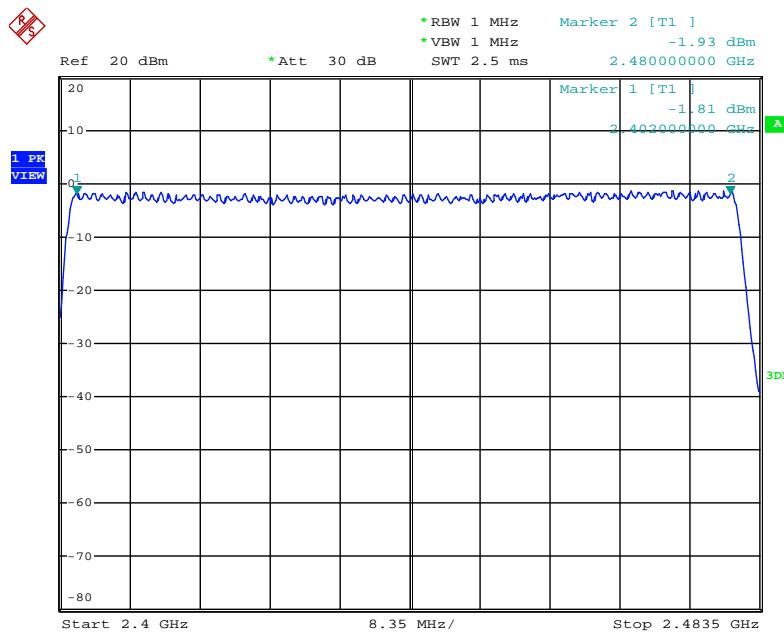

Date: 5.MAY.2014 21:22:05

Note: When Adaptive Frequency Hopping (AFH) function is employed, the minimum number of hopping channels is 20 channels.

4.5. Dwell Time Measurement

4.5.1. Limit

Frequency hopping systems in the 2400-2483.5 MHz band shall use at least 15 channels. The average time of occupancy on any channel shall not be greater than 0.4 seconds within a period of 0.4 seconds multiplied by the number of hopping channels employed.

4.5.2. Measuring Instruments and Setting

Please refer to section 5 of equipments list in this report. The following table is the setting of spectrum analyzer.

Spectrum Parameter	Setting
Attenuation	Auto
Span Frequency	0 MHz
RBW	1000 kHz
VBW	1000 kHz
Detector	Peak
Trace	Single Trigger

4.5.3. Test Procedures

1. The transmitter output (antenna port) was connected to the spectrum analyzer
2. Set RBW of spectrum analyzer to 1000kHz and VBW to 1000kHz.
3. Use a video trigger with the trigger level set to enable triggering only on full pulses.
4. Sweep Time is more than once pulse time.
5. Set the center frequency on any frequency would be measure and set the frequency span to zero span.
6. Measure the maximum time duration of one single pulse.
7. Set the EUT for DH1, DH3, DH5 packet transmitting.
8. Measure the maximum time duration of one single pulse.

4.5.4. Test Setup Layout

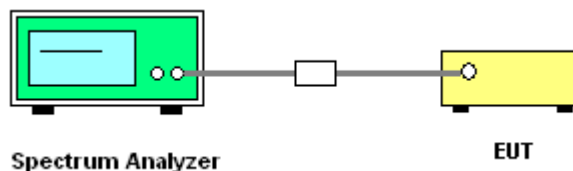

4.5.5. Test Deviation

There is no deviation with the original standard.

4.5.6. EUT Operation during Test

The EUT was programmed to be in continuously transmitting mode.

4.5.7. Test Result of Dwell Time

Temperature	20°C	Humidity	52%
Test Engineer	David Tseng	Configurations	BR (GFSK) / DH1, DH3, DH5

Data Packet	Frequency (MHz)	Pulse Duration (ms)	Dwell Time (s)	Limits (s)	Test Result
DH5	2402 MHz	2.9000	0.3093	0.4000	Complies
DH3	2402 MHz	1.6500	0.2640	0.4000	Complies
DH1	2402 MHz	0.3900	0.1248	0.4000	Complies
DH5	2441 MHz	2.9000	0.3093	0.4000	Complies
DH3	2441 MHz	1.6500	0.2640	0.4000	Complies
DH1	2441 MHz	0.3900	0.1248	0.4000	Complies
DH5	2480 MHz	2.9000	0.3093	0.4000	Complies
DH3	2480 MHz	1.6400	0.2624	0.4000	Complies
DH1	2480 MHz	0.3900	0.1248	0.4000	Complies

Note: Pulse Duration * Number of Pulses * (Dwell time / measure time)

Remark:

Dwell Time = Channels x 0.4(s) x Average Hopping Channel x Package transfer time (us)

Channels come from the Hopping Channel number.

Average Hopping Channel = hops / sweep time

The limit of maximum Hopping channels (79 channels)

DH5: $1600 / \text{Hopping Channel number (79)} / 6 \times (\text{Hopping Channel number (79)} \times 0.4\text{s}) \times \text{pulse on time} / 1000 = 0.4000$

DH3: $1600 / \text{Hopping Channel number (79)} / 4 \times (\text{Hopping Channel number (79)} \times 0.4\text{s}) \times \text{pulse on time} / 1000$

DH1: $1600 / \text{Hopping Channel number (79)} / 2 \times (\text{Hopping Channel number (79)} \times 0.4\text{s}) \times \text{pulse on time} / 1000$

The limit of minimum Hopping channels (20 channels) (AFH)

DH5: $1600 / \text{Hopping Channel number (20)} / 6 \times (\text{Hopping Channel number (20)} \times 0.4\text{s}) \times \text{pulse on time} / 1000$

DH3: $1600 / \text{Hopping Channel number (20)} / 4 \times (\text{Hopping Channel number (20)} \times 0.4\text{s}) \times \text{pulse on time} / 1000$

DH1: $1600 / \text{Hopping Channel number (20)} / 2 \times (\text{Hopping Channel number (20)} \times 0.4\text{s}) \times \text{pulse on time} / 1000$

Dwell Time Plot on BR (GFSK) / Channel 0 / DH1 / 2402 MHz

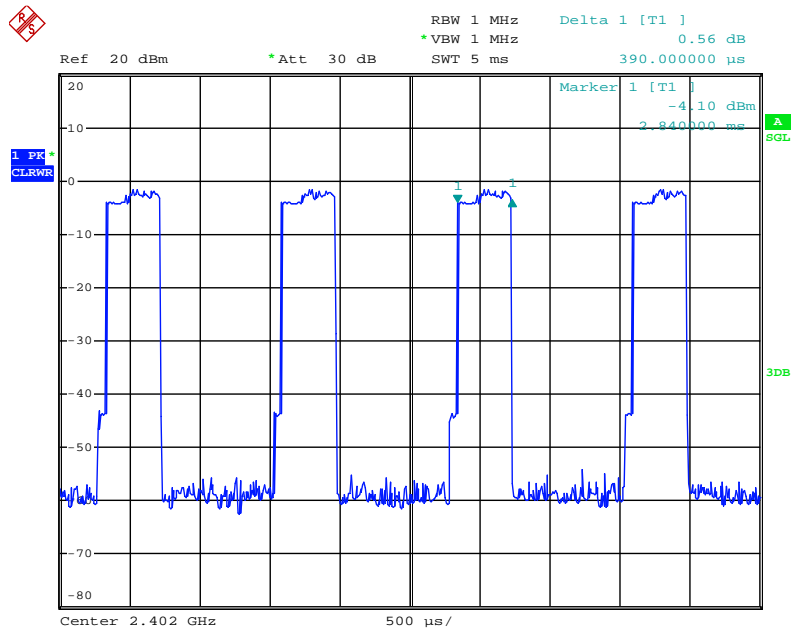

Date: 5.MAY.2014 20:42:14

Dwell Time Plot on BR (GFSK) / Channel 39 / DH1 / 2441 MHz

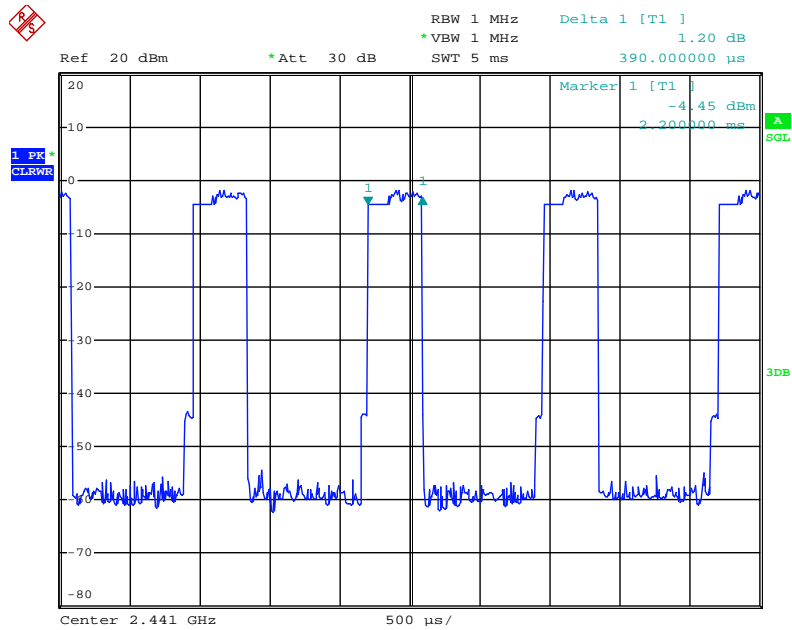

Date: 5.MAY.2014 20:41:29

Dwell Time Plot on BR (GFSK) / Channel 78 / DH1 / 2480 MHz

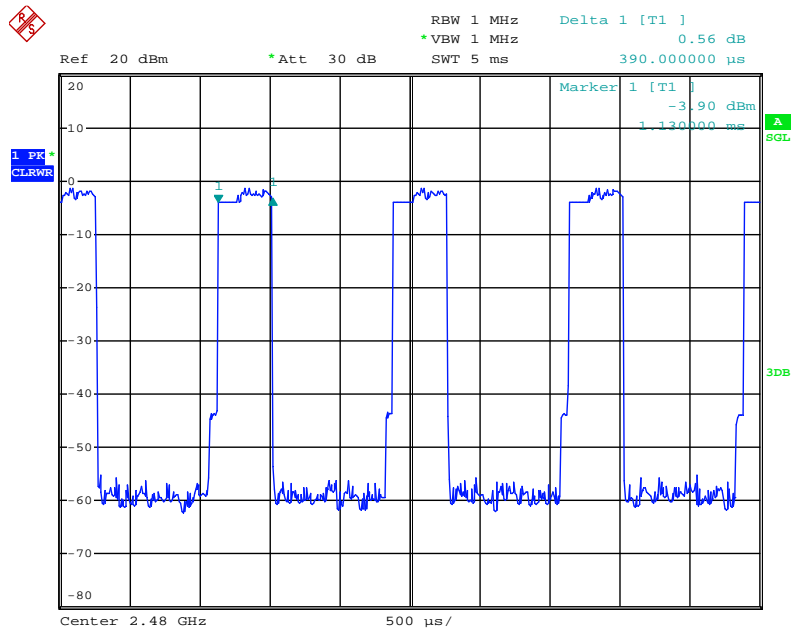

Date: 5.MAY.2014 20:43:05

Dwell Time Plot on BR (GFSK) / Channel 0 / DH3 / 2402 MHz

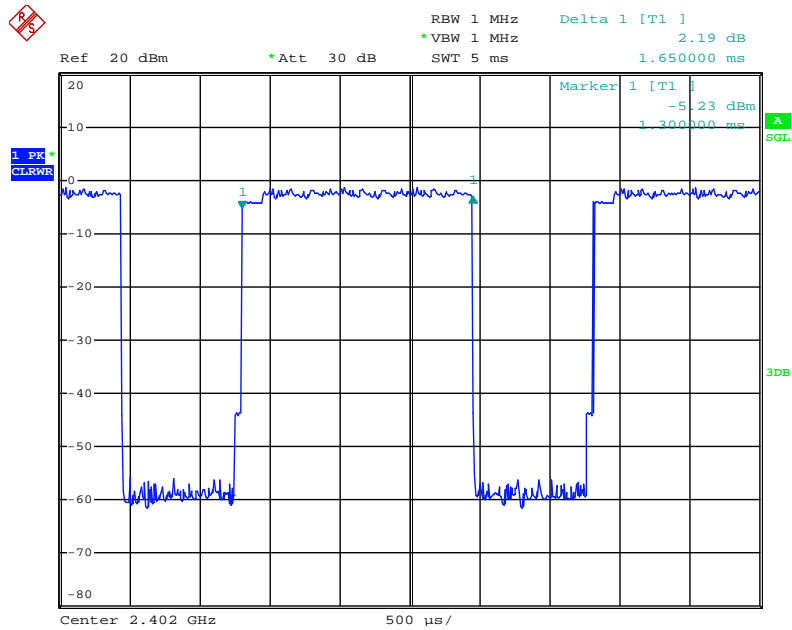

Date: 5.MAY.2014 20:55:55

Dwell Time Plot on BR (GFSK) / Channel 39 / DH3 / 2441 MHz

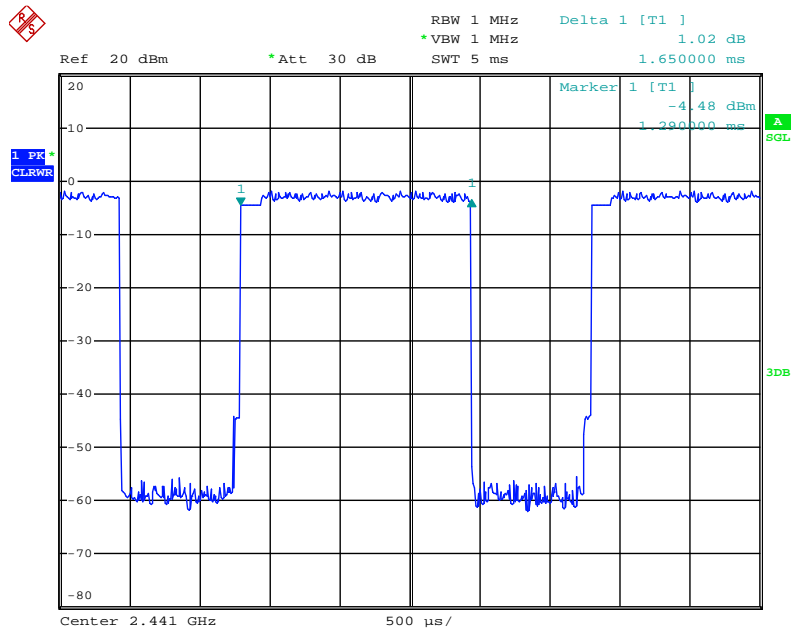

Date: 5.MAY.2014 20:47:11

Dwell Time Plot on BR (GFSK) / Channel 78 / DH3 / 2480 MHz

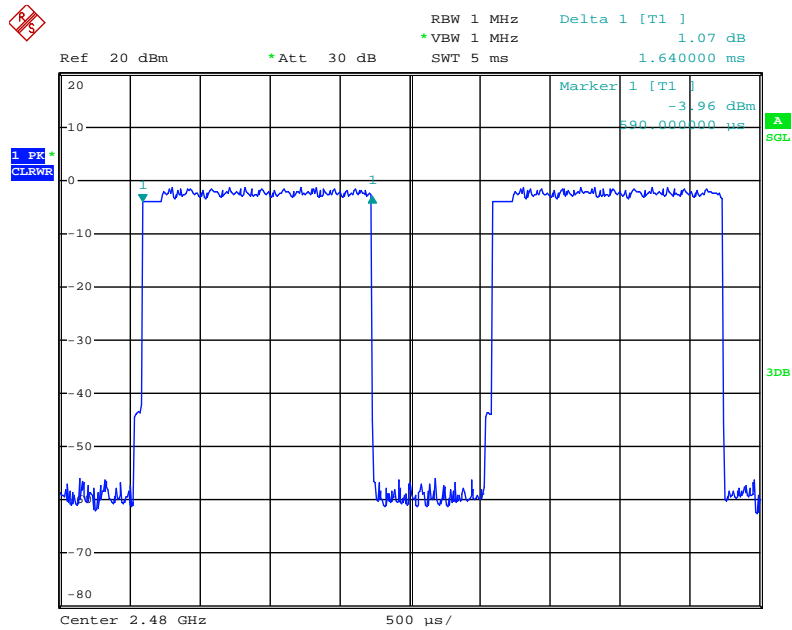

Date: 5.MAY.2014 20:44:31

Dwell Time Plot on BR (GFSK) / Channel 0 / DH5 / 2402 MHz

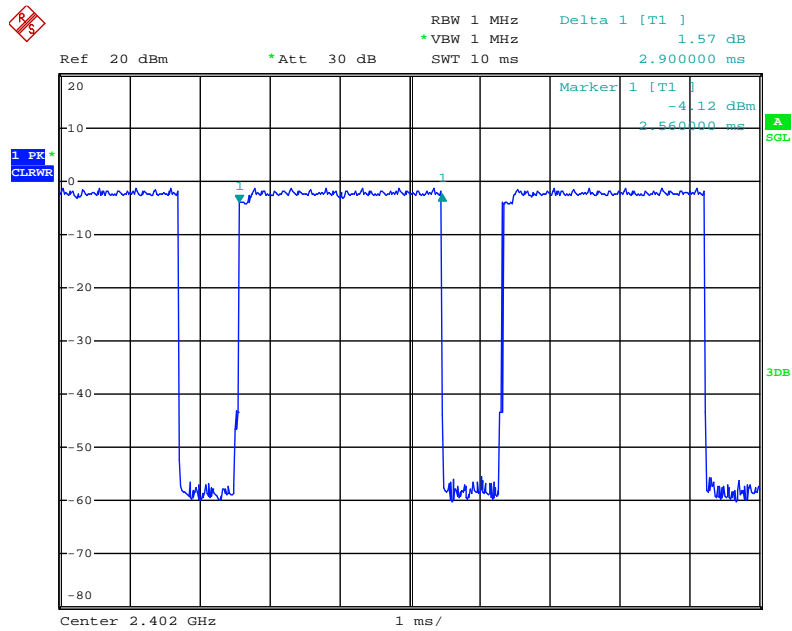

Date: 5.MAY.2014 20:57:23

Dwell Time Plot on BR (GFSK) / Channel 39 / DH5 / 2441 MHz

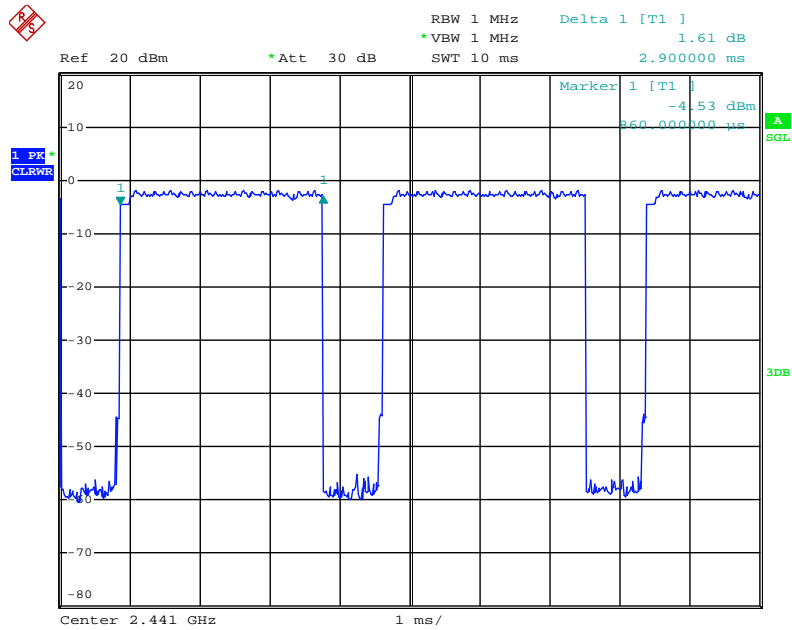

Date: 5.MAY.2014 20:58:03

Dwell Time Plot on BR (GFSK) / Channel 78 / DH5 / 2480 MHz

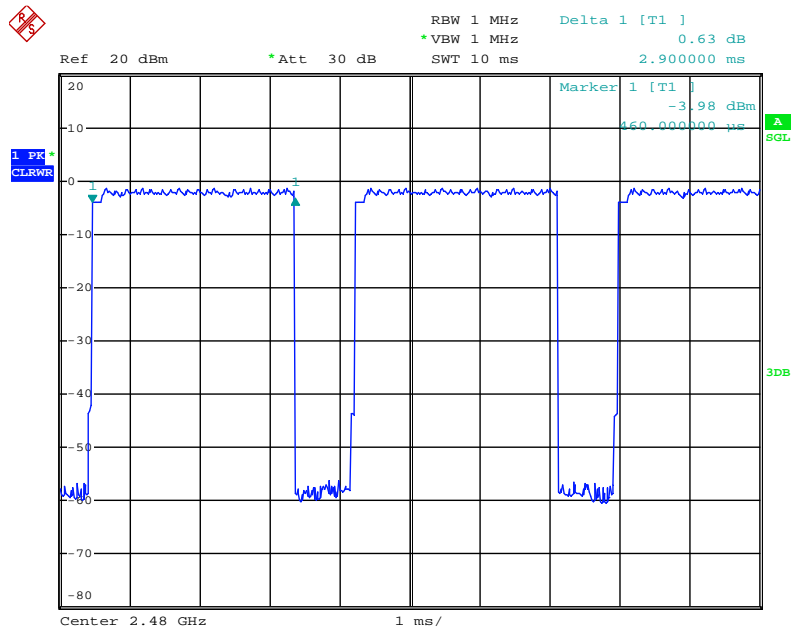

Date: 5.MAY.2014 20:58:46

4.6. Radiated Emissions Measurement

4.6.1. Limit

20dBc in any 100 kHz bandwidth outside the operating frequency band. In case the emission fall within the restricted band specified on 15.205(a), then the 15.209(a) limit in the table below has to be followed.

Frequencies (MHz)	Field Strength (micorvolts/meter)	Measurement Distance (meters)
0.009~0.490	2400/F(kHz)	300
0.490~1.705	24000/F(kHz)	30
1.705~30.0	30	30
30~88	100	3
88~216	150	3
216~960	200	3
Above 960	500	3

4.6.2. Measuring Instruments and Setting

Please refer to section 5 of equipments list in this report. The following table is the setting of spectrum analyzer and receiver.

Spectrum Parameter	Setting
Attenuation	Auto
Start Frequency	1000 MHz
Stop Frequency	10th carrier harmonic
RBW / VBW (Emission in restricted band)	1MHz / 3MHz for Peak, 1MHz / 10Hz for Average
RBW / VBW (Emission in non-restricted band)	100kHz / 300kHz for peak

Receiver Parameter	Setting
Attenuation	Auto
Start ~ Stop Frequency	9kHz~150kHz / RBW 200Hz for QP
Start ~ Stop Frequency	150kHz~30MHz / RBW 9kHz for QP
Start ~ Stop Frequency	30MHz~1000MHz / RBW 120kHz for QP

4.6.3. Test Procedures

1. Configure the EUT according to ANSI C63.10. The EUT was placed on the top of the turntable 0.8 meter above ground. The phase center of the receiving antenna mounted on the top of a height-variable antenna tower was placed 3 meters far away from the turntable.
2. Power on the EUT and all the supporting units. The turntable was rotated by 360 degrees to determine the position of the highest radiation.
3. The height of the broadband receiving antenna was varied between one meter and four meters above ground to find the maximum emissions field strength of both horizontal and vertical polarization.
4. For each suspected emissions, the antenna tower was scan (from 1 M to 4 M) and then the turntable was rotated (from 0 degree to 360 degrees) to find the maximum reading.
5. Set the test-receiver system to Peak or CISPR quasi-peak Detect Function with specified bandwidth under Maximum Hold Mode.
6. For emissions above 1GHz, use 1MHz VBW and 3MHz RBW for peak reading. Then 1MHz RBW and 10Hz VBW for average reading in spectrum analyzer.
7. When the radiated emissions limits are expressed in terms of the average value of the emissions, and pulsed operation is employed, the measurement field strength shall be determined by averaging over one complete pulse train, including blanking intervals, as long as the pulse train does not exceed 0.1 seconds. As an alternative (provided the transmitter operates for longer than 0.1 seconds) or in cases where the pulse train exceeds 0.1 seconds, the measured field strength shall be determined from the average absolute voltage during a 0.1 second interval during which the field strength is at its maximum value.
8. If the emissions level of the EUT in peak mode was 3 dB lower than the average limit specified, then testing will be stopped and peak values of EUT will be reported, otherwise, the emissions which do not have 3 dB margin will be repeated one by one using the quasi-peak method for below 1GHz.
9. For testing above 1GHz, the emissions level of the EUT in peak mode was lower than average limit (that means the emissions level in peak mode also complies with the limit in average mode), then testing will be stopped and peak values of EUT will be reported, otherwise, the emissions will be measured in average mode again and reported.
10. In case the emission is lower than 30MHz, loop antenna has to be used for measurement and the recorded data should be QP measured by receiver. High – Low scan is not required in this case.

4.6.4. Test Setup Layout

For Radiated Emissions: 9kHz ~30MHz

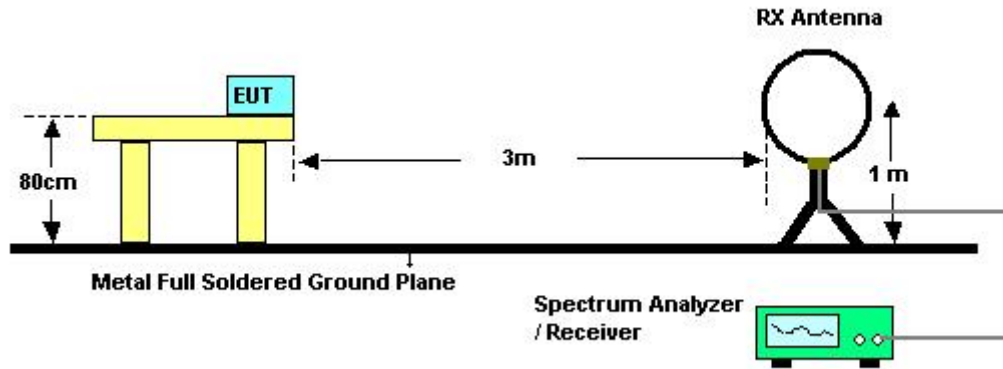

For Radiated Emissions: 30MHz~1GHz

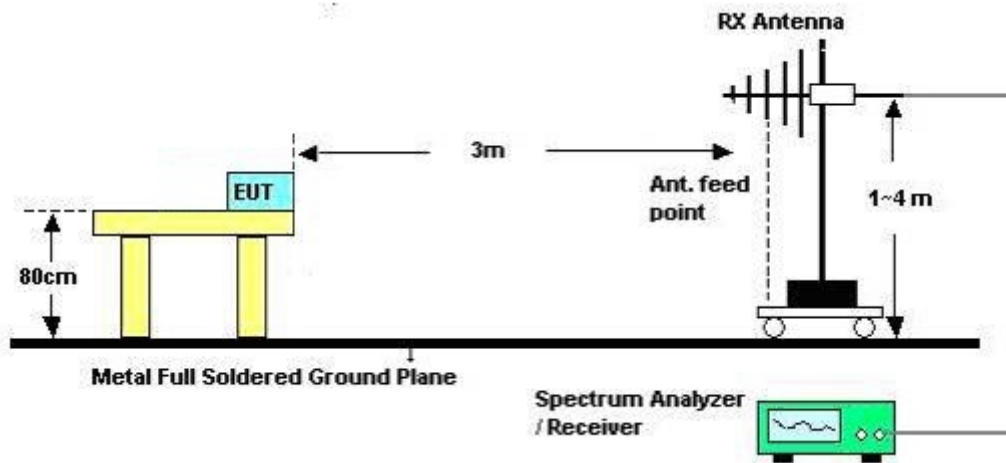

For Radiated Emissions: Above 1GHz

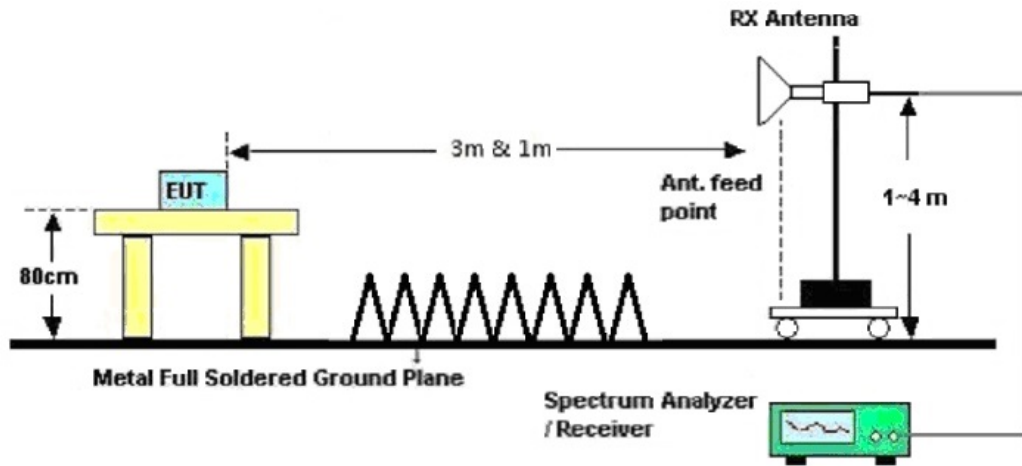

4.6.5. Test Deviation

There is no deviation with the original standard.

4.6.6. EUT Operation during Test

The EUT was programmed to be in continuously transmitting mode.

4.6.7. Results of Radiated Emissions (9kHz~30MHz)

Temperature	24°C	Humidity	51%
Test Engineer	David Tseng	Test Date	Apr. 04, 2014
Configurations	Normal Link	Test Mode	Mode 2

Freq. (MHz)	Level (dBuV)	Over Limit (dB)	Limit Line (dBuV)	Remark
-	-	-	-	See Note

Note:

The amplitude of spurious emissions which are attenuated by more than 20dB below the permissible value has no need to be reported.

Distance extrapolation factor = $40 \log(\text{specific distance} / \text{test distance})$ (dB);

Limit line = specific limits (dBuV) + distance extrapolation factor.

4.6.8. Results of Radiated Emissions (30MHz~1GHz)

Temperature	24°C	Humidity	51%
Test Engineer	David Tseng	Configurations	Normal Link
Test Mode	Mode 2		

Horizontal

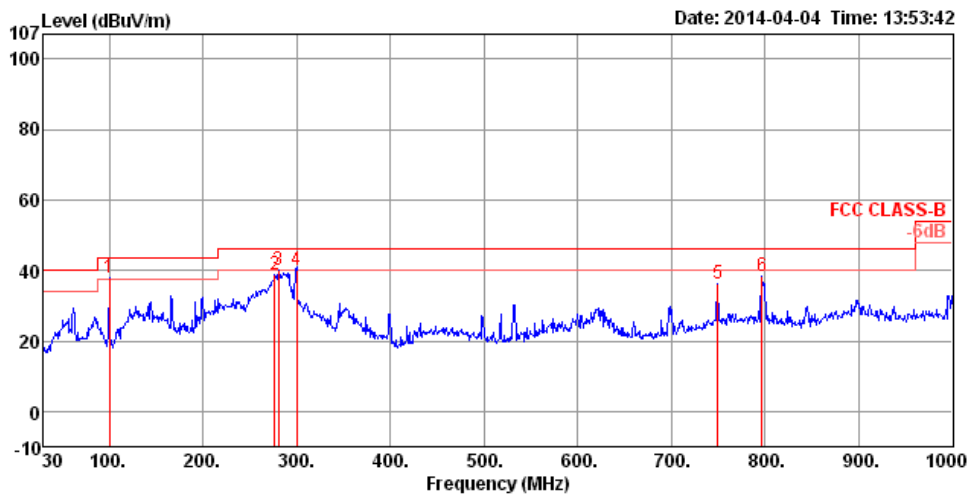

	Freq	Level	Limit	Over	Read	CableAntenna	Preamp	A/Pos	T/Pos	Pol/Phase	Remark
	MHz	dBuV/m	dBuV/m	dB	dBuV	dB	dB/m	dB	cm	deg	
1	99.84	37.75	43.50	-5.75	57.87	1.18	10.31	31.61	300	138	HORIZONTAL Peak
2	276.38	38.72	46.00	-7.28	55.79	2.01	12.47	31.55	125	308	HORIZONTAL Peak
3	280.26	39.88	46.00	-6.12	56.85	2.02	12.56	31.55	125	300	HORIZONTAL Peak
4	299.66	40.07	46.00	-5.93	56.34	2.13	13.02	31.42	125	197	HORIZONTAL Peak
5	749.74	36.05	46.00	-9.95	44.20	3.53	19.69	31.37	150	308	HORIZONTAL Peak
6	796.30	38.49	46.00	-7.51	46.36	3.66	19.75	31.28	150	15	HORIZONTAL Peak

Vertical

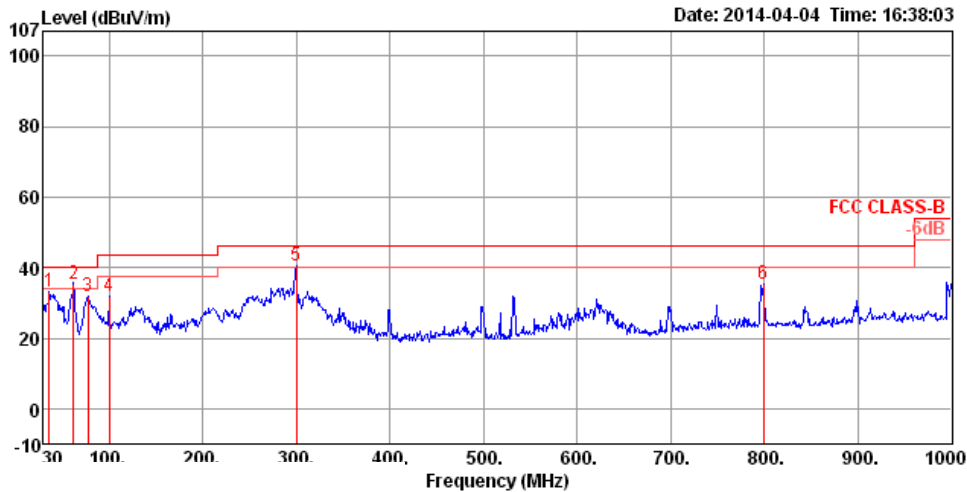

	Freq	Level	Limit	Over	Read	CableAntenna	Preamp	A/Pos	T/Pos	Pol/Phase	Remark
	MHz	dBuV/m	dBuV/m	dB	dBuV	dB	dB/m	dB	cm	deg	
1	35.82	33.27	40.00	-6.73	49.83	0.70	14.62	31.88	100	193	VERTICAL Peak
2	62.01	35.50	40.00	-4.50	61.57	0.91	4.82	31.80	300	357	VERTICAL Peak
3	77.53	31.68	40.00	-8.32	55.82	1.03	6.53	31.70	150	272	VERTICAL Peak
4	99.84	31.68	43.50	-11.82	51.80	1.18	10.31	31.61	100	193	VERTICAL Peak
5	299.66	40.41	46.00	-5.59	56.68	2.13	13.02	31.42	200	125	VERTICAL Peak
6	799.21	35.31	46.00	-10.69	43.15	3.67	19.76	31.27	100	275	VERTICAL Peak

Note:

The amplitude of spurious emissions which are attenuated by more than 20 dB below the permissible value has no need to be reported.

Emission level (dBuV/m) = 20 log Emission level (uV/m).

Corrected Reading: Antenna Factor + Cable Loss + Read Level - Preamp Factor = Level.

4.6.9. Results for Radiated Emissions (1GHz~10th Harmonic)

Temperature	24°C	Humidity	51%
Test Engineer	David Tseng	Configurations	BR (GFSK) / Channel 0
Test Date	Mar. 28, 2014		

Horizontal

	Freq	Level	Limit Line	Over Limit	Read Level	Cable Loss	Antenna Factor	Preamp Factor	Remark	T/Pos	A/Pos	Pol/Phase
	MHz	dBuV/m	dBuV/m	dB	dBuV	dB	dB/m	dB		deg	cm	
1	4803.30	45.68	74.00	-28.32	43.55	4.20	32.52	34.59	Peak	221	100	HORIZONTAL
2	4804.06	32.81	54.00	-21.19	30.68	4.20	32.52	34.59	Average	221	100	HORIZONTAL
3	7205.73	49.88	74.00	-24.12	42.42	5.32	36.95	34.81	Peak	64	100	HORIZONTAL
4	7206.90	37.41	54.00	-16.59	29.95	5.32	36.95	34.81	Average	64	100	HORIZONTAL

Vertical

	Freq	Level	Limit Line	Over Limit	Read Level	Cable Loss	Antenna Factor	Preamp Factor	Remark	T/Pos	A/Pos	Pol/Phase
	MHz	dBuV/m	dBuV/m	dB	dBuV	dB	dB/m	dB		deg	cm	
1	4804.29	45.92	74.00	-28.08	43.79	4.20	32.52	34.59	Peak	336	100	VERTICAL
2	4804.95	33.46	54.00	-20.54	31.33	4.20	32.52	34.59	Average	336	100	VERTICAL
3	7206.41	50.06	74.00	-23.94	42.60	5.32	36.95	34.81	Peak	180	100	VERTICAL
4	7206.42	37.56	54.00	-16.44	30.10	5.32	36.95	34.81	Average	180	100	VERTICAL



Temperature	24°C	Humidity	51%
Test Engineer	David Tseng	Configurations	BR (GFSK) / Channel 39
Test Date	Mar. 28, 2014		

Horizontal

	Freq	Level	Limit Line	Over Limit	Read Level	Cable Loss	Antenna Factor	Preamp Factor	Remark	T/Pos	A/Pos	Pol/Phase
	MHz	dBuV/m	dBuV/m	dB	dBuV	dB	dB/m	dB		deg	cm	
1	4882.66	29.90	54.00	-24.10	27.59	4.22	32.66	34.57	Average	313	100	HORIZONTAL
2	4882.83	42.91	74.00	-31.09	40.60	4.22	32.66	34.57	Peak	313	100	HORIZONTAL
3	7322.76	49.27	74.00	-24.73	41.66	5.35	37.09	34.83	Peak	153	100	HORIZONTAL
4	7322.91	35.60	54.00	-18.40	27.99	5.35	37.09	34.83	Average	153	100	HORIZONTAL

Vertical

	Freq	Level	Limit Line	Over Limit	Read Level	Cable Loss	Antenna Factor	Preamp Factor	Remark	T/Pos	A/Pos	Pol/Phase
	MHz	dBuV/m	dBuV/m	dB	dBuV	dB	dB/m	dB		deg	cm	
1	4881.24	43.25	74.00	-30.75	40.94	4.22	32.66	34.57	Peak	95	100	VERTICAL
2	4882.40	29.96	54.00	-24.04	27.65	4.22	32.66	34.57	Average	95	100	VERTICAL
3	7322.10	48.70	74.00	-25.30	41.09	5.35	37.09	34.83	Peak	269	100	VERTICAL
4	7322.13	35.55	54.00	-18.45	27.94	5.35	37.09	34.83	Average	269	100	VERTICAL

Temperature	24°C	Humidity	51%
Test Engineer	David Tseng	Configurations	BR (GFSK) / Channel 78
Test Date	Mar. 28, 2014		

Horizontal

	Freq	Level	Limit Line	Over Limit	Read Level	Cable Loss	Antenna Factor	Preamp Factor	Remark	T/Pos	A/Pos	Pol/Phase
	MHz	dBuV/m	dBuV/m	dB	dBuV	dB	dB/m	dB		deg	cm	
1	4959.08	43.66	74.00	-30.34	41.14	4.23	32.83	34.54	Peak	99	100	HORIZONTAL
2	4960.44	30.04	54.00	-23.96	27.52	4.23	32.83	34.54	Average	99	100	HORIZONTAL
3	7439.15	35.70	54.00	-18.30	27.94	5.37	37.24	34.85	Average	336	100	HORIZONTAL
4	7440.86	49.34	74.00	-24.66	41.58	5.37	37.24	34.85	Peak	336	100	HORIZONTAL

Vertical

	Freq	Level	Limit Line	Over Limit	Read Level	Cable Loss	Antenna Factor	Preamp Factor	Remark	T/Pos	A/Pos	Pol/Phase
	MHz	dBuV/m	dBuV/m	dB	dBuV	dB	dB/m	dB		deg	cm	
1	4959.00	29.60	54.00	-24.40	27.08	4.23	32.83	34.54	Average	151	100	VERTICAL
2	4960.04	43.54	74.00	-30.46	41.02	4.23	32.83	34.54	Peak	151	100	VERTICAL
3	7439.01	49.11	74.00	-24.89	41.35	5.37	37.24	34.85	Peak	240	100	VERTICAL
4	7440.84	35.73	54.00	-18.27	27.97	5.37	37.24	34.85	Average	240	100	VERTICAL

Note:

The amplitude of spurious emissions which are attenuated by more than 20dB below the permissible value has no need to be reported.

Emission level (dBuV/m) = 20 log Emission level (uV/m).

Corrected Reading: Antenna Factor + Cable Loss + Read Level - Preamp Factor = Level.



Temperature	24°C	Humidity	51%
Test Engineer	David Tseng	Configurations	EDR (8DPSK) / Channel 0
Test Date	Mar. 28, 2014		

Horizontal

	Freq	Level	Limit Line	Over Limit	Read Level	Cable Loss	Antenna Factor	Preamp Factor	Remark	T/Pos	A/Pos	Pol/Phase
	MHz	dBuV/m	dBuV/m	dB	dBuV	dB	dB/m	dB		deg	cm	
1	4803.42	42.96	74.00	-31.04	40.83	4.20	32.52	34.59	Peak	208	100	HORIZONTAL
2	4803.43	29.97	54.00	-24.03	27.84	4.20	32.52	34.59	Average	208	100	HORIZONTAL
3	7205.79	49.22	74.00	-24.78	41.76	5.32	36.95	34.81	Peak	281	100	HORIZONTAL
4	7206.21	35.54	54.00	-18.46	28.08	5.32	36.95	34.81	Average	281	100	HORIZONTAL

Vertical

	Freq	Level	Limit Line	Over Limit	Read Level	Cable Loss	Antenna Factor	Preamp Factor	Remark	T/Pos	A/Pos	Pol/Phase
	MHz	dBuV/m	dBuV/m	dB	dBuV	dB	dB/m	dB		deg	cm	
1	4803.40	43.51	74.00	-30.49	41.38	4.20	32.52	34.59	Peak	266	100	VERTICAL
2	4803.74	30.72	54.00	-23.28	28.59	4.20	32.52	34.59	Average	266	100	VERTICAL
3	7205.63	35.32	54.00	-18.68	27.86	5.32	36.95	34.81	Average	180	8995	VERTICAL
4	7205.82	49.37	74.00	-24.63	41.91	5.32	36.95	34.81	Peak	180	100	VERTICAL



Temperature	24°C	Humidity	51%
Test Engineer	David Tseng	Configurations	EDR (8DPSK) / Channel 39
Test Date	Mar. 28, 2014		

Horizontal

	Freq	Level	Limit Line	Over Limit	Read Level	Cable Loss	Antenna Factor	Preamp Factor	Remark	T/Pos	A/Pos	Pol/Phase
	MHz	dBuV/m	dBuV/m	dB	dBuV	dB	dB/m	dB		deg	cm	
1	4881.84	43.36	74.00	-30.64	41.05	4.22	32.66	34.57	Peak	306	100	HORIZONTAL
2	4882.89	29.81	54.00	-24.19	27.50	4.22	32.66	34.57	Average	306	100	HORIZONTAL
3	7322.56	49.27	74.00	-24.73	41.66	5.35	37.09	34.83	Peak	213	100	HORIZONTAL
4	7323.89	35.48	54.00	-18.52	27.87	5.35	37.09	34.83	Average	213	100	HORIZONTAL

Vertical

	Freq	Level	Limit Line	Over Limit	Read Level	Cable Loss	Antenna Factor	Preamp Factor	Remark	T/Pos	A/Pos	Pol/Phase
	MHz	dBuV/m	dBuV/m	dB	dBuV	dB	dB/m	dB		deg	cm	
1	4881.68	29.55	54.00	-24.45	27.24	4.22	32.66	34.57	Average	211	100	VERTICAL
2	4881.85	43.36	74.00	-30.64	41.05	4.22	32.66	34.57	Peak	211	100	VERTICAL
3	7322.30	35.48	54.00	-18.52	27.87	5.35	37.09	34.83	Average	87	100	VERTICAL
4	7323.14	48.60	74.00	-25.40	40.99	5.35	37.09	34.83	Peak	87	100	VERTICAL



Temperature	24°C	Humidity	51%
Test Engineer	David Tseng	Configurations	EDR (8DPSK) / Channel 78
Test Date	Mar. 28, 2014		

Horizontal

	Freq	Level	Limit Line	Over Limit	Read Level	Cable Loss	Antenna Factor	Preamp Factor	Remark	T/Pos	A/Pos	Pol/Phase
	MHz	dBuV/m	dBuV/m	dB	dBuV	dB	dB/m	dB		deg	cm	
1	4959.83	29.95	54.00	-24.05	27.43	4.23	32.83	34.54	Average	174	100	HORIZONTAL
2	4960.16	43.32	74.00	-30.68	40.80	4.23	32.83	34.54	Peak	174	100	HORIZONTAL
3	7439.67	48.43	74.00	-25.57	40.67	5.37	37.24	34.85	Peak	258	100	HORIZONTAL
4	7440.68	35.57	54.00	-18.43	27.81	5.37	37.24	34.85	Average	258	100	HORIZONTAL

Vertical

	Freq	Level	Limit Line	Over Limit	Read Level	Cable Loss	Antenna Factor	Preamp Factor	Remark	T/Pos	A/Pos	Pol/Phase
	MHz	dBuV/m	dBuV/m	dB	dBuV	dB	dB/m	dB		deg	cm	
1	4959.55	42.86	74.00	-31.14	40.34	4.23	32.83	34.54	Peak	194	100	VERTICAL
2	4959.60	30.18	54.00	-23.82	27.66	4.23	32.83	34.54	Average	194	100	VERTICAL
3	7439.21	49.23	74.00	-24.77	41.47	5.37	37.24	34.85	Peak	114	100	VERTICAL
4	7440.87	35.66	54.00	-18.34	27.90	5.37	37.24	34.85	Average	114	100	VERTICAL

Note:

The amplitude of spurious emissions which are attenuated by more than 20dB below the permissible value has no need to be reported.

Emission level (dBuV/m) = 20 log Emission level (uV/m).

Corrected Reading: Antenna Factor + Cable Loss + Read Level - Preamp Factor = Level.

4.7. Emissions Measurement

4.7.1. Limit

20dBc in any 100 kHz bandwidth outside the operating frequency band. In case the emission fall within the restricted band specified on 15.205(a), then the 15.209(a) limit in the table below has to be followed.

Frequencies (MHz)	Field Strength (micorvolts/meter)	Measurement Distance (meters)
0.009~0.490	2400/F(kHz)	300
0.490~1.705	24000/F(kHz)	30
1.705~30.0	30	30
30~88	100	3
88~216	150	3
216~960	200	3
Above 960	500	3

4.7.2. Measuring Instruments and Setting

Please refer to section 5 of equipments list in this report. The following table is the setting of the spectrum analyzer.

Spectrum Parameter	Setting
Attenuation	Auto
Span Frequency	100 MHz
RBW / VBW (Emission in restricted band)	1MHz / 3MHz for Peak, 1MHz / 10Hz for Average
RBW / VBW (Emission in non-restricted band)	100 kHz / 100 kHz for Peak

4.7.3. Test Procedures

For Radiated band edges Measurement:

1. The test procedure is the same as section 0, only the frequency range investigated is limited to 100MHz around band edges.

For Radiated Out of Band Emission Measurement:

1. The radiated emission test is performed on each TX port of operating mode without summing or adding 10log (N) since the limit is relative emission limit.
Only worst data of each operating mode is presented.

4.7.4. Test Setup Layout

For Radiated band edges Measurement:

This test setup layout is the same as that shown in section 4.6.4.

For Radiated Out of Band Emission Measurement:

This test setup layout is the same as that shown in section 4.6.4.

4.7.5. Test Deviation

There is no deviation with the original standard.

4.7.6. EUT Operation during Test

The EUT was programmed to be in continuously transmitting mode.

4.7.7. Test Result of Band Edge and Fundamental Emissions

Temperature	24°C	Humidity	51%
Test Engineer	David Tseng	Configurations	BR (GFSK) / Channel 0, 39, 78
Test Date	Apr. 11, 2014		

Channel 0

	Freq	Level	Limit	Over	Read	CableAntenna	Preamp	A/Pos	T/Pos	Pol/Phase	Remark
	MHz	dBuV/m	dBuV/m	dB	dBuV	dB	dB/m	dB	cm	deg	
1	2389.30	40.40	54.00	-13.60	8.82	3.68	27.90	0.00	149	53 HORIZONTAL	Average
2	2389.80	55.42	74.00	-18.58	23.84	3.68	27.90	0.00	149	53 HORIZONTAL	Peak
3	2402.00	96.45			64.86	3.69	27.90	0.00	149	53 HORIZONTAL	Average
4	2402.20	97.98			66.39	3.69	27.90	0.00	149	53 HORIZONTAL	Peak

Item 3, 4 are the fundamental frequency at 2402 MHz.

Channel 39

	Freq	Level	Limit	Over	Read	CableAntenna	Preamp	A/Pos	T/Pos	Pol/Phase	Remark
	MHz	dBuV/m	dBuV/m	dB	dBuV	dB	dB/m	dB	cm	deg	
1	2388.40	55.69	74.00	-18.31	24.11	3.68	27.90	0.00	143	232 HORIZONTAL	Peak
2	2390.00	40.23	54.00	-13.77	8.65	3.68	27.90	0.00	143	232 HORIZONTAL	Average
3	2441.00	95.58			63.97	3.71	27.90	0.00	143	232 HORIZONTAL	Average
4	2441.00	96.10			64.49	3.71	27.90	0.00	143	232 HORIZONTAL	Peak
5	2484.10	40.37	54.00	-13.63	8.74	3.73	27.90	0.00	143	232 HORIZONTAL	Average
6	2485.10	55.22	74.00	-18.78	23.59	3.73	27.90	0.00	143	232 HORIZONTAL	Peak

Item 3, 4 are the fundamental frequency at 2441 MHz.

Channel 78

	Freq	Level	Limit	Over	Read	CableAntenna	Preamp	A/Pos	T/Pos	Pol/Phase	Remark
	MHz	dBuV/m	dBuV/m	dB	dBuV	dB	dB/m	dB	cm	deg	
1	2480.00	95.01			63.38	3.73	27.90	0.00	142	236 HORIZONTAL	Average
2	2480.20	95.57			63.94	3.73	27.90	0.00	142	236 HORIZONTAL	Peak
3	2483.60	55.80	74.00	-18.20	24.17	3.73	27.90	0.00	142	236 HORIZONTAL	Peak
4	2484.10	41.28	54.00	-12.72	9.65	3.73	27.90	0.00	142	236 HORIZONTAL	Average

Item 1, 2 are the fundamental frequency at 2480 MHz.

Note:

Emission level (dBuV/m) = 20 log Emission level (uV/m).

Corrected Reading: Antenna Factor + Cable Loss + Read Level - Preamp Factor = Level.

Temperature	24°C	Humidity	51%
Test Engineer	David Tseng	Configurations	EDR (8DPSK) / Channel 0, 39, 78
Test Date	Apr. 11, 2014		

Channel 0

	Freq	Level	Limit	Over	Read	CableAntenna	Preamp	A/Pos	T/Pos	Pol/Phase	Remark
	MHz	dBuV/m	dBuV/m	dB	dBuV	dB	dB/m	dB	cm	deg	
1	2388.80	40.43	54.00	-13.57	8.85	3.68	27.90	0.00	101	9 VERTICAL	Average
2	2389.60	54.96	74.00	-19.04	23.38	3.68	27.90	0.00	101	9 VERTICAL	Peak
3	2402.00	87.70			56.11	3.69	27.90	0.00	101	9 VERTICAL	Average
4	2402.00	91.92			60.33	3.69	27.90	0.00	101	9 VERTICAL	Peak

Item 3, 4 are the fundamental frequency at 2402 MHz.

Channel 39

	Freq	Level	Limit	Over	Read	CableAntenna	Preamp	A/Pos	T/Pos	Pol/Phase	Remark
	MHz	dBuV/m	dBuV/m	dB	dBuV	dB	dB/m	dB	cm	deg	
1	2388.60	54.26	74.00	-19.74	22.68	3.68	27.90	0.00	144	232 HORIZONTAL	Peak
2	2389.20	40.43	54.00	-13.57	8.85	3.68	27.90	0.00	144	232 HORIZONTAL	Average
3	2441.00	94.25			62.64	3.71	27.90	0.00	144	232 HORIZONTAL	Average
4	2441.20	98.45			66.84	3.71	27.90	0.00	144	232 HORIZONTAL	Peak
5	2484.70	40.69	54.00	-13.31	9.06	3.73	27.90	0.00	144	232 HORIZONTAL	Average
6	2484.70	56.61	74.00	-17.39	24.98	3.73	27.90	0.00	144	232 HORIZONTAL	Peak

Item 3, 4 are the fundamental frequency at 2441 MHz.

Channel 78

	Freq	Level	Limit	Over	Read	CableAntenna	Preamp	A/Pos	T/Pos	Pol/Phase	Remark
	MHz	dBuV/m	dBuV/m	dB	dBuV	dB	dB/m	dB	cm	deg	
1	2480.00	93.10			61.47	3.73	27.90	0.00	138	232 HORIZONTAL	Average
2	2480.20	97.08			65.45	3.73	27.90	0.00	138	232 HORIZONTAL	Peak
3	2483.50	40.84	54.00	-13.16	9.21	3.73	27.90	0.00	138	232 HORIZONTAL	Average
4	2483.60	56.45	74.00	-17.55	24.82	3.73	27.90	0.00	138	232 HORIZONTAL	Peak

Item 1, 2 are the fundamental frequency at 2480 MHz.

Note:

Emission level (dBuV/m) = 20 log Emission level (uV/m).

Corrected Reading: Antenna Factor + Cable Loss + Read Level - Preamp Factor = Level.

Plot on Configuration For BR (GFSK) / Channel 0 / Reference Level

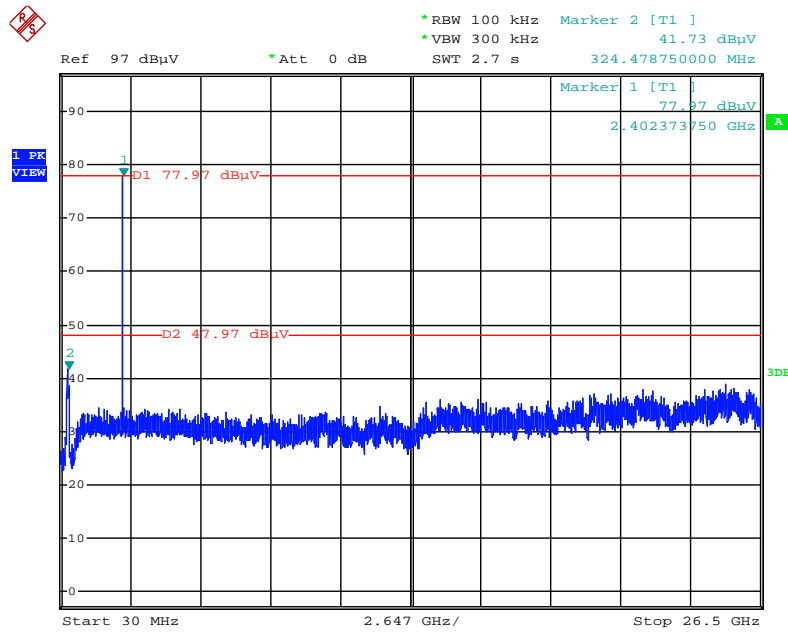

Date: 12.APR.2014 03:49:04

Plot on Configuration For BR (GFSK) / Channel 0 / 30MHz~2400MHz (down 30dBc)

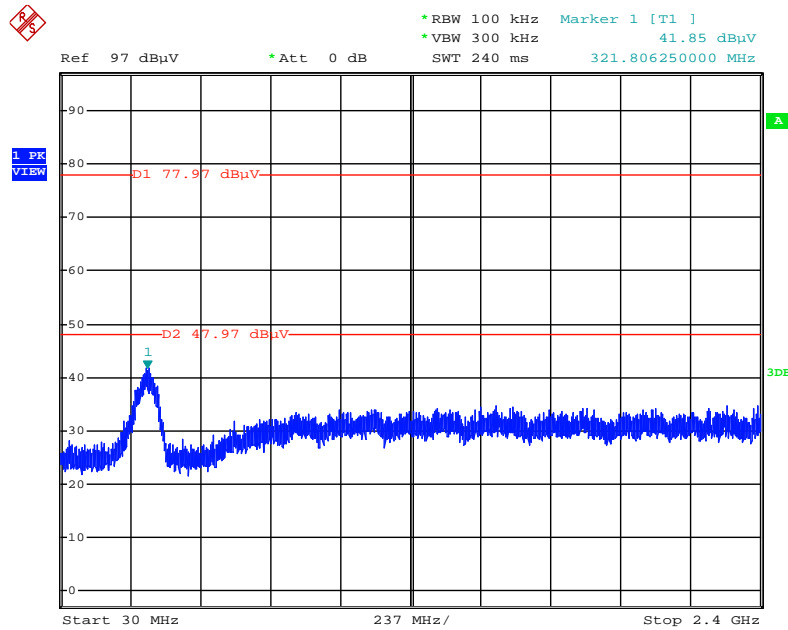

Date: 12.APR.2014 03:49:27

Plot on Configuration For BR (GFSK) / Channel 0 / 2500MHz~26500MHz (down 30dBc)

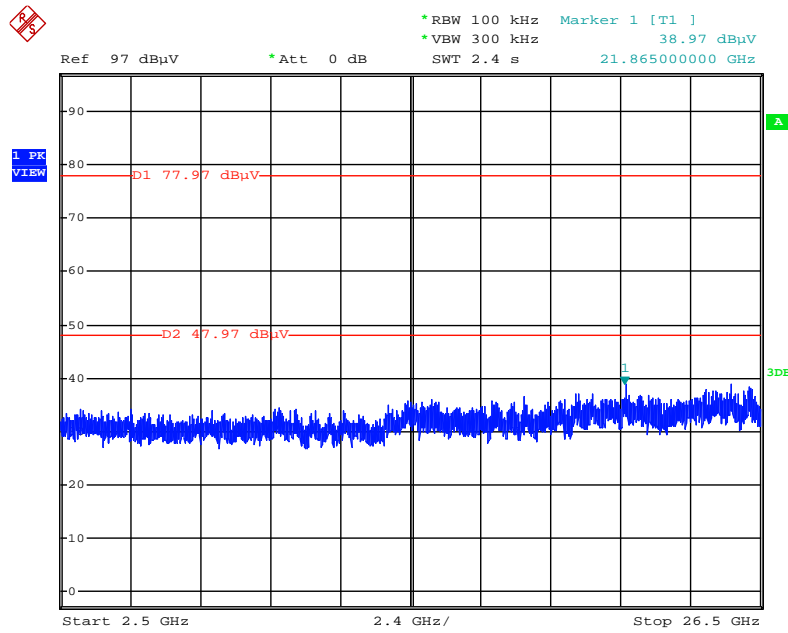

Date: 12.APR.2014 03:49:47

Plot on Configuration For BR (GFSK) / Channel 78 / Reference Level

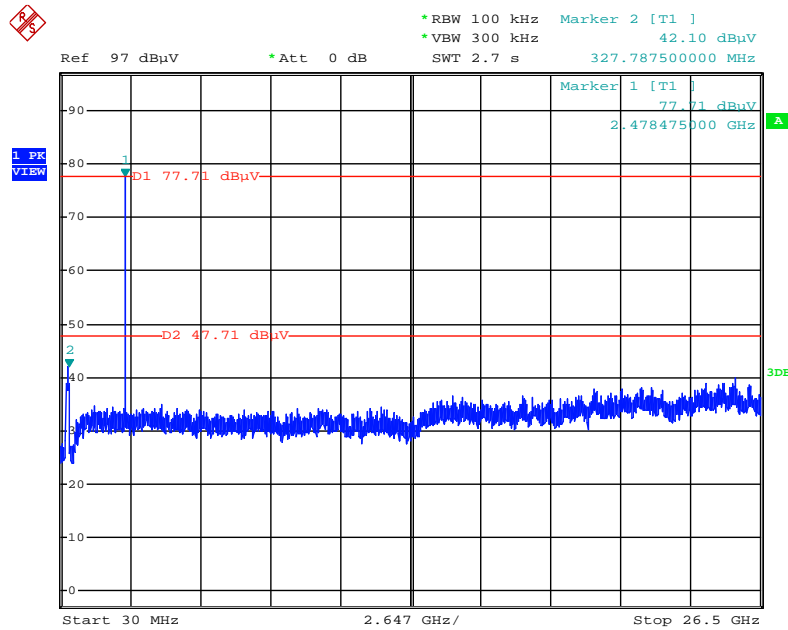

Date: 12.APR.2014 03:57:19

Plot on Configuration For BR (GFSK) / Channel 78 / 30MHz~2400MHz (down 30dBc)

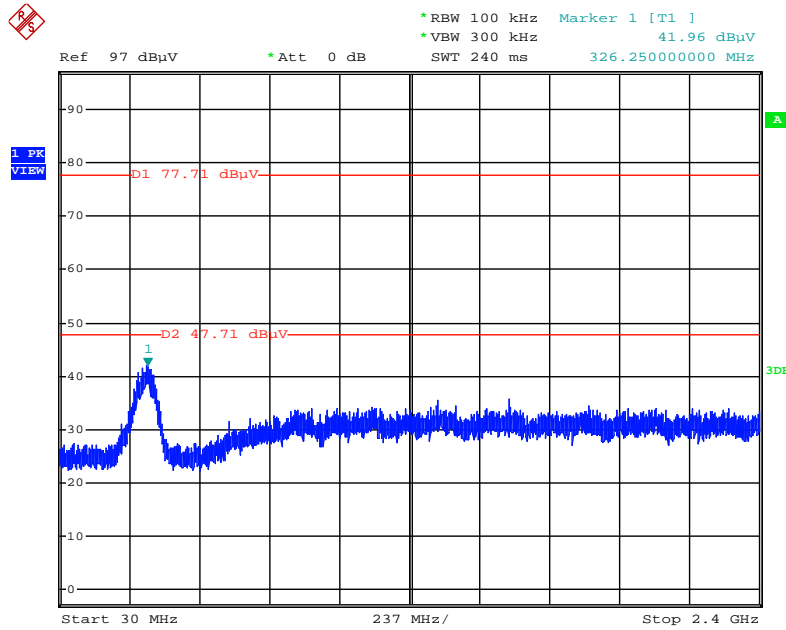

Date: 12.APR.2014 03:57:46

Plot on Configuration For BR (GFSK) / Channel 78 / 2500MHz~26500MHz (down 30dBc)

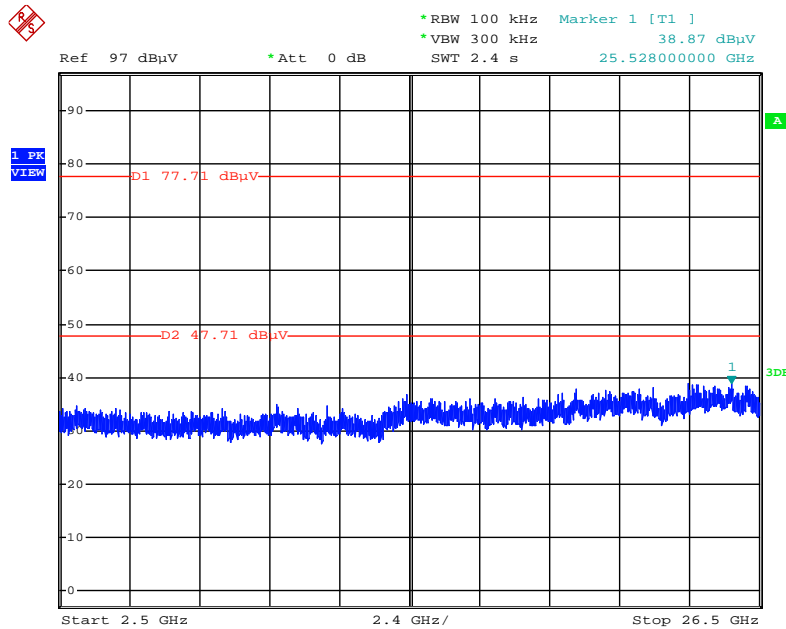

Date: 12.APR.2014 03:58:17

Plot on Configuration For BR (GFSK) / Hopping / Reference Level

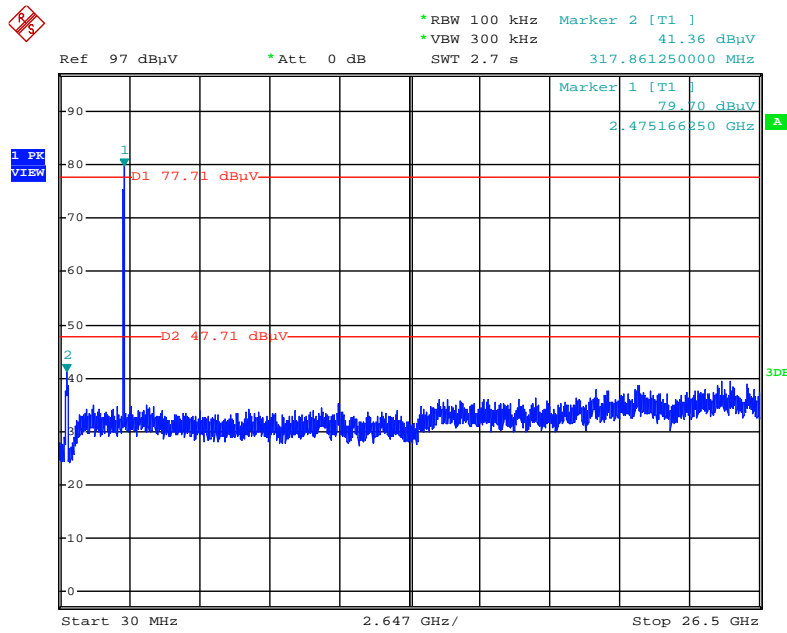

Date: 12.APR.2014 03:59:45

Plot on Configuration For BR (GFSK) / Hopping / 30MHz~2400MHz (down 30dBc)

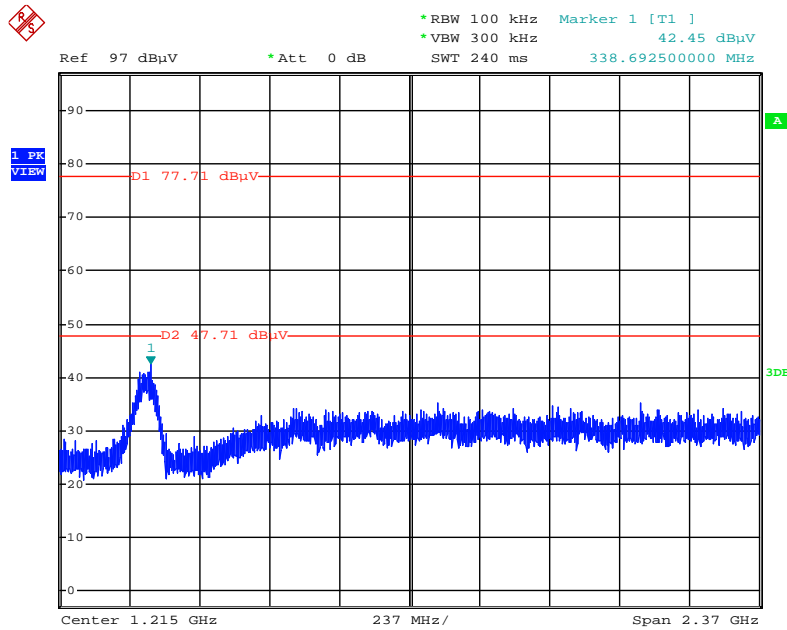

Date: 12.APR.2014 04:00:08

Plot on Configuration For BR (GFSK) / Hopping / 2500MHz~26500MHz (down 30dBc)

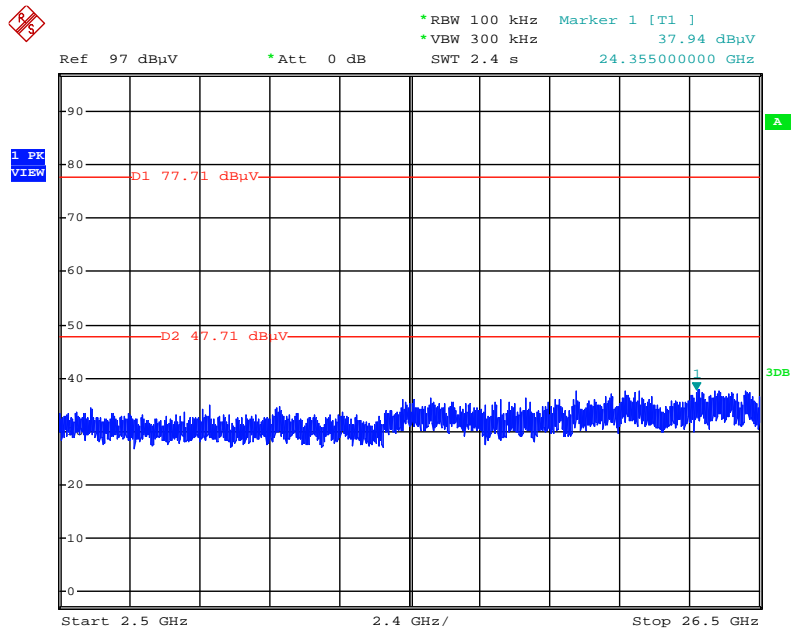

Date: 12.APR.2014 04:00:32

Plot on Configuration For EDR (8DPSK) / Channel 0 / Reference Level

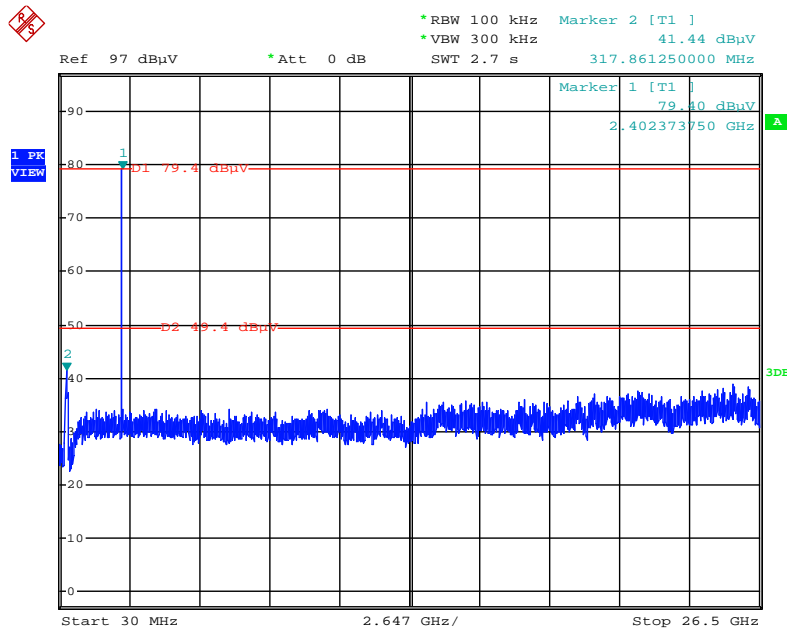

Date: 12.APR.2014 04:01:58

Plot on Configuration For EDR (8DPSK) / Channel 0 / 30MHz~2400MHz (down 30dBc)

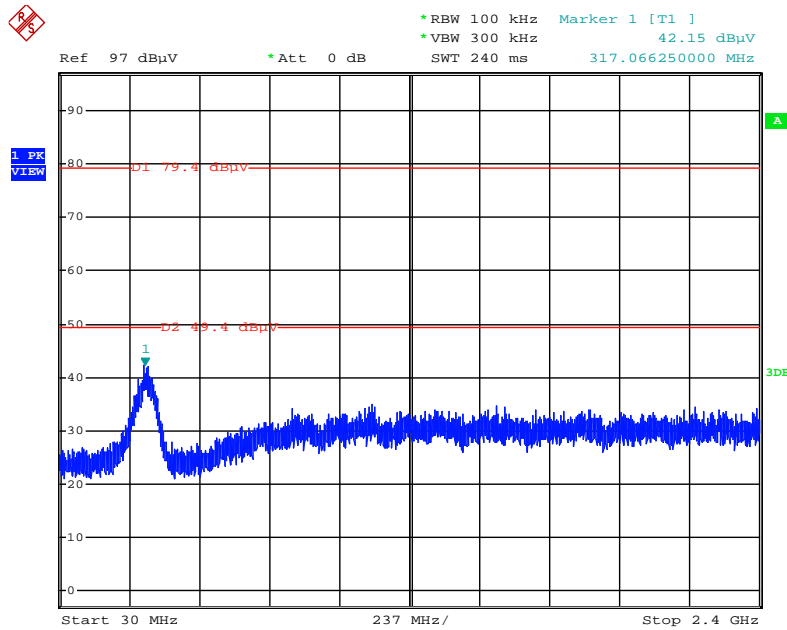

Date: 12.APR.2014 04:02:38

Plot on Configuration For EDR (8DPSK) / Channel 0 / 2500MHz~26500MHz (down 30dBc)

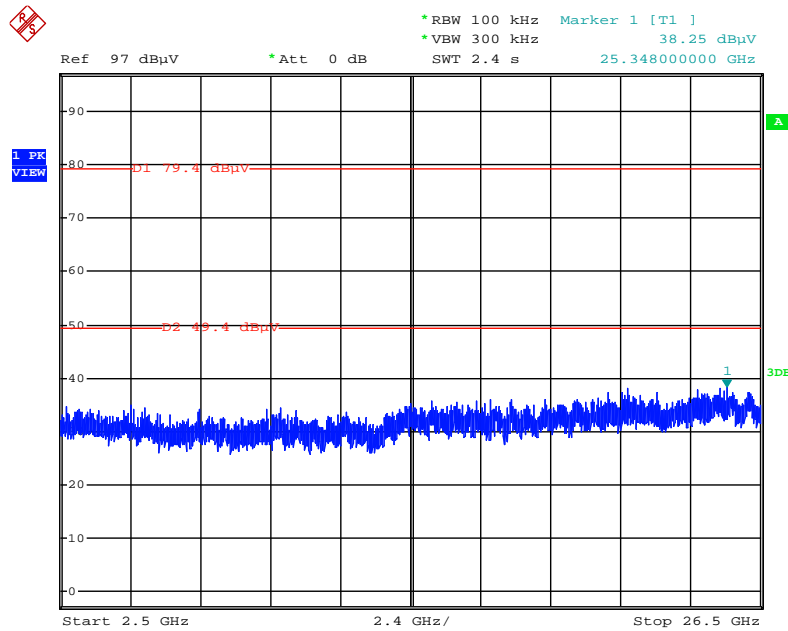

Date: 12.APR.2014 04:03:08

Plot on Configuration For EDR (8DPSK) / Channel 78 / Reference Level

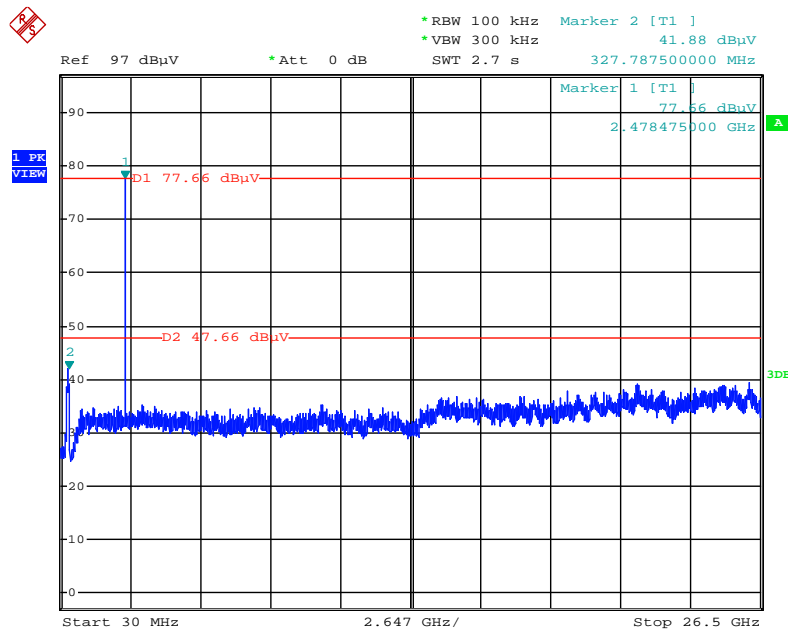

Date: 12.APR.2014 04:04:54

Plot on Configuration For EDR (8DPSK) / Channel 78 / 30MHz~2400MHz (down 30dBc)

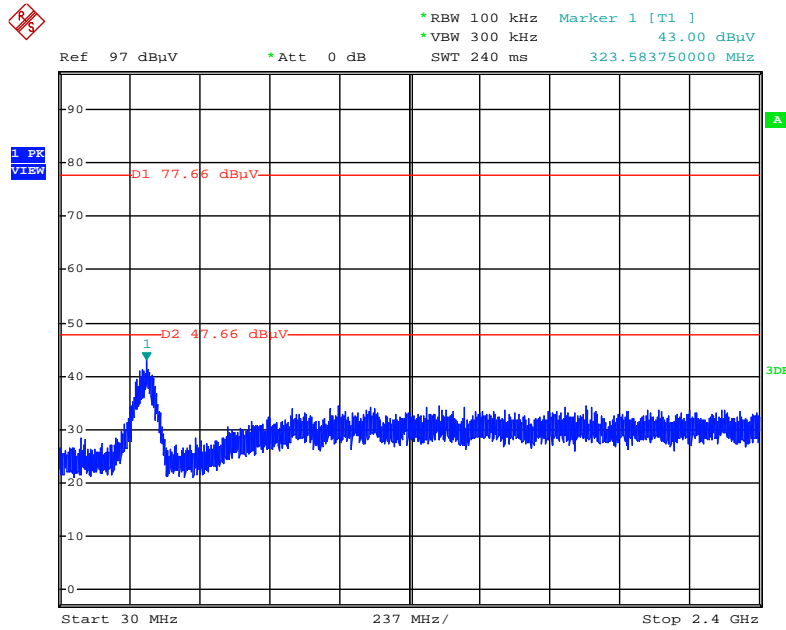

Date: 12.APR.2014 04:05:13

Plot on Configuration For EDR (8DPSK) / Channel 78 / 2500MHz~26500MHz (down 30dBc)

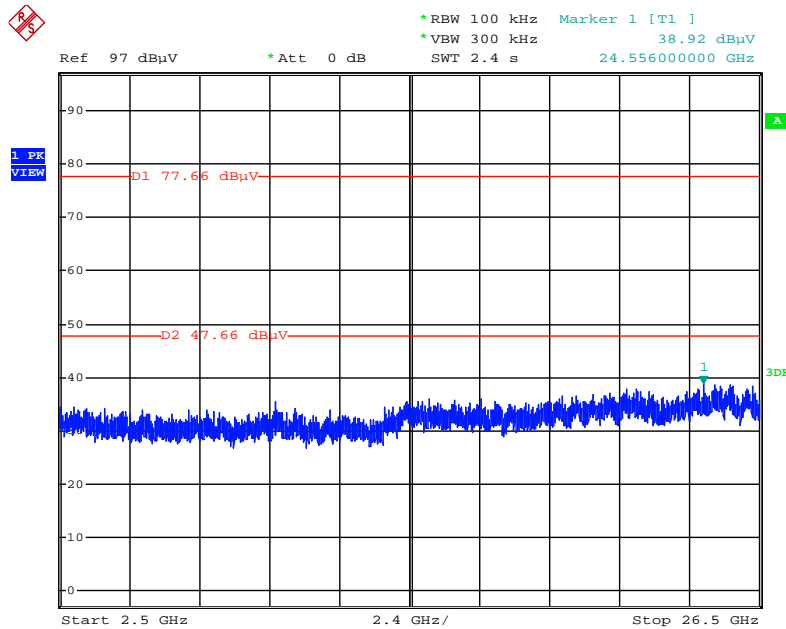

Date: 12.APR.2014 04:05:35

Plot on Configuration For EDR (8DPSK) / Hopping / Reference Level

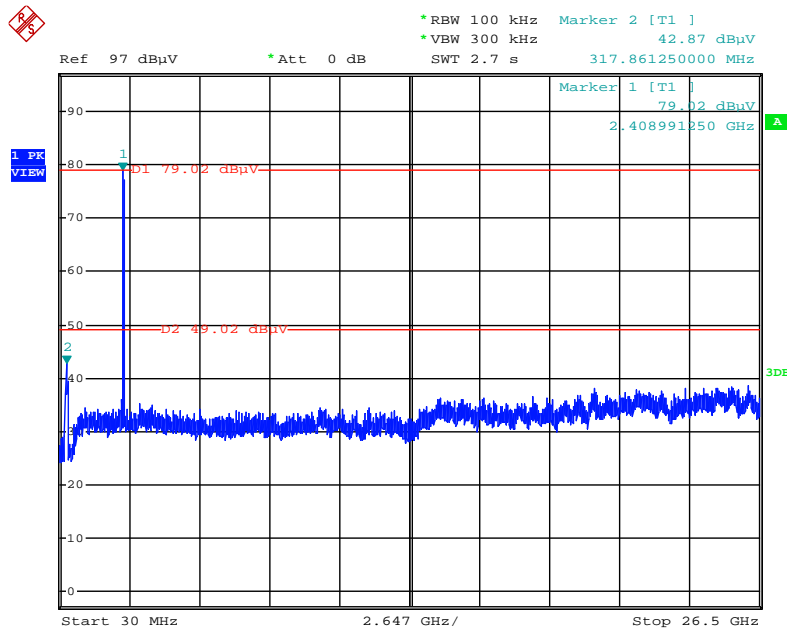

Date: 12.APR.2014 04:06:51

Plot on Configuration For EDR (8DPSK) / Hopping / 30MHz~2400MHz (down 30dBc)

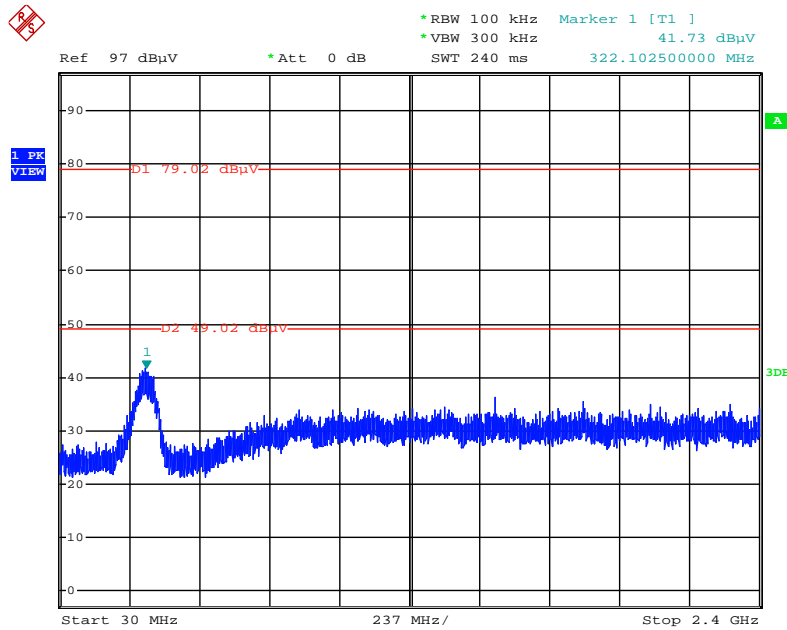

Date: 12.APR.2014 04:07:10

Plot on Configuration For EDR (8DPSK) / Hopping / 2500MHz~26500MHz (down 30dBc)

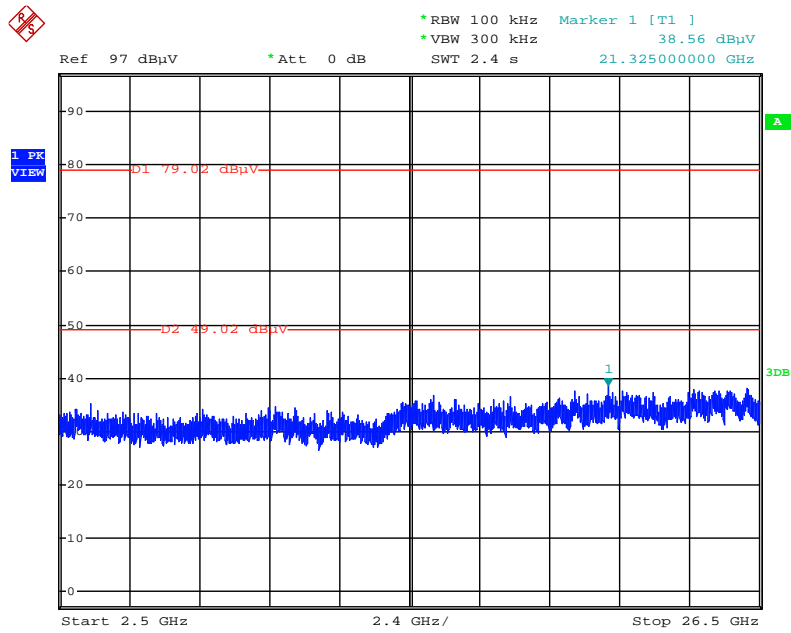

Date: 12.APR.2014 04:07:31

4.8. Antenna Requirements

4.8.1. Limit

Except for special regulations, the Low-power Radio-frequency Devices must not be equipped with any jacket for installing an antenna with extension cable. An intentional radiator shall be designed to ensure that no antenna other than that furnished by the responsible party shall be used with the device. The use of a permanently attached antenna or of an antenna that uses a unique coupling to the intentional radiator shall be considered sufficient to comply with the provisions of this Section. The manufacturer may design the unit so that the user can replace a broken antenna, but the use of a standard antenna jack or electrical connector is prohibited.

4.8.2. Antenna Connector Construction

Please refer to section 3.3 in this test report, antenna connector complied with the requirements.

5. LIST OF MEASURING EQUIPMENTS

Instrument	Manufacturer	Model No.	Serial No.	Characteristics	Calibration Date	Remark
EMI Test Receiver	R&S	ESCS 30	100355	9 kHz ~ 2.75 GHz	Apr. 12, 2013	Conduction (CO01-CB)
LISN	F.C.C.	FCC-LISN-50-16-2	04083	150 kHz ~ 100 MHz	Nov. 23, 2013	Conduction (CO01-CB)
LISN	Schwarzbeck	NSLK 8127	8127647	9kHz ~ 30MHz	Nov. 23, 2013	Conduction (CO01-CB)
COND Cable	Woken	Cable	01	150 kHz ~ 30 MHz	Dec. 04, 2013	Conduction (CO01-CB)
Software	Audix	E3	5.410e	-	N.C.R.	Conduction (CO01-CB)
BILOG ANTENNA	Schaffner	CBL6112D	22021	20MHz ~ 2GHz	Apr. 16, 2013	Radiation (03CH01-CB)
Horn Antenna	EMCO	3115	00075790	750MHz~18GHz	Nov. 01, 2013	Radiation (03CH01-CB)
Horn Antenna	SCHWARZBEAK	BBHA 9170	BBHA9170252	15GHz ~ 40GHz	Dec. 17, 2013	Radiation (03CH01-CB)
Pre-Amplifier	Agilent	8447D	2944A10991	0.1MHz ~ 1.3GHz	Nov. 12, 2013	Radiation (03CH01-CB)
Pre-Amplifier	Agilent	8449B	3008A02310	1GHz ~ 26.5GHz	Dec. 16, 2013	Radiation (03CH01-CB)
Pre-Amplifier	WM	TF-130N-R1	923365	26GHz ~ 40GHz	Oct. 23, 2013	Radiation (03CH01-CB)
Spectrum analyzer	R&S	FSP40	100019	9kHz~40GHz	Dec. 02, 2013	Radiation (03CH01-CB)
EMI Test Receiver	Agilent	N9038A	MY52260123	9kHz ~ 8GHz	Dec. 12, 2013	Radiation (03CH01-CB)
Turn Table	INN CO	CO 2000	N/A	0 ~ 360 degree	N.C.R.	Radiation (03CH01-CB)
Antenna Mast	INN CO	CO2000	N/A	1 m - 4 m	N.C.R.	Radiation (03CH01-CB)
RF Cable-low	Woken	Low Cable-1	N/A	30 MHz - 1 GHz	Nov. 17, 2013	Radiation (03CH01-CB)
RF Cable-high	Woken	High Cable-3	N/A	1 GHz - 40 GHz	Nov. 17, 2013	Radiation (03CH01-CB)
RF Cable-high	Woken	High Cable-4	N/A	1 GHz - 40 GHz	Nov. 17, 2013	Radiation (03CH01-CB)
Signal analyzer	R&S	FSV40	100979	9kHz~40GHz	Nov. 29, 2013	Conducted (TH01-CB)
Temp. and Humidity Chamber	Ten Billion	TTH-D3SP	TBN-931011	-30~100 degree	Jun. 04, 2013	Conducted (TH01-CB)
RF Cable-high	Woken	High Cable-7	-	1 GHz - 26.5 GHz	Nov. 17, 2013	Conducted (TH01-CB)
RF Cable-high	Woken	High Cable-8	-	1 GHz - 26.5 GHz	Nov. 17, 2013	Conducted (TH01-CB)
RF Cable-high	Woken	High Cable-9	-	1 GHz - 26.5 GHz	Nov. 17, 2013	Conducted (TH01-CB)
RF Cable-high	Woken	High Cable-10	-	1 GHz - 26.5 GHz	Nov. 17, 2013	Conducted (TH01-CB)
RF Cable-high	Woken	High Cable-11	-	1 GHz - 26.5 GHz	Nov. 17, 2013	Conducted (TH01-CB)
Power Sensor	Anritsu	MA2411B	0917223	300MHz~40GHz	Sep. 18, 2013	Conducted (TH01-CB)



Instrument	Manufacturer	Model No.	Serial No.	Characteristics	Calibration Date	Remark
Power Meter	Anritsu	ML2495A	1035008	300MHz~40GHz	Sep. 18, 2013	Conducted (TH01-CB)

Note: Calibration Interval of instruments listed above is one year.

* Calibration Interval of instruments listed above is two years.

N.C.R. means Non-Calibration required.

6. MEASUREMENT UNCERTAINTY

Uncertainty of Conducted Emission Measurement (150kHz ~ 30MHz)

Contribution	Uncertainty of x_i			$u(x_i)$
	Value	Unit	Probability Distribution k	
Receiver reading	0.026	dB	normal(k=2)	0.013
Cable loss	0.002	dB	normal(k=2)	0.001
AMN/LISN specification	1.200	dB	normal(k=2)	0.600
Mismatch				
Receiver VSWR 1 =	-0.080	dB	U-shaped	0.060
AMN/LISN VSWR 2 =				
Combined standard uncertainty $U_c(y)$				1.2
Measuring uncertainty for a level of confidence of 95% $U=2U_c(y)$				2.4

Uncertainty of Radiated Emission Measurement (30MHz ~ 1,000MHz)

Contribution	Uncertainty of x_i			$u(x_i)$
	Value	Unit	Probability Distribution k	
Receiver reading	± 0.173	dB	k=1	0.086
Cable loss	± 0.174	dB	k=2	0.087
Antenna gain	± 0.169	dB	k=2	0.084
Site imperfection	± 0.433	dB	Triangular	0.214
Pre-amplifier gain	± 0.366	dB	k=2	0.183
Transmitter antenna	± 1.200	dB	Rectangular	0.600
Signal generator	± 0.461	dB	Rectangular	0.231
Mismatch	± 0.080	dB	U-shape	0.040
Spectrum analyzer	± 0.500	dB	Rectangular	0.250
Combined standard uncertainty $U_c(y)$				1.778
Measuring uncertainty for a level of confidence of 95% $U=2U_c(y)$				3.555

Uncertainty of Radiated Emission Measurement (1GHz ~ 18GHz)

Contribution	Uncertainty of x_i			$u(x_i)$
	Value	Unit	Probability Distribution k	
Receiver reading	±0.191	dB	k=1	0.095
Cable loss	±0.169	dB	k=2	0.084
Antenna gain	±0.191	dB	k=2	0.096
Site imperfection	±0.582	dB	Triangular	0.291
Pre-amplifier gain	±0.304	dB	k=2	0.152
Transmitter antenna	±1.200	dB	Rectangular	0.600
Signal generator	±0.461	dB	Rectangular	0.231
Mismatch	±0.080	dB	U-shape	0.040
Spectrum analyzer	±0.500	dB	Rectangular	0.250
Combined standard uncertainty $U_c(y)$				1.839
Measuring uncertainty for a level of confidence of 95% $U=2U_c(y)$				3.678

Uncertainty of Radiated Emission Measurement (18GHz ~ 40GHz)

Contribution	Uncertainty of x_i			$u(x_i)$
	Value	Unit	Probability Distribution k	
Receiver reading	±0.186	dB	k=1	0.093
Cable loss	±0.167	dB	k=2	0.083
Antenna gain	±0.190	dB	k=2	0.095
Site imperfection	±0.488	dB	Triangular	0.244
Pre-amplifier gain	±0.269	dB	k=2	0.134
Transmitter antenna	±1.200	dB	Rectangular	0.600
Signal generator	±0.461	dB	Rectangular	0.231
Mismatch	±0.080	dB	U-shape	0.040
Spectrum analyzer	±0.500	dB	Rectangular	0.250
Combined standard uncertainty $U_c(y)$				1.771
Measuring uncertainty for a level of confidence of 95% $U=2U_c(y)$				3.541

Uncertainty of Conducted Emission Measurement

Contribution	Uncertainty of x_i			$u(x_i)$
	Value	Unit	Probability Distribution k	
Cable loss	±0.038	dB	k=2	0.019
Attenuator	±0.047	dB	k=2	0.024
Power Meter specification	±0.300	dB	Triangular	0.150
Power Sensor specification	±0.300	dB	Rectangular	0.150
Signal generator	±0.461	dB	Rectangular	0.231
Mismatch	±0.080	dB	U-shape	0.040
Spectrum analyzer	±0.500	dB	Rectangular	0.250
Combined standard uncertainty $U_c(y)$				0.863
Measuring uncertainty for a level of confidence of 95% $U=2U_c(y)$				1.726