



**FCC 47 CFR PART 15 SUBPART C &
INDUSTRY CANADA RSS-210
(Class II Permissive Change)**

TEST REPORT

For

802.11a/b/g/n/ac WLAN + Bluetooth PCI-E Mini Card

Trade Name: Broadcom

Model: BCM94352Z

Issued to

**Broadcom Corporation
190 Mathilda Avenue, Sunnyvale, CA 94086**

Issued by

**Compliance Certification Services Inc.
No.11, Wu-Gong 6th Rd., Wugu Industrial Park,
New Taipei City 248, Taiwan (R.O.C.)
<http://www.ccsrf.com>
service@ccsrf.com**

Issued Date: February 6, 2015



Note: This report shall not be reproduced except in full, without the written approval of Compliance Certification Services Inc. This document may be altered or revised by Compliance Certification Services Inc. personnel only, and shall be noted in the revision section of the document.



Revision History

Rev.	Issue Date	Revisions	Effect Page	Revised By
00	February 6, 2015	Initial Issue	ALL	Doris Chu



TABLE OF CONTENTS

1. TEST RESULT CERTIFICATION.....	4
2. EUT DESCRIPTION	5
3. TEST METHODOLOGY	6
3.1 EUT CONFIGURATION	6
3.2 EUT EXERCISE.....	6
3.3 GENERAL TEST PROCEDURES.....	6
3.4 FCC PART 15.205 RESTRICTED BANDS OF OPERATIONS.....	7
3.5 DESCRIPTION OF TEST MODES	8
4. INSTRUMENT CALIBRATION.....	9
4.1 MEASURING INSTRUMENT CALIBRATION	9
4.2 MEASUREMENT EQUIPMENT USED	9
4.3 MEASUREMENT UNCERTAINTY	10
5. FACILITIES AND ACCREDITATIONS	11
5.1 FACILITIES	11
5.2 EQUIPMENT.....	11
5.3 TABLE OF ACCREDITATIONS AND LISTINGS.....	12
6. SETUP OF EQUIPMENT UNDER TEST	13
6.1 SETUP CONFIGURATION OF EUT.....	13
6.2 SUPPORT EQUIPMENT	13
7. FCC PART 15.247 REQUIREMENTS & RSS 210 REQUIREMENTS	14
7.1 PEAK POWER.....	14
7.2 AVERAGE POWER.....	16
7.3 BAND EDGES MEASUREMENT	18
7.4 SPURIOUS EMISSIONS	29
APPENDIX I PHOTOGRAPHS OF TEST SETUP.....	40



1. TEST RESULT CERTIFICATION

Applicant: Broadcom Corporation
 190 Mathilda Avenue, Sunnyvale, CA 94086

Manufacturer: Broadcom Corporation
 190 Mathilda Avenue, Sunnyvale, CA 94086

Equipment Under Test: 802.11a/b/g/n/ac WLAN + Bluetooth PCI-E Mini Card

Trade Name: Broadcom

Model Number: BCM94352Z

Date of Test: January 20 ~ 25, 2015

APPLICABLE STANDARDS	
STANDARD	TEST RESULT
FCC 47 CFR Part 15 Subpart C & Industry Canada RSS-210 Issue 8 December, 2010	No non-compliance noted

We hereby certify that:

The above equipment was tested by Compliance Certification Services Inc. The test data, data evaluation, test procedures, and equipment configurations shown in this report were made in accordance with the procedures given in **ANSI C63.4: 2009** and the energy emitted by the sample EUT tested as described in this report is in compliance with the requirements of FCC Rules Part 15.207, 15.209, 15.247.

The test results of this report relate only to the tested sample EUT identified in this report.

Approved by:

Reviewed by:

Miller Lee
 Section Manager
 Compliance Certification Services Inc.

Angel Cheng
 Section Manager
 Compliance Certification Services Inc.



2. EUT DESCRIPTION

Product	802.11a/b/g/n/ac WLAN + Bluetooth PCI-E Mini Card		
Trade Name	Broadcom		
Model Number	BCM94352Z		
Received Date	January 9, 2015		
Power Supply	Powered from host device		
Frequency Range	2402 ~ 2480 MHz		
Transmit Power	6.50dBm		
Modulation Technique	GFSK for 1Mbps; $\pi/4$ -DQPSK for 2Mbps; 8DPSK for 3Mbps		
Number of Channels	79 Channels		
Antenna Specification	1. High-Tek Electronics Co.,Ltd P/N: 025.9006R.0011 (Main) / 0.91 dBi 025.9006S.0011 (Aux) / -1.01 dBi 2. Wistron NeWeb Corporation P/N: 025.9006R.0001 (Main) / 1.88 dBi 025.9006S.0001 (Aux) / -1.51 dBi		
Antenna Designation	PIFA Antenna		
Host Brand	lenovo	Host Model Name	Flex 3-1470
			Flex 3-1435
			Flex 3-1475
Class II Permissive Change	Adding the portable platforms Flex 3-1470, Flex 3-1435, Flex 3-1475, These hosts have the same antenna type as originally approved with lower gains.		

Remark:

1. The sample selected for test was engineering sample that approximated to production product and was provided by manufacturer.
2. This submittal(s) (test report) is intended for FCC ID: QDS-BRCM1076 & IC: 4324A-BRCM1076 filing to comply with Section 15.207, 15.209 and 15.247 of the FCC Part 15, Subpart C Rules.



3. TEST METHODOLOGY

The tests documented in this report were performed in accordance with ANSI C63.4: 2009 and FCC CFR 47 FCC CFR 47 Part 15.207, 15.209 and 15.247, RSS-GEN Issue 3, and RSS-210 Issue 8.

3.1 EUT CONFIGURATION

The EUT configuration for testing is installed on RF field strength measurement to meet the Commissions requirement and operating in a manner that intends to maximize its emission characteristics in a continuous normal application.

3.2 EUT EXERCISE

The EUT was operated in the engineering mode to fix the TX frequency that was for the purpose of the measurements.

According to its specifications, the EUT must comply with the requirements of the Section 15.207, 15.209 and 15.247 under the FCC Rules Part 15 Subpart C.

The tests documented in this report were performed in accordance with IC RSS-210, IC RSS-Gen, IC RSS-102, and ANSI C63.4: 2009.

3.3 GENERAL TEST PROCEDURES

Conducted Emissions

The EUT is placed on the turntable, which is 0.8 m above ground plane. According to the requirements in Section 13.1.4.1 of ANSI C63.4 Conducted emissions from the EUT measured in the frequency range between 0.15 MHz and 30MHz using CISPR Quasi-peak and average detector modes.

Radiated Emissions

The EUT is placed on a turn table, which is 0.8 m above ground plane. The turntable shall rotate 360 degrees to determine the position of maximum emission level. EUT is set 3m away from the receiving antenna, which varied from 1m to 4m to find out the highest emission. And also, each emission was to be maximized by changing the polarization of receiving antenna both horizontal and vertical. In order to find out the maximum emissions, exploratory radiated emission measurements were made according to the requirements in Section 13.1.4.1 of ANSI C63.4: 2009.



3.4 FCC PART 15.205 RESTRICTED BANDS OF OPERATIONS

(a) Except as shown in paragraph (d) of this section, only spurious emissions are permitted in any of the frequency bands listed below:

MHz	MHz	MHz	GHz
0.090 - 0.110	16.42 - 16.423	399.9 - 410	4.5 - 5.15
¹ 0.495 - 0.505	16.69475 - 16.69525	608 - 614	5.35 - 5.46
2.1735 - 2.1905	16.80425 - 16.80475	960 - 1240	7.25 - 7.75
4.125 - 4.128	25.5 - 25.67	1300 - 1427	8.025 - 8.5
4.17725 - 4.17775	37.5 - 38.25	1435 - 1626.5	9.0 - 9.2
4.20725 - 4.20775	73 - 74.6	1645.5 - 1646.5	9.3 - 9.5
6.215 - 6.218	74.8 - 75.2	1660 - 1710	10.6 - 12.7
6.26775 - 6.26825	108 - 121.94	1718.8 - 1722.2	13.25 - 13.4
6.31175 - 6.31225	123 - 138	2200 - 2300	14.47 - 14.5
8.291 - 8.294	149.9 - 150.05	2310 - 2390	15.35 - 16.2
8.362 - 8.366	156.52475 -	2483.5 - 2500	17.7 - 21.4
8.37625 - 8.38675	156.52525	2655 - 2900	22.01 - 23.12
8.41425 - 8.41475	156.7 - 156.9	3260 - 3267	23.6 - 24.0
12.29 - 12.293	162.0125 - 167.17	3332 - 3339	31.2 - 31.8
12.51975 - 12.52025	167.72 - 173.2	3345.8 - 3358	36.43 - 36.5
12.57675 - 12.57725	240 - 285	3600 - 4400	(²)
13.36 - 13.41	322 - 335.4		

¹ Until February 1, 1999, this restricted band shall be 0.490-0.510 MHz.

² Above 38.6

(b) Except as provided in paragraphs (d) and (e), the field strength of emissions appearing within these frequency bands shall not exceed the limits shown in Section 15.209. At frequencies equal to or less than 1000 MHz, compliance with the limits in Section 15.209 shall be demonstrated using measurement instrumentation employing a CISPR quasi-peak detector. Above 1000 MHz, compliance with the emission limits in Section 15.209 shall be demonstrated based on the average value of the measured emissions. The provisions in Section 15.35 apply to these measurements.



3.5 DESCRIPTION OF TEST MODES

The EUT (Model: BCM94352Z) had been tested under operating condition.

Test program used to control the EUT for staying in continuous transmitting mode was programmed.

Software used to control the EUT for staying in continuous transmitting mode was programmed.

After verification, all tests were carried out with the worst case test modes as shown below except radiated spurious emission below 1GHz and power line conducted emissions below 30MHz, which worst case was in normal link mode only.

During the preliminary test, GFSK, $\pi/4$ -QPSK & 8DPSK with DH1 were pre-tested and found that 8DPSK emits the highest output power. Then the tests were carried on with DH1 compare to DH3 & DH5 and found that 8DPSK with DH5 emit the highest output power, and therefore had been tested under operating condition.

Following channels were selected for the radiated emission testing only as listed below:

Tested Channel	Modulation Type	Packet Type	Date Rate
Low, Mid, High	GFSK	DH 5	1
Low, Mid, High	8DPSK	DH 5	3

The field strength of spurious emission was measured in the following position: EUT stand-up position (Z axis), lie-down position (X, Y axis). The worst emission was found in lie-down position (X axis) and the worst case was recorded.



4. INSTRUMENT CALIBRATION

4.1 MEASURING INSTRUMENT CALIBRATION

The measuring equipment, which was utilized in performing the tests documented herein, has been calibrated in accordance with the manufacturer's recommendations for utilizing calibration equipment, which is traceable to recognized national standards.

4.2 MEASUREMENT EQUIPMENT USED

Equipment Used for Emissions Measurement

Remark: Each piece of equipment is scheduled for calibration once a year and Loop Antenna is scheduled for calibration once three years.

Wugu 966 Chamber A				
Name of Equipment	Manufacturer	Model	Serial Number	Calibration Due
Spectrum Analyzer	Agilent	E4446A	US42510268	09/18/2015
EMI Test Receiver	R&S	ESCI	100064	05/30/2015
Bilog Antenna	Sunol Sciences	JB3	A030105	08/19/2015
Horn Antenna	EMCO	3117	00055165	02/04/2015
Turn Table	CCS	CC-T-1F	N/A	N.C.R
Antenna Tower	CCS	CC-A-1F	N/A	N.C.R
Controller	CCS	CC-C-1F	N/A	N.C.R
Test S/W	EZ-EMC (CCS-3A1RE)			



4.3 MEASUREMENT UNCERTAINTY

PARAMETER	UNCERTAINTY
3M Semi Anechoic Chamber / 30M~200M	+/- 4.0138
3M Semi Anechoic Chamber / 200M~1000M	+/- 3.9483
3M Semi Anechoic Chamber / 1G~8G	+/- 2.5975
3M Semi Anechoic Chamber / 8G~18G	+/- 2.6112
3M Semi Anechoic Chamber / 18G~26G	+/- 2.7389
3M Semi Anechoic Chamber / 26G~40G	+/- 2.9683

Remark: This uncertainty represents an expanded uncertainty expressed at approximately the 95% confidence level using a coverage factor of $k=2$.



5. FACILITIES AND ACCREDITATIONS

5.1 FACILITIES

All measurement facilities used to collect the measurement data are located at

No.11, Wu-Gong 6th Rd., Wugu Industrial Park, New Taipei City 248, Taiwan (R.O.C.)
Tel: 886-2-2299-9720 / Fax: 886-2-2298-4045

No.139, Wugong Rd., Wugu Industrial Park, New Taipei City 248, Taiwan (R.O.C.)

The sites are constructed in conformance with the requirements of ANSI C63.7, ANSI C63.4 and CISPR Publication 22.

5.2 EQUIPMENT

Radiated emissions are measured with one or more of the following types of linearly polarized antennas: tuned dipole, biconical, log periodic, bi-log, and/or ridged waveguide, horn. Spectrum analyzers with pre-selectors and quasi-peak detectors are used to perform radiated measurements.



Conducted emissions are measured with Line Impedance Stabilization Networks and EMI Test Receivers.

Calibrated wideband preamplifiers, coaxial cables, and coaxial attenuators are also used for making measurements.

All receiving equipment conforms to CISPR Publication 16-1, "Radio Interference Measuring Apparatus and Measurement Methods."



5.3 TABLE OF ACCREDITATIONS AND LISTINGS

Country	Agency	Scope of Accreditation	Logo
USA	FCC	3M Semi Anechoic Chamber (FCC MRA: TW1039) to perform FCC Part 15 measurements	 FCC MRA: TW1039
Taiwan	TAF	LP0002, RTTE01, FCC Method-47 CFR Part 15 Subpart C, D, E, RSS-210, RSS-310 IDA TS SRD, AS/NZS 4268, AS/NZS 4771, TS 12.1 & 12.2, ETSI EN 300 440-1, ETSI EN 300 440-2, ETSI EN 300 328, ETSI EN 300 220-1, ETSI EN 300 220-2, ETSI EN 301 893, ETSI EN 301 489-1/3/7/17 FCC OET Bulletin 65 + Supplement C, EN 50360, EN 50361, EN 50371, RSS 102, EN 50383, EN 50385, EN 50392, IEC 62209, CNS 14958-1, CNS 14959 FCC Method -47 CFR Part 15 Subpart B IEC / EN 61000-3-2, IEC / EN 61000-3-3, IEC / EN 61000-4-2/3/4/5/6/8/11	
Canada	Industry Canada	3M Semi Anechoic Chamber (IC 2324G-1 / IC 2324G-2) to perform	 IC 2324G-1 IC 2324G-2

* No part of this report may be used to claim or imply product endorsement by A2LA or any agency of the US Government.



6. SETUP OF EQUIPMENT UNDER TEST

6.1 SETUP CONFIGURATION OF EUT

See test photographs attached in Appendix II for the actual connections between EUT and support equipment.

6.2 SUPPORT EQUIPMENT

No.	Equipment	Model No.	Serial No.	FCC ID	Trade Name	Data Cable	Power Cord
1	Notebook PC	Flex 3-1470	N/A	FCC DOC	Lenovo	N/A	AC I/P: Unshielded, 1.8m DC O/P: Unshielded, 1.8m with a core

Remark:

1. All the equipment/cables were placed in the worst-case configuration to maximize the emission during the test.
2. Grounding was established in accordance with the manufacturer's requirements and conditions for the intended use.



7. FCC PART 15.247 REQUIREMENTS & RSS 210 REQUIREMENTS

7.1 PEAK POWER

LIMIT

The maximum peak output power of the intentional radiator shall not exceed the following:

1. According to §15.247(a)(1) & RSS-210 §A8.4(2) , Frequency hopping systems shall have hopping channel carrier frequencies separated by a minimum of 25 kHz or the 20 dB bandwidth of the hopping channel, whichever is greater. Alternatively, frequency hopping systems operating in the 2400-2483.5 MHz band may have hopping channel carrier frequencies that are separated by 25 kHz or two-thirds of the 20 dB bandwidth of the hopping channel, whichever is greater, provided the systems operate with an output power no greater than 125 mW.
2. According to §15.247(b)(3) & RSS 210 §A8.4(4),, for systems using digital modulation in the bands of 902-928 MHz, 2400-2483.5 MHz, and 5725-5850 MHz: 1 Watt.

Test Configuration

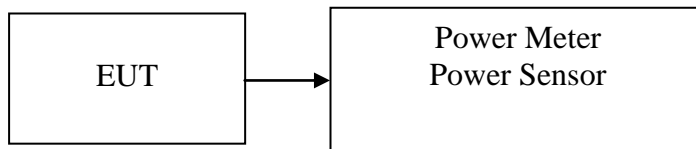

TEST PROCEDURE

The transmitter output is connected to the Power Meter. The Power Meter is set to the peak power detection.

TEST RESULTS

No non-compliance noted.



Test Data

For GFSK / DH5

Channel	Frequency (MHz)	Output Power (dBm)	Output Power (W)	Limit (W)	Result
Low	2402	5.10	0.0032	1	PASS
Mid	2441	4.80	0.0030		PASS
High	2480	4.50	0.0028		PASS

For 8DPSK / DH5

Channel	Frequency (MHz)	Output Power (dBm)	Output Power (W)	Limit (W)	Result
Low	2402	*6.50	0.0045	1	PASS
Mid	2441	6.10	0.0041		PASS
High	2480	5.80	0.0038		PASS



7.2 AVERAGE POWER

LIMIT

None; for reporting purposes only.

Test Configuration

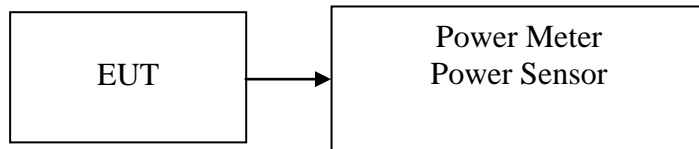

TEST PROCEDURE

The transmitter output is connected to the Power Meter. The Power Meter is set to the avg power detection.

TEST RESULTS

No non-compliance noted.



Test Data

For GFSK / DH5

Channel	Frequency (MHz)	Output Power (dBm)	Output Power (W)	Limit (W)	Result
Low	2402	4.70	0.0030	1	PASS
Mid	2441	4.40	0.0028		PASS
High	2480	4.10	0.0026		PASS

For 8DPSK / DH5

Channel	Frequency (MHz)	Output Power (dBm)	Output Power (W)	Limit (W)	Result
Low	2402	4.80	0.0030	1	PASS
Mid	2441	4.50	0.0028		PASS
High	2480	4.20	0.0026		PASS



7.3 BAND EDGES MEASUREMENT

LIMIT

According to §15.247(d), in any 100 kHz bandwidth outside the frequency band in which the spread spectrum or digitally modulated intentional radiator is operating, the radio frequency power that is produced by the intentional radiator shall be at least 20 dB below that in the 100 kHz bandwidth within the band that contains the highest level of the desired power, based on either an RF conducted or a radiated measurement, provided the transmitter demonstrates compliance with the peak conducted power limits. If the transmitter complies with the conducted power limits based on the use of RMS averaging over a time interval, as permitted under paragraph (b)(3) of this section, the attenuation required under this paragraph shall be 30 dB instead of 20 dB. Attenuation below the general limits specified in §15.209(a) is not required. In addition, radiated emissions which fall in the restricted bands, as defined in §15.205(a), must also comply with the radiated emission limits specified in §15.209(a) (see §15.205(c)).

According to RSS-210 §A8.5, in any 100 kHz bandwidth outside the frequency band in which the spread spectrum or digitally modulated device is operating, the radio frequency power that is produced shall be at least 20 dB below that in the 100 kHz bandwidth within the band that contains the highest level of the desired power, based on either an RF conducted or a radiated measurement, provided the transmitter demonstrates compliance with the peak conducted power limits. If the transmitter complies with the conducted power limits based on the use of RMS averaging over a time interval, as permitted under section A8.4(4), the attenuation required shall be 30 dB instead of 20 dB. Attenuation below the general limits specified in Tables 2 and 3 is not required. In addition, radiated emissions which fall in the restricted bands of Table 1 must also comply with the radiated emission limits specified in Tables 2 and 3.



Test Configuration

For Radiated

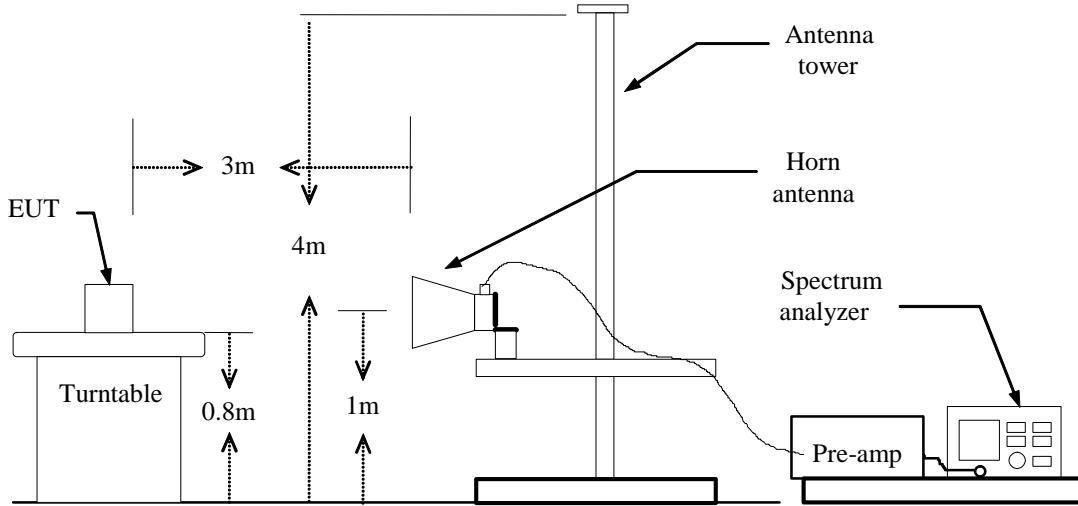

For Conducted

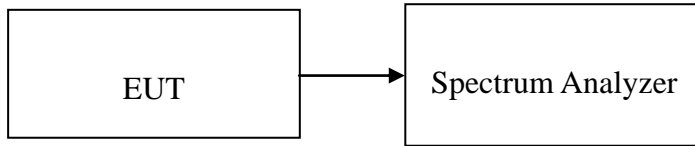



TEST PROCEDURE

For Radiated

1. The EUT is placed on a turntable, which is 0.8m above the ground plane.
2. The turntable shall be rotated for 360 degrees to determine the position of maximum emission level.
3. EUT is set 3m away from the receiving antenna, which is varied from 1m to 4m to find out the highest emission.
4. Set the spectrum analyzer in the following setting in order to capture the lower and upper band-edges of the emission:
 - (a) PEAK: RBW=1MHz,VBW=3MHz,Sweep=100ms
 - (b) AVERAGE: RBW=1MHz VBW=10Hz
5. Repeat the procedures until all the PEAK and AVERAGE versus POLARIZATION are measured.

For Conducted

Conducted RF measurements of the transmitter output were made to confirm that the EUT antenna port conducted emissions meet the specified limit and to identify any spurious signals that require further investigation or measurements on the radiated emissions site.

The transmitter output is connected to the spectrum analyzer. The resolution bandwidth is set to 300 kHz. The video bandwidth is set to 300 kHz.

TEST RESULTS

Refer to attach spectrum analyzer data chart.



For GFSK / DH5

Band Edges (CH Low)

Polarity: Vertical

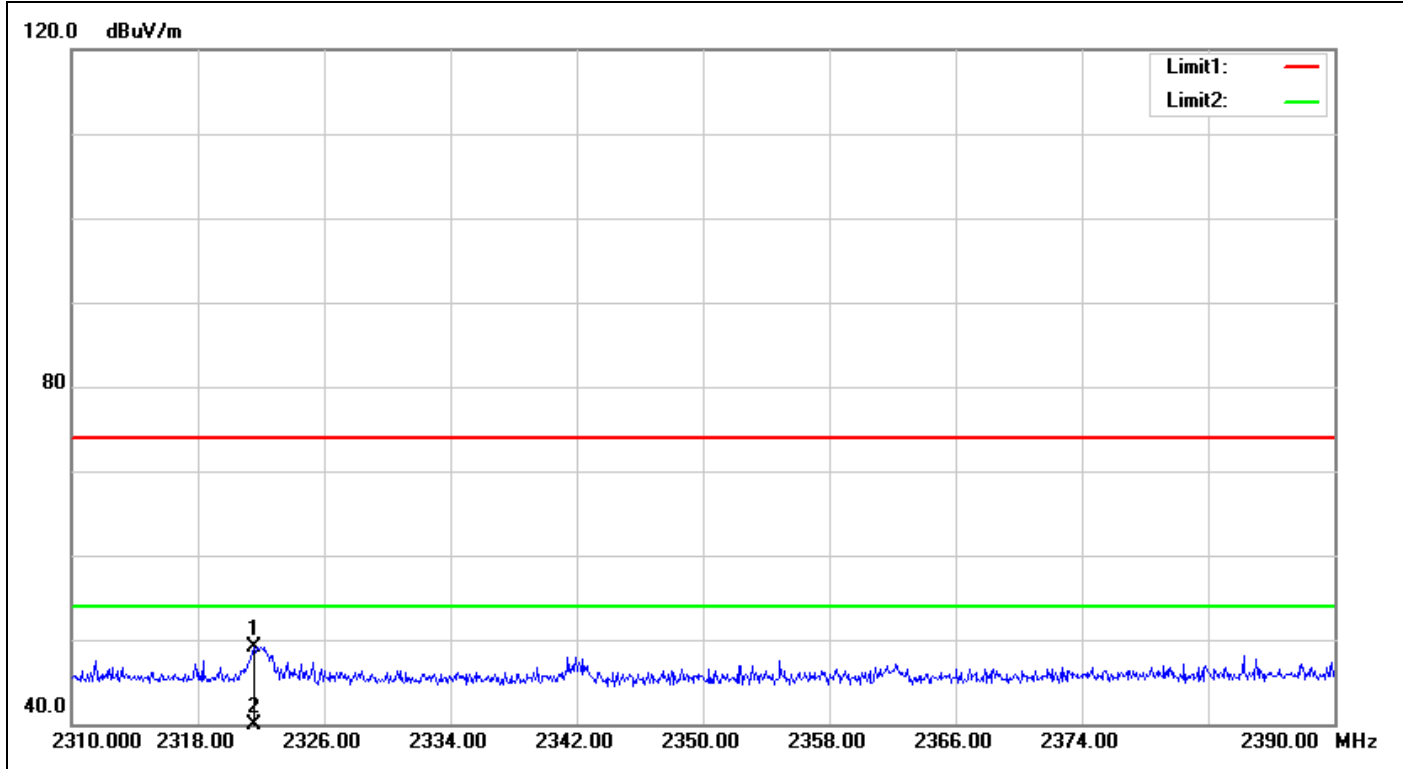

No.	Frequency (MHz)	Reading (dBuV)	Correct Factor(dB/m)	Result (dBuV/m)	Limit (dBuV/m)	Margin (dB)	Height (cm)	Degree (°)	Remark
1	2321.600	53.36	-4.25	49.11	74.00	-24.89	100	177	peak
2	2321.600	43.56	-4.25	39.31	54.00	-14.69	100	177	AVG



Polarity: Horizontal

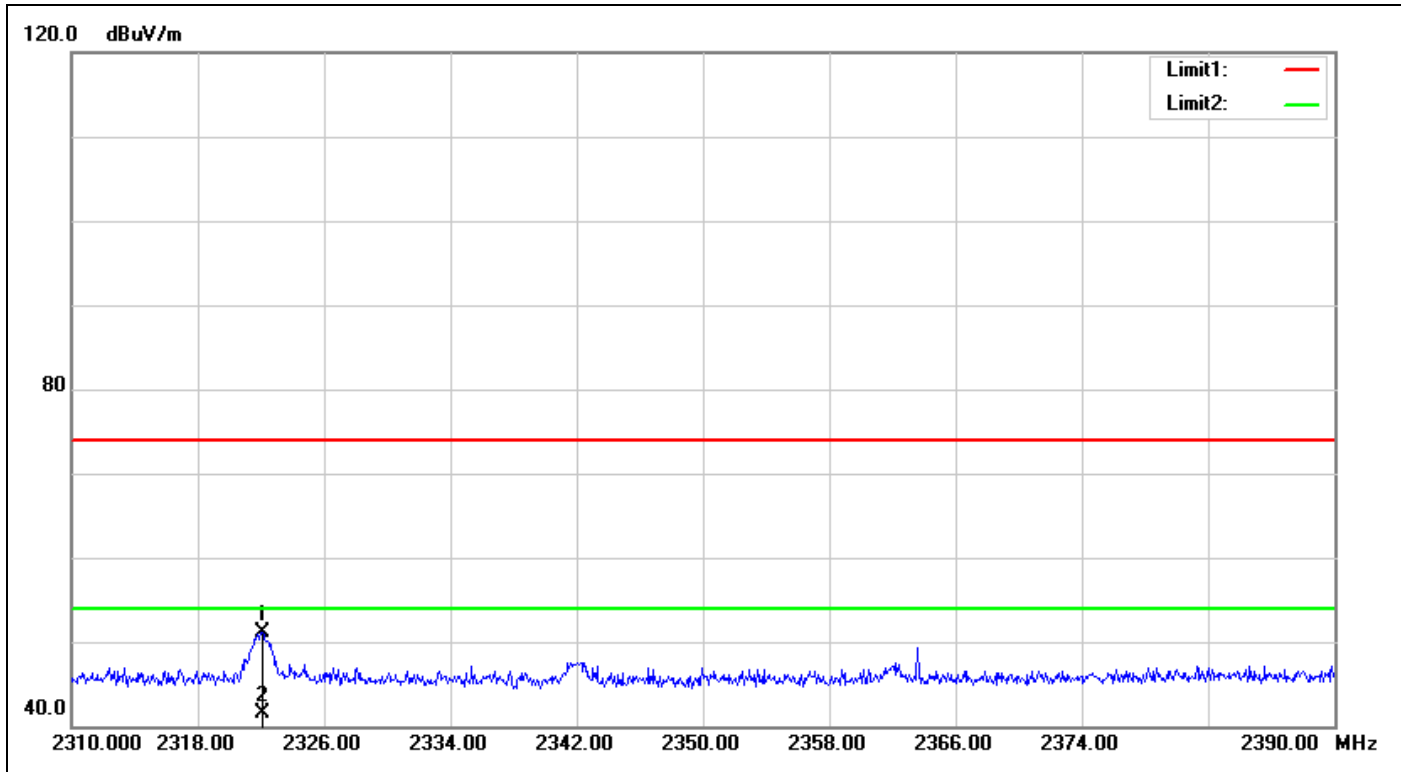

No.	Frequency (MHz)	Reading (dBuV)	Correct Factor(dB/m)	Result (dBuV/m)	Limit (dBuV/m)	Margin (dB)	Height (cm)	Degree (°)	Remark
1	2322.080	55.35	-4.24	51.11	74.00	-22.89	100	97	peak
2	2322.080	45.66	-4.24	41.42	54.00	-12.58	100	97	AVG



Band Edges (CH High)

Polarity: Vertical

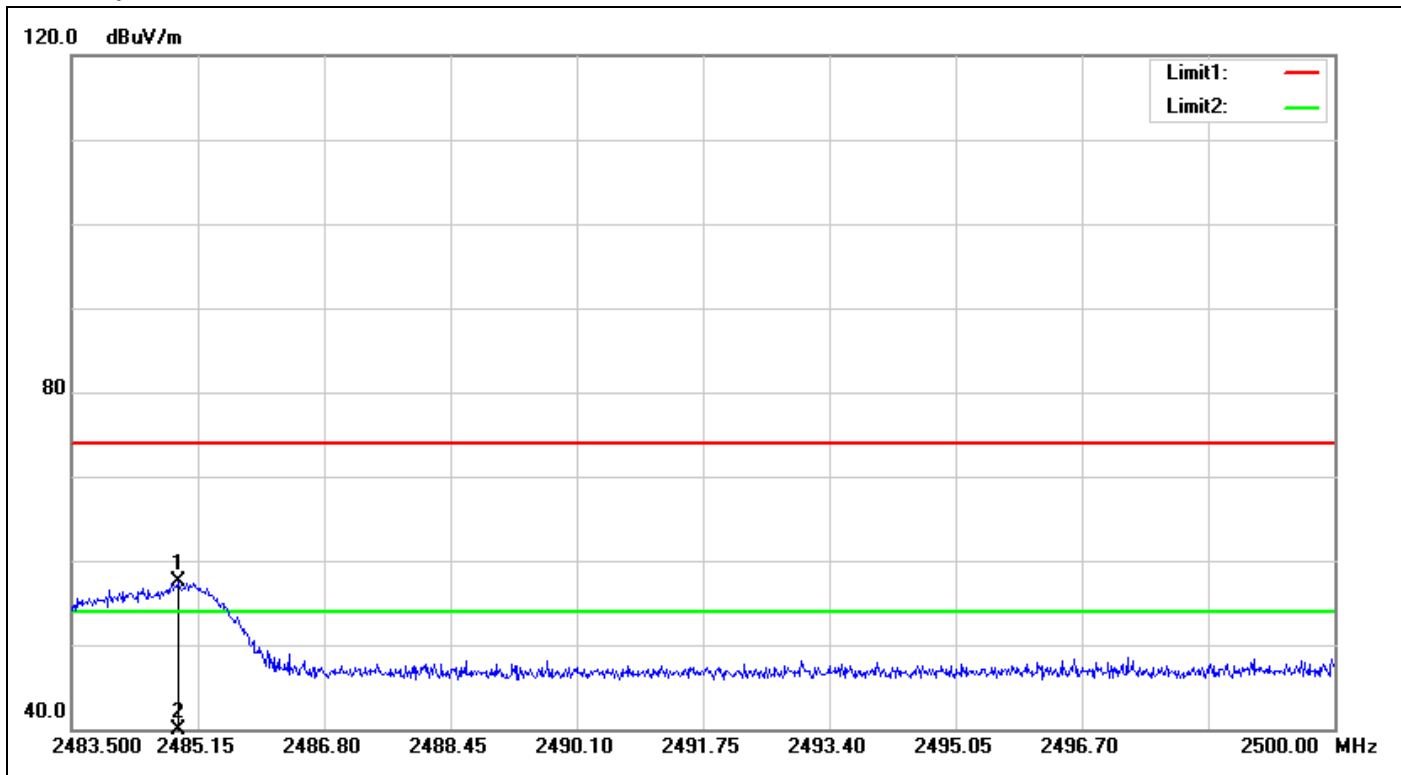

No.	Frequency (MHz)	Reading (dBuV)	Correct Factor(dB/m)	Result (dBuV/m)	Limit (dBuV/m)	Margin (dB)	Height (cm)	Degree (°)	Remark
1	2484.903	60.70	-3.26	57.44	74.00	-16.56	100	218	peak
2	2484.903	41.51	-3.26	38.25	54.00	-15.75	100	218	AVG



Polarity: Horizontal

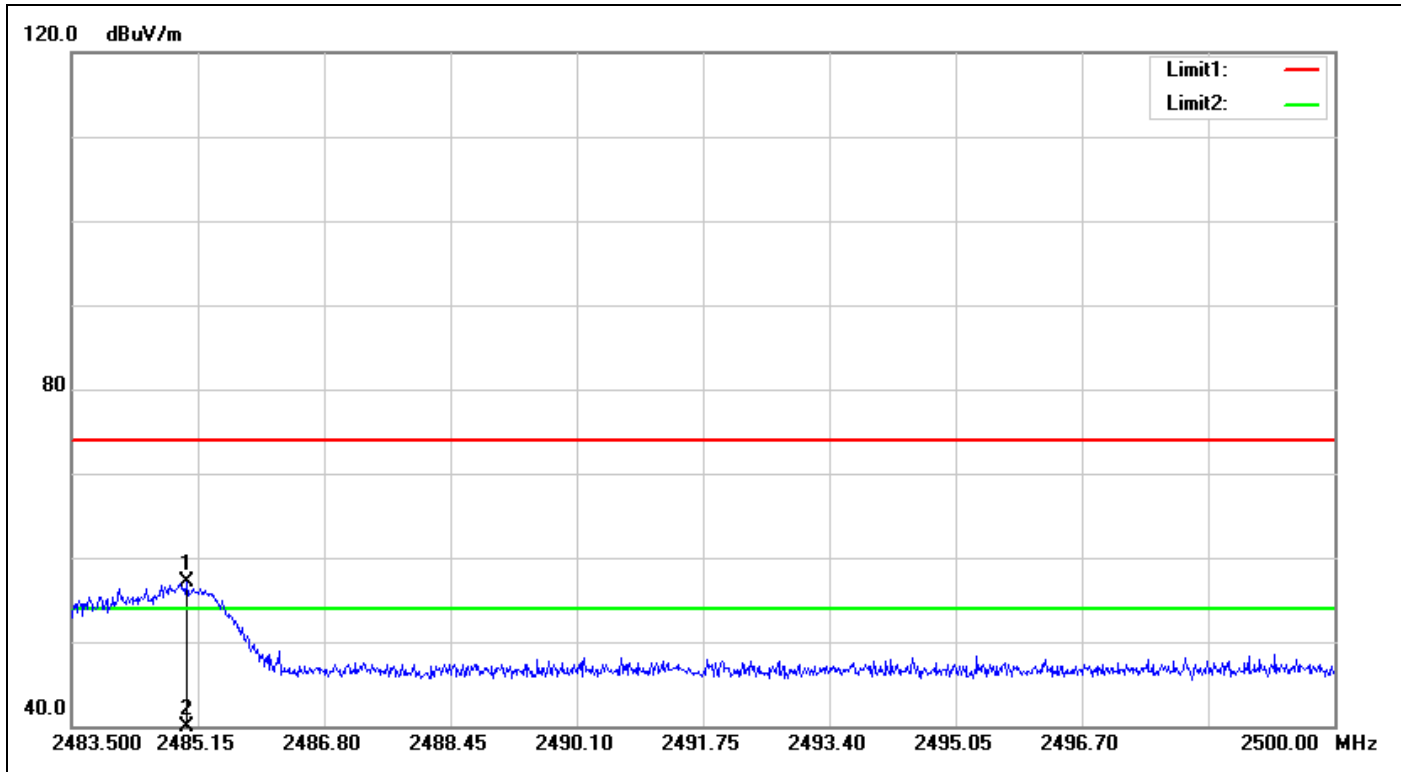

No.	Frequency (MHz)	Reading (dBuV)	Correct Factor(dB/m)	Result (dBuV/m)	Limit (dBuV/m)	Margin (dB)	Height (cm)	Degree (°)	Remark
1	2485.001	60.29	-3.26	57.03	74.00	-16.97	100	16	peak
2	2485.001	41.19	-3.26	37.93	54.00	-16.07	100	16	AVG



For 8DPSK / DH5

Band Edges (CH Low)

Polarity: Vertical

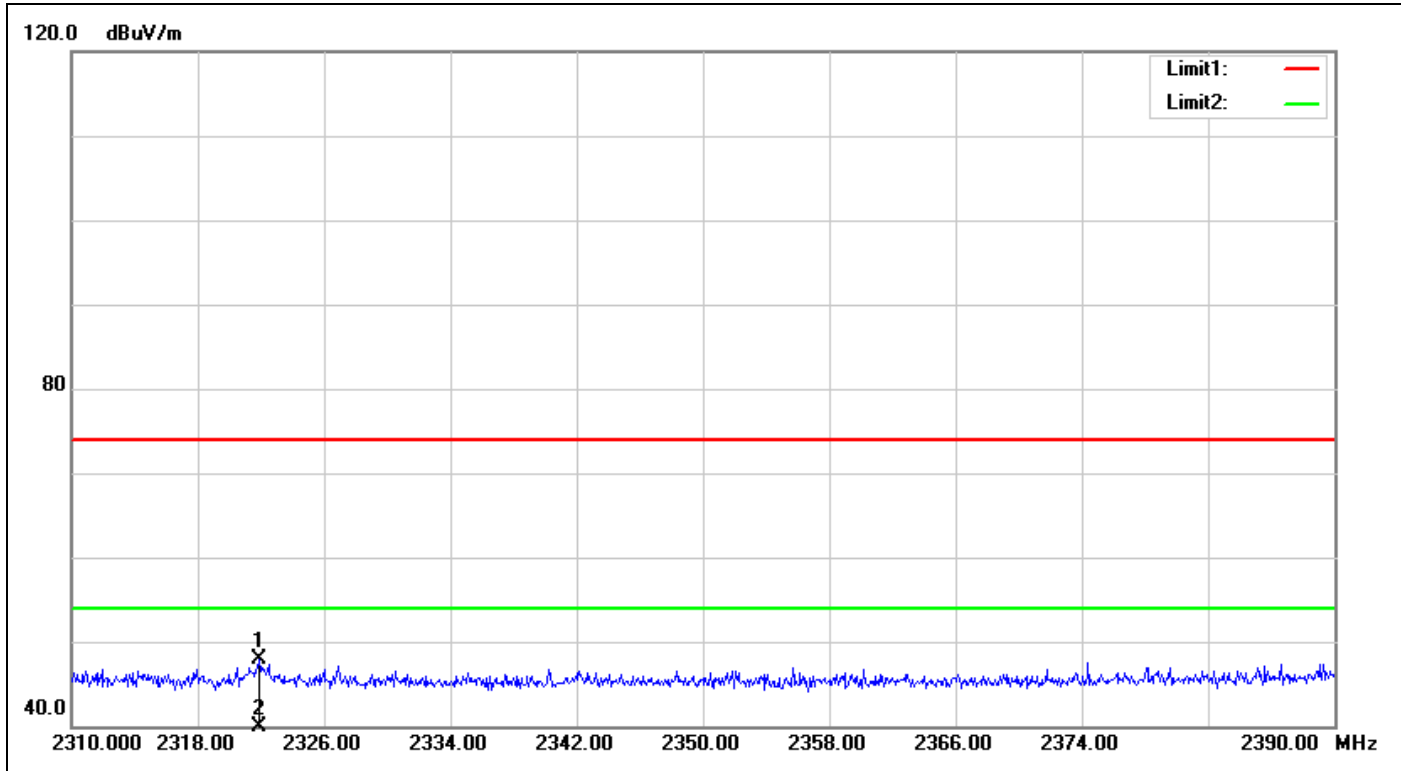

No.	Frequency (MHz)	Reading (dBuV)	Correct Factor(dB/m)	Result (dBuV/m)	Limit (dBuV/m)	Margin (dB)	Height (cm)	Degree (°)	Remark
1	2321.920	52.06	-4.24	47.82	74.00	-26.18	100	240	peak
2	2321.920	39.07	-4.24	34.83	54.00	-19.17	100	240	AVG



Polarity: Horizontal

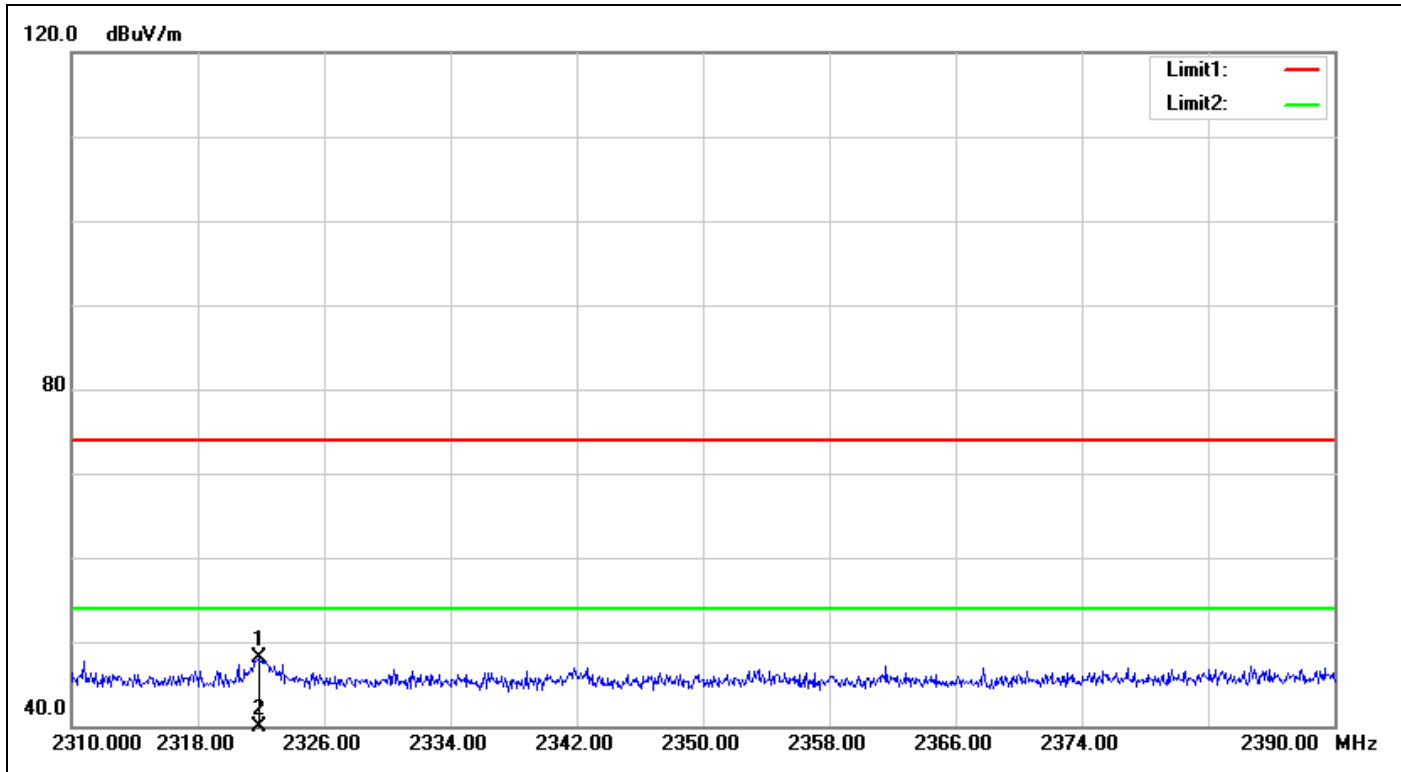

No.	Frequency (MHz)	Reading (dBuV)	Correct Factor(dB/m)	Result (dBuV/m)	Limit (dBuV/m)	Margin (dB)	Height (cm)	Degree (°)	Remark
1	2321.840	52.27	-4.24	48.03	74.00	-25.97	100	19	peak
2	2321.840	40.95	-4.24	36.71	54.00	-17.29	100	19	AVG



Band Edges (CH High)

Polarity: Vertical

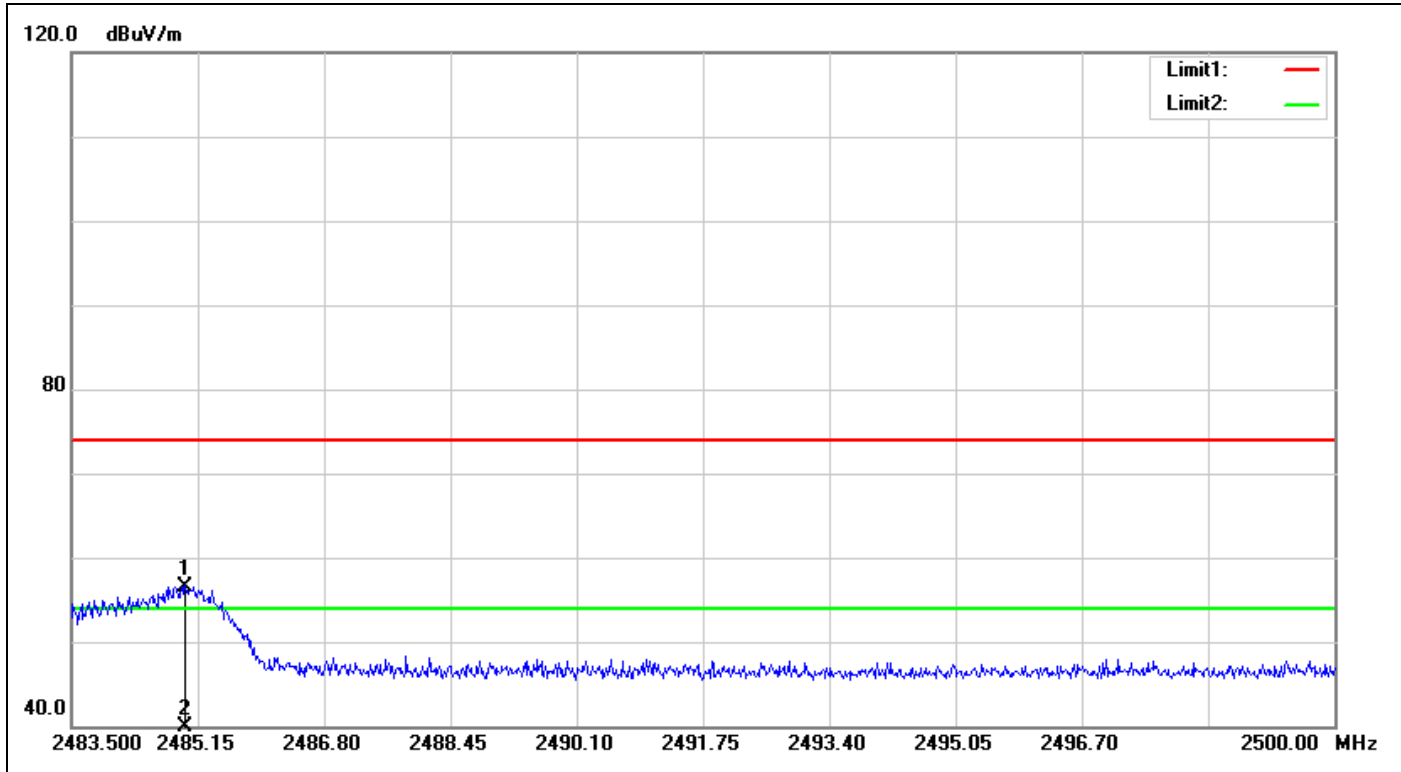

No.	Frequency (MHz)	Reading (dBuV)	Correct Factor(dB/m)	Result (dBuV/m)	Limit (dBuV/m)	Margin (dB)	Height (cm)	Degree (°)	Remark
1	2484.985	59.86	-3.26	56.60	74.00	-17.40	100	192	peak
2	2484.985	38.57	-3.26	35.31	54.00	-18.69	100	192	AVG



Polarity: Horizontal

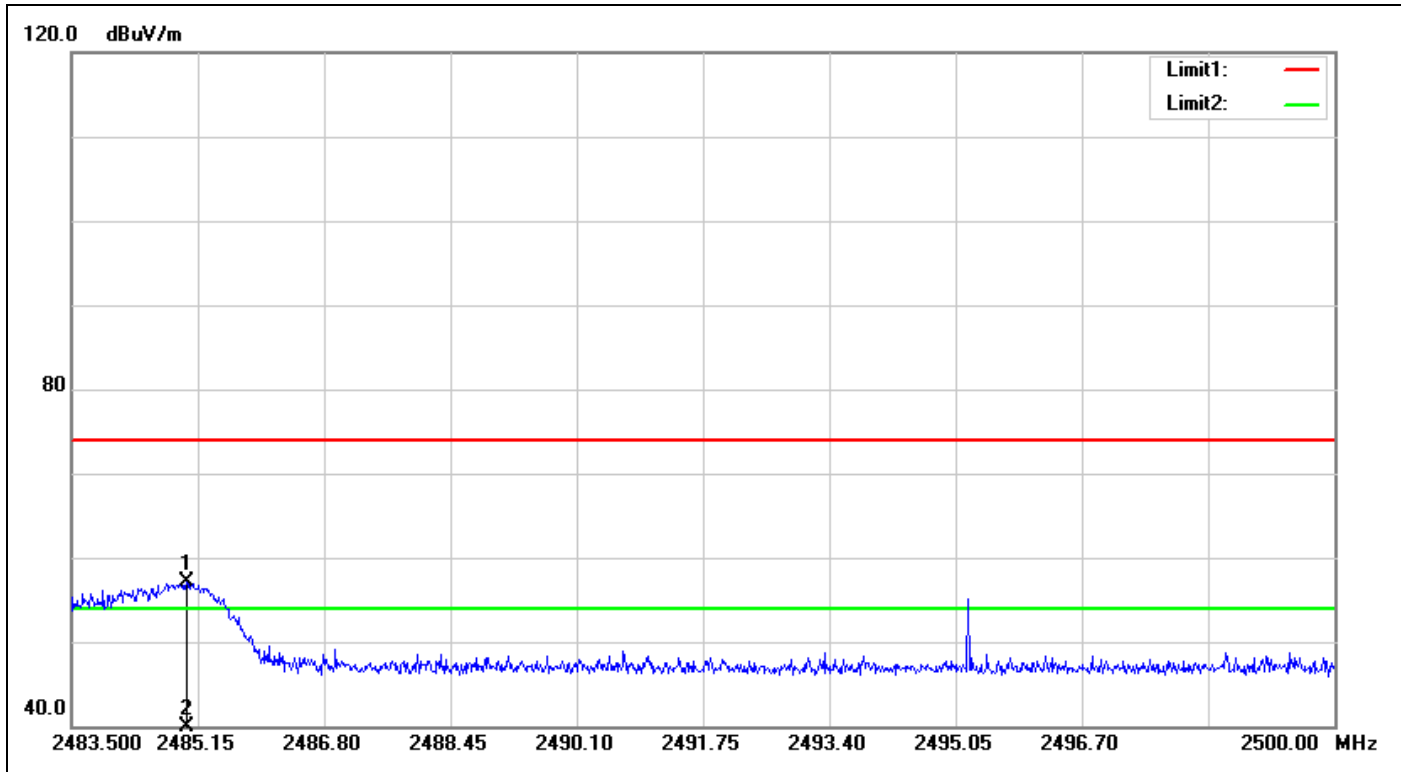

No.	Frequency (MHz)	Reading (dBuV)	Correct Factor(dB/m)	Result (dBuV/m)	Limit (dBuV/m)	Margin (dB)	Height (cm)	Degree (°)	Remark
1	2485.001	60.35	-3.26	57.09	74.00	-16.91	100	218	peak
2	2485.001	38.67	-3.26	35.41	54.00	-18.59	100	218	AVG



7.4 SPURIOUS EMISSIONS

7.4.1 Radiated Emissions

LIMIT

All spurious emissions shall comply with the limits of §15.209(a) and RSS-Gen Table 2 & Table 5.

RSS-Gen Table 2 & Table 5: General Field Strength Limits for Transmitters and Receivers at Frequencies Above 30 MHz ^(Note)

Frequency (MHz)	Field Strength microvolts/m at 3 metres (watts, e.i.r.p.)	
	Transmitters	Receivers
30-88	100 (3 nW)	100 (3 nW)
88-216	150 (6.8 nW)	150 (6.8 nW)
216-960	200 (12 nW)	200 (12 nW)
Above 960	500 (75 nW)	500 (75 nW)

Note: *Measurements for compliance with limits in the above table may be performed at distances other than 3 metres, in accordance with Section 7.2.7.

Transmitting devices are not permitted in Table 1 bands or, unless stated otherwise, in TV bands (54-72 MHz, 76-88 MHz, 174-216 MHz, 470-608 MHz and 614-806 MHz).

RSS-Gen Table 6: General Field Strength Limits for Transmitters at Frequencies Below 30 MHz (Transmit)

Frequency	Field Strength (microvolts/m)	Magnetic H-Field (microamperes/m)	Measurement Distance (metres)
9-490 kHz	2,400/F (F in kHz)	2,400/377F (F in kHz)	3000
490-1,705 kHz	24,000/F (F in kHz)	24,000/377F (F in kHz)	30
1.705-30 MHz	30	N/A	30

Note: The emission limits for the bands 9-90 kHz and 110-490 kHz are based on measurements employing an average detector.



Test Configuration

9kHz ~ 30MHz

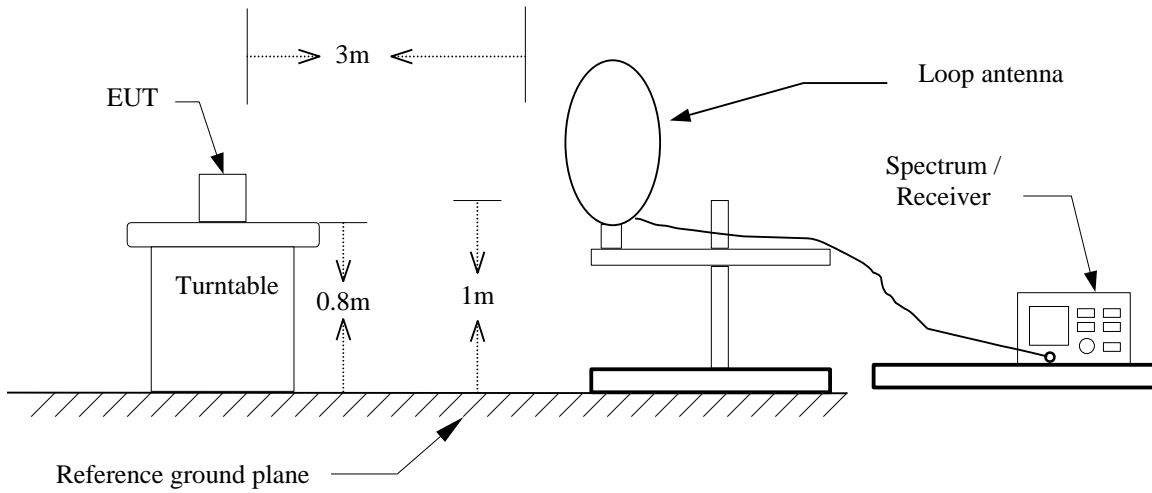

30MHz ~ 1GHz

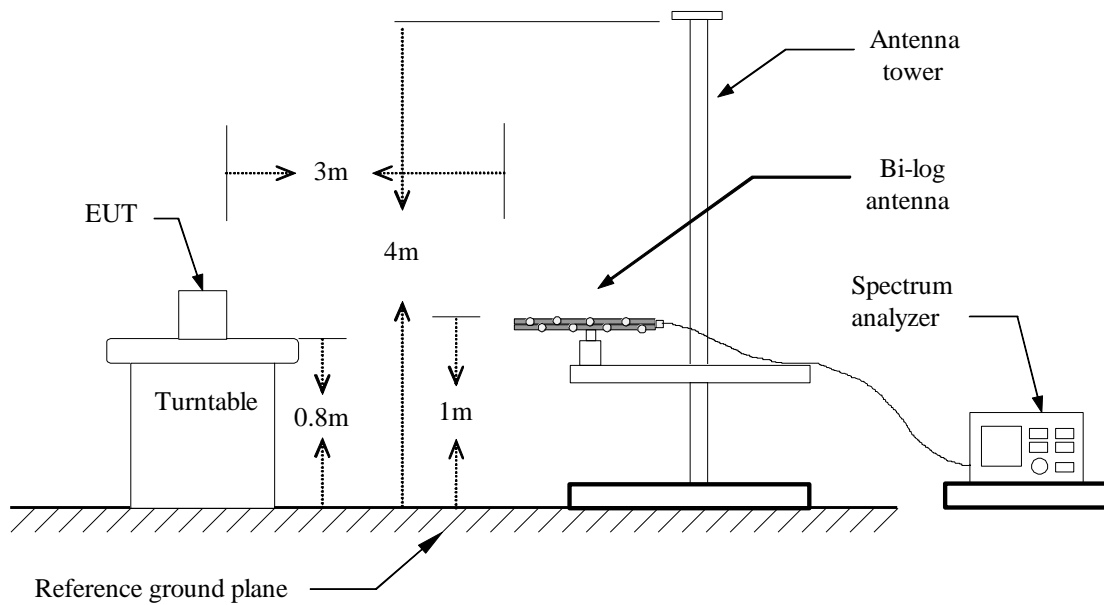



Above 1 GHz

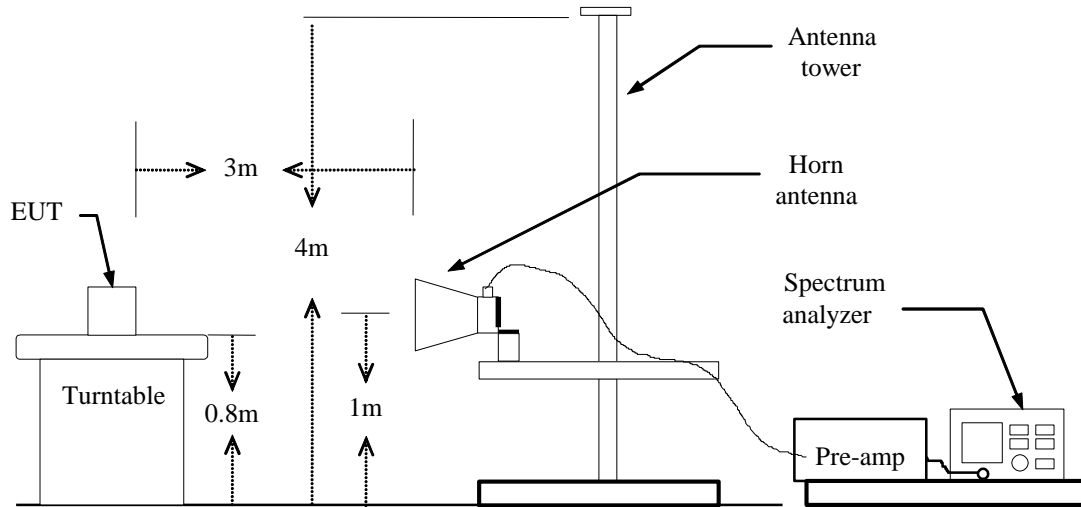



TEST PROCEDURE

1. The EUT is placed on a turntable, which is 0.8m above ground plane.
2. The turntable shall be rotated for 360 degrees to determine the position of maximum emission level.
3. EUT is set 3m away from the receiving antenna, which is varied from 1m to 4m to find out the highest emissions.
4. Maximum procedure was performed on the six highest emissions to ensure EUT compliance.
5. And also, each emission was to be maximized by changing the polarization of receiving antenna both horizontal and vertical.
6. Set the spectrum analyzer in the following setting as:
Below 1GHz:
RBW=100kHz / VBW=300kHz / Sweep=AUTO
Above 1GHz:
(a) PEAK: RBW=1MHz, VBW=3MHz / Sweep=AUTO
(b) AVERAGE: RBW=1MHz / VBW=10Hz / Sweep=AUTO
7. Repeat above procedures until the measurements for all frequencies are complete.



Below 1 GHz

Operation Mode: Normal Link **Test Date:** January 20, 2015
Temperature: 27°C **Tested by:** Owen Wu
Humidity: 53 % RH **Polarity:** Ver. / Hor.

Frequency (MHz)	Reading (dBuV)	Correction Factor (dB/m)	Result (dBuV/m)	Limit (dBuV/m)	Margin (dB)	Remark	Ant.Pol. (H/V)
40.6700	55.57	-17.58	37.99	40.00	-2.01	peak	V
140.5800	40.57	-17.71	22.86	43.50	-20.64	peak	V
301.6000	37.50	-16.37	21.13	46.00	-24.87	peak	V
450.9800	40.54	-12.64	27.90	46.00	-18.10	peak	V
599.3900	38.19	-10.52	27.67	46.00	-18.33	peak	V
833.1600	35.08	-6.98	28.10	46.00	-17.90	peak	V
57.1600	57.48	-23.64	33.84	40.00	-6.16	peak	H
252.1300	40.43	-18.25	22.18	46.00	-23.82	peak	H
456.8000	37.64	-12.55	25.09	46.00	-20.91	peak	H
597.4500	33.77	-10.53	23.24	46.00	-22.76	peak	H
833.1600	41.56	-6.98	34.58	46.00	-11.42	peak	H
998.0600	34.68	-4.71	29.97	54.00	-24.03	peak	H

Remark:

- 1. No emission found between lowest internal used/generated frequency to 30MHz (9kHz~30MHz)*
- 2. Radiated emissions measured in frequency range from 30 MHz to 1000MHz were made with an instrument using peak/quasi-peak detector mode.*
- 3. Quasi-peak test would be performed if the peak result were greater than the quasi-peak limit or as required by the applicant.*
- 4. Measurements above show only up to 6 maximum emissions noted, or would be lesser, with " N/A " remark, if no specific emissions from the EUT are recorded (ie: margin>20dB from the applicable limit) and considered that's already beyond the background noise floor.*
- 5. Margin (dB) = Remark result (dBuV/m) – Quasi-peak limit (dBuV/m).*



Above 1 GHz

Operation Mode: TX / GFSK / DH5 / CH Low

Test Date: January 25, 2015

Temperature: 27°C

Tested by: Owen Wu

Humidity: 53% RH

Polarity: Ver. / Hor.

Frequency (MHz)	Reading (dBuV)	Correction Factor (dB/m)	Result (dBuV/m)	Limit (dBuV/m)	Margin (dB)	Remark	Ant. Pol. (H/V)
1940.000	52.44	-5.20	47.24	74.00	-26.76	peak	V
4805.000	46.54	4.04	50.58	74.00	-23.42	peak	V
N/A							
2198.000	49.85	-4.44	45.41	74.00	-28.59	peak	H
4805.000	47.41	4.04	51.45	74.00	-22.55	peak	H
N/A							

Remark:

1. Measuring frequencies from 1 GHz to the 10th harmonic of highest fundamental frequency.
2. Radiated emissions measured in frequency above 1000MHz were made with an instrument using peak/average detector mode.
3. Average test would be performed if the peak result were greater than the average limit .
4. Data of measurement within this frequency range shown “ --- ” in the table above means the reading of emissions are attenuated more than 20dB below the permissible limits or the field strength is too small to be measured.
5. Measurements above show only up to 6 maximum emissions noted, or would be lesser, with “ N/A ” remark, if no specific emissions from the EUT are recorded (ie: margin>20dB from the applicable limit) and considered that's already beyond the background noise floor.
6. Margin (dB) = Remark result (dBuV/m) – Average limit (dBuV/m).



Operation Mode: TX / GFSK / DH5 / CH Mid

Test Date: January 25, 2015

Temperature: 27°C

Tested by: Owen Wu

Humidity: 53% RH

Polarity: Ver. / Hor.

Frequency (MHz)	Reading (dBuV)	Correction Factor (dB/m)	Result (dBuV/m)	Limit (dBuV/m)	Margin (dB)	Remark	Ant. Pol. (H/V)
1732.000	49.77	-6.30	43.47	74.00	-30.53	peak	V
4880.000	41.85	3.91	45.76	74.00	-28.24	peak	V
N/A							
2204.000	49.80	-4.42	45.38	74.00	-28.62	peak	H
4880.000	40.26	3.91	44.17	74.00	-29.83	peak	H
N/A							

Remark:

1. Measuring frequencies from 1 GHz to the 10th harmonic of highest fundamental frequency.
2. Radiated emissions measured in frequency above 1000MHz were made with an instrument using peak/average detector mode.
3. Average test would be performed if the peak result were greater than the average limit.
4. Data of measurement within this frequency range shown “ --- ” in the table above means the reading of emissions are attenuated more than 20dB below the permissible limits or the field strength is too small to be measured.
5. Measurements above show only up to 6 maximum emissions noted, or would be lesser, with “ N/A ” remark, if no specific emissions from the EUT are recorded (ie: margin>20dB from the applicable limit) and considered that's already beyond the background noise floor.
6. Margin (dB) = Remark result (dBuV/m) – Average limit (dBuV/m).



Operation Mode: TX / GFSK / DH5 / CH High

Test Date: January 25, 2015

Temperature: 27°C

Tested by: Owen Wu

Humidity: 53% RH

Polarity: Ver. / Hor.

Frequency (MHz)	Reading (dBuV)	Correction Factor (dB/m)	Result (dBuV/m)	Limit (dBuV/m)	Margin (dB)	Remark	Ant. Pol. (H/V)
2060.000	50.20	-4.94	45.26	74.00	-28.74	peak	V
N/A							
1694.000	52.22	-6.50	45.72	74.00	-28.28	peak	H
4960.000	38.93	3.93	42.86	74.00	-31.14	peak	H
N/A							

Remark:

1. Measuring frequencies from 1 GHz to the 10th harmonic of highest fundamental frequency.
2. Radiated emissions measured in frequency above 1000MHz were made with an instrument using peak/average detector mode.
3. Average test would be performed if the peak result were greater than the average limit.
4. Data of measurement within this frequency range shown “ --- ” in the table above means the reading of emissions are attenuated more than 20dB below the permissible limits or the field strength is too small to be measured.
5. Measurements above show only up to 6 maximum emissions noted, or would be lesser, with “ N/A ” remark, if no specific emissions from the EUT are recorded (ie: margin>20dB from the applicable limit) and considered that's already beyond the background noise floor.
6. Margin (dB) = Remark result (dBuV/m) – Average limit (dBuV/m).



Operation Mode: TX / 8DPSK / DH5 / CH Low

Test Date: January 25, 2015

Temperature: 27°C

Tested by: Owen Wu

Humidity: 53% RH

Polarity: Ver. / Hor.

Frequency (MHz)	Reading (dBuV)	Correction Factor (dB/m)	Result (dBuV/m)	Limit (dBuV/m)	Margin (dB)	Remark	Ant. Pol. (H/V)
1792.000	51.63	-5.98	45.65	74.00	-28.35	peak	V
N/A							
1880.000	49.55	-5.52	44.03	74.00	-29.97	peak	H
N/A							

Remark:

1. Measuring frequencies from 1 GHz to the 10th harmonic of highest fundamental frequency.
2. Radiated emissions measured in frequency above 1000MHz were made with an instrument using peak/average detector mode.
3. Average test would be performed if the peak result were greater than the average limit.
4. Data of measurement within this frequency range shown “ --- ” in the table above means the reading of emissions are attenuated more than 20dB below the permissible limits or the field strength is too small to be measured.
5. Measurements above show only up to 6 maximum emissions noted, or would be lesser, with “ N/A ” remark, if no specific emissions from the EUT are recorded (ie: margin > 20dB from the applicable limit) and considered that's already beyond the background noise floor.
6. Margin (dB) = Remark result (dBuV/m) – Average limit (dBuV/m).



Operation Mode: TX / 8DPSK / DH5 / CH Mid

Test Date: January 25, 2015

Temperature: 27°C

Tested by: Owen Wu

Humidity: 53% RH

Polarity: Ver. / Hor.

Frequency (MHz)	Reading (dBuV)	Correction Factor (dB/m)	Result (dBuV/m)	Limit (dBuV/m)	Margin (dB)	Remark	Ant. Pol. (H/V)
1792.000	51.99	-5.98	46.01	74.00	-27.99	peak	V
N/A							
1720.000	52.81	-6.36	46.45	74.00	-27.55	peak	H
N/A							

Remark:

1. Measuring frequencies from 1 GHz to the 10th harmonic of highest fundamental frequency.
2. Radiated emissions measured in frequency above 1000MHz were made with an instrument using peak/average detector mode.
3. Average test would be performed if the peak result were greater than the average limit.
4. Data of measurement within this frequency range shown “ --- ” in the table above means the reading of emissions are attenuated more than 20dB below the permissible limits or the field strength is too small to be measured.
5. Measurements above show only up to 6 maximum emissions noted, or would be lesser, with “ N/A ” remark, if no specific emissions from the EUT are recorded (ie: margin > 20dB from the applicable limit) and considered that's already beyond the background noise floor.
6. Margin (dB) = Remark result (dBuV/m) – Average limit (dBuV/m).



Operation Mode: TX / 8DPSK / DH5 / CH High

Test Date: January 25, 2015

Temperature: 27°C

Tested by: Owen Wu

Humidity: 53% RH

Polarity: Ver. / Hor.

Frequency (MHz)	Reading (dBuV)	Correction Factor (dB/m)	Result (dBuV/m)	Limit (dBuV/m)	Margin (dB)	Remark	Ant. Pol. (H/V)
1810.000	52.90	-5.89	47.01	74.00	-26.99	peak	V
N/A							
1950.000	50.14	-5.14	45.00	74.00	-29.00	peak	H
N/A							

Remark:

1. Measuring frequencies from 1 GHz to the 10th harmonic of highest fundamental frequency.
2. Radiated emissions measured in frequency above 1000MHz were made with an instrument using peak/average detector mode.
3. Average test would be performed if the peak result were greater than the average limit.
4. Data of measurement within this frequency range shown “ --- ” in the table above means the reading of emissions are attenuated more than 20dB below the permissible limits or the field strength is too small to be measured.
5. Measurements above show only up to 6 maximum emissions noted, or would be lesser, with “ N/A ” remark, if no specific emissions from the EUT are recorded (ie: margin > 20dB from the applicable limit) and considered that's already beyond the background noise floor.
6. Margin (dB) = Remark result (dBuV/m) – Average limit (dBuV/m).