

#01 WLAN2.4G_802.11b_Bottom Face_0cm_Ch6_Yageo_Ant A

DUT: 280820

Communication System: 802.11b ; Frequency: 2437 MHz;Duty Cycle: 1:1

Medium: MSL_2450_120904 Medium parameters used: $f = 2437$ MHz; $\sigma = 1.95$ mho/m; $\epsilon_r = 52.4$;

$\rho = 1000$ kg/m³

Ambient Temperature : 22.5 °C ; Liquid Temperature : 21.5 °C

DASY5 Configuration:

- Probe: EX3DV4 - SN3819; ConvF(7.4, 7.4, 7.4); Calibrated: 2011/11/16
- Sensor-Surface: 4mm (Mechanical Surface Detection)
- Electronics: DAE4 Sn1279; Calibrated: 2012/5/3
- Phantom: ELI 4.0; Type: QDOVA001BA; Serial: 1029
- Software: DASY5 Version; SEMCAD X Version 13.4 Build 45

Ch6/Area Scan (121x181x1): Measurement grid: dx=20mm, dy=20mm

Maximum value of SAR (interpolated) = 0.030 mW/g

Ch6/Zoom Scan (5x5x7)/Cube 0: Measurement grid: dx=8mm, dy=8mm, dz=5mm

Reference Value = 0 V/m; Power Drift = 0.103 dB

Peak SAR (extrapolated) = 0.048 W/kg

SAR(1 g) = 0.016 mW/g; SAR(10 g) = 0.00779 mW/g

Maximum value of SAR (measured) = 0.017 mW/g

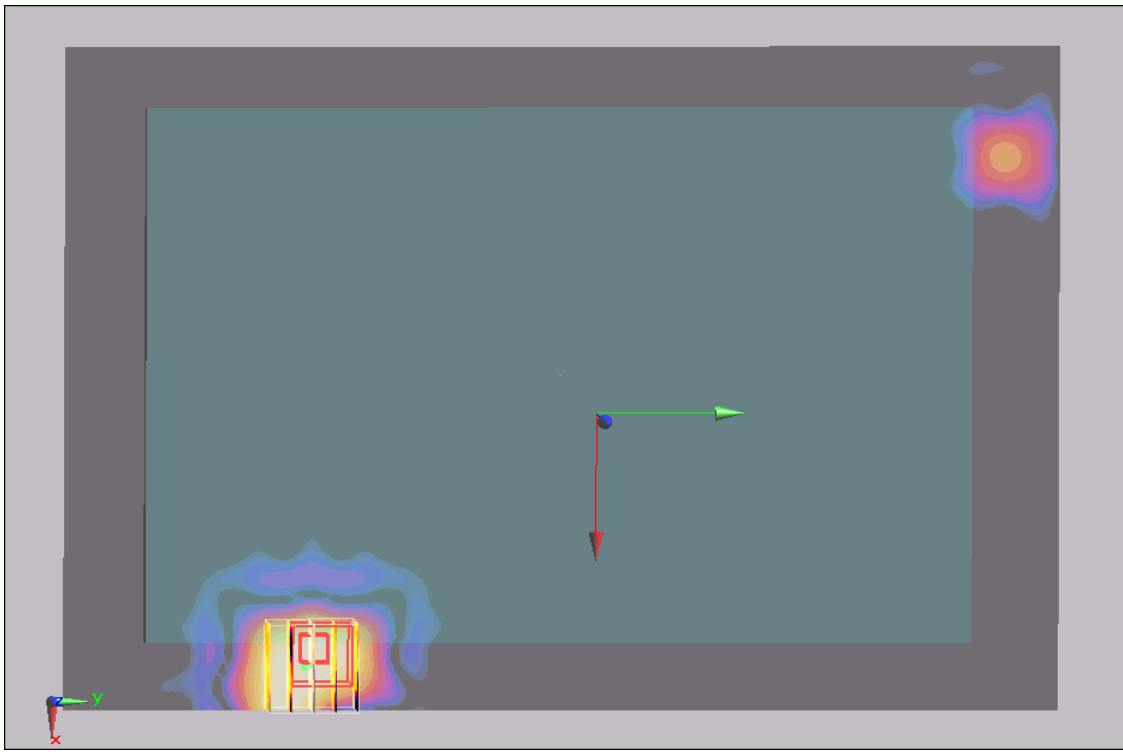
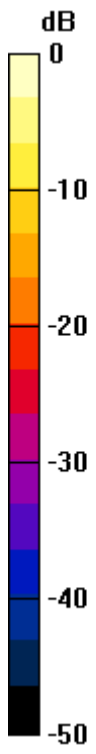

0 dB = 0.017mW/g

#02 WLAN2.4G_802.11b_Edge1_0cm_Ch6_Yageo_Ant A

DUT: 280820

Communication System: 802.11b ; Frequency: 2437 MHz;Duty Cycle: 1:1

Medium: MSL_2450_120904 Medium parameters used: $f = 2437$ MHz; $\sigma = 1.95$ mho/m; $\epsilon_r = 52.4$;

$\rho = 1000$ kg/m³

Ambient Temperature : 22.5 °C ; Liquid Temperature : 21.5 °C

DASY5 Configuration:

- Probe: EX3DV4 - SN3819; ConvF(7.4, 7.4, 7.4); Calibrated: 2011/11/16
- Sensor-Surface: 4mm (Mechanical Surface Detection)
- Electronics: DAE4 Sn1279; Calibrated: 2012/5/3
- Phantom: ELI 4.0; Type: QDOVA001BA; Serial: 1029
- Software: DASY5 Version; SEMCAD X Version 13.4 Build 45

Ch6/Area Scan (31x181x1): Measurement grid: dx=20mm, dy=20mm

Maximum value of SAR (interpolated) = 0.347 mW/g

Ch6/Zoom Scan (5x5x7)/Cube 0: Measurement grid: dx=8mm, dy=8mm, dz=5mm

Reference Value = 1.99 V/m; Power Drift = 0.102 dB

Peak SAR (extrapolated) = 0.684 W/kg

SAR(1 g) = 0.289 mW/g; SAR(10 g) = 0.117 mW/g

Maximum value of SAR (measured) = 0.328 mW/g

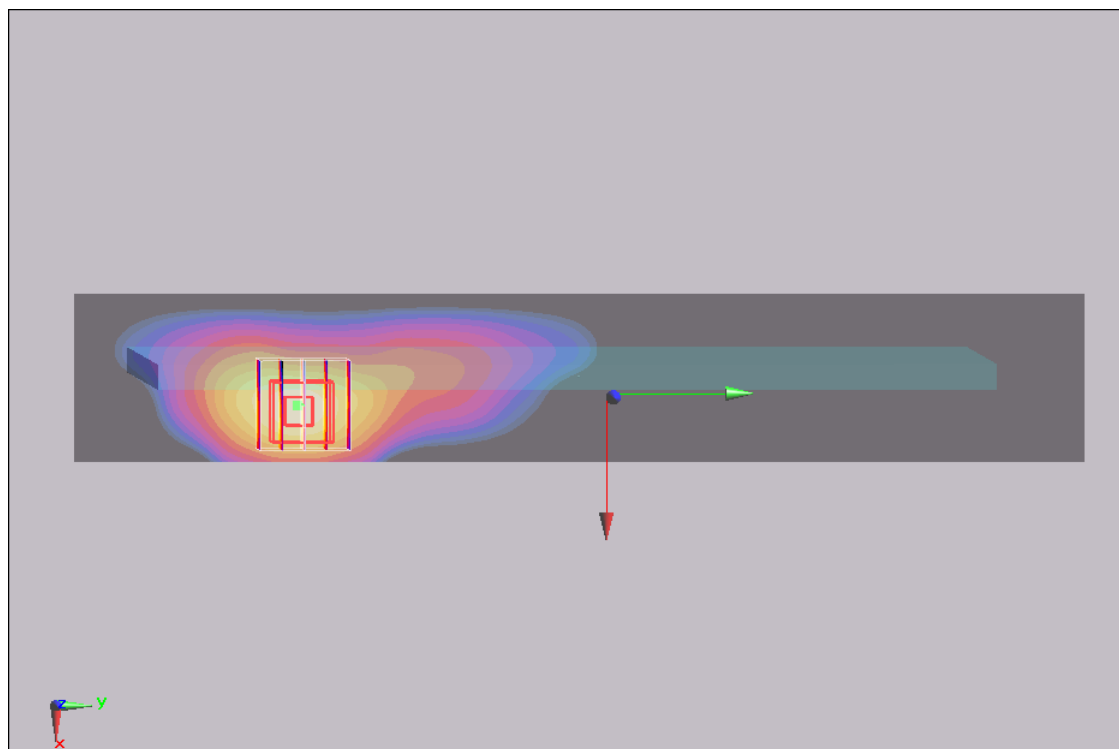
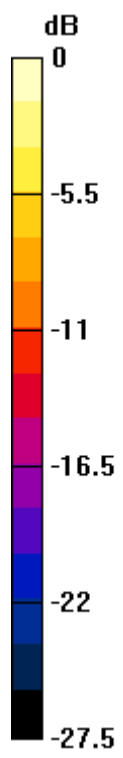

0 dB = 0.328mW/g

#02 WLAN2.4G_802.11b_Edge1_0cm_Ch6_Yageo_Ant A_2D

DUT: 280820

Communication System: 802.11b ; Frequency: 2437 MHz;Duty Cycle: 1:1

Medium: MSL_2450_120904 Medium parameters used: $f = 2437$ MHz; $\sigma = 1.95$ mho/m; $\epsilon_r = 52.4$;

$\rho = 1000$ kg/m³

Ambient Temperature : 22.5 °C ; Liquid Temperature : 21.5 °C

DASY5 Configuration:

- Probe: EX3DV4 - SN3819; ConvF(7.4, 7.4, 7.4); Calibrated: 2011/11/16
- Sensor-Surface: 4mm (Mechanical Surface Detection)
- Electronics: DAE4 Sn1279; Calibrated: 2012/5/3
- Phantom: ELI 4.0; Type: QDOVA001BA; Serial: 1029
- Software: DASY5 Version; SEMCAD X Version 13.4 Build 45

Ch6/Area Scan (31x181x1): Measurement grid: dx=20mm, dy=20mm

Maximum value of SAR (interpolated) = 0.347 mW/g

Ch6/Zoom Scan (5x5x7)/Cube 0: Measurement grid: dx=8mm, dy=8mm, dz=5mm

Reference Value = 1.99 V/m; Power Drift = 0.102 dB

Peak SAR (extrapolated) = 0.684 W/kg

SAR(1 g) = 0.289 mW/g; SAR(10 g) = 0.117 mW/g

Maximum value of SAR (measured) = 0.328 mW/g

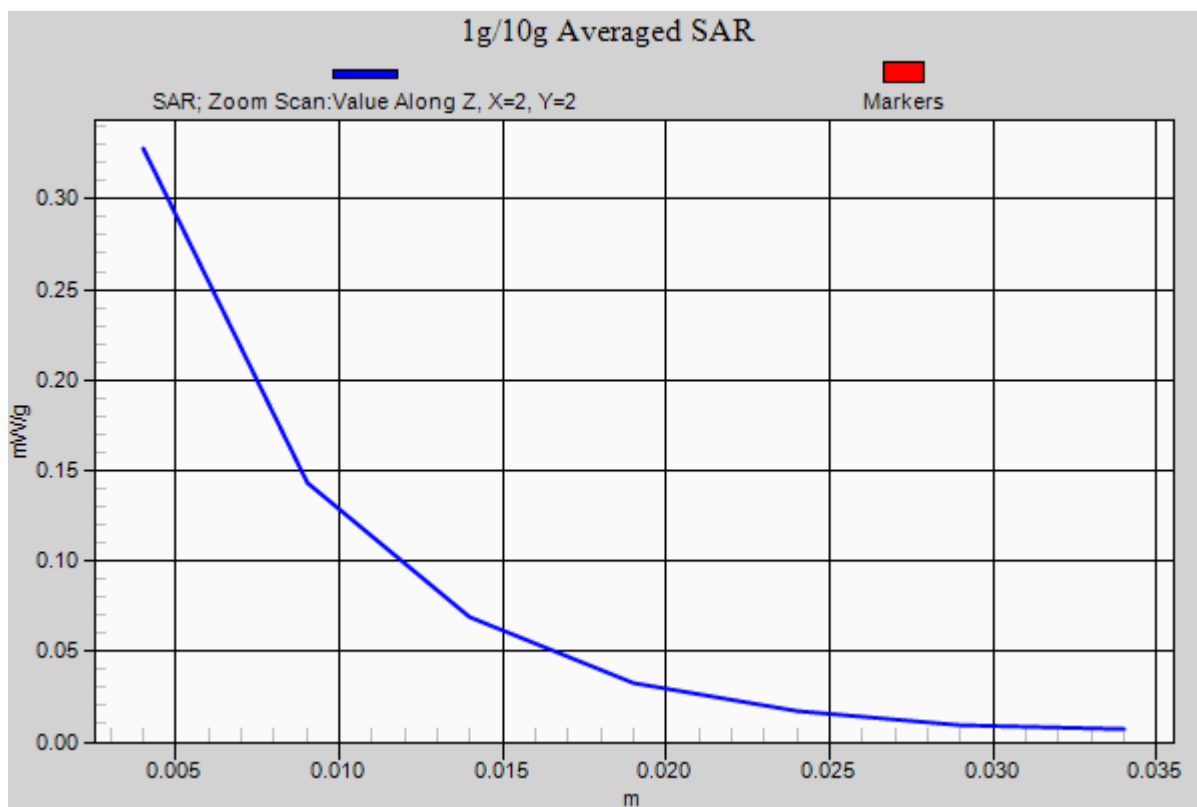

#03 WLAN2.4G_802.11b_Edge4_0cm_Ch6_Yageo_Ant A

DUT: 280820

Communication System: 802.11b ; Frequency: 2437 MHz;Duty Cycle: 1:1

Medium: MSL_2450_120904 Medium parameters used: $f = 2437$ MHz; $\sigma = 1.95$ mho/m; $\epsilon_r = 52.4$;

$\rho = 1000$ kg/m³

Ambient Temperature : 22.5 °C ; Liquid Temperature : 21.5 °C

DASY5 Configuration:

- Probe: EX3DV4 - SN3819; ConvF(7.4, 7.4, 7.4); Calibrated: 2011/11/16
- Sensor-Surface: 4mm (Mechanical Surface Detection)
- Electronics: DAE4 Sn1279; Calibrated: 2012/5/3
- Phantom: ELI 4.0; Type: QDOVA001BA; Serial: 1029
- Software: DASY5 Version; SEMCAD X Version 13.4 Build 45

Ch6/Area Scan (31x121x1): Measurement grid: dx=20mm, dy=20mm

Maximum value of SAR (interpolated) = 0.031 mW/g

Ch6/Zoom Scan (5x5x7)/Cube 0: Measurement grid: dx=8mm, dy=8mm, dz=5mm

Reference Value = 0.871 V/m; Power Drift = 0.075 dB

Peak SAR (extrapolated) = 0.075 W/kg

SAR(1 g) = 0.034 mW/g; SAR(10 g) = 0.015 mW/g

Maximum value of SAR (measured) = 0.038 mW/g

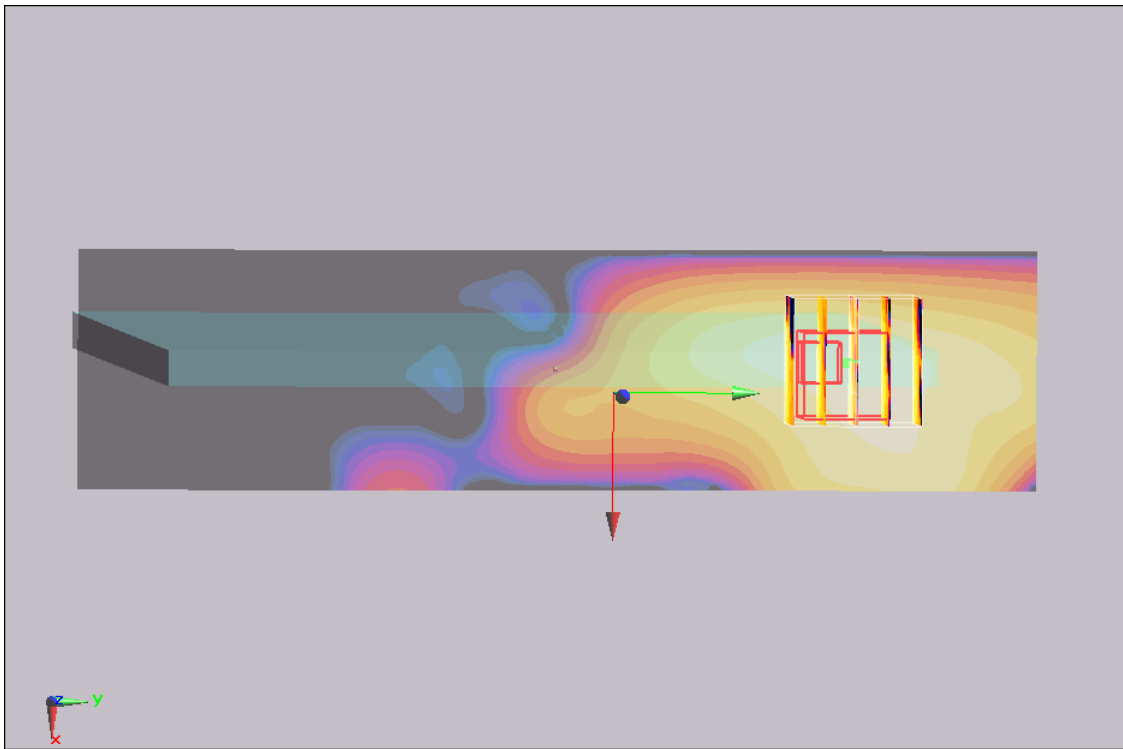
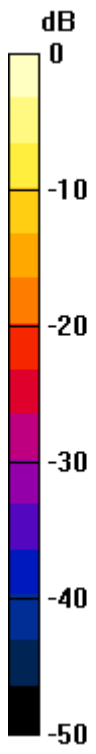

0 dB = 0.038mW/g

#04 WLAN2.4G_802.11b_Bottom_0cm_Ch6_Yageo_Ant A

DUT: 280820

Communication System: 802.11b ; Frequency: 2437 MHz; Duty Cycle: 1:1

Medium: MSL_2450_120904 Medium parameters used: $f = 2437$ MHz; $\sigma = 1.95$ mho/m; $\epsilon_r = 52.4$;

$\rho = 1000$ kg/m³

Ambient Temperature : 22.5 °C ; Liquid Temperature : 21.5 °C

DASY5 Configuration:

- Probe: EX3DV4 - SN3819; ConvF(7.4, 7.4, 7.4); Calibrated: 2011/11/16
- Sensor-Surface: 4mm (Mechanical Surface Detection)
- Electronics: DAE4 Sn1279; Calibrated: 2012/5/3
- Phantom: ELI 4.0; Type: QDOVA001BA; Serial: 1029
- Software: DASY5 Version; SEMCAD X Version 13.4 Build 45

Ch6/Area Scan (121x181x1): Measurement grid: dx=20mm, dy=20mm

Maximum value of SAR (interpolated) = 0.030 mW/g

Ch6/Zoom Scan (5x5x7)/Cube 0: Measurement grid: dx=8mm, dy=8mm, dz=5mm

Reference Value = 0 V/m; Power Drift = 0.056 dB

Peak SAR (extrapolated) = 0.103W/kg

SAR(1 g) = 0.093mW/g; SAR(10 g) = 0.086mW/g

Maximum value of SAR (measured) = 0.103mW/g

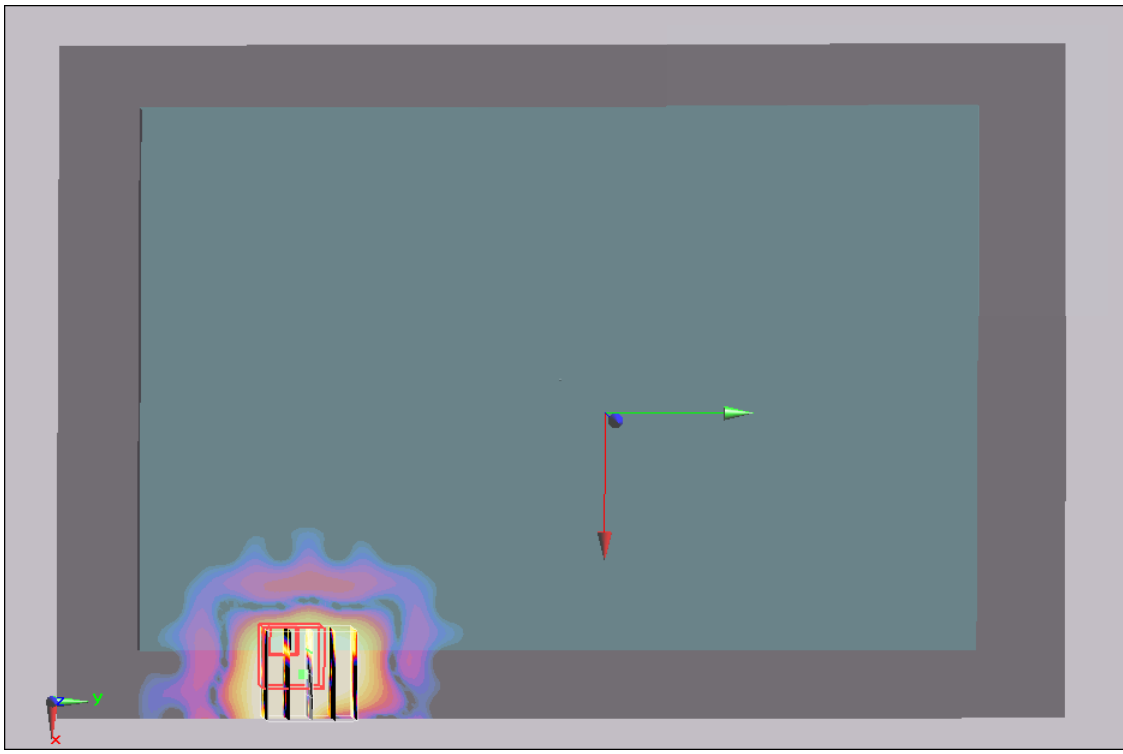
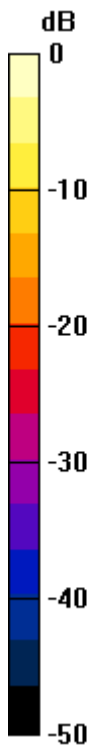

0 dB = 0.103mW/g

#05 WLAN2.4G_802.11b_Back of Display Screen_2.5cm_Ch6_Yageo_Ant A

DUT: 280820

Communication System: 802.11b ; Frequency: 2437 MHz;Duty Cycle: 1:1

Medium: MSL_2450_120904 Medium parameters used: $f = 2437$ MHz; $\sigma = 1.95$ mho/m; $\epsilon_r = 52.4$;

$\rho = 1000$ kg/m³

Ambient Temperature : 22.5 °C ; Liquid Temperature : 21.5 °C

DASY5 Configuration:

- Probe: EX3DV4 - SN3819; ConvF(7.4, 7.4, 7.4); Calibrated: 2011/11/16
- Sensor-Surface: 4mm (Mechanical Surface Detection)
- Electronics: DAE4 Sn1279; Calibrated: 2012/5/3
- Phantom: ELI 4.0; Type: QDOVA001BA; Serial: 1029
- Software: DASY5 Version; SEMCAD X Version 13.4 Build 45

Ch6/Area Scan (121x181x1): Measurement grid: dx=20mm, dy=20mm

Maximum value of SAR (interpolated) = 0.030 mW/g

Ch6/Zoom Scan (5x5x7)/Cube 0: Measurement grid: dx=8mm, dy=8mm, dz=5mm

Reference Value = 0 V/m; Power Drift = 0.069 dB

Peak SAR (extrapolated) = 0.000362 W/kg

SAR(1 g) = 0.0000227 mW/g; SAR(10 g) = 0.00000304 mW/g

Maximum value of SAR (measured) = 0.00215 mW/g

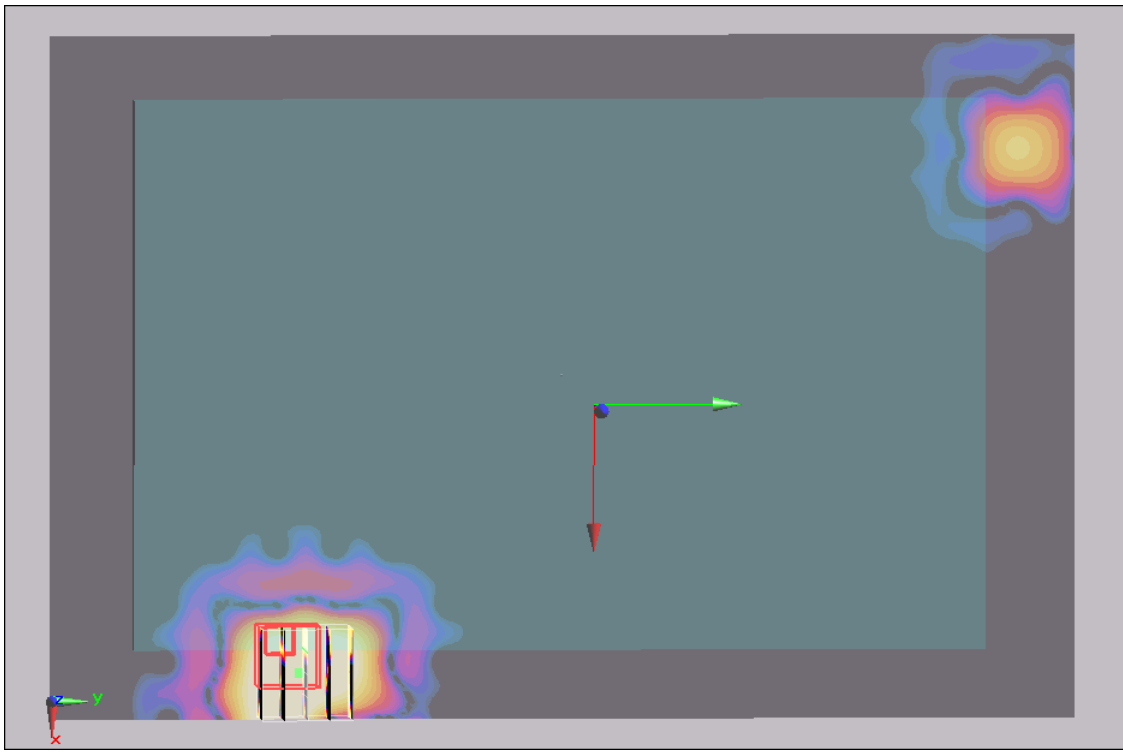
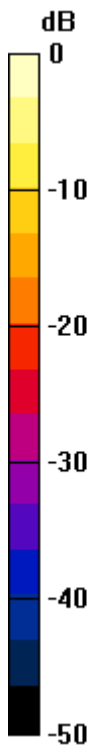

0 dB = 0.00215mW/g

#06 WLAN5G_802.11a_Bottom Face_0cm_Ch44_WNC_Ant B**DUT: 280820**

Communication System: 802.11a; Frequency: 5220 MHz; Duty Cycle: 1:1

Medium: MSL_5G_120906 Medium parameters used: $f = 5220$ MHz; $\sigma = 5.31$ mho/m; $\epsilon_r = 48.5$; $\rho = 1000$ kg/m³

Ambient Temperature : 22.3 °C ; Liquid Temperature : 21.3 °C

DASY4 Configuration:

- Probe: EX3DV4 - SN3819; ConvF(4.48, 4.48, 4.48); Calibrated: 2011/11/16
- Sensor-Surface: 2mm (Mechanical Surface Detection)
- Electronics: DAE4 Sn1279; Calibrated: 2012/5/3
- Phantom: ELI 4.0; Type: QDOVA001BA; Serial: 1029
- Software: DASY5 Version; SEMCAD X Version 13.4 Build 45

Ch44/Area Scan (241x361x1): Measurement grid: dx=10mm, dy=10mm

Maximum value of SAR (interpolated) = 0.045 mW/g

Ch44/Zoom Scan (8x8x10)/Cube 0: Measurement grid: dx=4mm, dy=4mm, dz=2.5mm

Reference Value = 0.000 V/m; Power Drift = 0.000 dB

Peak SAR (extrapolated) = 0.228 W/kg

SAR(1 g) = 0.023 mW/g; SAR(10 g) = 0.00866 mW/g

Maximum value of SAR (measured) = 0.039 mW/g

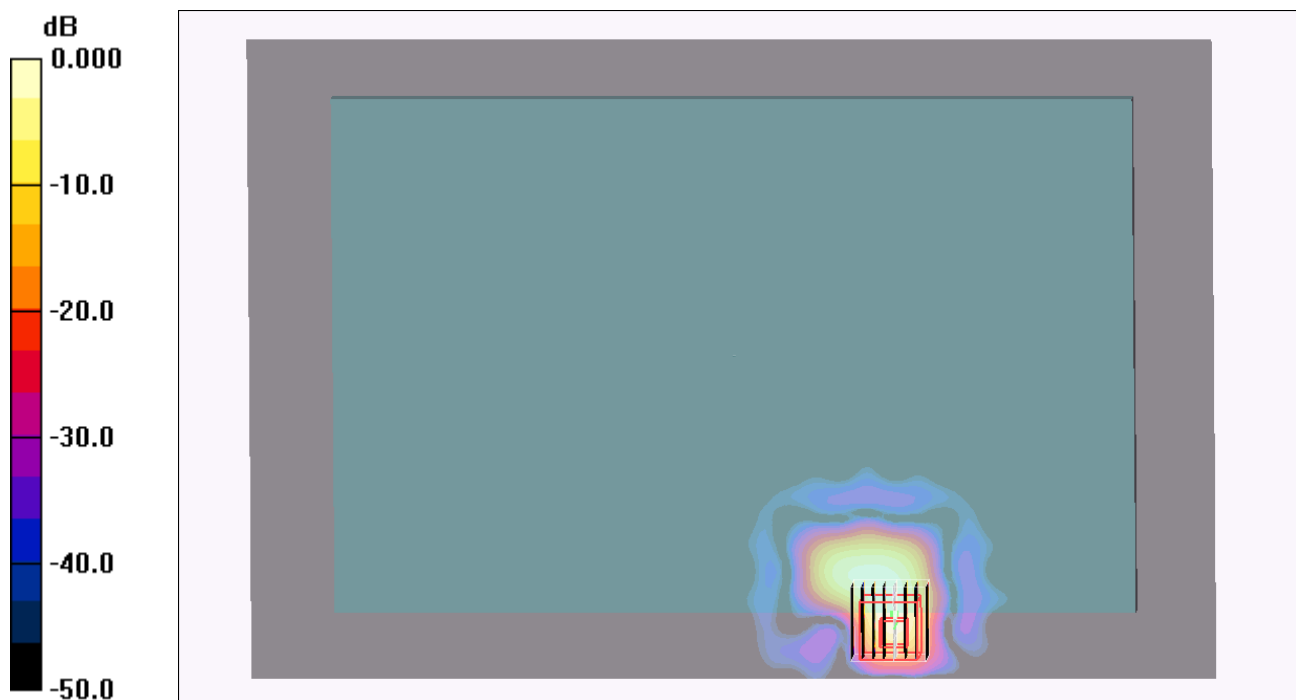

0 dB = 0.039mW/g

#07 WLAN5G_802.11a_Edge 1_0cm_Ch44_WNC_Ant B

DUT: 280820

Communication System: 802.11a; Frequency: 5220 MHz; Duty Cycle: 1:1

Medium: MSL_5G_120906 Medium parameters used: $f = 5220$ MHz; $\sigma = 5.31$ mho/m; $\epsilon_r = 48.5$; $\rho = 1000$ kg/m³

Ambient Temperature : 22.3 °C ; Liquid Temperature : 21.3 °C

DASY4 Configuration:

- Probe: EX3DV4 - SN3819; ConvF(4.48, 4.48, 4.48); Calibrated: 2011/11/16
- Sensor-Surface: 2mm (Mechanical Surface Detection)
- Electronics: DAE4 Sn1279; Calibrated: 2012/5/3
- Phantom: ELI 4.0; Type: QDOVA001BA; Serial: 1029
- Software: DASY5 Version; SEMCAD X Version 13.4 Build 45

Ch44/Area Scan (61x361x1): Measurement grid: dx=10mm, dy=10mm

Maximum value of SAR (interpolated) = 1.12 mW/g

Ch44/Zoom Scan (8x8x10)/Cube 0: Measurement grid: dx=4mm, dy=4mm, dz=2.5mm

Reference Value = 0.000 V/m; Power Drift = 0.000 dB

Peak SAR (extrapolated) = 1.16 W/kg

SAR(1 g) = 0.320 mW/g; SAR(10 g) = 0.105 mW/g

Maximum value of SAR (measured) = 0.662 mW/g

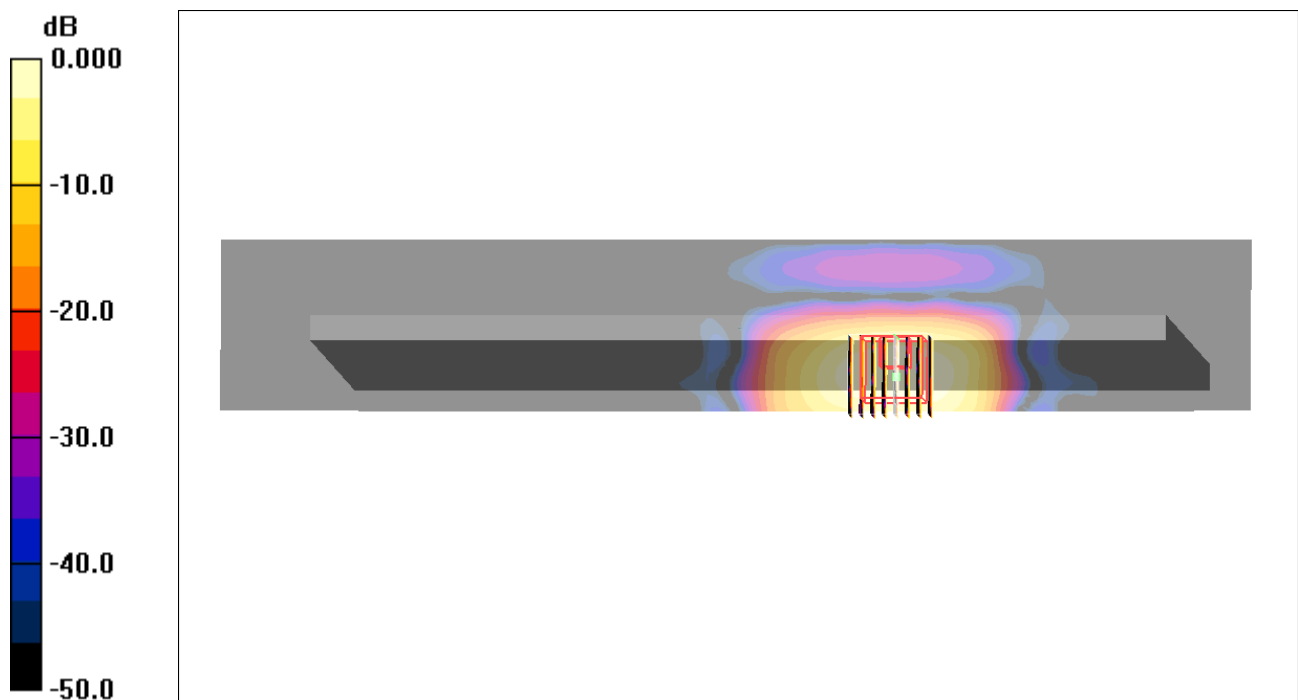

0 dB = 0.662mW/g

#07 WLAN5G_802.11a_Edge 1_0cm_Ch44_WNC_Ant B_2D

DUT: 280820

Communication System: 802.11a; Frequency: 5220 MHz; Duty Cycle: 1:1

Medium: MSL_5G_120906 Medium parameters used: $f = 5220$ MHz; $\sigma = 5.31$ mho/m; $\epsilon_r = 48.5$; $\rho = 1000$ kg/m³

Ambient Temperature : 22.3 °C ; Liquid Temperature : 21.3 °C

DASY4 Configuration:

- Probe: EX3DV4 - SN3819; ConvF(4.48, 4.48, 4.48); Calibrated: 2011/11/16
- Sensor-Surface: 2mm (Mechanical Surface Detection)
- Electronics: DAE4 Sn1279; Calibrated: 2012/5/3
- Phantom: ELI 4.0; Type: QDOVA001BA; Serial: 1029
- Software: DASY5 Version; SEMCAD X Version 13.4 Build 45

Ch44/Area Scan (61x361x1): Measurement grid: dx=10mm, dy=10mm

Maximum value of SAR (interpolated) = 1.12 mW/g

Ch44/Zoom Scan (8x8x10)/Cube 0: Measurement grid: dx=4mm, dy=4mm, dz=2.5mm

Reference Value = 0.000 V/m; Power Drift = 0.000 dB

Peak SAR (extrapolated) = 1.16 W/kg

SAR(1 g) = 0.320 mW/g; SAR(10 g) = 0.105 mW/g

Maximum value of SAR (measured) = 0.662 mW/g

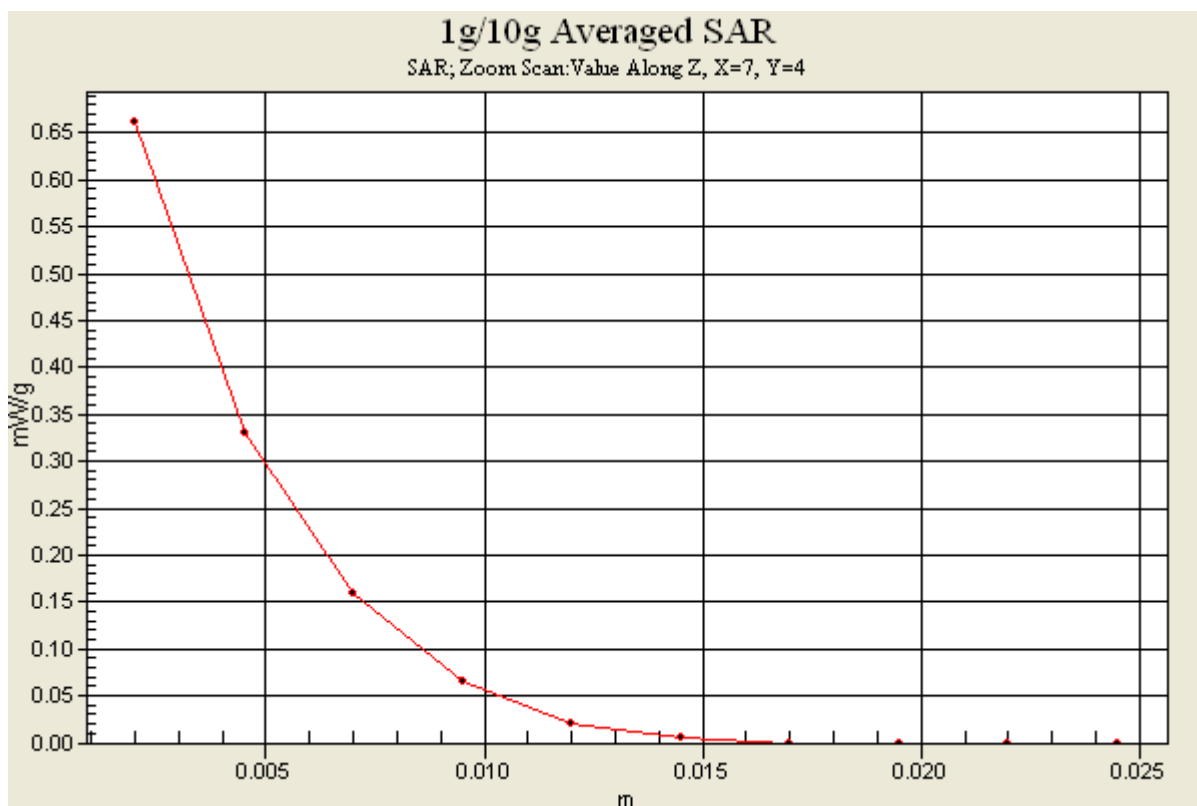

#10 WLAN5G_802.11a_Bottom_0cm_Ch44_WNC_Ant B

DUT: 280820

Communication System: 802.11a; Frequency: 5220 MHz; Duty Cycle: 1:1

Medium: MSL_5G_120906 Medium parameters used: $f = 5220$ MHz; $\sigma = 5.31$ mho/m; $\epsilon_r = 48.5$; $\rho = 1000$ kg/m³

Ambient Temperature : 22.3 °C ; Liquid Temperature : 21.3 °C

DASY4 Configuration:

- Probe: EX3DV4 - SN3819; ConvF(4.48, 4.48, 4.48); Calibrated: 2011/11/16
- Sensor-Surface: 2mm (Mechanical Surface Detection)
- Electronics: DAE4 Sn1279; Calibrated: 2012/5/3
- Phantom: ELI 4.0; Type: QDOVA001BA; Serial: 1029
- Software: DASY5 Version; SEMCAD X Version 13.4 Build 45

Ch44/Area Scan (241x341x1): Measurement grid: dx=10mm, dy=10mm

Maximum value of SAR (interpolated) = 0.031 mW/g

Ch44/Zoom Scan (8x8x10)/Cube 0: Measurement grid: dx=4mm, dy=4mm, dz=2.5mm

Reference Value = 0.000 V/m; Power Drift = 0.000 dB

Peak SAR (extrapolated) = 0.254 W/kg

SAR(1 g) = 0.024 mW/g; SAR(10 g) = 0.00887 mW/g

Maximum value of SAR (measured) = 0.044 mW/g

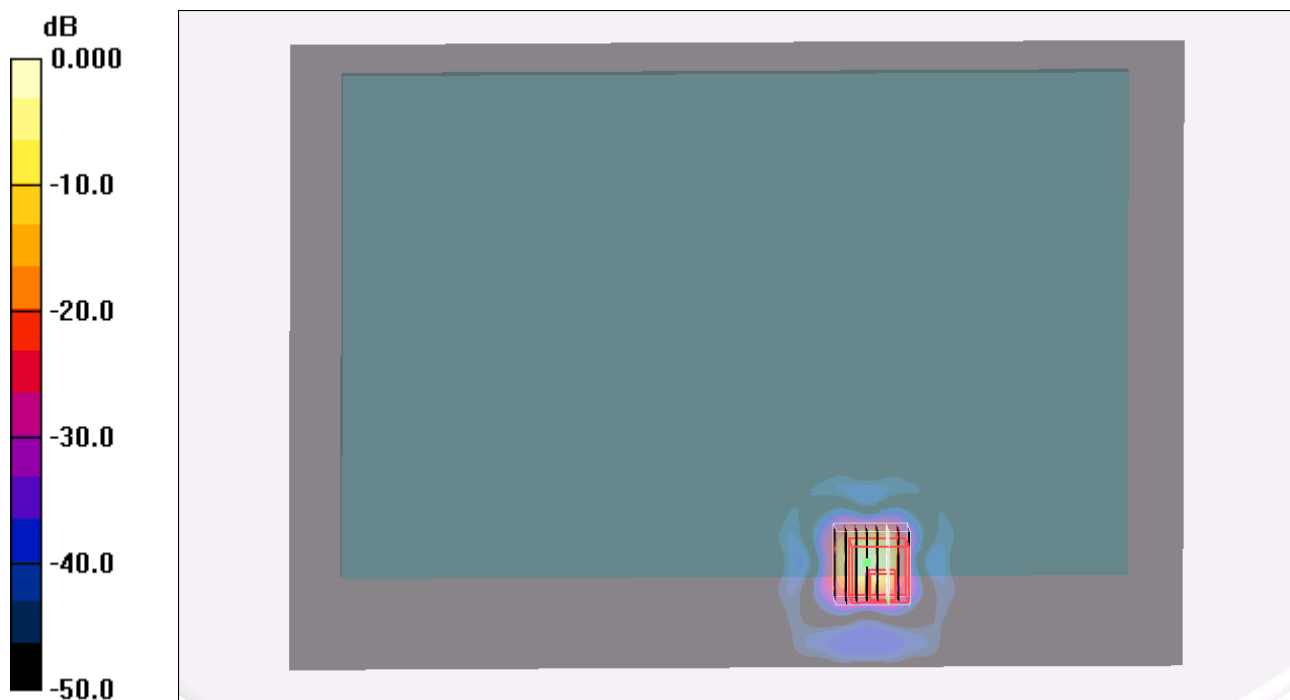

0 dB = 0.044mW/g

#11 WLAN5G_802.11a_Back of Display Screen_2.5cm_Ch44_WNC_Ant B**DUT: 280820**

Communication System: 802.11a; Frequency: 5220 MHz; Duty Cycle: 1:1

Medium: MSL_5G_120906 Medium parameters used: $f = 5220$ MHz; $\sigma = 5.31$ mho/m; $\epsilon_r = 48.5$; $\rho = 1000$ kg/m³

Ambient Temperature : 22.3 °C ; Liquid Temperature : 21.3 °C

DASY4 Configuration:

- Probe: EX3DV4 - SN3819; ConvF(4.48, 4.48, 4.48); Calibrated: 2011/11/16
- Sensor-Surface: 2mm (Mechanical Surface Detection)
- Electronics: DAE4 Sn1279; Calibrated: 2012/5/3
- Phantom: ELI 4.0; Type: QDOVA001BA; Serial: 1029
- Software: DASY5 Version; SEMCAD X Version 13.4 Build 45

Ch44/Area Scan (241x361x1): Measurement grid: dx=10mm, dy=10mm

Maximum value of SAR (interpolated) = 0.045 mW/g

Ch44/Zoom Scan (8x8x10)/Cube 0: Measurement grid: dx=4mm, dy=4mm, dz=2.5mm

Reference Value = 0.000 V/m; Power Drift = 0.000 dB

Peak SAR (extrapolated) = 0.133 W/kg

SAR(1 g) = 0.010 mW/g; SAR(10 g) = 0.00144 mW/g

Maximum value of SAR (measured) = 0.023 mW/g

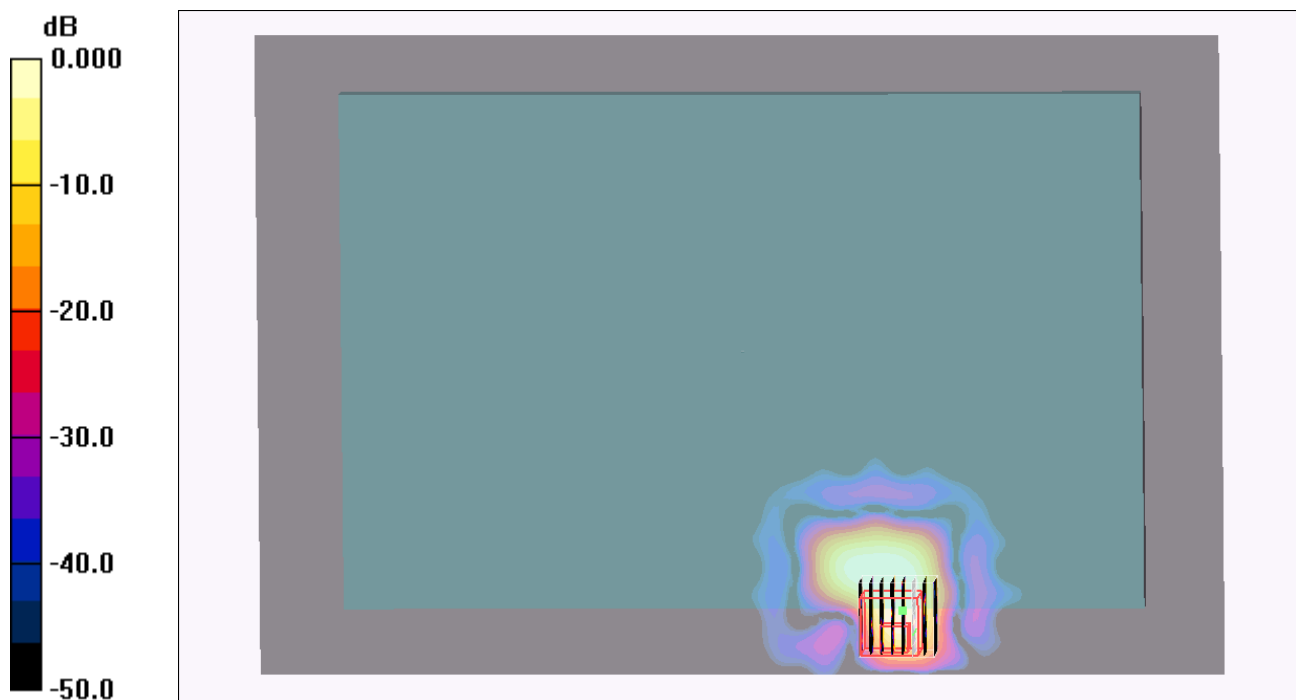

0 dB = 0.023mW/g

#09 WLAN5G_802.11a_Bottom Face_0cm_Ch52_WNC_Ant B

DUT: 280820

Communication System: 802.11a; Frequency: 5260 MHz; Duty Cycle: 1:1

Medium: MSL_5G_120906 Medium parameters used: $f = 5260$ MHz; $\sigma = 5.37$ mho/m; $\epsilon_r = 48.4$; $\rho = 1000$ kg/m³

Ambient Temperature : 22.3 °C ; Liquid Temperature : 21.3 °C

DASY4 Configuration:

- Probe: EX3DV4 - SN3819; ConvF(4.16, 4.16, 4.16); Calibrated: 2011/11/16
- Sensor-Surface: 2mm (Mechanical Surface Detection)
- Electronics: DAE4 Sn1279; Calibrated: 2012/5/3
- Phantom: ELI 4.0; Type: QDOVA001BA; Serial: 1029
- Software: DASY5 Version; SEMCAD X Version 13.4 Build 45

Ch52/Area Scan (241x341x1): Measurement grid: dx=10mm, dy=10mm

Maximum value of SAR (interpolated) = 0.096 mW/g

Ch52/Zoom Scan (8x8x10)/Cube 0: Measurement grid: dx=4mm, dy=4mm, dz=2.5mm

Reference Value = 0.000 V/m; Power Drift = 0.000 dB

Peak SAR (extrapolated) = 0.318 W/kg

SAR(1 g) = 0.032 mW/g; SAR(10 g) = 0.013 mW/g

Maximum value of SAR (measured) = 0.104 mW/g

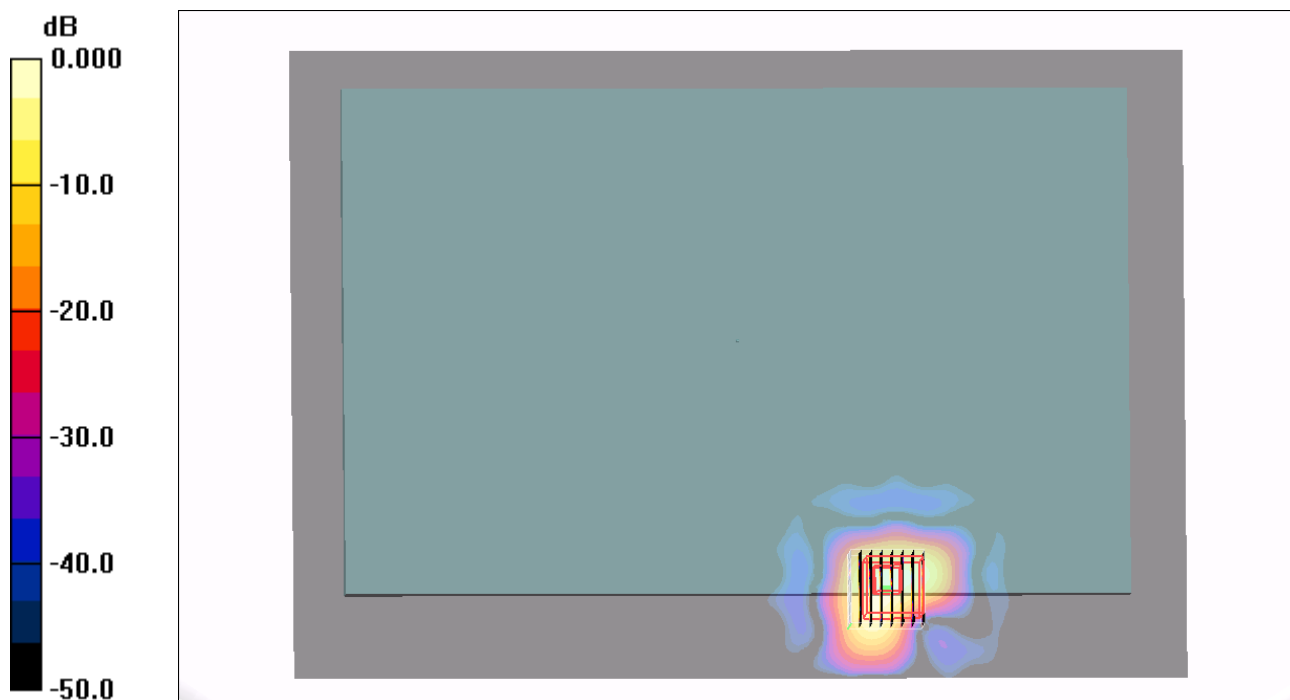

0 dB = 0.104mW/g

#08 WLAN5G_802.11a_Edge 1_0cm_Ch52_WNC_Ant B

DUT: 280820

Communication System: 802.11a; Frequency: 5260 MHz; Duty Cycle: 1:1

Medium: MSL_5G_120906 Medium parameters used: $f = 5260$ MHz; $\sigma = 5.37$ mho/m; $\epsilon_r = 48.4$; $\rho = 1000$ kg/m³

Ambient Temperature : 22.3 °C ; Liquid Temperature : 21.3 °C

DASY4 Configuration:

- Probe: EX3DV4 - SN3819; ConvF(4.16, 4.16, 4.16); Calibrated: 2011/11/16
- Sensor-Surface: 2mm (Mechanical Surface Detection)
- Electronics: DAE4 Sn1279; Calibrated: 2012/5/3
- Phantom: ELI 4.0; Type: QDOVA001BA; Serial: 1029
- Software: DASY5 Version; SEMCAD X Version 13.4 Build 45

Ch52/Area Scan (61x361x1): Measurement grid: dx=10mm, dy=10mm

Maximum value of SAR (interpolated) = 1.03 mW/g

Ch52/Zoom Scan (8x8x10)/Cube 0: Measurement grid: dx=4mm, dy=4mm, dz=2.5mm

Reference Value = 0.000 V/m; Power Drift = 0.000 dB

Peak SAR (extrapolated) = 1.14 W/kg

SAR(1 g) = 0.317 mW/g; SAR(10 g) = 0.104 mW/g

Maximum value of SAR (measured) = 0.675 mW/g



0 dB = 0.675mW/g

#08 WLAN5G_802.11a_Edge 1_0cm_Ch52_WNC_Ant B_2D**DUT: 280820**

Communication System: 802.11a; Frequency: 5260 MHz; Duty Cycle: 1:1

Medium: MSL_5G_120906 Medium parameters used: $f = 5260$ MHz; $\sigma = 5.37$ mho/m; $\epsilon_r = 48.4$; $\rho = 1000$ kg/m³

Ambient Temperature : 22.3 °C; Liquid Temperature : 21.3 °C

DASY4 Configuration:

- Probe: EX3DV4 - SN3819; ConvF(4.16, 4.16, 4.16); Calibrated: 2011/11/16
- Sensor-Surface: 2mm (Mechanical Surface Detection)
- Electronics: DAE4 Sn1279; Calibrated: 2012/5/3
- Phantom: ELI 4.0; Type: QDOVA001BA; Serial: 1029
- Software: DASY5 Version; SEMCAD X Version 13.4 Build 45

Ch52/Area Scan (61x361x1): Measurement grid: dx=10mm, dy=10mm

Maximum value of SAR (interpolated) = 1.03 mW/g

Ch52/Zoom Scan (8x8x10)/Cube 0: Measurement grid: dx=4mm, dy=4mm, dz=2.5mm

Reference Value = 0.000 V/m; Power Drift = 0.000 dB

Peak SAR (extrapolated) = 1.14 W/kg

SAR(1 g) = 0.317 mW/g; SAR(10 g) = 0.104 mW/g

Maximum value of SAR (measured) = 0.675 mW/g

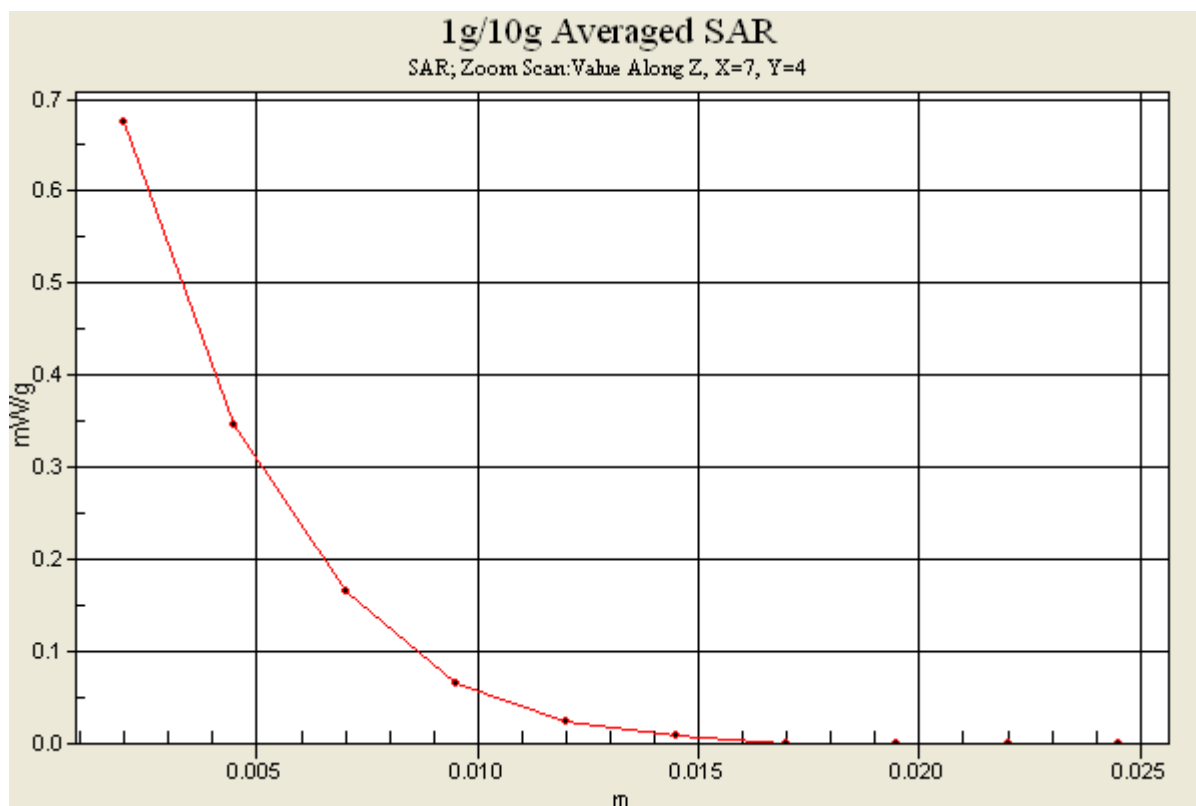

#12 WLAN5G_802.11a_Bottom_0cm_Ch52_WNC_Ant B

DUT: 280820

Communication System: 802.11a; Frequency: 5260 MHz; Duty Cycle: 1:1

Medium: MSL_5G_120906 Medium parameters used: $f = 5260$ MHz; $\sigma = 5.37$ mho/m; $\epsilon_r = 48.4$; $\rho = 1000$ kg/m³

Ambient Temperature : 22.3 °C ; Liquid Temperature : 21.3 °C

DASY4 Configuration:

- Probe: EX3DV4 - SN3819; ConvF(4.16, 4.16, 4.16); Calibrated: 2011/11/16
- Sensor-Surface: 2mm (Mechanical Surface Detection)
- Electronics: DAE4 Sn1279; Calibrated: 2012/5/3
- Phantom: ELI 4.0; Type: QDOVA001BA; Serial: 1029
- Software: DASY5 Version; SEMCAD X Version 13.4 Build 45

Ch52/Area Scan (241x341x1): Measurement grid: dx=10mm, dy=10mm

Maximum value of SAR (interpolated) = 0.038 mW/g

Ch52/Zoom Scan (8x8x10)/Cube 0: Measurement grid: dx=4mm, dy=4mm, dz=2.5mm

Reference Value = 0.000 V/m; Power Drift = 0.000 dB

Peak SAR (extrapolated) = 0.253 W/kg

SAR(1 g) = 0.025 mW/g; SAR(10 g) = 0.00777 mW/g

Maximum value of SAR (measured) = 0.070 mW/g

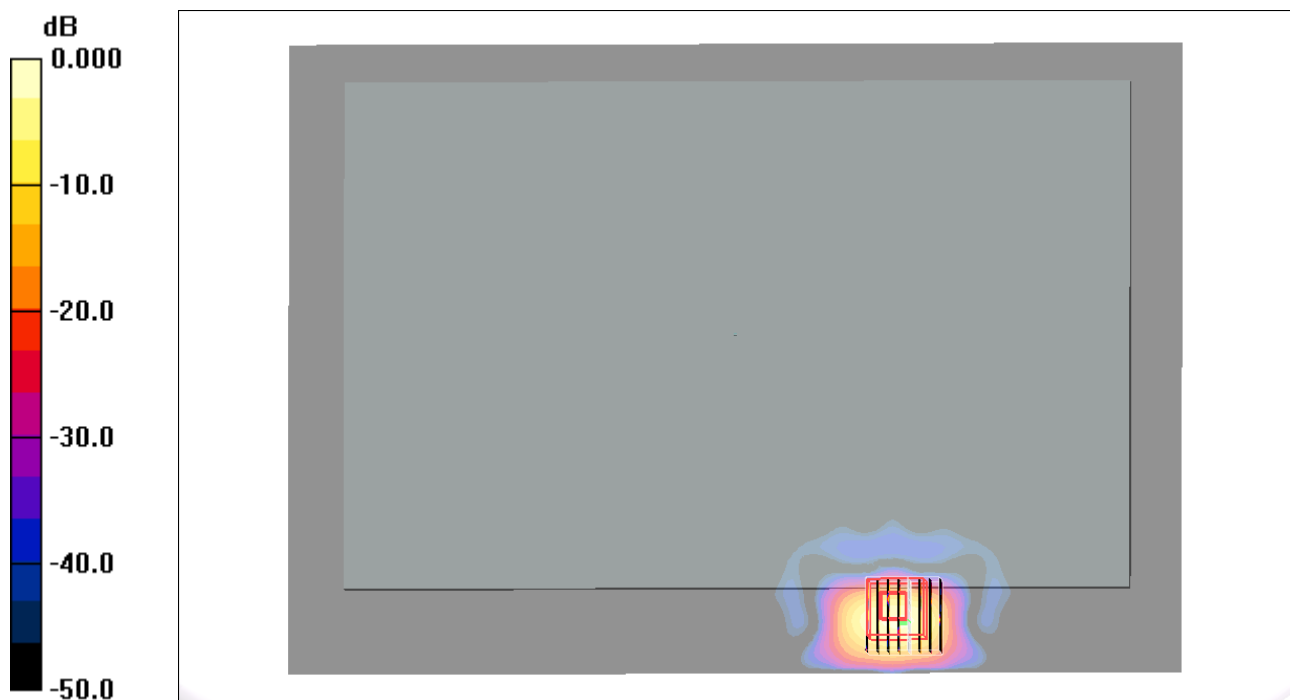

0 dB = 0.070mW/g

#13 WLAN5G_802.11a_Back of Display Screen_2.5cm_Ch52_WNC_Ant B

DUT: 280820

Communication System: 802.11a; Frequency: 5260 MHz; Duty Cycle: 1:1

Medium: MSL_5G_120906 Medium parameters used: $f = 5260$ MHz; $\sigma = 5.37$ mho/m; $\epsilon_r = 48.4$; $\rho = 1000$ kg/m³

Ambient Temperature : 22.3 °C ; Liquid Temperature : 21.3 °C

DASY4 Configuration:

- Probe: EX3DV4 - SN3819; ConvF(4.16, 4.16, 4.16); Calibrated: 2011/11/16
- Sensor-Surface: 2mm (Mechanical Surface Detection)
- Electronics: DAE4 Sn1279; Calibrated: 2012/5/3
- Phantom: ELI 4.0; Type: QDOVA001BA; Serial: 1029
- Software: DASY5 Version; SEMCAD X Version 13.4 Build 45

Ch52/Area Scan (241x341x1): Measurement grid: dx=10mm, dy=10mm

Maximum value of SAR (interpolated) = 0.096 mW/g

Ch52/Zoom Scan (8x8x10)/Cube 0: Measurement grid: dx=4mm, dy=4mm, dz=2.5mm

Reference Value = 0.000 V/m; Power Drift = 0.000 dB

Peak SAR (extrapolated) = 0.214 W/kg

SAR(1 g) = 0.017 mW/g; SAR(10 g) = 0.00265 mW/g

Maximum value of SAR (measured) = 0.036 mW/g

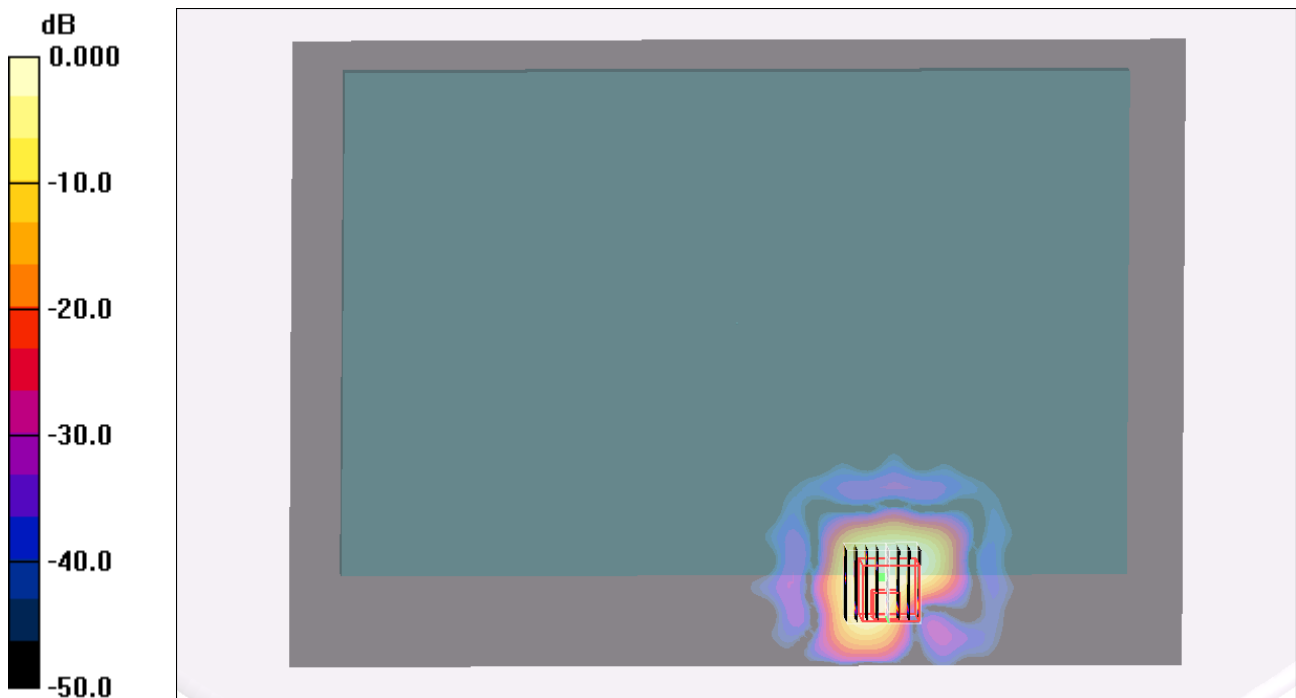

0 dB = 0.036mW/g

#14 WLAN5G_802.11a_Bottom Face_0cm_Ch140_WNC_Ant B

DUT: 280820

Communication System: 802.11a; Frequency: 5700 MHz; Duty Cycle: 1:1

Medium: MSL_5G_120906 Medium parameters used: $f = 5700$ MHz; $\sigma = 6$ mho/m; $\epsilon_r = 47.4$; $\rho = 1000$ kg/m³

Ambient Temperature : 22.5 °C; Liquid Temperature : 21.5 °C

DASY5 Configuration:

- Probe: EX3DV4 - SN3819; ConvF(4.02, 4.02, 4.02); Calibrated: 2011/11/16
- Sensor-Surface: 2mm (Mechanical Surface Detection)
- Electronics: DAE4 Sn1279; Calibrated: 2012/5/3
- Phantom: ELI 4.0; Type: QDOVA001BA; Serial: 1029
- Software: DASY5 Version; SEMCAD X Version 13.4 Build 45

Ch140/Area Scan (241x341x1): Measurement grid: dx=10mm, dy=10mm

Maximum value of SAR (interpolated) = 0.105 mW/g

Ch140/Zoom Scan (8x8x10)/Cube 0: Measurement grid: dx=4mm, dy=4mm, dz=2.5mm

Reference Value = 0 V/m; Power Drift = 0 dB

Peak SAR (extrapolated) = 0.219 W/kg

SAR(1 g) = 0.015 mW/g; SAR(10 g) = 0.00235 mW/g

Maximum value of SAR (measured) = 0.041 mW/g

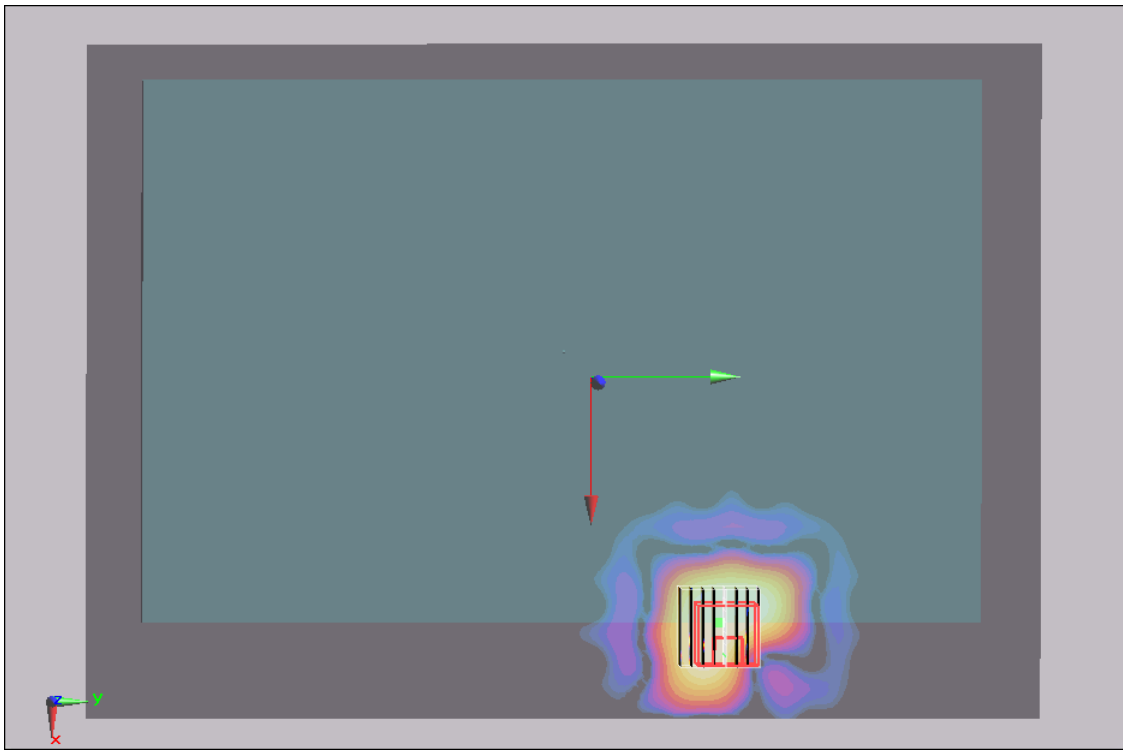
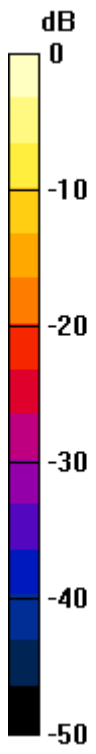

0 dB = 0.041mW/g

#15 WLAN5G_802.11a_Edge1_0cm_Ch140_WNC_Ant B

DUT: 280820

Communication System: 802.11a; Frequency: 5700 MHz; Duty Cycle: 1:1

Medium: MSL_5G_120908 Medium parameters used: $f = 5700$ MHz; $\sigma = 5.81$ mho/m; $\epsilon_r = 46.685$; $\rho =$

1000 kg/m³

Ambient Temperature : 22.6 °C ; Liquid Temperature : 21.6 °C

DASY5 Configuration:

- Probe: EX3DV4 - SN3792; ConvF(3.72, 3.72, 3.72); Calibrated: 2012/6/21;
- Sensor-Surface: 2mm (Mechanical Surface Detection)
- Electronics: DAE3 Sn495; Calibrated: 2012/4/23
- Phantom: ELI v5.0; Type: QDOVA002AA; Serial: TP1127
- Measurement SW: DASY52, Version 52.8 (2); SEMCAD X Version 14.6.6 (6824)

Ch140/Area Scan (61x321x1): Measurement grid: dx=10 mm, dy=10 mm

Maximum value of SAR (interpolated) = 1.26 W/kg

Ch140/Zoom Scan (8x8x10)/Cube 0: Measurement grid: dx=4mm, dy=4mm, dz=2.5mm

Reference Value = 0 V/m; Power Drift = 0.07 dB

Peak SAR (extrapolated) = 1.424 mW/g

SAR(1 g) = 0.420 mW/g; SAR(10 g) = 0.143 mW/g

Maximum value of SAR (measured) = 0.824 W/kg

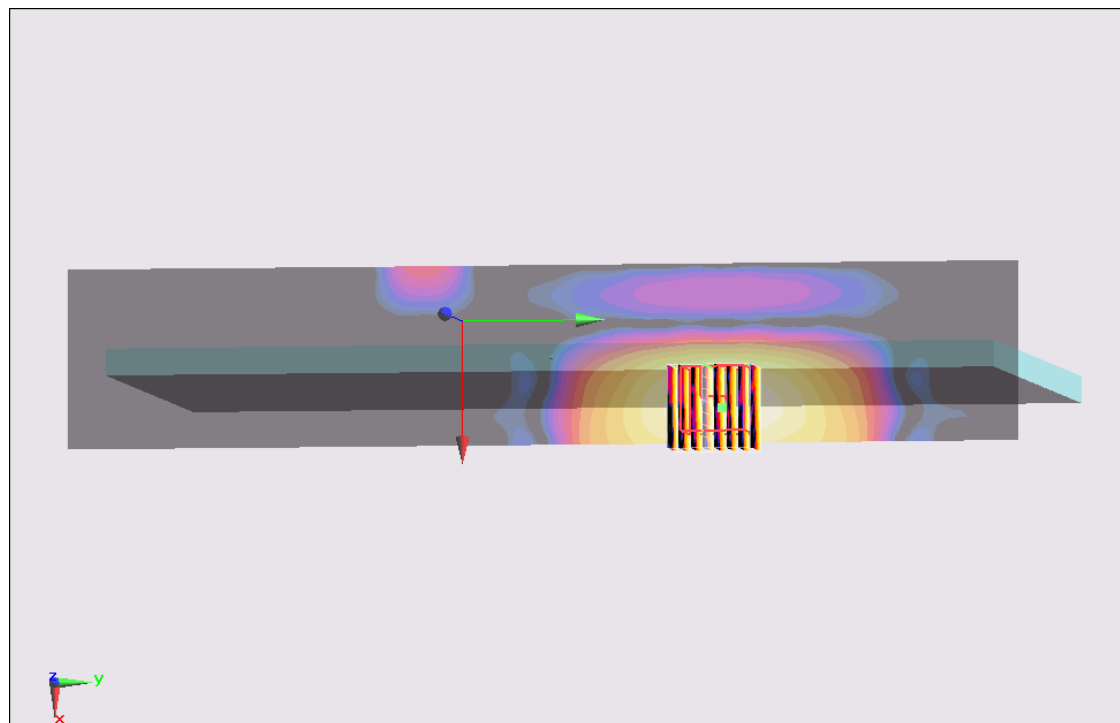
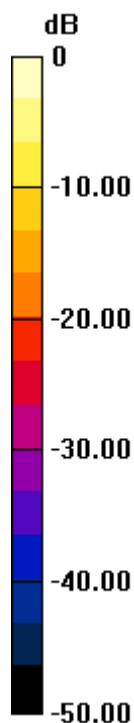

#15 WLAN5G_802.11a_Edge1_0cm_Ch140_WNC_Ant B_2D

DUT: 280820

Communication System: 802.11a; Frequency: 5700 MHz; Duty Cycle: 1:1

Medium: MSL_5G_120908 Medium parameters used: $f = 5700$ MHz; $\sigma = 5.81$ mho/m; $\epsilon_r = 46.685$; $\rho =$

1000 kg/m³

Ambient Temperature : 22.6 °C ; Liquid Temperature : 21.6 °C

DASY5 Configuration:

- Probe: EX3DV4 - SN3792; ConvF(3.72, 3.72, 3.72); Calibrated: 2012/6/21;
- Sensor-Surface: 2mm (Mechanical Surface Detection)
- Electronics: DAE3 Sn495; Calibrated: 2012/4/23
- Phantom: ELI v5.0; Type: QDOVA002AA; Serial: TP1127
- Measurement SW: DASY52, Version 52.8 (2); SEMCAD X Version 14.6.6 (6824)

Ch140/Area Scan (61x321x1): Measurement grid: dx=10 mm, dy=10 mm

Maximum value of SAR (interpolated) = 1.26 W/kg

Ch140/Zoom Scan (8x8x10)/Cube 0: Measurement grid: dx=4mm, dy=4mm, dz=2.5mm

Reference Value = 0 V/m; Power Drift = 0.07 dB

Peak SAR (extrapolated) = 1.424 mW/g

SAR(1 g) = 0.420 mW/g; SAR(10 g) = 0.143 mW/g

Maximum value of SAR (measured) = 0.824 W/kg

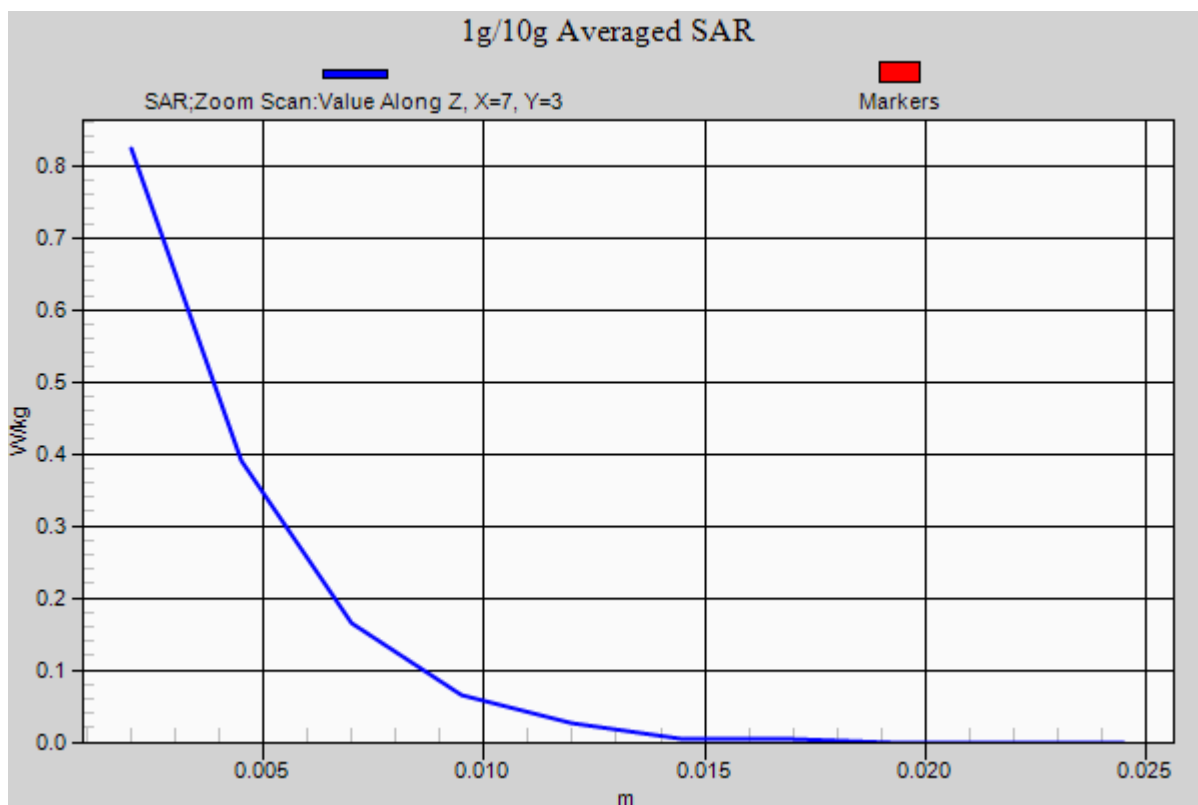

#16 WLAN5G_802.11a_Bottom_0cm_Ch140_WNC_Ant B

DUT: 280820

Communication System: 802.11a; Frequency: 5700 MHz; Duty Cycle: 1:1

Medium: MSL_5G_120906 Medium parameters used: $f = 5700$ MHz; $\sigma = 6$ mho/m; $\epsilon_r = 47.4$; $\rho = 1000$ kg/m³

Ambient Temperature : 22. °C; Liquid Temperature : 21. °C

DASY5 Configuration:

- Probe: EX3DV4 - SN3819; ConvF(4.02, 4.02, 4.02); Calibrated: 2011/11/16
- Sensor-Surface: 2mm (Mechanical Surface Detection)
- Electronics: DAE4 Sn1279; Calibrated: 2012/5/3
- Phantom: ELI 4.0; Type: QDOVA001BA; Serial: 1029
- Software: DASY5 Version; SEMCAD X Version 13.4 Build 45

Ch140/Area Scan (241x341x1): Measurement grid: dx=10mm, dy=10mm

Maximum value of SAR (interpolated) = 0.105 mW/g

Ch140/Zoom Scan (8x8x10)/Cube 0: Measurement grid: dx=4mm, dy=4mm, dz=2.5mm

Reference Value = 0 V/m; Power Drift = 0 dB

Peak SAR (extrapolated) = 0.248 W/kg

SAR(1 g) = 0.022 mW/g; SAR(10 g) = 0.00361 mW/g

Maximum value of SAR (measured) = 0.041 mW/g

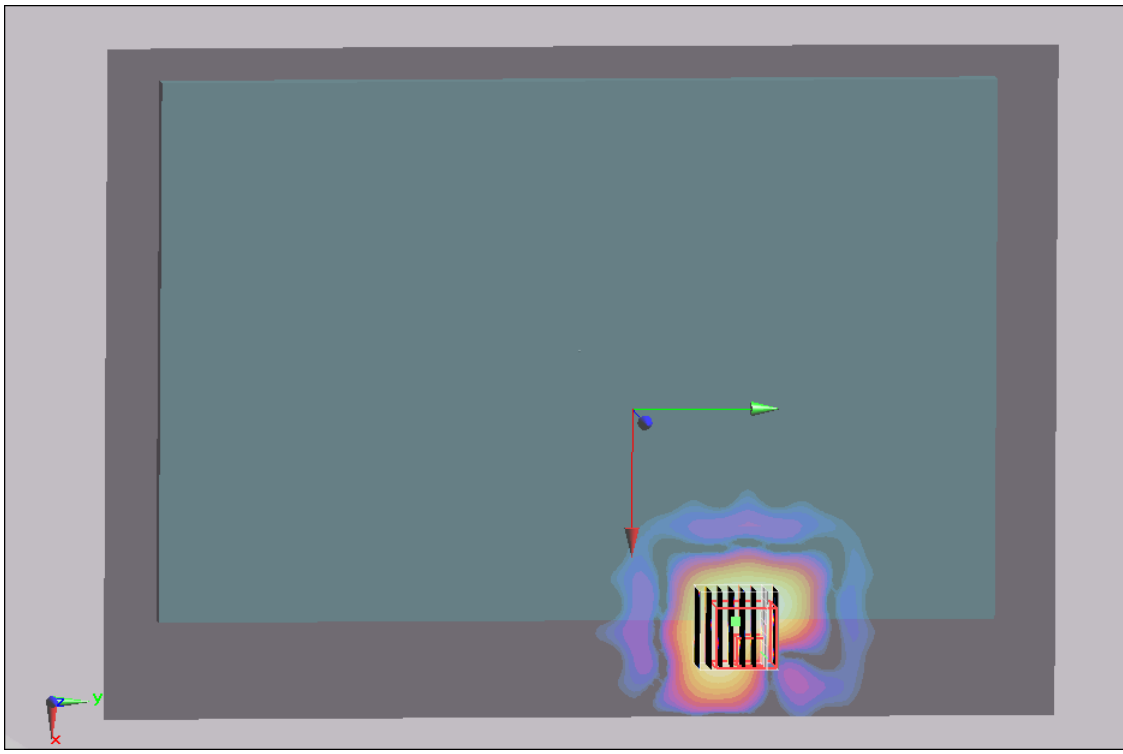
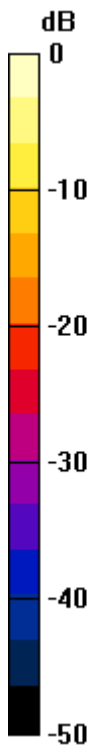

0 dB = 0.041mW/g

#17 WLAN5G_802.11a_Back of Display Screen_0cm_Ch140_WNC_Ant B

DUT: 280820

Communication System: 802.11a; Frequency: 5700 MHz; Duty Cycle: 1:1

Medium: MSL_5G_120906 Medium parameters used: $f = 5700$ MHz; $\sigma = 6$ mho/m; $\epsilon_r = 47.4$; $\rho = 1000$ kg/m³

Ambient Temperature : 22.3 °C; Liquid Temperature : 21.3 °C

DASY5 Configuration:

- Probe: EX3DV4 - SN3819; ConvF(4.02, 4.02, 4.02); Calibrated: 2011/11/16
- Sensor-Surface: 2mm (Mechanical Surface Detection)
- Electronics: DAE4 Sn1279; Calibrated: 2012/5/3
- Phantom: ELI 4.0; Type: QDOVA001BA; Serial: 1029
- Software: DASY5 Version; SEMCAD X Version 13.4 Build 45

Ch140/Area Scan (241x341x1): Measurement grid: dx=10mm, dy=10mm

Maximum value of SAR (interpolated) = 0.105 mW/g

Ch140/Zoom Scan (8x8x10)/Cube 0: Measurement grid: dx=4mm, dy=4mm, dz=2.5mm

Reference Value = 0 V/m; Power Drift = 0 dB

Peak SAR (extrapolated) = 0.144 W/kg

SAR(1 g) = 0.0074 mW/g; SAR(10 g) = 0.000839 mW/g

Maximum value of SAR (measured) = 0.031 mW/g

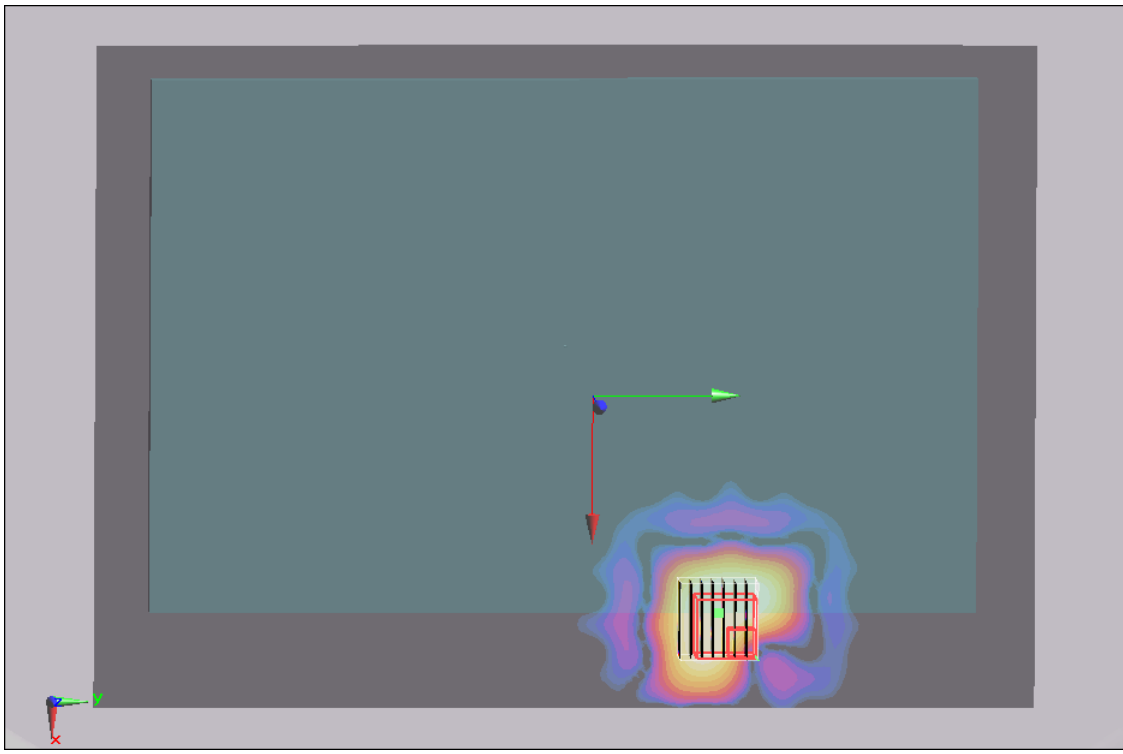
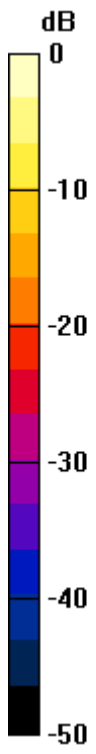

0 dB = 0.031mW/g

#18 WLAN5G_802.11a_Bottom Face_0cm_Ch161_WNC_Ant B

DUT: 280820

Communication System: 802.11a; Frequency: 5805 MHz; Duty Cycle: 1:1

Medium: MSL_5G_120908 Medium parameters used: $f = 5805$ MHz; $\sigma = 5.993$ mho/m; $\epsilon_r = 46.503$; $\rho =$

1000 kg/m³

Ambient Temperature : 22.6 °C ; Liquid Temperature : 21.6 °C

DASY5 Configuration:

- Probe: EX3DV4 - SN3792; ConvF(3.89, 3.89, 3.89); Calibrated: 2012/6/21;
- Sensor-Surface: 2mm (Mechanical Surface Detection)
- Electronics: DAE3 Sn495; Calibrated: 2012/4/23
- Phantom: ELI v5.0; Type: QDOVA002AA; Serial: TP1127
- Measurement SW: DASY52, Version 52.8 (2); SEMCAD X Version 14.6.6 (6824)

Ch161/Area Scan (261x321x1): Measurement grid: dx=10 mm, dy=10 mm

Maximum value of SAR (interpolated) = 0.0426 W/kg

Ch161/Zoom Scan (8x8x10)/Cube 0: Measurement grid: dx=4mm, dy=4mm, dz=2.5mm

Reference Value = 0 V/m; Power Drift = 0.10 dB

Peak SAR (extrapolated) = 0.123 mW/g

SAR(1 g) = 0.012 mW/g; SAR(10 g) = 0.00443 mW/g

Maximum value of SAR (measured) = 0.0259 W/kg

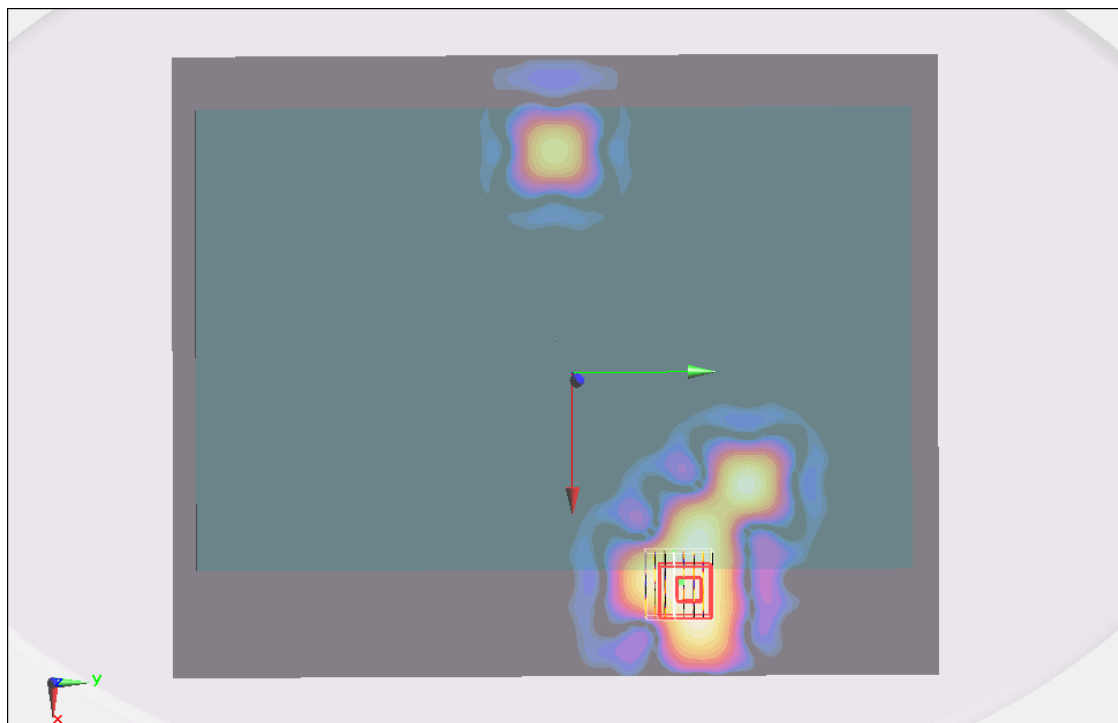
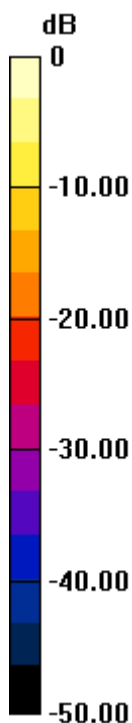

0 dB = 0.0259 W/kg = -31.73 dB W/kg

#19 WLAN5G_802.11a_Edge1_0cm_Ch161_WNC_Ant B

DUT: 280820

Communication System: 802.11a; Frequency: 5805 MHz; Duty Cycle: 1:1

Medium: MSL_5G_120908 Medium parameters used: $f = 5805$ MHz; $\sigma = 5.993$ mho/m; $\epsilon_r = 46.503$; $\rho =$

1000 kg/m³

Ambient Temperature : 22.6 °C ; Liquid Temperature : 21.6 °C

DASY5 Configuration:

- Probe: EX3DV4 - SN3792; ConvF(3.89, 3.89, 3.89); Calibrated: 2012/6/21;
- Sensor-Surface: 2mm (Mechanical Surface Detection)
- Electronics: DAE3 Sn495; Calibrated: 2012/4/23
- Phantom: ELI v5.0; Type: QDOVA002AA; Serial: TP1127
- Measurement SW: DASY52, Version 52.8 (2); SEMCAD X Version 14.6.6 (6824)

Ch161/Area Scan (61x321x1): Measurement grid: dx=10 mm, dy=10 mm

Maximum value of SAR (interpolated) = 1.18 W/kg

Ch161/Zoom Scan (8x8x10)/Cube 0: Measurement grid: dx=4mm, dy=4mm, dz=2.5mm

Reference Value = 0 V/m; Power Drift = 0.01 dB

Peak SAR (extrapolated) = 1.369 mW/g

SAR(1 g) = 0.399 mW/g; SAR(10 g) = 0.140 mW/g

Maximum value of SAR (measured) = 0.777 W/kg

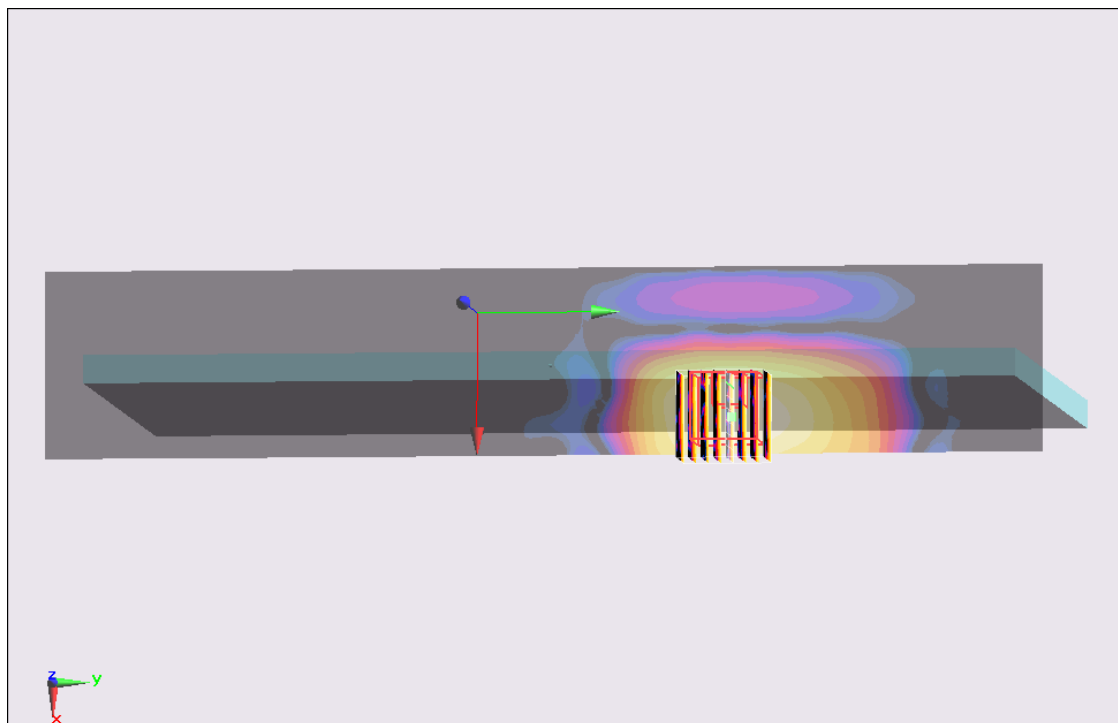
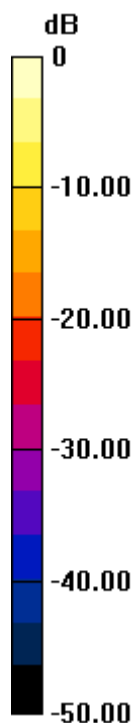

0 dB = 0.777 W/kg = -2.19 dB W/kg

#19 WLAN5G_802.11a_Edge1_0cm_Ch161_WNC_Ant B_2D

DUT: 280820

Communication System: 802.11a; Frequency: 5805 MHz; Duty Cycle: 1:1

Medium: MSL_5G_120908 Medium parameters used: $f = 5805$ MHz; $\sigma = 5.993$ mho/m; $\epsilon_r = 46.503$; $\rho =$

1000 kg/m³

Ambient Temperature : 22.6 °C ; Liquid Temperature : 21.6 °C

DASY5 Configuration:

- Probe: EX3DV4 - SN3792; ConvF(3.89, 3.89, 3.89); Calibrated: 2012/6/21;
- Sensor-Surface: 2mm (Mechanical Surface Detection)
- Electronics: DAE3 Sn495; Calibrated: 2012/4/23
- Phantom: ELI v5.0; Type: QDOVA002AA; Serial: TP1127
- Measurement SW: DASY52, Version 52.8 (2); SEMCAD X Version 14.6.6 (6824)

Ch161/Area Scan (61x321x1): Measurement grid: dx=10 mm, dy=10 mm

Maximum value of SAR (interpolated) = 1.18 W/kg

Ch161/Zoom Scan (8x8x10)/Cube 0: Measurement grid: dx=4mm, dy=4mm, dz=2.5mm

Reference Value = 0 V/m; Power Drift = 0.01 dB

Peak SAR (extrapolated) = 1.369 mW/g

SAR(1 g) = 0.399 mW/g; SAR(10 g) = 0.140 mW/g

Maximum value of SAR (measured) = 0.777 W/kg

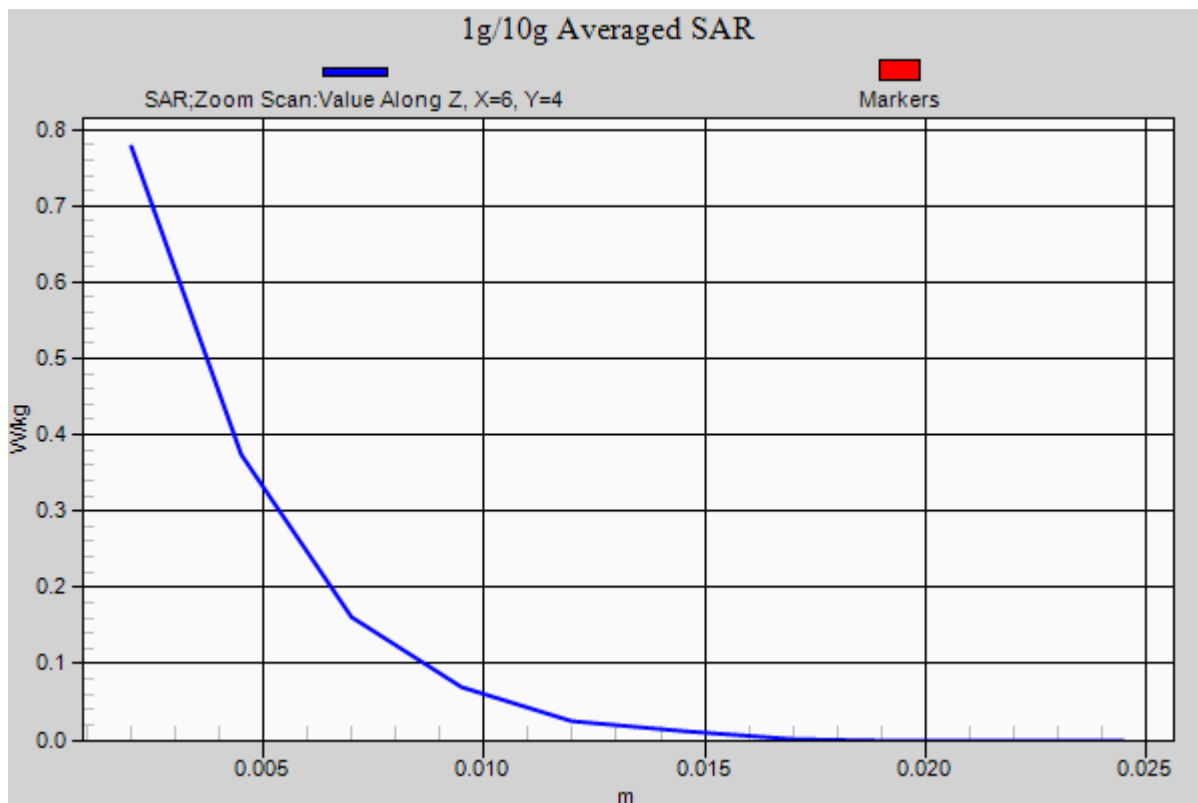

#20 WLAN5G_802.11a_Bottom_0cm_Ch161_WNC_Ant B

DUT: 280820

Communication System: 802.11a; Frequency: 5805 MHz; Duty Cycle: 1:1

Medium: MSL_5G_120908 Medium parameters used: $f = 5805$ MHz; $\sigma = 5.993$ mho/m; $\epsilon_r = 46.503$; $\rho = 1000$ kg/m³

Ambient Temperature : 22.6 °C; Liquid Temperature : 21.6 °C

DASY5 Configuration:

- Probe: EX3DV4 - SN3792; ConvF(3.89, 3.89, 3.89); Calibrated: 2012/6/21;
- Sensor-Surface: 2mm (Mechanical Surface Detection)
- Electronics: DAE3 Sn495; Calibrated: 2012/4/23
- Phantom: ELI v5.0; Type: QDOVA002AA; Serial: TP1127
- Measurement SW: DASY52, Version 52.8 (2); SEMCAD X Version 14.6.6 (6824)

Ch161/Area Scan (281x321x1): Measurement grid: dx=10 mm, dy=10 mm
Maximum value of SAR (interpolated) = 0.0160 W/kg

Ch161/Zoom Scan (8x8x10)/Cube 0: Measurement grid: dx=4mm, dy=4mm, dz=2.5mm
Reference Value = 0 V/m; Power Drift = 0.00 dB
Peak SAR (extrapolated) = 0.108 mW/g
SAR(1 g) = 0.011 mW/g; SAR(10 g) = 0.00281 mW/g
Maximum value of SAR (measured) = 0.0191 W/kg

Ch161/Zoom Scan (8x8x10)/Cube 1: Measurement grid: dx=4mm, dy=4mm, dz=2.5mm
Reference Value = 0 V/m; Power Drift = 0.00 dB
Peak SAR (extrapolated) = 0 mW/g
SAR(1 g) = n.a. ; SAR(10 g) = n.a.
Maximum value of SAR (measured) = 0.00669 W/kg

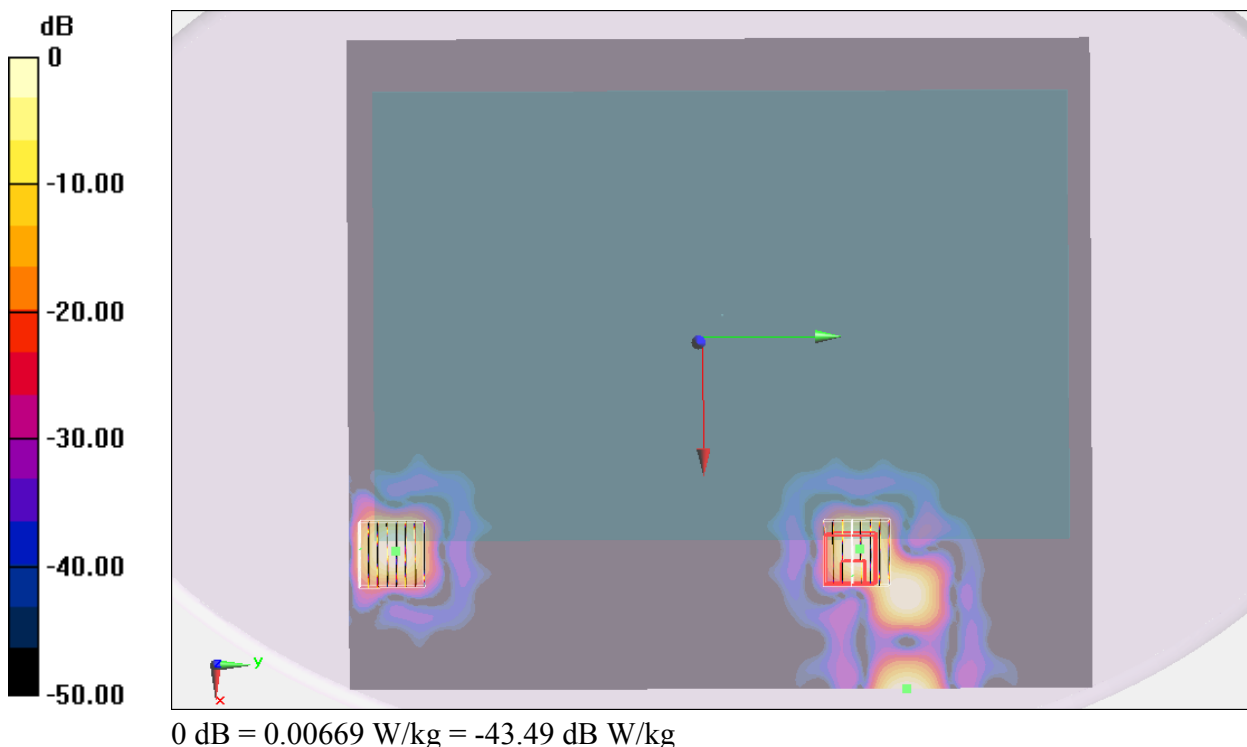

#21 WLAN5G_802.11a_Back of Display Screen_2.5cm_Ch161_WNC_Ant B

DUT: 280820

Communication System: 802.11a; Frequency: 5805 MHz; Duty Cycle: 1:1

Medium: MSL_5G_120908 Medium parameters used: $f = 5805$ MHz; $\sigma = 5.993$ mho/m; $\epsilon_r = 46.503$; $\rho =$

1000 kg/m³

Ambient Temperature : 22.6 °C ; Liquid Temperature : 21.6 °C

DASY5 Configuration:

- Probe: EX3DV4 - SN3792; ConvF(3.89, 3.89, 3.89); Calibrated: 2012/6/21;
- Sensor-Surface: 2mm (Mechanical Surface Detection)
- Electronics: DAE3 Sn495; Calibrated: 2012/4/23
- Phantom: ELI v5.0; Type: QDOVA002AA; Serial: TP1127
- Measurement SW: DASY52, Version 52.8 (2); SEMCAD X Version 14.6.6 (6824)

Ch161/Area Scan (261x321x1): Measurement grid: dx=10 mm, dy=10 mm

Maximum value of SAR (interpolated) = 0.0458 W/kg

Ch161/Zoom Scan (8x8x10)/Cube 0: Measurement grid: dx=4mm, dy=4mm, dz=2.5mm

Reference Value = 0 V/m; Power Drift = 0.00 dB

Peak SAR (extrapolated) = 0.098 mW/g

SAR(1 g) = 0.00954 mW/g; SAR(10 g) = 0.00365 mW/g

Maximum value of SAR (measured) = 0.0199 W/kg

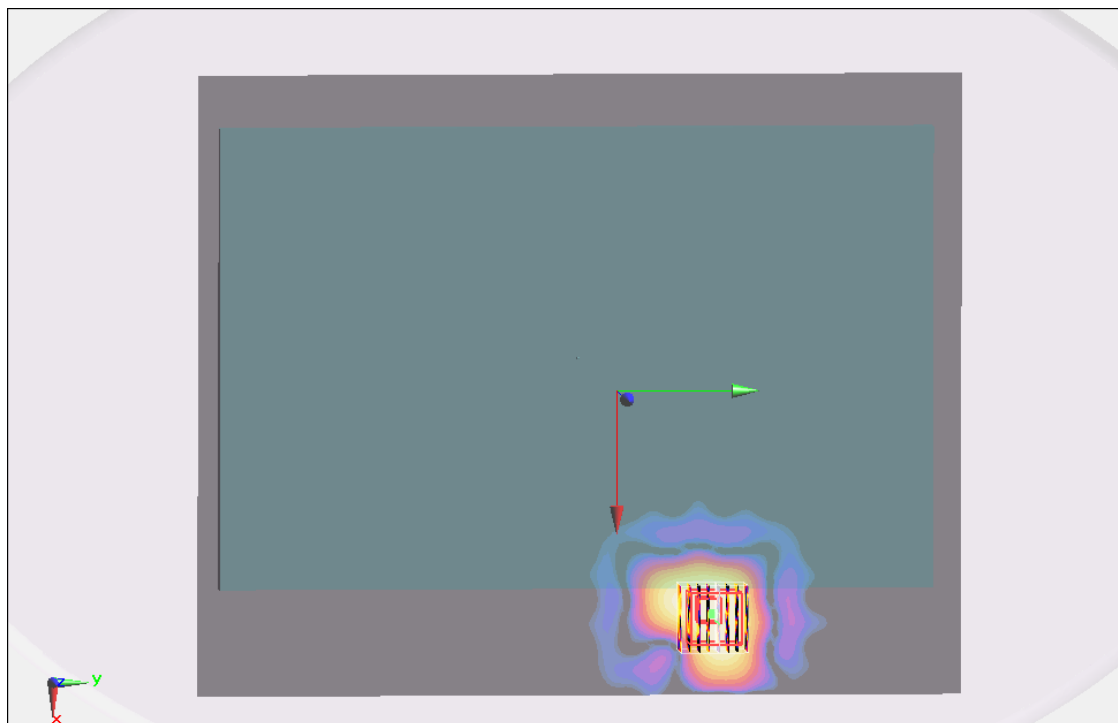
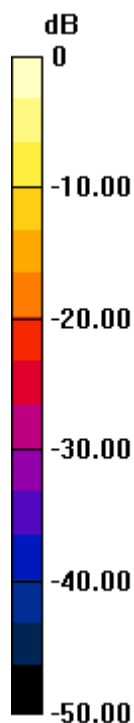

0 dB = 0.0199 W/kg = -34.02 dB W/kg