



# SPORTON International Inc.

No. 52, Hwa Ya 1st Rd., Kwei-Shan Hsiang, TaoYuan Hsien, Taiwan, R.O.C.  
Ph: 886-3-327-3456 / FAX: 886-3-327-0973 / www.sporton.com.tw

## FCC RADIO TEST REPORT

Applicant's company	<b>Broadcom Corporation</b>
Applicant Address	190 Mathilda Place, Sunnyvale, CA 94086 USA
FCC ID	<b>QDS-BRCM1067</b>
Manufacturer's company	<b>Hon Hai PRECISION IND. CO., LTD.</b>
Manufacturer Address	5F-1, 5 Hsin-An road Hsinchu, Science-Based Industrial Park, Taiwan, R.O.C.

Product Name	802.11abgn WLAN + Bluetooth Card
Brand Name	Broadcom
Model Name	BCM94330LGA
Test Rule Part(s)	47 CFR FCC Part 15 Subpart C § 15.247
Test Freq. Range	2400 ~ 2483.5MHz / 5725 ~ 5850MHz
Received Date	Jun. 04, 2012
Final Test Date	Jul. 17, 2012
Submission Type	Original Equipment

### Statement

**Test result included is only for the IEEE 802.11n, IEEE 802.11b/g part and IEEE 802.11a (5725 ~ 5850MHz) of the product.**

The test result in this report refers exclusively to the presented test model / sample.

Without written approval of SPORTON International Inc., the test report shall not be reproduced except in full.

The measurements and test results shown in this test report were made in accordance with the procedures and found in compliance with the limit given in **ANSI C63.10-2009** and **47 CFR FCC Part 15 Subpart C** and KDB 558074 – 20120118 & KDB662911 D01-20110404.

The test equipment used to perform the test is calibrated and traceable to NML/ROC.



## Table of Contents

<b>1. CERTIFICATE OF COMPLIANCE</b> .....	<b>1</b>
<b>2. SUMMARY OF THE TEST RESULT</b> .....	<b>2</b>
<b>3. GENERAL INFORMATION</b> .....	<b>3</b>
3.1. Product Details .....	3
3.2. Accessories .....	5
3.3. Table for Filed Antenna .....	6
3.4. Table for Carrier Frequencies .....	7
3.5. Table for Test Modes .....	8
3.6. Table for Testing Locations.....	10
3.7. Table for Supporting Units .....	10
3.8. Table for Parameters of Test Software Setting .....	11
3.9. Test Configurations.....	13
<b>4. TEST RESULT</b> .....	<b>16</b>
4.1. AC Power Line Conducted Emissions Measurement .....	16
4.2. Peak Output Power Measurement .....	20
4.3. Average Output Power Measurement.....	23
4.4. Power Spectral Density Measurement.....	26
4.5. 6dB Spectrum Bandwidth Measurement .....	33
4.6. Radiated Emissions Measurement.....	39
4.7. Band Edge Emissions Measurement.....	60
4.8. Antenna Requirements .....	69
<b>5. LIST OF MEASURING EQUIPMENTS</b> .....	<b>70</b>
<b>6. TEST LOCATION</b> .....	<b>72</b>
<b>7. TAF CERTIFICATE OF ACCREDITATION</b> .....	<b>73</b>
<b>APPENDIX A. TEST PHOTOS</b> .....	<b>A1 ~ A6</b>
<b>APPENDIX B. MAXIMUM PERMISSIBLE EXPOSURE</b> .....	<b>B1 ~ B4</b>
<b>APPENDIX C. CO-LOCATION REPORT</b> .....	<b>C1 ~ C3</b>

### History of This Test Report

REPORT NO.	VERSION	DESCRIPTION	ISSUED DATE
FR260412AA	Rev. 01	Initial issue of report	Jul. 25, 2012

## 1. CERTIFICATE OF COMPLIANCE

Product Name : 802.11 abgn WLAN + Bluetooth Card  
Brand Name : Broadcom  
Model Name : BCM94330LGA  
Applicant : Broadcom Corporation  
Test Rule Part(s) : 47 CFR FCC Part 15 Subpart C § 15.247

Sporton International as requested by the applicant to evaluate the EMC performance of the product sample received on Jun. 04, 2012 would like to declare that the tested sample has been evaluated and found to be in compliance with the tested rule parts. The data recorded as well as the test configuration specified is true and accurate for showing the sample's EMC nature.

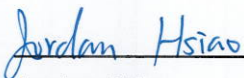

Jordan Hsiao

SPORTON INTERNATIONAL INC.

## 2. SUMMARY OF THE TEST RESULT

Applied Standard: 47 CFR FCC Part 15 Subpart C				
Part	Rule Section	Description of Test	Result	Under Limit
4.1	15.207	AC Power Line Conducted Emissions	Complies	18.49 dB
4.2	15.247(b)(3)	Peak Output Power	Complies	7.48 dB
4.3	-	Average Output Power	-	-
4.4	15.247(e)	Power Spectral Density	Complies	17.79 dB
4.5	15.247(a)(2)	6dB Spectrum Bandwidth	Complies	-
4.6	15.247(d)	Radiated Emissions	Complies	2.36 dB
4.7	15.247(d)	Band Edge Emissions	Complies	0.25 dB
4.8	15.203	Antenna Requirements	Complies	-

Test Items	Uncertainty	Remark
AC Power Line Conducted Emissions	±2.3dB	Confidence levels of 95%
Maximum Peak Output Power	±0.8dB	Confidence levels of 95%
Power Spectral Density	±0.5dB	Confidence levels of 95%
6dB Spectrum Bandwidth	±8.5×10 <sup>-8</sup>	Confidence levels of 95%
Radiated Emissions (9kHz~30MHz)	±0.8dB	Confidence levels of 95%
Radiated Emissions (30MHz~1000MHz)	±1.9dB	Confidence levels of 95%
Radiated / Band Edge Emissions (1GHz~18GHz)	±1.9dB	Confidence levels of 95%
Radiated Emissions (18GHz~40GHz)	±1.9dB	Confidence levels of 95%
Temperature	±0.7°C	Confidence levels of 95%
Humidity	±3.2%	Confidence levels of 95%
DC / AC Power Source	±1.4%	Confidence levels of 95%

### 3. GENERAL INFORMATION

#### 3.1. Product Details

##### IEEE 802.11n

Items	Description
Product Type	WLAN (1TX, 1RX)
Radio Type	Intentional Transceiver
Power Type	From host system
Modulation	see the below table for IEEE 802.11n
Data Modulation	OFDM (BPSK / QPSK / 16QAM / 64QAM)
Data Rate (Mbps)	see the below table for IEEE 802.11n
Frequency Range	2400 ~ 2483.5MHz / 5725 ~ 5850MHz
Channel Number	For 2.4GHz Band: 11 for 20MHz bandwidth For 5GHz Band: 5 for 20MHz bandwidth
Channel Band Width (99%)	For 2.4GHz Band: MCS0 (20MHz): 17.60 MHz For 5GHz Band: MCS0 (20MHz): 17.60 MHz
Peak Output Power	For 2.4GHz Band: MCS0 (20MHz): 22.32 dBm For 5GHz Band: MCS0 (20MHz): 20.51 dBm
Carrier Frequencies	Please refer to section 3.4
Antenna	Please refer to section 3.3

**802.11a/b/g**

Items	Description
Product Type	WLAN (1TX, 1RX)
Radio Type	Intentional Transceiver
Power Type	From host system
Modulation	DSSS for IEEE 802.11b ; OFDM for IEEE 802.11a/g
Data Modulation	DSSS (BPSK / QPSK / CCK) ; OFDM (BPSK / QPSK / 16QAM / 64QAM)
Data Rate (Mbps)	DSSS (1/ 2/ 5.5/11) ; OFDM (6/9/12/18/24/36/48/54)
Frequency Range	2400 ~ 2483.5MHz / 5725 ~ 5850MHz
Channel Number	11b/g: 11 ; 11a: 5
Channel Band Width (99%)	11b: 12.16 MHz ; 11g: 16.64 MHz ; 11a: 16.72 MHz
Peak Output Power	11b: 19.12 dBm ; 11g: 22.52 dBm ; 11a: 20.96 dBm
Carrier Frequencies	Please refer to section 3.4
Antenna	Please refer to section 3.3

**Antenna & Band width**

Antenna	Single (TX)
Band width Mode	20 MHz
IEEE 802.11a	✓
IEEE 802.11b	✓
IEEE 802.11g	✓
IEEE 802.11n	✓

## IEEE 802.11n spec

MCS Index	Nss	Modulation	R	NBPS	NCBPS	NDBPS	Datarate(Mbps)	
							800nsGI	400nsGI
							20MHz	20MHz
0	1	BPSK	1/2	1	52	26	6.5	7.200
1	1	QPSK	1/2	2	104	52	13.0	14.400
2	1	QPSK	3/4	2	104	78	19.5	21.700
3	1	16-QAM	1/2	4	208	104	26.0	28.900
4	1	16-QAM	3/4	4	208	156	39.0	43.300
5	1	64-QAM	2/3	6	312	208	52.0	57.800
6	1	64-QAM	3/4	6	312	234	58.5	65.000
7	1	64-QAM	5/6	6	312	260	65.0	72.200
8	2	BPSK	1/2	1	104	52	13.0	14.444
9	2	QPSK	1/2	2	208	104	26.0	28.889
10	2	QPSK	3/4	2	208	156	39.0	43.333
11	2	16-QAM	1/2	4	416	208	52.0	57.778
12	2	16-QAM	3/4	4	416	312	78.0	86.667
13	2	64-QAM	2/3	6	624	416	104.0	115.556
14	2	64-QAM	3/4	6	624	468	117.0	130.000
15	2	64-QAM	5/6	6	624	520	130.0	144.444

Symbol	Explanation
NSS	Number of spatial streams
R	Code rate
NBPS	Number of coded bits per single carrier
NCBPS	Number of coded bits per symbol
NDBPS	Number of data bits per symbol
GI	guard interval

### 3.2. Accessories

NA



### 3.3. Table for Filed Antenna

Ant.	Brand	Model Name	Antenna Type	Connector	Gain (dBi)	
A	WhaYu	-	PIFA Antenna	I-pex	2.4GHz	3
B	WhaYu	-	PIFA Antenna	I-pex	5GHz	4.3

Note: The EUT has two antennas. One for 2.4GHz band use, the other for 5GHz band use.

<2.4GHz WALN function without Bluetooth function:>

For IEEE 802.11 b/g/n mode (1TX,1RX)

Only Ant. A can be used as transmitting/receiving antenna.

<2.4GHz WALN function with Bluetooth function:>

For IEEE 802.11b/g/n Mode: (1TX, 1RX)

Only Ant. A can be used as transmitting/receiving antenna.

<5GHz WALN function>

For IEEE 802.11a/an Mode: (1TX, 1RX)

Only Ant. B can be used as transmitting/receiving antenna.

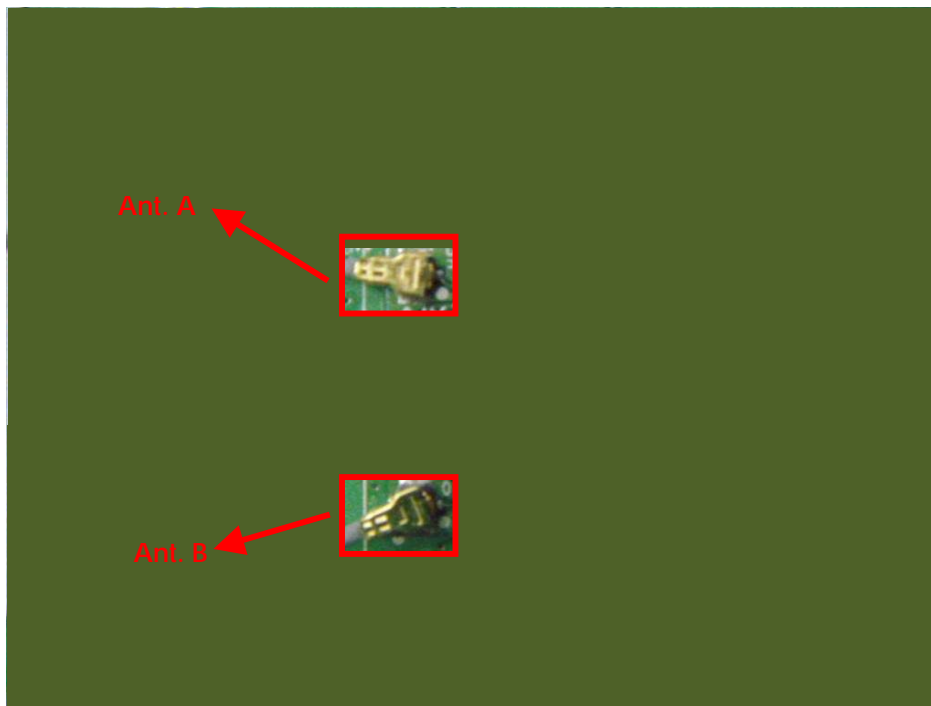

### 3.4. Table for Carrier Frequencies

#### For 2.4GHz Band:

For IEEE 802.11b/g, use Channel 1~Channel 11.

There is one bandwidth systems for IEEE 802.11n.

For both 20MHz bandwidth systems, use Channel 1~Channel 11.

Frequency Band	Channel No.	Frequency	Channel No.	Frequency
2400~2483.5MHz	1	2412 MHz	7	2442 MHz
	2	2417 MHz	8	2447 MHz
	3	2422 MHz	9	2452 MHz
	4	2427 MHz	10	2457 MHz
	5	2432 MHz	11	2462 MHz
	6	2437 MHz	-	-

#### For 5GHz Band:

For IEEE 802.11a, use Channel 149, 153, 157, 161, 165.

There is one bandwidth systems for IEEE 802.11n.

For 20MHz bandwidth systems, use Channel 149, 153, 157, 161, 165.

Frequency Band	Channel No.	Frequency	Channel No.	Frequency
5725~5850 MHz Band 4	149	5745 MHz	157	5785 MHz
	153	5765 MHz	161	5805 MHz
	165	5825 MHz	-	-

### 3.5. Table for Test Modes

Preliminary tests were performed in different data rate to find the worst radiated emission. The data rate shown in the table below is the worst-case rate with respect to the specific test item. Investigation has been done on all the possible configurations for searching the worst cases. The following table is a list of the test modes shown in this test report.

#### For 2.4GHz Band

Test Items	Mode	Data Rate	Channel	Antenna
AC Power Line Conducted Emissions	Normal Link	Auto	-	-
Peak Output Power	MCS0/20MHz	6.5 Mbps	1/6/11	A
Average Output Power	11b/CCK	1 Mbps	1/6/11	A
Power Spectral Density	11g/BPSK	6 Mbps	1/6/11	A
6dB Spectrum Bandwidth	MCS0/20MHz	6.5 Mbps	1/6/11	A
	11b/CCK	1 Mbps	1/6/11	A
	11g/BPSK	6 Mbps	1/6/11	A
Radiated Emissions Below 1GHz	Normal Link	Auto	-	-
Radiated Emissions Above 1GHz	MCS0/20MHz	6.5 Mbps	1/6/11	A
	11b/CCK	1 Mbps	1/6/11	A
	11g/BPSK	6 Mbps	1/6/11	A
Band Edge Emissions	MCS0/20MHz	6.5 Mbps	1/6/11	A
	11b/CCK	1 Mbps	1/6/11	A
	11g/BPSK	6 Mbps	1/6/11	A

**For 5GHz Band**

Test Items	Mode	Data Rate	Channel	Antenna
AC Power Line Conducted Emissions	Normal Link	Auto	-	-
Peak Output Power	MCS0/20MHz	6.5 Mbps	149/157/165	B
Average Output Power	11a/BPSK	6 Mbps	149/157/165	B
Power Spectral Density				
6dB Spectrum Bandwidth	MCS0/20MHz	6.5 Mbps	149/157/165	B
	11a/BPSK	6 Mbps	149/157/165	B
Radiated Emissions Below 1GHz	Normal Link	Auto	-	-
Radiated Emissions Above 1GHz	MCS0/20MHz	6.5 Mbps	149/157/165	B
	11a/BPSK	6 Mbps	149/157/165	B
Band Edge Emissions	MCS0/20MHz	6.5 Mbps	149/157/165	B
	11a/BPSK	6 Mbps	149/157/165	B

**<For MPE and Co-location Test>:**

The EUT could be applied with 2.4GHz WLAN function and 5GHz WLAN function; therefore Maximum Permissible Exposure (Please refer to Appendix B) and Co-location (please refer to Appendix C) tests are added for simultaneously transmit between 2.4GHz WLAN function and 5GHz WLAN function.

### 3.6. Table for Testing Locations

Test Site No.	Site Category	Location	FCC Reg. No.	IC File No.
03CH01-CB	SAC	Hsin Chu	262045	IC 4086D
CO01-CB	Conduction	Hsin Chu	262045	IC 4086D
TH01-CB	OVEN Room	Hsin Chu	-	-

Open Area Test Site (OATS); Semi Anechoic Chamber (SAC); Fully Anechoic Chamber (FAC).

Please refer section 6 for Test Site Address.

### 3.7. Table for Supporting Units

Support Unit	Brand	Model	FCC ID
Notebook	DELL	M1330	E2K4965AGNM
Notebook	DELL	LATITUDE E6500	PDN:5JNCT A00
Mouse	Logitech M90	M-U0026	DoC
Wireless AP	BELKIN	WG7016G22-LF-AK	DoC
EARPHONES	E-books	E-EPC040	N/A

### 3.8. Table for Parameters of Test Software Setting

During testing, Channel & Power Controlling Software provided by the customer was used to control the operating channel as well as the output power level. The RF output power selection is for the setting of RF output power expected by the customer and is going to be fixed on the firmware of the final end product.

#### For 2.4GHz Band

##### Power Parameters of IEEE 802.11n MCS0 20MHz

Test Software Version	DOS		
Frequency	2412 MHz	2437 MHz	2462 MHz
MCS0 20MHz	56	54	54

##### Power Parameters of IEEE 802.11b/g

Test Software Version	DOS		
Frequency	2412 MHz	2437 MHz	2462 MHz
IEEE 802.11b	64	64	62
IEEE 802.11g	58	58	58

**For 5GHz Band**

**Power Parameters of IEEE 802.11n MCS0 20MHz**

Test Software Version	DOS		
Frequency	5745 MHz	5785 MHz	5825 MHz
MCS0 20MHz	48	48	50

**Power Parameters of IEEE 802.11a**

Test Software Version	DOS		
Frequency	5745 MHz	5785 MHz	5825 MHz
IEEE 802.11a	52	52	54

During the test, "DOS" under WIN XP was executed the test program to control the EUT continuously transmit RF signal.

### 3.9. Test Configurations

#### 3.9.1. Radiation Emissions Test Configuration

Test Configuration: 30MHz ~1GHz

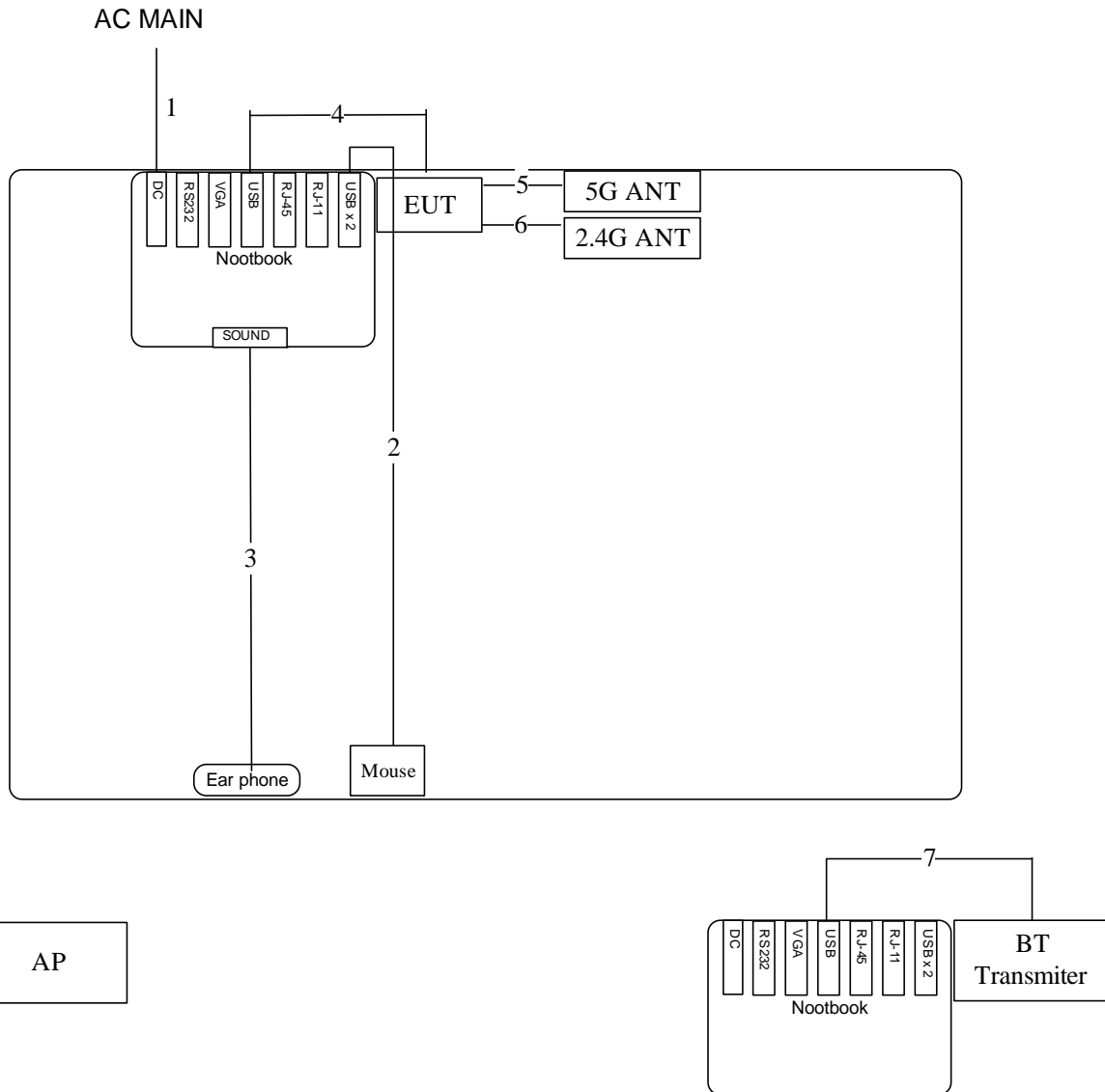

Item	Connection	Shield	Length
1	Power cable	No	2.6M
2	USB cable	No	1.8M
3	Earphone cable	No	1.1M
4	RS-232 cable	Yes	1.95M
5	Antenna cable	Yes	0.11M
6	Antenna cable	Yes	1.8M
7	RS-232 cable	Yes	1.95M



Test Configuration: above 1GHz

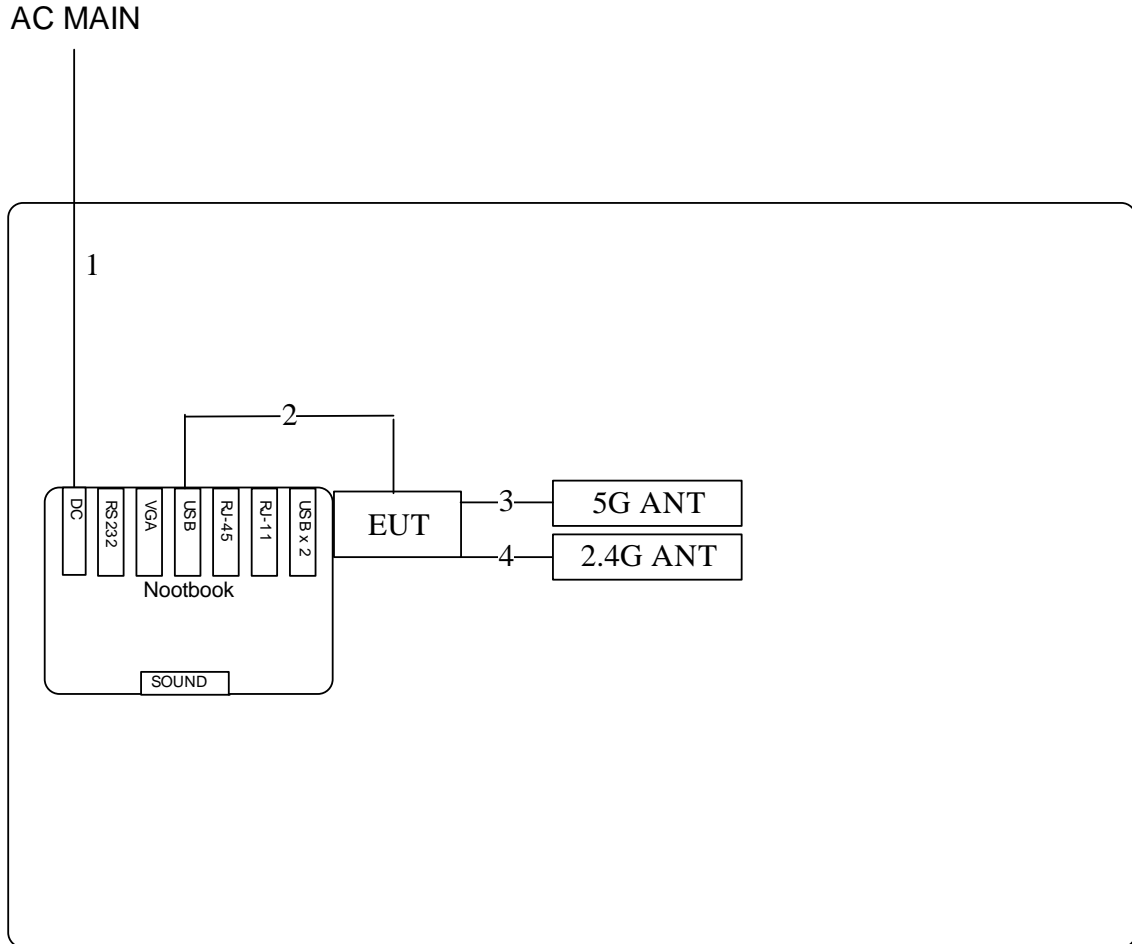

Item	Connection	Shield	Length
1	Power cable	No	2.6M
2	Antenna cable	Yes	0.11M
3	Antenna cable	Yes	1.8M
4	RS-232 cable	Yes	1.95M

### 3.9.2. AC Power Line Conduction Emissions Test Configuration

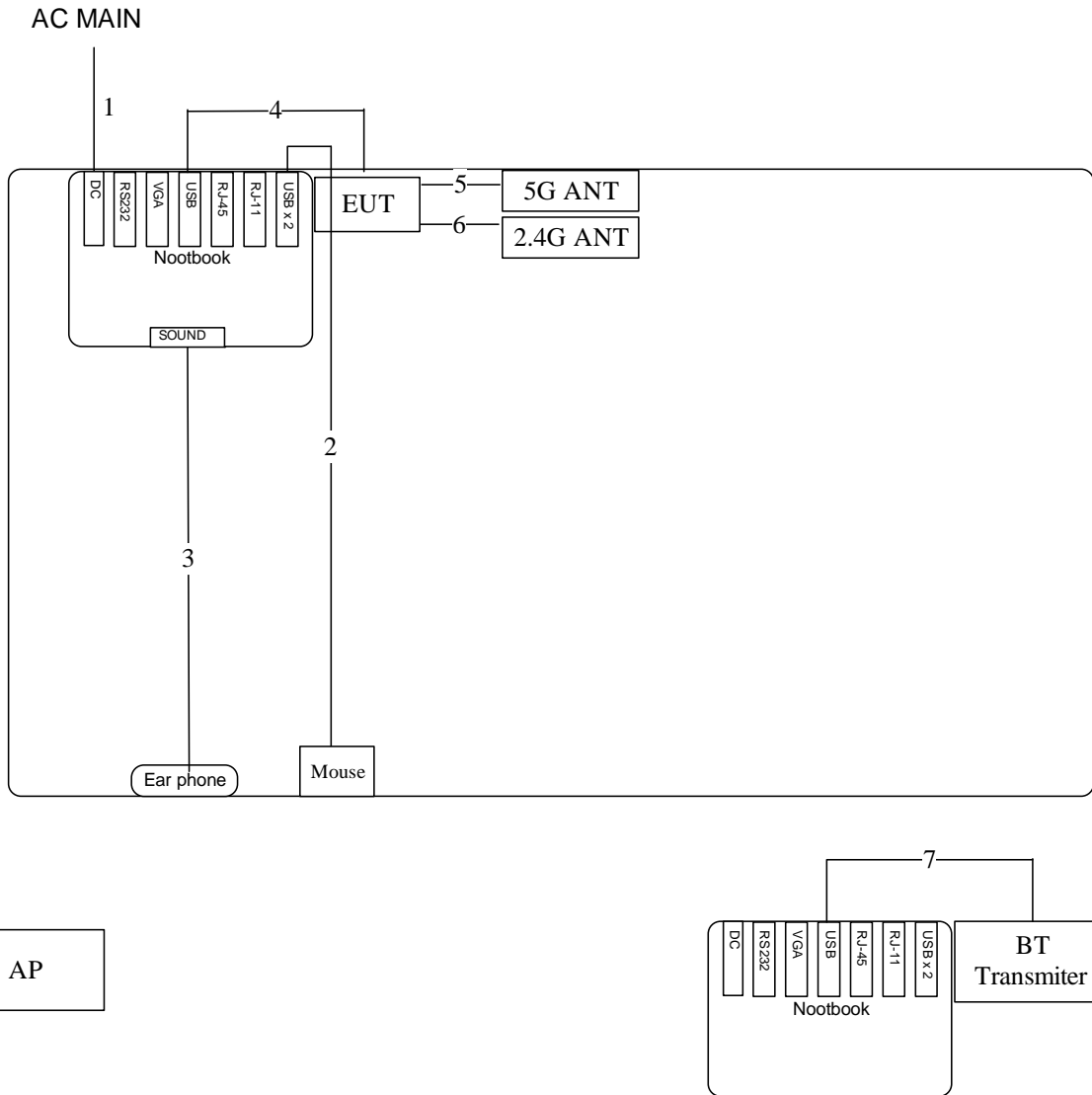

Item	Connection	Shield	Length
1	Power cable	No	2.6M
2	USB cable	No	1.8M
3	Earphone cable	No	1.1M
4	RS-232 cable	Yes	1.95M
5	Antenna cable	Yes	0.11M
6	Antenna cable	Yes	1.8M
7	RS-232 cable	Yes	1.95M

## 4. TEST RESULT

### 4.1. AC Power Line Conducted Emissions Measurement

#### 4.1.1. Limit

For this product which is designed to be connected to the AC power line, the radio frequency voltage that is conducted back onto the AC power line on any frequency or frequencies within the band 150 kHz to 30 MHz shall not exceed below limits table.

Frequency (MHz)	QP Limit (dBuV)	AV Limit (dBuV)
0.15~0.5	66~56	56~46
0.5~5	56	46
5~30	60	50

#### 4.1.2. Measuring Instruments and Setting

Please refer to section 5 of equipments list in this report. The following table is the setting of the receiver.

Receiver Parameters	Setting
Attenuation	10 dB
Start Frequency	0.15 MHz
Stop Frequency	30 MHz
IF Bandwidth	9 KHz

#### 4.1.3. Test Procedures

1. Configure the EUT according to ANSI C63.10. The EUT or host of EUT has to be placed 0.4 meter far from the conducting wall of the shielding room and at least 80 centimeters from any other grounded conducting surface.
2. Connect EUT or host of EUT to the power mains through a line impedance stabilization network (LISN).
3. All the support units are connected to the other LISNs. The LISN should provide 50uH/50ohms coupling impedance.
4. The frequency range from 150 KHz to 30 MHz was searched.
5. Set the test-receiver system to Peak Detect Function and Specified Bandwidth with Maximum Hold Mode.
6. The measurement has to be done between each power line and ground at the power terminal.

#### 4.1.4. Test Setup Layout

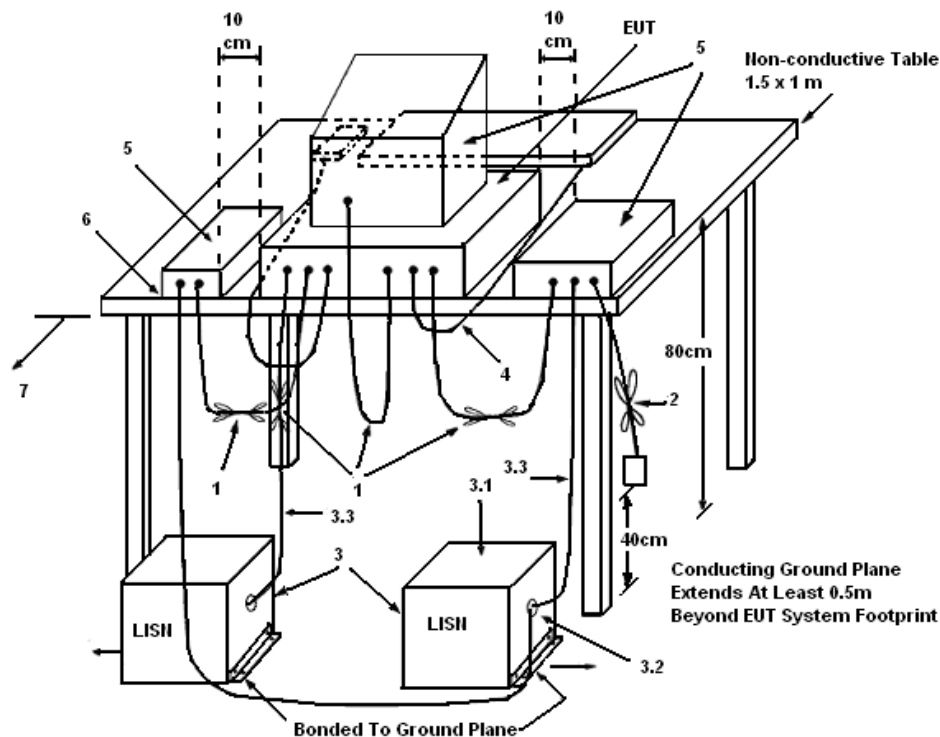

#### LEGEND:

- (1) Interconnecting cables that hang closer than 40 cm to the ground plane shall be folded back and forth in the center forming a bundle 30 to 40 cm long.
- (2) I/O cables that are not connected to a peripheral shall be bundled in the center. The end of the cable may be terminated, if required, using the correct terminating impedance. The overall length shall not exceed 1 m.
- (3) EUT connected to one LISN. Unused LISN measuring port connectors shall be terminated in 50 Ω. LISN can be placed on top of, or immediately beneath, reference ground plane.
  - (3.1) All other equipment powered from additional LISN(s).
  - (3.2) Multiple outlet strip can be used for multiple power cords of non-EUT equipment.
  - (3.3) LISN at least 80 cm from nearest part of EUT chassis.
- (4) Cables of hand-operated devices, such as keyboards, mice, etc., shall be placed as for normal use.
- (5) Non-EUT components of EUT system being tested.
- (6) Rear of EUT, including peripherals, shall all be aligned and flush with rear of tabletop.
- (7) Rear of tabletop shall be 40 cm removed from a vertical conducting plane that is bonded to the ground plane.

#### 4.1.5. Test Deviation

There is no deviation with the original standard.

#### 4.1.6. EUT Operation during Test

The EUT was placed on the test table and programmed in normal function.

4.1.7. Results of AC Power Line Conducted Emissions Measurement

Temperature	22°C	Humidity	57%
Test Engineer	Kane Liu	Phase	Line
Configuration	Normal Link		

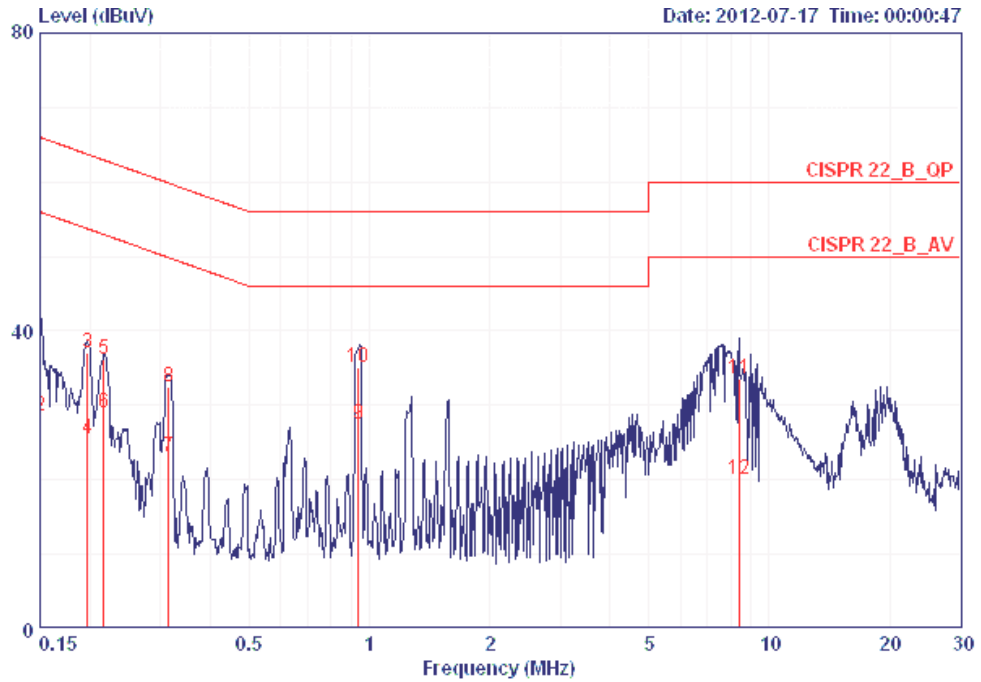

	Freq	Level	Over Limit	Limit Line	Read Level	LISN Factor	Cable Loss	Pol/Phase	Remark
	MHz	dBuV	dB	dBuV	dBuV	dB	dB		
1	0.15000	39.38	-26.62	66.00	39.02	0.16	0.20	LINE	QP
2	0.15000	28.47	-27.53	56.00	28.11	0.16	0.20	LINE	AVERAGE
3	0.19758	36.95	-26.76	63.71	36.60	0.15	0.20	LINE	QP
4	0.19758	25.45	-28.26	53.71	25.10	0.15	0.20	LINE	AVERAGE
5	0.21620	36.23	-26.73	62.96	35.88	0.15	0.20	LINE	QP
6	0.21620	28.93	-24.03	52.96	28.58	0.15	0.20	LINE	AVERAGE
7	0.31495	23.15	-26.69	49.84	22.80	0.15	0.20	LINE	AVERAGE
8	0.31495	32.58	-27.26	59.84	32.23	0.15	0.20	LINE	QP
9	0.94009	27.51	-18.49	46.00	27.14	0.17	0.20	LINE	AVERAGE
10	0.94009	35.20	-20.80	56.00	34.83	0.17	0.20	LINE	QP
11	8.412	33.56	-26.44	60.00	32.93	0.31	0.32	LINE	QP
12	8.412	20.08	-29.92	50.00	19.45	0.31	0.32	LINE	AVERAGE

Temperature	22°C	Humidity	57%
Test Engineer	Kane Liu	Phase	Neutral
Configuration	Normal Link		

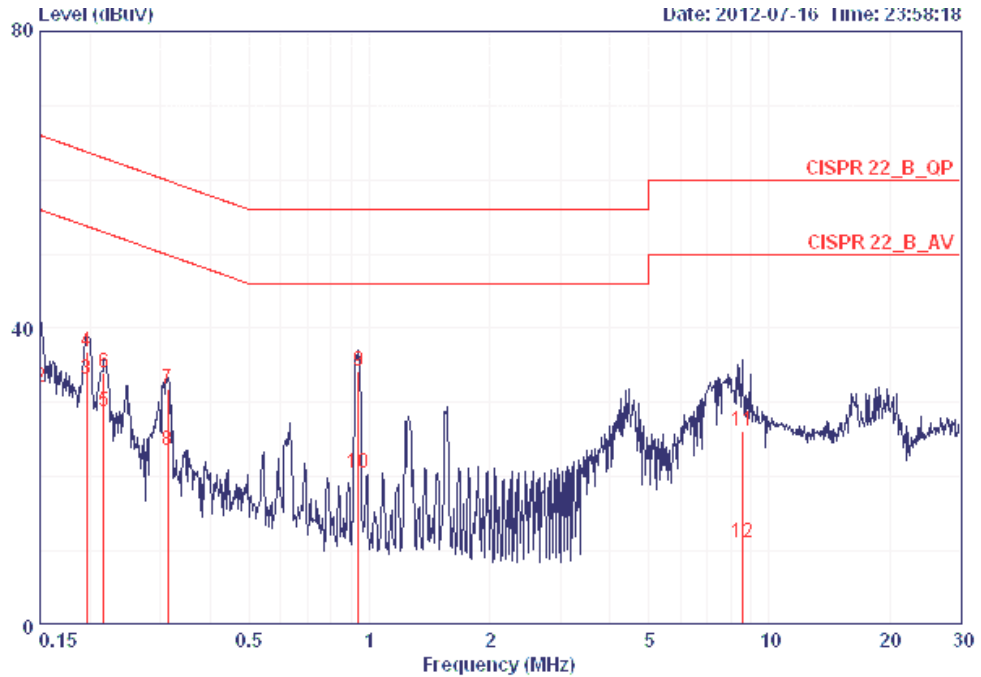

	Freq	Level	Over Limit	Limit Line	Read Level	LISN Factor	Cable Loss	Pol/Phase	Remark
	MHz	dBuV	dB	dBuV	dBuV	dB	dB		
1	0.15000	38.47	-27.53	66.00	38.19	0.08	0.20	NEUTRAL	QP
2	0.15000	32.00	-24.00	56.00	31.72	0.08	0.20	NEUTRAL	AVERAGE
3	0.19654	33.16	-20.60	53.76	32.88	0.08	0.20	NEUTRAL	AVERAGE
4	0.19654	36.82	-26.94	63.76	36.54	0.08	0.20	NEUTRAL	QP
5	0.21620	28.77	-24.19	52.96	28.49	0.08	0.20	NEUTRAL	AVERAGE
6	0.21620	33.94	-29.02	62.96	33.66	0.08	0.20	NEUTRAL	QP
7	0.31328	31.88	-28.00	59.88	31.60	0.08	0.20	NEUTRAL	QP
8	0.31328	23.63	-26.25	49.88	23.35	0.08	0.20	NEUTRAL	AVERAGE
9	0.93810	34.19	-21.81	56.00	33.90	0.09	0.20	NEUTRAL	QP
10	0.93810	20.51	-25.49	46.00	20.22	0.09	0.20	NEUTRAL	AVERAGE
11	8.546	26.19	-33.81	60.00	25.68	0.21	0.30	NEUTRAL	QP
12	8.546	11.19	-38.81	50.00	10.68	0.21	0.30	NEUTRAL	AVERAGE

Note:

Level = Read Level + LISN Factor + Cable Loss.

## 4.2. Peak Output Power Measurement

### 4.2.1. Limit

For systems using digital modulation in the 2400-2483.5MHz, the limit for peak output power is 30dBm. The limited has to be reduced by the amount in dB that the gain of the antenna exceed 6dBi. In case of point-to-point operation, the limit has to be reduced by 1dB for every 3dB that the directional gain of the antenna exceeds 6dBi. Systems operating in the 5725-5850 MHz band that are used exclusively for fixed, point-to-point operations may employ transmitting antennas with directional gain greater than 6 dBi without any corresponding reduction in transmitter peak output power.

### 4.2.2. Measuring Instruments and Setting

Please refer to section 5 of equipments list in this report. The following table is the setting of the peak power meter.

Power Meter Parameter	Setting
Bandwidth	50MHz bandwidth is greater than the EUT emission bandwidth
Detector	Peak

### 4.2.3. Test Procedures

Spectrum Parameter	Setting
RF Output Power Method	<input checked="" type="checkbox"/> ANSI C63.10 clause 6.10.2.1 (a) power meter method
RF Output Power Method	<input type="checkbox"/> ANSI C63.10 clause 6.10.2.1 (b) channel integration method
RF Output Power Method	<input type="checkbox"/> ANSI C63.10 clause 6.10.3.1 Method 1 - spectral trace averaging
RF Output Power Method	<input type="checkbox"/> ANSI C63.10 clause 6.10.3.2 Method 2 - zero-span mode with trace averaging

### 4.2.4. Test Setup Layout

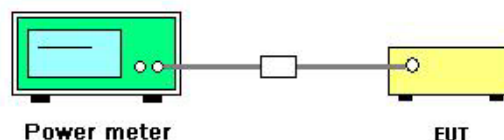

### 4.2.5. Test Deviation

There is no deviation with the original standard.

### 4.2.6. EUT Operation during Test

The EUT was programmed to be in continuously transmitting mode.

#### 4.2.7. Test Result of Peak Output Power

Temperature	24°C	Humidity	63%
Test Engineer	Satoshi Yang	Configurations	IEEE 802.11n
Test Date	Jun. 28, 2012		

##### For 2.4GHz Band

##### Configuration IEEE 802.11n MCS0 20MHz

Channel	Frequency	Conducted Power (dBm)	Max. Limit (dBm)	Result
		Ant. A		
1	2412 MHz	22.32	30.00	Complies
6	2437 MHz	22.25	30.00	Complies
11	2462 MHz	22.31	30.00	Complies

##### For 5GHz Band

##### Configuration IEEE 802.11n MCS0 20MHz

Channel	Frequency	Conducted Power (dBm)	Max. Limit (dBm)	Result
		Ant. B		
149	5745 MHz	20.43	30.00	Complies
157	5785 MHz	20.15	30.00	Complies
165	5825 MHz	20.51	30.00	Complies



Temperature	24°C	Humidity	63%
Test Engineer	Satoshi Yang	Configurations	IEEE 802.11a/b/g
Test Date	Jun. 28, 2012		

**Configuration IEEE 802.11b**

Channel	Frequency	Conducted Power (dBm)	Max. Limit (dBm)	Result
		Ant. A		
1	2412 MHz	18.72	30.00	Complies
6	2437 MHz	19.12	30.00	Complies
11	2462 MHz	18.85	30.00	Complies

**Configuration IEEE 802.11g**

Channel	Frequency	Conducted Power (dBm)	Max. Limit (dBm)	Result
		Ant. A		
1	2412 MHz	22.15	30.00	Complies
6	2437 MHz	22.25	30.00	Complies
11	2462 MHz	22.52	30.00	Complies

**Configuration IEEE 802.11a**

Channel	Frequency	Conducted Power (dBm)	Max. Limit (dBm)	Result
		Ant. B		
149	5745 MHz	20.69	30.00	Complies
157	5785 MHz	20.85	30.00	Complies
165	5825 MHz	20.96	30.00	Complies

### 4.3. Average Output Power Measurement

#### 4.3.1. Measuring Instruments and Setting

Please refer to section 5 of equipments list in this report. The following table is the setting of the power meter.

Power Meter Parameter	Setting
Bandwidth	50MHz bandwidth is greater than the EUT emission bandwidth
Detector	Average

#### 4.3.2. Test Procedures

Spectrum Parameter	Setting
RF Output Power Method	<input checked="" type="checkbox"/> ANSI C63.10 clause 6.10.2.1 (a) power meter method
RF Output Power Method	<input type="checkbox"/> ANSI C63.10 clause 6.10.2.1 (b) channel integration method
RF Output Power Method	<input type="checkbox"/> ANSI C63.10 clause 6.10.3.1 Method 1 - spectral trace averaging
RF Output Power Method	<input type="checkbox"/> ANSI C63.10 clause 6.10.3.2 Method 2 - zero-span mode with trace averaging

#### 4.3.3. Test Setup Layout

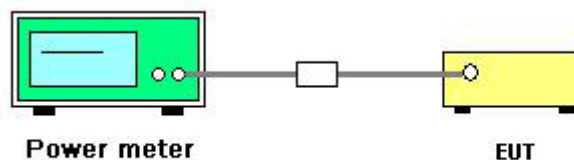

#### 4.3.4. Test Deviation

There is no deviation with the original standard.

#### 4.3.5. EUT Operation during Test

The EUT was programmed to be in continuously transmitting mode.

Note: Average output power is only for Maximum Permissible Exposure use.

#### 4.3.6. Test Result of Average Output Power

Temperature	24°C	Humidity	63%
Test Engineer	Satoshi Yang	Configurations	IEEE 802.11n
Test Date	Jun. 28, 2012		

For 2.4GHz Band

Configuration IEEE 802.11n MCS0 20MHz

Channel	Frequency	Average Conducted Power (dBm)
		Ant. A
1	2412 MHz	13.59
6	2437 MHz	13.56
11	2462 MHz	13.57

For 5GHz Band

Configuration IEEE 802.11n MCS0 20MHz

Channel	Frequency	Average Conducted Power (dBm)
		Ant. B
149	5745 MHz	12.22
157	5785 MHz	11.98
165	5825 MHz	12.35

Temperature	24°C	Humidity	63%
Test Engineer	Satoshi Yang	Configurations	IEEE 802.11a/b/g
Test Date	Jun. 28, 2012		

**Configuration IEEE 802.11b**

Channel	Frequency	Average Conducted Power (dBm)
		Ant. A
1	2412 MHz	15.43
6	2437 MHz	15.82
11	2462 MHz	15.58

**Configuration IEEE 802.11g**

Channel	Frequency	Average Conducted Power (dBm)
		Ant. A
1	2412 MHz	14.59
6	2437 MHz	14.58
11	2462 MHz	14.78

**Configuration IEEE 802.11a**

Channel	Frequency	Average Conducted Power (dBm)
		Ant. B
149	5745 MHz	13.02
157	5785 MHz	13.12
165	5825 MHz	13.25

## 4.4. Power Spectral Density Measurement

### 4.4.1. Limit

For digitally modulated systems, the power spectral density conducted from the intentional radiator to the antenna shall not be greater than 8dBm in any 3 kHz band during any time interval of continuous transmission.

### 4.4.2. Measuring Instruments and Setting

Please refer to section 5 of equipments list in this report. The following table is the setting of the spectrum analyzer.

Spectrum Parameter	Setting
Attenuation	Auto
Span Frequency	Set the analyzer span to 5-30% greater than the EBW.
RB	100 kHz
VB	300 kHz
Detector	PEAK
Trace	MAX HOLD
Sweep Time	AUTO

### 4.4.3. Test Procedures

1. Use this procedure when the maximum conducted output power in the fundamental emission is used to demonstrate compliance. The EUT must be configured to transmit continuously at full power over the measurement duration.
2. Ensure that the number of measurement points in the sweep  $\geq 2 \times \text{span}/\text{RBW}$  (use of a greater number of measurement points than this minimum requirement is recommended).
3. Use the peak marker function to determine the maximum level in any 100 kHz band segment within the fundamental EBW.
4. Scale the observed power level to an equivalent level in 3 kHz by adjusting (reducing) the measured power by a bandwidth correction factor (BWCF) where:  $\text{BWCF} = 10\log(3 \text{ kHz}/100 \text{ kHz}) = -15.2 \text{ dB}$ .
5. The resulting PSD level must be  $\leq 8 \text{ dBm}$ .

#### 4.4.4. Test Setup Layout

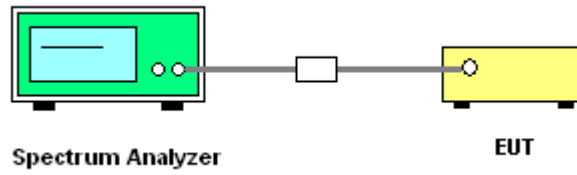

#### 4.4.5. Test Deviation

There is no deviation with the original standard.

#### 4.4.6. EUT Operation during Test

The EUT was programmed to be in continuously transmitting mode.

#### 4.4.7. Test Result of Power Spectral Density

Temperature	24°C	Humidity	63%
Test Engineer	Satoshi Yang	Configurations	IEEE 802.11n

##### For 2.4GHz Band

##### Configuration IEEE 802.11n MCS0 20MHz

Channel	Frequency	Power Density (dBm/100kHz)	BWCF factor (100KHz to 3KHz)	Power Density (dBm/3kHz)	Max. Limit (dBm/3kHz)	Result
		Ant. A				
1	2412 MHz	-0.59	-15.23	-15.82	8.00	Complies
6	2437 MHz	-0.38	-15.23	-15.61	8.00	Complies
11	2462 MHz	0.74	-15.23	-14.50	8.00	Complies

##### For 5GHz Band

##### Configuration IEEE 802.11n MCS0 20MHz

Channel	Frequency	Power Density (dBm/100kHz)	BWCF factor (100KHz to 3KHz)	Power Density (dBm/3kHz)	Max. Limit (dBm/3kHz)	Result
		Ant. B				
149	5745 MHz	1.56	-15.23	-13.67	8.00	Complies
157	5785 MHz	1.79	-15.23	-13.44	8.00	Complies
165	5825 MHz	1.95	-15.23	-13.28	8.00	Complies

Temperature	24°C	Humidity	63%
Test Engineer	Satoshi Yang	Configurations	IEEE 802.11a/b/g

**Configuration IEEE 802.11b**

Channel	Frequency	Power Density (dBm/100kHz)	BWCF factor (100kHz to 3kHz)	Power Density (dBm/3kHz)	Max. Limit (dBm/3kHz)	Result
		Ant. A				
1	2412 MHz	3.30	-15.23	-11.93	8.00	Complies
6	2437 MHz	4.29	-15.23	-10.94	8.00	Complies
11	2462 MHz	5.44	-15.23	-9.79	8.00	Complies

**Configuration IEEE 802.11g**

Channel	Frequency	Power Density (dBm/100kHz)	BWCF factor (100kHz to 3kHz)	Power Density (dBm/3kHz)	Max. Limit (dBm/3kHz)	Result
		Ant. A				
1	2412 MHz	-1.39	-15.23	-16.62	8.00	Complies
6	2437 MHz	-0.66	-15.23	-15.89	8.00	Complies
11	2462 MHz	1.25	-15.23	-13.98	8.00	Complies

**Configuration IEEE 802.11a**

Channel	Frequency	Power Density (dBm/100kHz)	BWCF factor (100kHz to 3kHz)	Power Density (dBm/3kHz)	Max. Limit (dBm/3kHz)	Result
		Ant. B				
149	5745 MHz	2.35	-15.23	-12.88	8.00	Complies
157	5785 MHz	2.68	-15.23	-12.55	8.00	Complies
165	5825 MHz	2.83	-15.23	-12.40	8.00	Complies

Note: All the test values were listed in the report.

For plots, only the channel with maximum results was shown.



Power Density Plot on Configuration IEEE 802.11n MCS0 20MHz / Ant. A / 2462 MHz

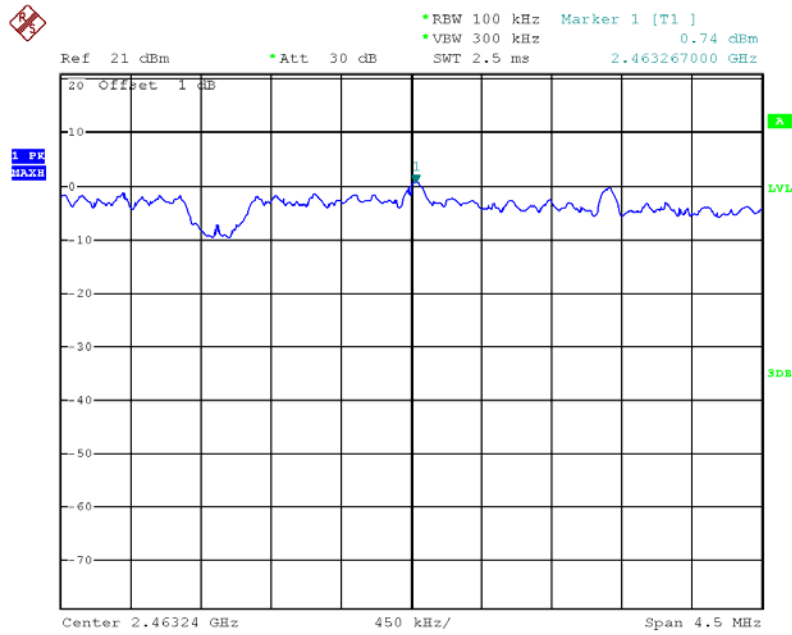

Date: 28.JUN.2012 23:01:21

Power Density Plot on Configuration IEEE 802.11n MCS0 20MHz / Ant. B / 5825 MHz

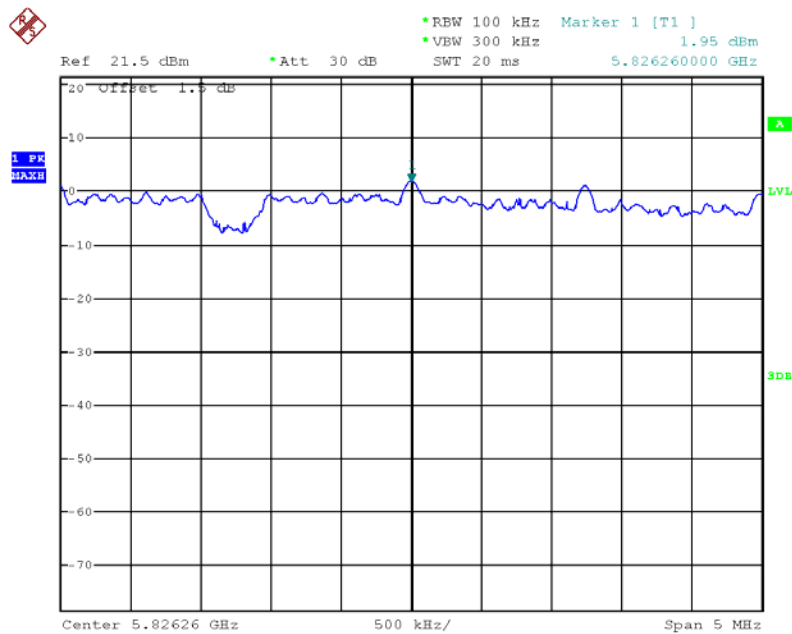

Date: 28.JUN.2012 22:39:50

Power Density Plot on Configuration IEEE 802.11b / Ant. A / 2462 MHz

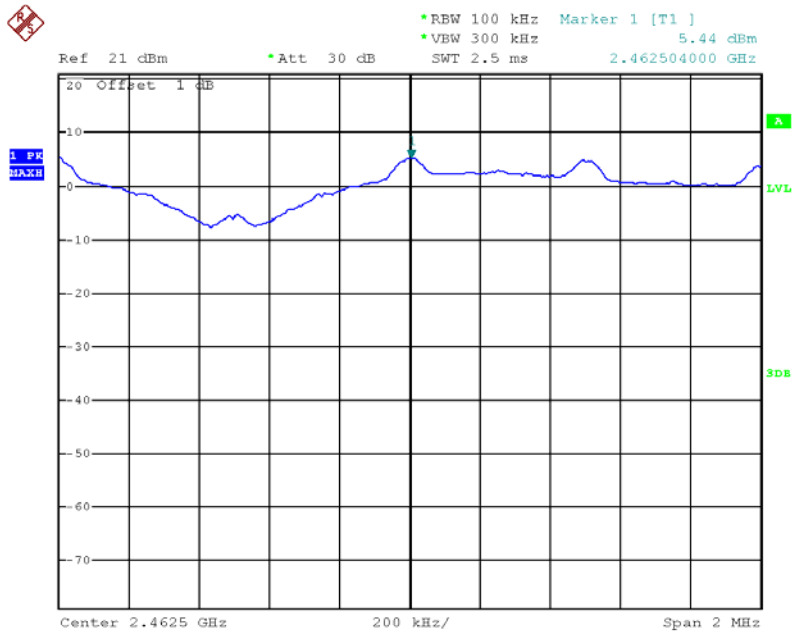

Date: 28.JUN.2012 22:51:55

Power Density Plot on Configuration IEEE 802.11g / Ant. A / 2462 MHz

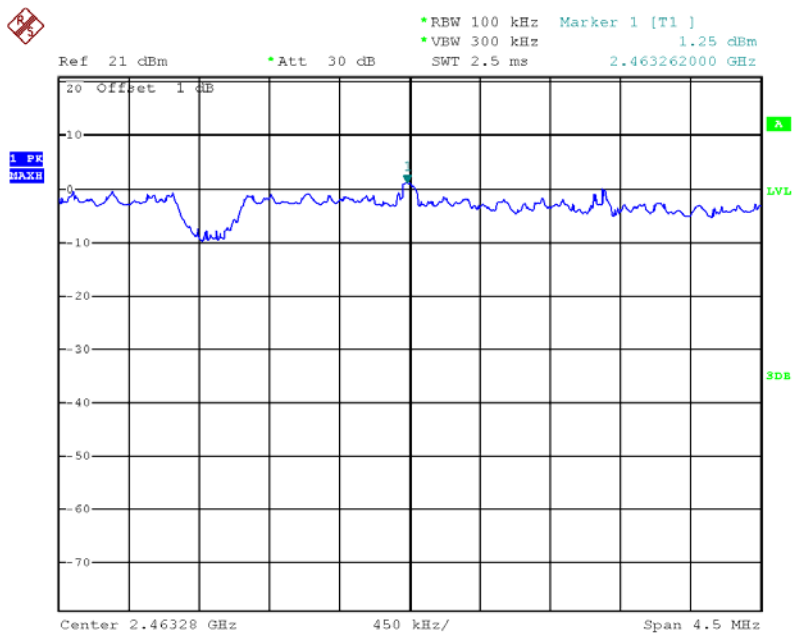

Date: 28.JUN.2012 22:56:31

### Power Density Plot on Configuration IEEE 802.11a / Ant. B / 5825 MHz

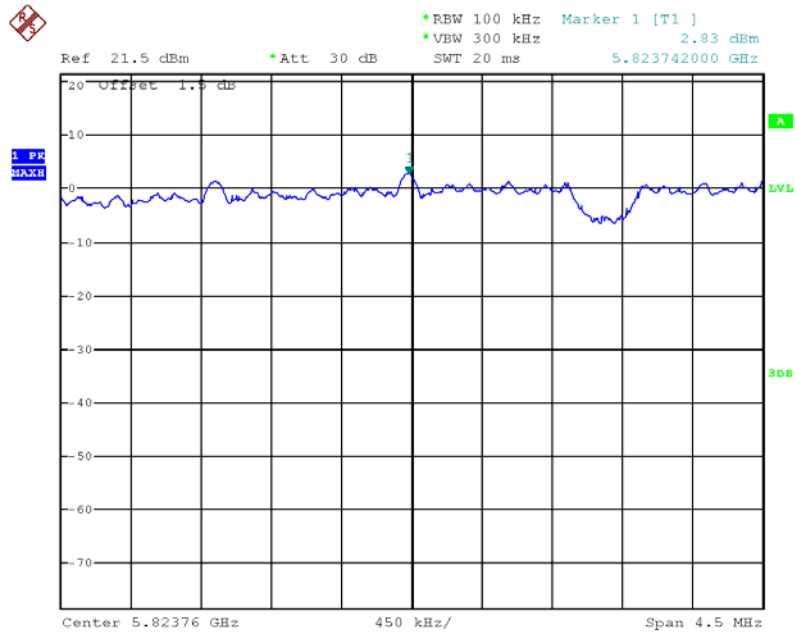

Date: 28.JUN.2012 22:44:31

## 4.5. 6dB Spectrum Bandwidth Measurement

### 4.5.1. Limit

For digital modulation systems, the minimum 6dB bandwidth shall be at least 500 kHz.

### 4.5.2. Measuring Instruments and Setting

Please refer to section 5 of equipments list in this report. The following table is the setting of the spectrum analyzer.

Spectrum Parameters	Setting
Attenuation	Auto
Span Frequency	> 6dB Bandwidth
RB	1-5 % of the emission bandwidth (EBW)
VB	$\geq 3 \times \text{RBW}$
Detector	Peak
Trace	Max Hold
Sweep Time	Auto

### 4.5.3. Test Procedures

1. The transmitter output (antenna port) was connected to the spectrum analyzer in peak hold mode.
2. Test was performed in accordance with KDB 558074 Guidance for Performing Compliance Measurements on Digital Transmission Systems (DTS) Operating Under §15.247 section 5.1.1 EBW Measurement Procedure
3. Multiple antenna systems was performed in accordance with KDB 662911 Emissions Testing of Transmitters with Multiple Outputs in the Same Band.
4. Measured the spectrum width with power higher than 6dB below carrier.

### 4.5.4. Test Setup Layout

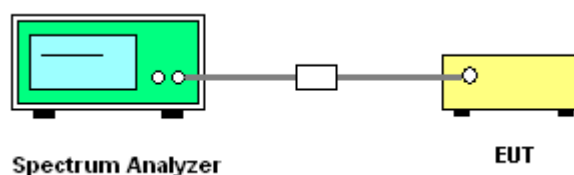

### 4.5.5. Test Deviation

There is no deviation with the original standard.

### 4.5.6. EUT Operation during Test

The EUT was programmed to be in continuously transmitting mode.

#### 4.5.7. Test Result of 6dB Spectrum Bandwidth

Temperature	24°C	Humidity	63%
Test Engineer	Satoshi Yang	Configurations	IEEE 802.11n

For 2.4GHz Band

Configuration IEEE 802.11n MCS0 20MHz / Ant. A

Channel	Frequency	6dB Bandwidth (MHz)	99% Occupied Bandwidth (MHz)	Min. Limit (kHz)	Test Result
1	2412 MHz	17.04	17.60	500	Complies
6	2437 MHz	17.28	17.60	500	Complies
11	2462 MHz	17.28	17.60	500	Complies

For 5GHz Band

Configuration IEEE 802.11n MCS0 20MHz / Ant. B

Channel	Frequency	6dB Bandwidth (MHz)	99% Occupied Bandwidth (MHz)	Min. Limit (kHz)	Test Result
149	5745 MHz	17.52	17.60	500	Complies
157	5785 MHz	17.44	17.60	500	Complies
165	5825 MHz	17.36	17.60	500	Complies

Temperature	24°C	Humidity	63%
Test Engineer	Satoshi Yang	Configurations	IEEE 802.11a/b/g

**Configuration IEEE 802.11b / Ant. A**

Channel	Frequency	6dB Bandwidth (MHz)	99% Occupied Bandwidth (MHz)	Min. Limit (kHz)	Test Result
1	2412 MHz	8.16	12.16	500	Complies
6	2437 MHz	7.68	12.16	500	Complies
11	2462 MHz	7.20	12.08	500	Complies

**Configuration IEEE 802.11g / Ant. A**

Channel	Frequency	6dB Bandwidth (MHz)	99% Occupied Bandwidth (MHz)	Min. Limit (kHz)	Test Result
1	2412 MHz	16.00	16.56	500	Complies
6	2437 MHz	15.84	16.64	500	Complies
11	2462 MHz	15.36	16.56	500	Complies

**Configuration IEEE 802.11a / Ant. B**

Channel	Frequency	6dB Bandwidth (MHz)	99% Occupied Bandwidth (MHz)	Min. Limit (kHz)	Test Result
149	5745 MHz	16.08	16.64	500	Complies
157	5785 MHz	16.00	16.72	500	Complies
165	5825 MHz	15.76	16.64	500	Complies

6 dB Bandwidth Plot on Configuration IEEE 802.11n MCS0 20MHz / Ant. A / 2412 MHz

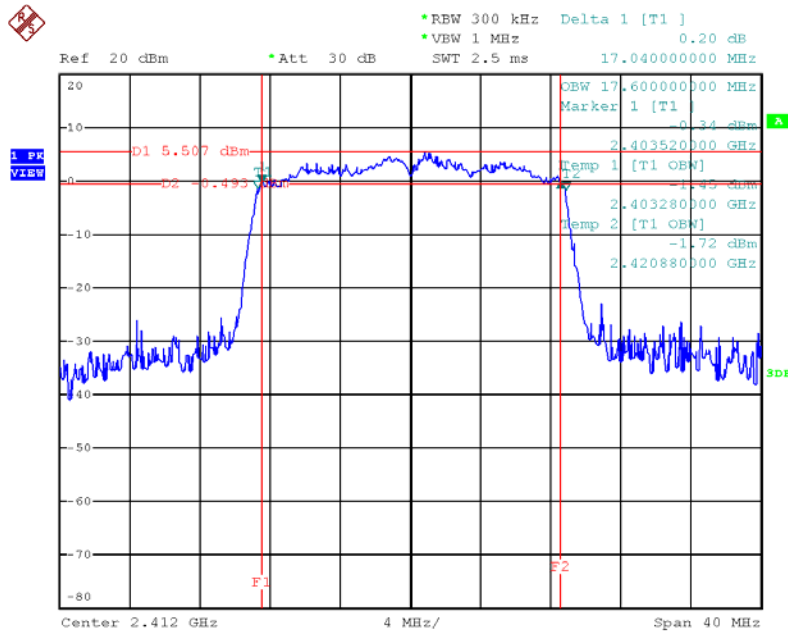

Date: 28.JUN.2012 22:01:16

6 dB Bandwidth Plot on Configuration IEEE 802.11n MCS0 20MHz / Ant. B / 5825 MHz

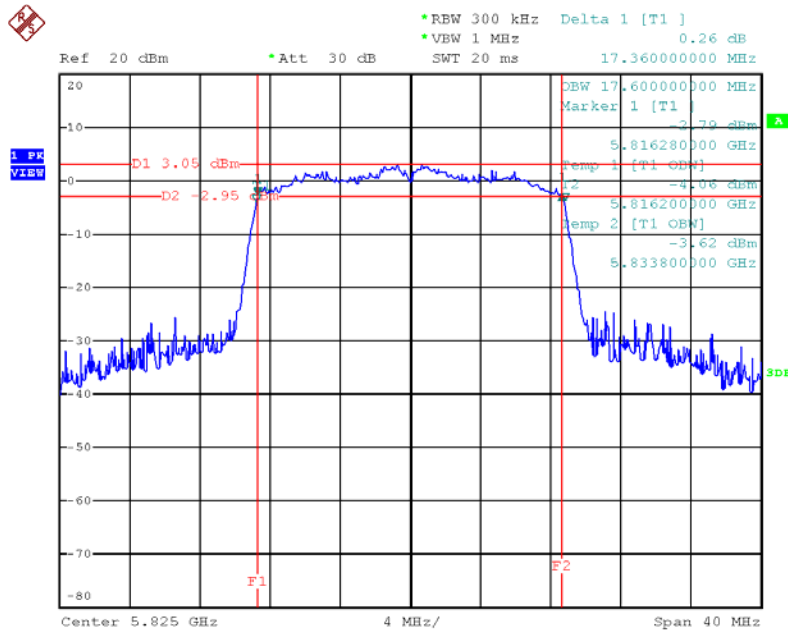

Date: 28.JUN.2012 22:17:13

6 dB Bandwidth Plot on Configuration IEEE 802.11b / Ant. A / 2462 MHz

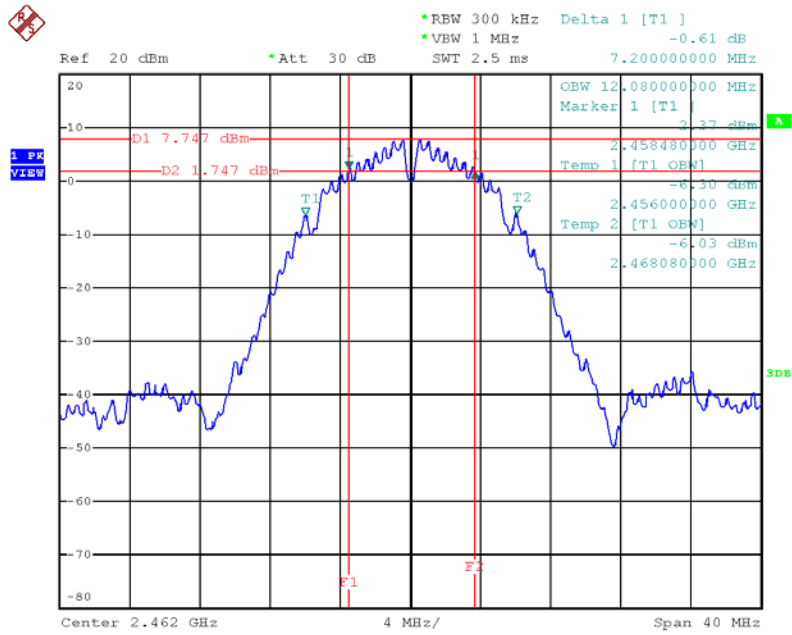

Date: 28.JUN.2012 21:53:14

6 dB Bandwidth Plot on Configuration IEEE 802.11g / Ant. A / 2462 MHz

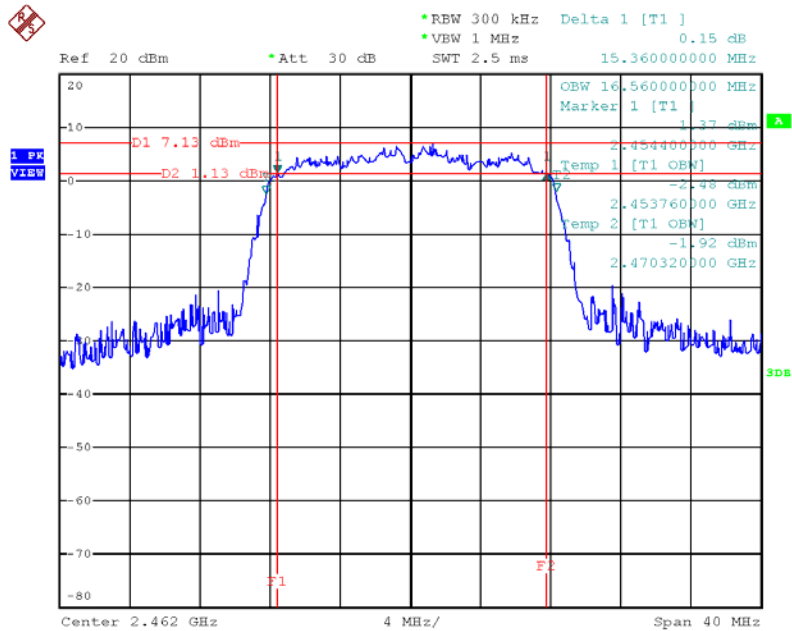

Date: 28.JUN.2012 21:57:20



6 dB Bandwidth Plot on Configuration IEEE 802.11a / Ant. B / 5825 MHz

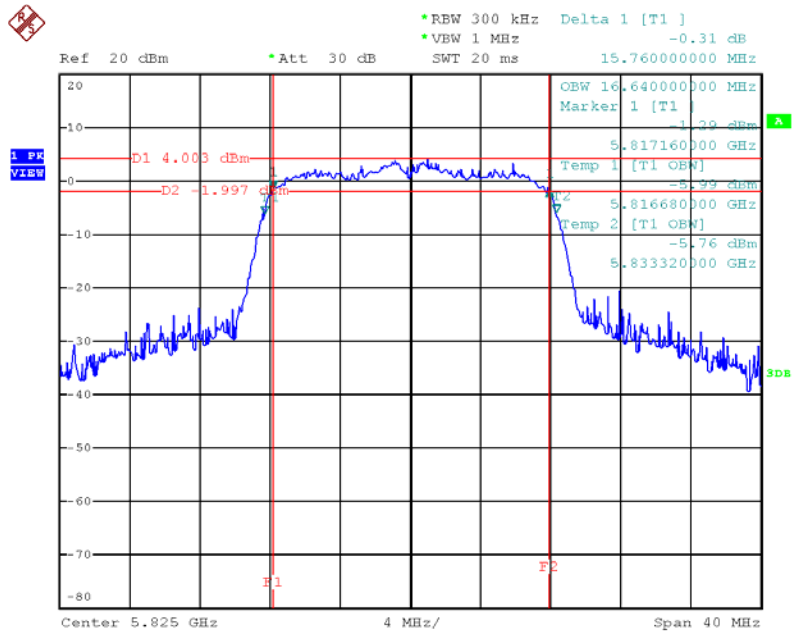

Date: 28.JUN.2012 22:12:13

## 4.6. Radiated Emissions Measurement

### 4.6.1. Limit

20dBc in any 100 kHz bandwidth outside the operating frequency band. In case the emission fall within the restricted band specified on 15.205(a), then the 15.209(a) limit in the table below has to be followed.

Frequencies (MHz)	Field Strength (micorvolts/meter)	Measurement Distance (meters)
0.009~0.490	2400/F(KHz)	300
0.490~1.705	24000/F(KHz)	30
1.705~30.0	30	30
30~88	100	3
88~216	150	3
216~960	200	3
Above 960	500	3

### 4.6.2. Measuring Instruments and Setting

Please refer to section 5 of equipments list in this report. The following table is the setting of spectrum analyzer and receiver.

Spectrum Parameter	Setting
Attenuation	Auto
Start Frequency	1000 MHz
Stop Frequency	10th carrier harmonic
RB / VB (Emission in restricted band)	1MHz / 3MHz for Peak, 1 MHz / 10Hz for Average
RB / VB (Emission in non-restricted band)	1MHz / 3MHz for peak

Receiver Parameter	Setting
Attenuation	Auto
Start ~ Stop Frequency	9kHz~150kHz / RB 200Hz for QP
Start ~ Stop Frequency	150kHz~30MHz / RB 9kHz for QP
Start ~ Stop Frequency	30MHz~1000MHz / RB 120kHz for QP

#### 4.6.3. Test Procedures

1. Configure the EUT according to ANSI C63.10. The EUT was placed on the top of the turntable 0.8 meter above ground. The phase center of the receiving antenna mounted on the top of a height-variable antenna tower was placed 3 meters far away from the turntable.
2. Power on the EUT and all the supporting units. The turntable was rotated by 360 degrees to determine the position of the highest radiation.
3. The height of the broadband receiving antenna was varied between one meter and four meters above ground to find the maximum emissions field strength of both horizontal and vertical polarization.
4. For each suspected emissions, the antenna tower was scan (from 1 M to 4 M) and then the turntable was rotated (from 0 degree to 360 degrees) to find the maximum reading.
5. Set the test-receiver system to Peak or CISPR quasi-peak Detect Function with specified bandwidth under Maximum Hold Mode.
6. For emissions above 1GHz, use 1MHz VBW and 3MHz RBW for peak reading. Then 1MHz RBW and 10Hz VBW for average reading in spectrum analyzer.
7. When the radiated emissions limits are expressed in terms of the average value of the emissions, and pulsed operation is employed, the measurement field strength shall be determined by averaging over one complete pulse train, including blanking intervals, as long as the pulse train does not exceed 0.1 seconds. As an alternative (provided the transmitter operates for longer than 0.1 seconds) or in cases where the pulse train exceeds 0.1 seconds, the measured field strength shall be determined from the average absolute voltage during a 0.1 second interval during which the field strength is at its maximum value.
8. If the emissions level of the EUT in peak mode was 3 dB lower than the average limit specified, then testing will be stopped and peak values of EUT will be reported, otherwise, the emissions which do not have 3 dB margin will be repeated one by one using the quasi-peak method for below 1GHz.
9. For testing above 1GHz, the emissions level of the EUT in peak mode was lower than average limit (that means the emissions level in peak mode also complies with the limit in average mode), then testing will be stopped and peak values of EUT will be reported, otherwise, the emissions will be measured in average mode again and reported.
10. In case the emission is lower than 30MHz, loop antenna has to be used for measurement and the recorded data should be QP measured by receiver. High – Low scan is not required in this case.

#### 4.6.4. Test Setup Layout

For radiated emissions below 1GHz

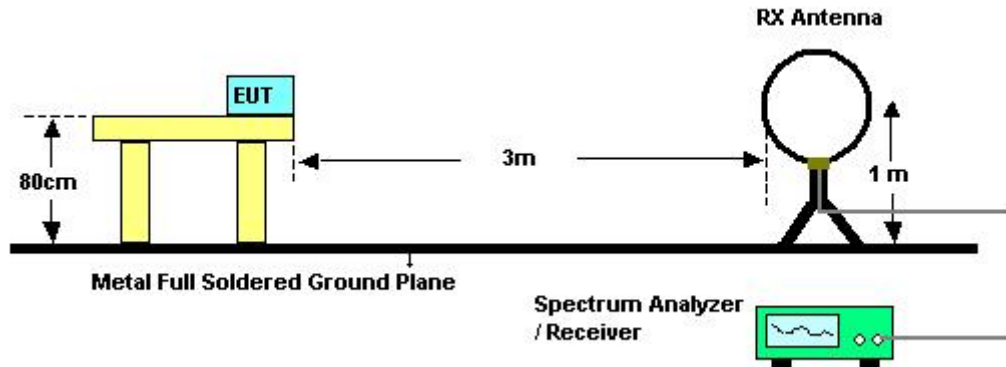

For radiated emissions above 1GHz

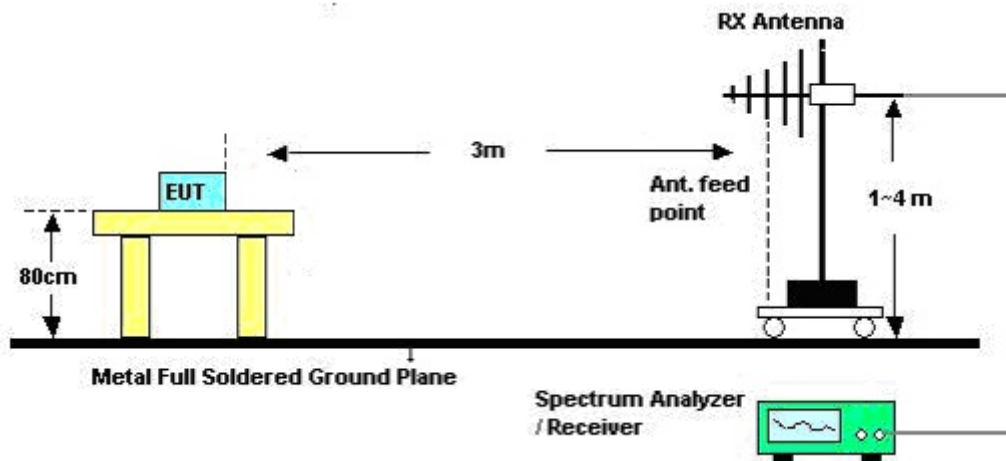

#### 4.6.5. Test Deviation

There is no deviation with the original standard.

#### 4.6.6. EUT Operation during Test

The EUT was programmed to be in continuously transmitting mode.

#### 4.6.7. Results of Radiated Emissions (9kHz~30MHz)

Temperature	21°C	Humidity	56.4%
Test Engineer	Benson Peng	Configurations	Normal Link
Test Date	Jul. 06, 2012		

Freq. (MHz)	Level (dBuV)	Over Limit (dB)	Limit Line (dBuV)	Remark
-	-	-	-	See Note

Note:

The amplitude of spurious emissions that are attenuated by more than 20 dB below the permissible value has no need to be reported.

Distance extrapolation factor =  $40 \log (\text{specific distance} / \text{test distance})$  (dB);

Limit line = specific limits (dBuV) + distance extrapolation factor.

## 4.6.8. Results of Radiated Emissions (30MHz~1GHz)

Temperature	21°C	Humidity	56.4%
Test Engineer	Benson Peng	Configurations	Normal Link

Horizontal

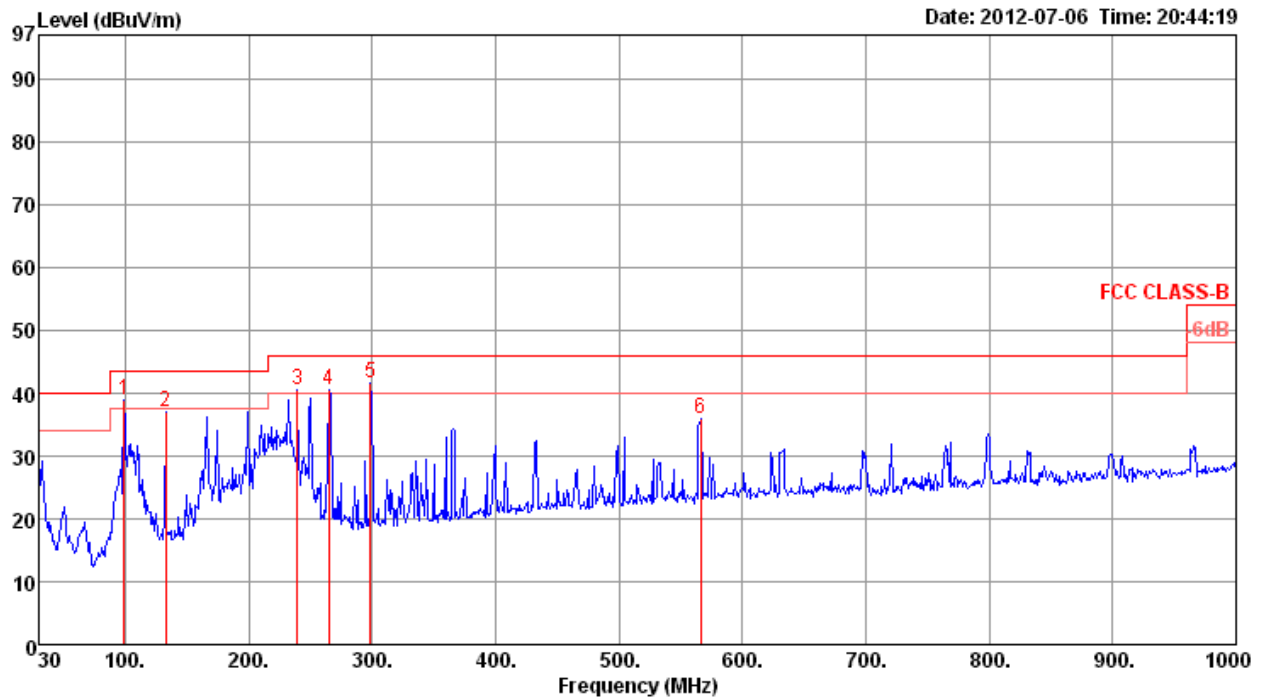

	Freq	Level	Limit	Over	Read	Cable	Antenna	Preamp	Remark	A/Pos	T/Pos	PoI/Phase
	MHz	dBuV/m	dBuV/m	dB	dBuV	dB	dB/m	dB		cm	deg	
1	98.87	38.89	43.50	-4.61	54.53	1.18	10.79	27.61	Peak	100	0	HORIZONTAL
2	132.82	37.01	43.50	-6.49	50.83	1.33	12.28	27.43	Peak	100	0	HORIZONTAL
3	239.52	40.60	46.00	-5.40	53.78	1.86	11.98	27.02	Peak	100	0	HORIZONTAL
4	264.74	40.59	46.00	-5.41	52.66	1.96	12.94	26.97	Peak	100	0	HORIZONTAL
5	298.69	41.54	46.00	-4.46	52.99	2.10	13.35	26.90	Peak	100	0	HORIZONTAL
6	566.41	35.94	46.00	-10.06	42.83	2.83	18.38	28.10	Peak	100	0	HORIZONTAL

*Vertical*

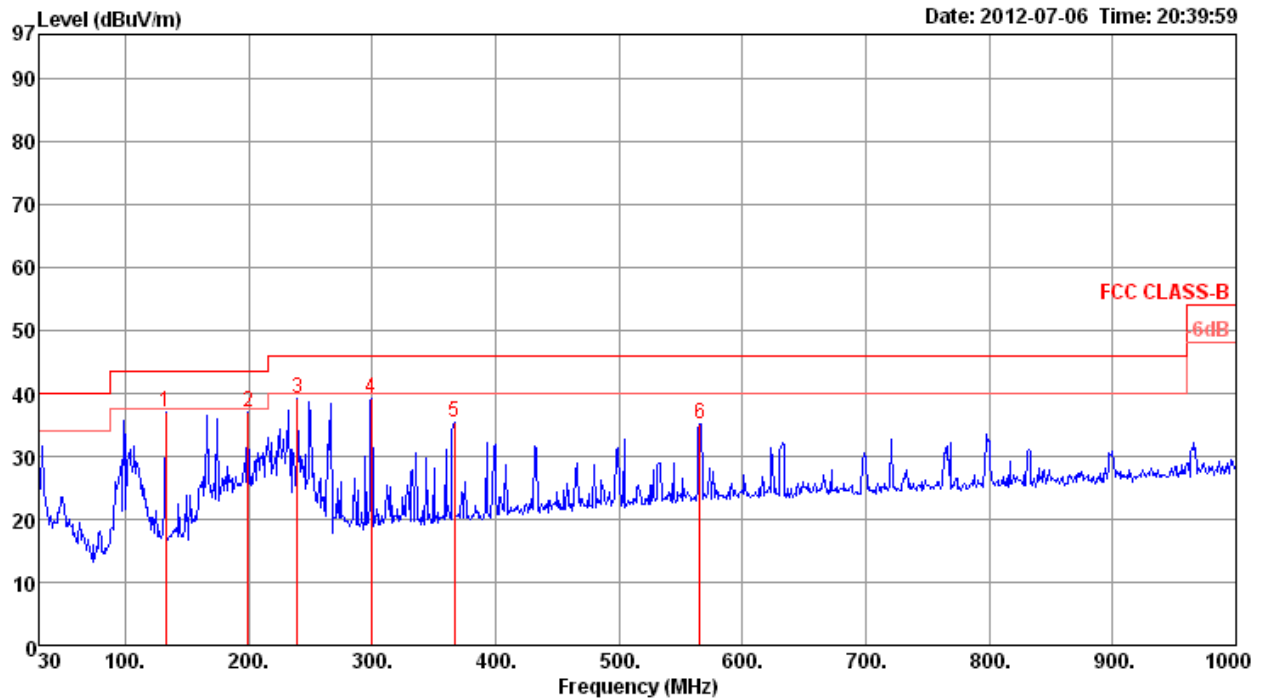

	Freq	Level	Limit	Over	Read	CableAntenna	Preamp		A/Pos	T/Pos	
	MHz	dBuV/m	dBuV/m	dB	dBuV	dB	dB/m	dB	cm	deg	Pol/Phase
1	132.82	37.02	43.50	-6.48	50.84	1.33	12.28	27.43	400	0	VERTICAL
2	199.75	37.07	43.50	-6.43	53.42	1.70	9.05	27.10	400	0	VERTICAL
3	239.52	39.09	46.00	-6.91	52.27	1.86	11.98	27.02	400	0	VERTICAL
4	299.66	39.05	46.00	-6.95	50.49	2.10	13.36	26.90	400	0	VERTICAL
5	366.59	35.27	46.00	-10.73	45.24	2.23	15.17	27.37	400	0	VERTICAL
6	565.44	35.16	46.00	-10.84	42.06	2.83	18.37	28.10	400	0	VERTICAL

Note:

The amplitude of spurious emissions that are attenuated by more than 20dB below the permissible value has no need to be reported.

Emission level (dBuV/m) = 20 log Emission level (uV/m).

Corrected Reading: Antenna Factor + Cable Loss + Read Level - Preamp Factor = Level.

4.6.9. Results for Radiated Emissions (1GHz~10<sup>th</sup> Harmonic)

Temperature	21°C	Humidity	56.4%
Test Engineer	Benson Peng	Configurations	IEEE 802.11n MCS0 20MHz Ch 1 / Ant. A
Test Date	Jun. 14, 2012		

*Horizontal*

	Freq	Level	Limit Line	Over Limit	Read Level	Cable Loss	Antenna Factor	Preamp Factor	Remark	A/Pos	T/Pos	Pol/Phase
	MHz	dBuV/m	dBuV/m	dB	dBuV	dB	dB/m	dB		cm	deg	
1	4824.26	44.38	74.00	-29.62	43.04	3.31	33.06	35.03	Peak	162	254	HORIZONTAL
2	4824.69	29.12	54.00	-24.88	27.78	3.31	33.06	35.03	Average	162	254	HORIZONTAL

*Vertical*

	Freq	Level	Limit Line	Over Limit	Read Level	Cable Loss	Antenna Factor	Preamp Factor	Remark	A/Pos	T/Pos	Pol/Phase
	MHz	dBuV/m	dBuV/m	dB	dBuV	dB	dB/m	dB		cm	deg	
1	4824.59	27.62	54.00	-26.38	26.28	3.31	33.06	35.03	Average	100	89	VERTICAL
2	4824.82	42.08	74.00	-31.92	40.74	3.31	33.06	35.03	Peak	100	89	VERTICAL



Temperature	21°C	Humidity	56.4%
Test Engineer	Benson Peng	Configurations	IEEE 802.11n MCS0 20MHz Ch 6 / Ant. A
Test Date	Jun. 14, 2012		

### Horizontal

	Freq	Level	Limit	Over	Read	CableAntenna	Preamp	Remark	A/Pos	T/Pos	Pol/Phase	
	MHz	dBuV/m	dBuV/m	dB	dBuV	dB	dB/m	dB	cm	deg		
1	4875.03	45.32	74.00	-28.68	43.86	3.33	33.16	35.03	Peak	161	74	HORIZONTAL
2	4875.07	31.68	54.00	-22.32	30.22	3.33	33.16	35.03	Average	161	74	HORIZONTAL
3	7312.60	55.93	74.00	-18.07	51.31	4.06	35.96	35.40	Peak	175	250	HORIZONTAL
4	7314.18	42.72	54.00	-11.28	38.10	4.06	35.96	35.40	Average	175	250	HORIZONTAL

### Vertical

	Freq	Level	Limit	Over	Read	CableAntenna	Preamp	Remark	A/Pos	T/Pos	Pol/Phase	
	MHz	dBuV/m	dBuV/m	dB	dBuV	dB	dB/m	dB	cm	deg		
1	4876.33	46.06	74.00	-27.94	44.60	3.33	33.16	35.03	Peak	100	90	VERTICAL
2	4876.50	31.38	54.00	-22.62	29.92	3.33	33.16	35.03	Average	100	90	VERTICAL
3	7309.90	41.45	54.00	-12.55	36.83	4.06	35.96	35.40	Average	174	173	VERTICAL
4	7310.48	54.75	74.00	-19.25	50.13	4.06	35.96	35.40	Peak	174	173	VERTICAL

Temperature	21°C	Humidity	56.4%
Test Engineer	Benson Peng	Configurations	IEEE 802.11n MCS0 20MHz Ch11 / Ant. A
Test Date	Jun. 14, 2012		

### Horizontal

	Freq	Level	Limit Line	Over Limit	Read Level	Cable Loss	Antenna Factor	Preamp Factor	Remark	A/Pos	T/Pos	Pol/Phase
	MHz	dBuV/m	dBuV/m	dB	dBuV	dB	dB/m	dB		cm	deg	
1	4922.38	31.64	54.00	-22.36	30.04	3.35	33.26	35.01	Average	177	67	HORIZONTAL
2	4923.74	45.57	74.00	-28.43	43.97	3.35	33.26	35.01	Peak	177	67	HORIZONTAL
3	7386.86	53.62	74.00	-20.38	48.87	4.06	36.09	35.40	Peak	176	253	HORIZONTAL
4	7388.98	39.37	54.00	-14.63	34.62	4.06	36.09	35.40	Average	176	253	HORIZONTAL

### Vertical

	Freq	Level	Limit Line	Over Limit	Read Level	Cable Loss	Antenna Factor	Preamp Factor	Remark	A/Pos	T/Pos	Pol/Phase
	MHz	dBuV/m	dBuV/m	dB	dBuV	dB	dB/m	dB		cm	deg	
1	4922.82	43.68	74.00	-30.32	42.08	3.35	33.26	35.01	Peak	100	90	VERTICAL
2	4923.38	30.92	54.00	-23.08	29.32	3.35	33.26	35.01	Average	100	90	VERTICAL
3	7385.10	52.34	74.00	-21.66	47.59	4.06	36.09	35.40	Peak	171	152	VERTICAL
4	7386.88	38.51	54.00	-15.49	33.76	4.06	36.09	35.40	Average	171	152	VERTICAL

Temperature	21°C	Humidity	56.4%
Test Engineer	Benson Peng	Configurations	IEEE 802.11n MCS0 20MHz CH 149 / Ant. B
Test Date	Jun. 15, 2012		

### Horizontal

	Freq	Level	Limit Line	Over Limit	Read Level	CableAntenna Loss	Antenna Factor	Preamp Factor	Remark	A/Pos	T/Pos	Pol/Phase
	MHz	dBuV/m	dBuV/m	dB	dBuV	dB	dB/m	dB		cm	deg	
1	11489.04	46.78	54.00	-7.22	38.17	5.11	38.78	35.28	Average	100	64	HORIZONTAL
2	11490.36	61.01	74.00	-12.99	52.40	5.11	38.78	35.28	Peak	100	64	HORIZONTAL

### Vertical

	Freq	Level	Limit Line	Over Limit	Read Level	CableAntenna Loss	Antenna Factor	Preamp Factor	Remark	A/Pos	T/Pos	Pol/Phase
	MHz	dBuV/m	dBuV/m	dB	dBuV	dB	dB/m	dB		cm	deg	
1	11486.60	65.03	74.00	-8.97	56.42	5.11	38.78	35.28	Peak	114	63	VERTICAL
2	11487.80	50.72	54.00	-3.28	42.11	5.11	38.78	35.28	Average	114	63	VERTICAL

Temperature	21°C	Humidity	56.4%
Test Engineer	Benson Peng	Configurations	IEEE 802.11n MCS0 20MHz CH 157 / Ant. B
Test Date	Jun. 15, 2012		

### Horizontal

	Freq	Level	Limit	Over	Read	CableAntenna	Preamp	Remark	A/Pos	T/Pos	Pol/Phase
	MHz	dBuV/m	dBuV/m	dB	dBuV	dB	dB/m	dB	cm	deg	
1	11567.68	61.10	74.00	-12.90	52.44	5.13	38.83	35.30	Peak	99	64 HORIZONTAL
2	11568.40	48.31	54.00	-5.69	39.65	5.13	38.83	35.30	Average	99	64 HORIZONTAL

### Vertical

	Freq	Level	Limit	Over	Read	CableAntenna	Preamp	Remark	A/Pos	T/Pos	Pol/Phase
	MHz	dBuV/m	dBuV/m	dB	dBuV	dB	dB/m	dB	cm	deg	
1	11568.52	51.64	54.00	-2.36	42.98	5.13	38.83	35.30	Average	156	64 VERTICAL
2	11571.84	66.24	74.00	-7.76	57.57	5.14	38.83	35.30	Peak	156	64 VERTICAL

Temperature	21°C	Humidity	56.4%
Test Engineer	Benson Peng	Configurations	IEEE 802.11n MCS0 20MHz CH 165 / Ant. B
Test Date	Jun. 15, 2012		

### Horizontal

	Freq	Level	Limit Line	Over Limit	Read Level	CableAntenna Loss	Antenna Factor	Preamp Factor	Remark	A/Pos	T/Pos	Pol/Phase
	MHz	dBuV/m	dBuV/m	dB	dBuV	dB	dB/m	dB		cm	deg	
1	11649.48	47.33	54.00	-6.67	38.61	5.16	38.86	35.30	Average	111	66	HORIZONTAL
2	11649.80	60.57	74.00	-13.43	51.85	5.16	38.86	35.30	Peak	111	66	HORIZONTAL

### Vertical

	Freq	Level	Limit Line	Over Limit	Read Level	CableAntenna Loss	Antenna Factor	Preamp Factor	Remark	A/Pos	T/Pos	Pol/Phase
	MHz	dBuV/m	dBuV/m	dB	dBuV	dB	dB/m	dB		cm	deg	
1	11647.00	50.16	54.00	-3.84	41.44	5.16	38.86	35.30	Average	122	261	VERTICAL
2	11653.04	62.92	74.00	-11.08	54.20	5.16	38.86	35.30	Peak	122	261	VERTICAL

Temperature	21°C	Humidity	56.4%
Test Engineer	Benson Peng	Configurations	IEEE 802.11b CH 1 / Ant. A
Test Date	Jun. 14, 2012		

### Horizontal

	Freq	Level	Limit Line	Over Limit	Read Level	CableAntenna Loss	Antenna Factor	Preamp Factor	Remark	A/Pos	T/Pos	Pol/Phase
	MHz	dBuV/m	dBuV/m	dB	dBuV	dB	dB/m	dB		cm	deg	
1	4823.90	48.72	74.00	-25.28	47.38	3.31	33.06	35.03	Peak	165	240	HORIZONTAL
2	4823.97	45.16	54.00	-8.84	43.82	3.31	33.06	35.03	Average	165	240	HORIZONTAL

### Vertical

	Freq	Level	Limit Line	Over Limit	Read Level	CableAntenna Loss	Antenna Factor	Preamp Factor	Remark	A/Pos	T/Pos	Pol/Phase
	MHz	dBuV/m	dBuV/m	dB	dBuV	dB	dB/m	dB		cm	deg	
1	4823.97	39.35	54.00	-14.65	38.01	3.31	33.06	35.03	Average	100	321	VERTICAL
2	4824.10	44.77	74.00	-29.23	43.43	3.31	33.06	35.03	Peak	100	321	VERTICAL

Temperature	21°C	Humidity	56.4%
Test Engineer	Benson Peng	Configurations	IEEE 802.11b CH 6 / Ant. A
Test Date	Jun. 14, 2012		

### Horizontal

	Freq	Level	Limit	Over	Read	Cable	Antenna	Preamp	Remark	A/Pos	T/Pos	Pol/Phase
	MHz	dBuV/m	dBuV/m	dB	dBuV	Loss	Factor	Factor		cm	deg	
1	4874.00	46.21	54.00	-7.79	44.75	3.33	33.16	35.03	Average	144	57	HORIZONTAL
2	4874.12	49.63	74.00	-24.37	48.17	3.33	33.16	35.03	Peak	144	57	HORIZONTAL
3	7311.72	48.55	54.00	-5.45	43.93	4.06	35.96	35.40	Average	152	277	HORIZONTAL
4	7311.90	54.31	74.00	-19.69	49.69	4.06	35.96	35.40	Peak	152	277	HORIZONTAL

### Vertical

	Freq	Level	Limit	Over	Read	Cable	Antenna	Preamp	Remark	A/Pos	T/Pos	Pol/Phase
	MHz	dBuV/m	dBuV/m	dB	dBuV	Loss	Factor	Factor		cm	deg	
1	4873.99	44.68	54.00	-9.32	43.22	3.33	33.16	35.03	Average	100	91	VERTICAL
2	4874.02	48.26	74.00	-25.74	46.80	3.33	33.16	35.03	Peak	100	91	VERTICAL
3	7309.94	54.59	74.00	-19.41	49.97	4.06	35.96	35.40	Peak	172	175	VERTICAL
4	7310.24	49.03	54.00	-4.97	44.41	4.06	35.96	35.40	Average	172	175	VERTICAL

Temperature	21°C	Humidity	56.4%
Test Engineer	Benson Peng	Configurations	IEEE 802.11b CH 11 / Ant. A
Test Date	Jun. 14, 2012		

### Horizontal

	Freq	Level	Limit	Over	Read	CableAntenna	Preamp		A/Pos	T/Pos	Pol/Phase
	MHz	dBuV/m	dBuV/m	dB	dBuV	dB	dB/m	dB	cm	deg	
1	4923.99	49.21	74.00	-24.79	47.61	3.35	33.26	35.01	Peak	169	70 HORIZONTAL
2	4924.00	46.34	54.00	-7.66	44.74	3.35	33.26	35.01	Average	169	70 HORIZONTAL
3	7386.68	48.71	54.00	-5.29	43.96	4.06	36.09	35.40	Average	137	266 HORIZONTAL
4	7386.94	54.40	74.00	-19.60	49.65	4.06	36.09	35.40	Peak	137	266 HORIZONTAL

### Vertical

	Freq	Level	Limit	Over	Read	CableAntenna	Preamp		A/Pos	T/Pos	Pol/Phase
	MHz	dBuV/m	dBuV/m	dB	dBuV	dB	dB/m	dB	cm	deg	
1	4923.95	50.64	74.00	-23.36	49.04	3.35	33.26	35.01	Peak	102	31 VERTICAL
2	4924.03	47.63	54.00	-6.37	46.03	3.35	33.26	35.01	Average	102	31 VERTICAL
3	7386.66	47.59	54.00	-6.41	42.84	4.06	36.09	35.40	Average	158	183 VERTICAL
4	7386.98	53.62	74.00	-20.38	48.87	4.06	36.09	35.40	Peak	158	183 VERTICAL



Temperature	21°C	Humidity	56.4%
Test Engineer	Benson Peng	Configurations	IEEE 802.11g CH 1 / Ant. A
Test Date	Jun. 14, 2012		

### Horizontal

	Freq	Level	Limit	Over	Read	CableAntenna	Preamp	Remark	A/Pos	T/Pos	Pol/Phase	
	MHz	dBuV/m	dBuV/m	dB	dBuV	dB	dB/m	dB	cm	deg		
1	4824.92	30.81	54.00	-23.19	29.47	3.31	33.06	35.03	Average	163	253	HORIZONTAL
2	4828.40	43.76	74.00	-30.24	42.42	3.31	33.06	35.03	Peak	163	253	HORIZONTAL

### Vertical

	Freq	Level	Limit	Over	Read	CableAntenna	Preamp	Remark	A/Pos	T/Pos	Pol/Phase	
	MHz	dBuV/m	dBuV/m	dB	dBuV	dB	dB/m	dB	cm	deg		
1	4824.70	28.80	54.00	-25.20	27.46	3.31	33.06	35.03	Average	100	90	VERTICAL
2	4825.96	41.48	74.00	-32.52	40.14	3.31	33.06	35.03	Peak	100	90	VERTICAL

Temperature	21°C	Humidity	56.4%
Test Engineer	Benson Peng	Configurations	IEEE 802.11g CH 6 / Ant. A
Test Date	Jun. 14, 2012		

### Horizontal

	Freq	Level	Limit	Over	Read	CableAntenna	Preamp	Remark	A/Pos	T/Pos	Pol/Phase	
	MHz	dBuV/m	dBuV/m	dB	dBuV	dB	dB/m	dB	cm	deg		
1	4873.90	47.40	74.00	-26.60	45.94	3.33	33.16	35.03	Peak	162	240	HORIZONTAL
2	4875.18	33.66	54.00	-20.34	32.20	3.33	33.16	35.03	Average	162	240	HORIZONTAL
3	7311.24	43.57	54.00	-10.43	38.95	4.06	35.96	35.40	Average	171	256	HORIZONTAL
4	7312.98	57.57	74.00	-16.43	52.95	4.06	35.96	35.40	Peak	171	256	HORIZONTAL

### Vertical

	Freq	Level	Limit	Over	Read	CableAntenna	Preamp	Remark	A/Pos	T/Pos	Pol/Phase	
	MHz	dBuV/m	dBuV/m	dB	dBuV	dB	dB/m	dB	cm	deg		
1	4876.76	32.55	54.00	-21.45	31.09	3.33	33.16	35.03	Average	100	90	VERTICAL
2	4876.88	46.22	74.00	-27.78	44.76	3.33	33.16	35.03	Peak	100	90	VERTICAL
3	7306.30	42.06	54.00	-11.94	37.48	4.06	35.92	35.40	Average	169	175	VERTICAL
4	7312.24	56.88	74.00	-17.12	52.26	4.06	35.96	35.40	Peak	169	175	VERTICAL



Temperature	21°C	Humidity	56.4%
Test Engineer	Benson Peng	Configurations	IEEE 802.11g CH 11 / Ant. A
Test Date	Jun. 14, 2012		

*Horizontal*

	Freq	Level	Limit Line	Over Limit	Read Level	Cable Loss	Antenna Factor	Preamp Factor	Remark	A/Pos	T/Pos	Pol/Phase
	MHz	dBuV/m	dBuV/m	dB	dBuV	dB	dB/m	dB		cm	deg	
1	4923.06	45.34	74.00	-28.66	43.74	3.35	33.26	35.01	Peak	155	241	HORIZONTAL
2	4925.24	31.24	54.00	-22.76	29.64	3.35	33.26	35.01	Average	155	241	HORIZONTAL
3	7383.32	53.34	74.00	-20.66	48.59	4.06	36.09	35.40	Peak	184	253	HORIZONTAL
4	7384.70	39.30	54.00	-14.70	34.55	4.06	36.09	35.40	Average	184	253	HORIZONTAL

*Vertical*

	Freq	Level	Limit Line	Over Limit	Read Level	Cable Loss	Antenna Factor	Preamp Factor	Remark	A/Pos	T/Pos	Pol/Phase
	MHz	dBuV/m	dBuV/m	dB	dBuV	dB	dB/m	dB		cm	deg	
1	4924.56	31.82	54.00	-22.18	30.22	3.35	33.26	35.01	Average	100	90	VERTICAL
2	4925.30	44.96	74.00	-29.04	43.36	3.35	33.26	35.01	Peak	100	90	VERTICAL
3	7386.66	52.10	74.00	-21.90	47.35	4.06	36.09	35.40	Peak	173	179	VERTICAL
4	7387.12	38.51	54.00	-15.49	33.76	4.06	36.09	35.40	Average	173	179	VERTICAL

Temperature	21°C	Humidity	56.4%
Test Engineer	Benson Peng	Configurations	IEEE 802.11a CH 149 / Ant. B
Test Date	Jun. 15, 2012		

### Horizontal

	Freq	Level	Limit Line	Over Limit	Read Level	CableAntenna Loss	Antenna Factor	Preamp Factor	Remark	A/Pos	T/Pos	Pol/Phase
	MHz	dBuV/m	dBuV/m	dB	dBuV	dB	dB/m	dB		cm	deg	
1	11487.32	66.24	74.00	-7.76	57.63	5.11	38.78	35.28	Peak	109	66	HORIZONTAL
2	11489.44	51.46	54.00	-2.54	42.85	5.11	38.78	35.28	Average	109	66	HORIZONTAL

### Vertical

	Freq	Level	Limit Line	Over Limit	Read Level	CableAntenna Loss	Antenna Factor	Preamp Factor	Remark	A/Pos	T/Pos	Pol/Phase
	MHz	dBuV/m	dBuV/m	dB	dBuV	dB	dB/m	dB		cm	deg	
1	11488.20	65.01	74.00	-8.99	56.40	5.11	38.78	35.28	Peak	131	296	VERTICAL
2	11488.72	51.19	54.00	-2.81	42.58	5.11	38.78	35.28	Average	131	296	VERTICAL

Temperature	21°C	Humidity	56.4%
Test Engineer	Benson Peng	Configurations	IEEE 802.11a CH 157 / Ant. B
Test Date	Jun. 15, 2012		

### Horizontal

	Freq	Level	Limit	Over	Read	Cable	Antenna	Preamp	Remark	A/Pos	T/Pos	Pol/Phase
	MHz	dBuV/m	dBuV/m	dB	dBuV	dB	dB/m	dB		cm	deg	
1	11568.84	51.14	54.00	-2.86	42.48	5.13	38.83	35.30	Average	116	67	HORIZONTAL
2	11569.16	65.23	74.00	-8.77	56.57	5.13	38.83	35.30	Peak	116	67	HORIZONTAL

### Vertical

	Freq	Level	Limit	Over	Read	Cable	Antenna	Preamp	Remark	A/Pos	T/Pos	Pol/Phase
	MHz	dBuV/m	dBuV/m	dB	dBuV	dB	dB/m	dB		cm	deg	
1	11569.48	50.22	54.00	-3.78	41.56	5.13	38.83	35.30	Average	134	294	VERTICAL
2	11569.96	63.75	74.00	-10.25	55.08	5.14	38.83	35.30	Peak	134	294	VERTICAL

Temperature	21°C	Humidity	56.4%
Test Engineer	Benson Peng	Configurations	IEEE 802.11a CH 165 / Ant. B
Test Date	Jun. 15, 2012		

### Horizontal

	Freq	Level	Limit	Over	Read	CableAntenna	Preamp	Remark	A/Pos	T/Pos	Pol/Phase	
	MHz	dBuV/m	dBuV/m	dB	dBuV	dB	dB/m	dB	cm	deg		
1	11648.64	50.51	54.00	-3.49	41.79	5.16	38.86	35.30	Average	114	62	HORIZONTAL
2	11655.16	64.33	74.00	-9.67	55.61	5.16	38.86	35.30	Peak	114	62	HORIZONTAL

### Vertical

	Freq	Level	Limit	Over	Read	CableAntenna	Preamp	Remark	A/Pos	T/Pos	Pol/Phase	
	MHz	dBuV/m	dBuV/m	dB	dBuV	dB	dB/m	dB	cm	deg		
1	11650.08	50.15	54.00	-3.85	41.43	5.16	38.86	35.30	Average	140	288	VERTICAL
2	11650.88	64.31	74.00	-9.69	55.59	5.16	38.86	35.30	Peak	140	288	VERTICAL

## 4.7. Band Edge Emissions Measurement

### 4.7.1. Limit

20dBc in any 100 kHz bandwidth outside the operating frequency band. In case the emission fall within the restricted band specified on 15.205(a), then the 15.209(a) limit in the table below has to be followed.

Frequencies (MHz)	Field Strength (micorvolts/meter)	Measurement Distance (meters)
0.009~0.490	2400/F(KHz)	300
0.490~1.705	24000/F(KHz)	30
1.705~30.0	30	30
30~88	100	3
88~216	150	3
216~960	200	3
Above 960	500	3

### 4.7.2. Measuring Instruments and Setting

Please refer to section 5 of equipments list in this report. The following table is the setting of the spectrum analyzer.

Spectrum Parameter	Setting
Attenuation	Auto
Span Frequency	100 MHz
RB / VB (Emission in restricted band)	1MHz / 3MHz for Peak, 1 MHz / 10Hz for Average
RB / VB (Emission in non-restricted band)	100 KHz / 300 KHz for Peak

### 4.7.3. Test Procedures

The test procedure is the same as section 4.5.3, only the frequency range investigated is limited to 100MHz around bandedges.

### 4.7.4. Test Setup Layout

This test setup layout is the same as that shown in section 4.5.4.

### 4.7.5. Test Deviation

There is no deviation with the original standard.

### 4.7.6. EUT Operation during Test

The EUT was programmed to be in continuously transmitting mode.

#### 4.7.7. Test Result of Band Edge and Fundamental Emissions

Temperature	21°C	Humidity	56.4%
Test Engineer	Benson Peng	Configurations	IEEE 802.11n MCS0 20MHz Ch 1, 6, 11 / Ant. A
Test date	Jun. 14, 2012		

##### Channel 1

	Freq	Level	Limit Line	Over Limit	Read Level	CableAntenna Loss	Antenna Factor	Preamp Factor	Remark	A/Pos	T/Pos	Pol/Phase
	MHz	dBuV/m	dBuV/m	dB	dBuV	dB	dB/m	dB		cm	deg	
1	2389.60	72.34	74.00	-1.66	41.96	2.21	28.17	0.00	Peak	100	191	HORIZONTAL
2	2390.00	53.62	54.00	-0.38	23.23	2.22	28.17	0.00	Average	100	191	HORIZONTAL
3	2411.00				61.20	2.22	28.21	0.00	Average	100	191	HORIZONTAL
4	2412.60				73.31	2.22	28.21	0.00	Peak	100	191	HORIZONTAL

Item 3, 4 are the fundamental frequency at 2412 MHz.

##### Channel 6

	Freq	Level	Limit Line	Over Limit	Read Level	CableAntenna Loss	Antenna Factor	Preamp Factor	Remark	A/Pos	T/Pos	Pol/Phase
	MHz	dBuV/m	dBuV/m	dB	dBuV	dB	dB/m	dB		cm	deg	
1	2389.80	57.86	74.00	-16.14	27.47	2.22	28.17	0.00	Peak	100	127	VERTICAL
2	2390.00	44.92	54.00	-9.08	14.53	2.22	28.17	0.00	Average	100	127	VERTICAL
3	2436.20				62.69	2.23	28.29	0.00	Average	100	127	VERTICAL
4	2438.20				74.97	2.23	28.29	0.00	Peak	100	127	VERTICAL
5	2483.50	45.80	54.00	-8.20	15.17	2.26	28.37	0.00	Average	100	127	VERTICAL
6	2483.70	58.45	74.00	-15.55	27.82	2.26	28.37	0.00	Peak	100	127	VERTICAL

Item 3, 4 are the fundamental frequency at 2437MHz.

##### Channel 11

	Freq	Level	Limit Line	Over Limit	Read Level	CableAntenna Loss	Antenna Factor	Preamp Factor	Remark	A/Pos	T/Pos	Pol/Phase
	MHz	dBuV/m	dBuV/m	dB	dBuV	dB	dB/m	dB		cm	deg	
1	2464.20				73.47	2.24	28.33	0.00	Peak	100	172	VERTICAL
2	2467.60				61.56	2.26	28.33	0.00	Average	100	172	VERTICAL
3	2483.50	53.75	54.00	-0.25	23.12	2.26	28.37	0.00	Average	100	172	VERTICAL
4	2483.90	72.84	74.00	-1.16	42.21	2.26	28.37	0.00	Peak	100	172	VERTICAL

Item 1, 2 are the fundamental frequency at 2462 MHz.



Temperature	21°C	Humidity	56.4%
Test Engineer	Benson Peng	Configurations	IEEE 802.11b CH 1, 6, 11 / Ant. A
Test Date	Jun. 14, 2012		

**Channel 1**

	Freq	Level	Limit	Over	Read	CableAntenna	Preamp	Remark	A/Pos	T/Pos	Pol/Phase
	MHz	dBuV/m	dBuV/m	dB	dBuV	dB	dB/m	dB	cm	deg	
1	2385.00	58.98	74.00	-15.02	28.60	2.21	28.17	0.00	Peak	100	189 HORIZONTAL
2	2385.20	51.19	54.00	-2.81	20.81	2.21	28.17	0.00	Average	100	189 HORIZONTAL
3	2411.00				74.14	2.22	28.21	0.00	Peak	100	189 HORIZONTAL
4	2411.20				70.27	2.22	28.21	0.00	Average	100	189 HORIZONTAL

Item 3, 4 are the fundamental frequency at 2412 MHz.

**Channel 6**

	Freq	Level	Limit	Over	Read	CableAntenna	Preamp	Remark	A/Pos	T/Pos	Pol/Phase
	MHz	dBuV/m	dBuV/m	dB	dBuV	dB	dB/m	dB	cm	deg	
1	2390.00	42.85	54.00	-11.15	12.46	2.22	28.17	0.00	Average	100	259 HORIZONTAL
2	2390.00	54.23	74.00	-19.77	23.84	2.22	28.17	0.00	Peak	100	259 HORIZONTAL
3	2436.20				67.53	2.23	28.29	0.00	Average	100	259 HORIZONTAL
4	2436.20				71.35	2.23	28.29	0.00	Peak	100	259 HORIZONTAL
5	2483.50	43.10	54.00	-10.90	12.46	2.26	28.38	0.00	Average	100	259 HORIZONTAL
6	2484.30	54.80	74.00	-19.20	24.16	2.26	28.38	0.00	Peak	100	259 HORIZONTAL

Item 3, 4 are the fundamental frequency at 2437 MHz.

**Channel 11**

	Freq	Level	Limit	Over	Read	CableAntenna	Preamp	Remark	A/Pos	T/Pos	Pol/Phase
	MHz	dBuV/m	dBuV/m	dB	dBuV	dB	dB/m	dB	cm	deg	
1	2462.60				71.41	2.24	28.33	0.00	Average	100	171 VERTICAL
2	2463.00				75.50	2.24	28.33	0.00	Peak	100	171 VERTICAL
3	2488.10	47.93	54.00	-6.07	17.26	2.26	28.41	0.00	Average	100	171 VERTICAL
4	2488.10	58.38	74.00	-15.62	27.71	2.26	28.41	0.00	Peak	100	171 VERTICAL

Item 1, 2 are the fundamental frequency at 2462 MHz.

Temperature	21°C	Humidity	56.4%
Test Engineer	Benson Peng	Configurations	IEEE 802.11g CH 1, 6, 11 / Ant. A
Test Date	Jun. 14, 2012		

**Channel 1**

	Freq	Level	Limit	Over	Read	CableAntenna	Preamp	Remark	A/Pos	T/Pos	Pol/Phase
	MHz	dBuV/m	dBuV/m	dB	dBuV	dB	dB/m	dB	cm	deg	
1	2390.00	53.57	54.00	-0.43	23.18	2.22	28.17	0.00	Average	103	175 VERTICAL
2	2390.00	72.87	74.00	-1.13	42.48	2.22	28.17	0.00	Peak	103	175 VERTICAL
3	2411.00				63.90	2.22	28.21	0.00	Average	103	175 VERTICAL
4	2411.80				76.53	2.22	28.21	0.00	Peak	103	175 VERTICAL

Item 3, 4 are the fundamental frequency at 2412 MHz.

**Channel 6**

	Freq	Level	Limit	Over	Read	CableAntenna	Preamp	Remark	A/Pos	T/Pos	Pol/Phase
	MHz	dBuV/m	dBuV/m	dB	dBuV	dB	dB/m	dB	cm	deg	
1	2390.00	44.07	54.00	-9.93	13.68	2.22	28.17	0.00	Average	100	259 HORIZONTAL
2	2390.00	56.08	74.00	-17.92	25.69	2.22	28.17	0.00	Peak	100	259 HORIZONTAL
3	2437.80				60.33	2.23	28.29	0.00	Average	100	259 HORIZONTAL
4	2438.40				72.09	2.23	28.29	0.00	Peak	100	259 HORIZONTAL
5	2483.50	45.15	54.00	-8.85	14.51	2.26	28.38	0.00	Average	100	259 HORIZONTAL
6	2483.50	57.36	74.00	-16.64	26.72	2.26	28.38	0.00	Peak	100	259 HORIZONTAL

Item 3, 4 are the fundamental frequency at 2437 MHz.

**Channel 11**

	Freq	Level	Limit	Over	Read	CableAntenna	Preamp	Remark	A/Pos	T/Pos	Pol/Phase
	MHz	dBuV/m	dBuV/m	dB	dBuV	dB	dB/m	dB	cm	deg	
1	2466.80				75.75	2.26	28.33	0.00	Peak	100	172 VERTICAL
2	2467.80				62.87	2.26	28.33	0.00	Average	100	172 VERTICAL
3	2483.50	53.70	54.00	-0.30	23.07	2.26	28.37	0.00	Average	100	172 VERTICAL
4	2483.50	73.19	74.00	-0.81	42.56	2.26	28.37	0.00	Peak	100	172 VERTICAL

Item 1, 2 are the fundamental frequency at 2462 MHz.

For Emission not in Restricted Band

Plot on Configuration IEEE 802.11n MCS0 20MHz / Ant. A / 2412 MHz

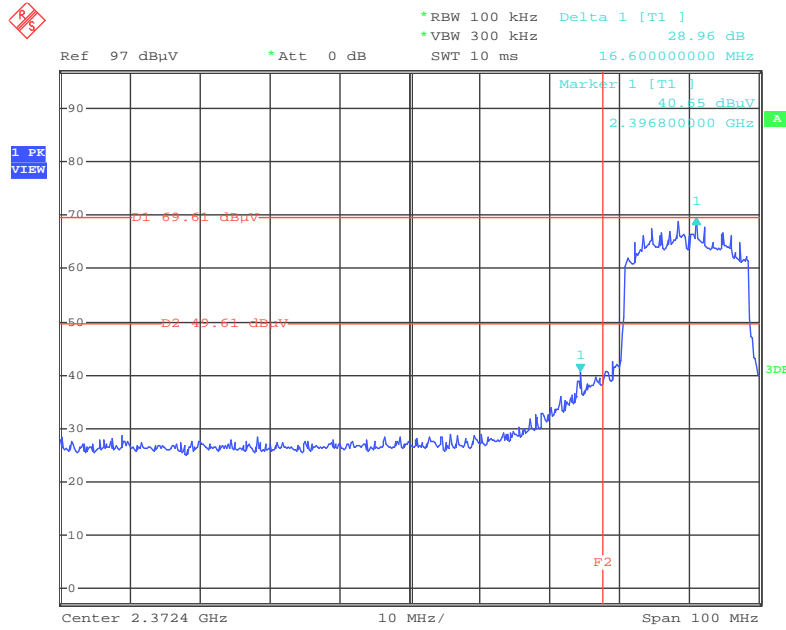

Date: 14.JUN.2012 17:48:22

Plot on Configuration IEEE 802.11n MCS0 20MHz / Ant. A / 2462 MHz

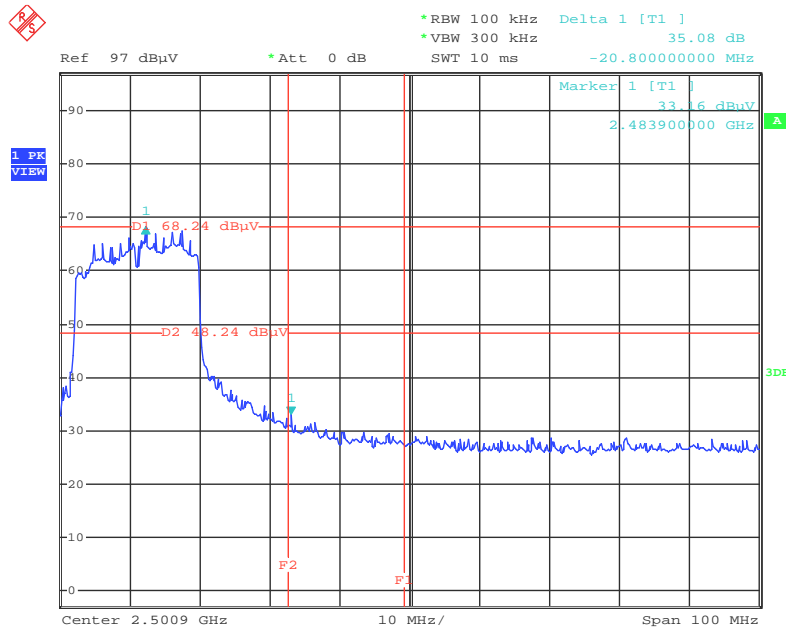

Date: 14.JUN.2012 17:31:59

Plot on Configuration IEEE 802.11n MCS0 20MHz / Ant. B / 5745 MHz

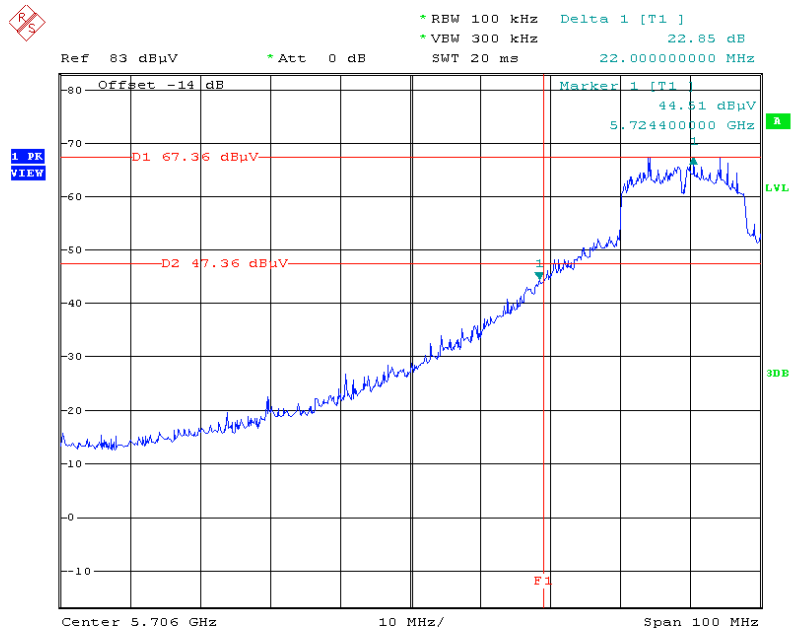

Date: 15.JUN.2012 14:58:53

Plot on Configuration IEEE 802.11n MCS0 20MHz / Ant. B / 5825 MHz

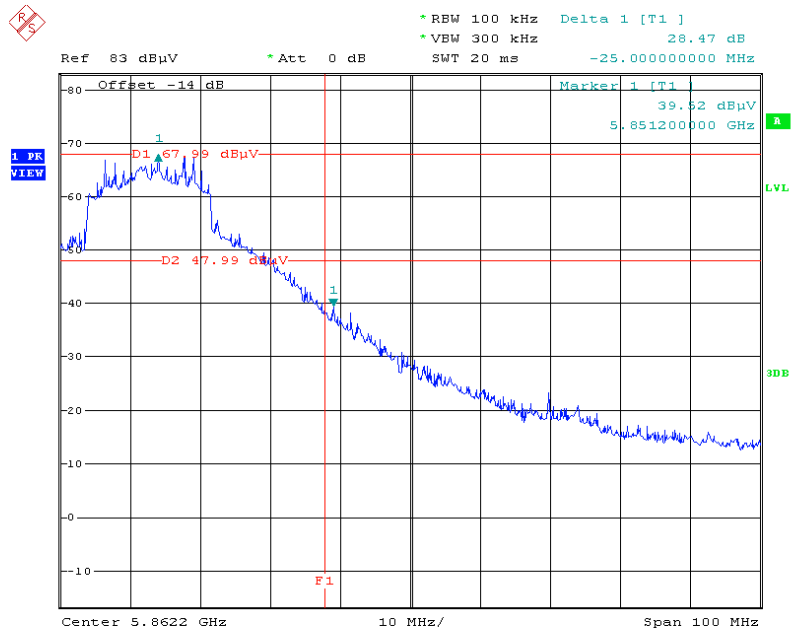

Date: 15.JUN.2012 14:55:08

Plot on Configuration IEEE 802.11b / Ant. A / 2412 MHz

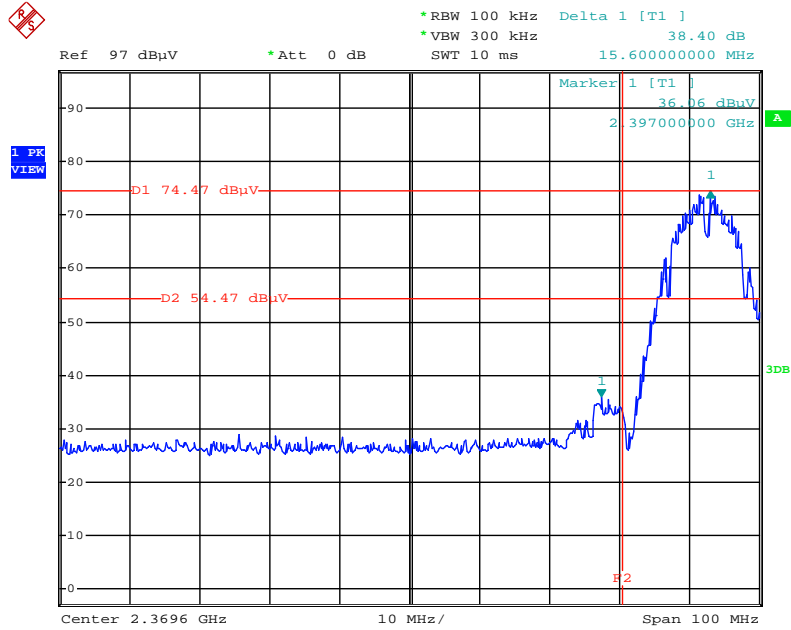

Date: 14.JUN.2012 16:16:36

Plot on Configuration IEEE 802.11b / Ant. A / 2462 MHz

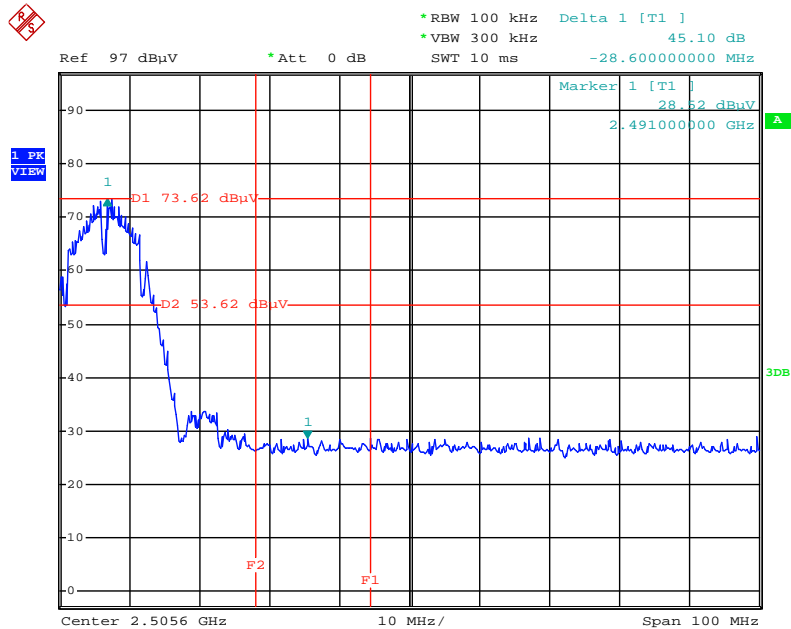

Date: 14.JUN.2012 15:53:55

Plot on Configuration IEEE 802.11g / Ant. A / 2412 MHz

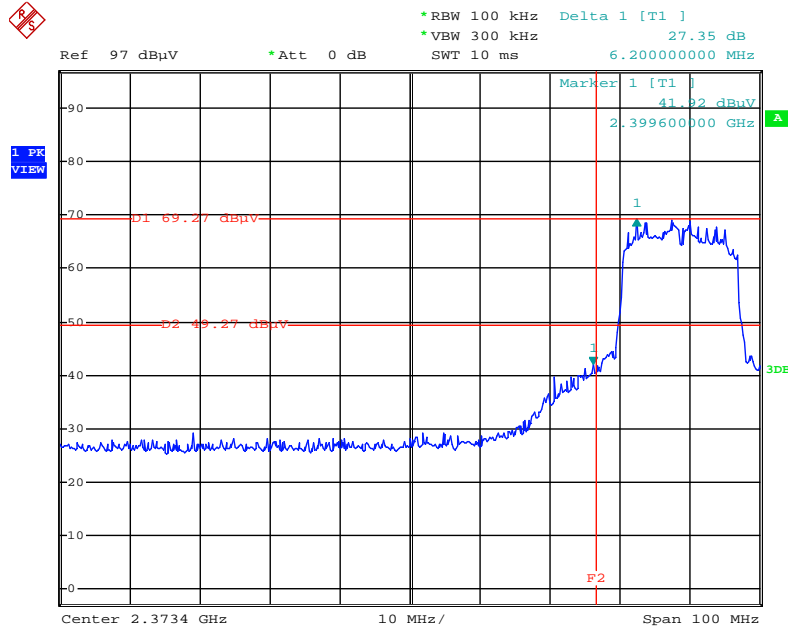

Date: 14.JUN.2012 16:32:52

Plot on Configuration IEEE 802.11g / Ant. A / 2462 MHz

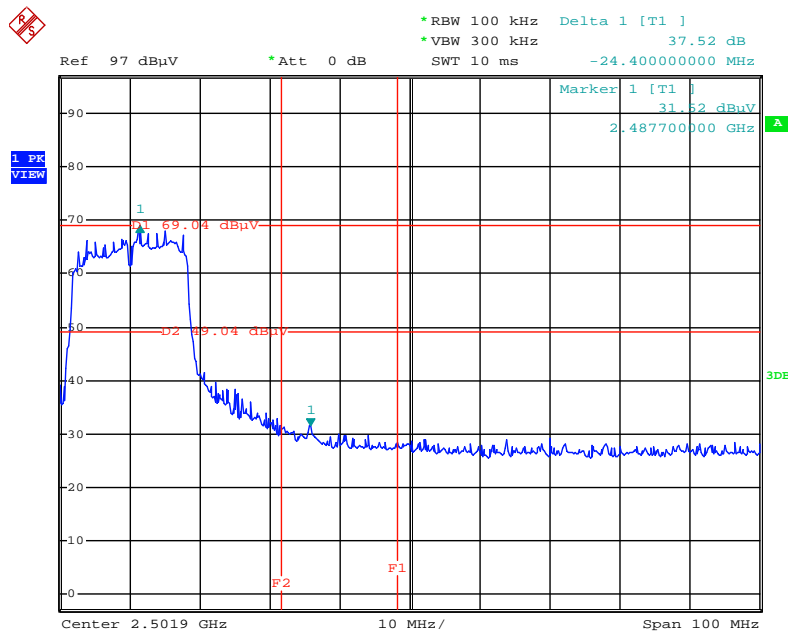

Date: 14.JUN.2012 16:54:20

Plot on Configuration IEEE 802.11a / Ant. B / 5745 MHz

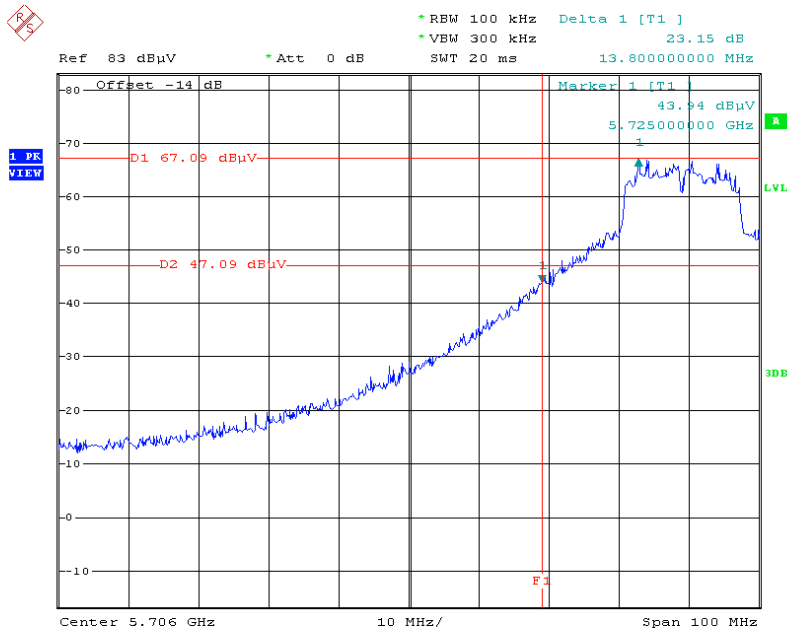

Date: 15.JUN.2012 15:01:07

Plot on Configuration IEEE 802.11a / Ant. B / 5825 MHz

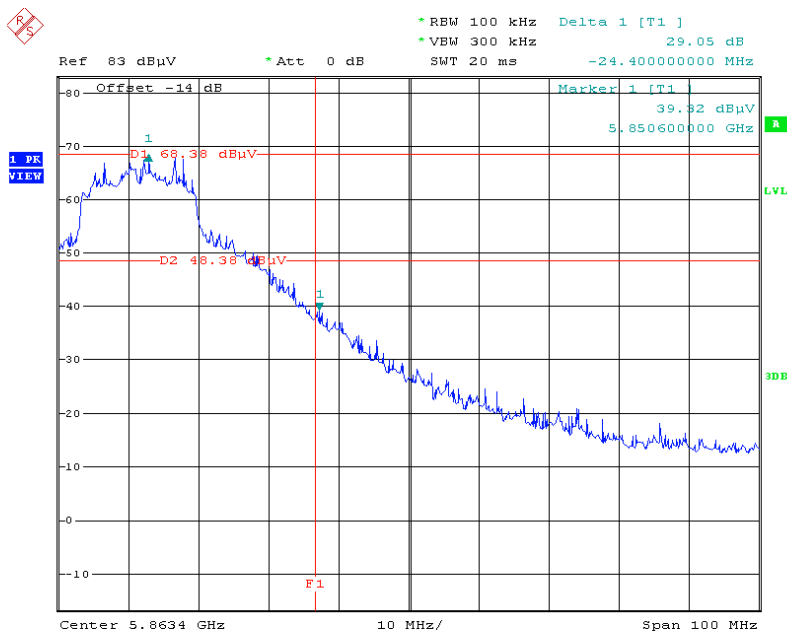

Date: 15.JUN.2012 15:02:47

## 4.8. Antenna Requirements

### 4.8.1. Limit

Except for special regulations, the Low-power Radio-frequency Devices must not be equipped with any jacket for installing an antenna with extension cable. An intentional radiator shall be designed to ensure that no antenna other than that furnished by the responsible party shall be used with the device. The use of a permanently attached antenna or of an antenna that uses a unique coupling to the intentional radiator shall be considered sufficient to comply with the provisions of this Section. The manufacturer may design the unit so that the user can replace a broken antenna, but the use of a standard antenna jack or electrical connector is prohibited. Further, this requirement does not apply to intentional radiators that must be professionally installed.

### 4.8.2. Antenna Connector Construction

Please refer to section 3.3 in this test report; antenna connector complied with the requirements.



## 5. LIST OF MEASURING EQUIPMENTS

Instrument	Manufacturer	Model No.	Serial No.	Characteristics	Calibration Date	Remark
EMI Test Receiver	R&S	ESCS 30	100377	9kHz ~ 2.75GHz	Sep. 14, 2011	Conduction (CO01-CB)
LISN	F.C.C.	FCC-LISN-50-16-2	04083	150kHz ~ 100MHz	Nov. 14, 2011	Conduction (CO01-CB)
V- LISN	Schwarzbeck	NSLK 8127	8127-478	9K ~ 30MHz	Jun. 22, 2012	Conduction (CO01-CB)
PULSE LIMITER	R&S	ESH3-Z2	100430	9K-30MHz	Feb. 03, 2012	Conduction (CO01-CB)
COND Cable	Woken	Cable	01	0.15MHz~30MHz	Dec. 4, 2011	Conduction (CO01-CB)
BILOG ANTENNA	Schaffner	CBL6112D	22021	20MHz ~ 2GHz	Jan. 11, 2012	Radiation (03CH01-CB)
Horn Antenna	EMCO	3115	00075790	750MHz~18GHz	Nov. 25, 2011	Radiation (03CH01-CB)
Horn Antenna	SCHWARZBEAK	BBHA 9170	BBHA9170252	15GHz ~ 40GHz	Nov. 22, 2011	Radiation (03CH01-CB)
Pre-Amplifier	Agilent	8447D	2944A10991	0.1MHz ~ 1.3GHz	Nov. 17, 2011	Radiation (03CH01-CB)
Pre-Amplifier	Agilent	8449B	3008A02310	1GHz ~ 26.5GHz	Nov. 29, 2011	Radiation (03CH01-CB)
Pre-Amplifier	WM	TF-130N-R1	923365	26.5GHz ~ 40GHz	Jul. 29, 2011	Radiation (03CH01-CB)
Spectrum analyzer	R&S	FSP40	100056	9KHz~40GHz	Nov. 03, 2011	Radiation (05CH01-CB)
EMI Test Receiver	R&S	ESCS 30	100355	9KHz ~ 2.75GHz	Mar. 20, 2012	Radiation (03CH01-CB)
Loop Antenna	Teseq	HLA 6120	24155	9 kHz - 30 MHz	Sep. 09, 2010*	Radiation (03CH01-CB)
Turn Table	INN CO	CO 2000	N/A	0 ~ 360 degree	N/A	Radiation (03CH01-CB)
Antenna Mast	INN CO	CO2000	N/A	1 m - 4 m	N/A	Radiation (03CH01-CB)
RF Cable-low	Woken	Low Cable-1	N/A	30 MHz - 1 GHz	Nov. 17, 2011	Radiation (03CH01-CB)
RF Cable-high	Woken	High Cable-1	N/A	1 GHz – 26.5 GHz	Nov. 17, 2011	Radiation (03CH01-CB)
RF Cable-high	Woken	High Cable-2	N/A	1 GHz – 26.5 GHz	Nov. 17, 2011	Radiation (03CH01-CB)
RF Cable-high	Woken	High Cable-3	N/A	1 GHz - 40 GHz	Nov. 17, 2011	Radiation (03CH01-CB)
RF Cable-high	Woken	High Cable-4	N/A	1 GHz - 40 GHz	Nov. 17, 2011	Radiation (03CH01-CB)
Signal analyzer	R&S	FSV40	100979	9KHz~40GHz	Sep. 26, 2011	Conducted (TH01-CB)
Temp. and Humidity Chamber	Ten Billion	TTH-D3SP	TBN-931011	-30~100 degree	Jun. 05, 2012	Conducted (TH01-CB)
Thermo-Hygro Meter	N/A	HC 520	#1	15~70 degree	Nov. 02, 2011	Conducted (TH01-CB)
Signal Generator	R&S	SMR40	100302	10MHz-40GHz	Nov. 22, 2011	Conducted (TH01-CB)

Instrument	Manufacturer	Model No.	Serial No.	Characteristics	Calibration Date	Remark
RF Power Divider	HP	11636A	00306	2GHz ~ 18GHz	N/A	Conducted (TH01-CB)
RF Power Splitter	Anaren	44100	1839	2GHz ~ 18GHz	N/A	Conducted (TH01-CB)
RF Power Splitter	Anaren	42100	17930	2GHz ~ 18GHz	N/A	Conducted (TH01-CB)
Signal generator	R&S	SMU200A	102782	10MHz-40GHz	Jun. 07, 2012	Conducted (TH01-CB)
Horn Antenna	COM-POWER	AH-118	071187	1GHz – 18GHz	May 09, 2012	Conducted (TH01-CB)
RF Cable-high	Woken	High Cable-7	-	1 GHz – 26.5 GHz	Nov. 17, 2011	Conducted (TH01-CB)
RF Cable-high	Woken	High Cable-8	-	1 GHz – 26.5 GHz	Nov. 17, 2011	Conducted (TH01-CB)
RF Cable-high	Woken	High Cable-9	-	1 GHz – 26.5 GHz	Nov. 17, 2011	Conducted (TH01-CB)
RF Cable-high	Woken	High Cable-10	-	1 GHz – 26.5 GHz	Nov. 17, 2011	Conducted (TH01-CB)
RF Cable-high	Woken	High Cable-11	-	1 GHz – 26.5 GHz	Nov. 17, 2011	Conducted (TH01-CB)
RF Cable-high	Woken	High Cable-12	-	1 GHz – 26.5 GHz	Nov. 17, 2011	Conducted (TH01-CB)
RF Cable-high	Woken	High Cable-13	-	1 GHz – 26.5 GHz	Nov. 17, 2011	Conducted (TH01-CB)
Power Sensor	Anritsu	MA2411B	0917223	300MHz~40GHz	Nov. 01, 2011	Conducted (TH01-CB)
Power Meter	Anritsu	ML2495A	1035008	300MHz~40GHz	Nov. 01, 2011	Conducted (TH01-CB)

Note: Calibration Interval of instruments listed above is one year.

Note: “\*” Calibration Interval of instruments listed above is two years.

## 6. TEST LOCATION

SHIJR	ADD : 6Fl., No. 106, Sec. 1, Shintai 5th Rd., Shijr City, Taipei, Taiwan 221, R.O.C. TEL : 886-2-2696-2468 FAX : 886-2-2696-2255
HWA YA	ADD : No. 52, Hwa Ya 1st Rd., Kwei-Shan Hsiang, Tao Yuan Hsien, Taiwan, R.O.C. TEL : 886-3-327-3456 FAX : 886-3-318-0055
LINKOU	ADD : No. 30-2, Dingfu Tsuen, Linkou Shiang, Taipei, Taiwan 244, R.O.C TEL : 886-2-2601-1640 FAX : 886-2-2601-1695
DUNGHU	ADD : No. 3, Lane 238, Kangle St., Neihu Chiu, Taipei, Taiwan 114, R.O.C. TEL : 886-2-2631-4739 FAX : 886-2-2631-9740
JUNGHE	ADD : 7Fl., No. 758, Jungjeng Rd., Junghe City, Taipei, Taiwan 235, R.O.C. TEL : 886-2-8227-2020 FAX : 886-2-8227-2626
NEIHU	ADD : 4Fl., No. 339, Hsin Hu 2 <sup>nd</sup> Rd., Taipei 114, Taiwan, R.O.C. TEL : 886-2-2794-8886 FAX : 886-2-2794-9777
JHUBEI	ADD : No.8, Lane 724, Bo-ai St., Jhubei City, HsinChu County 302, Taiwan, R.O.C. TEL : 886-3-656-9065 FAX : 886-3-656-9085

## 7. TAF CERTIFICATE OF ACCREDITATION



Certificate No. : L1190-110702

財團法人全國認證基金會  
Taiwan Accreditation Foundation

### Certificate of Accreditation

This is to certify that

**Sporton International Inc.**  
**EMC & Wireless Communications Laboratory**  
No.52, Hwa Ya 1st Road, Hwa Ya Technology Park, Kwei-Shan Hsiang, Tao Yuan Hsien,  
Taiwan, R.O.C.

**is accredited in respect of laboratory**

<b>Accreditation Criteria</b>	: ISO/IEC 17025:2005
<b>Accreditation Number</b>	: 1190
<b>Originally Accredited</b>	: December 15, 2003
<b>Effective Period</b>	: January 10, 2010 to January 09, 2013
<b>Accredited Scope</b>	: Testing Field, see described in the Appendix
<b>Specific Accreditation Program</b>	: Accreditation Program for Designated Testing Laboratory for Commodities Inspection Accreditation Program for Telecommunication Equipment Testing Laboratory Accreditation Program for BSMI Mutual Recognition Arrangement with Foreign Authorities

*Jay-San Chen*

Jay-San Chen  
President, Taiwan Accreditation Foundation  
Date : July 02, 2011

P1, total 22 pages

The Appendix forms an integral part of this Certificate, which shall be invalid when use without the Appendix