



**FCC CFR47 PART 15 SUBPART C
INDUSTRY CANADA RSS-210 ISSUE 8**

CERTIFICATION TEST REPORT

FOR

802.11a/g/n WLAN + Bluetooth PCI-E Custom Combination Card

MODEL NUMBER: BCM94331PCIEBT3B

**FCC ID: QDS-BRCM1066
IC: 4324A-BRCM1066**

REPORT NUMBER: 12U14373-1, Revision A

ISSUE DATE: JUNE 28, 2012

Prepared for

**BROADCOM CORPORATION
190 MATHILDA PLACE
SUNNYVALE, CA 94086, U.S.A.**

Prepared by

**COMPLIANCE CERTIFICATION SERVICES (UL CCS)
47173 BENICIA STREET
FREMONT, CA 94538, U.S.A.
TEL: (510) 771-1000
FAX: (510) 661-0888**



NVLAP LAB CODE 200065-0

Revision History

<u>Rev.</u>	<u>Issue Date</u>	<u>Revisions</u>	<u>Revised By</u>
--	05/22/12	Initial Issue	F. Ibrahim
A	06/28/12	Updated section 7.2.5	F. Ibrahim

TABLE OF CONTENTS

1. ATTESTATION OF TEST RESULTS	5
2. TEST METHODOLOGY	6
3. FACILITIES AND ACCREDITATION	6
4. CALIBRATION AND UNCERTAINTY	6
4.1. <i>MEASURING INSTRUMENT CALIBRATION</i>	6
4.2. <i>SAMPLE CALCULATION</i>	6
4.3. <i>MEASUREMENT UNCERTAINTY</i>	6
5. EQUIPMENT UNDER TEST	7
5.1. <i>DESCRIPTION OF EUT</i>	7
5.2. <i>MAXIMUM OUTPUT POWER</i>	7
5.3. <i>DESCRIPTION OF AVAILABLE ANTENNAS</i>	7
5.4. <i>SOFTWARE AND FIRMWARE</i>	7
5.5. <i>WORST-CASE CONFIGURATION AND MODE</i>	7
5.6. <i>DESCRIPTION OF TEST SET</i>	8
6. TEST AND MEASUREMENT EQUIPMENT	10
7. ANTENNA PORT TEST RESULTS	11
7.1. <i>BASIC DATA RATE GFSK MODULATION</i>	11
7.1.1. 99% BANDWIDTH	11
7.1.2. 20 dB BANDWIDTH	14
7.1.3. HOPPING FREQUENCY SEPARATION	17
7.1.4. NUMBER OF HOPPING CHANNELS.....	18
7.1.5. AVERAGE TIME OF OCCUPANCY	21
7.1.6. OUTPUT POWER	25
7.1.7. CONDUCTED SPURIOUS EMISSIONS.....	28
7.2. <i>ENHANCED DATA RATE 8PSK MODULATION</i>	33
7.2.1. 99% BANDWIDTH	33
7.2.2. 20dB BANDWIDTH	36
7.2.3. HOPPING FREQUENCY SEPARATION	39
7.2.4. NUMBER OF HOPPING CHANNELS.....	40
7.2.5. AVERAGE TIME OF OCCUPANCY	43
7.2.6. OUTPUT POWER	47
7.2.7. CONDUCTED SPURIOUS EMISSIONS.....	50
8. RADIATED TEST RESULTS	55
8.1. <i>LIMITS AND PROCEDURE</i>	55
8.2. <i>TX SPURIOUS ABOVE 1 GHz</i>	56
8.2.1. BASIC DATA RATE GFSK MODULATION.....	56

8.2.2. ENHANCED DATA RATE 8PSK MODULATION.....	61
8.3. WORST-CASE BELOW 1 GHz.....	66
9. AC POWER LINE CONDUCTED EMISSIONS.....	69
10. MAXIMUM PERMISSIBLE EXPOSURE	73
11. SETUP PHOTOS.....	76

1. ATTESTATION OF TEST RESULTS

COMPANY NAME: BROADCOM CORPORATION
190 MATHILDA PLACE
SUNNYVALE, CA 94086, U.S.A.

EUT DESCRIPTION: 802.11a/g/n WLAN + Bluetooth PCI-E Custom Combination Card

MODEL: BCM94331PCIEBT3B

SERIAL NUMBER: 01 (P100)

DATE TESTED: APRIL 05 – MAY 22, 2012

APPLICABLE STANDARDS	
STANDARD	TEST RESULTS
CFR 47 Part 15 Subpart C	Pass
INDUSTRY CANADA RSS-210 Issue 8 Annex 8	Pass
INDUSTRY CANADA RSS-GEN Issue 3	Pass

Compliance Certification Services (UL CCS) tested the above equipment in accordance with the requirements set forth in the above standards. All indications of Pass/Fail in this report are opinions expressed by UL CCS based on interpretations and/or observations of test results. Measurement Uncertainties were not taken into account and are published for informational purposes only. The test results show that the equipment tested is capable of demonstrating compliance with the requirements as documented in this report.

Note: The results documented in this report apply only to the tested sample, under the conditions and modes of operation as described herein. This document may not be altered or revised in any way unless done so by UL CCS and all revisions are duly noted in the revisions section. Any alteration of this document not carried out by UL CCS will constitute fraud and shall nullify the document. This report must not be used by the client to claim product certification, approval, or endorsement by NVLAP, NIST, any agency of the Federal Government, or any agency of any government.

Approved & Released For UL CCS By:



FRANK IBRAHIM
EMC SUPERVISOR
UL CCS

Tested By:



VIEN TRAN
EMC ENGINEER
UL CCS

2. TEST METHODOLOGY

The tests documented in this report were performed in accordance with ANSI C63.4-2003, FCC CFR 47 Part 2, FCC CFR 47 Part 15, RSS-GEN Issue 3, and RSS-210 Issue 8.

3. FACILITIES AND ACCREDITATION

The test sites and measurement facilities used to collect data are located at 47173 Benicia Street, Fremont, California, USA.

UL CCS is accredited by NVLAP, Laboratory Code 200065-0. The full scope of accreditation can be viewed at <http://www.ccsemc.com>.

4. CALIBRATION AND UNCERTAINTY

4.1. MEASURING INSTRUMENT CALIBRATION

The measuring equipment utilized to perform the tests documented in this report has been calibrated in accordance with the manufacturer's recommendations, and is traceable to recognized national standards.

4.2. SAMPLE CALCULATION

Where relevant, the following sample calculation is provided:

$$\begin{aligned} \text{Field Strength (dBuV/m)} &= \text{Measured Voltage (dBuV)} + \text{Antenna Factor (dB/m)} + \\ &\text{Cable Loss (dB)} - \text{Preamp Gain (dB)} \\ 36.5 \text{ dBuV} + 18.7 \text{ dB/m} + 0.6 \text{ dB} - 26.9 \text{ dB} &= 28.9 \text{ dBuV/m} \end{aligned}$$

4.3. MEASUREMENT UNCERTAINTY

Where relevant, the following measurement uncertainty levels have been estimated for tests performed on the apparatus:

PARAMETER	UNCERTAINTY
Conducted Disturbance, 0.15 to 30 MHz	3.52 dB
Radiated Disturbance, 30 to 1000 MHz	4.94 dB

Uncertainty figures are valid to a confidence level of 95%.

5. EQUIPMENT UNDER TEST

5.1. DESCRIPTION OF EUT

The EUT is an 802.11a/g/n WLAN + Bluetooth PCI-E Custom Combination Card

The radio module is manufactured by Broadcom.

5.2. MAXIMUM OUTPUT POWER

The transmitter has a maximum peak conducted output power as follows:

Frequency Range (MHz)	Mode	Output Power (dBm)	Output Power (mW)
2402 - 2480	Basic GFSK	7.68	5.86
2402 - 2480	Enhanced 8PSK	7.58	5.73

5.3. DESCRIPTION OF AVAILABLE ANTENNAS

The radio utilizes an 802.11a/g/n WLAN + Bluetooth antenna with a maximum gain of 1.11 dBi.

5.4. SOFTWARE AND FIRMWARE

The EUT driver software installed during testing was Broadcom Bluetooth Version 5.1.0.1400

The test utility software used during testing was Blue Tool, ver. 1.6.0.4.

5.5. WORST-CASE CONFIGURATION AND MODE

Radiated emission and power line conducted emission were performed with the EUT set to transmit at the channel with the highest output power as worst-case scenario.

5.6. DESCRIPTION OF TEST SET

SUPPORT EQUIPMENT

Support Equipment List				
Description	Manufacturer	Model	Serial Number	FCC ID
Laptop	Dell	E6400	BDRBKK1	Doc
AC Adapter	Dell	FA90PE1-00	CN-0CM889-73245-966-3810-A01	N/A
Converter Board	Broadcom	BCM94331PCIEBT3HAD	95	N/A
USB Cable	N/A	N/A	N/A	N/A

I/O CABLES

I/O CABLE LIST						
Cable No.	Port	# of Identical Ports	Connector Type	Cable Type	Cable Length	Remarks
1	AC	1	US 115V	Shielded	1.5m	NA
2	DC	1	DC	Un-shielded	1.5m	Ferrite at laptop's end
3	USB	1	USB	Un-shielded	1.0m	NA

SETUP DIAGRAM

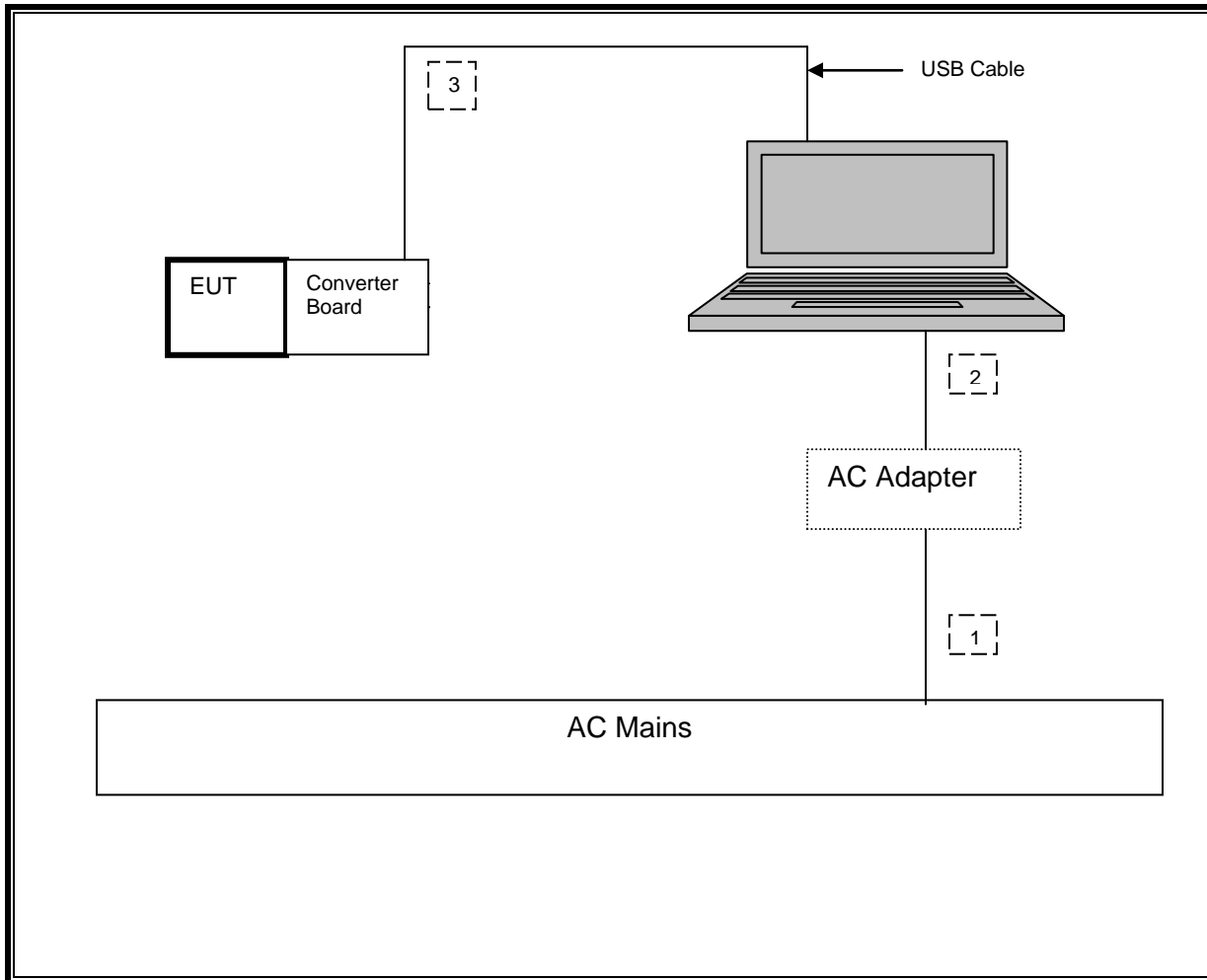

TEST SETUP

The EUT was tested as an external module that installed on a converter board connected to a host Laptop PC via USB cable.

6. TEST AND MEASUREMENT EQUIPMENT

The following test and measurement equipment was utilized for the tests documented in this report:

TEST EQUIPMENT LIST				
Description	Manufacturer	Model	Asset	Cal Due
Spectrum Analyzer, 44 GHz	Agilent / HP	E4446A	C00996	03/22/13
Antenna, Bilog, 2 GHz	Sunol Sciences	JB1	C01171	07/16/12
Antenna, Horn, 18 GHz	EMCO	3115	C00872	09/20/12
Antenna, Horn, 26.5 GHz	ARA	MWH-1826/B	C00980	07/28/12
Preamplifier, 1300 MHz	Agilent / HP	8447D	C00778	11/11/12
Preamplifier, 26.5 GHz	Agilent / HP	8449B	C00749	07/18/12
Peak Power Meter	Agilent / HP	E9327A	C00964	12/13/13
Peak Power Sensor	Agilent / HP	E4416A	C00963	12/13/13
Reject Filter, 2.4-2.5 GHz	Micro-Tronics	BRM50702	N02685	CNR
LISN, 30 MHz	FCC	LISN-50/250-25-2	N02625	12/13/12
EMI Test Receiver, 30 MHz	R & S	ESHS 20	N02396	08/19/13

7. ANTENNA PORT TEST RESULTS

7.1. BASIC DATA RATE GFSK MODULATION

7.1.1. 99% BANDWIDTH

LIMIT

None; for reporting purposes only.

TEST PROCEDURE

The transmitter output is connected to a spectrum analyzer. The RBW is set to $\geq 1\%$ of the 99% bandwidth. The VBW is set to \geq RBW. The sweep time is coupled.

RESULTS

Channel	Frequency (MHz)	99% Bandwidth (kHz)
Low	2402	877.6198
Middle	2441	867.4473
High	2480	858.5681

99% BANDWIDTH

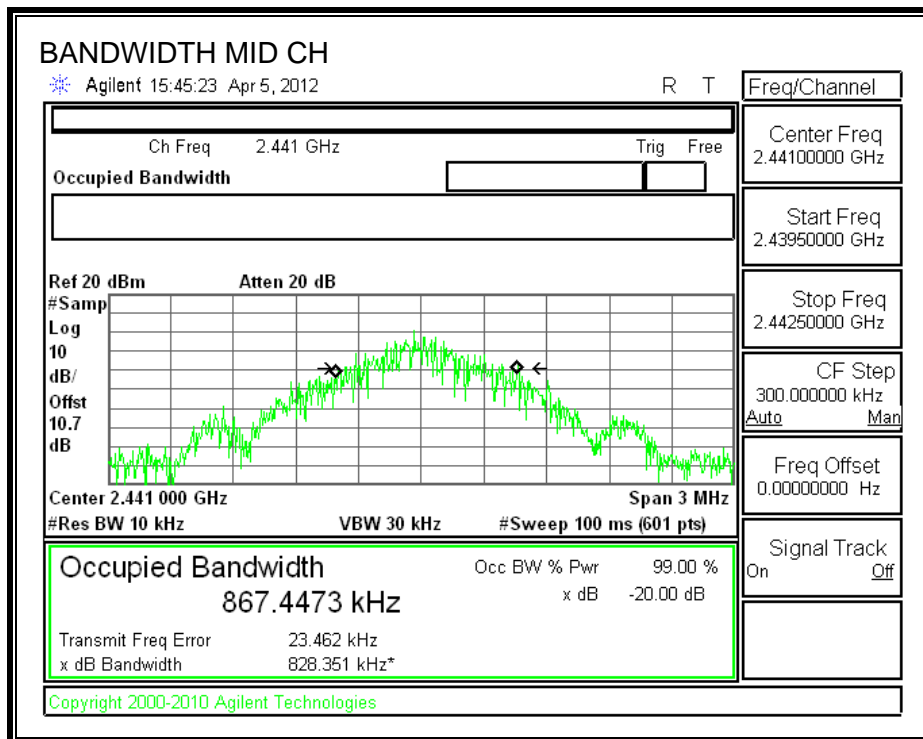
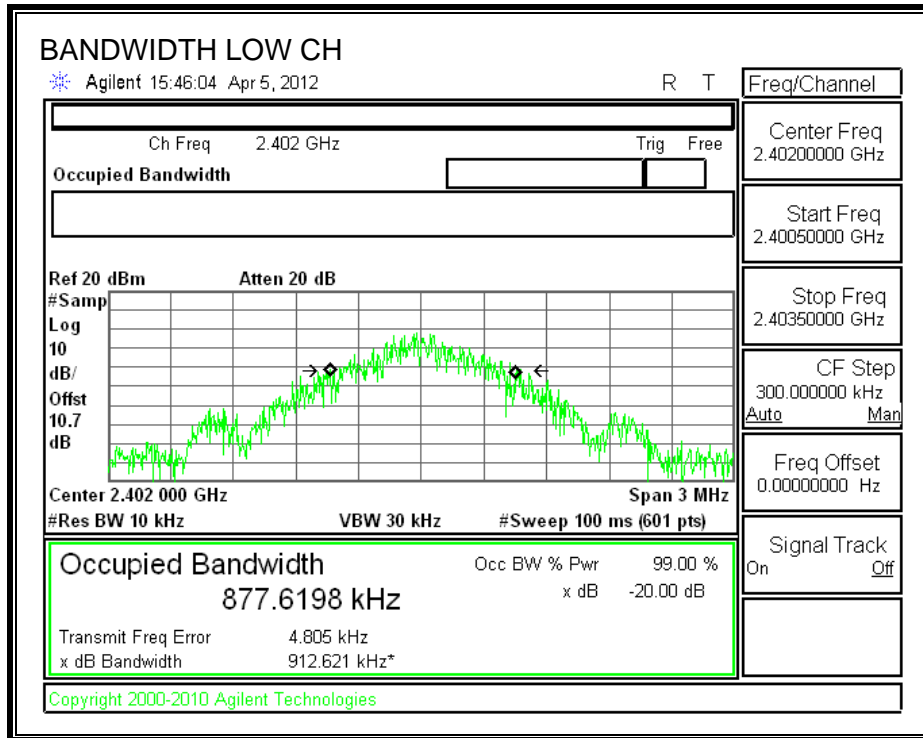

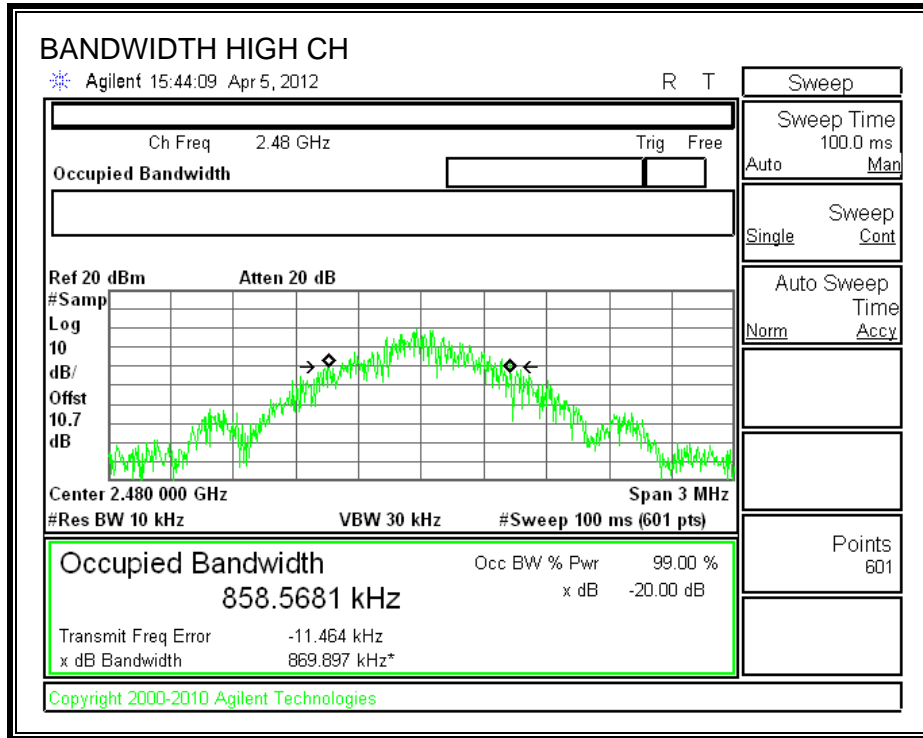

7.1.2. 20 dB BANDWIDTH

LIMIT

None; for reporting purposes only.

TEST PROCEDURE

The transmitter output is connected to a spectrum analyzer. The RBW is set to $\geq 1\%$ of the 20 dB bandwidth. The VBW is set to \geq RBW. The sweep time is coupled.

RESULTS

Channel	Frequency (MHz)	20 dB Bandwidth (kHz)
Low	2402	922.925
Middle	2441	924.551
High	2480	925.530

20 dB BANDWIDTH

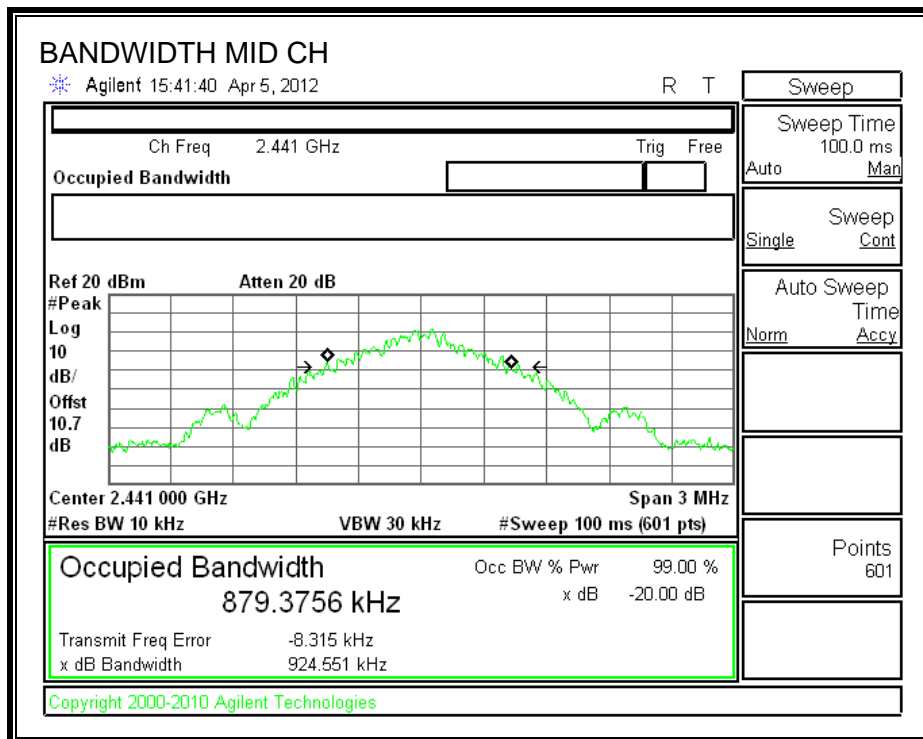
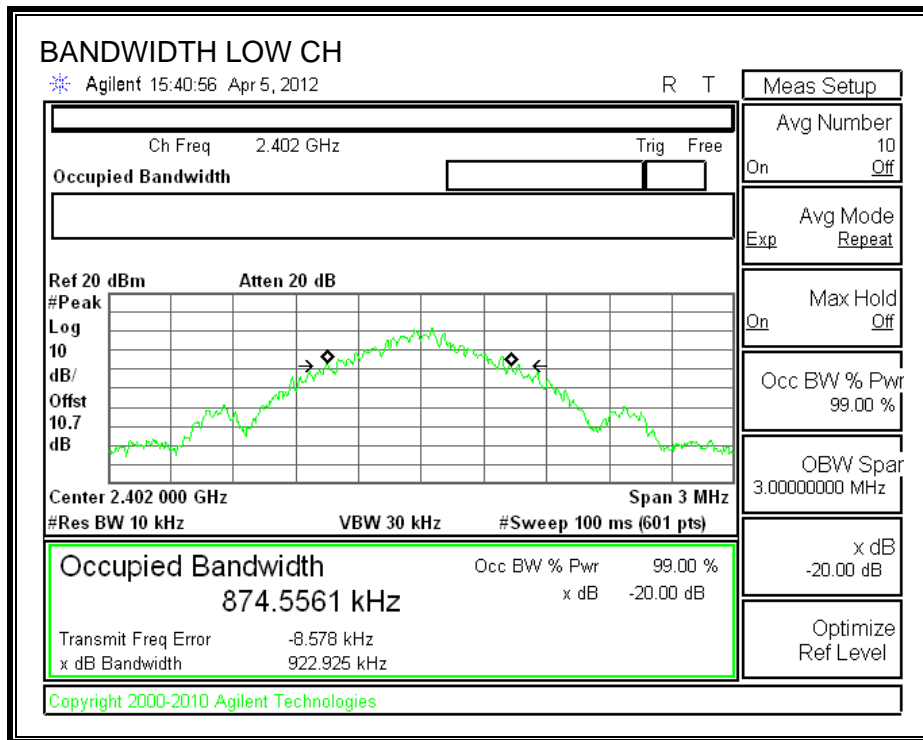

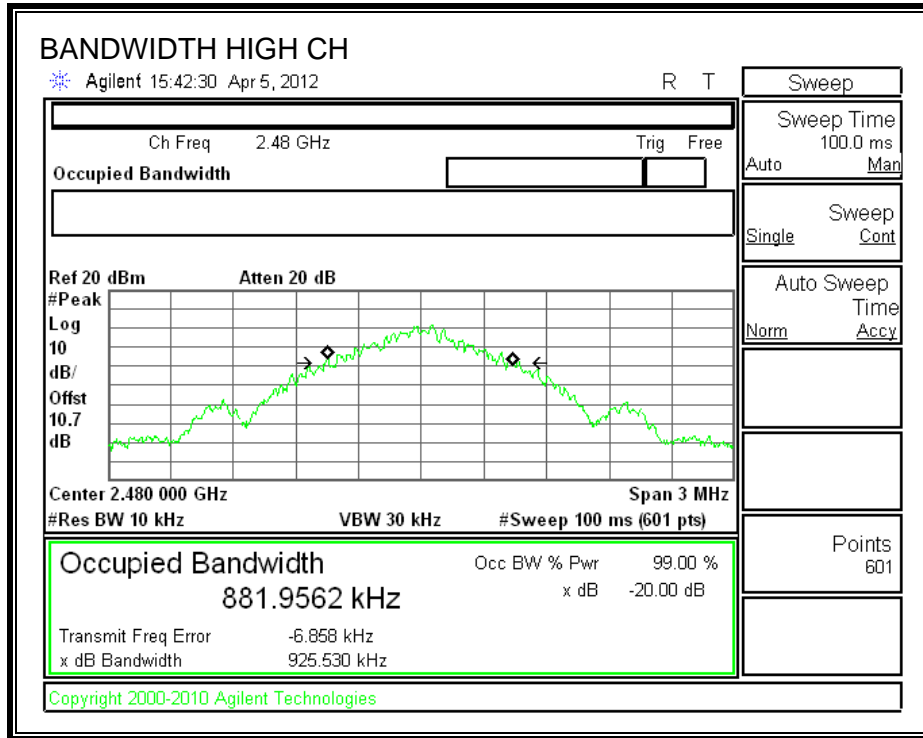

7.1.3. HOPPING FREQUENCY SEPARATION

LIMIT

FCC §15.247 (a) (1)

IC RSS-210 A8.1 (b)

Frequency hopping systems shall have hopping channel carrier frequencies separated by a minimum of 25 kHz or the 20 dB bandwidth of the hopping channel, whichever is greater.

Alternatively, frequency hopping systems operating in the 2400-2483.5 MHz band may have hopping channel carrier frequencies that are separated by 25 kHz or two-thirds of the 20 dB bandwidth of the hopping channel, whichever is greater, provided the systems operate with an output power no greater than 125 mW.

TEST PROCEDURE

The transmitter output is connected to a spectrum analyzer. The RBW is set to 100 kHz and the VBW is set to 100 kHz. The sweep time is coupled.

RESULTS

HOPPING FREQUENCY SEPARATION

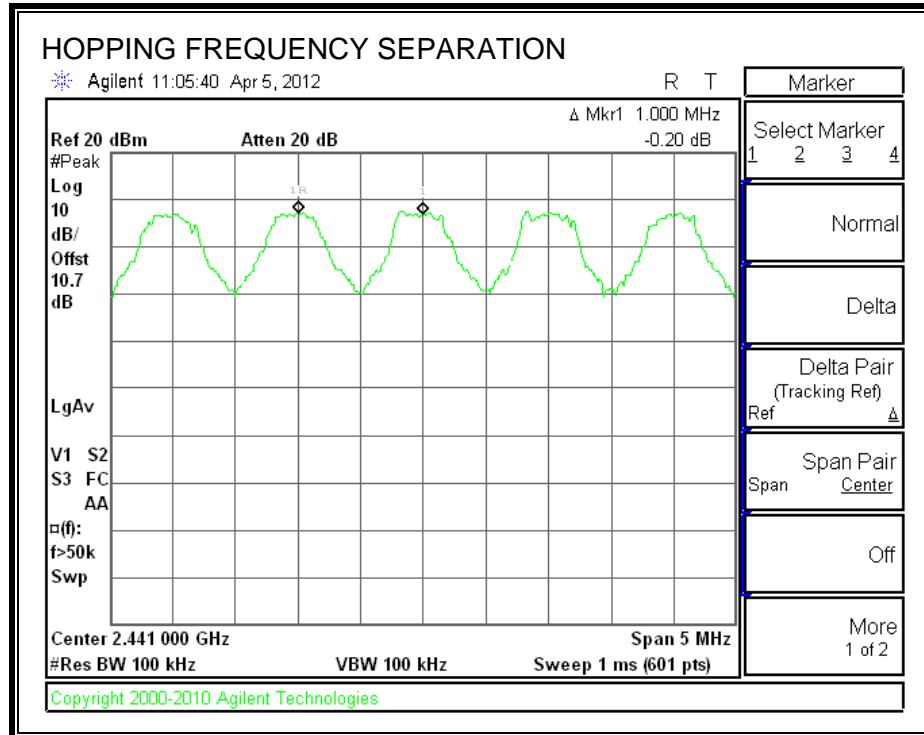

7.1.4. NUMBER OF HOPPING CHANNELS

LIMIT

FCC §15.247 (a) (1) (iii)

IC RSS-210 A8.1 (d)

Frequency hopping systems in the 2400 – 2483.5 MHz band shall use at least 15 non-overlapping channels.

TEST PROCEDURE

The transmitter output is connected to a spectrum analyzer. The span is set to cover the entire authorized band, in either a single sweep or in multiple contiguous sweeps. The RBW is set to a maximum of 1 % of the span. The analyzer is set to Max Hold.

RESULTS

Normal Mode: Minimum channels are 20 and maximum channels are 79

AFH Mode: Minimum channels are 20 and maximum channels are 79

NUMBER OF HOPPING CHANNELS

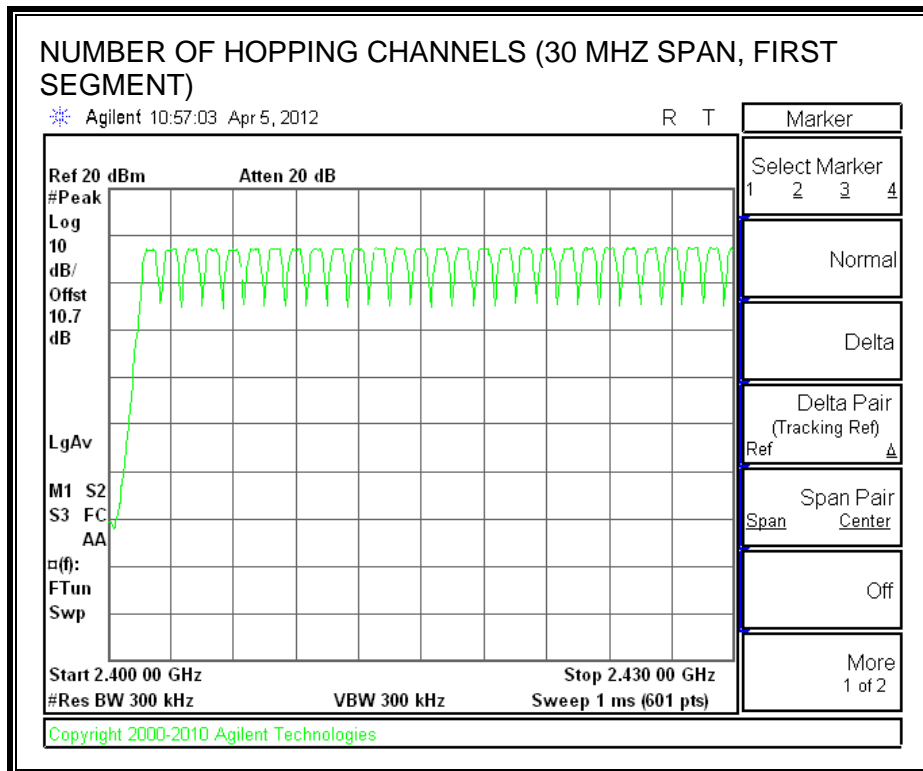
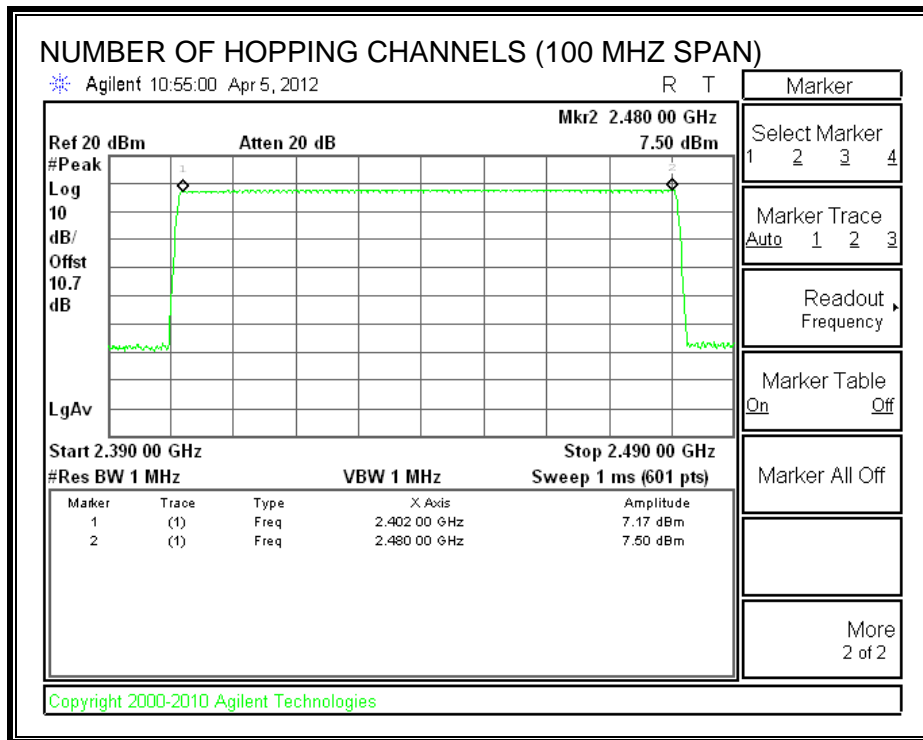

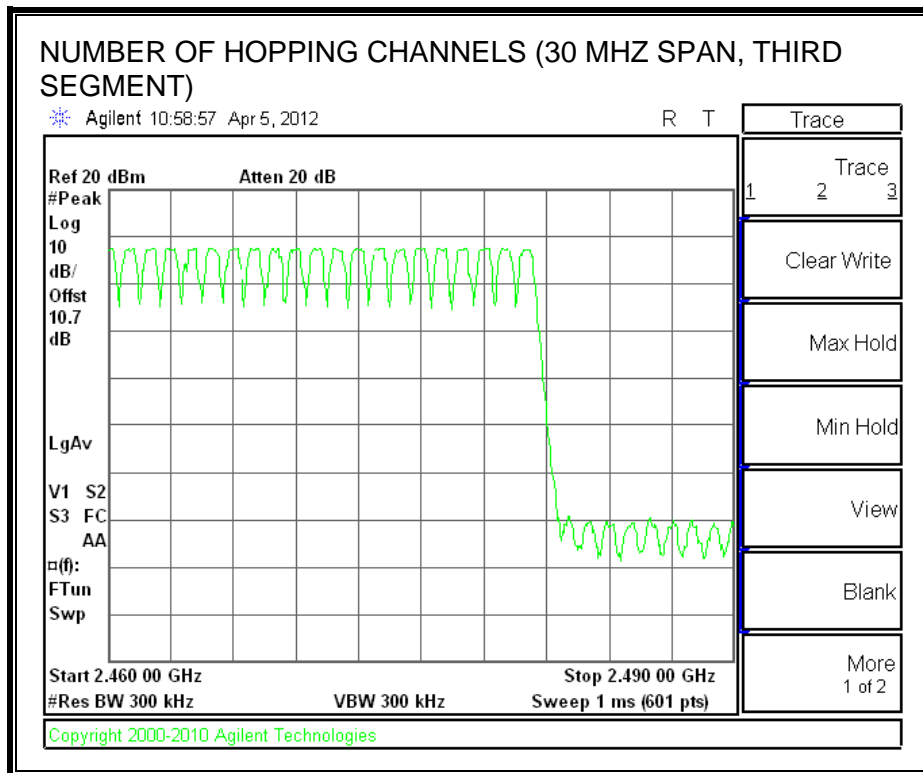
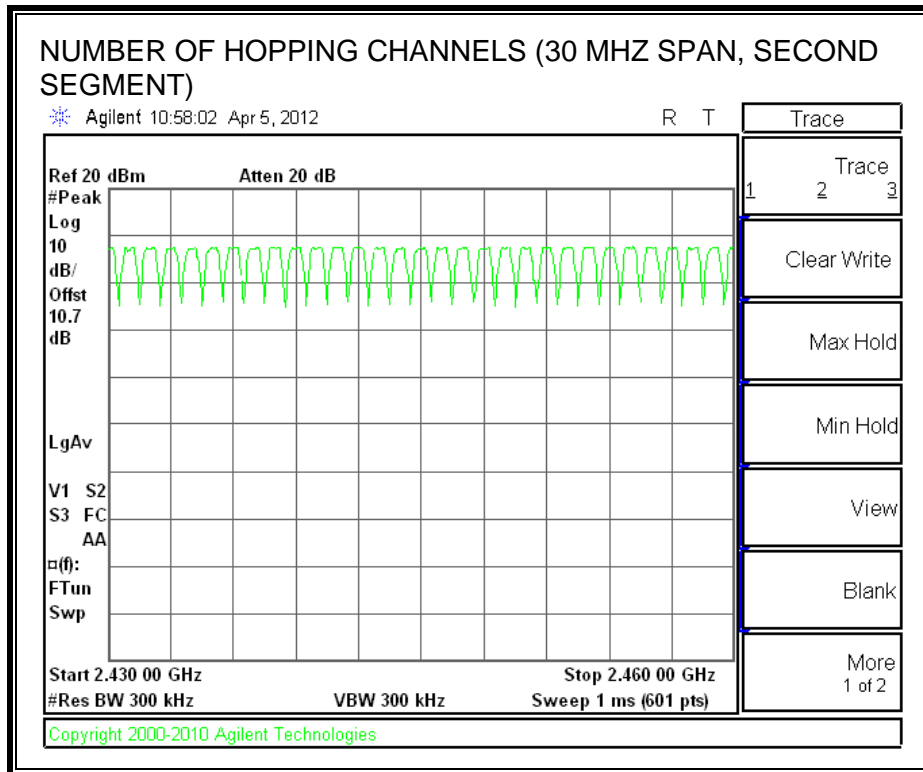

7.1.5. AVERAGE TIME OF OCCUPANCY

LIMIT

FCC §15.247 (a) (1) (iii)

IC RSS-210 A8.1 (d)

The average time of occupancy on any channel shall not be greater than 0.4 seconds within a period of 0.4 seconds multiplied by the number of hopping channels employed.

TEST PROCEDURE

The transmitter output is connected to a spectrum analyzer. The span is set to 0 Hz, centered on a single, selected hopping channel. The width of a single pulse is measured in a fast scan. The number of pulses is measured in a 3.16 second scan, to enable resolution of each occurrence.

The average time of occupancy in the specified 31.6 second period (79 channels * 0.4 s) is equal to $10 * (\# \text{ of pulses in } 3.16 \text{ s}) * \text{ pulse width}$.

For AFH mode, the average time of occupancy in the specified 8 second period (20 channels * 0.4 seconds) is equal to $10 * (\# \text{ of pulses in } 0.8 \text{ s}) * \text{ pulse width}$.

RESULTS

DH Packet	Pulse Width (msec)	Number of Pulses in 3.16 seconds	Average Time of Occupancy (sec)	Limit (sec)	Margin (sec)
GFSK Normal Mode					
DH1	0.4433	32	0.1419	0.4	-0.2581
DH3	1.7030	20	0.3406	0.4	-0.0594
DH5	2.9520	12	0.3542	0.4	-0.0458
GFSK AFH Mode					
DH Packet	Pulse Width (msec)	Number of Pulses in 0.8 seconds	Average Time of Occupancy (sec)	Limit (sec)	Margin (sec)
DH1	0.4433	64	0.284	0.4	-0.116
DH3	1.703	21	0.358	0.4	-0.042
DH5	2.952	13	0.384	0.4	-0.016

DH1

PULSE WIDTH

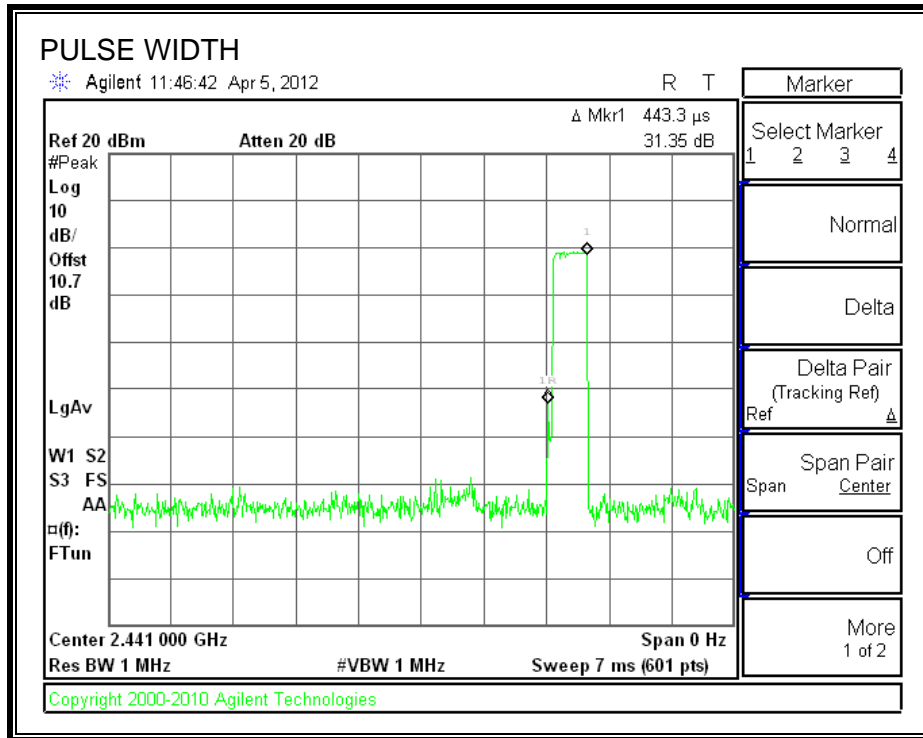

NUMBER OF PULSES IN 3.16 SECOND OBSERVATION PERIOD

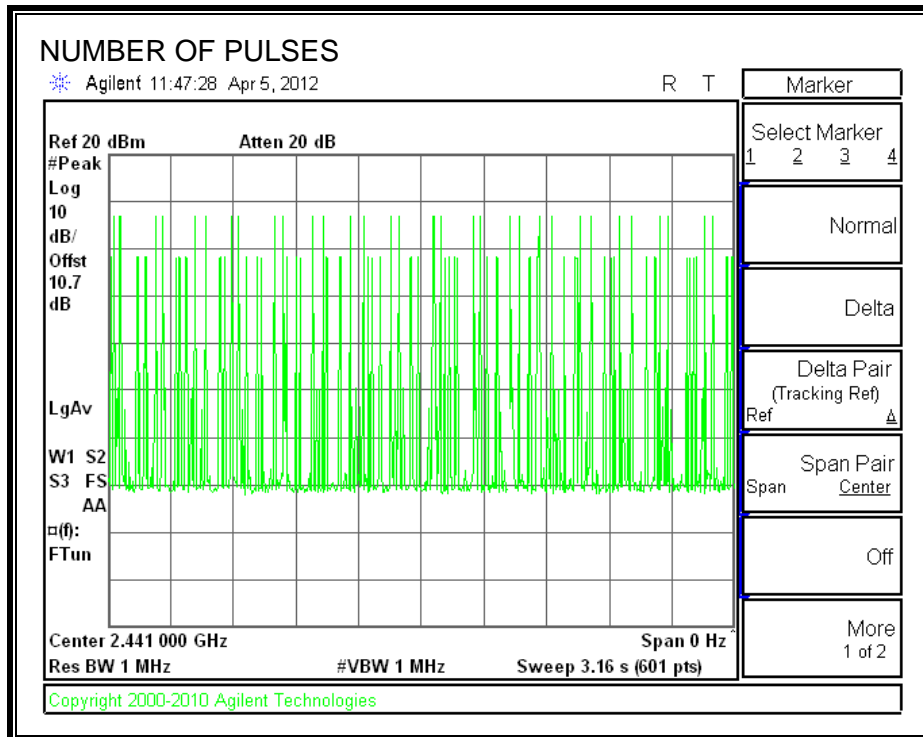

DH3

PULSE WIDTH

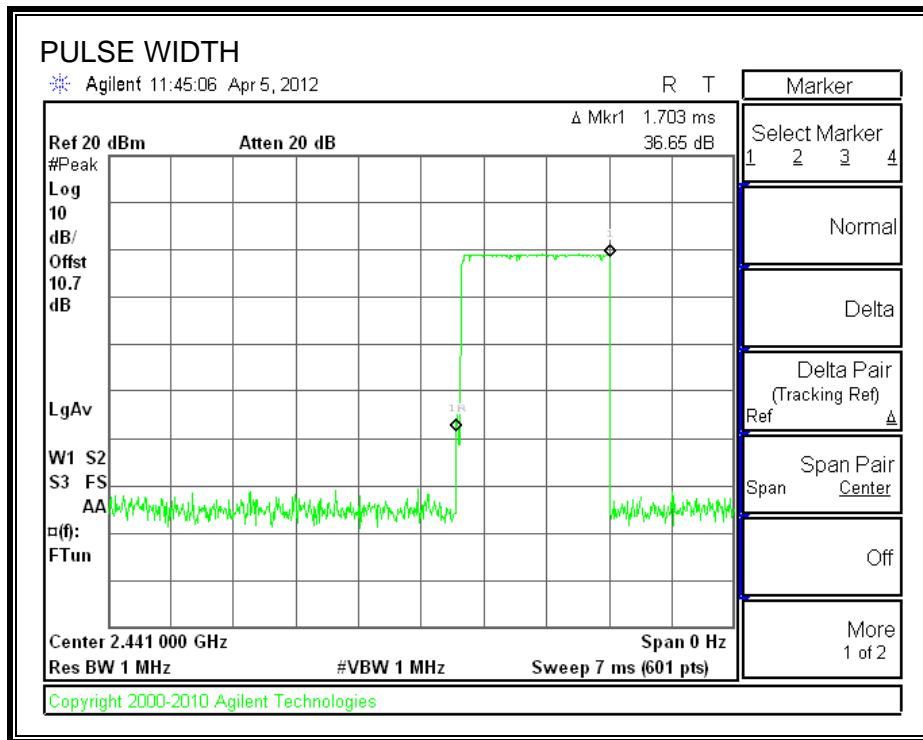

NUMBER OF PULSES IN 3.16 SECOND OBSERVATION PERIOD

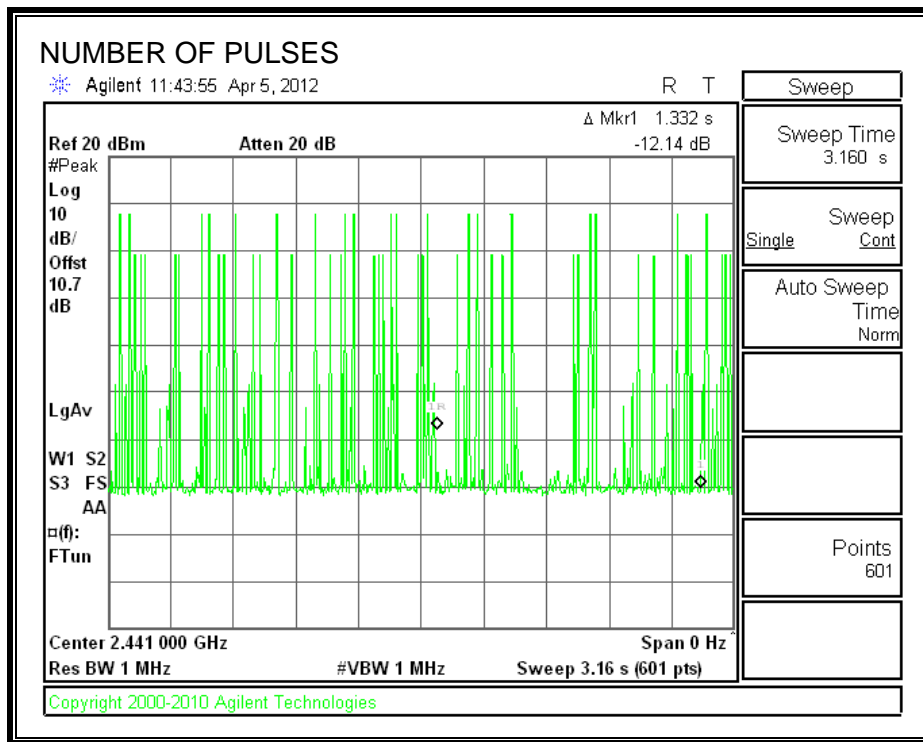

DH5

PULSE WIDTH

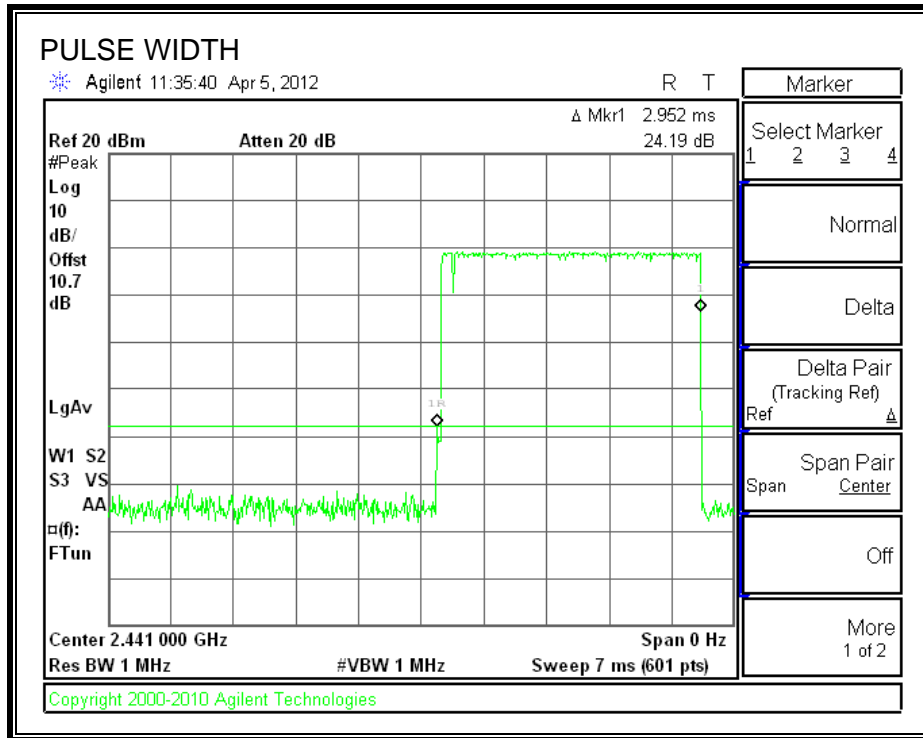

NUMBER OF PULSES IN 3.16 SECOND OBSERVATION PERIOD

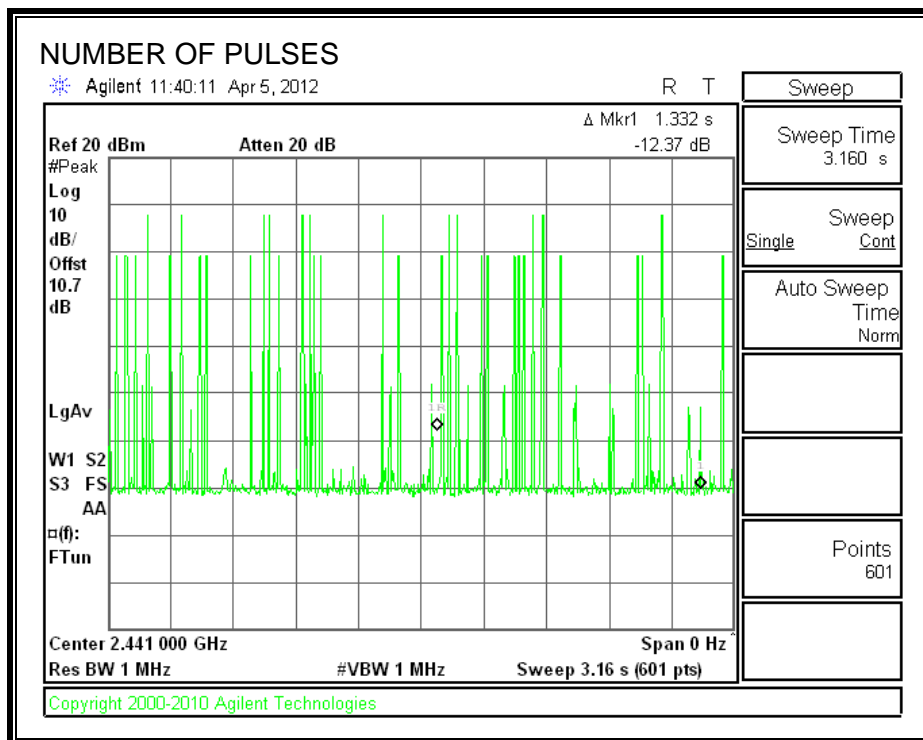

7.1.6. OUTPUT POWER

LIMIT

§15.247 (b) (1)

RSS-210 Issue 7 Clause A8.4

The maximum antenna gain is less than 6 dBi, therefore the limit is 30 dBm.

TEST PROCEDURE

The transmitter output is connected to a spectrum analyzer the analyzer bandwidth is set to a value greater than the 20 dB bandwidth of the EUT.

RESULTS

Channel	Frequency (MHz)	Output Power (dBm)	Limit (dBm)	Margin (dB)
Low	2402	7.32	30	-22.68
Middle	2441	7.68	30	-22.32
High	2480	7.63	30	-22.37

OUTPUT POWER

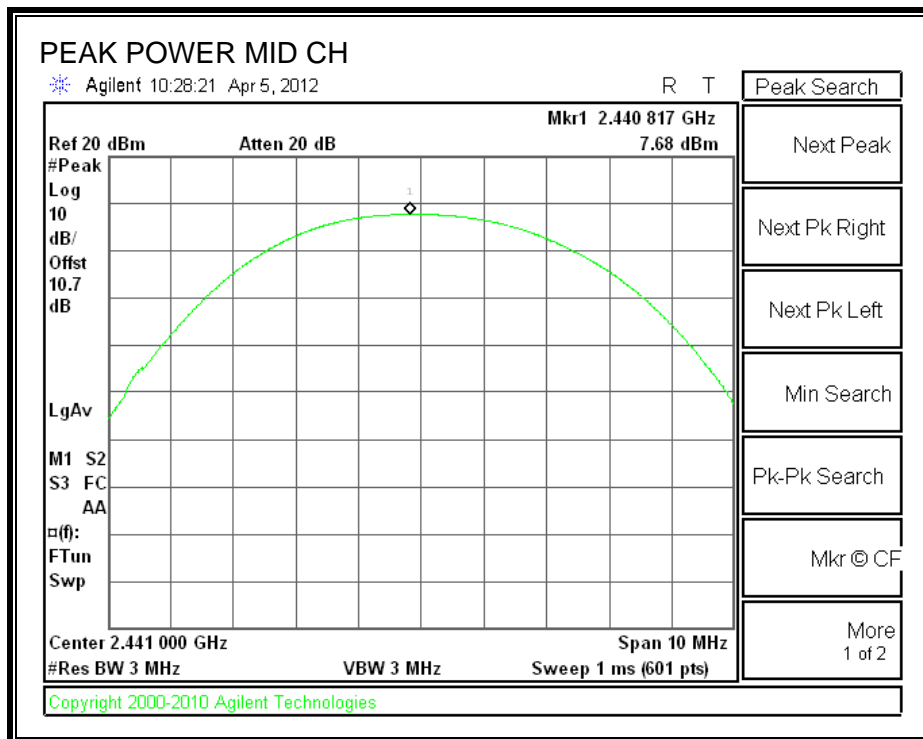
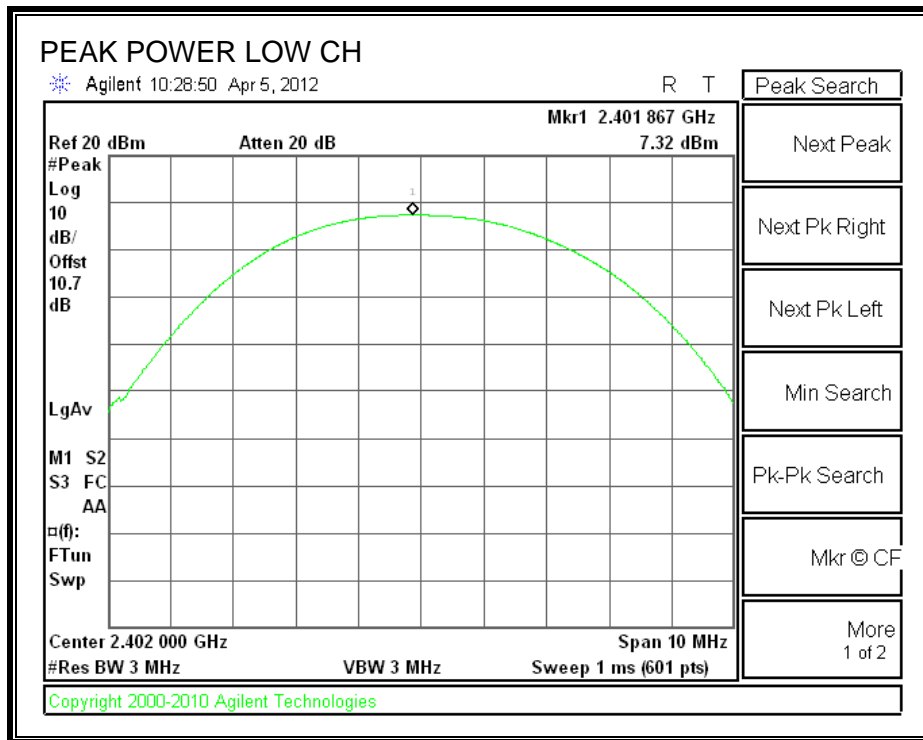

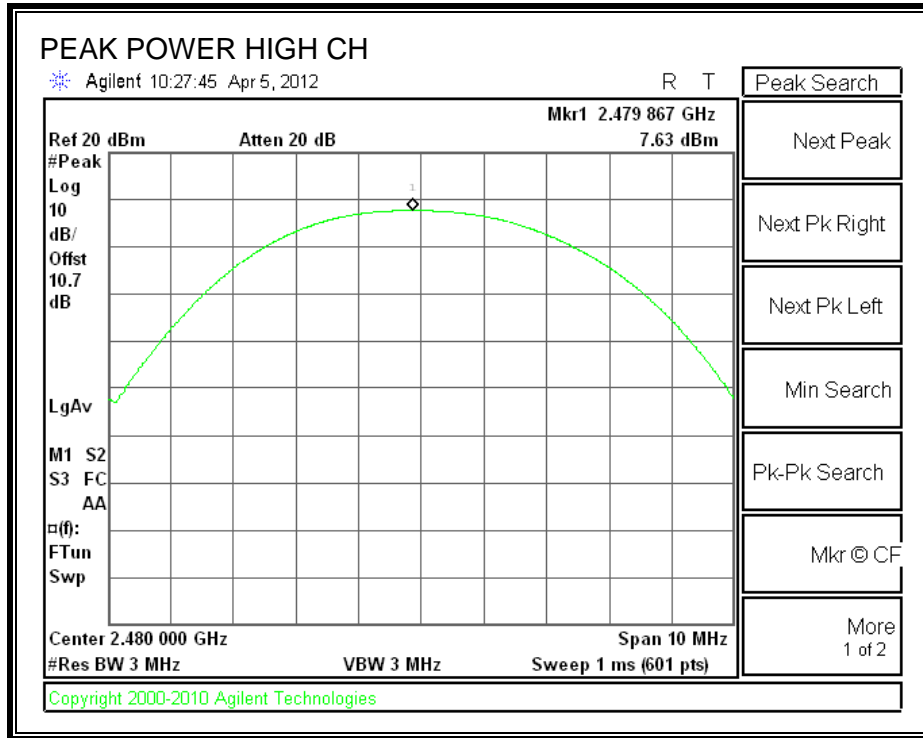

7.1.7. CONDUCTED SPURIOUS EMISSIONS

LIMITS

FCC §15.247 (d)

IC RSS-210 A8.5

Limit = -20 dBc

TEST PROCEDURE

The transmitter output is connected to a spectrum analyzer. The resolution bandwidth is set to 100 kHz. The video bandwidth is set to 300 kHz.

The spectrum from 30 MHz to 26 GHz is investigated with the transmitter set to the lowest, middle, and highest channels.

The band edges at 2.4 and 2.4835 GHz are investigated with the transmitter set to the normal hopping mode.

RESULTS

SPURIOUS EMISSIONS, LOW CHANNEL

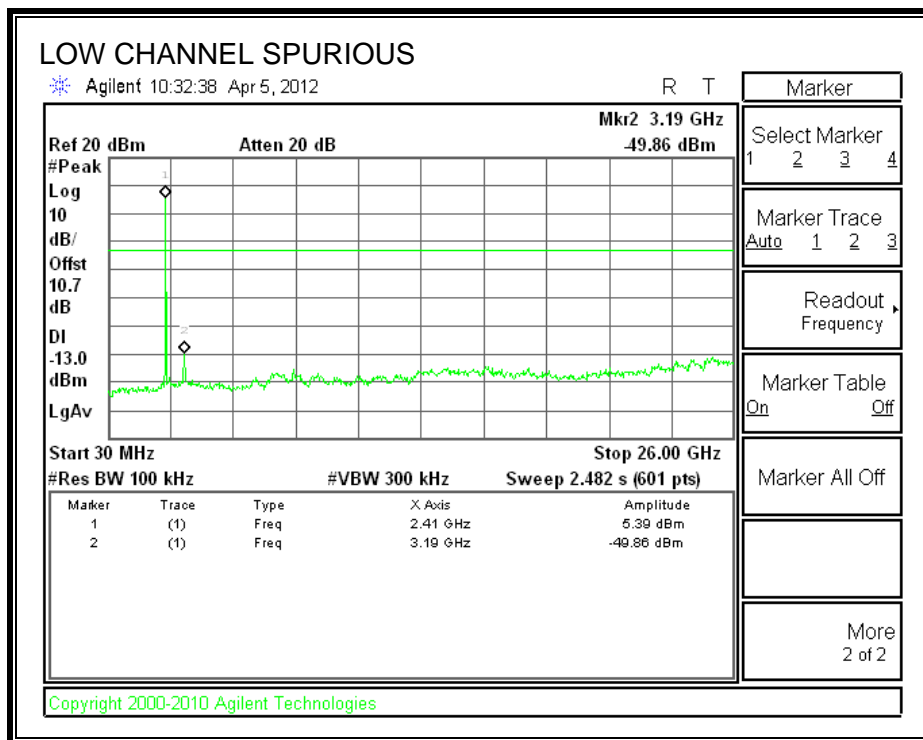
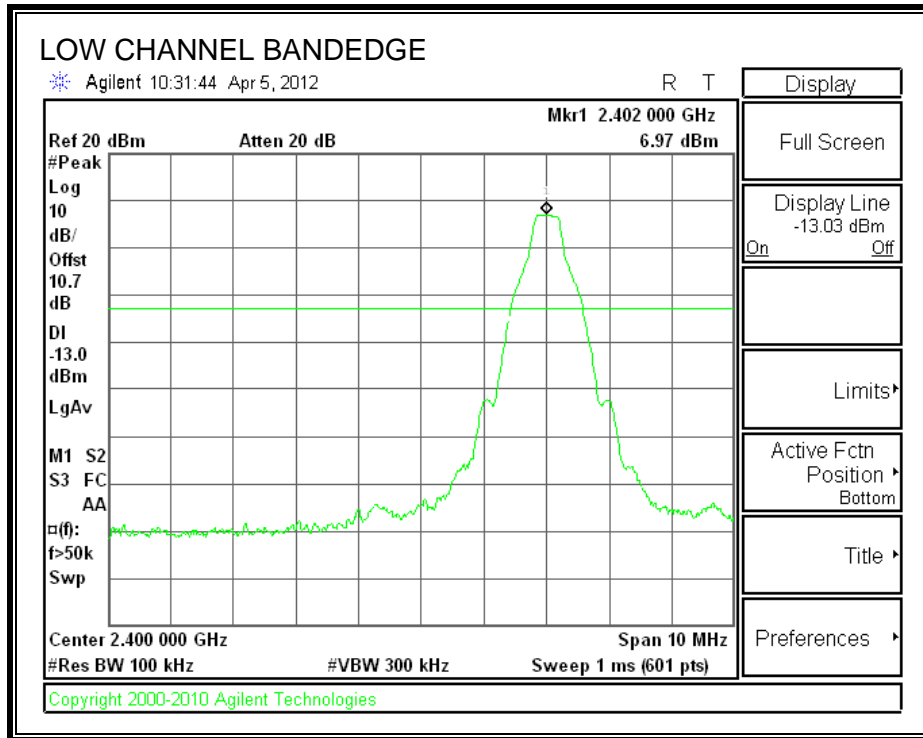

SPURIOUS EMISSIONS, MID CHANNEL

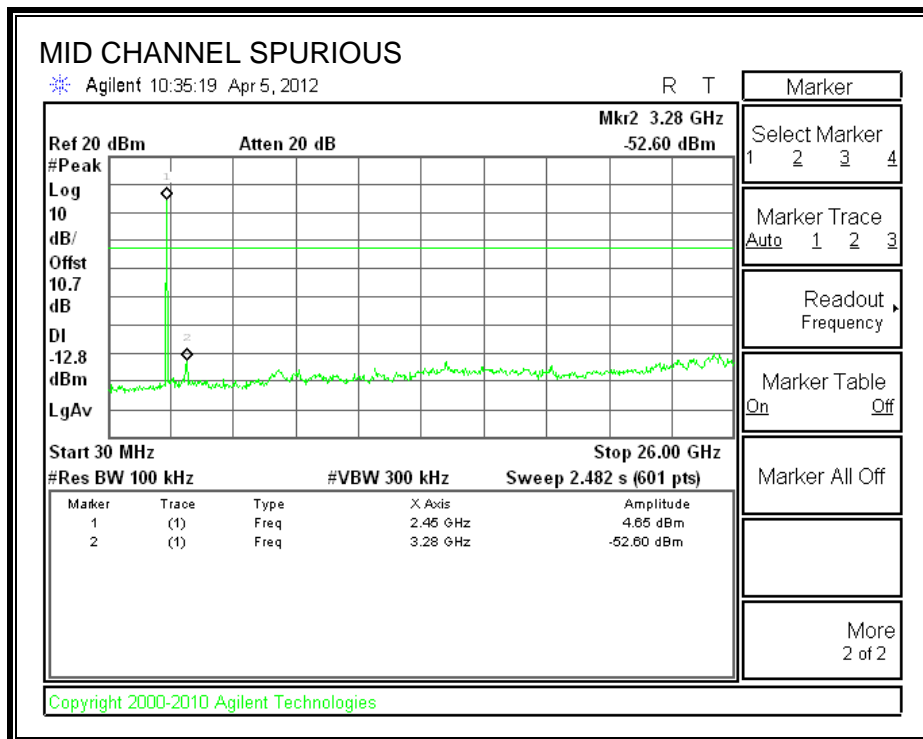
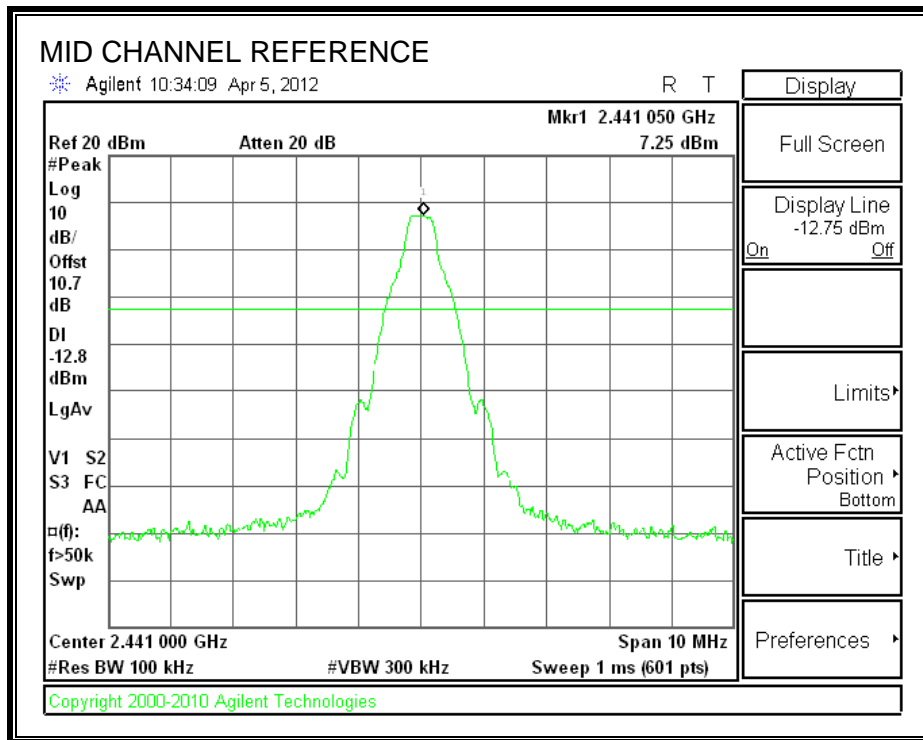

SPURIOUS EMISSIONS, HIGH CHANNEL

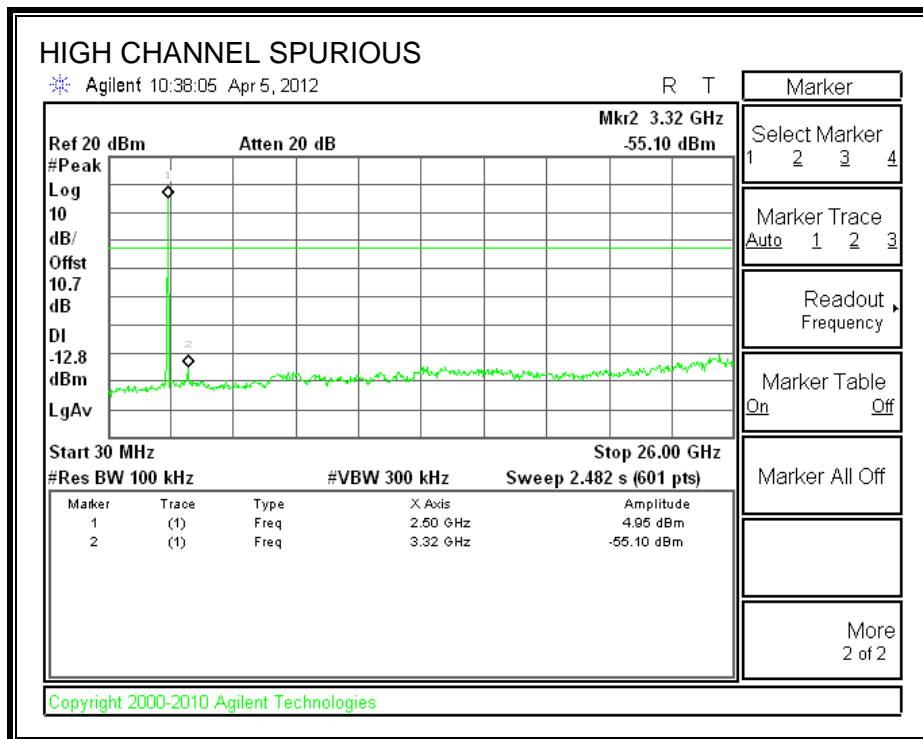
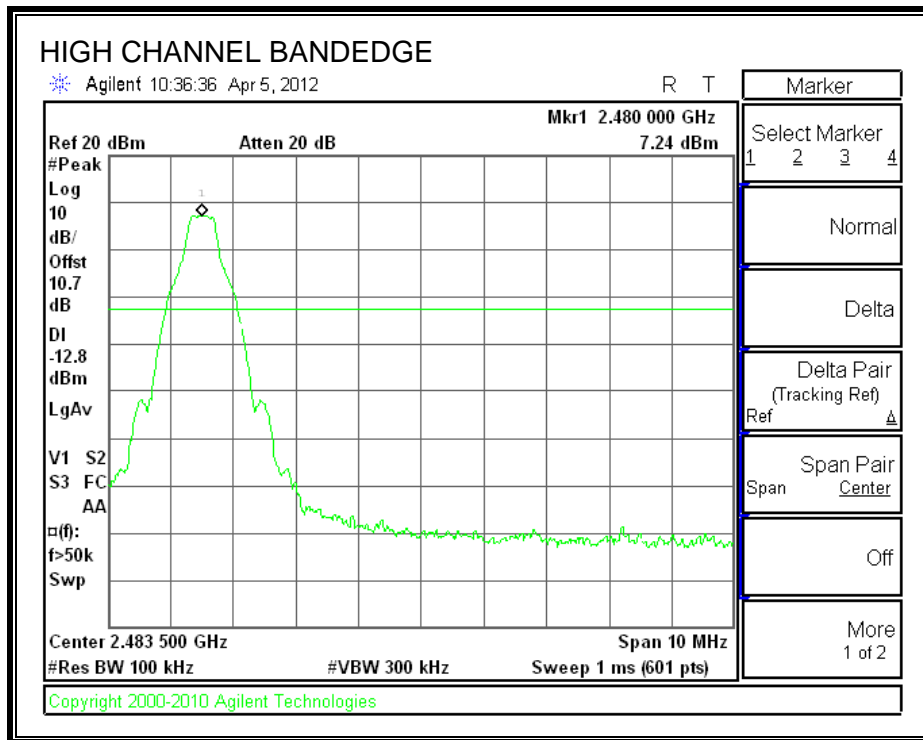

SPURIOUS BANDEDGE EMISSIONS WITH HOPPING ON

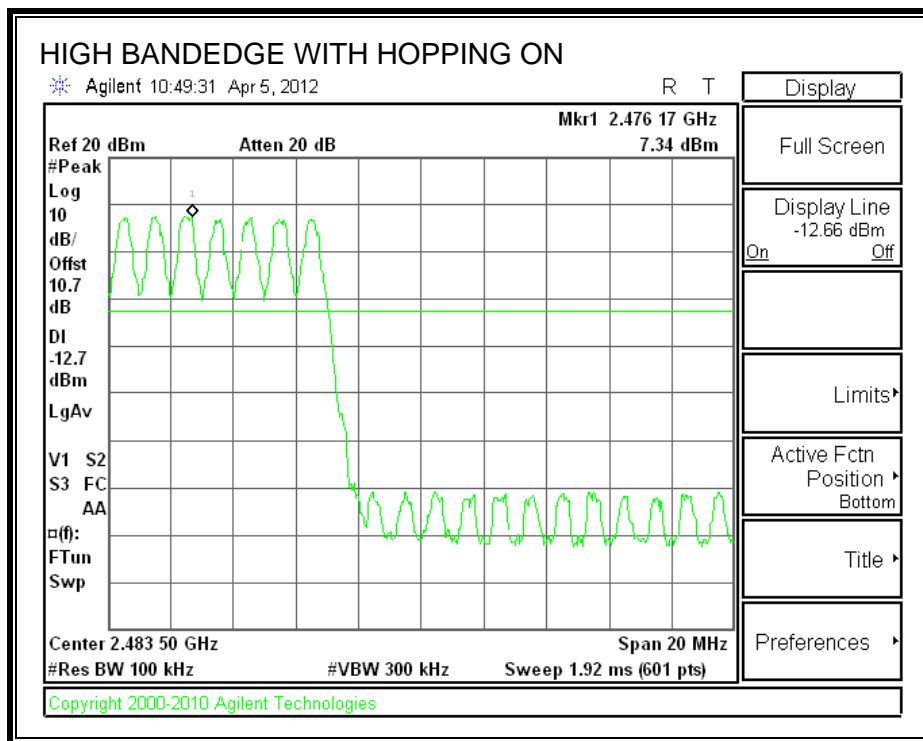
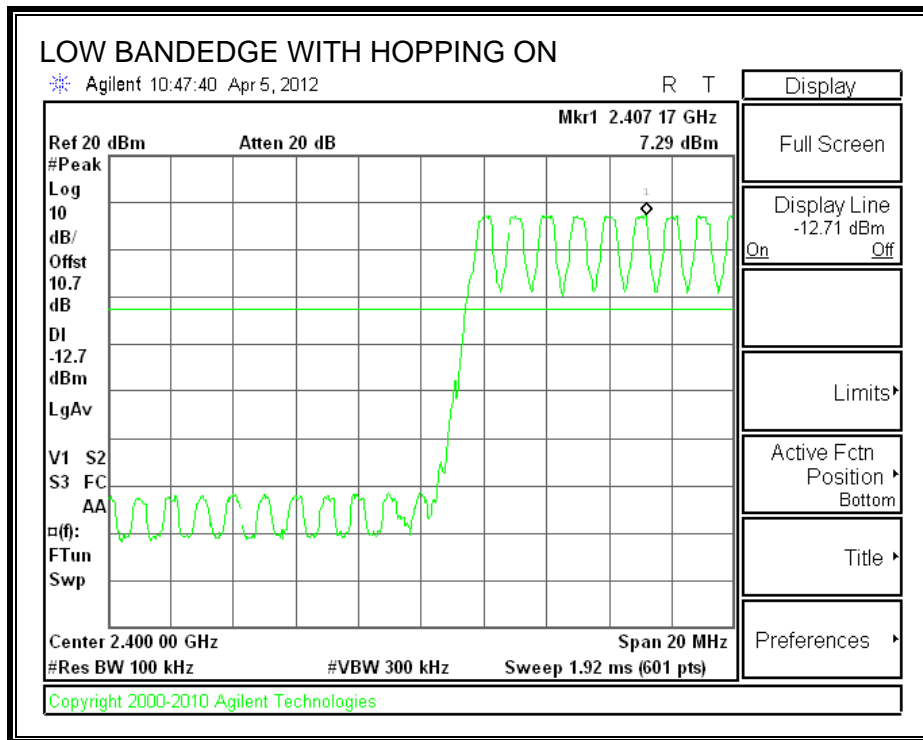

7.2. ENHANCED DATA RATE 8PSK MODULATION

7.2.1. 99% BANDWIDTH

LIMIT

None; for reporting purposes only.

TEST PROCEDURE

The transmitter output is connected to a spectrum analyzer. The RBW is set to $\geq 1\%$ of the 99% bandwidth. The VBW is set to \geq RBW. The sweep time is coupled.

RESULTS

Channel	Frequency (MHz)	99% Bandwidth (MHz)
Low	2402	1.2009
Middle	2441	1.2106
High	2480	1.2116

99% BANDWIDTH

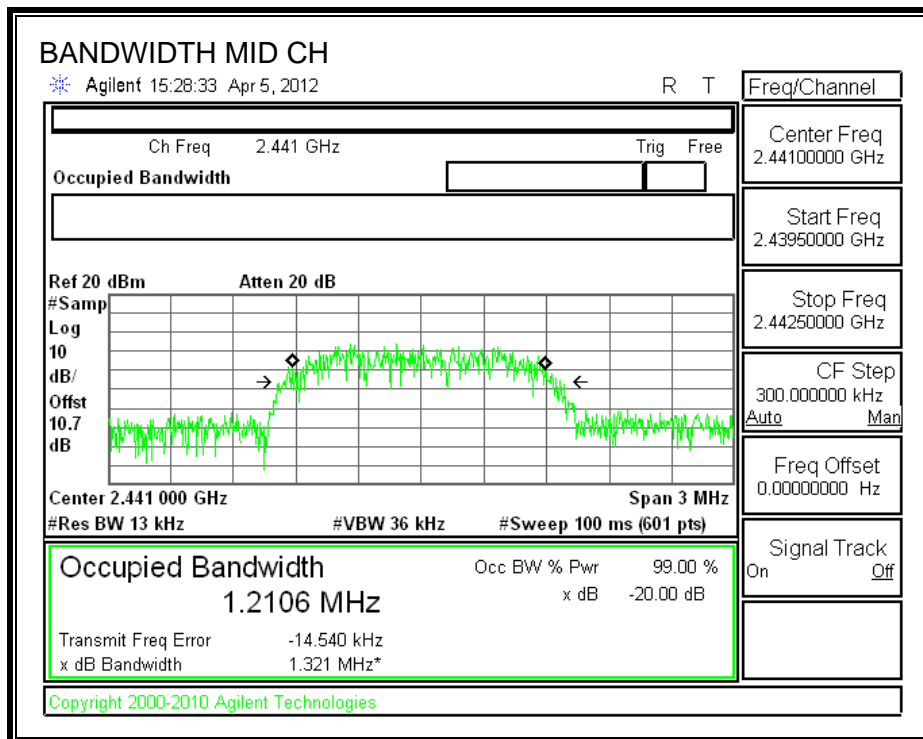
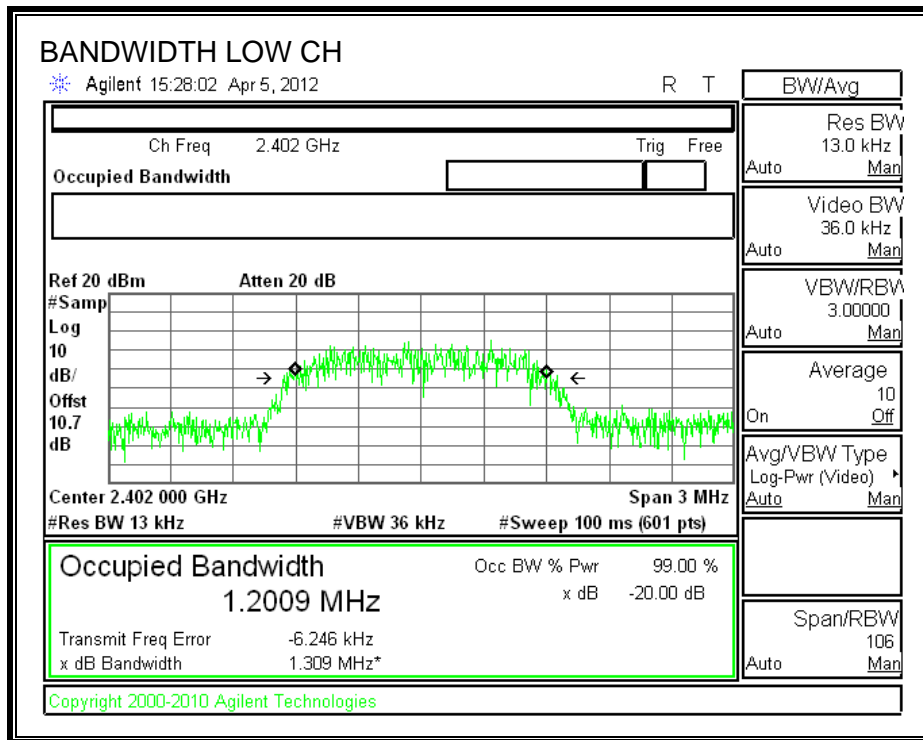

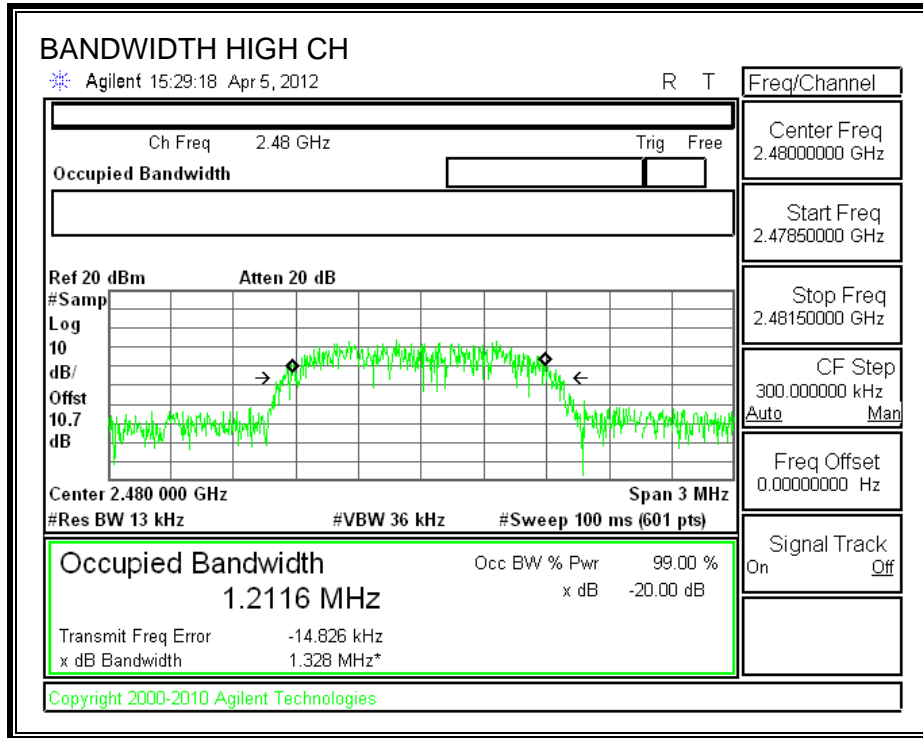

7.2.2. 20dB BANDWIDTH

LIMIT

None; for reporting purposes only.

TEST PROCEDURE

The transmitter output is connected to a spectrum analyzer. The RBW is set to $\geq 1\%$ of the 20dB bandwidth. The VBW is set to \geq RBW. The sweep time is coupled.

RESULTS

Channel	Frequency (MHz)	20 dB Bandwidth (MHz)
Low	2402	1.341
Middle	2441	1.341
High	2480	1.343

20 dB BANDWIDTH

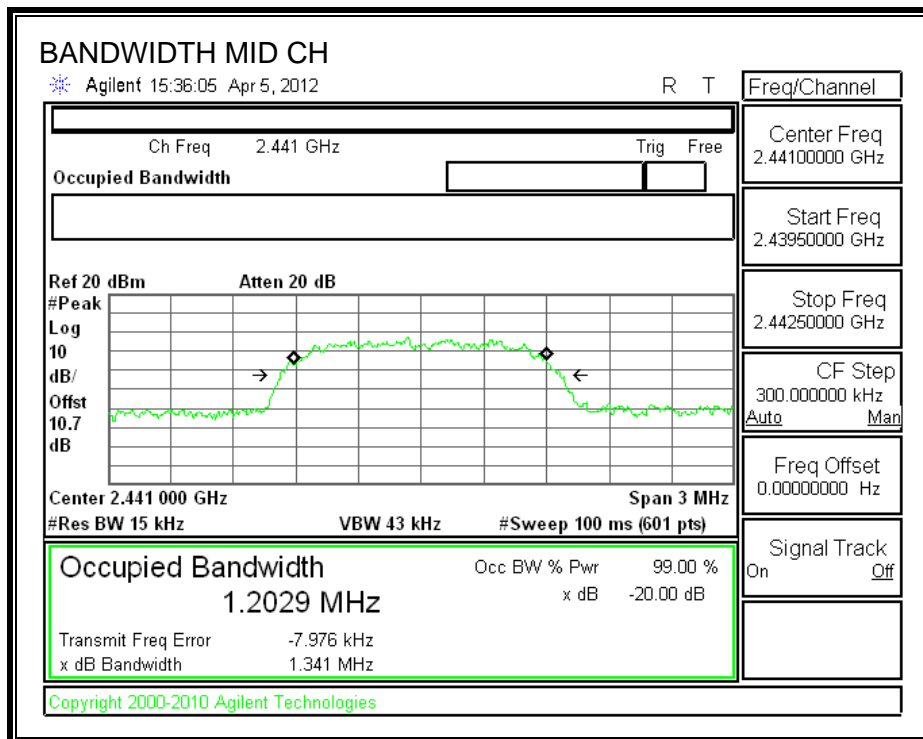
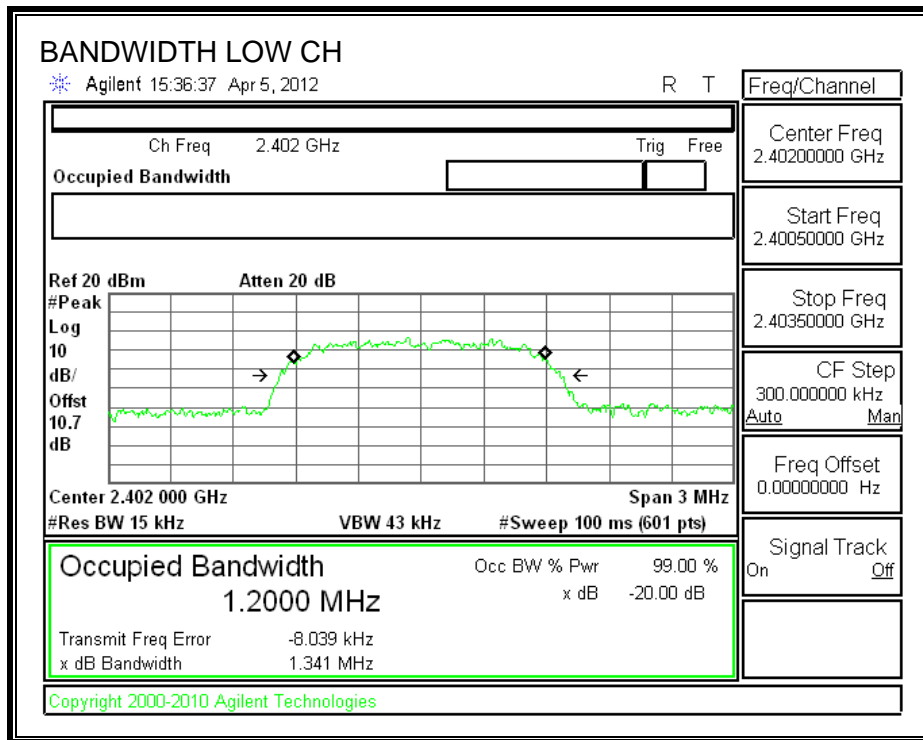

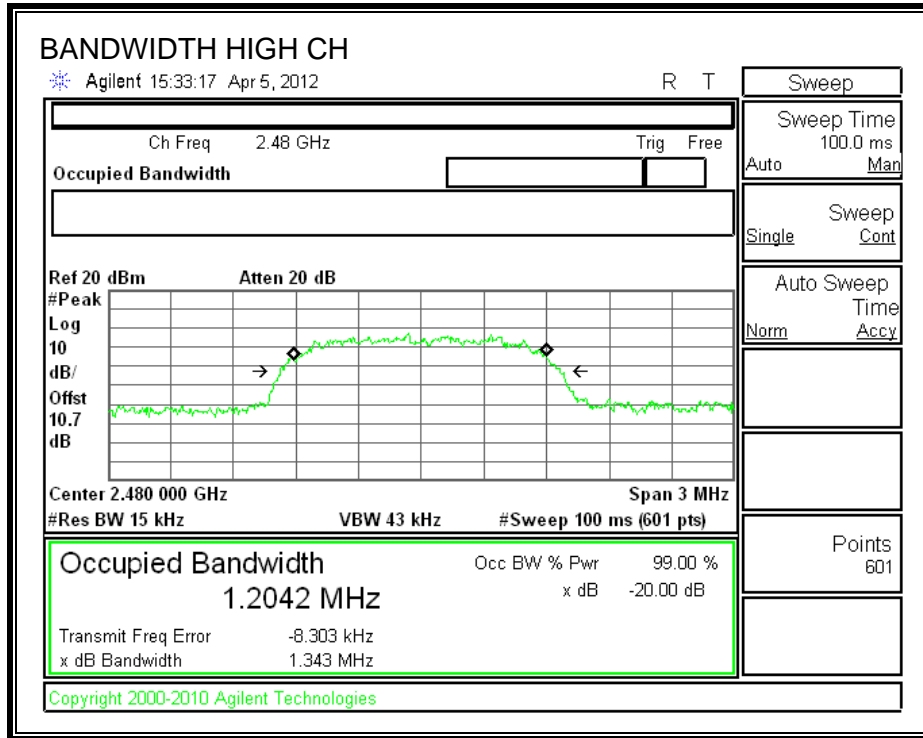

7.2.3. HOPPING FREQUENCY SEPARATION

LIMIT

FCC §15.247 (a) (1)

IC RSS-210 A8.1 (b)

Frequency hopping systems shall have hopping channel carrier frequencies separated by a minimum of 25 kHz or the 20 dB bandwidth of the hopping channel, whichever is greater.

Alternatively, frequency hopping systems operating in the 2400-2483.5 MHz band may have hopping channel carrier frequencies that are separated by 25 kHz or two-thirds of the 20 dB bandwidth of the hopping channel, whichever is greater, provided the systems operate with an output power no greater than 125 mW.

TEST PROCEDURE

The transmitter output is connected to a spectrum analyzer. The RBW is set to 100 kHz and the VBW is set to 100 kHz. The sweep time is coupled.

RESULTS

HOPPING FREQUENCY SEPARATION

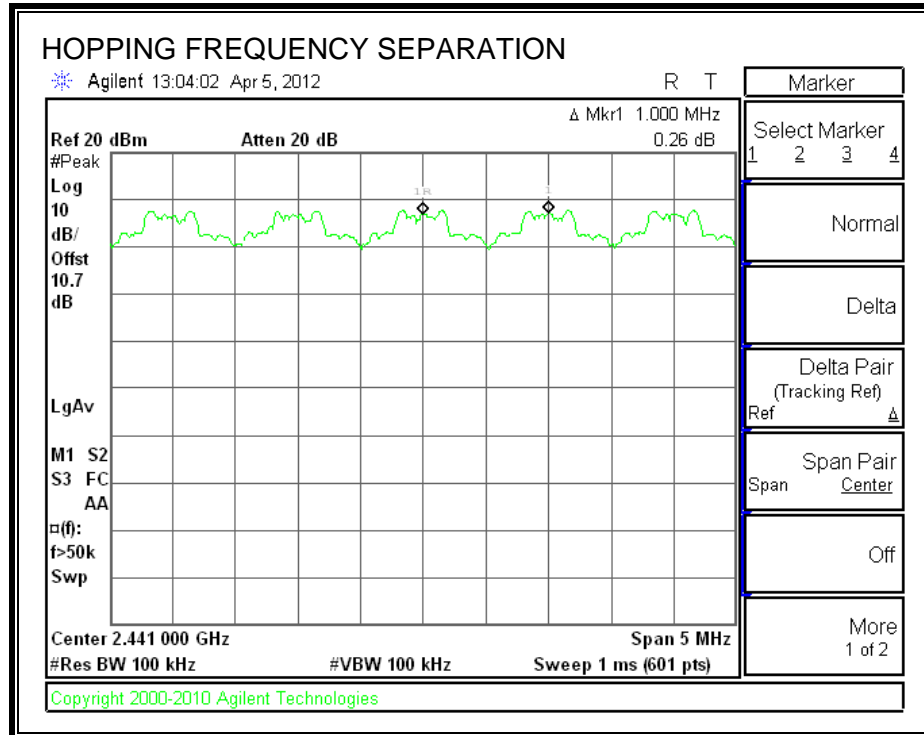

7.2.4. NUMBER OF HOPPING CHANNELS

LIMIT

FCC §15.247 (a) (1) (iii)

IC RSS-210 A8.1 (d)

Frequency hopping systems in the 2400 – 2483.5 MHz band shall use at least 15 non-overlapping channels.

TEST PROCEDURE

The transmitter output is connected to a spectrum analyzer. The span is set to cover the entire authorized band, in either a single sweep or in multiple contiguous sweeps. The RBW is set to a maximum of 1 % of the span. The analyzer is set to Max Hold.

RESULTS

Normal Mode: Minimum channels are 20 and maximum channels are 79

AFH Mode: Minimum channels are 20 and maximum channels are 79

NUMBER OF HOPPING CHANNELS

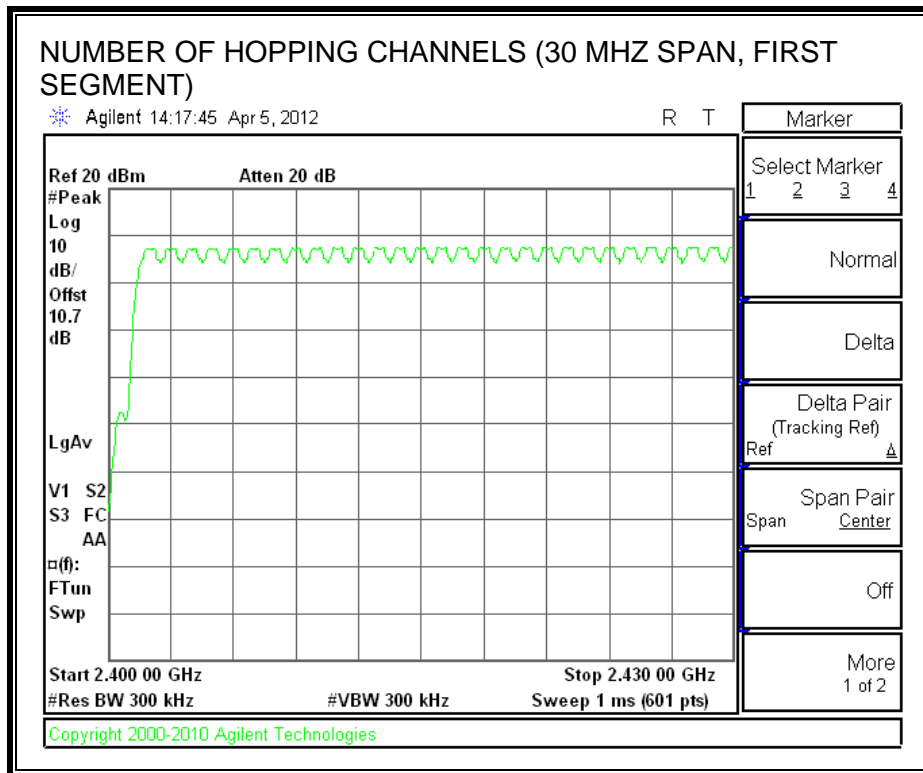
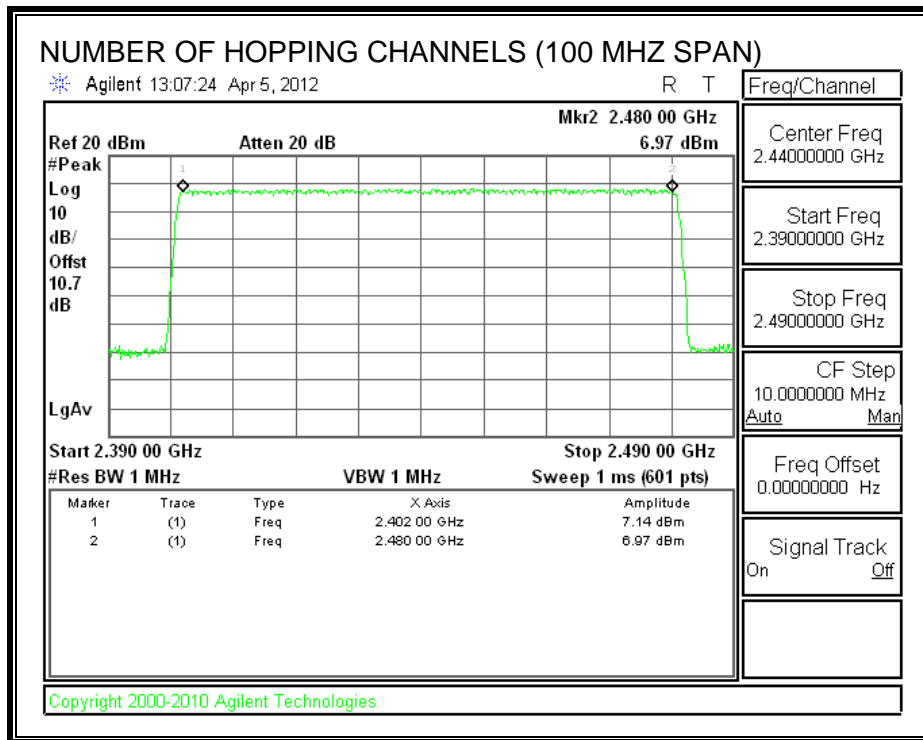

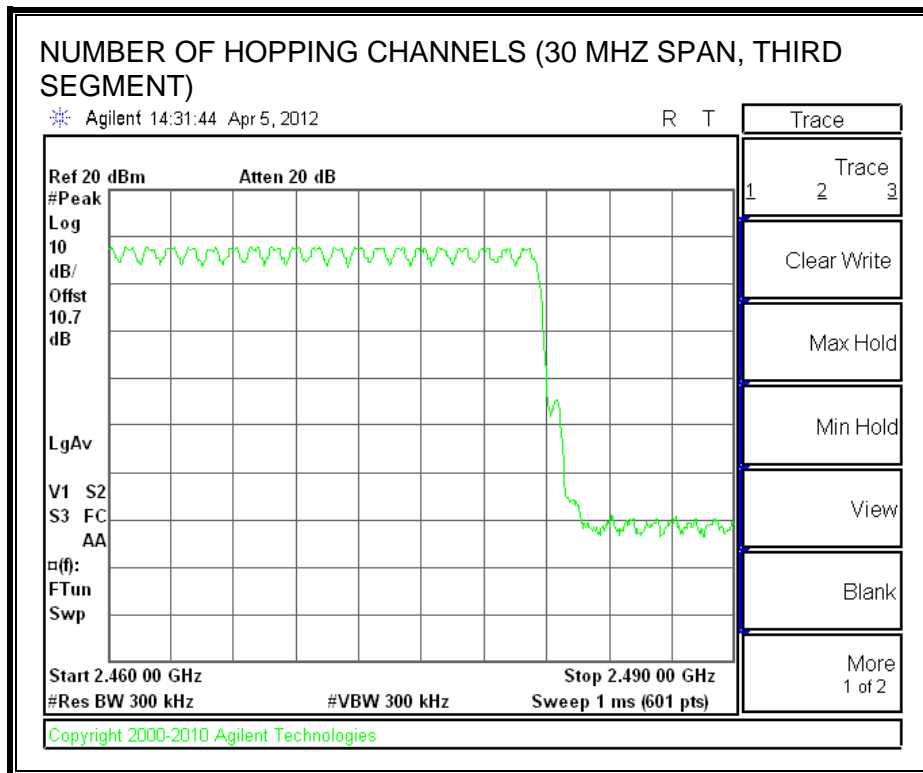
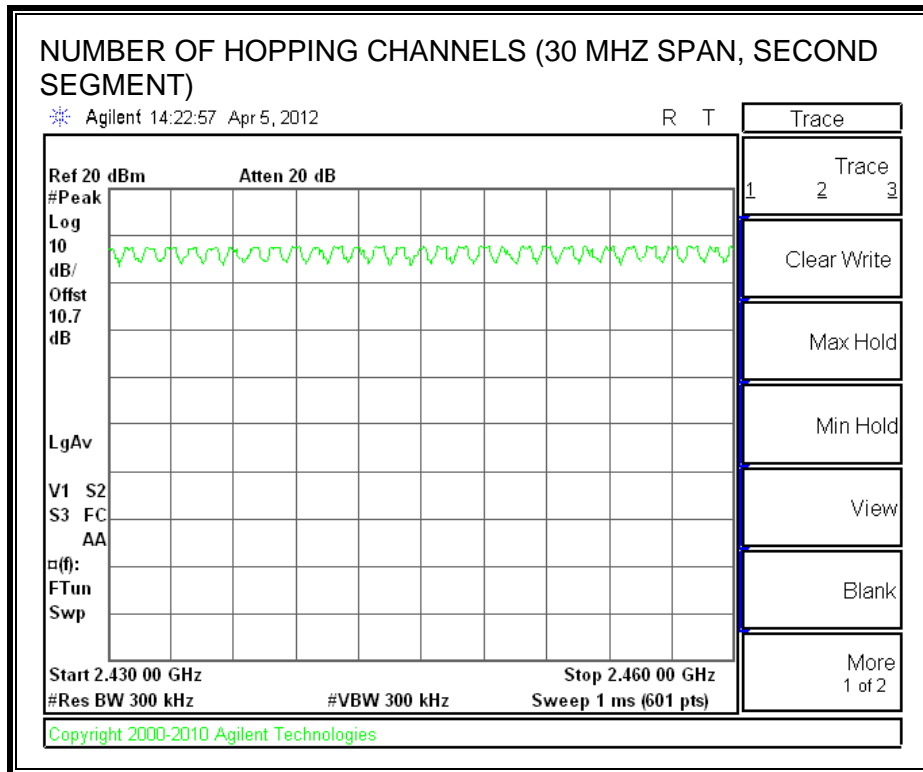

7.2.5. AVERAGE TIME OF OCCUPANCY

LIMIT

FCC §15.247 (a) (1) (iii)

IC RSS-210 A8.1 (d)

The average time of occupancy on any channel shall not be greater than 0.4 seconds within a period of 0.4 seconds multiplied by the number of hopping channels employed.

TEST PROCEDURE

The transmitter output is connected to a spectrum analyzer. The span is set to 0 Hz, centered on a single, selected hopping channel. The width of a single pulse is measured in a fast scan. The number of pulses is measured in a 3.16 second scan, to enable resolution of each occurrence.

The average time of occupancy in the specified 31.6 second period (79 channels * 0.4 s) is equal to $10 * (\# \text{ of pulses in } 3.16 \text{ s}) * \text{ pulse width}$.

RESULTS

DH Packet	Pulse Width (msec)	Number of Pulses in 3.16 seconds	Average Time of Occupancy (sec)	Limit (sec)	Margin (sec)
DH1	0.4450	32	0.1424	0.4	-0.2576
DH3	1.7030	19	0.3236	0.4	-0.0764
DH5	2.9520	13	0.3838	0.4	-0.0162

DH1

PULSE WIDTH

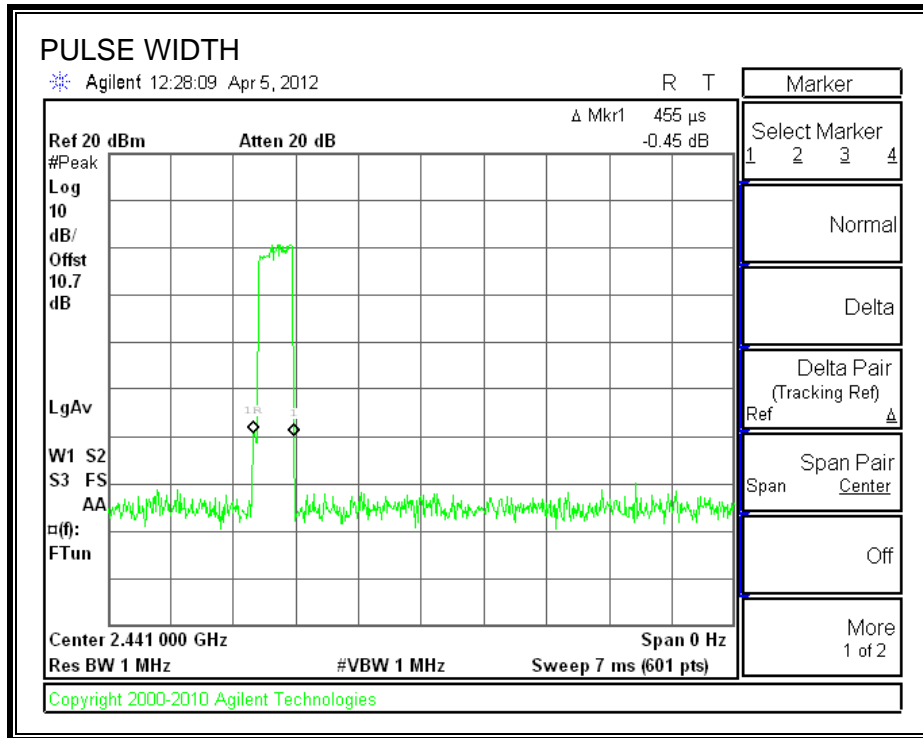

NUMBER OF PULSES IN 3.16 SECOND OBSERVATION PERIOD

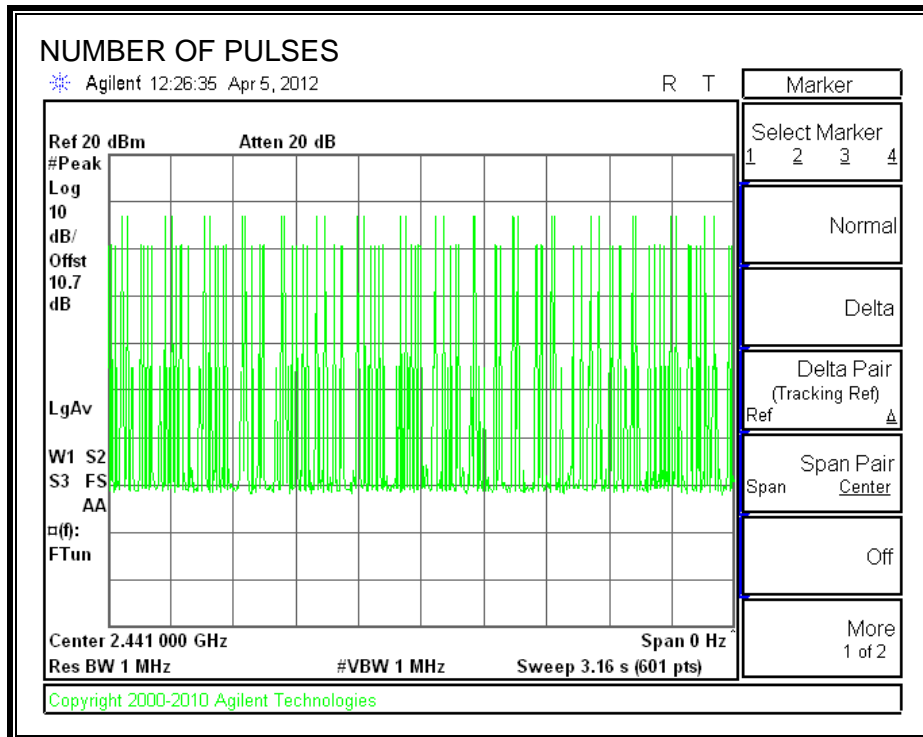

DH3

PULSE WIDTH

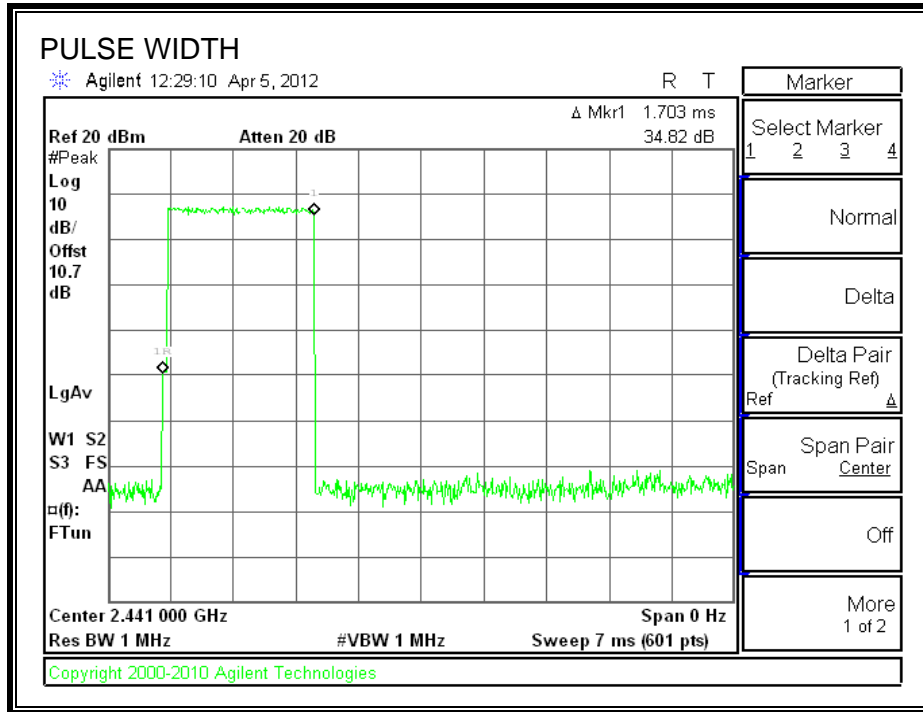

NUMBER OF PULSES IN 3.16 SECOND OBSERVATION PERIOD

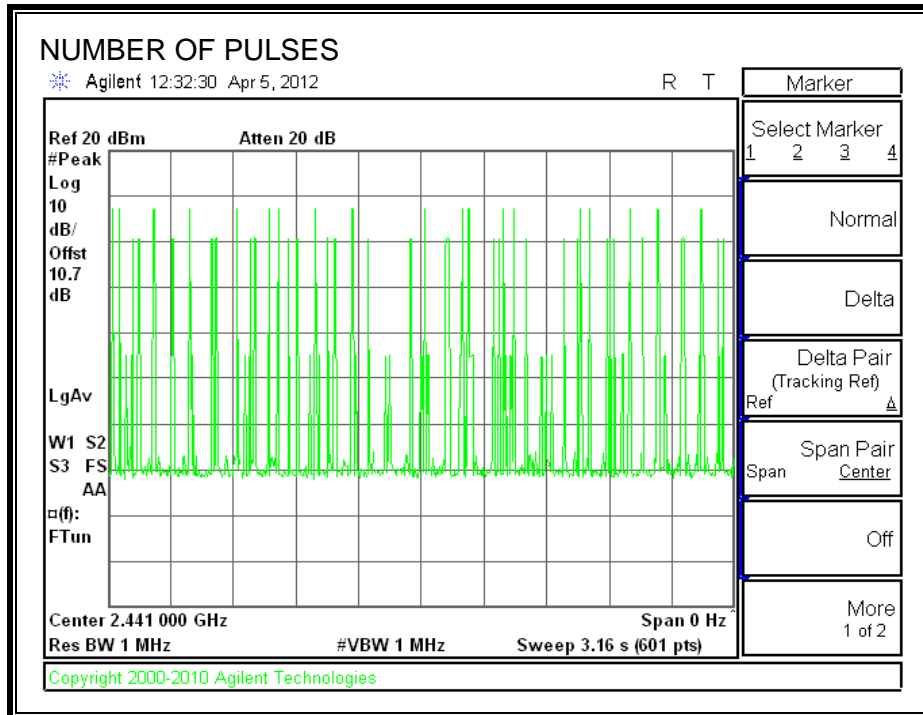

DH5

PULSE WIDTH

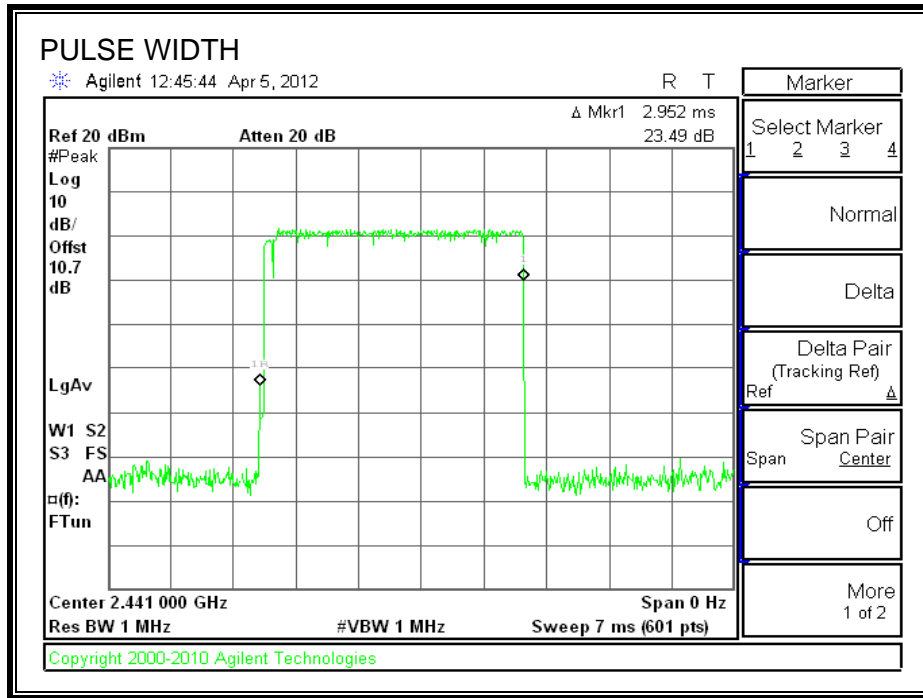

NUMBER OF PULSES IN 3.16 SECOND OBSERVATION PERIOD

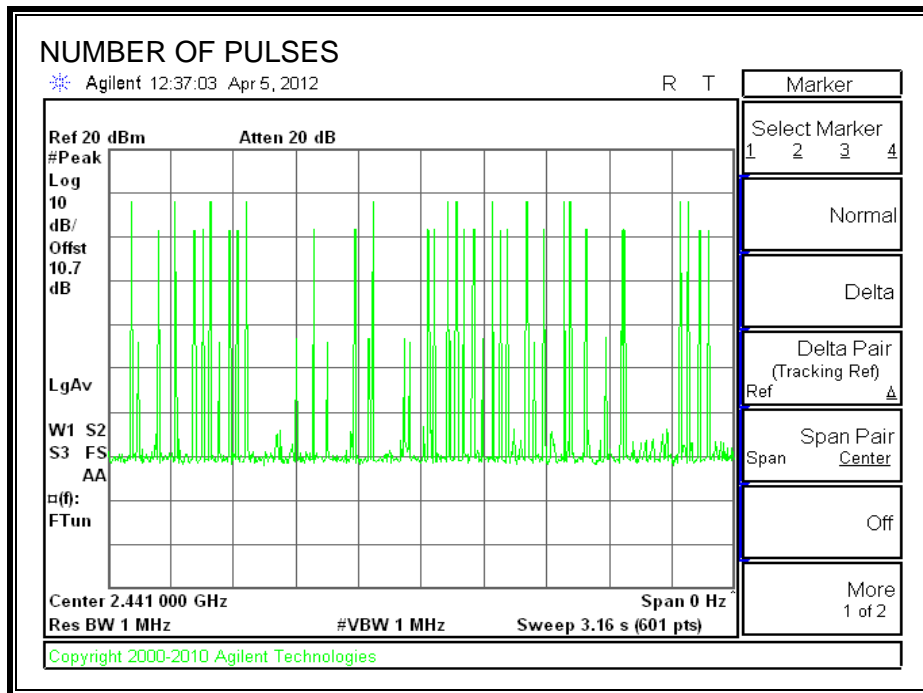

7.2.6. OUTPUT POWER

LIMIT

§15.247 (b) (1)

RSS-210 Issue 7 Clause A8.4

The maximum antenna gain is less than 6 dBi, therefore the limit is 20.97 dBm.

Alternatively, frequency hopping systems operating in the 2400-2483.5 MHz band may have hopping channel carrier frequencies that are separated by 25 kHz or two-thirds of the 20 dB bandwidth of the hopping channel, whichever is greater, provided the systems operate with an output power no greater than 125 mW.

TEST PROCEDURE

The transmitter output is connected to a spectrum analyzer the analyzer bandwidth is set to a value greater than the 20 dB bandwidth of the EUT.

RESULTS

Channel	Frequency (MHz)	Output Power (dBm)	Limit (dBm)	Margin (dB)
Low	2402	7.19	20.97	-13.78
Middle	2441	7.58	20.97	-13.39
High	2480	7.53	20.97	-13.44

OUTPUT POWER

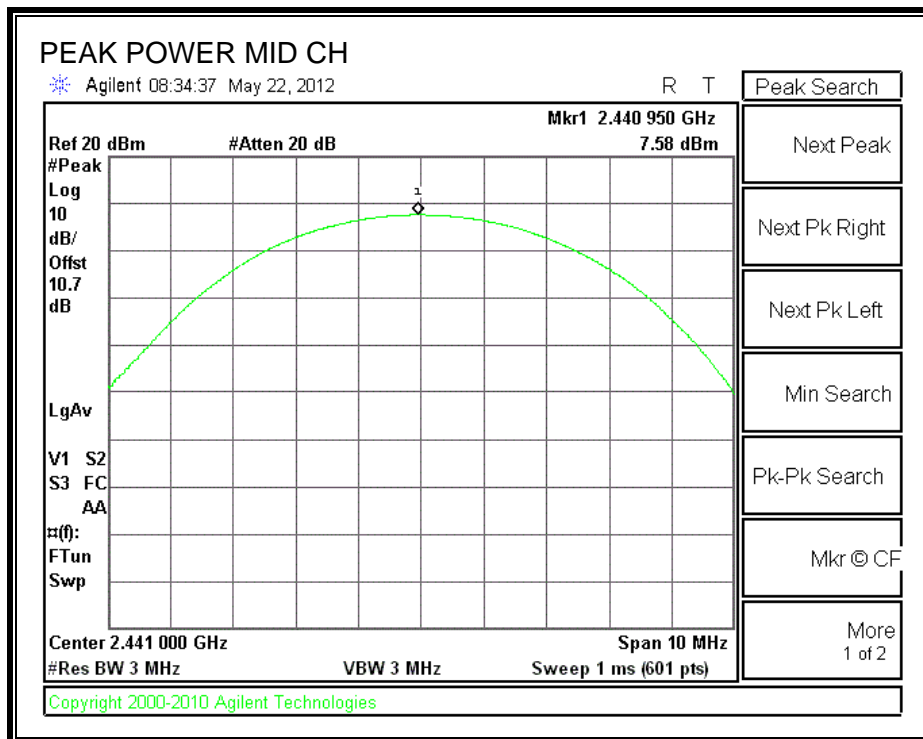
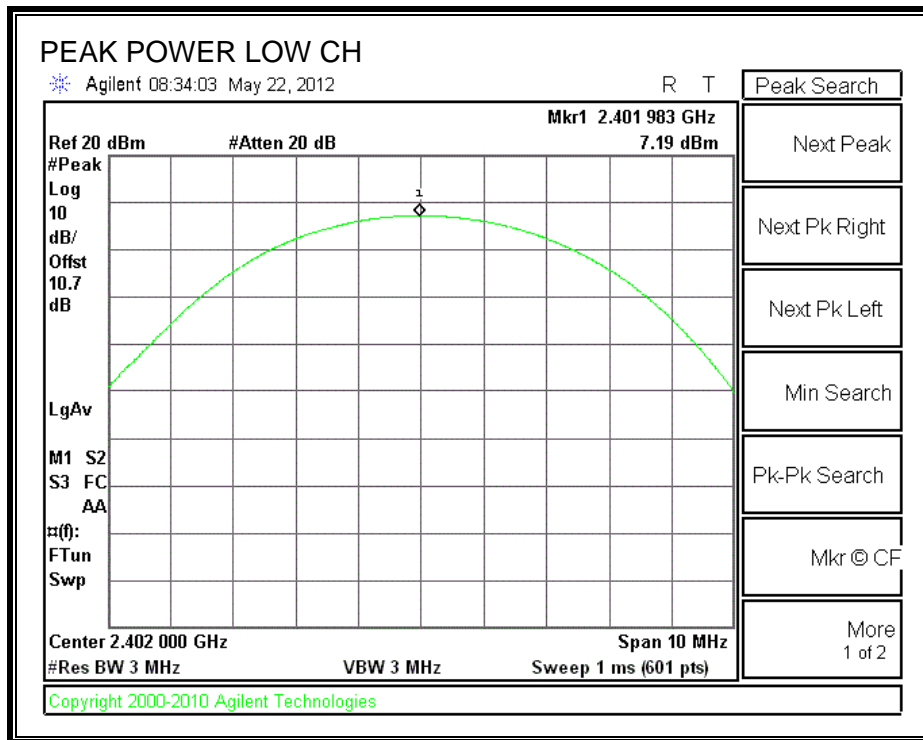

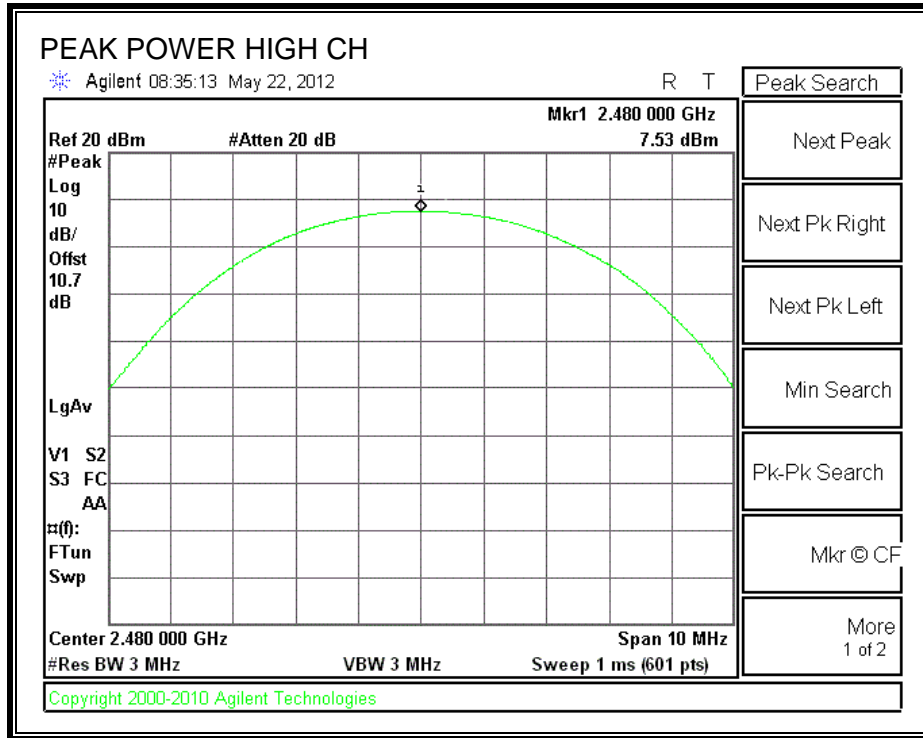

7.2.7. CONDUCTED SPURIOUS EMISSIONS

LIMITS

FCC §15.247 (d)

IC RSS-210 A8.5

Limit = -20 dBc

TEST PROCEDURE

The transmitter output is connected to a spectrum analyzer. The resolution bandwidth is set to 100 kHz. The video bandwidth is set to 300 kHz.

The spectrum from 30 MHz to 26 GHz is investigated with the transmitter set to the lowest, middle, and highest channels.

The band edges at 2.4 and 2.4835 GHz are investigated with the transmitter set to the normal hopping mode.

RESULTS

SPURIOUS EMISSIONS, LOW CHANNEL

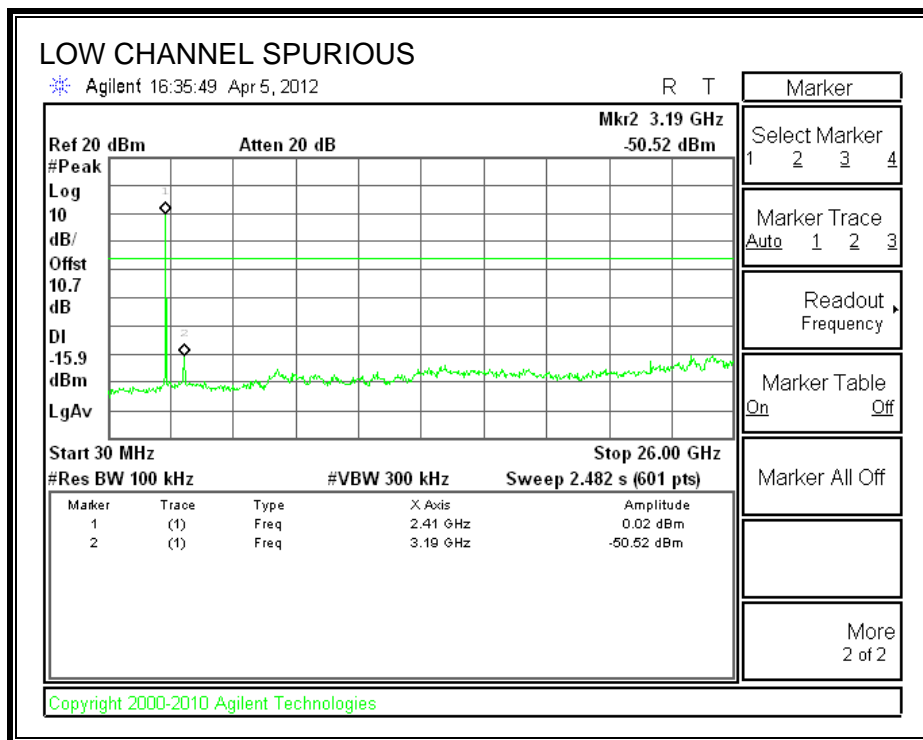
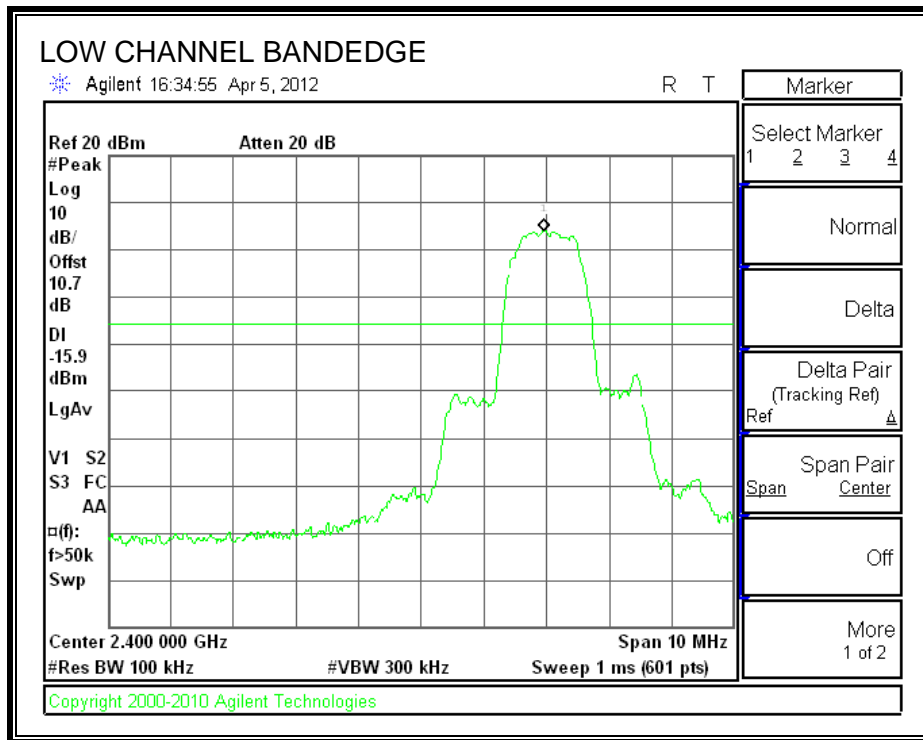

SPURIOUS EMISSIONS, MID CHANNEL

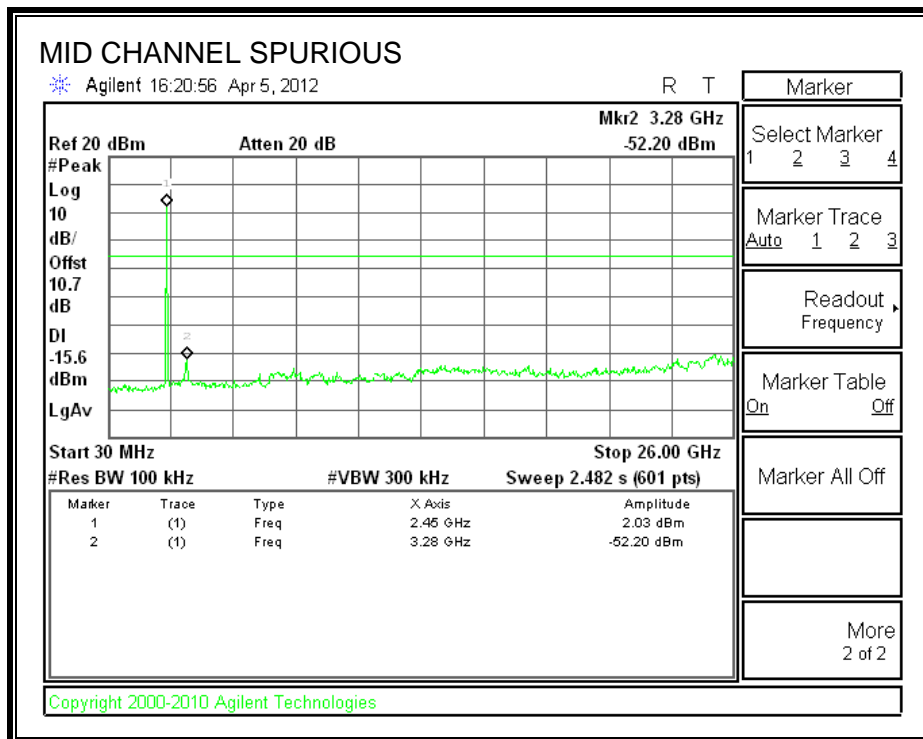
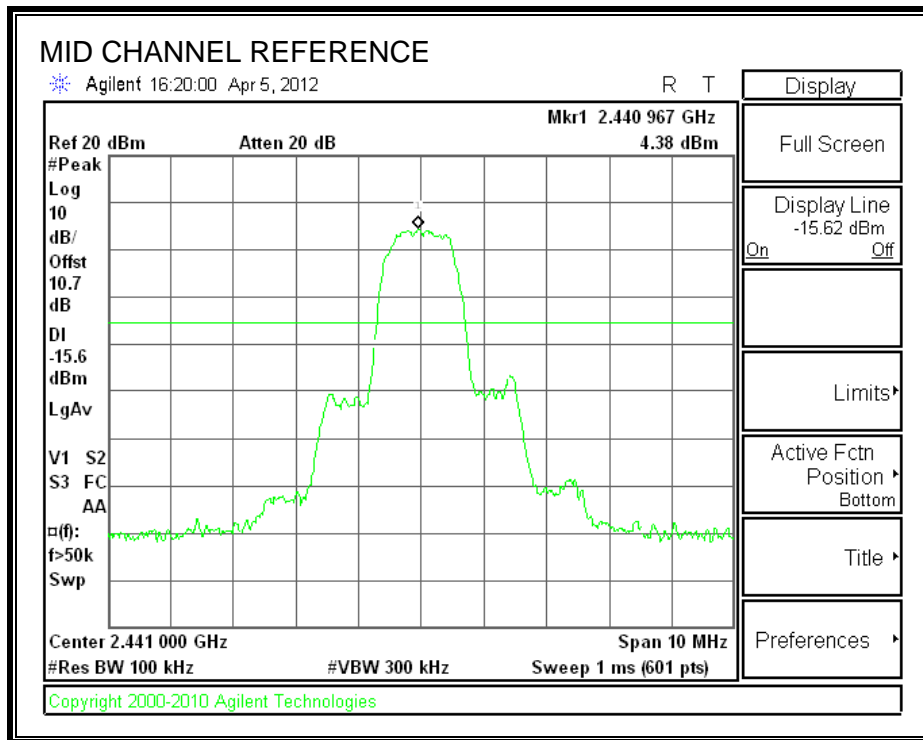

SPURIOUS EMISSIONS, HIGH CHANNEL

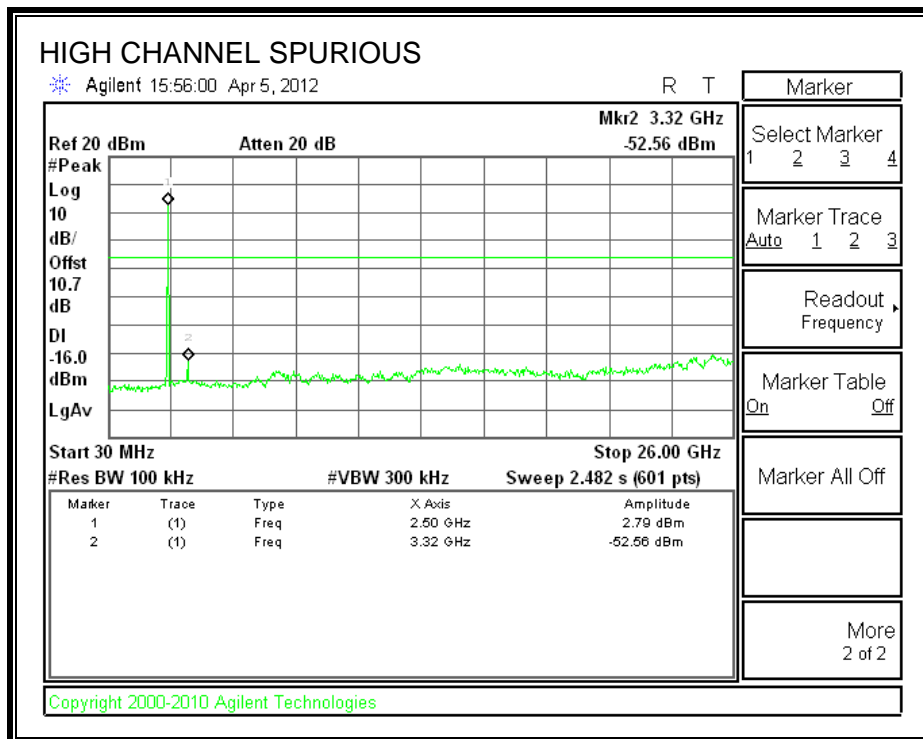
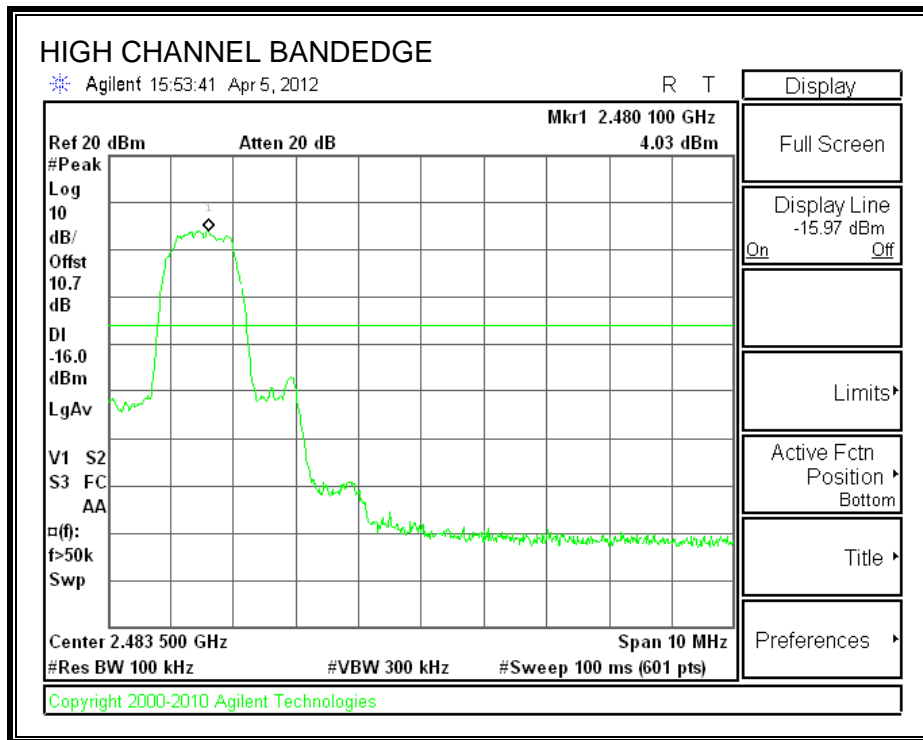

SPURIOUS BANDEDGE EMISSIONS WITH HOPPING ON

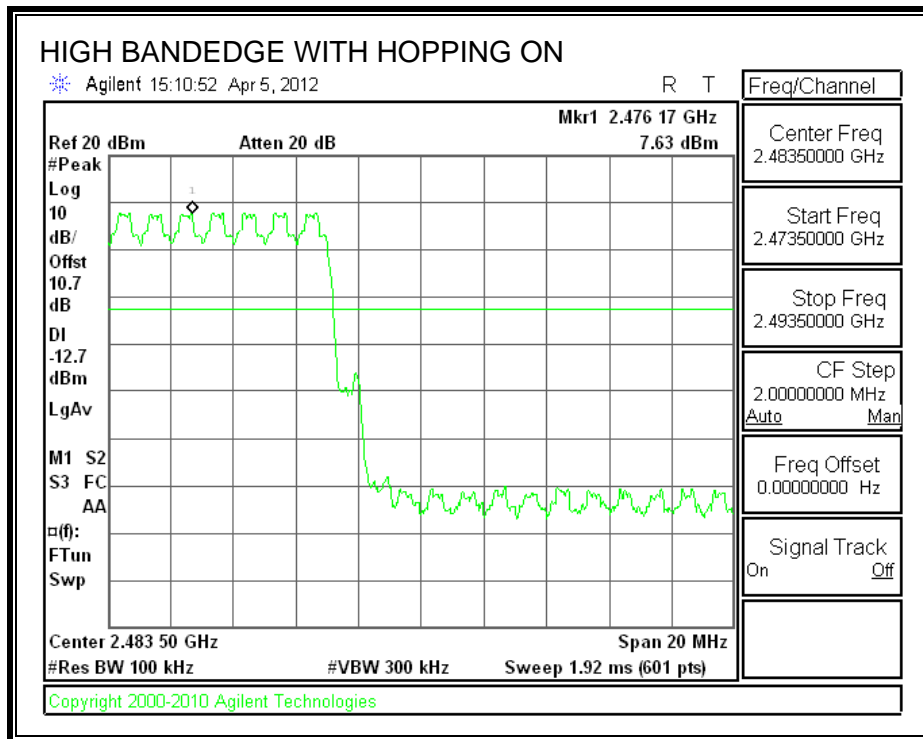
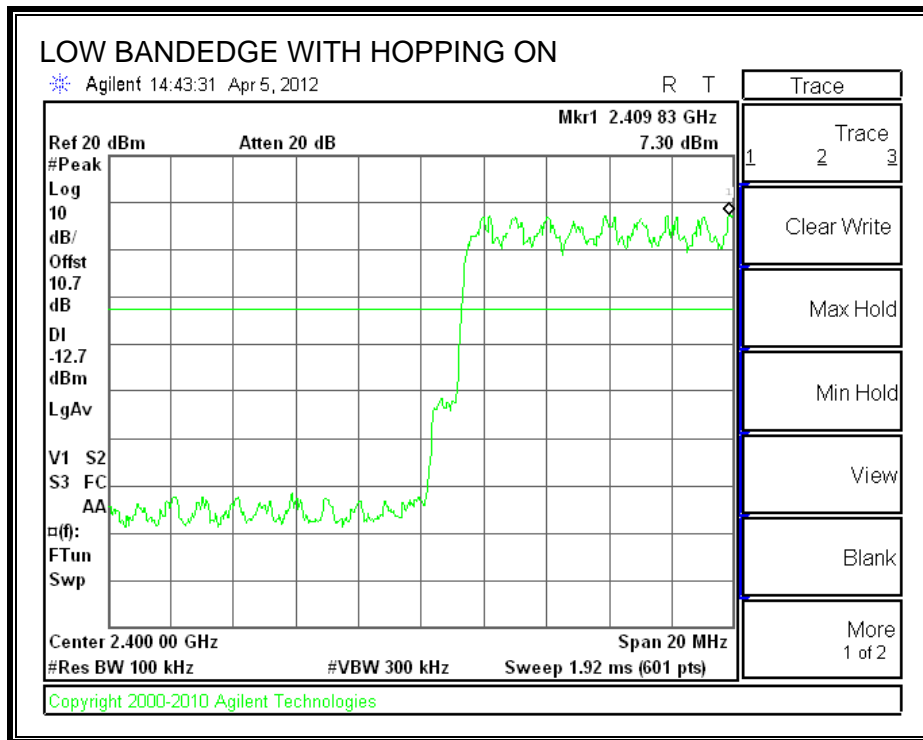

8. RADIATED TEST RESULTS

8.1. LIMITS AND PROCEDURE

LIMITS

FCC §15.205 and §15.209

IC RSS-210 Clause 2.6 (Transmitter)

IC RSS-GEN Clause 6 (Receiver)

Frequency Range (MHz)	Field Strength Limit (uV/m) at 3 m	Field Strength Limit (dBuV/m) at 3 m
30 - 88	100	40
88 - 216	150	43.5
216 - 960	200	46
Above 960	500	54

TEST PROCEDURE

The EUT is placed on a non-conducting table 80 cm above the ground plane. The antenna to EUT distance is 3 meters. The EUT is configured in accordance with ANSI C63.4. The EUT is set to transmit in a continuous mode.

For measurements below 1 GHz the resolution bandwidth is set to 100 kHz for peak detection measurements or 120 kHz for quasi-peak detection measurements. Peak detection is used unless otherwise noted as quasi-peak.

For measurements above 1 GHz the resolution bandwidth is set to 1 MHz, and then the video bandwidth is set to 1 MHz for peak measurements and 10 Hz for average measurements.

The spectrum from 30 MHz to 26 GHz is investigated with the transmitter set to the lowest, middle, and highest channels in the 2.4 GHz band.

The frequency range of interest is monitored at a fixed antenna height and EUT azimuth. The EUT is rotated through 360 degrees to maximize emissions received. The antenna is scanned from 1 to 4 meters above the ground plane to further maximize the emission. Measurements are made with the antenna polarized in both the vertical and the horizontal positions.

8.2. TX SPURIOUS ABOVE 1 GHz

8.2.1. BASIC DATA RATE GFSK MODULATION

RESTRICTED BANDEDGE (LOW CHANNEL, HORIZONTAL)

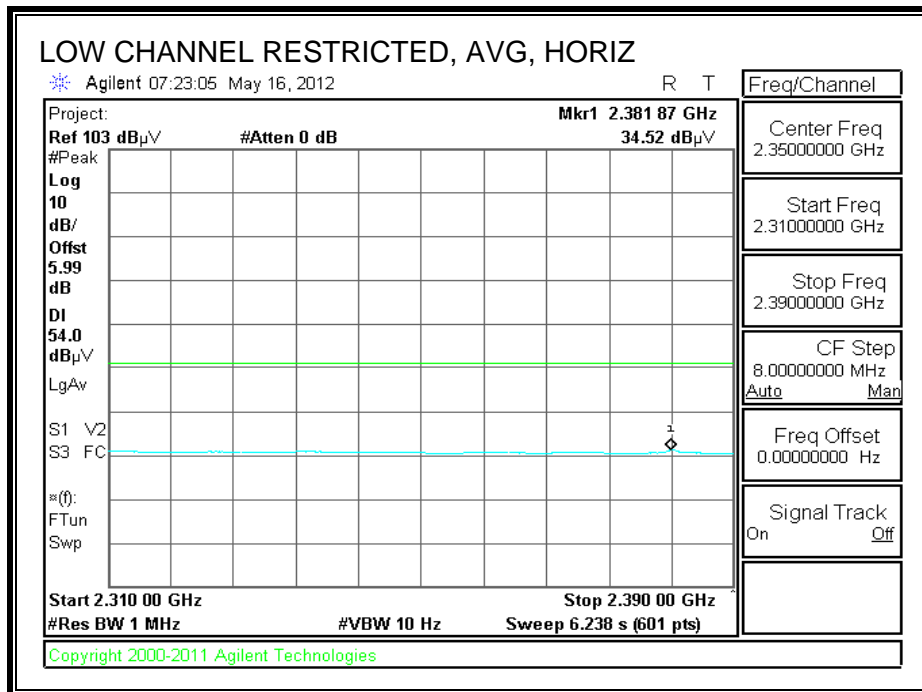
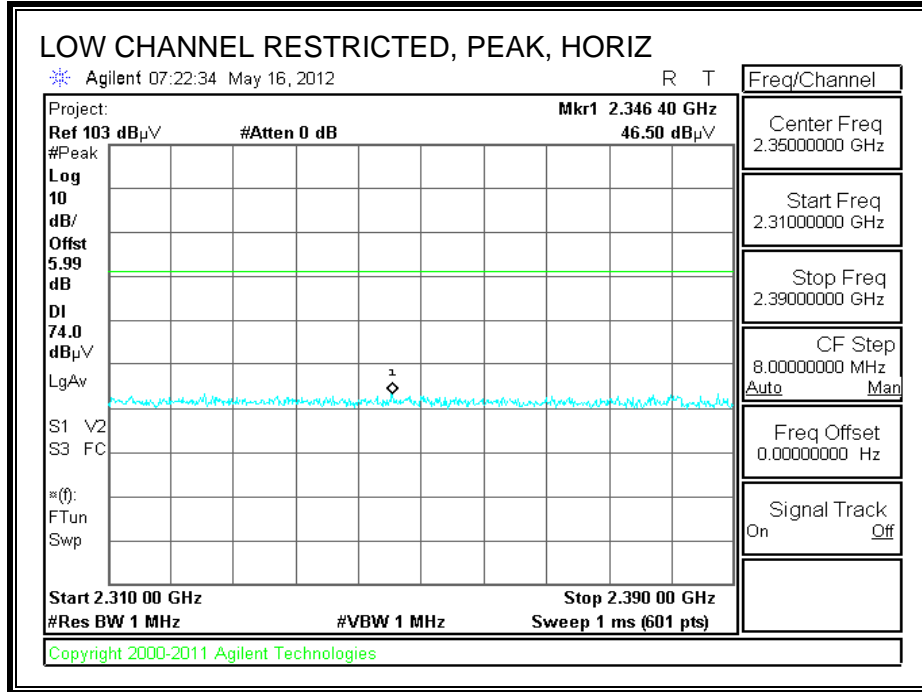

RESTRICTED BANDEDGE (LOW CHANNEL, VERTICAL)

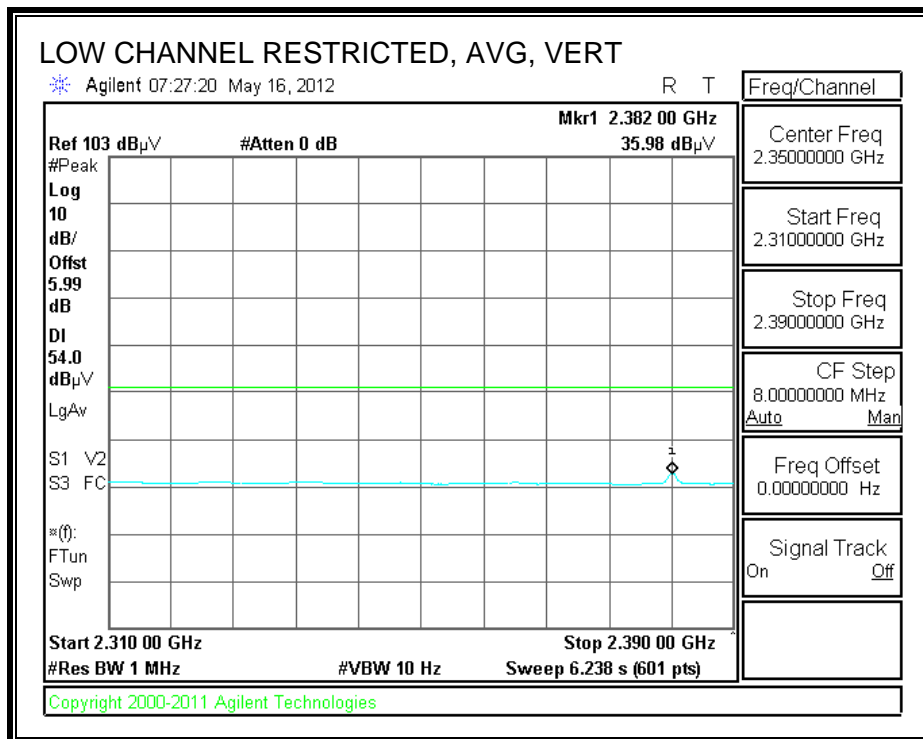
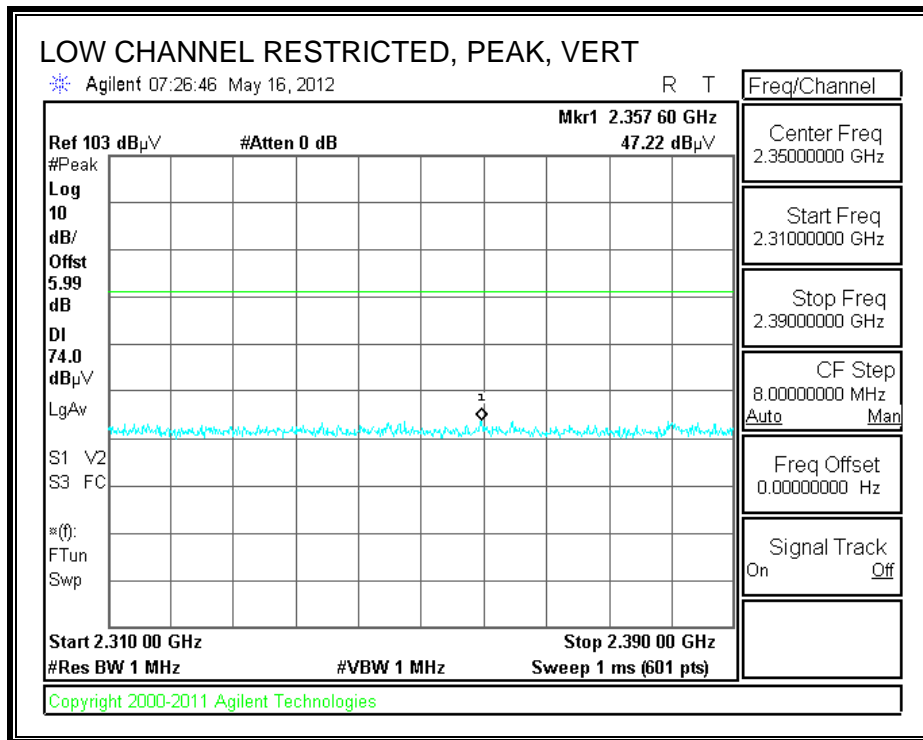

RESTRICTED BANDEDGE (HIGH CHANNEL, HORIZONTAL)

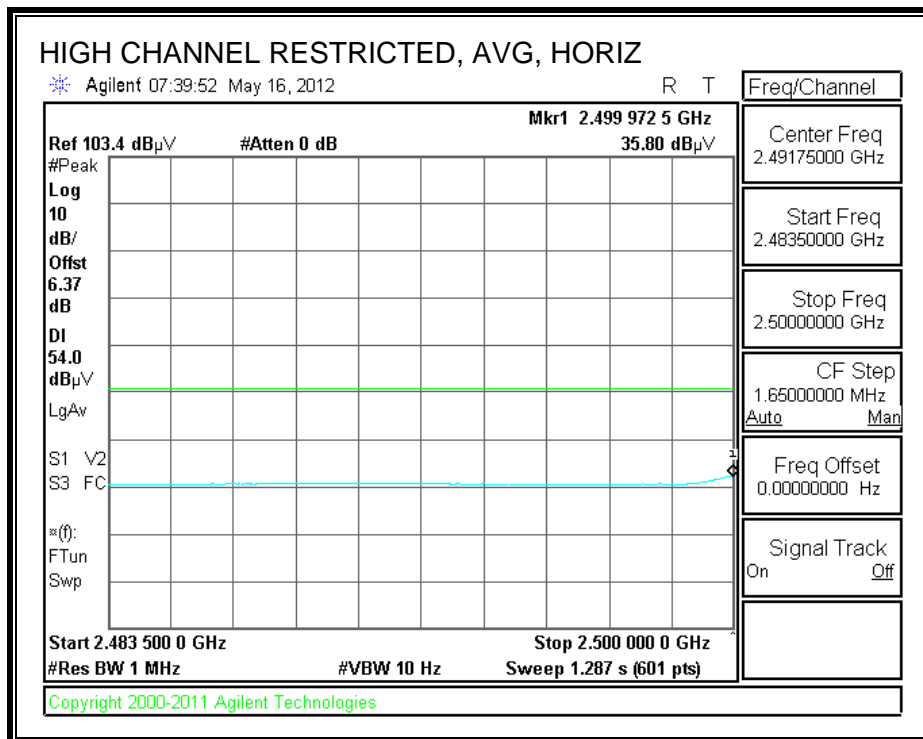
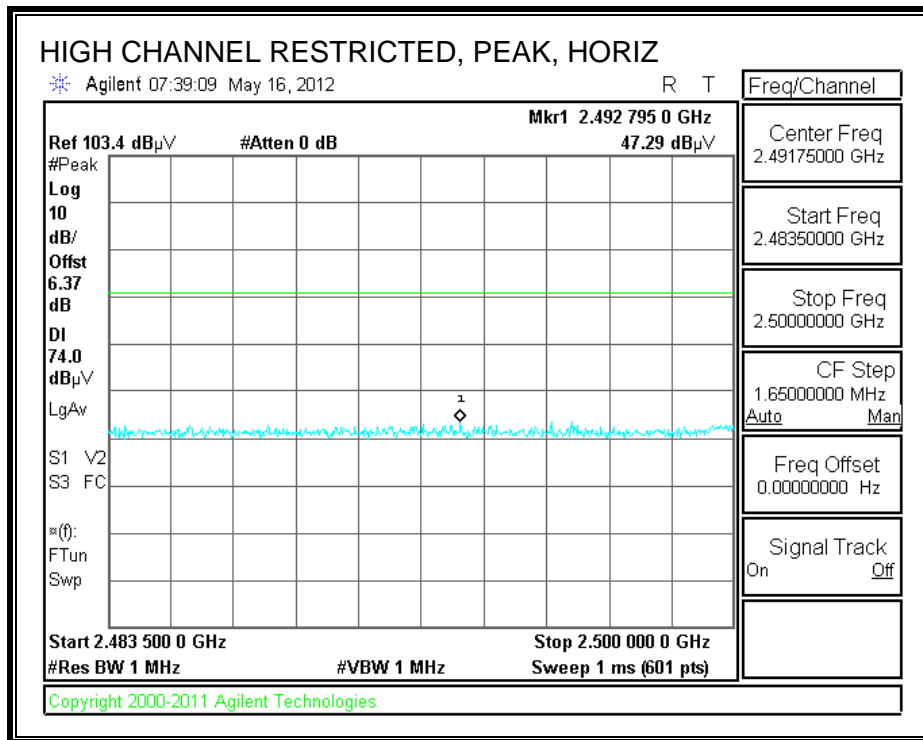

RESTRICTED BANDEDGE (HIGH CHANNEL, VERTICAL)

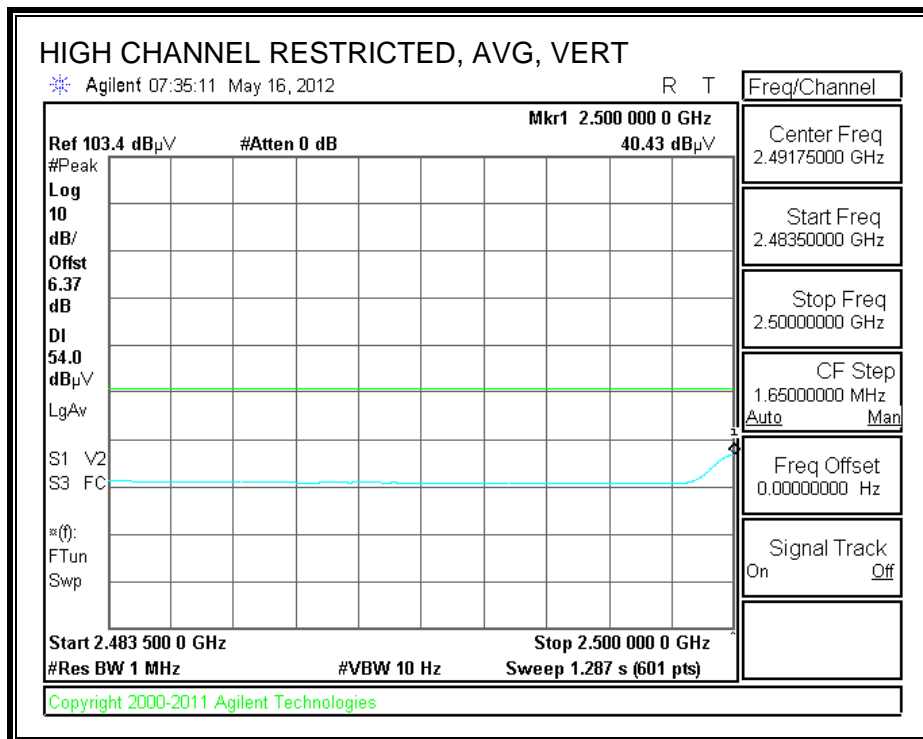
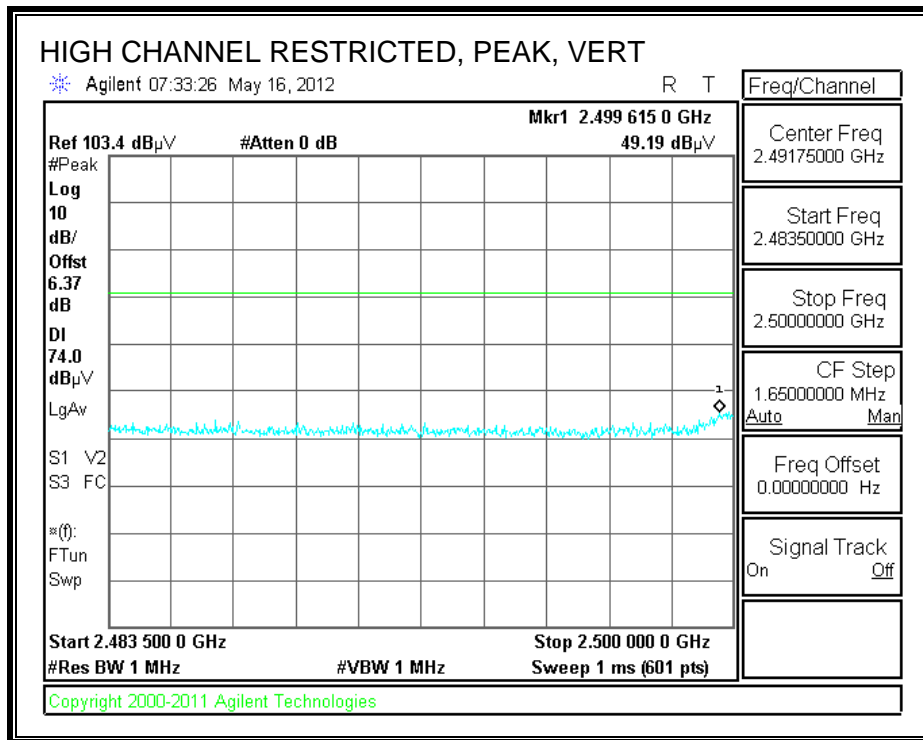

HARMONICS AND SPURIOUS EMISSIONS

High Frequency Measurement															
Compliance Certification Services, Fremont 5m Chamber															
Test Engr:	Vien Tran														
Date:	05/16/12														
Project #:	12U14373														
Company:	Broadcom														
Test Target:	FCC 15.247														
Mode Oper:	Tx GFSK														
f	Measurement Frequency	Amp	Preamp Gain	Average Field Strength Limit											
Dist	Distance to Antenna	D Corr	Distance Correct to 3 meters	Peak Field Strength Limit											
Read	Analyzer Reading	Avg	Average Field Strength @ 3 m	Margin vs. Average Limit											
AF	Antenna Factor	Peak	Calculated Peak Field Strength	Margin vs. Peak Limit											
CL	Cable Loss	HPF	High Pass Filter												
f GHz	Dist (m)	Read dBuV	AF dB/m	CL dB	Amp dB	D Corr dB	Filtr dB	Corr. dBuV/m	Limit dBuV/m	Margin dB	Ant. Pol. V/H	Det. P/A/QP	Ant.High cm	Table Angle Degree	Notes
LOW CHANNEL, 2402MHz															
4.804	3.0	41.0	33.4	6.2	-35.5	0.0	0.0	45.1	74.0	-28.9	V	P	100.7	97.2	
4.804	3.0	35.5	33.4	6.2	-35.5	0.0	0.0	39.6	54.0	-14.4	V	A	100.7	97.2	
4.804	3.0	39.0	33.4	6.2	-35.5	0.0	0.0	43.1	74.0	-30.9	H	P	100.3	185.9	
4.804	3.0	29.7	33.4	6.2	-35.5	0.0	0.0	33.8	54.0	-20.2	H	A	100.3	185.9	
MID CHANNEL, 2441MHz															
4.882	3.0	42.0	33.5	6.2	-35.5	0.0	0.0	46.2	74.0	-27.8	V	P	103.5	122.7	
4.882	3.0	37.5	33.5	6.2	-35.5	0.0	0.0	41.7	54.0	-12.3	V	A	103.5	122.7	
7.323	3.0	35.5	35.7	8.4	-35.4	0.0	0.0	44.2	74.0	-29.8	V	P	197.8	187.6	
7.323	3.0	23.4	35.7	8.4	-35.4	0.0	0.0	32.1	54.0	-21.9	V	A	197.8	187.6	
4.882	3.0	38.4	33.5	6.2	-35.5	0.0	0.0	42.7	74.0	-31.3	H	P	103.1	171.2	
4.882	3.0	28.7	33.5	6.2	-35.5	0.0	0.0	32.9	54.0	-21.1	H	A	103.1	171.2	
7.323	3.0	35.8	35.7	8.4	-35.4	0.0	0.0	44.5	74.0	-29.5	H	P	103.5	94.7	
7.323	3.0	23.6	35.7	8.4	-35.4	0.0	0.0	32.2	54.0	-21.8	H	A	103.5	94.7	
HIGH CHANNEL, 2480MHz															
4.960	3.0	41.6	33.6	6.3	-35.5	0.0	0.0	46.0	74.0	-28.0	V	P	102.9	122.3	
4.960	3.0	36.8	33.6	6.3	-35.5	0.0	0.0	41.1	54.0	-12.9	V	A	102.9	122.3	
7.440	3.0	36.4	35.9	8.4	-35.5	0.0	0.0	45.3	74.0	-28.7	V	P	102.9	122.3	
7.440	3.0	23.8	35.9	8.4	-35.5	0.0	0.0	32.6	54.0	-21.4	V	A	102.9	122.3	
4.960	3.0	36.9	33.6	6.3	-35.5	0.0	0.0	41.3	74.0	-32.7	H	P	100.0	261.3	
4.960	3.0	27.9	33.6	6.3	-35.5	0.0	0.0	32.3	54.0	-21.7	H	A	100.0	261.3	
7.440	3.0	36.0	35.9	8.4	-35.5	0.0	0.0	44.9	74.0	-29.1	H	P	100.1	114.1	
7.440	3.0	23.8	35.9	8.4	-35.5	0.0	0.0	32.7	54.0	-21.3	H	A	100.1	114.1	

Rev. 4.1.2.7

Note: No other emissions were detected above the system noise floor.

8.2.2. ENHANCED DATA RATE 8PSK MODULATION

RESTRICTED BANDEDGE (LOW CHANNEL, HORIZONTAL)

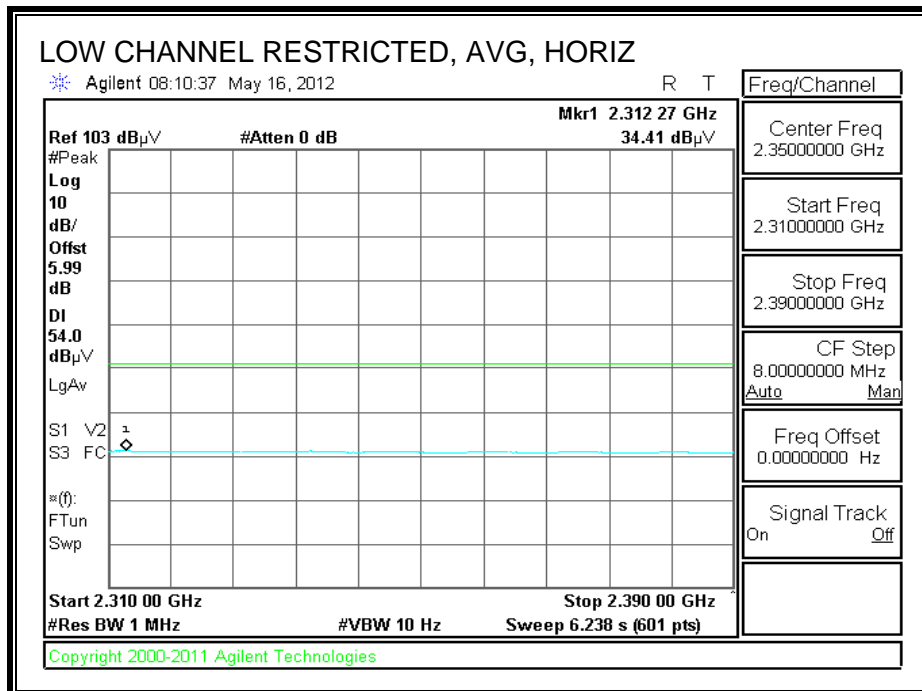
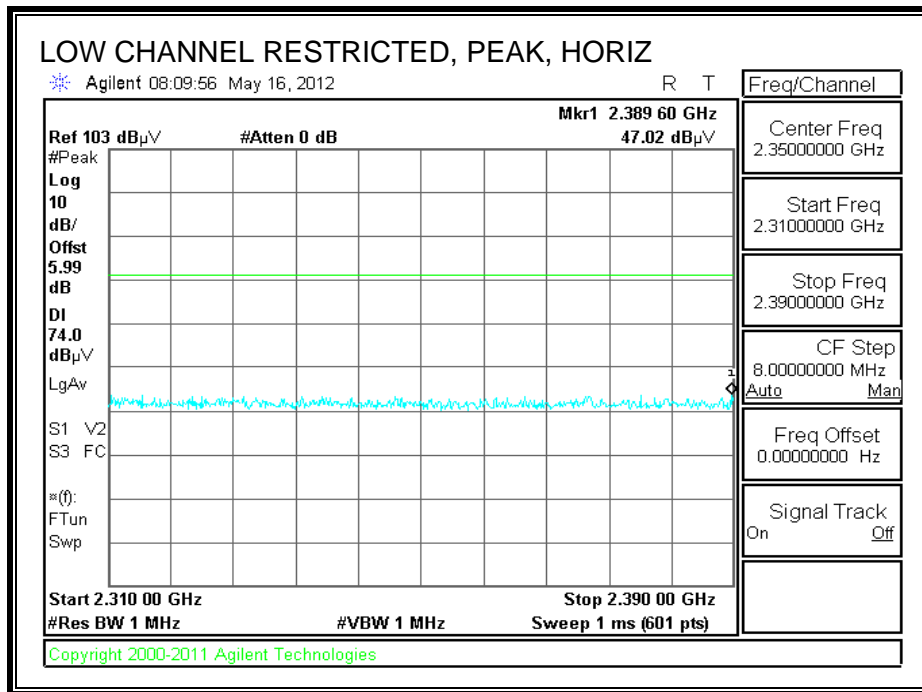

RESTRICTED BANDEDGE (LOW CHANNEL, VERTICAL)

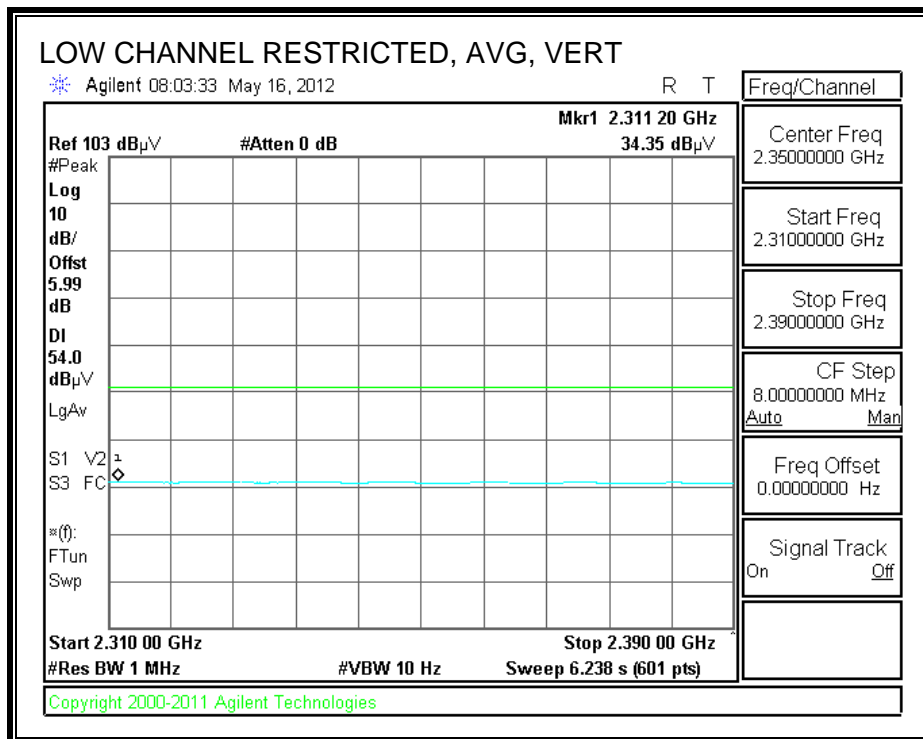
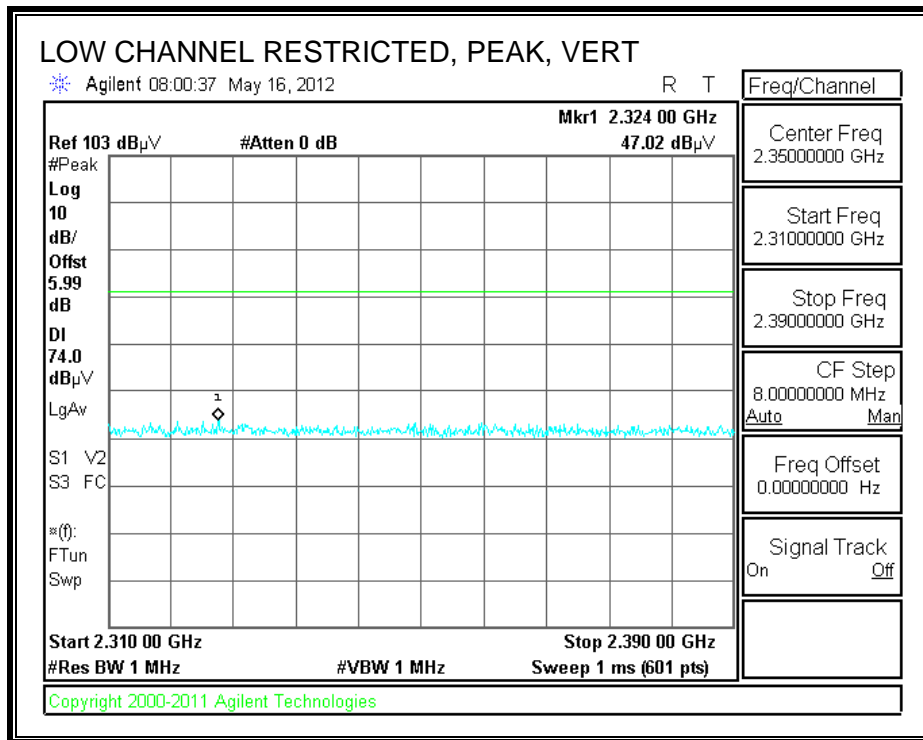

RESTRICTED BANDEDGE (HIGH CHANNEL, HORIZONTAL)

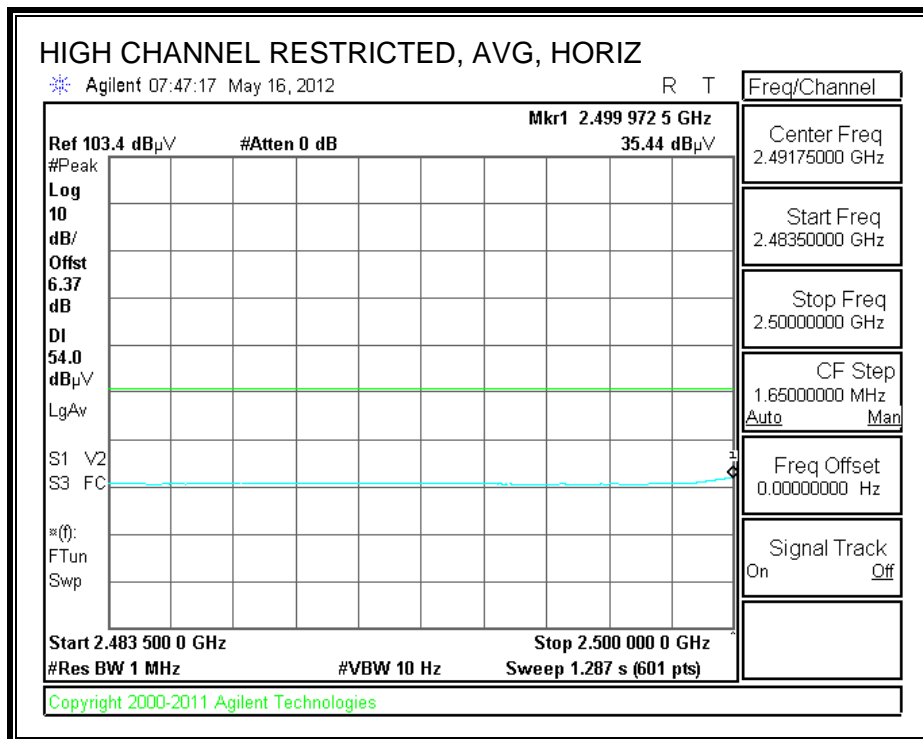
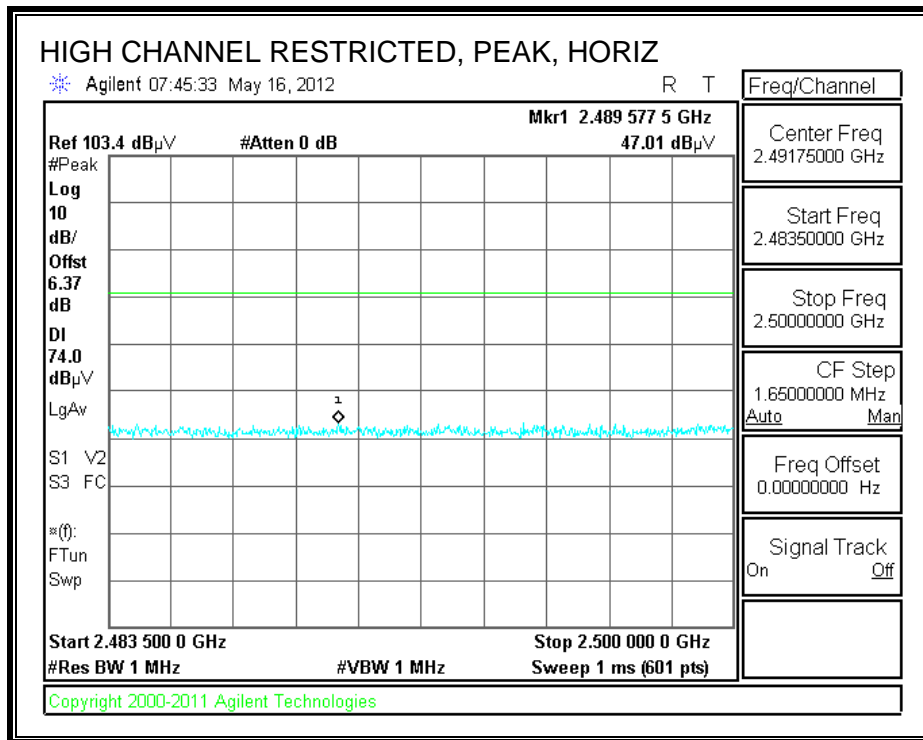

RESTRICTED BANDEDGE (HIGH CHANNEL, VERTICAL)

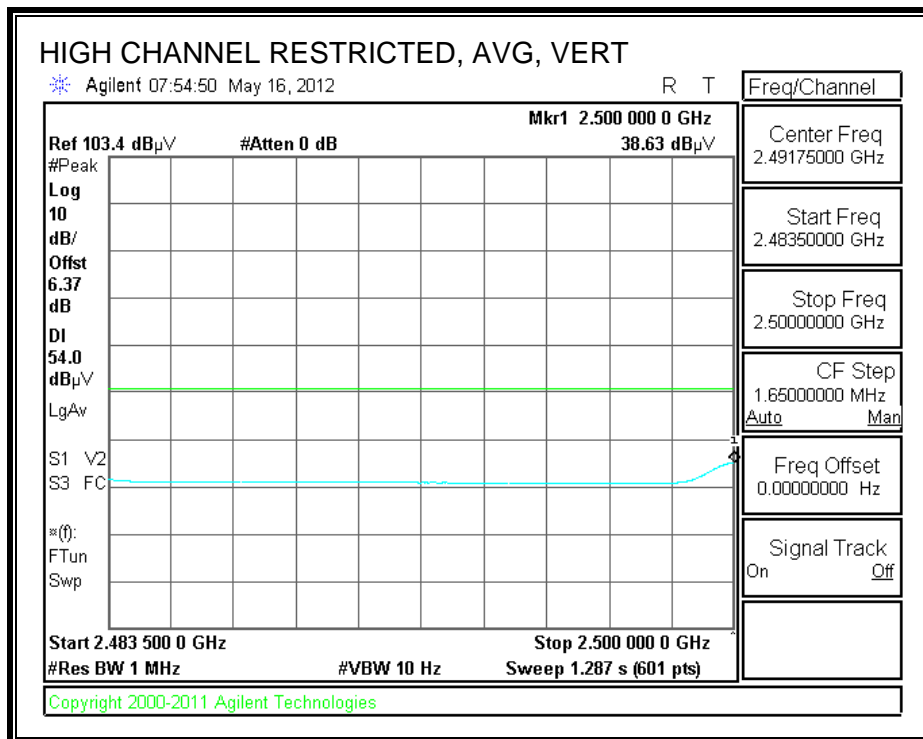
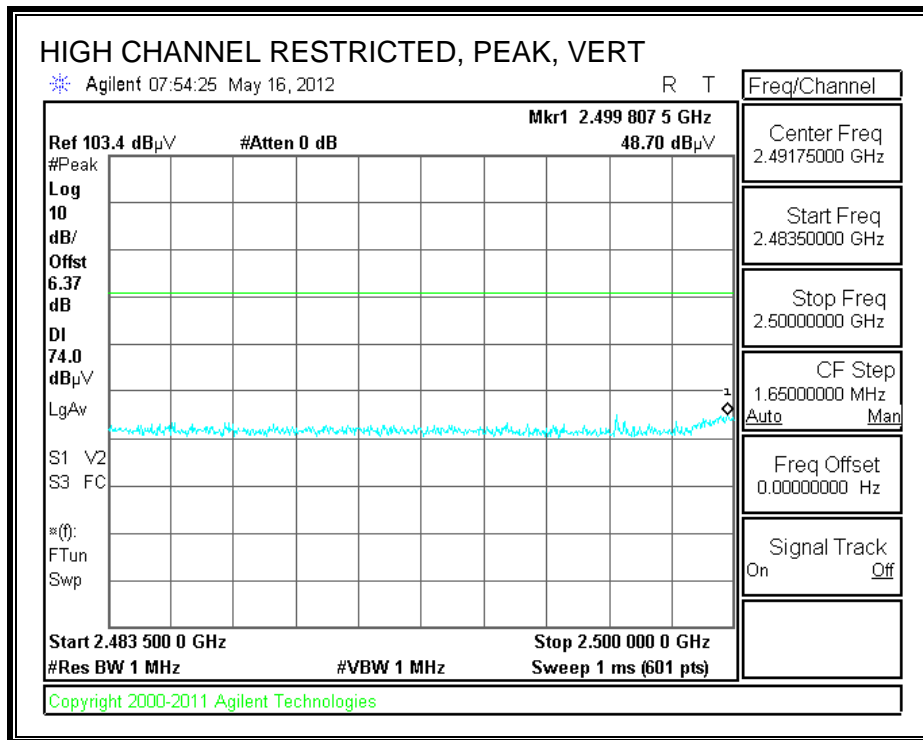

HARMONICS AND SPURIOUS EMISSIONS

High Frequency Measurement																
Compliance Certification Services, Fremont 5m Chamber																
Test Engr:		Vien Tran														
Date:		05/16/12														
Project #:		12U14373														
Company:		Broadcom														
Test Target:		FCC 15.247														
Mode Oper:		Tx 8PSK														
f	Measurement Frequency		Amp	Preamp Gain		Average Field Strength Limit										
Dist	Distance to Antenna		D Corr	Distance Correct to 3 meters		Peak Field Strength Limit										
Read	Analyzer Reading		Avg	Average Field Strength @ 3 m		Margin vs. Average Limit										
AF	Antenna Factor		Peak	Calculated Peak Field Strength		Margin vs. Peak Limit										
CL	Cable Loss		HPF	High Pass Filter												
f	Dist	Read	AF	CL	Amp	D Corr	Fltr	Corr.	Limit	Margin	Ant. Pol.	Det.	Ant.High	Table Angle	Notes	
GHz	(m)	dBuV	dB/m	dB	dB	dB	dB	dB	dBuV/m	dBuV/m	dB	V/H	P/A/QP	cm	Degree	
LOW CHANNEL, 2402MHz																
4.804	3.0	40.6	33.4	6.2	-35.5	0.0	0.0	44.7	74.0	-29.3	V	P	100.0	96.7		
4.804	3.0	32.1	33.4	6.2	-35.5	0.0	0.0	36.2	54.0	-17.8	V	A	100.0	96.7		
4.804	3.0	37.2	33.4	6.2	-35.5	0.0	0.0	41.3	74.0	-32.7	H	P	100.4	145.4		
4.804	3.0	26.9	33.4	6.2	-35.5	0.0	0.0	31.0	54.0	-23.0	H	A	100.4	145.4		
MID CHANNEL, 2441MHz																
4.882	3.0	41.5	33.5	6.2	-35.5	0.0	0.0	45.7	74.0	-28.3	V	P	103.4	121.8		
4.882	3.0	33.8	33.5	6.2	-35.5	0.0	0.0	38.1	54.0	-15.9	V	A	103.4	121.8		
7.323	3.0	35.6	35.7	8.4	-35.4	0.0	0.0	44.3	74.0	-29.7	V	P	138.5	355.9		
7.323	3.0	23.2	35.7	8.4	-35.4	0.0	0.0	31.9	54.0	-22.1	V	A	138.5	355.9		
4.882	3.0	36.0	33.5	6.2	-35.5	0.0	0.0	40.3	74.0	-33.7	H	P	100.7	77.4		
4.882	3.0	25.2	33.5	6.2	-35.5	0.0	0.0	29.4	54.0	-24.6	H	A	100.7	77.4		
7.323	3.0	36.6	35.7	8.4	-35.4	0.0	0.0	45.3	74.0	-28.7	H	P	199.1	70.1		
7.323	3.0	23.6	35.7	8.4	-35.4	0.0	0.0	32.3	54.0	-21.7	H	A	199.1	70.1		
HIGH CHANNEL, 2480MHz																
4.960	3.0	40.2	33.6	6.3	-35.5	0.0	0.0	44.6	74.0	-29.4	V	P	100.6	122.8		
4.960	3.0	32.2	33.6	6.3	-35.5	0.0	0.0	36.6	54.0	-17.4	V	A	100.6	122.8		
7.440	3.0	36.2	35.9	8.4	-35.5	0.0	0.0	45.1	74.0	-28.9	V	P	100.6	122.8		
7.440	3.0	23.6	35.9	8.4	-35.5	0.0	0.0	32.5	54.0	-21.5	V	A	100.6	122.8		
4.960	3.0	36.7	33.6	6.3	-35.5	0.0	0.0	41.0	74.0	-33.0	H	P	100.0	189.1		
4.960	3.0	25.5	33.6	6.3	-35.5	0.0	0.0	29.9	54.0	-24.1	H	A	100.0	189.1		
7.440	3.0	36.1	35.9	8.4	-35.5	0.0	0.0	45.0	74.0	-29.0	H	P	100.0	189.1		
7.440	3.0	23.6	35.9	8.4	-35.5	0.0	0.0	32.5	54.0	-21.5	H	A	100.0	189.1		

Rev. 4.1.2.7

Note: No other emissions were detected above the system noise floor.

8.3. WORST-CASE BELOW 1 GHz

SPURIOUS EMISSIONS 30 TO 1000 MHz (WORST-CASE CONFIGURATION, HORIZONTAL & VERTICAL)

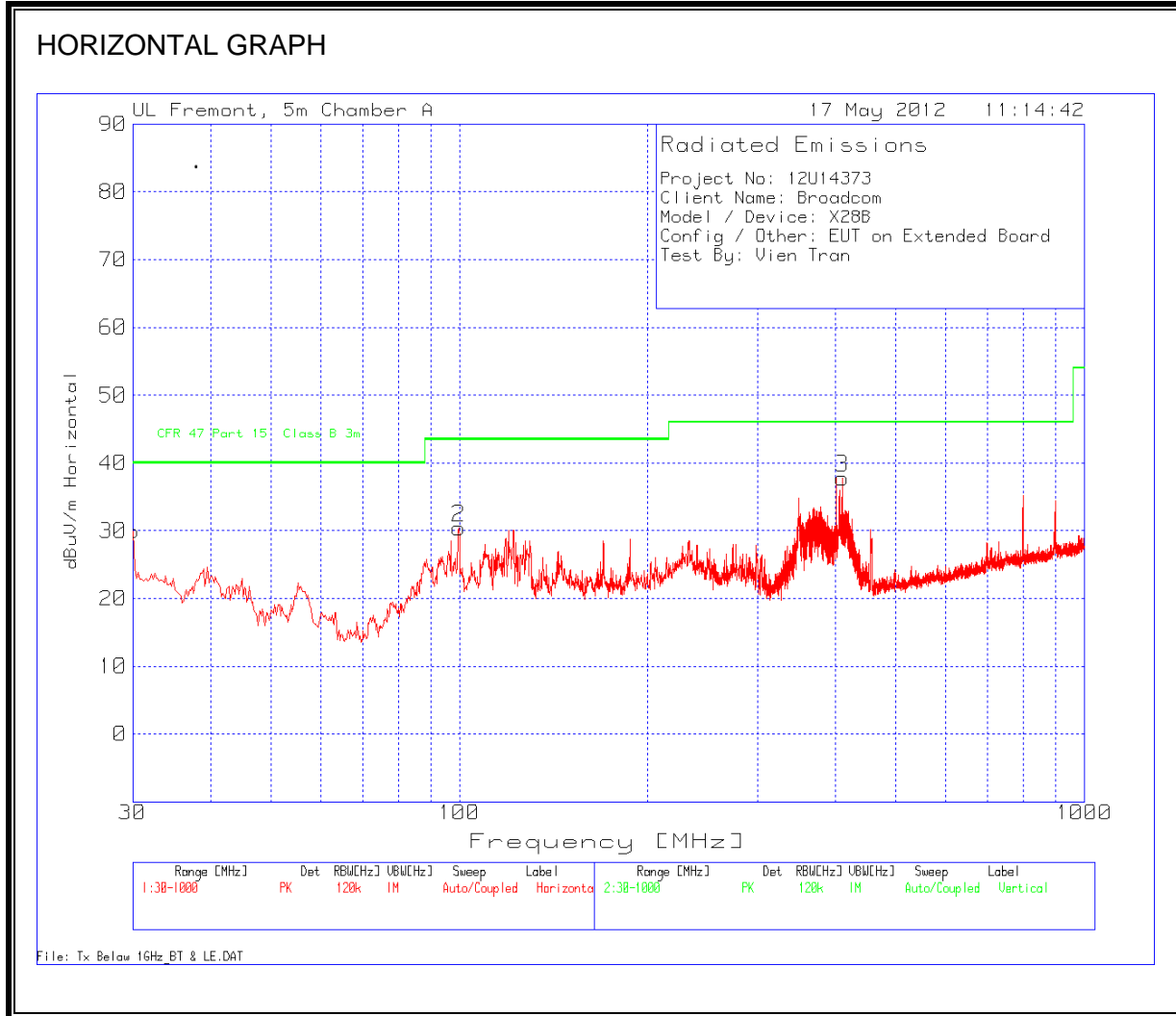

VERTICAL GRAPH

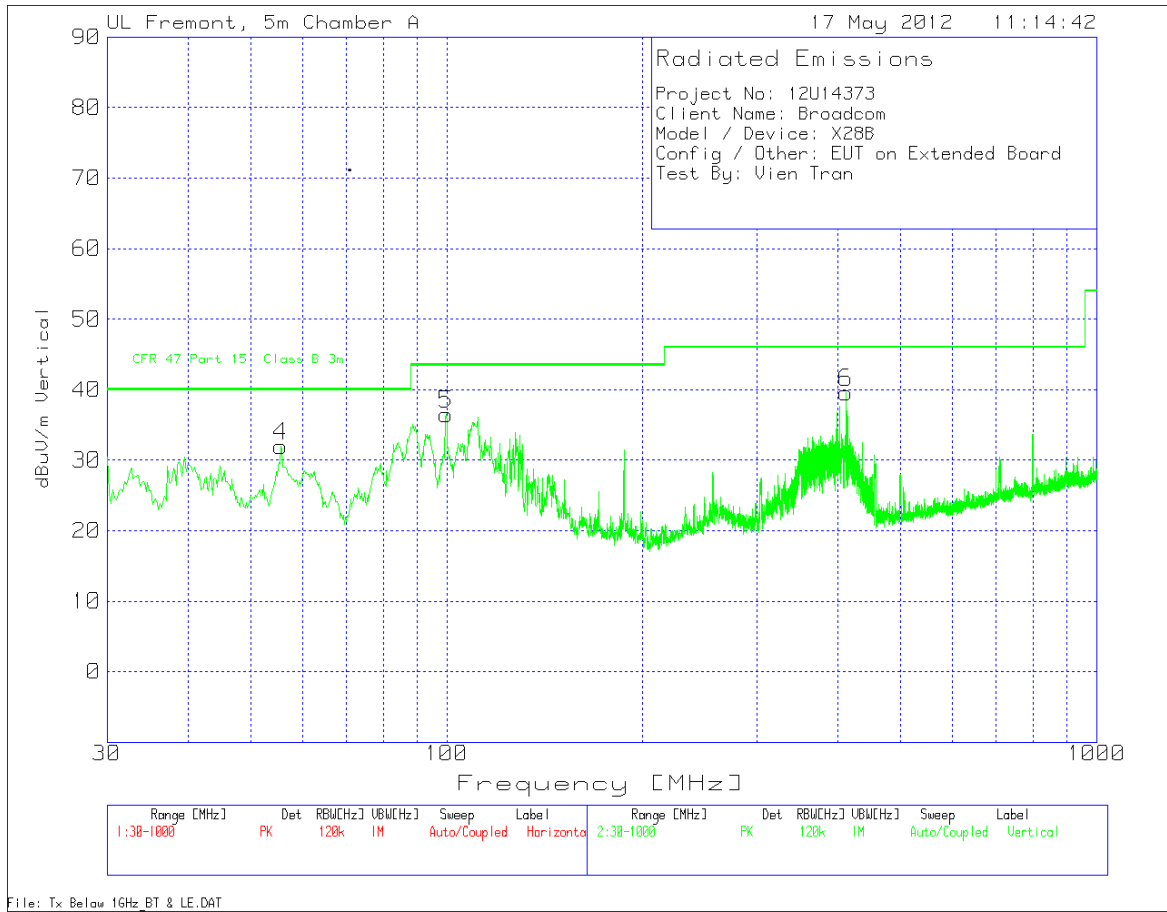

Project No: 12U14373									
Client Name: Broadcom									
Model / Device: X28B									
Config / Other: EUT on Extended Board									
Test By: Vien Tran									
Horizontal 30 - 1000MHz									
Test Frequency	Meter Reading	Detector	25MHz-1GHz ChmbrA Amplified.TX [dB]	T243 Sunol Bilog.TXT [dB]	dBuV/m	CFR 47 Part 15 Class B 3m	Margin	Height [cm]	Polarity
30	36.18	PK	-27.5	21.3	29.98	40	-10.02	100	Horz
99.7842	47.18	PK	-26.9	10.1	30.38	43.5	-13.12	200	Horz
410.7114	47.08	PK	-25.2	15.9	37.78	46	-8.22	100	Horz
Vertical 30 - 1000MHz									
Test Frequency	Meter Reading	Detector	25MHz-1GHz ChmbrA Amplified.TX [dB]	T243 Sunol Bilog.TXT [dB]	dBuV/m	CFR 47 Part 15 Class B 3m	Margin	Height [cm]	Polarity
55.5875	52.19	PK	-27.3	7.1	31.99	40	-8.01	200	Vert
99.7842	53.25	PK	-26.9	10.1	36.45	43.5	-7.05	100	Vert
411.6807	48.84	PK	-25.2	16	39.64	46	-6.36	100	Vert
PK - Peak detector									
QP - Quasi-Peak detector									
LnAv - Linear Average detector									
LgAv - Log Average detector									
Av - Average detector									
CAV - CISPR Average detector									
RMS - RMS detection									
CRMS - CISPR RMS detection									
Text File: Tx Below 1GHz_BT & LE.TXT									
File: Tx Below 1GHz_BT & LE.DAT									

9. AC POWER LINE CONDUCTED EMISSIONS

LIMITS

FCC §15.207 (a)

RSS-Gen 7.2.2

Frequency of Emission (MHz)	Conducted Limit (dBuV)	
	Quasi-peak	Average
0.15-0.5	66 to 56*	56 to 46*
0.5-5	56	46
5-30	60	50

*Decreases with the logarithm of the frequency.

TEST PROCEDURE

The EUT is placed on a non-conducting table 40 cm from the vertical ground plane and 80 cm above the horizontal ground plane. The EUT is configured in accordance with ANSI C63.4.

The receiver is set to a resolution bandwidth of 9 kHz. Peak detection is used unless otherwise noted as quasi-peak or average.

Line conducted data is recorded for both NEUTRAL and HOT lines.

RESULTS

Project No: 12U14373									
Client Name: Broadcom									
Model/Device: X28B									
Test Volt/Freq: 120VAC / 60Hz									
Test By: Vien Tran									
Line-L1 .15 - 30MHz									
Test Frequency	Meter Reading	Detector	T24 IL L1.TXT (dB)	LC Cables 1&3.TXT (dB)	dB(uVolts)	CFR 47 Part 15 Class B QP	Margin	CFR 47 Part 15 Class B Avg	Margin
0.1815	56.69	PK	0.1	0	56.79	64.4	-7.61	-	-
0.1815	34.74	Av	0.1	0	34.84	-	-	54.4	-19.56
0.537	48.75	PK	0.1	0	48.85	56	-7.15	-	-
0.537	31.25	Av	0.1	0	31.35	-	-	46	-14.65
20.8365	39.86	PK	0.3	0.2	40.36	60	-19.64	-	-
20.8365	25.29	Av	0.3	0.2	25.79	-	-	50	-24.21
Line-L2 .15 - 30MHz									
Test Frequency	Meter Reading	Detector	T24 IL L1.TXT (dB)	LC Cables 1&3.TXT (dB)	dB(uVolts)	CFR 47 Part 15 Class B QP	Margin	CFR 47 Part 15 Class B Avg	Margin
0.1815	56.12	PK	0.1	0	56.22	64.4	-8.18	-	-
0.1815	34.18	Av	0.1	0	34.28	-	-	54.4	-20.12
0.537	47.69	PK	0.1	0	47.79	56	-8.21	-	-
0.537	29.64	Av	0.1	0	29.74	-	-	46	-16.26
16.8315	41.15	PK	0.2	0.2	41.55	60	-18.45	-	-
16.8315	25.48	Av	0.2	0.2	25.88	-	-	50	-24.12
PK - Peak detector									
QP - Quasi-Peak detector									
LnAv - Linear Average detector									
LgAv - Log Average detector									
Av - Average detector									
CAV - CISPR Average detector									
RMS - RMS detection									
CRMS - CISPR RMS detection									
Text File: LC_BT & LE.TXT									
File: ESHS20-CE 150K-30MHz FCC Class B Step Rcvr.TST									

LINE 1 RESULTS

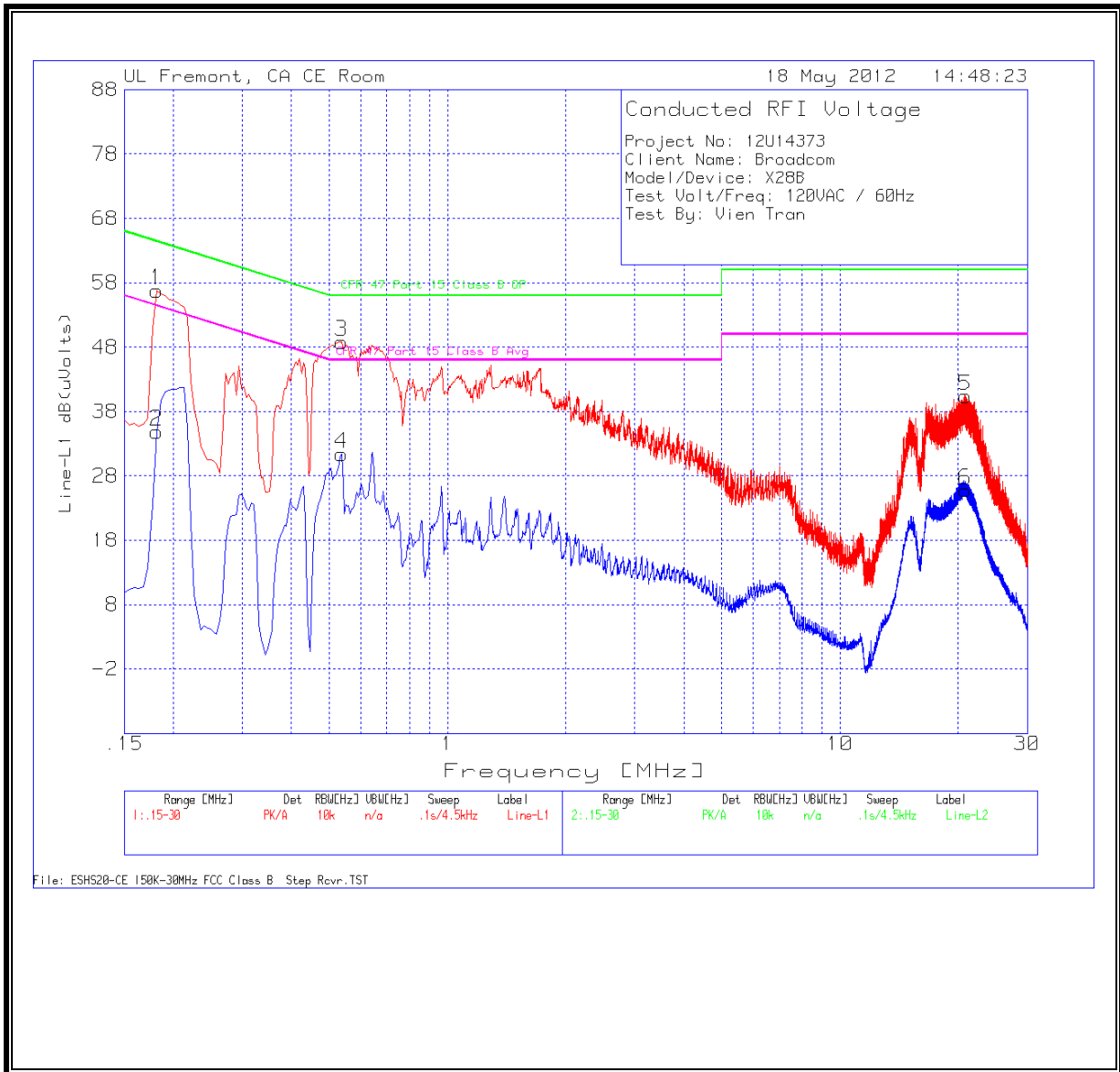

LINE 2 RESULTS

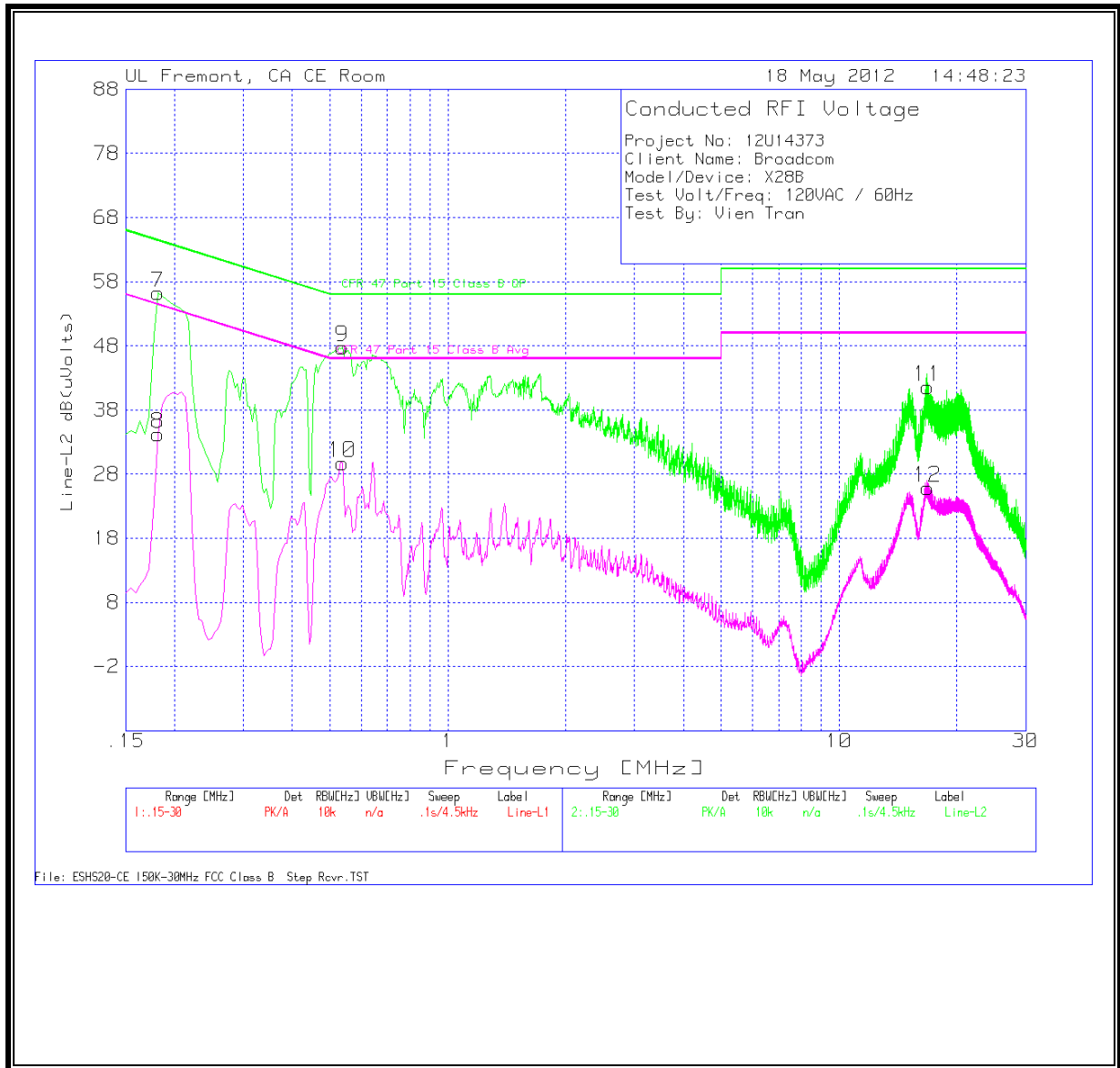

10. MAXIMUM PERMISSIBLE EXPOSURE

FCC RULES

§1.1310 The criteria listed in Table 1 shall be used to evaluate the environmental impact of human exposure to radio-frequency (RF) radiation as specified in §1.1307(b), except in the case of portable devices which shall be evaluated according to the provisions of §2.1093 of this chapter.

TABLE 1—LIMITS FOR MAXIMUM PERMISSIBLE EXPOSURE (MPE)

Frequency range (MHz)	Electric field strength (V/m)	Magnetic field strength (A/m)	Power density (mW/cm ²)	Averaging time (minutes)
(A) Limits for Occupational/Controlled Exposures				
0.3–3.0	614	1.63	*(100)	6
3.0–30	1842/f	4.89/f	*(900/f ²)	6
30–300	61.4	0.163	1.0	6
300–1500	f/300	6
1500–100,000	5	6
(B) Limits for General Population/Uncontrolled Exposure				
0.3–1.34	614	1.63	*(100)	30
1.34–30	824/f	2.19/f	*(180/f ²)	30

TABLE 1—LIMITS FOR MAXIMUM PERMISSIBLE EXPOSURE (MPE)—Continued

Frequency range (MHz)	Electric field strength (V/m)	Magnetic field strength (A/m)	Power density (mW/cm ²)	Averaging time (minutes)
30–300	27.5	0.073	0.2	30
300–1500	f/1500	30
1500–100,000	1.0	30

f = frequency in MHz

* = Plane-wave equivalent power density

NOTE 1 TO TABLE 1: Occupational/controlled limits apply in situations in which persons are exposed as a consequence of their employment provided those persons are fully aware of the potential for exposure and can exercise control over their exposure. Limits for occupational/controlled exposure also apply in situations when an individual is transient through a location where occupational/controlled limits apply provided he or she is made aware of the potential for exposure.

NOTE 2 TO TABLE 1: General population/uncontrolled exposures apply in situations in which the general public may be exposed, or in which persons that are exposed as a consequence of their employment may not be fully aware of the potential for exposure or can not exercise control over their exposure.

IC RULES

IC Safety Code 6, Section 2.2.1 (a) A person other than an RF and microwave exposed worker shall not be exposed to electromagnetic radiation in a frequency band listed in Column 1 of Table 5, if the field strength exceeds the value given in Column 2 or 3 of Table 5, when averaged spatially and over time, or if the power density exceeds the value given in Column 4 of Table 5, when averaged spatially and over time.

**Table 5
 Exposure Limits for Persons Not Classed As RF and Microwave Exposed Workers (Including the General Public)**

1 Frequency (MHz)	2 Electric Field Strength; rms (V/m)	3 Magnetic Field Strength; rms (A/m)	4 Power Density (W/m ²)	5 Averaging Time (min)
0.003–1	280	2.19		6
1–10	280/ <i>f</i>	2.19/ <i>f</i>		6
10–30	28	2.19/ <i>f</i>		6
30–300	28	0.073	2*	6
300–1 500	1.585 <i>f</i> ^{0.5}	0.0042 <i>f</i> ^{0.5}	<i>f</i> /150	6
1 500–15 000	61.4	0.163	10	6
15 000–150 000	61.4	0.163	10	616 000 / <i>f</i> ^{1.2}
150 000–300 000	0.158 <i>f</i> ^{0.5}	4.21 x 10 ⁻⁴ <i>f</i> ^{0.5}	6.67 x 10 ⁻⁵ <i>f</i>	616 000 / <i>f</i> ^{1.2}

* Power density limit is applicable at frequencies greater than 100 MHz.

- Notes:**
1. Frequency, *f*, is in MHz.
 2. A power density of 10 W/m² is equivalent to 1 mW/cm².
 3. A magnetic field strength of 1 A/m corresponds to 1.257 microtesla (μT) or 12.57 milligauss (mG).

EQUATIONS

Power density is given by:

$$S = \text{EIRP} / (4 * \text{Pi} * \text{D}^2)$$

where

- S = Power density in W/m²
- EIRP = Equivalent Isotropic Radiated Power in W
- D = Separation distance in m

Power density in units of W/m² is converted to units of mWc/m² by dividing by 10.

Distance is given by:

$$D = \text{SQRT} (\text{EIRP} / (4 * \text{Pi} * S))$$

where

- D = Separation distance in m
- EIRP = Equivalent Isotropic Radiated Power in W
- S = Power density in W/m²

For multiple colocated transmitters operating simultaneously in frequency bands where the limit is identical, the total power density is calculated using the total EIRP obtained by summing the Power * Gain product (in linear units) of each transmitter.

$$\text{Total EIRP} = (P1 * G1) + (P2 * G2) + \dots + (Pn * Gn)$$

where

- Px = Power of transmitter x
- Gx = Numeric gain of antenna x

In the table(s) below, Power and Gain are entered in units of dBm and dBi respectively and conversions to linear forms are used for the calculations.

LIMITS

From FCC §1.1310 Table 1 (B), the maximum value of S = 1.0 mW/cm²
 From IC Safety Code 6, Section 2.2 Table 5 Column 4, S = 10 W/m²

RESULTS

Band	Mode	Separation Distance (m)	Output Power (dBm)	Antenna Gain (dBi)	IC Power Density (W/m ²)	FCC Power Density (mW/cm ²)
2.4 GHz	Bluetooth	0.20	7.68	1.11	0.0151	0.0015