



**FCC 47 CFR PART 15 SUBPART E &  
INDUSTRY CANADA RSS-210  
(Class II Permissive Change)**

**TEST REPORT**

**For**

**802.11a/b/g/n WLAN + BLUETOOTH PCI-E MINI CARD**

**Model: BCM943228HMB**

**Trade Name: Broadcom**

*Issued to*

**Broadcom Corporation  
190 Mathilda Place Sunnyvale, CA 94086, USA**

*Issued by*

**Compliance Certification Services Inc.  
No.11, Wugong 6th Rd., Wugu Dist.,  
New Taipei City 24891, Taiwan. (R.O.C.)  
<http://www.ccsrf.com>  
[service@ccsrf.com](mailto:service@ccsrf.com)  
Issued Date: March 19, 2013**



Testing Laboratory  
1309

---

*Note: This report shall not be reproduced except in full, without the written approval of Compliance Certification Services Inc. This document may be altered or revised by Compliance Certification Services Inc. personnel only, and shall be noted in the revision section of the document.*



**Revision History**

Rev.	Issue Date	Revisions	Effect Page	Revised By
00	March 19, 2013	Initial Issue	ALL	Angel Cheng



## TABLE OF CONTENTS

<b>1. TEST RESULT CERTIFICATION.....</b>	<b>4</b>
<b>2. EUT DESCRIPTION .....</b>	<b>5</b>
<b>3. TEST METHODOLOGY .....</b>	<b>8</b>
3.1 EUT CONFIGURATION .....	8
3.2 EUT EXERCISE .....	8
3.3 GENERAL TEST PROCEDURES .....	8
3.4 FCC PART 15.205 RESTRICTED BANDS OF OPERATIONS .....	9
3.5 DESCRIPTION OF TEST MODES .....	10
<b>4. INSTRUMENT CALIBRATION.....</b>	<b>11</b>
4.1 MEASURING INSTRUMENT CALIBRATION .....	11
4.2 MEASUREMENT EQUIPMENT USED .....	11
4.3 MEASUREMENT UNCERTAINTY .....	12
<b>5. FACILITIES AND ACCREDITATIONS .....</b>	<b>13</b>
5.1 FACILITIES .....	13
5.2 EQUIPMENT .....	13
5.3 LABORATORY ACCREDITATIONS AND LISTING .....	13
5.4 TABLE OF ACCREDITATIONS AND LISTINGS .....	14
<b>6. SETUP OF EQUIPMENT UNDER TEST .....</b>	<b>15</b>
6.1 SETUP CONFIGURATION OF EUT .....	15
6.2 SUPPORT EQUIPMENT .....	15
<b>7. APPLICABLE RULES .....</b>	<b>16</b>
<b>8. FCC PART 15 REQUIREMENTS &amp; RSS 210 REQUIREMENTS .....</b>	<b>25</b>
8.1 AVERAGE POWER.....	25
8.2 BAND EDGES MEASUREMENT .....	29
8.3 RADIATED UNDESIRABLE EMISSION.....	42
<b>APPENDIX I PHOTOGRAPHS OF TEST SETUP .....</b>	<b>72</b>
<b>APPENDIX 1 - PHOTOGRAPHS OF EUT</b>	



# 1. TEST RESULT CERTIFICATION

**Applicant:** Broadcom Corporation  
190 Mathilda Place Sunnyvale, CA 94086, USA

**Manufacturer:** Broadcom Corporation  
190 Mathilda Place Sunnyvale, CA 94086, USA

**Equipment Under Test:** 802.11a/b/g/n WLAN + BLUETOOTH PCI-E MINI CARD

**Trade Name:** Broadcom

**Model:** BCM943228HMB

**Date of Test:** March 14 ~ 18, 2013

APPLICABLE STANDARDS	
STANDARD	TEST RESULT
FCC 47 CFR Part 15 Subpart E & Industry Canada RSS-210 Issue 8 <small>December, 2010</small>	No non-compliance noted

### We hereby certify that:

Compliance Certification Services Inc. tested the above equipment. The test data, data evaluation, test procedures, and equipment configurations shown in this report were made in accordance with the procedures given in ANSI C63.4: 2009 and the energy emitted by the sample EUT tested as described in this report is in compliance with conducted and radiated emission limits of FCC Rules Part 15.407 and Industry Canada RSS-210 Issue 8.

The test results of this report relate only to the tested sample identified in this report.

Approved by:

Reviewed by:

---

Miller Lee  
Section Manager  
Compliance Certification Services Inc.

---

Gina Lo  
Section Manager  
Compliance Certification Services Inc.



## 2. EUT DESCRIPTION

<b>Product</b>	802.11a/b/g/n WLAN + BLUETOOTH PCI-E MINI CARD			
<b>Trade Name</b>	Broadcom			
<b>Model Number</b>	BCM943228HMB			
<b>Model Discrepancy</b>	N/A			
<b>Received Date</b>	February 22, 2013			
<b>Power Supply</b>	Powered by host device.			
<b>Operating Frequency Range &amp; Number of Channels</b>	UNII Band I	Mode	Frequency Range (MHz)	Number of Channels
		IEEE 802.11a	5180 – 5240	4 Channels
		IEEE 802.11n HT 20 MHz	5180 – 5240	4 Channels
	UNII Band II	IEEE 802.11n HT 40 MHz	5190 ~ 5230	2 Channels
		IEEE 802.11a	5260 - 5320	4 Channels
		IEEE 802.11n HT 20 MHz	5260 - 5320	4 Channels
	UNII Band III	IEEE 802.11n HT 40 MHz	5270 - 5310	2 Channels
		IEEE 802.11a	5500 - 5700	8 Channels
		IEEE 802.11n HT 20 MHz	5500 – 5700	8 Channels
		IEEE 802.11n HT 40 MHz	5510 - 5670	5 Channels
<b>Original Transmit Power</b>	Frequency Range (MHz)	Output Power (mw)		
	5180 – 5240	0.025		
	5180 – 5240	0.017		
	5190 – 5230	0.019		
	5260 – 5320	0.055		
	5260 – 5320	0.087		
	5270 – 5310	0.101		
	5500 – 5700	0.055		
	5500 – 5700	0.094		
	5510 - 5670	0.116		
<b>Modulation Technique</b>	OFDM (QPSK, BPSK, 16-QAM, 64-QAM)			
<b>Transmit Data Rate</b>	IEEE 802.11a mode: 54, 48, 36, 24, 18, 12, 9, 6 Mbps IEEE 802.11n HT 20 MHz: OFDM (6.5, 7.2, 13, 14.4, 14.44, 19.5, 21.7, 26, 28.89, 28.9, 39, 43.3, 43.33 52, 57.78, 57.8, 58.5, 65.0, 72.2, 78, 86.67, 104, 115.56, 117, 130, 144.44 Mbps) IEEE 802.11n HT 40 MHz: OFDM (13.5, 15, 27, 30, 40.5, 45, 54, 60, 81, 90, 108, 120, 121.5, 135, 150, 162, 180, 216, 240, 243, 270, 300 Mbps)			



<b>Antenna Designation</b>	<b>HIGH-TEK ELECTRONICS CO., LTD / PIFA Antenna</b> <b>UNII Band I:</b> Main Antenna: DC33001AC00 / 1.48 dBi Aux. Antenna: DC33001AC00 / -0.13 dBi <b>UNII Band II:</b> Main Antenna: DC33001AC00 / 1.48 dBi Aux. Antenna: DC33001AC00 / -0.13 dBi <b>UNII Band III:</b> Main Antenna: DC33001AC00 / 0.03 dBi Aux. Antenna: DC33001AC00 / 0.96 dBi <b>JESS-LINK PRODUCTS CO., LTD / PIFA Antenna</b> <b>UNII Band I:</b> Main Antenna: DC33001AD00 / 1.52 dBi Aux. Antenna: DC33001AD00 / 0.42 dBi <b>UNII Band II:</b> Main Antenna: DC33001AD00 / 1.52 dBi Aux. Antenna: DC33001AD00 / 0.42 dBi <b>UNII Band III:</b> Main Antenna: DC33001AD00 / 0.53 dBi Aux. Antenna: DC33001AD00 / 0.91 dBi
<b>Class II Permissive Change</b>	The product will be installed in the following models of notebooks/laptops: Model: TP00056A



**Operation Frequency:**

UNLICENSED NATIONAL INFORMATION INFRASTRUCTURE (U-NII)	
CHANNEL	MHz
36	5180
38	5190
40	5200
44	5220
46	5230
48	5240
52	5260
54	5270
56	5280
60	5300
62	5310
64	5320
100	5500
102	5510
104	5520
108	5540
110	5550
112	5560
116	5580
118	5590
132	5660
134	5670
136	5680
140	5700

**Remark:** *The sample selected for test was engineering sample that approximated to production product and was provided by manufacturer.*



### **3. TEST METHODOLOGY**

Both conducted and radiated testing was performed according to the procedures in ANSI C63.4: 2009 Radiated testing was performed at an antenna to EUT distance 3 meters.

The tests documented in this report were performed in accordance with ANSI C63.4: 2009 and FCC CFR 47 Part 15.207, 15.209 and 15.247, RSS-GEN Issue 2, and RSS-210 Issue 8.

#### **3.1 EUT CONFIGURATION**

The EUT configuration for testing is installed for RF field strength measurement to meet the Commissions requirement, and is operated in a manner intended to generate the maximum emission in a continuous normal application.

#### **3.2 EUT EXERCISE**

The EUT is operated in the engineering mode to fix the Tx frequency for the purposes of measurement.

According to its specifications, the EUT must comply with the requirements of Section 15.407 under the FCC Rules Part 15 Subpart E.

#### **3.3 GENERAL TEST PROCEDURES**

##### **Conducted Emissions**

The EUT is placed on the turntable, which is positioned at 0.8 m above the ground plane. According to the requirements in Section 13.1.4.1 of ANSI C63.4, the conducted emission from the EUT is measured in the frequency range between 0.15 MHz and 30MHz, using the CISPR Quasi-Peak detector mode.

##### **Radiated Emissions**

The EUT is placed on the turntable, which is 0.8 m above the ground plane. The turntable is then rotated for 360 degrees to determine the proper orientation for the maximum emission level. The EUT is set 3m away from the receiving antenna, which is varied from 1m to 4m to find out the highest emission level. And, each emission is to be maximized by changing the horizontal and vertical polarization of the receiving antenna. In order to find out the maximum emissions, exploratory radiated emission measurements were made according to the requirements in Section 13.1.4.1 of ANSI C63.4: 2003.





### 3.4 FCC PART 15.205 RESTRICTED BANDS OF OPERATIONS

(a) Except as shown in paragraph (d) of this section, only spurious emissions are permitted in any of the frequency bands listed below:

MHz	MHz	MHz	GHz
0.090 - 0.110	16.42 - 16.423	399.9 - 410	4.5 - 5.15
<sup>1</sup> 0.495 - 0.505	16.69475 - 16.69525	608 - 614	5.35 - 5.46
2.1735 - 2.1905	16.80425 - 16.80475	960 - 1240	7.25 - 7.75
4.125 - 4.128	25.5 - 25.67	1300 - 1427	8.025 - 8.5
4.17725 - 4.17775	37.5 - 38.25	1435 - 1626.5	9.0 - 9.2
4.20725 - 4.20775	73 - 74.6	1645.5 - 1646.5	9.3 - 9.5
6.215 - 6.218	74.8 - 75.2	1660 - 1710	10.6 - 12.7
6.26775 - 6.26825	108 - 121.94	1718.8 - 1722.2	13.25 - 13.4
6.31175 - 6.31225	123 - 138	2200 - 2300	14.47 - 14.5
8.291 - 8.294	149.9 - 150.05	2310 - 2390	15.35 - 16.2
8.362 - 8.366	156.52475 -	2483.5 - 2500	17.7 - 21.4
8.37625 - 8.38675	156.52525	2655 - 2900	22.01 - 23.12
8.41425 - 8.41475	156.7 - 156.9	3260 - 3267	23.6 - 24.0
12.29 - 12.293	162.0125 - 167.17	3332 - 3339	31.2 - 31.8
12.51975 - 12.52025	167.72 - 173.2	3345.8 - 3358	36.43 - 36.5
12.57675 - 12.57725	240 - 285	3600 - 4400	( <sup>2</sup> )
13.36 - 13.41	322 - 335.4		

<sup>1</sup> Until February 1, 1999, this restricted band shall be 0.490-0.510 MHz.

<sup>2</sup> Above 38.6

(b) Except as provided in paragraphs (d) and (e), the field strength of emissions appearing within these frequency bands shall not exceed the limits shown in Section 15.209. At frequencies equal to or less than 1000 MHz, compliance with the limits in Section 15.209 shall be demonstrated using measurement instrumentation employing a CISPR quasi-peak detector. Above 1000 MHz, compliance with the emission limits in Section 15.209 shall be demonstrated based on the average value of the measured emissions. The provisions in Section 15.35 apply to these measurements.



### 3.5 DESCRIPTION OF TEST MODES

The EUT (model: BCM943228HMB) had been tested under operating condition.

Software used to control the EUT for staying in continuous transmitting mode was programmed.

After verification, all tests were carried out with the worst case test modes as shown below except radiated spurious emission below 1GHz, which worst case was in normal link mode only.

#### UNII Band I:

##### **IEEE 802.11a for 5180 ~ 5240MHz:**

Channel Low (5180MHz), Channel Mid (5220MHz) and Channel High (5240MHz) with 6Mbps data rate were chosen for full testing.

##### **IEEE 802.11n HT 20 MHz for 5180 ~ 5240MHz:**

Channel Low (5180MHz), Channel Mid (5220MHz) and Channel High (5240MHz) with 6.5Mbps data rate were chosen for full testing.

##### **IEEE 802.11n HT 40 MHz Channel for 5190 ~ 5230MHz:**

Channel Low (5190MHz) and Channel High (5230MHz) with 13.5Mbps data rate were chosen for full testing.

#### UNII Band II:

##### **IEEE 802.11a for 5260 ~ 5320MHz:**

Channel Low (5260MHz), Channel Mid (5280MHz) and Channel High (5320MHz) with 6Mbps data rate were chosen for full testing.

##### **IEEE 802.11n HT 20 MHz for 5260 ~ 5320MHz:**

Channel Low (5260MHz), Channel Mid (5280MHz) and Channel High (5320MHz) with 6.5Mbps data rate were chosen for full testing.

##### **IEEE 802.11n HT 40 MHz for 5270 ~ 5310MHz:**

Channel Low (5270MHz) and Channel High (5310MHz) with 13.5Mbps data rate were chosen for full testing.

#### UNII Band III:

##### **IEEE 802.11a for 5500 ~ 5700MHz:**

Channel Low (5500MHz), Channel Mid (5580MHz) and Channel High (5700MHz) with 6Mbps data rate were chosen for full testing.

##### **IEEE 802.11n HT 20 MHz for 5500 ~ 5700MHz:**

Channel Low (5500MHz), Channel Mid (5580MHz) and Channel High (5700MHz) with 6.5Mbps data rate were chosen for full testing.

##### **IEEE 802.11n HT 40 MHz for 5510 ~ 5670MHz:**

Channel Low (5510MHz), Channel Mid (5550MHz) and Channel High (5670MHz) with 13.5Mbps data rate were chosen for full testing.



## 4. INSTRUMENT CALIBRATION

### 4.1 MEASURING INSTRUMENT CALIBRATION

The measuring equipment, which was utilized in performing the tests documented herein, has been calibrated in accordance with the manufacturer's recommendations for utilizing calibration equipment, which is traceable to recognized national standards.

### 4.2 MEASUREMENT EQUIPMENT USED

#### Equipment Used for Emissions Measurement

*Remark: Each piece of equipment is scheduled for calibration once a year and Loop Antenna is scheduled for calibration once three years.*

Conducted Emissions Test Site				
Name of Equipment	Manufacturer	Model	Serial Number	Calibration Due
Spectrum Analyzer	Agilent	E4446A	MY43360131	03/21/2013
Power Meter	Anritsu	ML2495A	1012009	06/05/2013
Power Sensor	Anritsu	MA2411A	0917072	06/05/2013

3M Chamber Test Site				
Name of Equipment	Manufacturer	Model	Serial Number	Calibration Due
Spectrum Analyzer	Agilent	E4446A	US42510268	11/06/2013
EMI Test Receiver	R&S	ESCI	100064	02/28/2014
Pre-Amplifier	Mini-Circuits	ZFL-1000LN	SF350700823	01/12/2014
Pre-Amplifier	MITEQ	AFS44-00102650-42-10P-44	1415367	11/19/2013
Bilog Antenna	Sunol Sciences	JB3	A030105	10/02/2013
Horn Antenna	EMCO	3117	00055165	02/13/2014
Horn Antenna	EMCO	3116	2487	10/10/2013
Loop Antenna	EMCO	6502	8905/2356	06/10/2013
Turn Table	CCS	CC-T-1F	N/A	N.C.R
Antenna Tower	CCS	CC-A-1F	N/A	N.C.R
Controller	CCS	CC-C-1F	N/A	N.C.R
Site NSA	CCS	N/A	N/A	12/22/2013
Test S/W	EZ-EMC (CCS-3A1RE)			



### 4.3 MEASUREMENT UNCERTAINTY

PARAMETER	UNCERTAINTY
3M Semi Anechoic Chamber / 30M~200M	+/- 4.0138
3M Semi Anechoic Chamber / 200M~1000M	+/- 3.9483
3M Semi Anechoic Chamber / 1G~8G	+/- 2.5975
3M Semi Anechoic Chamber / 8G~18G	+/- 2.6112
3M Semi Anechoic Chamber / 18G~26G	+/- 2.7389
3M Semi Anechoic Chamber / 26G~40G	+/- 2.9683

**Remark:** This uncertainty represents an expanded uncertainty expressed at approximately the 95% confidence level using a coverage factor of  $k=2$ .



## **5. FACILITIES AND ACCREDITATIONS**

### **5.1 FACILITIES**

All measurement facilities used to collect the measurement data are located at

No.199, Chunghsen Road, Hsintien City, Taipei Hsien, Taiwan, R.O.C.  
Tel: 886-2-2217-0894 / Fax: 886-2-2217-1029

No.11, Wugong 6th Rd., Wugu Dist., New Taipei City 24891, Taiwan. (R.O.C.)  
Tel: 886-2-2299-9720 / Fax: 886-2-2298-4045

No.81-1, Lane 210, Bade 2nd Rd., Luchu Hsiang, Taoyuan Hsien 338, Taiwan  
Tel: 886-3-324-0332 / Fax: 886-3-324-5235

The sites are constructed in conformance with the requirements of ANSI C63.7, ANSI C63.4 and CISPR Publication 22.

### **5.2 EQUIPMENT**

Radiated emissions are measured with one or more of the following types of linearly polarized antennas: tuned dipole, biconical, log periodic, bi-log, and/or ridged waveguide, horn. Spectrum analyzers with pre-selectors and quasi-peak detectors are used to perform radiated measurements.

Conducted emissions are measured with Line Impedance Stabilization Networks and EMI Test Receivers.

Calibrated wideband preamplifiers, coaxial cables, and coaxial attenuators are also used for making measurements.



All receiving equipment conforms to CISPR Publication 16-1, "Radio Interference Measuring Apparatus and Measurement Methods."

### **5.3 LABORATORY ACCREDITATIONS AND LISTING**

The test facilities used to perform radiated and conducted emissions tests are accredited by American Association for Laboratory Accreditation Program for the specific scope accreditation under Lab Code: 0824-01 to perform Electromagnetic Interference tests according to FCC Part 15 and CISPR 22 requirements. In addition, the test facilities are listed with Industry Canada, Certification and Engineering Bureau, IC 2324G-1 for 3M Semi Anechoic Chamber A, 2324G-2 for 3M Semi Anechoic Chamber B.



### 5.4 TABLE OF ACCREDITATIONS AND LISTINGS

Country	Agency	Scope of Accreditation	Logo
USA	FCC	3M Semi Anechoic Chamber (FCC MRA: TW1039) to perform FCC Part 15 measurements	 FCC MRA: TW1039
Taiwan	TAF	LP0002, RTTE01, FCC Method-47 CFR Part 15 Subpart C, D, E, RSS-210, RSS-310 IDA TS SRD, AS/NZS 4268, AS/NZS 4771, TS 12.1 & 12.2, ETSI EN 300 440-1, ETSI EN 300 440-2, ETSI EN 300 328, ETSI EN 300 220-1, ETSI EN 300 220-2, ETSI EN 301 893, ETSI EN 301 489-1/3/7/17 FCC OET Bulletin 65 + Supplement C, EN 50360, EN 50361, EN 50371, RSS 102, EN 50383, EN 50385, EN 50392, IEC 62209, CNS 14958-1, CNS 14959 FCC Method -47 CFR Part 15 Subpart B IEC / EN 61000-3-2, IEC / EN 61000-3-3, IEC / EN 61000-4-2/3/4/5/6/8/11	
Canada	Industry Canada	3M Semi Anechoic Chamber (IC 2324G-1 / IC 2324G-2) to perform	 IC 2324G-1 IC 2324G-2

*\* No part of this report may be used to claim or imply product endorsement by A2LA or any agency of the US Government.*



## 6. SETUP OF EQUIPMENT UNDER TEST

### 6.1 SETUP CONFIGURATION OF EUT

See test photographs attached in Appendix I for the actual connections between EUT and support equipment.

### 6.2 SUPPORT EQUIPMENT

No.	Device Type	Brand	Model	Series No.	FCC ID	Data Cable	Power Cord
	N/A						

**Remark:**

1. *All the equipment/cables were placed in the worst-case configuration to maximize the emission during the test.*
2. *Grounding was established in accordance with the manufacturer's requirements and conditions for the intended use.*



## 7. APPLICABLE RULES

### **RSS-210 §2 General Certification Requirements and Specifications**

#### **RSS-210 §2.1 RSS-Gen Compliance**

In addition to RSS-210, the requirements in RSS-Gen, *General Requirements and Information for the Certification of Radio Apparatus*, must be met.

#### **RSS-210 §2.2 Emissions Falling Within Restricted Frequency Bands**

Category I licence-exempt equipment is required to comply with the provisions in RSS-Gen with respect to emissions falling within restricted frequency bands. These restricted frequency bands are listed in RSS-Gen.

#### **RSS-210 §2.3 Receivers**

Category I equipment receivers for use with transmitters subject to RSS-210 must comply with the applicable requirements set out in RSS-Gen and be certified under RSS-210. Category II equipment receivers for use with transmitters subject to RSS-210 are exempt from certification, but are subject to compliance with RSS-Gen and RSS-310.

#### **RSS-210 §2.5 General Field Strength Limits**

RSS-Gen includes the general field strength limits of unwanted emissions, where applicable, for transmitters and receivers operating in accordance with the provisions specified in this standard. Unwanted emissions of transmitters and receivers are permitted to fall within the restricted bands listed in RSS-Gen, and including the TV bands, but fundamental emissions are prohibited in the restricted bands.

##### **RSS-210 §2.5.1 Transmitters with Wanted Emissions that are Within the General Field Strength Limits**

Whether or not their operation is addressed by published RSS standards, transmitters whose wanted and unwanted emissions are within the general field strength limits shown in RSS-Gen, they may operate in any of the frequency bands, other than the restricted bands listed in RSS-Gen and including the TV bands, and shall be certified under RSS-210. Under no conditions may the level of any unwanted emissions exceed the level of the fundamental emission.

**Note:** Devices operating below 490 kHz in which all emissions are at least 40 dB below the limit listed in RSS-Gen (*General Field Strength Limits for Transmitters at Frequencies below 30 MHz*) are Category II devices and are subject to RSS-310.





## **RSS-210 §2.7 Tables**

### **RSS-210 §Annex 8: Frequency Hopping and Digital Modulation Systems Operating in the 902-928 MHz, 2400-2483.5 MHz, and 5725-5850 MHz Bands**

This section applies to systems that employ frequency hopping (FH) and digital modulation technology in the 902-928 MHz, 2400-2483.5 MHz and 5725-5850 MHz bands. Systems in these bands may employ frequency hopping, digital modulation and or a combination (hybrid) of both techniques.

A frequency hopping system that synchronizes with another or several other systems (to avoid frequency collision among them) via off-air sensing or via connecting cables is not hopping randomly and therefore is not in compliance with RSS-210.

### **RSS-210 §A8.1 Frequency Hopping Systems**

Frequency hopping systems are spread spectrum systems in which the carrier is modulated with coded information in a conventional manner causing a conventional spreading of the RF energy about the carrier frequency. The frequency of the carrier is not fixed but changes at fixed intervals under the direction of a coded sequence.

Frequency hopping systems are not required to employ all available hopping frequencies during each transmission. However, the system, consisting of both the transmitter and the receiver, must be designed to comply with all of the regulations in this section should the transmitter be presented with a continuous data (or information) stream.

Incorporation of intelligence into a frequency hopping system that enables it to recognize other users of the band and to avoid occupied frequencies is permitted, provided that the frequency hopping system does it individually, and independently chooses or adapts its hopset. The coordination of frequency hopping systems in any other manner for the express purpose of avoiding the simultaneous occupancy of individual hopping frequencies by multiple transmitters is not permitted.

The following applies to frequency hopping systems in each of the three bands.

(a) The bandwidth of a frequency hopping channel is the 20 dB emission bandwidth, measured with the hopping stopped. The system RF bandwidth is equal to the channel bandwidth multiplied by the number of channels in the hopset. The hopset shall be such that the near term distribution of frequencies appears random, with sequential hops randomly distributed in both direction and magnitude of change in the hopset while the long term distribution appears evenly distributed.



(b) Frequency hopping systems shall have hopping channel carrier frequencies separated by a minimum of 25 kHz or the 20 dB bandwidth of the hopping channel, whichever is greater. Alternatively, frequency hopping systems operating in the 2400-2483.5 MHz band may have hopping channel carrier frequencies that are separated by 25 kHz or two-thirds of the 20 dB bandwidth of the hopping channel, whichever is greater, provided the systems operate with an output power no greater than 0.125 W. The system receivers shall have input bandwidths that match the hopping channel bandwidths of their corresponding transmitters and shall shift frequencies in synchronization with the transmitted signals.

(d) Frequency hopping systems operating in the 2400-2483.5 MHz band shall use at least 15 hopping channels. The average time of occupancy on any channel shall not be greater than 0.4 seconds within a period of 0.4 seconds multiplied by the number of hopping channels employed. Transmissions on particular hopping frequencies may be avoided or suppressed provided that a minimum of 15 hopping channels are used.

### **RSS-210 §A8.2 Digital Modulation Systems**

These include systems employing digital modulation techniques resulting in spectral characteristics similar to direct sequence systems. The following applies to all three bands.

### **RSS-210 §A8.4 Transmitter Output Power and e.i.r.p. Requirements**

(4) For systems employing digital modulation techniques operating in the 902-928 MHz, 2400-2483.5 MHz and 5725-5850 MHz bands, the maximum peak conducted power shall not exceed 1 W. Except as provided in Section A8.4(5), the e.i.r.p. shall not exceed 4 W.

As an alternative to a peak power measurement, compliance can be based on a measurement of the maximum conducted output power (see RSS-Gen)

(5) Point-to-point systems in the bands 2400-2483.5 MHz and 5725-5850 MHz are permitted to have an e.i.r.p. higher than 4 W, provided that the higher e.i.r.p. is achieved by employing higher gain directional antennas and not higher transmitter output powers. Point-to-multipoint systems, omni-directional applications and multiple co-located transmitters transmitting the same information are prohibited from exceeding 4 W e.i.r.p. However, remote stations of point-to-multipoint systems shall be allowed to operate at greater than 4 W e.i.r.p. under the same conditions as for point-to-point systems.

**Note:** "Fixed, point-to-point operation", excludes point-to-multipoint systems, omnidirectional applications and multiple co-located transmitters transmitting the same information.



### **RSS-210 §A8.5 Out-of-band Emissions**

In any 100 kHz bandwidth outside the frequency band in which the spread spectrum or digitally modulated device is operating, the radio frequency power that is produced shall be at least 20 dB below that in the 100 kHz bandwidth within the band that contains the highest level of the desired power, based on either an RF conducted or a radiated measurement, provided the transmitter demonstrates compliance with the peak conducted power limits. If the transmitter complies with the conducted power limits based on the use of RMS averaging over a time interval, as permitted under section A8.4(4), the attenuation required shall be 30 dB instead of 20 dB. Attenuation below the general limits specified in Tables 2 and 3 is not required.

### **RSS-Gen §2 General Information**

#### **RSS-Gen §2.1.2 Category II Equipment**

Category II equipment comprises radio devices where a standard has been prescribed but for which a TAC is not required, that is, equipment certification by Industry Canada or a Certification Body (CB) is not required (certification exempt), pursuant to subsection 4(3) of the Radiocommunication Act. The manufacturer or importer shall nevertheless ensure that the standards are complied with. A test report shall be available on request and the device shall be properly labelled.

#### **RSS-Gen §2.2 Receivers**

Receivers that are used for radiocommunication other than broadcasting are defined as Category I equipment or Category II equipment, subject to compliance with applicable Industry Canada standards.

Receivers shall be capable of operation only with transmitters for which RSSs are published. Receivers are classified as described in sections 2.2.1 and 2.2.2.

#### **RSS-Gen §2.2.1 Category I Equipment Receivers**

A receiver is classified as Category I equipment if it meets one of the following conditions:

- (a) a stand-alone receiver (see Note 1, below), which operates on any frequency in the band 30-960 MHz, and is used for the reception of signals in that frequency band from a transmitter classified as Category I equipment;
- (b) a Citizen's Band (CB) receiver (26.96-27.410 MHz);
- (c) a scanner receiver.

**Note 1:** A *stand-alone receiver* is defined as any receiver that is not permanently combined together with a transmitter in a single case (transceiver), in which it functions as the receiver component of the transceiver.

Receivers classified as Category I equipment shall comply with the limits for receiver spurious emissions set out in RSS-Gen; however, equipment certification is granted under the applicable RSS standard along with the associated transmitter classified as Category I equipment. Scanner receivers are covered under their own specific RSS.

#### **RSS-Gen §2.2.2 Category II Equipment Receivers**

A receiver is classified as Category II equipment if it does not meet any of the conditions of Section 2.2.1.

Category II receivers shall comply with the applicable testing, labelling and user manual requirements in RSS-310.



**RSS-Gen §5.6 Exposure of Humans to RF Fields**

Category I and Category II equipment shall comply with the applicable requirements of RSS-102.

**RSS-Gen §6 Receiver Spurious Emission Standard**

Receivers shall comply with the limits of spurious emissions set out in this section, measured over the frequency range determined in accordance with Section 4.10.

**RSS-Gen §6.1 Radiated Limits**

Radiated spurious emission measurements shall be performed with the receiver antenna connected to the receiver antenna terminals.

Spurious emissions from receivers shall not exceed the radiated limits shown in the table below:

**RSS-Gen Table 2 - Spurious Emission Limits for Receivers**

Frequency (MHz)	Field Strength microvolts/m at 3 metres
30-88	100
88-216	150
216-960	200
Above 960	500

\*Measurements for compliance with limits in the above table may be performed at distances other than 3 metres, in accordance with Section 7.2.7.



**RSS- Gen Table 3: Restricted Frequency Bands** <sup>(Note)</sup>

MHz	MHz	MHz	MHz	GHz
0.090-0.110	8.37625-8.38675	--	1718.8-1722.2	9.0-9.2
--	8.41425-8.41475	156.52475-156.52525	2200-2300	9.3-9.5
2.1735-2.1905	12.29-12.293	156.7-156.9	2310-2390	10.6-12.7
3.020-3.026	12.51975-12.52025	--	--	13.25-13.4
4.125-4.128	12.57675-12.57725	--	2655-2900	14.47-14.5
4.17725-4.17775	13.36-13.41	240-285	3260-3267	15.35-16.2
4.20725-4.20775	16.42-16.423	322-335.4	3332-3339	17.7-21.4
5.677-5.683	16.69475-16.69525	399.9-410	3345.8-3358	22.01-23.12
6.215-6.218	16.80425-16.80475	608-614	3500-4400	23.6-24.0
6.26775-6.26825	25.5-25.67	960-1427	4500-5150	31.2-31.8
6.31175-6.31225	37.5-38.25	1435-1626.5	5350-5460	36.43-36.5
8.291-8.294	73-74.6; 74.8-75.2	1645.5-1646.5	7250-7750	Above 38.6
8.362-8.366	108-138	1660-1710	8025-8500	

*Note: Certain frequency bands listed in Table 2 and above 38.6 GHz are designated for low-power licence-exempt applications. These frequency bands and the requirements that apply to the devices are set out in this Standard as well as RSS-310.*

**RSS- Gen Table 5: General Field Strength Limits for Transmitters at Frequencies Above 30 MHz**

Frequency (MHz)	Field Strength (microvolt/m at 3 metres)
30-88	100
88-216	150
216-960	200
Above 960	500

*Note: Transmitting devices are not permitted in Table 1 bands or, unless stated otherwise, in TV bands(54-72 MHz, 76-88 MHz, 174-216 MHz, 470-608 MHz and 614-806 MHz).*



**RSS- Gen Table 6: General Field Strength Limits for Transmitters at Frequencies Below 30 MHz (Transmit)**

Frequency (fundamental or spurious)	Field Strength (microvolts/m)	Magnetic H-Field (microamperes/m)	Measurement Distance (metres)
9-490 kHz	2,400/F (F in kHz)	2,400/377F (F in Hz)	300
490-1.705 kHz	24,000/F (F in kHz)	24,000/377F (F in kHz)	30
1.705-30 MHz	30	N/A	30

*Note: The emission limits for the bands 9-90 kHz and 110-490 kHz are based on measurements employing an average detector.*



### **RSS-Gen §7.1.2 Transmitter Antenna**

A transmitter can only be sold or operated with antennas with which it was approved. Transmitter may be approved with multiple antenna types. An antenna type comprises antennas having similar in-band and out-of-band radiation patterns. Testing shall be performed using the highest gain antenna of each combination of transmitter and antenna type for which approval is being sought, with the transmitter output power set at the maximum level. Any antenna of the same type having equal or lesser gain as an antenna that had been successfully tested with the transmitter, will also be considered approved with the transmitter, and may be used and marketed with the transmitter. For Category I transmitters, the manufacturer shall include with the application for certification a list of acceptable antenna types to be used with the transmitter.

When a measurement at the antenna connector is used to determine RF output power, the effective gain of the device's antenna shall be stated, based on measurement or on data from the antenna manufacturer.

For transmitters of RF output power of 10 milliwatts or less, only the portion of the antenna gain that is in excess of 6 dBi (6 dB above isotropic gain) shall be added to the measured RF output power to demonstrate compliance with the radiated power limits specified in the applicable standard. For transmitters of output power greater than 10 milliwatts, the total antenna gain shall be added to the measured RF output power to demonstrate compliance to the specified radiated power limits. User manuals for transmitters shall display the following notice in a conspicuous location:

*Under Industry Canada regulations, this radio transmitter may only operate using an antenna of a type and maximum (or lesser) gain approved for the transmitter by Industry Canada. To reduce potential radio interference to other users, the antenna type and its gain should be so chosen that the equivalent isotropically radiated power (e.i.r.p.) is not more than that necessary for successful communication.*

The above notice may be affixed to the device instead of displayed in the user manual.

User manuals for transmitters equipped with detachable antennas shall also contain the following notice in a conspicuous location:

*This radio transmitter (identify the device by certification number, or model number if Category II) has been approved by Industry Canada to operate with the antenna types listed below with the maximum permissible gain and required antenna impedance for each antenna type indicated. Antenna types not included in this list, having a gain greater than the maximum gain indicated for that type, are strictly prohibited for use with this device.*

Immediately following the above notice, the manufacturer shall provide a list of all antenna types approved for use with the transmitter, indicating the maximum permissible antenna gain (in dBi) and required impedance for each.



**RSS-Gen §7.2.4 Transmitter and Receiver AC Power Lines Conducted Emission Limits**

Except when the requirements applicable to a given device state otherwise, for any radio apparatus equipped to operate from the public utility AC power supply, either directly or indirectly (such as with a battery charger), the radio frequency voltage of emissions conducted back onto the AC power lines in the frequency range of 0.15 MHz to 30 MHz shall not exceed the limits shown in the table below. The more stringent limit applies at the frequency range boundaries.

The conducted emissions shall be measured with a 50 ohm/50 microhenry line impedance stabilization network (LISN).

**RSS-Gen Table 4 – AC Power Line Conducted Emission Limits**

Frequency Range (MHz)	Conducted limit (dBµV)	
	Quasi-peak	Average
0.15 to 0.5	66 to 56*	56 to 46*
0.5 to 5	56	46
5 to 30	60	50

*\*Decreases with the logarithm of the frequency.*





## 8. FCC PART 15 REQUIREMENTS & RSS 210 REQUIREMENTS

### 8.1 AVERAGE POWER

#### limit

None; for reporting purposes only.

#### Test Configuration

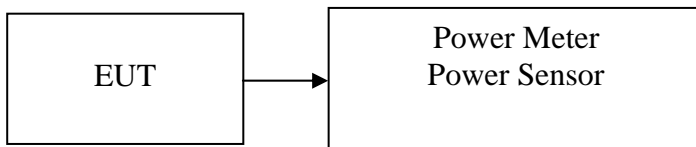

#### test procedure

The transmitter output is connected to the Power Meter. The Power Meter is set to the Average power detection.

#### test results

No non-compliance noted.



**Test Data**

**Test mode: IEEE 802.11a mode / 5180 ~ 5240MHz**

Channel	Frequency (MHz)	Output Power (dBm)	Limit (dBm)
Low	5180	13.0	17.00
Mid	5220	13.0	17.00
High	5240	13.0	17.00

**Test mode: IEEE 802.11n HT 20 MHz Channel mode / 5180 ~ 5240MHz**

Channel	Frequency (MHz)	Chain 0 Output Power (dBm)	Chain 1 Output Power (dBm)	Total Output Power (dBm)	Maximum Conducted Output Power Limit (dBm)
Low	5180	9.0	9.0	12.0	17.00
Mid	5220	9.0	9.0	12.0	17.00
High	5240	8.5	8.5	11.5	17.00

**Test mode: IEEE 802.11n HT 40 MHz mode / 5190 ~ 5230MHz**

Channel	Frequency (MHz)	Chain 0 Output Power (dBm)	Chain 1 Output Power (dBm)	Total Output Power (dBm)	Maximum Conducted Output Power Limit (dBm)
Low	5190	9.0	9.0	12.0	17.00
High	5230	10.0	10.0	13.0	17.00

Remark: Total Output Power (w) = Chain 0 (10^(Output Power /10)/1000) + Chain 1 (10^(Output Power /10)/1000))



**Test mode: IEEE 802.11a mode / 5260 ~ 5320MHz**

Channel	Frequency (MHz)	Output Power (dBm)	Limit (dBm)
Low	5260	17.5	24.00
Mid	5280	16.0	24.00
High	5320	14.0	24.00

**Test mode: IEEE 802.11n HT 20 MHz Channel mode / 5260 ~ 5320MHz**

Channel	Frequency (MHz)	Chain 0 Output Power (dBm)	Chain 1 Output Power (dBm)	Total Output Power (dBm)	Maximum Conducted Output Power Limit (dBm)
Low	5260	13.0	13.0	16.0	24.00
Mid	5280	16.0	16.0	19.0	24.00
High	5320	14.0	14.0	17.0	24.00

**Test mode: IEEE 802.11n HT 40 MHz mode / 5270 ~ 5310MHz**

Channel	Frequency (MHz)	Chain 0 Output Power (dBm)	Chain 1 Output Power (dBm)	Total Output Power (dBm)	Maximum Conducted Output Power Limit (dBm)
Low	5270	16.5	16.5	19.5	24.00
High	5310	11.0	11.0	14.0	24.00

Remark: Total Output Power (w) = Chain 0 (10^(Output Power /10)/1000) + Chain 1 (10^(Output Power /10)/1000)



**Test mode: IEEE 802.11a mode / 5500 ~ 5700MHz**

Channel	Frequency (MHz)	Output Power (dBm)	Limit (dBm)
Low	5500	16.5	24.00
Mid	5580	17.0	24.00
High	5700	17.0	24.00

**Test mode: IEEE 802.11n HT 20 MHz Channel mode/ 5500 ~ 5700MHz**

Channel	Frequency (MHz)	Chain 0 Output Power (dBm)	Chain 1 Output Power (dBm)	Total Output Power (dBm)	Maximum Conducted Output Power Limit (dBm)
Low	5500	16.0	16.0	19.0	24.00
Mid	5580	16.0	16.0	19.0	24.00
High	5700	12.0	12.0	15.0	24.00

**Test mode: IEEE 802.11n HT 40 MHz mode / 5510 ~ 5670MHz**

Channel	Frequency (MHz)	Chain 0 Output Power (dBm)	Chain 1 Output Power (dBm)	Total Output Power (dBm)	Maximum Conducted Output Power Limit (dBm)
Low	5510	13.0	13.0	16.0	24.00
Mid	5550	17.0	17.0	20.0	24.00
High	5670	17.0	17.0	20.0	24.00

Remark: Total Output Power (w) = Chain 0 (10^(Output Power /10)/1000) + Chain 1 (10^(Output Power /10)/1000)



## 8.2 BAND EDGES MEASUREMENT

### LIMIT

According to §15.407(b) & RSS-210 §A8.5,

- (1) The provisions of Section 15.205 of this part apply to intentional radiators operating under this section.
- (2) When measuring the emission limits, the nominal carrier frequency shall be adjusted as close to the upper and lower frequency block edges as the design of the equipment permits.

### Test Configuration

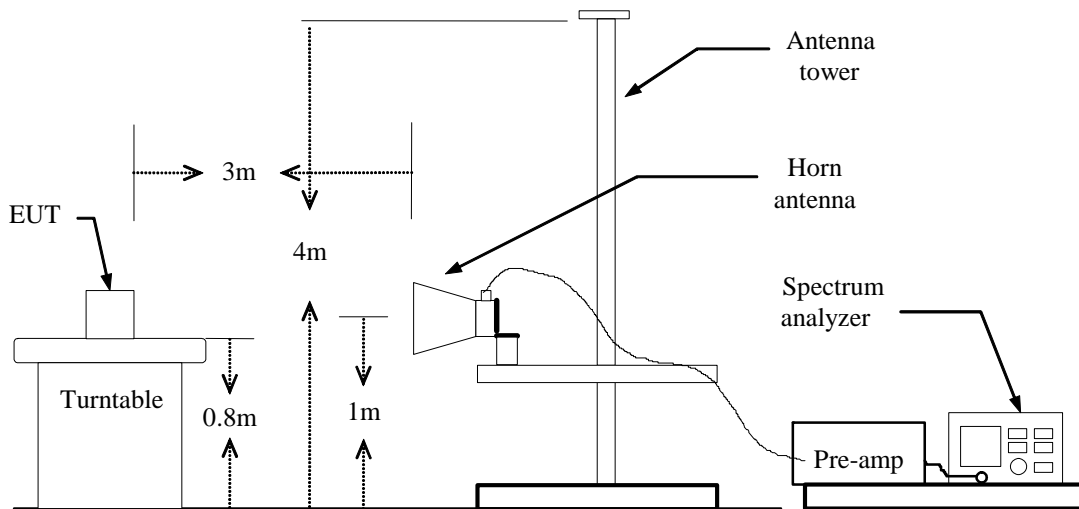

### TEST PROCEDURE

1. The EUT is placed on a turntable, which is 0.8m above the ground plane.
2. The turntable shall be rotated for 360 degrees to determine the position of maximum emission level.
3. EUT is set 3m away from the receiving antenna, which is varied from 1m to 4m to find out the highest emission.
4. Set the spectrum analyzer in the following setting in order to capture the lower and upper band-edges of the emission:
  - (a) PEAK: RBW=VBW=1MHz / Sweep=AUTO
  - (b) AVERAGE: RBW=1MHz / VBW=10Hz / Sweep=AUTO
5. Repeat the procedures until all the PEAK and AVERAGE versus POLARIZATION are measured.

### TEST RESULTS

Refer to attach spectrum analyzer data chart.



Band Edges (IEEE 802.11a mode / 5180 MHz)

Detector mode: Peak

Polarity: Vertical

Agilent

R T

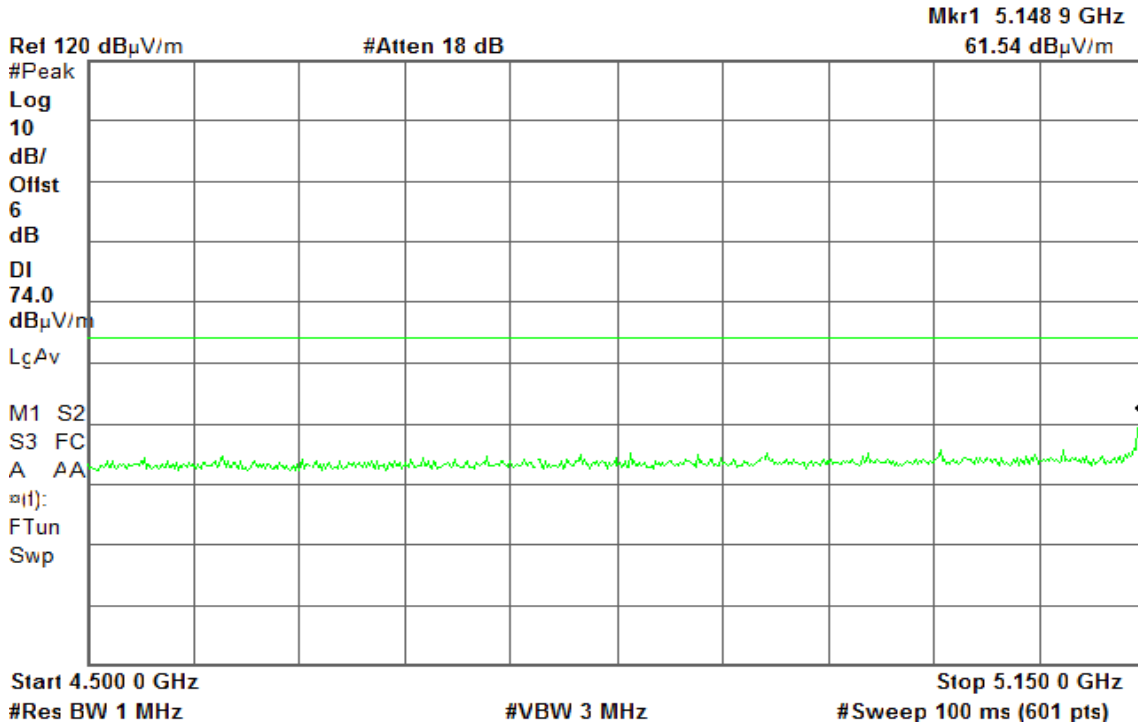

Detector mode: Average

Polarity: Vertical

Agilent

R T

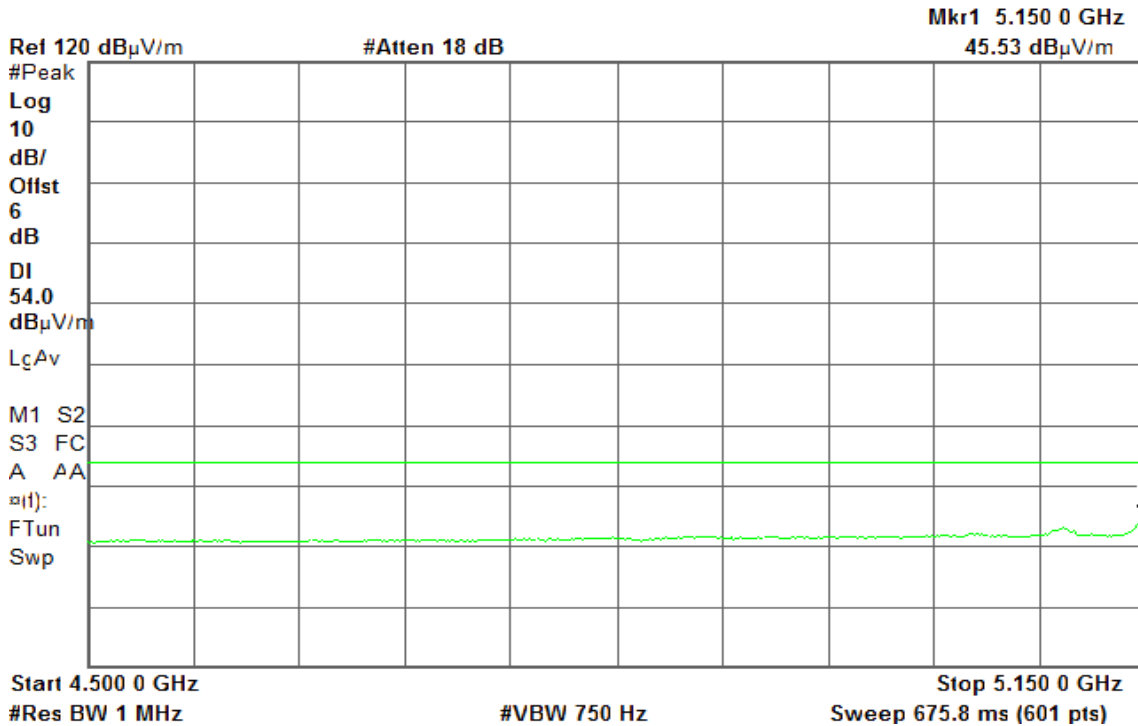



Detector mode: Peak

Polarity: Horizontal

Agilent

R T

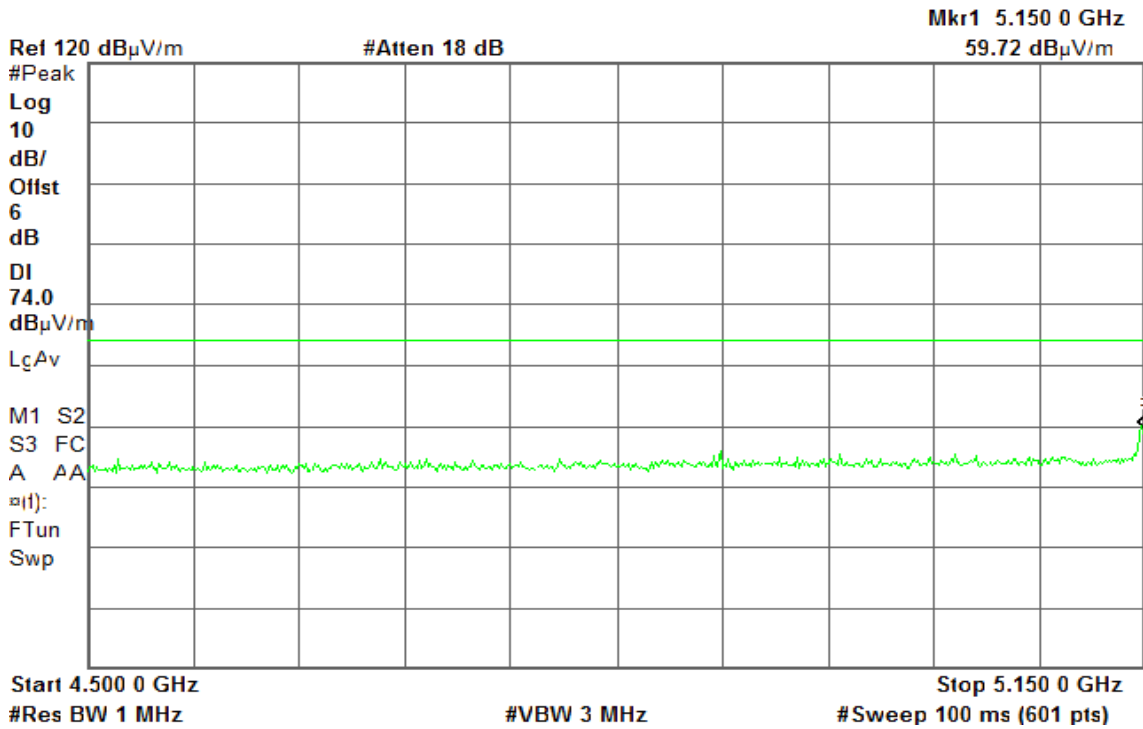

Detector mode: Average

Polarity: Horizontal

Agilent

R T

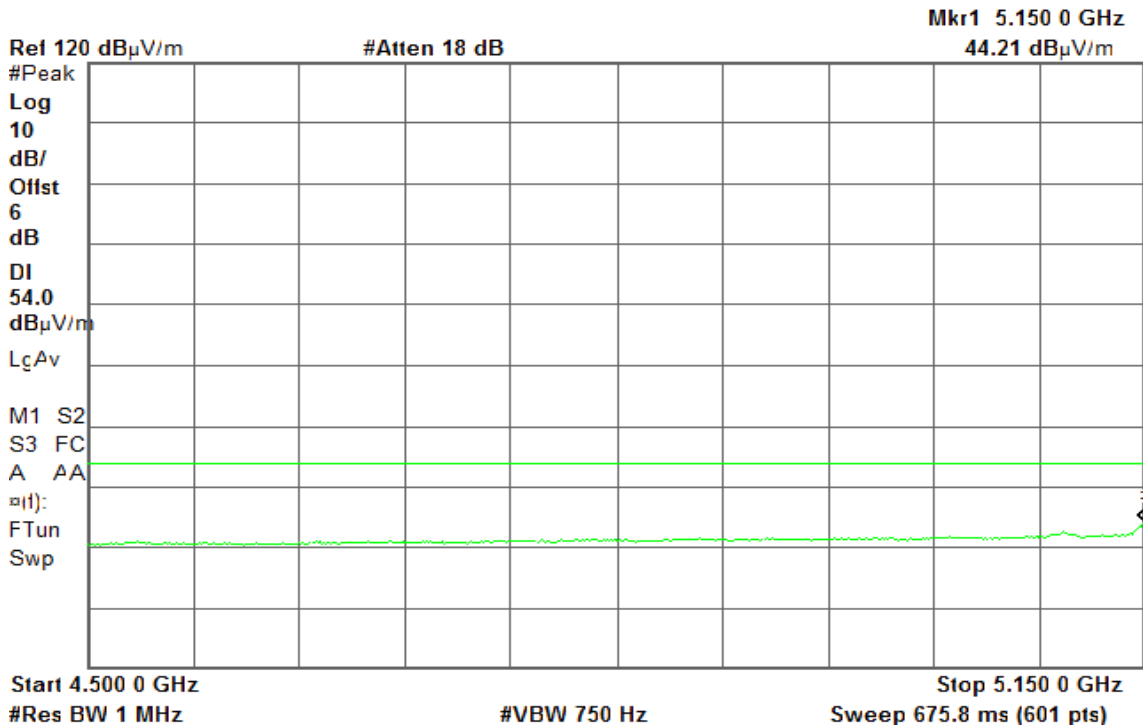



### Band Edges (IEEE 802.11a mode / 5320 MHz)

Detector mode: Peak

Polarity: Vertical

Agilent

R T

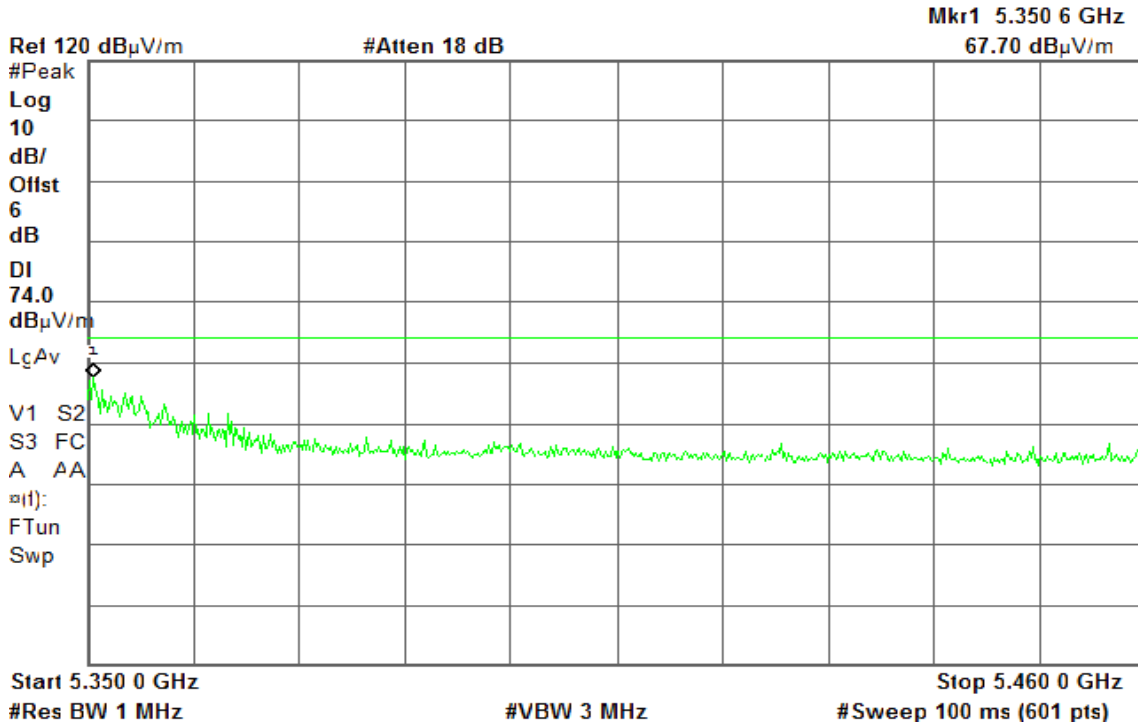

Detector mode: Average

Polarity: Vertical

Agilent

R T

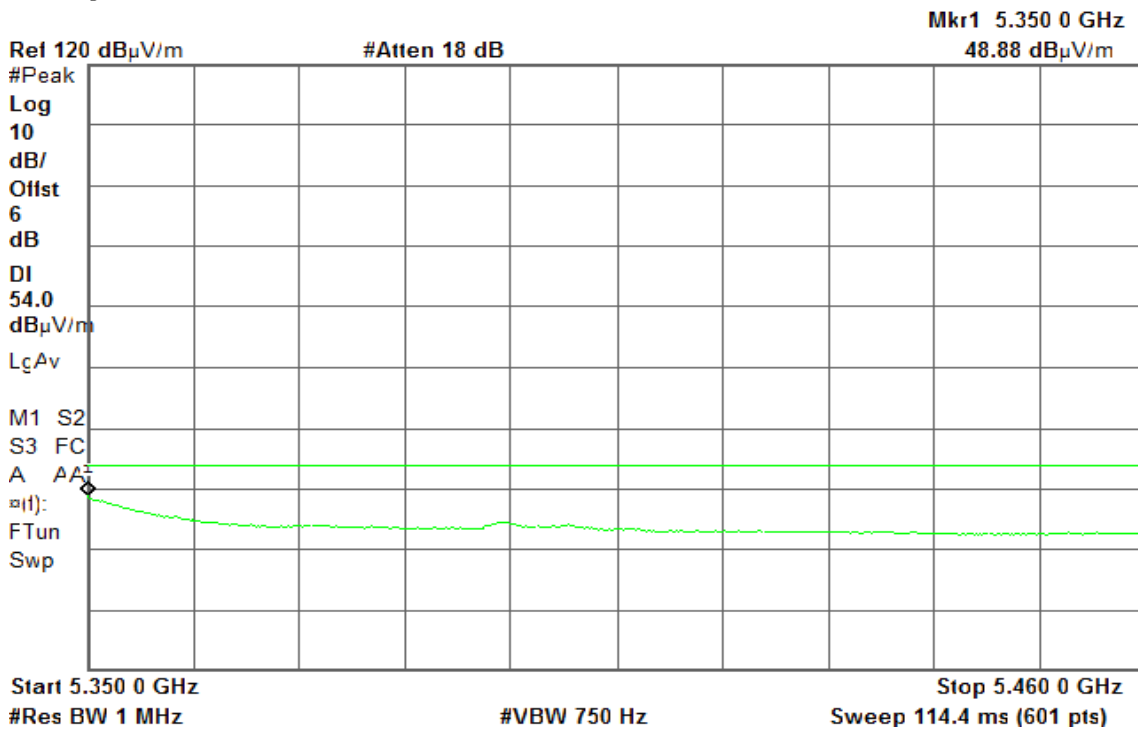





Detector mode: Peak

Polarity: Horizontal

Agilent

R T

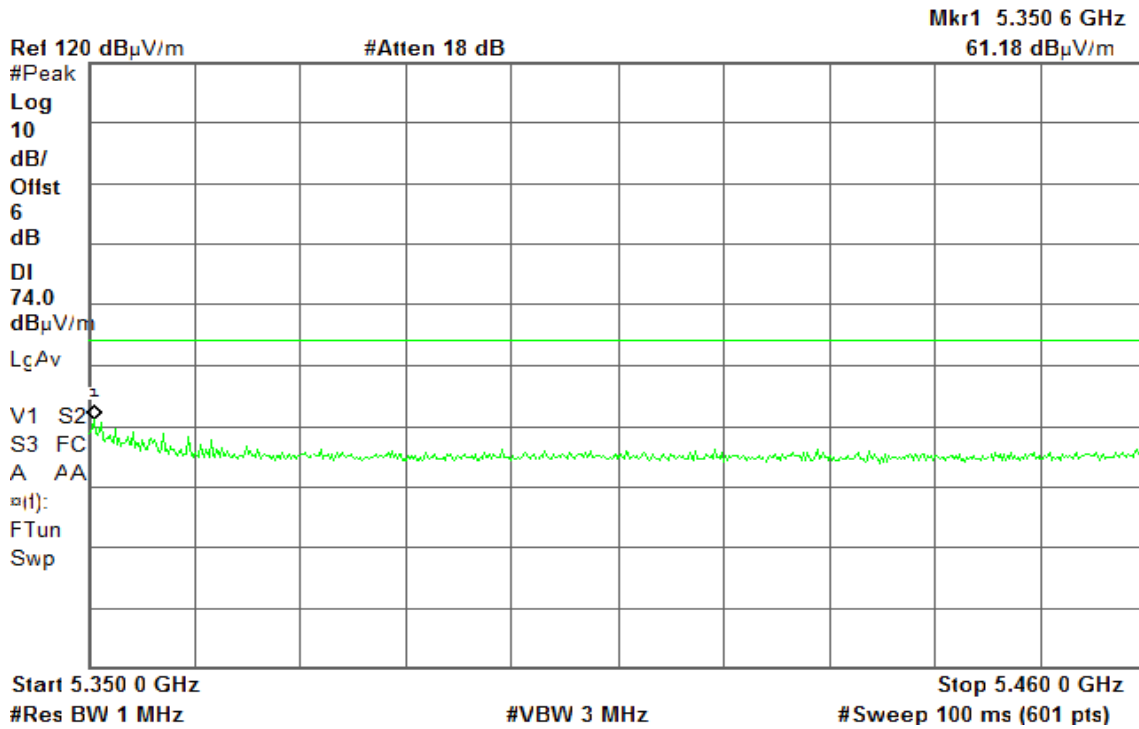

Detector mode: Average

Polarity: Horizontal

Agilent

R T

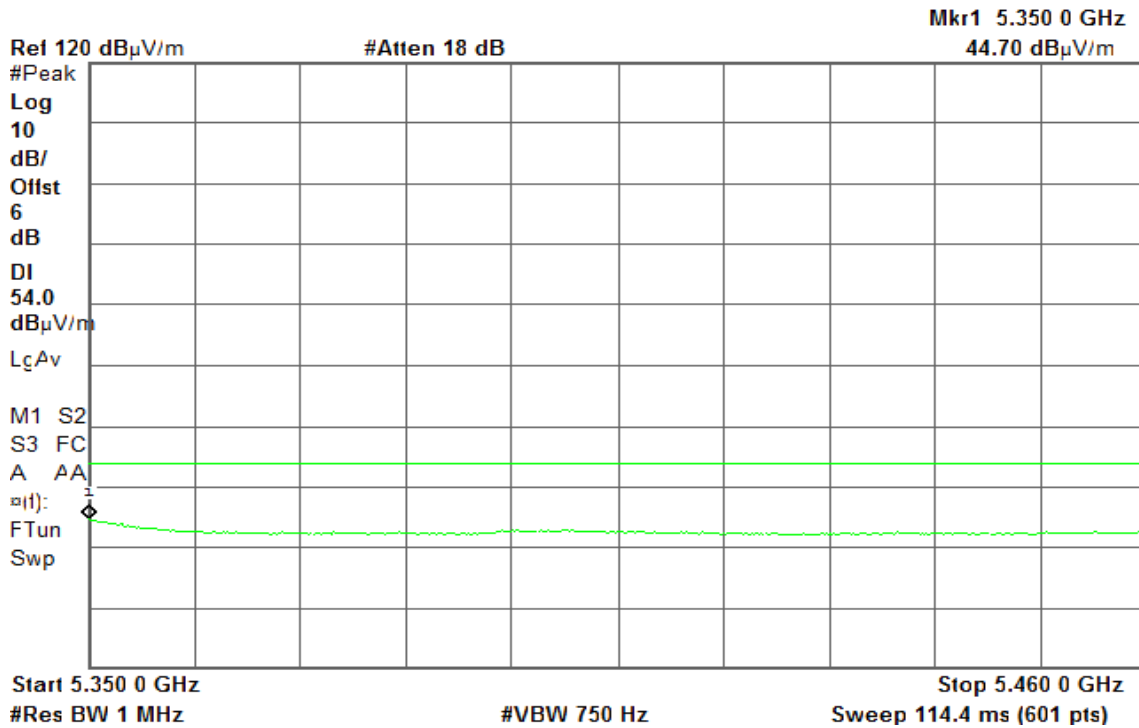



Band Edges (IEEE 802.11n HT 20 MHz Channel mode / 5180 MHz)

Detector mode: Peak

Polarity: Vertical

Agilent

R T

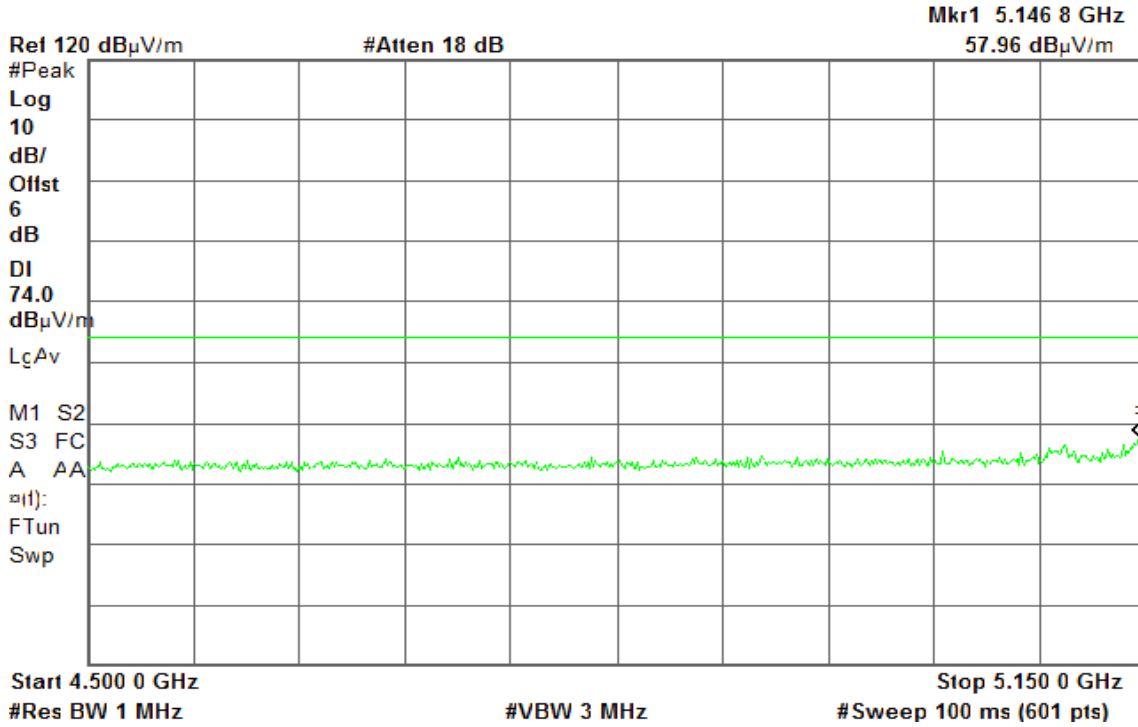

Detector mode: Average

Polarity: Vertical

Agilent

R T

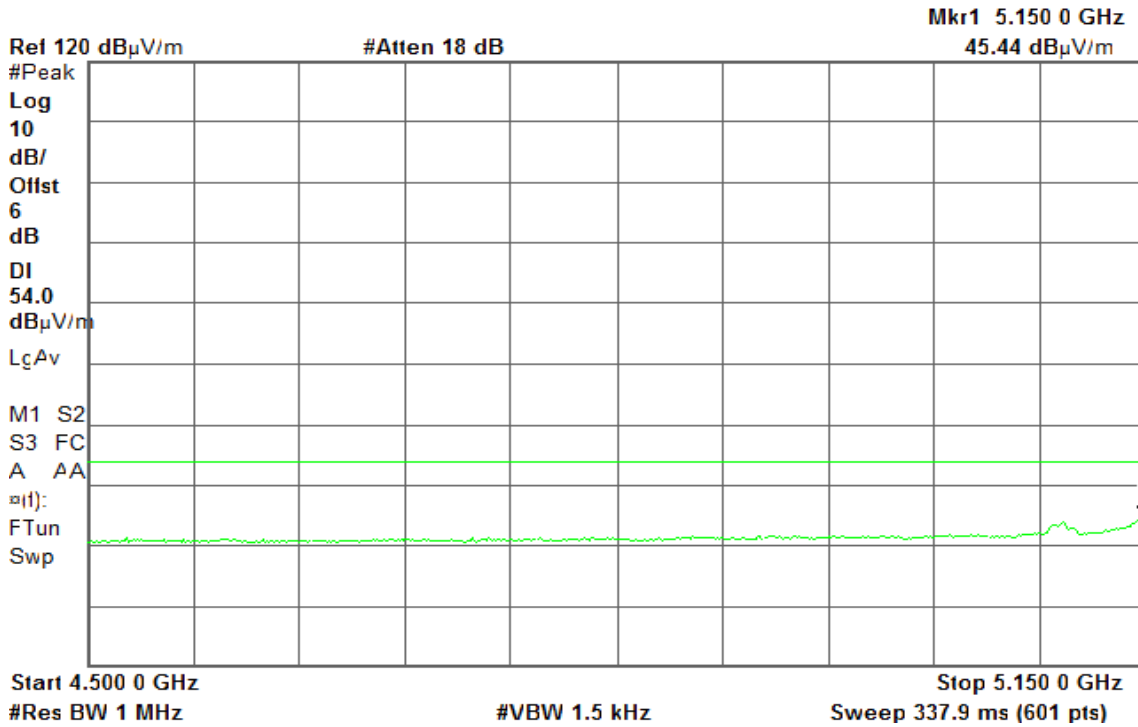



Detector mode: Peak

Polarity: Horizontal

Agilent

R T

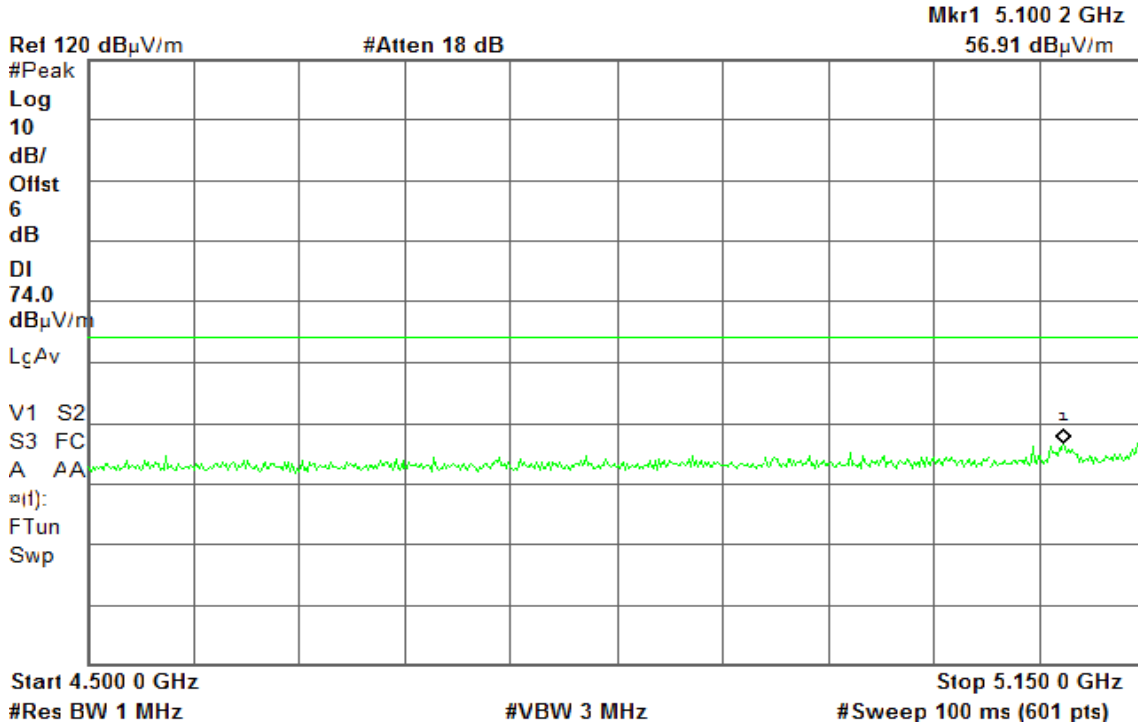

Detector mode: Average

Polarity: Horizontal

Agilent

R T

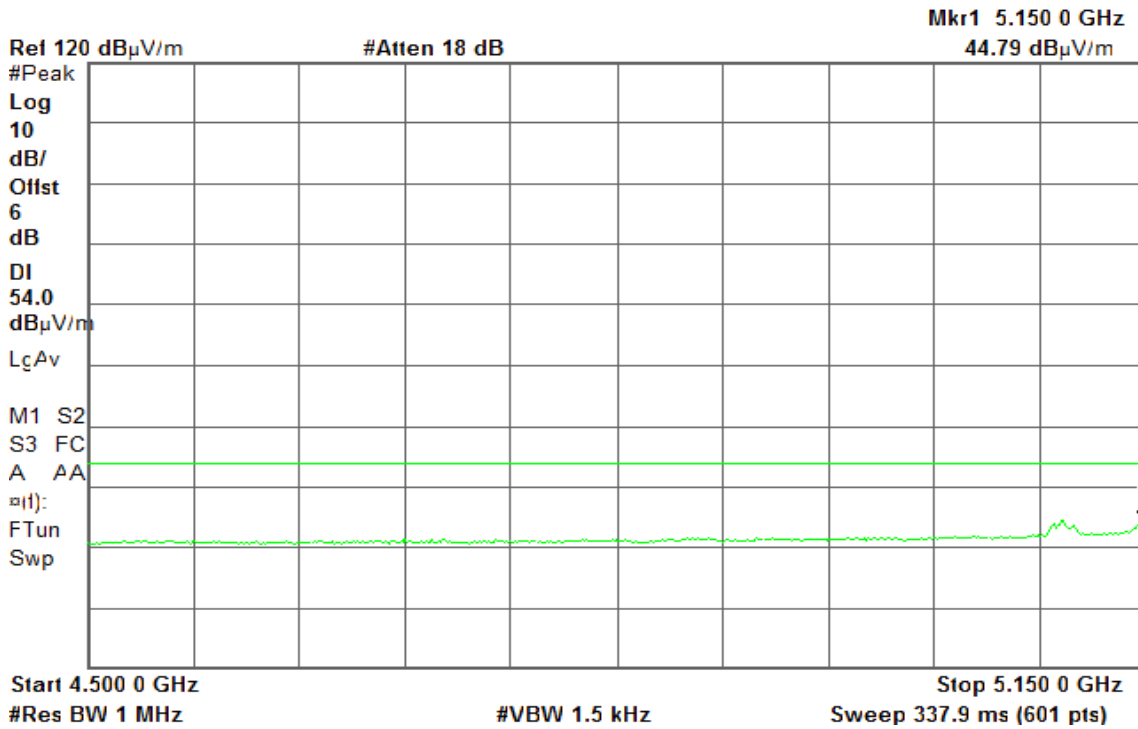



Band Edges (IEEE 802.11n HT 20 MHz Channel mode / 5320 MHz)

Detector mode: Peak

Polarity: Vertical

Agilent

R T

Mkr1 5.350 6 GHz  
63.02 dBμV/m

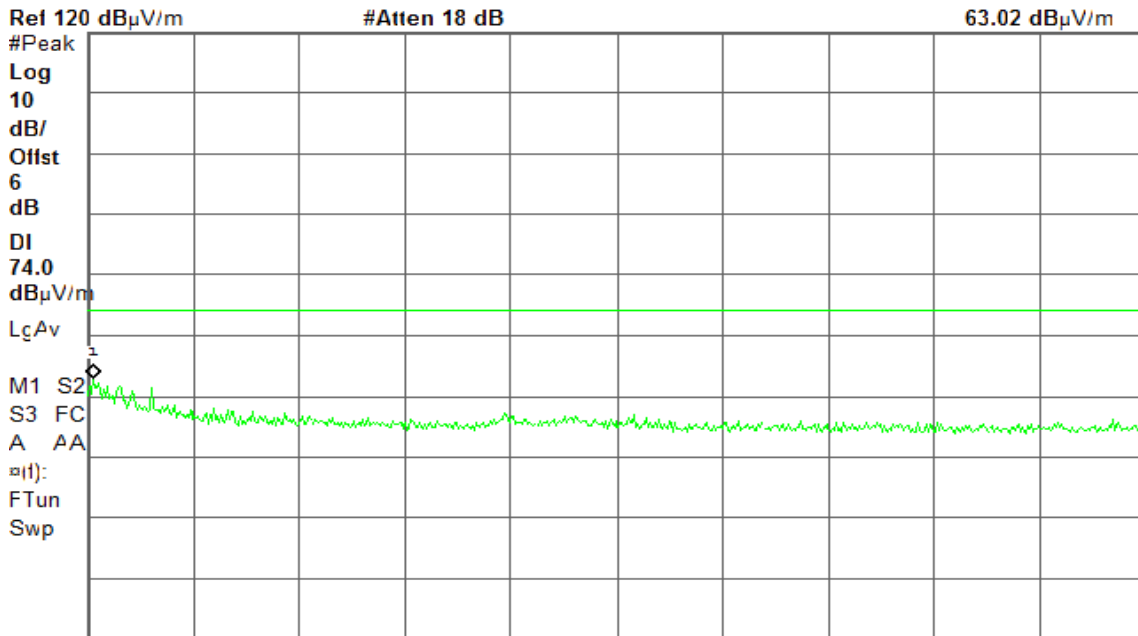

Start 5.350 0 GHz Stop 5.460 0 GHz  
#Res BW 1 MHz #VBW 3 MHz #Sweep 100 ms (601 pts)

Detector mode: Average

Polarity: Vertical

Agilent

R T

Mkr1 5.350 0 GHz  
48.17 dBμV/m

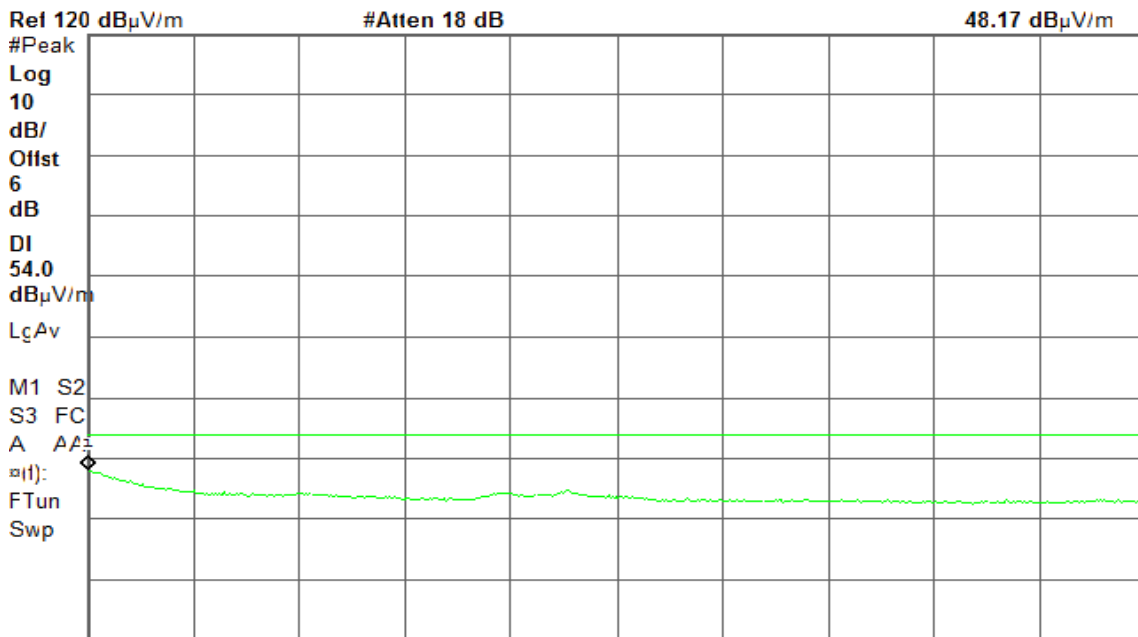

Start 5.350 0 GHz Stop 5.460 0 GHz  
#Res BW 1 MHz #VBW 1.5 kHz Sweep 57.2 ms (601 pts)



Detector mode: Peak

Polarity: Horizontal

Agilent

R T

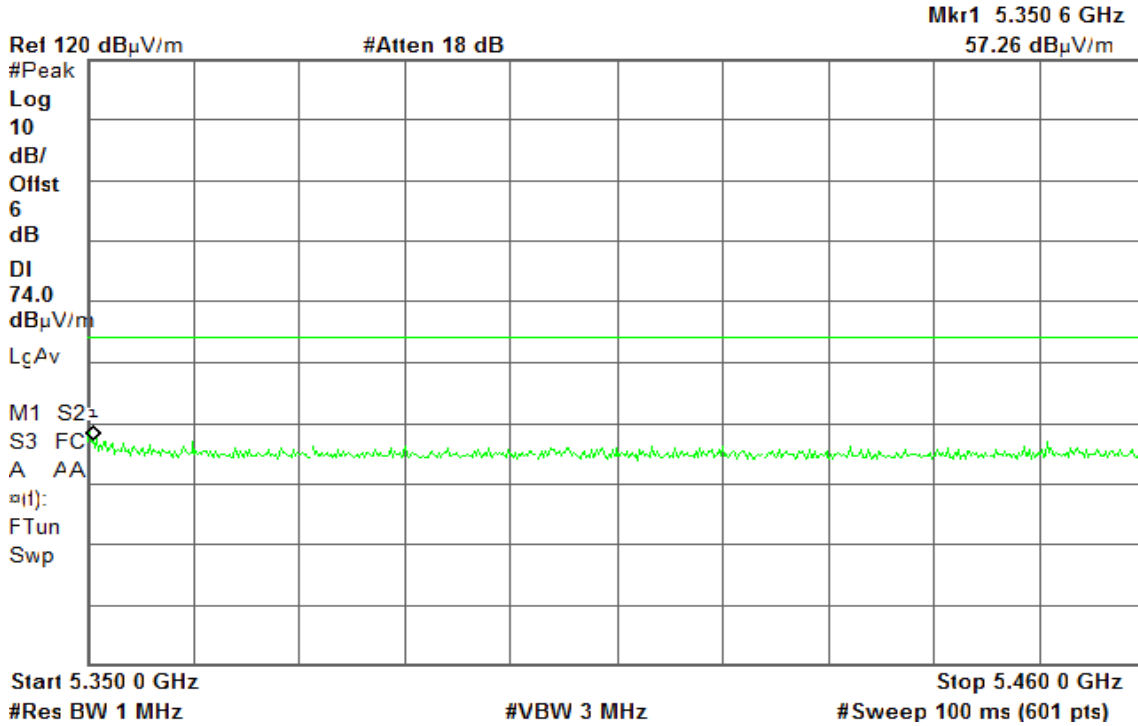

Detector mode: Average

Polarity: Horizontal

Agilent

R T

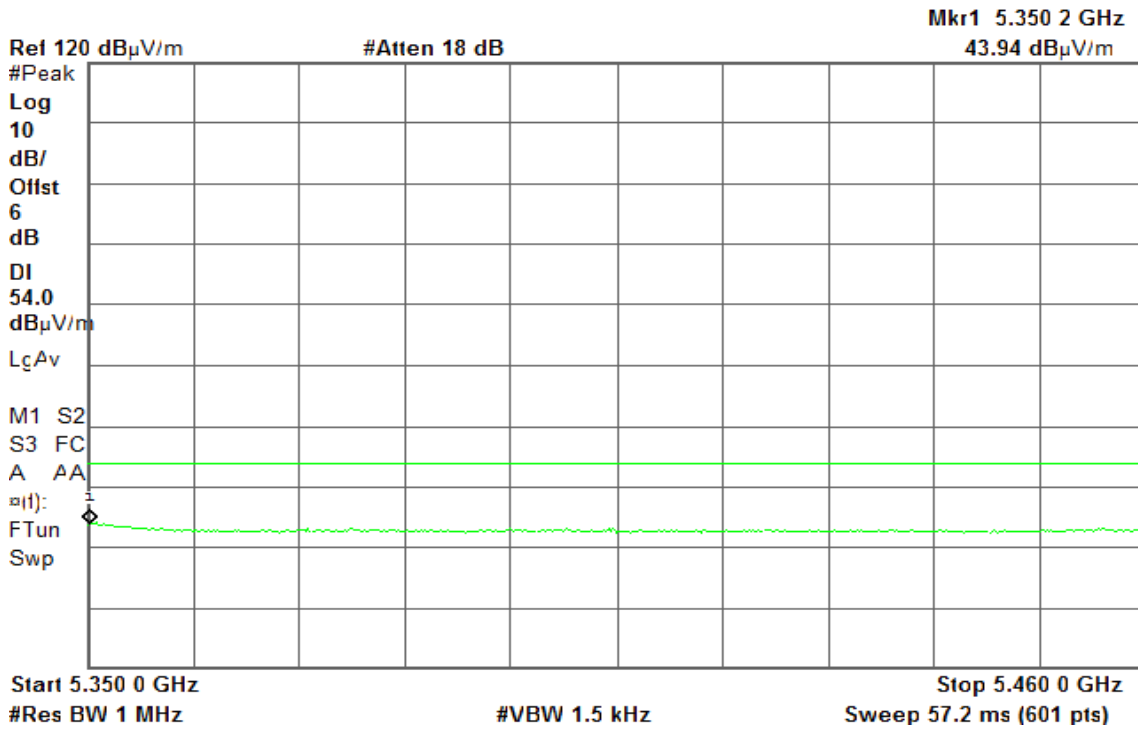



Band Edges (IEEE 802.11n HT 40 MHz mode / 5190 MHz)

Detector mode: Peak

Polarity: Vertical

Agilent

R T

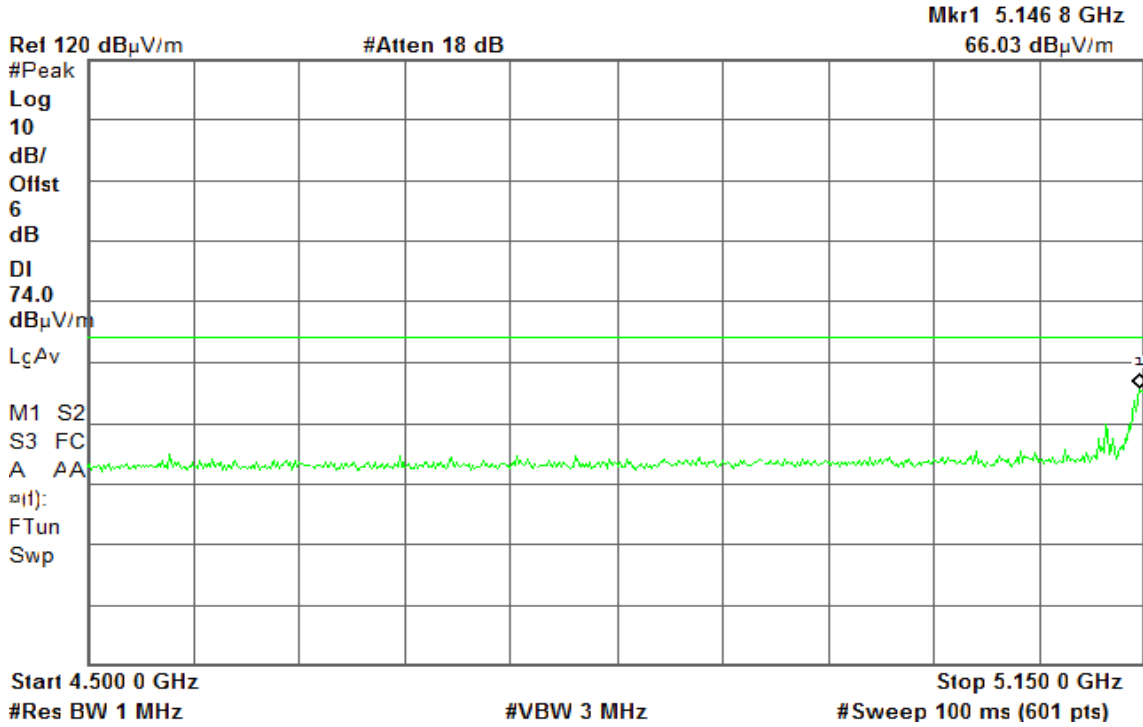

Detector mode: Average

Polarity: Vertical

Agilent

R T

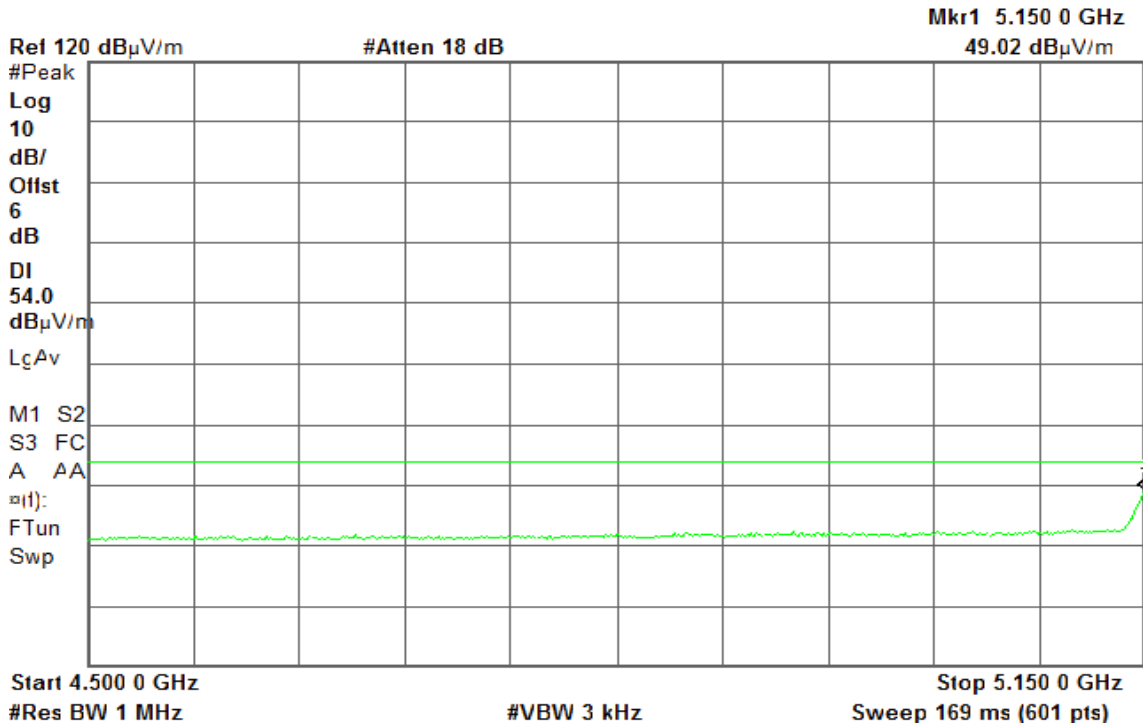



Detector mode: Peak

Polarity: Horizontal

Agilent

R T

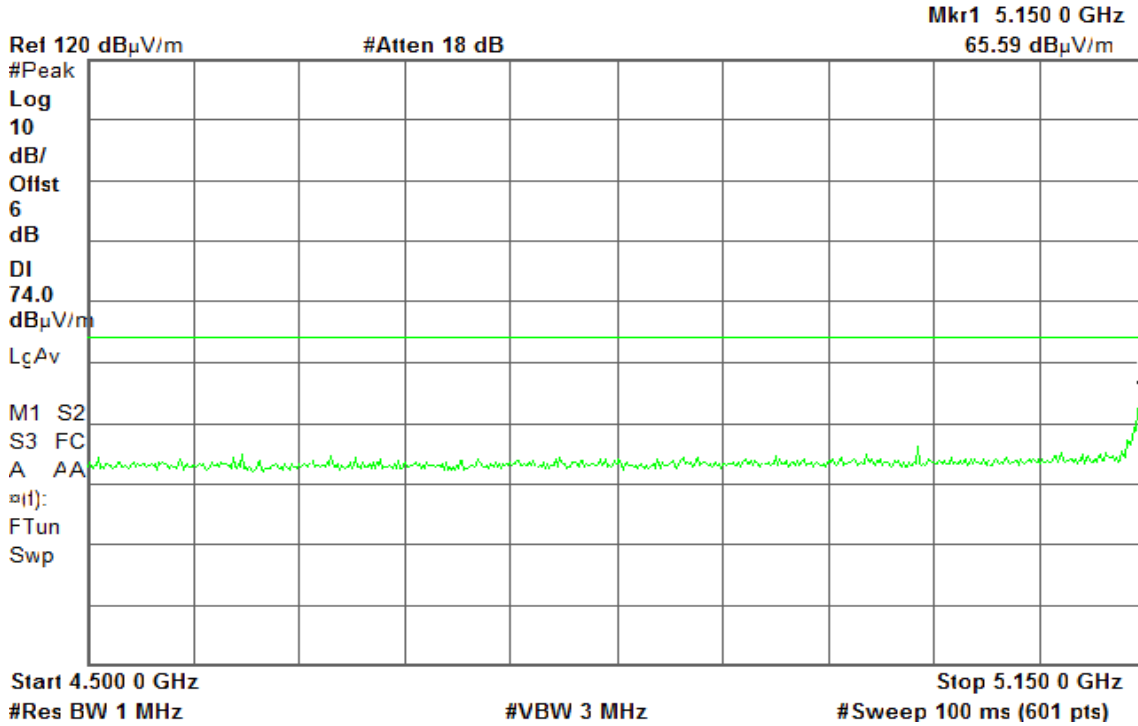

Detector mode: Average

Polarity: Horizontal

Agilent

R T

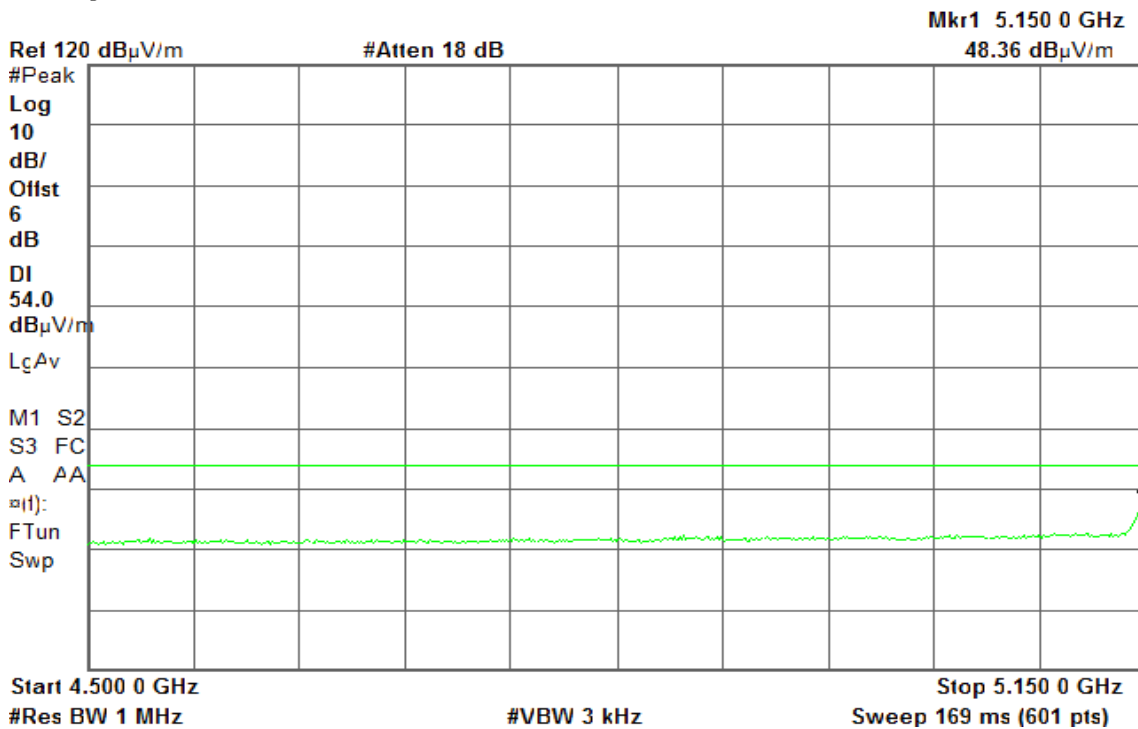



Band Edges (IEEE 802.11n HT 40 MHz mode / CH 5310 MHz)

Detector mode: Peak

Polarity: Vertical

Agilent

R T

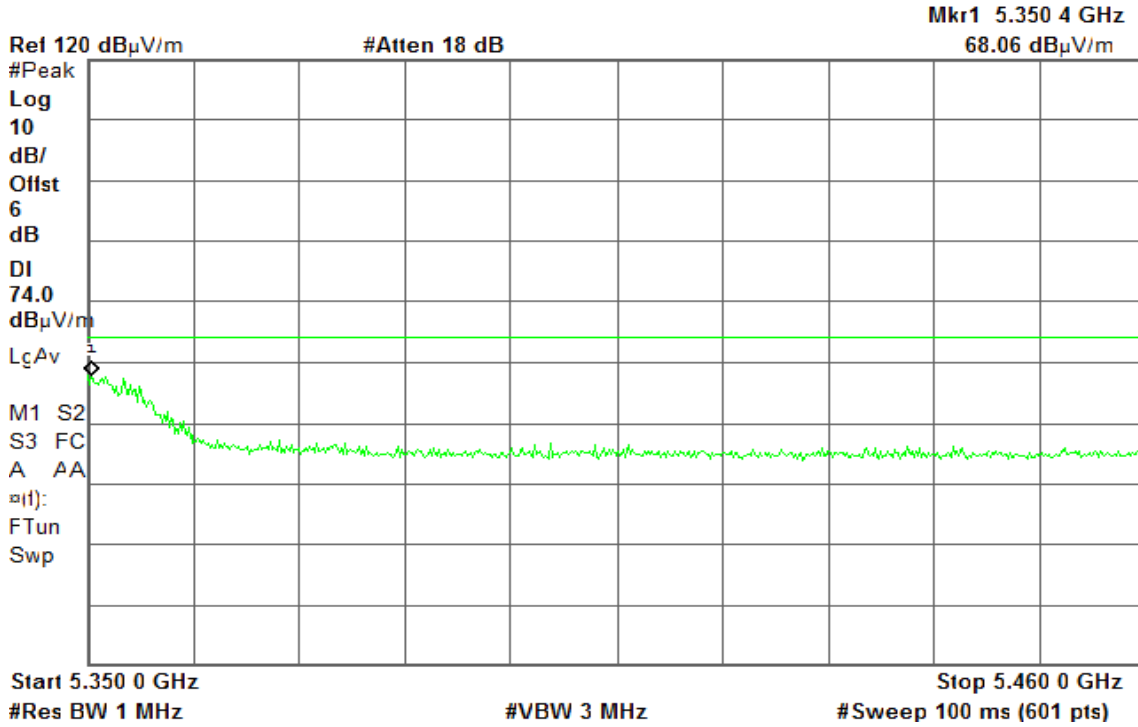

Detector mode: Average

Polarity: Vertical

Agilent

R T

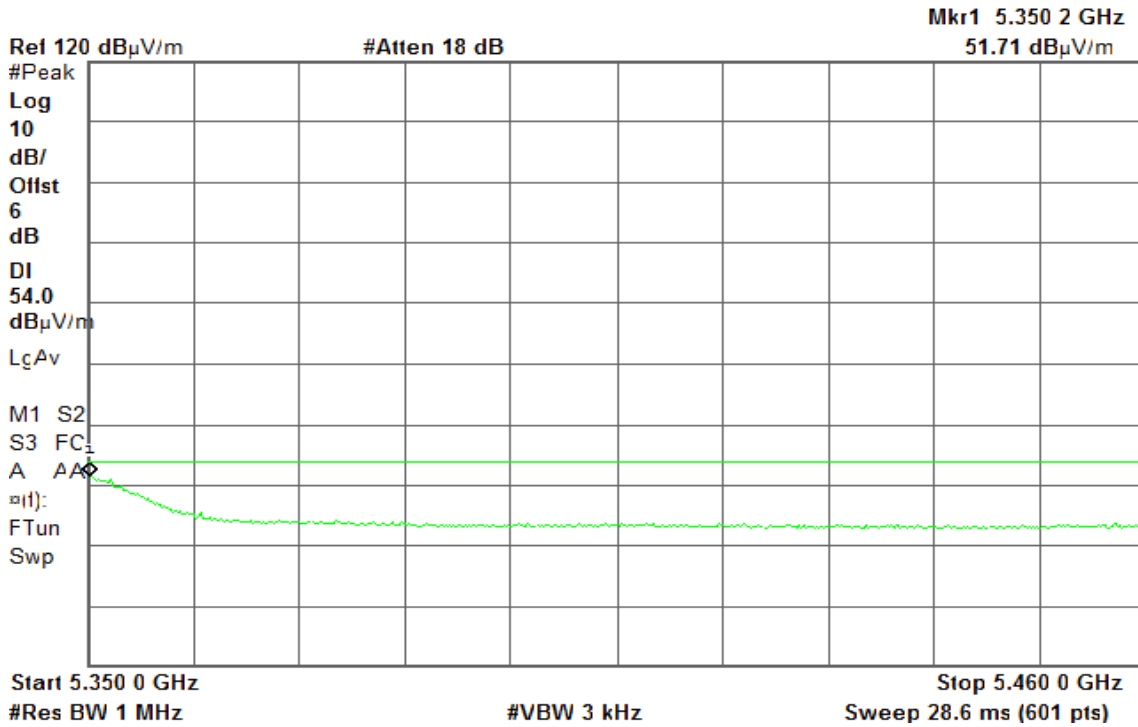





Detector mode: Peak

Polarity: Horizontal

Agilent

R T

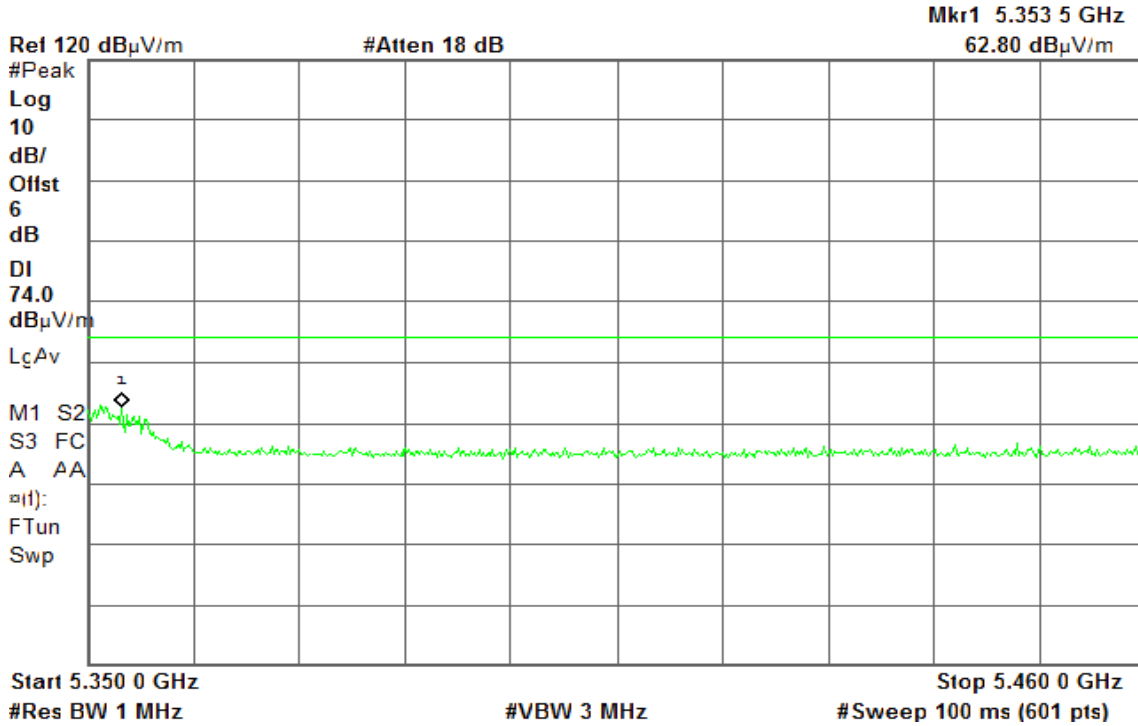

Detector mode: Average

Polarity: Horizontal

Agilent

R T

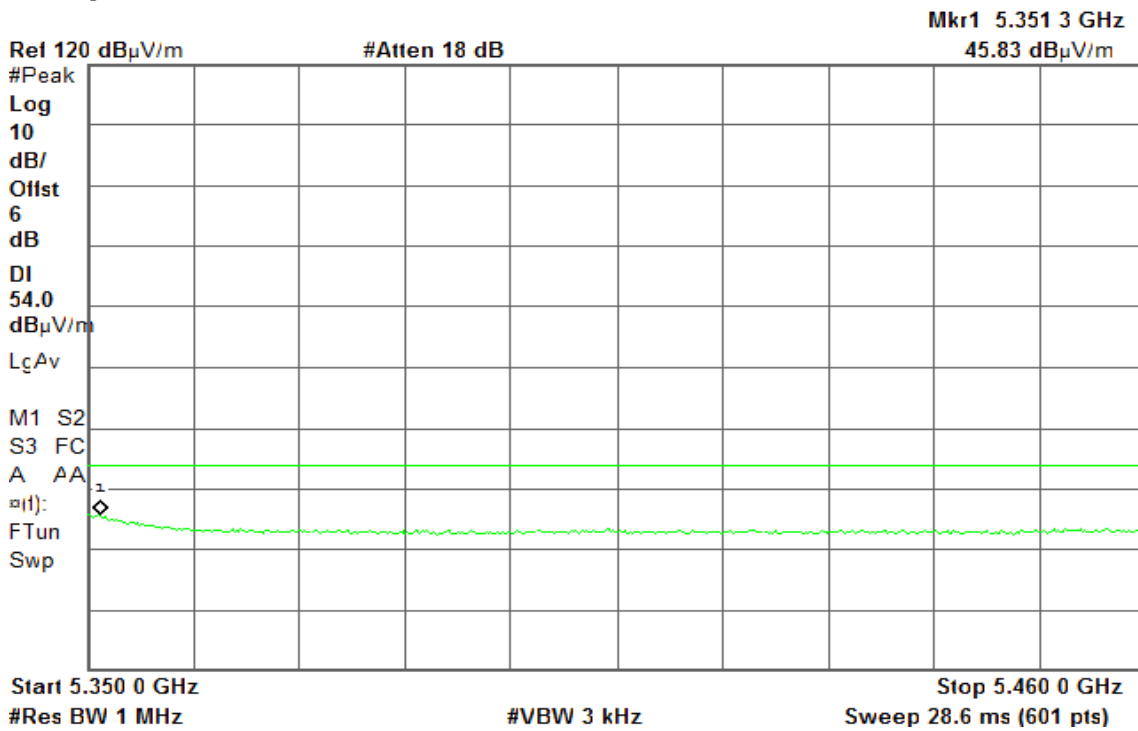



### 8.3 RADIATED UNDESIRABLE EMISSION

1. According to §15.209(a) & RSS-210 §A9.3, except as provided elsewhere in this Subpart, the emissions from an intentional radiator shall not exceed the field strength levels specified in the following table:

Frequency (MHz)	Field Strength (µV/m)	Measurement Distance (m)
30-88	100*	3
88-216	150*	3
216-960	200*	3
Above 960	500	3

**Remark:** Except as provided in paragraph (g), fundamental emissions from intentional radiators operating under this Section shall not be located in the frequency bands 54-72 MHz, 76-88 MHz, 174-216 MHz or 470-806 MHz. However, operation within these frequency bands is permitted under other sections of this Part, e.g., Sections 15.231 and 15.241.

2. In the emission table above, the tighter limit applies at the band edges.

Frequency (MHz)	Field Strength (µV/m at 3-meter)	Field Strength (dBµV/m at 3-meter)
30-88	100	40
88-216	150	43.5
216-960	200	46
Above 960	500	54



### Test Configuration

#### 9kHz ~ 30MHz

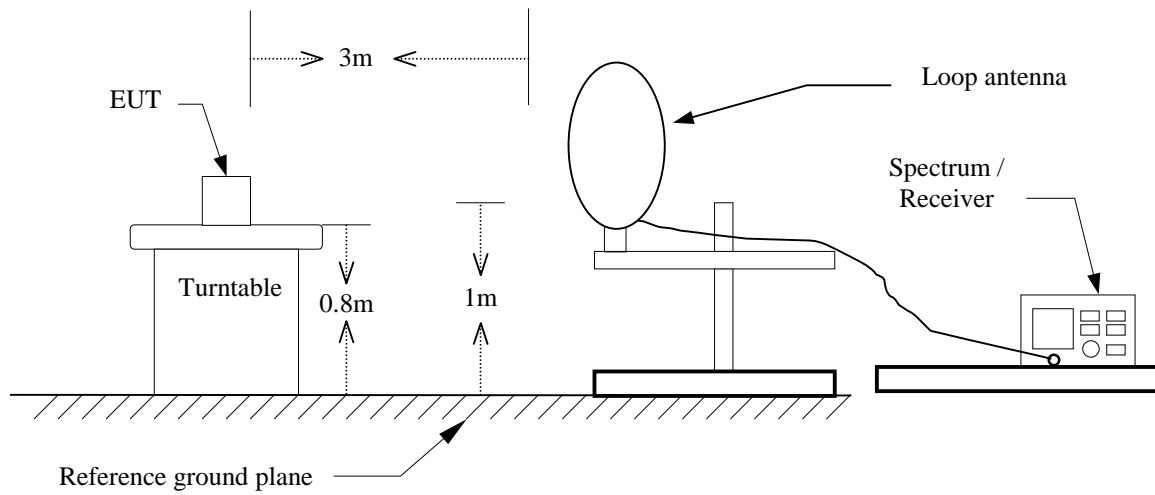

#### 30MHz ~ 1GHz

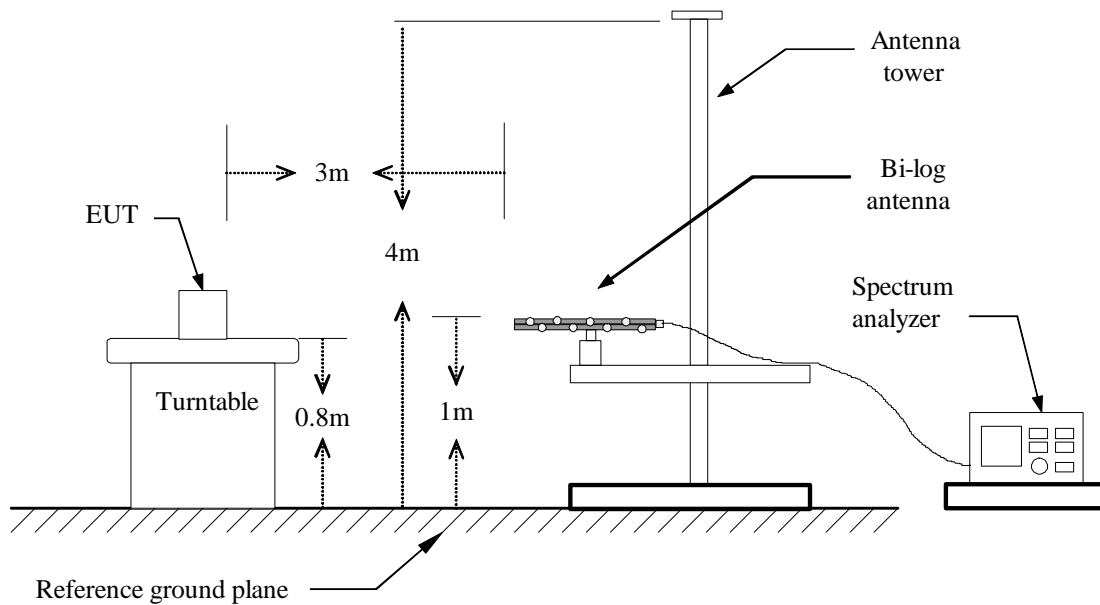



Above 1 GHz

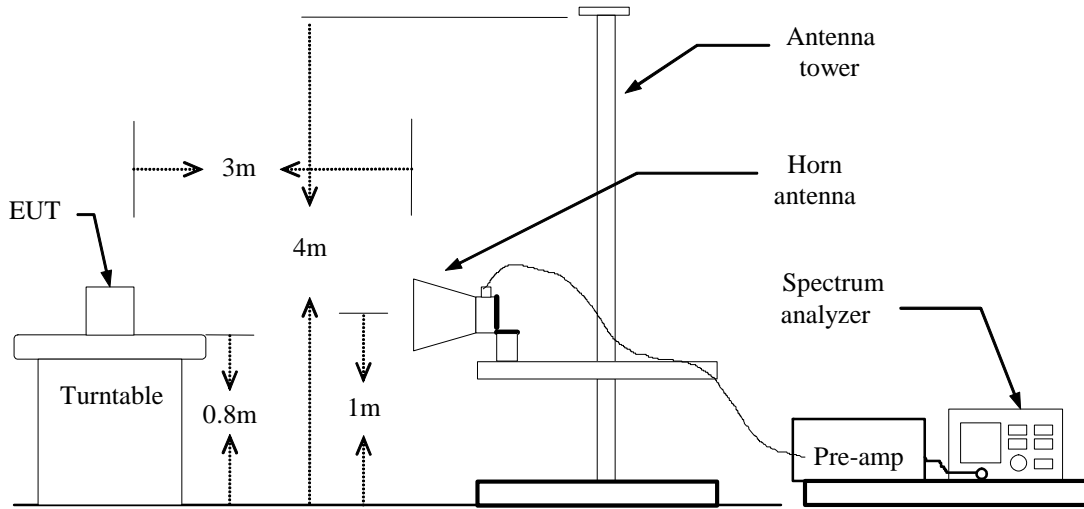



## **TEST PROCEDURE**

1. The EUT is placed on a turntable, which is 0.8m above ground plane.
2. The turntable shall be rotated for 360 degrees to determine the position of maximum emission level.
3. EUT is set 3m away from the receiving antenna, which is varied from 1m to 4m to find out the highest emissions.
4. Maximum procedure was performed on the six highest emissions to ensure EUT compliance.
5. And also, each emission was to be maximized by changing the polarization of receiving antenna both horizontal and vertical.
6. Set the spectrum analyzer in the following setting as:

Below 1GHz:

RBW=100kHz / VBW=300kHz / Sweep=AUTO

Above 1GHz:

(a) PEAK: RBW=VBW=1MHz / Sweep=AUTO

(b) AVERAGE: RBW=1MHz / VBW=10Hz / Sweep=AUTO

7. Repeat above procedures until the measurements for all frequencies are complete.



**Below 1 GHz**

**Operation Mode:** Normal Link

**Test Date:** March 18, 2013

**Temperature:** 27°C

**Tested by:** Shawn Wu

**Humidity:** 53% RH

**Polarity:** Ver. / Hor.

Frequency (MHz)	Reading (dBuV)	Correction Factor (dB/m)	Result (dBuV/m)	Limit (dBuV/m)	Margin (dB)	Remark	Ant.Pol. (H/V)
31.6167	57.16	-21.64	35.52	40.00	-4.48	Peak	V
110.8333	53.34	-29.83	23.51	43.50	-19.99	Peak	V
202.9833	53.29	-28.89	24.40	43.50	-19.10	Peak	V
377.5833	62.40	-25.99	36.41	46.00	-9.59	Peak	V
571.5833	51.63	-22.65	28.98	46.00	-17.02	Peak	V
856.1167	48.71	-18.06	30.65	46.00	-15.35	Peak	V
31.6167	48.32	-21.64	26.68	40.00	-13.32	Peak	H
76.8833	54.27	-33.73	20.54	40.00	-19.46	Peak	H
251.4833	58.52	-29.54	28.98	46.00	-17.02	Peak	H
375.9667	61.73	-26.03	35.70	46.00	-10.30	Peak	H
799.5333	52.94	-19.04	33.90	46.00	-12.10	Peak	H
864.2000	52.24	-17.93	34.31	46.00	-11.69	Peak	H

**Remark:**

- 1 *Measuring frequencies from 30 MHz to the 1GHz.*
- 2 *Radiated emissions measured in frequency range from 30 MHz to 1000MHz were made with an instrument using peak/quasi-peak detector mode.*
- 3 *Quasi-peak test would be performed if the peak result were greater than the quasi-peak limit or as required by the applicant.*
- 4 *Measurements above show only up to 6 maximum emissions noted, or would be lesser, with " N/A " remark, if no specific emissions from the EUT are recorded (ie: margin>20dB from the applicable limit) and considered that's already beyond the background noise floor.*
- 5 *Margin (dB) = Remark result (dBuV/m) – Quasi-peak limit (dBuV/m).*



**Above 1 GHz**

**Operation Mode:** Tx / IEEE 802.11a mode / 5180 ~ 5240MHz / CH Low      **Test Date:** March 14, 2013

**Temperature:** 25°C      **Tested by:** Shawn Wu

**Humidity:** 50% RH      **Polarity:** Ver. / Hor.

Frequency (MHz)	Reading (dBuV)	Correction (dB/m)	Result (dBuV/m)	Limit (dBuV/m)	Margin (dB)	Remark	Ant.Pol. (H/V)
2925.000	62.49	-13.34	49.15	68.30	-19.15	peak	V
N/A							
2878.333	62.86	-13.44	49.42	74.00	-24.58	peak	H
N/A							

**Remark:**

1. Measuring frequencies from 1 GHz to the 10th harmonic of highest fundamental frequency.
2. Radiated emissions measured in frequency above 1000MHz were made with an instrument using peak/average detector mode.
3. Average test would be performed if the peak result were greater than the average limit.
4. Data of measurement within this frequency range shown “ --- ” in the table above means the reading of emissions are attenuated more than 20dB below the permissible limits or the field strength is too small to be measured.
5. Measurements above show only up to 6 maximum emissions noted, or would be lesser, with “ N/A ” remark, if no specific emissions from the EUT are recorded (ie: margin>20dB from the applicable limit) and considered that's already beyond the background noise floor.
6. Margin (dB) = Remark result (dBuV/m) – Average limit (dBuV/m).



**Operation Mode:** Tx / IEEE 802.11a mode / 5180 ~ 5240MHz / CH Mid      **Test Date:** March 14, 2013  
**Temperature:** 25°C      **Tested by:** Shawn Wu  
**Humidity:** 50% RH      **Polarity:** Ver. / Hor.

Frequency (MHz)	Reading (dBuV)	Correction (dB/m)	Result (dBuV/m)	Limit (dBuV/m)	Margin (dB)	Remark	Ant.Pol. (H/V)
2960.000	63.70	-13.26	50.44	68.30	-17.86	peak	V
N/A							
3018.333	62.82	-13.15	49.67	68.30	-18.63	peak	H
N/A							

**Remark:**

1. Measuring frequencies from 1 GHz to the 10th harmonic of highest fundamental frequency.
2. Radiated emissions measured in frequency above 1000MHz were made with an instrument using peak/average detector mode.
3. Average test would be performed if the peak result were greater than the average limit.
4. Data of measurement within this frequency range shown “ --- ” in the table above means the reading of emissions are attenuated more than 20dB below the permissible limits or the field strength is too small to be measured.
5. Measurements above show only up to 6 maximum emissions noted, or would be lesser, with “ N/A ” remark, if no specific emissions from the EUT are recorded (ie: margin>20dB from the applicable limit) and considered that's already beyond the background noise floor.
6. Margin (dB) = Remark result (dBuV/m) – Average limit (dBuV/m).





Operation Mode: Tx / IEEE 802.11a mode / 5180 ~ 5240MHz / CH High

Test Date: March 14, 2013

Temperature: 25°C

Tested by: Shawn Wu

Humidity: 50% RH

Polarity: Ver. / Hor.

Frequency (MHz)	Reading (dBuV)	Correction (dB/m)	Result (dBuV/m)	Limit (dBuV/m)	Margin (dB)	Remark	Ant.Pol. (H/V)
1735.000	66.37	-17.80	48.57	68.30	-19.73	peak	V
N/A							
2796.667	63.47	-13.61	49.86	74.00	-24.14	peak	H
N/A							

Remark:

1. Measuring frequencies from 1 GHz to the 10th harmonic of highest fundamental frequency.
2. Radiated emissions measured in frequency above 1000MHz were made with an instrument using peak/average detector mode.
3. Average test would be performed if the peak result were greater than the average limit.
4. Data of measurement within this frequency range shown “ --- ” in the table above means the reading of emissions are attenuated more than 20dB below the permissible limits or the field strength is too small to be measured.
5. Measurements above show only up to 6 maximum emissions noted, or would be lesser, with “ N/A ” remark, if no specific emissions from the EUT are recorded (ie: margin>20dB from the applicable limit) and considered that's already beyond the background noise floor.
6. Margin (dB) = Remark result (dBuV/m) – Average limit (dBuV/m).



Operation Mode: Tx / IEEE 802.11n HT 20 MHz Channel mode / 5180 ~ 5240MHz / CH Low

Test Date: March 16, 2013

Temperature: 23°C

Tested by: Shawn Wu

Humidity: 53% RH

Polarity: Ver. / Hor.

Frequency (MHz)	Reading (dBuV)	Correction (dB/m)	Result (dBuV/m)	Limit (dBuV/m)	Margin (dB)	Remark	Ant.Pol. (H/V)
2423.333	64.02	-14.41	49.61	68.30	-18.69	peak	V
N/A							
3030.000	63.29	-13.13	50.16	68.30	-18.14	peak	H
N/A							

Remark:

1. Measuring frequencies from 1 GHz to the 10th harmonic of highest fundamental frequency.
2. Radiated emissions measured in frequency above 1000MHz were made with an instrument using peak/average detector mode.
3. Average test would be performed if the peak result were greater than the average limit.
4. Data of measurement within this frequency range shown " --- " in the table above means the reading of emissions are attenuated more than 20dB below the permissible limits or the field strength is too small to be measured.
5. Measurements above show only up to 6 maximum emissions noted, or would be lesser, with " N/A " remark, if no specific emissions from the EUT are recorded (ie: margin>20dB from the applicable limit) and considered that's already beyond the background noise floor.
6. Margin (dB) = Remark result (dBuV/m) – Average limit (dBuV/m).



Operation Mode: Tx / IEEE 802.11n HT 20 MHz Channel mode / 5180 ~ 5240MHz / CH Mid

Test Date: March 16, 2013

Temperature: 23°C

Tested by: Shawn Wu

Humidity: 53% RH

Polarity: Ver. / Hor.

Frequency (MHz)	Reading (dBuV)	Correction (dB/m)	Result (dBuV/m)	Limit (dBuV/m)	Margin (dB)	Remark	Ant.Pol. (H/V)
2680.000	63.75	-13.85	49.90	74.00	-24.10	peak	V
N/A							
3065.000	63.03	-13.08	49.95	68.30	-18.35	peak	H
N/A							

Remark:

1. Measuring frequencies from 1 GHz to the 10th harmonic of highest fundamental frequency.
2. Radiated emissions measured in frequency above 1000MHz were made with an instrument using peak/average detector mode.
3. Average test would be performed if the peak result were greater than the average limit.
4. Data of measurement within this frequency range shown " --- " in the table above means the reading of emissions are attenuated more than 20dB below the permissible limits or the field strength is too small to be measured.
5. Measurements above show only up to 6 maximum emissions noted, or would be lesser, with " N/A " remark, if no specific emissions from the EUT are recorded (ie: margin>20dB from the applicable limit) and considered that's already beyond the background noise floor.
6. Margin (dB) = Remark result (dBuV/m) – Average limit (dBuV/m).



**Operation Mode:** Tx / IEEE 802.11n HT 20 MHz Channel mode / 5180 ~ 5240MHz / CH High **Test Date:** March 16, 2013

**Temperature:** 23°C **Tested by:** Shawn Wu

**Humidity:** 53% RH **Polarity:** Ver. / Hor.

Frequency (MHz)	Reading (dBuV)	Correction (dB/m)	Result (dBuV/m)	Limit (dBuV/m)	Margin (dB)	Remark	Ant.Pol. (H/V)
2761.667	63.90	-13.68	50.22	74.00	-23.78	peak	V
N/A							
2820.000	63.20	-13.56	49.64	74.00	-24.36	peak	H
N/A							

**Remark:**

1. Measuring frequencies from 1 GHz to the 10th harmonic of highest fundamental frequency.
2. Radiated emissions measured in frequency above 1000MHz were made with an instrument using peak/average detector mode.
3. Average test would be performed if the peak result were greater than the average limit.
4. Data of measurement within this frequency range shown " --- " in the table above means the reading of emissions are attenuated more than 20dB below the permissible limits or the field strength is too small to be measured.
5. Measurements above show only up to 6 maximum emissions noted, or would be lesser, with " N/A " remark, if no specific emissions from the EUT are recorded (ie: margin>20dB from the applicable limit) and considered that's already beyond the background noise floor.
6. Margin (dB) = Remark result (dBuV/m) – Average limit (dBuV/m).



**Operation Mode:** Tx / IEEE 802.11n HT 40 MHz mode / 5190 ~ 5230MHz / CH Low      **Test Date:** March 16, 2013

**Temperature:** 23°C      **Tested by:** Shawn Wu

**Humidity:** 53% RH      **Polarity:** Ver. / Hor.

Frequency (MHz)	Reading (dBuV)	Correction (dB/m)	Result (dBuV/m)	Limit (dBuV/m)	Margin (dB)	Remark	Ant.Pol. (H/V)
3065.000	62.86	-13.08	49.78	68.30	-18.52	peak	V
N/A							
2878.333	62.97	-13.44	49.53	74.00	-24.47	peak	H
N/A							

**Remark:**

1. Measuring frequencies from 1 GHz to the 10th harmonic of highest fundamental frequency.
2. Radiated emissions measured in frequency above 1000MHz were made with an instrument using peak/average detector mode.
3. Average test would be performed if the peak result were greater than the average limit.
4. Data of measurement within this frequency range shown “ --- ” in the table above means the reading of emissions are attenuated more than 20dB below the permissible limits or the field strength is too small to be measured.
5. Measurements above show only up to 6 maximum emissions noted, or would be lesser, with “ N/A ” remark, if no specific emissions from the EUT are recorded (ie: margin>20dB from the applicable limit) and considered that's already beyond the background noise floor.
6. Margin (dB) = Remark result (dBuV/m) – Average limit (dBuV/m).



**Operation Mode:** Tx / IEEE 802.11n HT 40 MHz mode / 5190 ~ 5230MHz / CH High      **Test Date:** March 16, 2013  
**Temperature:** 23°C      **Tested by:** Shawn Wu  
**Humidity:** 53% RH      **Polarity:** Ver. / Hor.

Frequency (MHz)	Reading (dBuV)	Correction (dB/m)	Result (dBuV/m)	Limit (dBuV/m)	Margin (dB)	Remark	Ant.Pol. (H/V)
2761.667	63.09	-13.68	49.41	74.00	-24.59	peak	V
N/A							
2691.667	63.05	-13.83	49.22	74.00	-24.78	peak	H
N/A							

**Remark:**

1. Measuring frequencies from 1 GHz to the 10th harmonic of highest fundamental frequency.
2. Radiated emissions measured in frequency above 1000MHz were made with an instrument using peak/average detector mode.
3. Average test would be performed if the peak result were greater than the average limit.
4. Data of measurement within this frequency range shown “ --- ” in the table above means the reading of emissions are attenuated more than 20dB below the permissible limits or the field strength is too small to be measured.
5. Measurements above show only up to 6 maximum emissions noted, or would be lesser, with “ N/A ” remark, if no specific emissions from the EUT are recorded (ie: margin>20dB from the applicable limit) and considered that's already beyond the background noise floor.
6. Margin (dB) = Remark result (dBuV/m) – Average limit (dBuV/m).



**Operation Mode:** Tx / IEEE 802.11a mode / 5260 ~ 5320MHz / CH Low      **Test Date:** March 14, 2013  
**Temperature:** 25°C      **Tested by:** Shawn Wu  
**Humidity:** 50% RH      **Polarity:** Ver. / Hor.

Frequency (MHz)	Reading (dBuV)	Correction (dB/m)	Result (dBuV/m)	Limit (dBuV/m)	Margin (dB)	Remark	Ant.Pol. (H/V)
1735.000	67.34	-17.80	49.54	68.30	-18.76	peak	V
N/A							
2668.333	63.09	-13.88	49.21	74.00	-24.79	peak	H
N/A							

**Remark:**

1. Measuring frequencies from 1 GHz to the 10th harmonic of highest fundamental frequency.
2. Radiated emissions measured in frequency above 1000MHz were made with an instrument using peak/average detector mode.
3. Average test would be performed if the peak result were greater than the average limit.
4. Data of measurement within this frequency range shown “ --- ” in the table above means the reading of emissions are attenuated more than 20dB below the permissible limits or the field strength is too small to be measured.
5. Measurements above show only up to 6 maximum emissions noted, or would be lesser, with “ N/A ” remark, if no specific emissions from the EUT are recorded (ie: margin>20dB from the applicable limit) and considered that's already beyond the background noise floor.
6. Margin (dB) = Remark result (dBuV/m) – Average limit (dBuV/m).



**Operation Mode:** Tx / IEEE 802.11a mode / 5260 ~ 5320MHz / CH Mid      **Test Date:** March 14, 2013  
**Temperature:** 25°C      **Tested by:** Shawn Wu  
**Humidity:** 50% RH      **Polarity:** Ver. / Hor.

Frequency (MHz)	Reading (dBuV)	Correction (dB/m)	Result (dBuV/m)	Limit (dBuV/m)	Margin (dB)	Remark	Ant.Pol. (H/V)
2551.667	63.99	-14.12	49.87	68.30	-18.43	peak	V
N/A							
2796.667	62.79	-13.61	49.18	74.00	-24.82	peak	H
N/A							

**Remark:**

1. Measuring frequencies from 1 GHz to the 10th harmonic of highest fundamental frequency.
2. Radiated emissions measured in frequency above 1000MHz were made with an instrument using peak/average detector mode.
3. Average test would be performed if the peak result were greater than the average limit.
4. Data of measurement within this frequency range shown “ --- ” in the table above means the reading of emissions are attenuated more than 20dB below the permissible limits or the field strength is too small to be measured.
5. Measurements above show only up to 6 maximum emissions noted, or would be lesser, with “ N/A ” remark, if no specific emissions from the EUT are recorded (ie: margin>20dB from the applicable limit) and considered that's already beyond the background noise floor.
6. Margin (dB) = Remark result (dBuV/m) – Average limit (dBuV/m).





**Operation Mode:** Tx / IEEE 802.11a mode / 5260 ~ 5320MHz / CH High      **Test Date:** March 14, 2013  
**Temperature:** 25°C      **Tested by:** Shawn Wu  
**Humidity:** 50% RH      **Polarity:** Ver. / Hor.

Frequency (MHz)	Reading (dBuV)	Correction (dB/m)	Result (dBuV/m)	Limit (dBuV/m)	Margin (dB)	Remark	Ant.Pol. (H/V)
2785.000	62.62	-13.63	48.99	74.00	-25.01	peak	V
N/A							
3170.000	63.32	-12.91	50.41	68.30	-17.89	peak	H
N/A							

**Remark:**

1. Measuring frequencies from 1 GHz to the 10th harmonic of highest fundamental frequency.
2. Radiated emissions measured in frequency above 1000MHz were made with an instrument using peak/average detector mode.
3. Average test would be performed if the peak result were greater than the average limit.
4. Data of measurement within this frequency range shown “ --- ” in the table above means the reading of emissions are attenuated more than 20dB below the permissible limits or the field strength is too small to be measured.
5. Measurements above show only up to 6 maximum emissions noted, or would be lesser, with “ N/A ” remark, if no specific emissions from the EUT are recorded (ie: margin>20dB from the applicable limit) and considered that's already beyond the background noise floor.
6. Margin (dB) = Remark result (dBuV/m) – Average limit (dBuV/m).



Operation Mode: Tx / IEEE 802.11n HT 20 MHz Channel mode / 5260 ~ 5320MHz / CH Low

Test Date: March 16, 2013

Temperature: 23°C

Tested by: Shawn Wu

Humidity: 53% RH

Polarity: Ver. / Hor.

Frequency (MHz)	Reading (dBuV)	Correction (dB/m)	Result (dBuV/m)	Limit (dBuV/m)	Margin (dB)	Remark	Ant.Pol. (H/V)
2761.667	63.34	-13.68	49.66	74.00	-24.34	peak	V
N/A							
2890.000	63.10	-13.41	49.69	74.00	-24.31	peak	H
N/A							

**Remark:**

1. Measuring frequencies from 1 GHz to the 10th harmonic of highest fundamental frequency.
2. Radiated emissions measured in frequency above 1000MHz were made with an instrument using peak/average detector mode.
3. Average test would be performed if the peak result were greater than the average limit.
4. Data of measurement within this frequency range shown “ --- ” in the table above means the reading of emissions are attenuated more than 20dB below the permissible limits or the field strength is too small to be measured.
5. Measurements above show only up to 6 maximum emissions noted, or would be lesser, with “ N/A ” remark, if no specific emissions from the EUT are recorded (ie: margin>20dB from the applicable limit) and considered that's already beyond the background noise floor.
6. Margin (dB) = Remark result (dBuV/m) – Average limit (dBuV/m).



Operation Mode: Tx / IEEE 802.11n HT 20 MHz Channel mode / 5260 ~ 5320MHz / CH Mid

Test Date: March 16, 2013

Temperature: 23°C

Tested by: Shawn Wu

Humidity: 53% RH

Polarity: Ver. / Hor.

Frequency (MHz)	Reading (dBuV)	Correction (dB/m)	Result (dBuV/m)	Limit (dBuV/m)	Margin (dB)	Remark	Ant.Pol. (H/V)
2493.333	64.75	-14.25	50.50	74.00	-23.50	peak	V
N/A							
2750.000	63.41	-13.71	49.70	74.00	-24.30	peak	H
N/A							

Remark:

1. Measuring frequencies from 1 GHz to the 10th harmonic of highest fundamental frequency.
2. Radiated emissions measured in frequency above 1000MHz were made with an instrument using peak/average detector mode.
3. Average test would be performed if the peak result were greater than the average limit.
4. Data of measurement within this frequency range shown " --- " in the table above means the reading of emissions are attenuated more than 20dB below the permissible limits or the field strength is too small to be measured.
5. Measurements above show only up to 6 maximum emissions noted, or would be lesser, with " N/A " remark, if no specific emissions from the EUT are recorded (ie: margin>20dB from the applicable limit) and considered that's already beyond the background noise floor.
6. Margin (dB) = Remark result (dBuV/m) – Average limit (dBuV/m).



**Operation Mode:** Tx / IEEE 802.11n HT 20 MHz Channel mode / 5260 ~ 5320MHz / CH High **Test Date:** March 16, 2013

**Temperature:** 23°C **Tested by:** Shawn Wu

**Humidity:** 53% RH **Polarity:** Ver. / Hor.

Frequency (MHz)	Reading (dBuV)	Correction (dB/m)	Result (dBuV/m)	Limit (dBuV/m)	Margin (dB)	Remark	Ant.Pol. (H/V)
2995.000	62.45	-13.19	49.26	68.30	-19.04	peak	V
N/A							
2411.667	64.15	-14.43	49.72	68.30	-18.58	peak	H
N/A							

**Remark:**

1. Measuring frequencies from 1 GHz to the 10th harmonic of highest fundamental frequency.
2. Radiated emissions measured in frequency above 1000MHz were made with an instrument using peak/average detector mode.
3. Average test would be performed if the peak result were greater than the average limit.
4. Data of measurement within this frequency range shown “ --- ” in the table above means the reading of emissions are attenuated more than 20dB below the permissible limits or the field strength is too small to be measured.
5. Measurements above show only up to 6 maximum emissions noted, or would be lesser, with “ N/A ” remark, if no specific emissions from the EUT are recorded (ie: margin>20dB from the applicable limit) and considered that's already beyond the background noise floor.
6. Margin (dB) = Remark result (dBuV/m) – Average limit (dBuV/m).



**Operation Mode:** Tx / IEEE 802.11n HT 40 MHz mode / 5270 ~ 5310MHz / CH Low      **Test Date:** March 16, 2013  
**Temperature:** 23°C      **Tested by:** Shawn Wu  
**Humidity:** 53% RH      **Polarity:** Ver. / Hor.

Frequency (MHz)	Reading (dBuV)	Correction (dB/m)	Result (dBuV/m)	Limit (dBuV/m)	Margin (dB)	Remark	Ant.Pol. (H/V)
2388.333	64.43	-14.50	49.93	74.00	-24.07	peak	V
N/A							
							V
3216.667	63.42	-12.83	50.59	68.30	-17.71	peak	H
N/A							

**Remark:**

1. Measuring frequencies from 1 GHz to the 10th harmonic of highest fundamental frequency.
2. Radiated emissions measured in frequency above 1000MHz were made with an instrument using peak/average detector mode.
3. Average test would be performed if the peak result were greater than the average limit.
4. Data of measurement within this frequency range shown “ --- ” in the table above means the reading of emissions are attenuated more than 20dB below the permissible limits or the field strength is too small to be measured.
5. Measurements above show only up to 6 maximum emissions noted, or would be lesser, with “ N/A ” remark, if no specific emissions from the EUT are recorded (ie: margin>20dB from the applicable limit) and considered that's already beyond the background noise floor.
6. Margin (dB) = Remark result (dBuV/m) – Average limit (dBuV/m).



**Operation Mode:** Tx / IEEE 802.11n HT 40 MHz mode / 5270 ~ 5310MHz / CH High      **Test Date:** March 16, 2013  
**Temperature:** 23°C      **Tested by:** Shawn Wu  
**Humidity:** 53% RH      **Polarity:** Ver. / Hor.

Frequency (MHz)	Reading (dBuV)	Correction (dB/m)	Result (dBuV/m)	Limit (dBuV/m)	Margin (dB)	Remark	Ant.Pol. (H/V)
3088.333	62.82	-13.04	49.78	68.30	-18.52	peak	V
N/A							
2808.333	63.39	-13.58	49.81	74.00	-24.19	peak	H
N/A							

**Remark:**

1. Measuring frequencies from 1 GHz to the 10th harmonic of highest fundamental frequency.
2. Radiated emissions measured in frequency above 1000MHz were made with an instrument using peak/average detector mode.
3. Average test would be performed if the peak result were greater than the average limit.
4. Data of measurement within this frequency range shown “ --- ” in the table above means the reading of emissions are attenuated more than 20dB below the permissible limits or the field strength is too small to be measured.
5. Measurements above show only up to 6 maximum emissions noted, or would be lesser, with “ N/A ” remark, if no specific emissions from the EUT are recorded (ie: margin>20dB from the applicable limit) and considered that's already beyond the background noise floor.
6. Margin (dB) = Remark result (dBuV/m) – Average limit (dBuV/m).



**Operation Mode:** Tx / IEEE 802.11a mode / 5500 ~ 5700MHz / CH Low      **Test Date:** March 14, 2013  
**Temperature:** 25°C      **Tested by:** Shawn Wu  
**Humidity:** 50% RH      **Polarity:** Ver. / Hor.

Frequency (MHz)	Reading (dBuV)	Correction (dB/m)	Result (dBuV/m)	Limit (dBuV/m)	Margin (dB)	Remark	Ant.Pol. (H/V)
2843.333	63.11	-13.51	49.60	74.00	-24.40	peak	V
N/A							
2855.000	62.89	-13.48	49.41	74.00	-24.59	peak	H
N/A							

**Remark:**

1. Measuring frequencies from 1 GHz to the 10th harmonic of highest fundamental frequency.
2. Radiated emissions measured in frequency above 1000MHz were made with an instrument using peak/average detector mode.
3. Average test would be performed if the peak result were greater than the average limit or as required by the applicant.
4. Data of measurement within this frequency range shown “ --- ” in the table above means the reading of emissions are attenuated more than 20dB below the permissible limits or the field strength is too small to be measured.
5. Measurements above show only up to 6 maximum emissions noted, or would be lesser, with “ N/A ” remark, if no specific emissions from the EUT are recorded (ie: margin>20dB from the applicable limit) and considered that's already beyond the background noise floor.
6. Margin (dB) = Remark result (dBuV/m) – Average limit (dBuV/m).



**Operation Mode:** Tx / IEEE 802.11a mode / 5500 ~ 5700MHz /CH Mid      **Test Date:** March 14, 2013  
**Temperature:** 25°C      **Tested by:** Shawn Wu  
**Humidity:** 50% RH      **Polarity:** Ver. / Hor.

Frequency (MHz)	Reading (dBuV)	Correction (dB/m)	Result (dBuV/m)	Limit (dBuV/m)	Margin (dB)	Remark	Ant.Pol. (H/V)
3076.667	63.30	-13.06	50.24	68.30	-18.06	peak	V
N/A							
							V
2913.333	63.02	-13.36	49.66	68.30	-18.64	peak	H
N/A							

**Remark:**

1. Measuring frequencies from 1 GHz to the 10th harmonic of highest fundamental frequency.
2. Radiated emissions measured in frequency above 1000MHz were made with an instrument using peak/average detector mode.
3. Average test would be performed if the peak result were greater than the average limit or as required by the applicant.
4. Data of measurement within this frequency range shown “ --- ” in the table above means the reading of emissions are attenuated more than 20dB below the permissible limits or the field strength is too small to be measured.
5. Measurements above show only up to 6 maximum emissions noted, or would be lesser, with “ N/A ” remark, if no specific emissions from the EUT are recorded (ie: margin>20dB from the applicable limit) and considered that's already beyond the background noise floor.
6. Margin (dB) = Remark result (dBuV/m) – Average limit (dBuV/m).





**Operation Mode:** Tx / IEEE 802.11a mode / 5500 ~ 5700MHz / CH High      **Test Date:** March 14, 2013  
**Temperature:** 25°C      **Tested by:** Shawn Wu  
**Humidity:** 50% RH      **Polarity:** Ver. / Hor.

Frequency (MHz)	Reading (dBuV)	Correction (dB/m)	Result (dBuV/m)	Limit (dBuV/m)	Margin (dB)	Remark	Ant.Pol. (H/V)
2400.000	64.52	-14.46	50.06	68.30	-18.24	peak	V
N/A							
2866.667	62.88	-13.46	49.42	74.00	-24.58	peak	H
N/A							

**Remark:**

1. Measuring frequencies from 1 GHz to the 10th harmonic of highest fundamental frequency.
2. Radiated emissions measured in frequency above 1000MHz were made with an instrument using peak/average detector mode.
3. Average test would be performed if the peak result were greater than the average limit or as required by the applicant.
4. Data of measurement within this frequency range shown “ --- ” in the table above means the reading of emissions are attenuated more than 20dB below the permissible limits or the field strength is too small to be measured.
5. Measurements above show only up to 6 maximum emissions noted, or would be lesser, with “ N/A ” remark, if no specific emissions from the EUT are recorded (ie: margin>20dB from the applicable limit) and considered that's already beyond the background noise floor.
6. Margin (dB) = Remark result (dBuV/m) – Average limit (dBuV/m).



Operation Mode: Tx / IEEE 802.11n HT 20 MHz Channel mode / 5500 ~ 5700MHz / CH Low

Test Date: March 16, 2013

Temperature: 23°C

Tested by: Shawn Wu

Humidity: 53% RH

Polarity: Ver. / Hor.

Frequency (MHz)	Reading (dBuV)	Correction (dB/m)	Result (dBuV/m)	Limit (dBuV/m)	Margin (dB)	Remark	Ant.Pol. (H/V)
3088.333	62.26	-13.04	49.22	68.30	-19.08	peak	V
N/A							
3660.000	62.48	-11.78	50.70	74.00	-23.30	peak	H
N/A							

Remark:

1. Measuring frequencies from 1 GHz to the 10th harmonic of highest fundamental frequency.
2. Radiated emissions measured in frequency above 1000MHz were made with an instrument using peak/average detector mode.
3. Average test would be performed if the peak result were greater than the average limit or as required by the applicant.
4. Data of measurement within this frequency range shown “ --- ” in the table above means the reading of emissions are attenuated more than 20dB below the permissible limits or the field strength is too small to be measured.
5. Measurements above show only up to 6 maximum emissions noted, or would be lesser, with “ N/A ” remark, if no specific emissions from the EUT are recorded (ie: margin>20dB from the applicable limit) and considered that's already beyond the background noise floor.
6. Margin (dB) = Remark result (dBuV/m) – Average limit (dBuV/m).



Operation Mode: Tx / IEEE 802.11n HT 20 MHz Channel mode / 5500 ~ 5700MHz / CH Mid

Test Date: March 16, 2013

Temperature: 23°C

Tested by: Shawn Wu

Humidity: 53% RH

Polarity: Ver. / Hor.

Frequency (MHz)	Reading (dBuV)	Correction (dB/m)	Result (dBuV/m)	Limit (dBuV/m)	Margin (dB)	Remark	Ant.Pol. (H/V)
2890.000	63.15	-13.41	49.74	74.00	-24.26	peak	V
N/A							
2621.667	63.48	-13.97	49.51	68.30	-18.79	peak	H
N/A							

Remark:

1. Measuring frequencies from 1 GHz to the 10th harmonic of highest fundamental frequency.
2. Radiated emissions measured in frequency above 1000MHz were made with an instrument using peak/average detector mode.
3. Average test would be performed if the peak result were greater than the average limit or as required by the applicant.
4. Data of measurement within this frequency range shown “ --- ” in the table above means the reading of emissions are attenuated more than 20dB below the permissible limits or the field strength is too small to be measured.
5. Measurements above show only up to 6 maximum emissions noted, or would be lesser, with “ N/A ” remark, if no specific emissions from the EUT are recorded (ie: margin>20dB from the applicable limit) and considered that's already beyond the background noise floor.
6. Margin (dB) = Remark result (dBuV/m) – Average limit (dBuV/m).



Operation Mode: Tx / IEEE 802.11n HT 20 MHz Channel mode / 5500 ~ 5700MHz / CH High

Test Date: March 16, 2013

Temperature: 23°C

Tested by: Shawn Wu

Humidity: 53% RH

Polarity: Ver. / Hor.

Frequency (MHz)	Reading (dBuV)	Correction (dB/m)	Result (dBuV/m)	Limit (dBuV/m)	Margin (dB)	Remark	Ant.Pol. (H/V)
2598.333	63.55	-14.02	49.53	68.30	-18.77	peak	V
N/A							
3135.000	63.63	-12.96	50.67	68.30	-17.63	peak	H
N/A							

Remark:

1. Measuring frequencies from 1 GHz to the 10th harmonic of highest fundamental frequency.
2. Radiated emissions measured in frequency above 1000MHz were made with an instrument using peak/average detector mode.
3. Average test would be performed if the peak result were greater than the average limit or as required by the applicant.
4. Data of measurement within this frequency range shown “ --- ” in the table above means the reading of emissions are attenuated more than 20dB below the permissible limits or the field strength is too small to be measured.
5. Measurements above show only up to 6 maximum emissions noted, or would be lesser, with “ N/A ” remark, if no specific emissions from the EUT are recorded (ie: margin>20dB from the applicable limit) and considered that's already beyond the background noise floor.
6. Margin (dB) = Remark result (dBuV/m) – Average limit (dBuV/m).



**Operation Mode:** Tx / IEEE 802.11n HT 40 MHz mode / 5510 ~ 5670MHz / CH Low      **Test Date:** March 16, 2013  
**Temperature:** 23°C      **Tested by:** Shawn Wu  
**Humidity:** 53% RH      **Polarity:** Ver. / Hor.

Frequency (MHz)	Reading (dBuV)	Correction (dB/m)	Result (dBuV/m)	Limit (dBuV/m)	Margin (dB)	Remark	Ant.Pol. (H/V)
2505.000	63.63	-14.22	49.41	68.30	-18.89	peak	V
N/A							
2936.667	62.55	-13.31	49.24	68.30	-19.06	peak	H
N/A							

**Remark:**

1. Measuring frequencies from 1 GHz to the 10th harmonic of highest fundamental frequency.
2. Radiated emissions measured in frequency above 1000MHz were made with an instrument using peak/average detector mode.
3. Average test would be performed if the peak result were greater than the average limit or as required by the applicant.
4. Data of measurement within this frequency range shown “ --- ” in the table above means the reading of emissions are attenuated more than 20dB below the permissible limits or the field strength is too small to be measured.
5. Measurements above show only up to 6 maximum emissions noted, or would be lesser, with “ N/A ” remark, if no specific emissions from the EUT are recorded (ie: margin>20dB from the applicable limit) and considered that's already beyond the background noise floor.
6. Margin (dB) = Remark result (dBuV/m) – Average limit (dBuV/m).



**Operation Mode:** Tx / IEEE 802.11n HT 40 MHz mode / 5510 ~ 5670MHz / CH Mid      **Test Date:** March 16, 2013  
**Temperature:** 23°C      **Tested by:** Shawn Wu  
**Humidity:** 53% RH      **Polarity:** Ver. / Hor.

Frequency (MHz)	Reading (dBuV)	Correction (dB/m)	Result (dBuV/m)	Limit (dBuV/m)	Margin (dB)	Remark	Ant.Pol. (H/V)
2645.000	63.21	-13.93	49.28	68.30	-19.02	peak	V
N/A							
3205.000	63.44	-12.85	50.59	68.30	-17.71	peak	H
N/A							

**Remark:**

1. Measuring frequencies from 1 GHz to the 10th harmonic of highest fundamental frequency.
2. Radiated emissions measured in frequency above 1000MHz were made with an instrument using peak/average detector mode.
3. Average test would be performed if the peak result were greater than the average limit or as required by the applicant.
4. Data of measurement within this frequency range shown “ --- ” in the table above means the reading of emissions are attenuated more than 20dB below the permissible limits or the field strength is too small to be measured.
5. Measurements above show only up to 6 maximum emissions noted, or would be lesser, with “ N/A ” remark, if no specific emissions from the EUT are recorded (ie: margin>20dB from the applicable limit) and considered that's already beyond the background noise floor.
6. Margin (dB) = Remark result (dBuV/m) – Average limit (dBuV/m).



**Operation Mode:** Tx / IEEE 802.11n HT 40 MHz mode / 5510 ~ 5670MHz / CH High      **Test Date:** March 16, 2013  
**Temperature:** 23°C      **Tested by:** Shawn Wu  
**Humidity:** 53% RH      **Polarity:** Ver. / Hor.

Frequency (MHz)	Reading (dBuV)	Correction (dB/m)	Result (dBuV/m)	Limit (dBuV/m)	Margin (dB)	Remark	Ant.Pol. (H/V)
3216.667	64.52	-12.83	51.69	68.30	-16.61	peak	V
N/A							
3275.000	62.95	-12.74	50.21	68.30	-18.09	peak	H
N/A							

**Remark:**

1. Measuring frequencies from 1 GHz to the 10th harmonic of highest fundamental frequency.
2. Radiated emissions measured in frequency above 1000MHz were made with an instrument using peak/average detector mode.
3. Average test would be performed if the peak result were greater than the average limit or as required by the applicant.
4. Data of measurement within this frequency range shown “ --- ” in the table above means the reading of emissions are attenuated more than 20dB below the permissible limits or the field strength is too small to be measured.
5. Measurements above show only up to 6 maximum emissions noted, or would be lesser, with “ N/A ” remark, if no specific emissions from the EUT are recorded (ie: margin>20dB from the applicable limit) and considered that's already beyond the background noise floor.
6. Margin (dB) = Remark result (dBuV/m) – Average limit (dBuV/m).