



FCC SAR Test Report

APPLICANT : Broadcom Corporation
EQUIPMENT : 802.11a/b/g/n WLAN + BLUETOOTH PCI-E MINI CARD
BRAND NAME : Broadcom
MODEL NAME : BCM943228HMB
FCC ID : QDS-BRCM1058
STANDARD : FCC 47 CFR Part 2 (2.1093)
ANSI/IEEE C95.1-1992
IEEE 1528-2003
FCC OET Bulletin 65 Supplement C (Edition 01-01)

The product was installed into Notebook Computer (Brand Name: Acer, Model Name: Q1VZC) during test.

The product was completely tested on Oct. 17, 2012. We, SPORTON INTERNATIONAL INC., would like to declare that the tested sample has been evaluated in accordance with the procedures and shown the compliance with the applicable technical standards.

The test results in this report apply exclusively to the tested model / sample. Without written approval of SPORTON INTERNATIONAL INC., the test report shall not be reproduced except in full.

Reviewed by:

Jones Tsai / Manager



SPORTON INTERNATIONAL INC.

No. 52, Hwa Ya 1st Rd., Hwa Ya Technology Park, Kwei-Shan Hsiang, Tao Yuan Hsien, Taiwan, R.O.C.

SPORTON INTERNATIONAL INC.

TEL : 886-3-327-3456

FAX : 886-3-328-4978

FCC ID : QDS-BRCM1058

Page Number : 1 of 32

Report Issued Date : Nov. 23, 2012

Report Version : Rev. 03



Table of Contents

1. Statement of Compliance 4
2. Administration Data 5
2.1 Testing Laboratory..... 5
2.2 Applicant 5
2.3 Manufacturer..... 5
2.4 Application Details..... 5
3. General Information 6
3.1 Description of Equipment Under Test (EUT) 6
3.2 Product Photos..... 7
3.3 Applied Standards..... 7
3.4 Device Category and SAR Limits 7
3.5 Test Conditions..... 7
4. Specific Absorption Rate (SAR)..... 8
4.1 Introduction 8
4.2 SAR Definition..... 8
5. SAR Measurement System 9
5.1 E-Field Probe 10
5.2 Data Acquisition Electronics (DAE) 11
5.3 Robot 11
5.4 Measurement Server..... 11
5.5 Phantom..... 12
5.6 Device Holder..... 13
5.7 Data Storage and Evaluation 14
5.8 Test Equipment List..... 16
6. Tissue Simulating Liquids 17
7. SAR Measurement Evaluation 19
7.1 Purpose of System Performance check 19
7.2 System Setup..... 19
7.3 Validation Results..... 20
8. EUT Testing Position 21
9. Measurement Procedures 22
9.1 Spatial Peak SAR Evaluation 22
9.2 Area & Zoom Scan Procedures..... 22
9.3 Volume Scan Procedures..... 23
9.4 SAR Averaged Methods 23
9.5 Power Drift Monitoring..... 23
10. SAR Test Configurations..... 24
10.1 Exposure Positions Consideration 24
10.2 Conducted RF Output Power (Unit: dBm) 25
11. SAR Test Results 28
11.1 Test Records for Body SAR Test 28
11.2 Simultaneous Transmission SAR Analysis and Measurements..... 28
12. Uncertainty Assessment 29
13. References..... 32

- Appendix A. Plots of System Performance Check
Appendix B. Plots of SAR Measurement
Appendix C. DASY Calibration Certificate
Appendix D. Product Photos
Appendix E. Test Setup Photos



Revision History

REPORT NO.	VERSION	DESCRIPTION	ISSUED DATE
FA241902	Rev. 01	Initial issue of report	Oct. 22, 2012
FA241902	Rev. 02	Update report for revising antenna location in Section 10.1 and appendix D	Nov. 08, 2012
FA241902	Rev. 03	Revise Page.4 in Section 1 and Page 28 in Section11.1	Nov. 23, 2012



1. Statement of Compliance

The maximum results of Specific Absorption Rate (SAR) found during testing for **Broadcom Corporation, 802.11a/b/g/n WLAN + BLUETOOTH PCI-E MINI CARD, Broadcom, BCM943228HMB** are as follows.

Band	Position	SAR _{1g} (W/kg)	Scaled SAR _{1g} (W/kg)
WLAN 2.4G	Body (0 cm Gap)	0.09	0.093
WLAN 5G	Body (0 cm Gap)	0.048	0.050

This device is in compliance with Specific Absorption Rate (SAR) for general population/uncontrolled exposure limits (1.6 W/kg) specified in FCC 47 CFR part 2 (2.1093) and ANSI/IEEE C95.1-1992, and had been tested in accordance with the measurement methods and procedures specified in IEEE 1528-2003 and FCC OET Bulletin 65 Supplement C (Edition 01-01).



2. Administration Data

2.1 Testing Laboratory

Test Site	SPORTON INTERNATIONAL INC.
Test Site Location	No. 52, Hwa Ya 1 st Rd., Hwa Ya Technology Park, Kwei-Shan Hsiang, Tao Yuan Hsien, Taiwan, R.O.C. TEL: +886-3-327-3456 FAX: +886-3-328-4978

2.2 Applicant

Company Name	Broadcom Corporation
Address	190 Mathilda Place, Sunnyvale, CA 94086, U.S.A.

2.3 Manufacturer

Company Name	<ol style="list-style-type: none">1. Compal Electronics, Inc.2. Compal Electronics Technology (Kunshan) Co., Ltd.3. Compal Information (Kunshan) Co., Ltd.4. Compal Information Technology (Kunshan) Co., Ltd.5. Compalead Eletrônica Do Brasil Indústria E Comércio Ltda6. Compal (Vietnam) Co., Ltd.
Address	<ol style="list-style-type: none">1. No.581, Ruiguang Rd., Neihu District, Taipei City 11492, Taiwan2. No.25, Third Avenue, A Zone, Kunshan Comprehensive Free Trade Zone, Kunshan, Jiangsu, China3. No.15, Third Avenue, A Zone, Kunshan Comprehensive Free Trade Zone, Kunshan, Jiangsu, China4. No.58, First Avenue, A Zone, Kunshan Comprehensive Free Trade Zone, Kunshan, Jiangsu, China5. Rua Kanebo 175, Galpões C1, C2, C3, C4, C5 C6 E C12, Bairro Distrito Industrial Jundiaí Business Park, Cep 13213-090, Jundiaí - São Paulo, Brasil6. Ba Thien Industrial Zone, Ba Hien Commune, Binh Xuyen County, Vinh Phuc Province, Vietnam

2.4 Application Details

Date of Start during the Test	May 10, 2012
Date of End during the Test	Oct. 17, 2012

3. General Information

3.1 Description of Equipment Under Test (EUT)

Product Feature & Specification	
EUT	802.11a/b/g/n WLAN + BLUETOOTH PCI-E MINI CARD
Brand Name	Broadcom
Model Name	BCM943228HMB
FCC ID	QDS-BRCM1058
Tx Frequency	WLAN2.4G: 2412 MHz ~ 2462 MHz WLAN5G: 5180 MHz ~ 5240 MHz; 5260 MHz ~ 5320 MHz; 5500 MHz ~ 5700 MHz; 5745 MHz ~ 5825 MHz Bluetooth: 2402 MHz ~ 2480 MHz
Maximum Average Output Power to Antenna	802.11b: 17.53 dBm 802.11g: 19.03 dBm 802.11n-HT20 (2.4GHz): 17.94 dBm 802.11n-HT40 (2.4GHz): 14.14 dBm 802.11a: 17.58 dBm 802.11n-HT20 (5GHz): 19.66 dBm 802.11n-HT40 (5GHz): 19.61 dBm Bluetooth: 3.98 dBm
Antenna Type	WLAN: PIFA Antenna Bluetooth: PIFA Antenna
HW Version	M/B : LA 8941P
SW Version	BIOS : Acer V0.08
Uplink Modulations	802.11b: DSSS (BPSK / QPSK / CCK) 802.11a/g/n: OFDM (BPSK / QPSK / 16QAM / 64QAM) Bluetooth : GFSK Bluetooth EDR : $\pi/4$ -DQPSK, 8-DPSK Bluetooth v4.0+LE: GFSK
EUT Stage	Identical Prototype
Remark:	
1. The above EUT's information was declared by manufacturer. Please refer to the specifications or user's manual for more detailed description.	
2. 5600 MHz ~ 5650 MHz is notched.	



3.2 Product Photos

Please refer to Appendix D.

3.3 Applied Standards

The Specific Absorption Rate (SAR) testing specification, method, and procedure for this device is in accordance with the following standards:

- FCC 47 CFR Part 2 (2.1093)
- ANSI/IEEE C95.1-1992
- IEEE 1528-2003
- FCC OET Bulletin 65 Supplement C (Edition 01-01)
- FCC KDB 447498 D01 v04
- FCC KDB 616217 D01 v01r01
- FCC KDB 616217 D03 v01
- FCC KDB 248227 D01 v01r02

3.4 Device Category and SAR Limits

This device belongs to portable device category because its radiating structure is allowed to be used within 20 centimeters of the body of the user. Limit for General Population/Uncontrolled exposure should be applied for this device, it is 1.6 W/kg as averaged over any 1 gram of tissue.

3.5 Test Conditions

3.5.1 Ambient Condition

Ambient Temperature	20 to 24 °C
Humidity	< 60 %

3.5.2 Test Configuration

For WLAN SAR testing, WLAN engineering testing software installed on the EUT can provide continuous transmitting RF signal.

4. Specific Absorption Rate (SAR)

4.1 Introduction

SAR is related to the rate at which energy is absorbed per unit mass in an object exposed to a radio field. The SAR distribution in a biological body is complicated and is usually carried out by experimental techniques or numerical modeling. The standard recommends limits for two tiers of groups, occupational/controlled and general population/uncontrolled, based on a person's awareness and ability to exercise control over his or her exposure. In general, occupational/controlled exposure limits are higher than the limits for general population/uncontrolled.

4.2 SAR Definition

The SAR definition is the time derivative (rate) of the incremental energy (dW) absorbed by (dissipated in) an incremental mass (dm) contained in a volume element (dv) of a given density (ρ). The equation description is as below:

$$\text{SAR} = \frac{d}{dt} \left(\frac{dW}{dm} \right) = \frac{d}{dt} \left(\frac{dW}{\rho dv} \right)$$

SAR is expressed in units of Watts per kilogram (W/kg)

SAR measurement can be either related to the temperature elevation in tissue by

$$\text{SAR} = C \left(\frac{\delta T}{\delta t} \right)$$

Where: C is the specific heat capacity, δT is the temperature rise and δt is the exposure duration, or related to the electrical field in the tissue by

$$\text{SAR} = \frac{\sigma |E|^2}{\rho}$$

Where: σ is the conductivity of the tissue, ρ is the mass density of the tissue and E is the RMS electrical field strength.

However for evaluating SAR of low power transmitter, electrical field measurement is typically applied.

5. SAR Measurement System

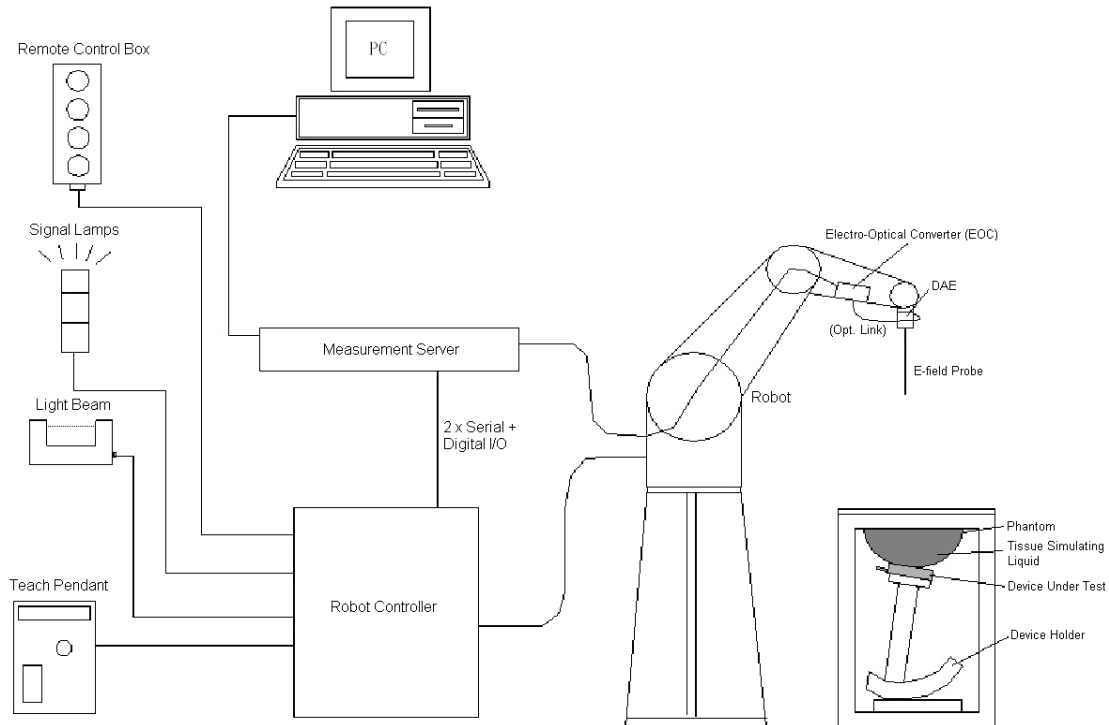

Fig 5.1 SPEAG DASY System Configurations

The DASY system for performance compliance tests is illustrated above graphically. This system consists of the following items:

- A standard high precision 6-axis robot with controller, a teach pendant and software
- A data acquisition electronic (DAE) attached to the robot arm extension
- A dosimetric probe equipped with an optical surface detector system
- The electro-optical converter (EOC) performs the conversion between optical and electrical signals
- A measurement server performs the time critical tasks such as signal filtering, control of the robot operation and fast movement interrupts.
- A probe alignment unit which improves the accuracy of the probe positioning
- A computer operating Windows XP
- DASY software
- Remote control with teach pendant and additional circuitry for robot safety such as warning lamps, etc.
- The SAM twin phantom
- A device holder
- Tissue simulating liquid
- Dipole for evaluating the proper functioning of the system

Some of the components are described in details in the following sub-sections.

5.1 E-Field Probe

The SAR measurement is conducted with the dosimetric probe (manufactured by SPEAG). The probe is specially designed and calibrated for use in liquid with high permittivity. The dosimetric probe has special calibration in liquid at different frequency. This probe has a built in optical surface detection system to prevent from collision with phantom.

5.1.1 E-Field Probe Specification

<ET3DV6 / ET3DV6R Probe >

Construction	Symmetrical design with triangular core Built-in optical fiber for surface detection system. Built-in shielding against static charges. PEEK enclosure material (resistant to organic solvents, e.g., DGBE)	 <p>Fig 5.2 Photo of ET3DV6/ET3DV6R</p>
Frequency	10 MHz to 3 GHz; Linearity: ± 0.2 dB	
Directivity	± 0.2 dB in HSL (rotation around probe axis) ± 0.4 dB in HSL (rotation normal to probe axis)	
Dynamic Range	5 μ W/g to 100 mW/g; Linearity: ± 0.2 dB	
Dimensions	Overall length: 330 mm (Tip: 16 mm) Tip diameter: 6.8 mm (Body: 12 mm) Distance from probe tip to dipole centers: 2.7 mm	

<EX3DV4 / ES3DV4 Probe>

Construction	Symmetrical design with triangular core Built-in shielding against static charges PEEK enclosure material (resistant to organic solvents, e.g., DGBE)	 <p>Fig 5.3 Photo of EX3DV4/ES3DV4</p>
Frequency	10 MHz to 6 GHz; Linearity: ± 0.2 dB	
Directivity	± 0.3 dB in HSL (rotation around probe axis) ± 0.5 dB in tissue material (rotation normal to probe axis)	
Dynamic Range	10 μ W/g to 100 mW/g; Linearity: ± 0.2 dB (noise: typically < 1 μ W/g)	
Dimensions	Overall length: 330 mm (Tip: 20 mm) Tip diameter: 2.5 mm (Body: 12 mm) Typical distance from probe tip to dipole centers: 1 mm	

5.1.2 E-Field Probe Calibration

Each probe needs to be calibrated according to a dosimetric assessment procedure with accuracy better than $\pm 10\%$. The spherical isotropy shall be evaluated and within ± 0.25 dB. The sensitivity parameters (NormX, NormY, and NormZ), the diode compression parameter (DCP) and the conversion factor (ConvF) of the probe are tested. The calibration data can be referred to appendix C of this report.

5.2 Data Acquisition Electronics (DAE)

The data acquisition electronics (DAE) consists of a highly sensitive electrometer-grade preamplifier with auto-zeroing, a channel and gain-switching multiplexer, a fast 16 bit AD-converter and a command decoder and control logic unit. Transmission to the measurement server is accomplished through an optical downlink for data and status information as well as an optical uplink for commands and the clock.

The input impedance of the DAE is 200 MOhm; the inputs are symmetrical and floating. Common mode rejection is above 80 dB.



Fig 5.4 Photo of DAE

5.3 Robot

The SPEAG DASY system uses the high precision robots (DASY4: RX90BL; DASY5: TX90XL) type from Stäubli SA (France). For the 6-axis controller system, the robot controller version (DASY4: CS7MB; DASY5: CS8c) from Stäubli is used. The Stäubli robot series have many features that are important for our application:

- High precision (repeatability ± 0.035 mm)
- High reliability (industrial design)
- Jerk-free straight movements
- Low ELF interference (the closed metallic construction shields against motor control fields)



Fig 5.5 Photo of DASY4



Fig 5.6 Photo of DASY5

5.4 Measurement Server

The measurement server is based on a PC/104 CPU board with CPU (DASY4: 166 MHz, Intel Pentium; DASY5: 400 MHz, Intel Celeron), chipdisk (DASY4: 32 MB; DASY5: 128 MB), RAM (DASY4: 64 MB, DASY5: 128 MB). The necessary circuits for communication with the DAE electronic box, as well as the 16 bit AD converter system for optical detection and digital I/O interface are contained on the DASY I/O board, which is directly connected to the PC/104 bus of the CPU board.

The measurement server performs all the real-time data evaluation for field measurements and surface detection, controls robot movements and handles safety operations.



Fig 5.7 Photo of Server for DASY4



Fig 5.8 Photo of Server for DASY5

5.5 Phantom

<SAM Twin Phantom>

Shell Thickness	2 ± 0.2 mm; Center ear point: 6 ± 0.2 mm	 <p>Fig 5.9 Photo of SAM Phantom</p>
Filling Volume	Approx. 25 liters	
Dimensions	Length: 1000 mm; Width: 500 mm; Height: adjustable feet	
Measurement Areas	Left Hand, Right Hand, Flat Phantom	

The bottom plate contains three pair of bolts for locking the device holder. The device holder positions are adjusted to the standard measurement positions in the three sections. A white cover is provided to tap the phantom during off-periods to prevent water evaporation and changes in the liquid parameters. On the phantom top, three reference markers are provided to identify the phantom position with respect to the robot.

<ELI4 Phantom>

Shell Thickness	2 ± 0.2 mm (sagging: <1%)	 <p>Fig 5.10 Photo of ELI4 Phantom</p>
Filling Volume	Approx. 30 liters	
Dimensions	Major ellipse axis: 600 mm Minor axis: 400 mm	

The ELI4 phantom is intended for compliance testing of handheld and body-mounted wireless devices in the frequency range of 30 MHz to 6 GHz. ELI4 is fully compatible with standard and all known tissue simulating liquids.

5.6 Device Holder

<Device Holder for SAM Twin Phantom>

The SAR in the phantom is approximately inversely proportional to the square of the distance between the source and the liquid surface. For a source at 5 mm distance, a positioning uncertainty of ± 0.5 mm would produce a SAR uncertainty of ± 20 %. Accurate device positioning is therefore crucial for accurate and repeatable measurements. The positions in which the devices must be measured are defined by the standards.

The DASY device holder is designed to cope with different positions given in the standard. It has two scales for the device rotation (with respect to the body axis) and the device inclination (with respect to the line between the ear reference points). The rotation center for both scales is the ear reference point (ERP). Thus the device needs no repositioning when changing the angles.

The DASY device holder is constructed of low-loss POM material having the following dielectric parameters: relative permittivity $\epsilon = 3$ and loss tangent $\delta = 0.02$. The amount of dielectric material has been reduced in the closest vicinity of the device, since measurements have suggested that the influence of the clamp on the test results could thus be lowered.



Fig 5.11 Device Holder

<Laptop Extension Kit>

The extension is lightweight and made of POM, acrylic glass and foam. It fits easily on the upper part of the mounting device in place of the phone positioned. The extension is fully compatible with the SAM Twin and ELI phantoms.

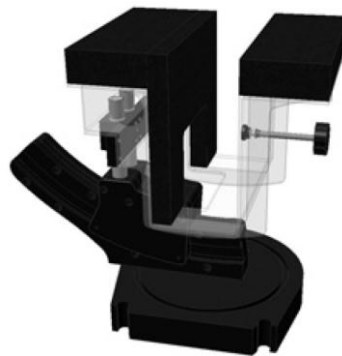

Fig 5.12 Laptop Extension Kit



5.7 Data Storage and Evaluation

5.7.1 Data Storage

The DASY software stores the assessed data from the data acquisition electronics as raw data (in microvolt readings from the probe sensors), together with all the necessary software parameters for the data evaluation (probe calibration data, liquid parameters and device frequency and modulation data) in measurement files. The post-processing software evaluates the desired unit and format for output each time the data is visualized or exported. This allows verification of the complete software setup even after the measurement and allows correction of erroneous parameter settings. For example, if a measurement has been performed with an incorrect crest factor parameter in the device setup, the parameter can be corrected afterwards and the data can be reevaluated.

The measured data can be visualized or exported in different units or formats, depending on the selected probe type (e.g., [V/m], [A/m], [mW/g]). Some of these units are not available in certain situations or give meaningless results, e.g., a SAR-output in a non-lose media, will always be zero. Raw data can also be exported to perform the evaluation with other software packages.

5.7.2 Data Evaluation

The DASY post-processing software (SEMCAD) automatically executes the following procedures to calculate the field units from the microvolt readings at the probe connector. The parameters used in the evaluation are stored in the configuration modules of the software :

Probe parameters :	- Sensitivity	Norm _i , a _{i0} , a _{i1} , a _{i2}
	- Conversion factor	ConvF _i
	- Diode compression point	dcp _i
Device parameters :	- Frequency	f
	- Crest factor	cf
Media parameters :	- Conductivity	σ
	- Density	ρ

These parameters must be set correctly in the software. They can be found in the component documents or they can be imported into the software from the configuration files issued for the DASY components. In the direct measuring mode of the multi-meter option, the parameters of the actual system setup are used. In the scan visualization and export modes, the parameters stored in the corresponding document files are used.

The first step of the evaluation is a linearization of the filtered input signal to account for the compression characteristics of the detector diode. The compensation depends on the input signal, the diode type and the DC-transmission factor from the diode to the evaluation electronics. If the exciting field is pulsed, the crest factor of the signal must be known to correctly compensate for peak power.

The formula for each channel can be given as :

$$V_i = U_i + U_i^2 \cdot \frac{cf}{dcp_i}$$

with V_i = compensated signal of channel i , ($i = x, y, z$)
 U_i = input signal of channel i , ($i = x, y, z$)
 cf = crest factor of exciting field (DASY parameter)
 dcp_i = diode compression point (DASY parameter)

From the compensated input signals, the primary field data for each channel can be evaluated :

$$\text{E-field Probes : } E_i = \sqrt{\frac{V_i}{\text{Norm}_i \cdot \text{ConvF}}}$$

$$\text{H-field Probes : } H_i = \sqrt{V_i \cdot \frac{a_{i0} + a_{i1}f + a_{i2}f^2}{f}}$$

with V_i = compensated signal of channel i , ($i = x, y, z$)
 Norm_i = sensor sensitivity of channel i , ($i = x, y, z$), $\mu\text{V}/(\text{V}/\text{m})^2$ for E-field Probes
 ConvF = sensitivity enhancement in solution
 a_{ij} = sensor sensitivity factors for H-field probes
 f = carrier frequency [GHz]
 E_i = electric field strength of channel i in V/m
 H_i = magnetic field strength of channel i in A/m

The RSS value of the field components gives the total field strength (Hermitian magnitude) :

$$E_{\text{tot}} = \sqrt{E_x^2 + E_y^2 + E_z^2}$$

The primary field data are used to calculate the derived field units.

$$\text{SAR} = E_{\text{tot}}^2 \cdot \frac{\sigma}{\rho \cdot 1000}$$

with SAR = local specific absorption rate in mW/g
 E_{tot} = total field strength in V/m
 σ = conductivity in [mho/m] or [Siemens/m]
 ρ = equivalent tissue density in g/cm^3

Note that the density is set to 1, to account for actual head tissue density rather than the density of the tissue simulating liquid.



5.8 Test Equipment List

Manufacturer	Name of Equipment	Type/Model	Serial Number	Calibration	
				Last Cal.	Due Date
SPEAG	Dosimetric E-Field Probe	EX3DV4	3792	Jun. 21, 2012	Jun. 20, 2013
SPEAG	Dosimetric E-Field Probe	ES3DV3	3305	Sep. 12, 2012	Sep. 11, 2013
SPEAG	Dosimetric E-Field Probe	EX3DV4	3819	Nov. 16, 2011	Nov. 15, 2012
SPEAG	Dosimetric E-Field Probe	EX3DV4	3697	Sep. 28, 2012	Sep. 27, 2013
SPEAG	2450MHz System Validation Kit	D2450V2	736	Jul. 25, 2011	Jul. 24, 2013
SPEAG	5GHz System Validation Kit	D5GHzV2	1006	Jan. 18, 2012	Jan. 17, 2013
SPEAG	Data Acquisition Electronics	DAE4	778	Nov. 22, 2011	Nov. 21, 2012
SPEAG	Data Acquisition Electronics	DAE3	495	Apr. 23, 2012	Apr. 22, 2013
SPEAG	Data Acquisition Electronics	DAE4	1338	Jun. 12, 2012	Jun. 11, 2013
SPEAG	Data Acquisition Electronics	DAE4	1279	May. 03, 2012	May. 02, 2013
SPEAG	Device Holder	N/A	N/A	NCR	NCR
SPEAG	SAM Phantom	QD 000 P40 C	TP-1303	NCR	NCR
SPEAG	SAM Phantom	QD 000 P40 C	TP-1383	NCR	NCR
SPEAG	SAM Phantom	QD 000 P40 C	TP-1446	NCR	NCR
SPEAG	SAM Phantom	QD 000 P40 C	TP-1478	NCR	NCR
SPEAG	SAM Phantom	QD 000 P41 C	TP-1150	NCR	NCR
SPEAG	SAM Phantom	QD 000 P40 CD	TP-1644	NCR	NCR
SPEAG	SAM Phantom	SM 000 T01 DA	TP-1542	NCR	NCR
SPEAG	ELI4 Phantom	QD 0VA 001 BB	1026	NCR	NCR
SPEAG	ELI4 Phantom	QD 0VA 001 BA	1029	NCR	NCR
SPEAG	ELI4 Phantom	QD 0VA 002 AA	TP-1127	NCR	NCR
SPEAG	ELI4 Phantom	QD 0VA 002 AA	TP-1131	NCR	NCR
Agilent	Network Analyzer	E5071C	MY46100746	Jun. 10, 2011	Jun. 09, 2012
Agilent	Network Analyzer	E5071C	MY46101588	May. 11, 2012	May. 10, 2013
Agilent	ESG Vector Series Signal Generator	E4438C	MY49070755	Oct. 17, 2011	Oct. 16, 2012
Agilent	ESG Vector Series Signal Generator	E4438C	MY49070755	Oct. 02, 2012	Oct. 01, 2013
Anritsu	Power Meter	ML2495A	0932001	Sep. 21, 2011	Sep. 20, 2012
Anritsu	Power Meter	ML2495A	1132003	Aug. 14, 2012	Aug. 13, 2013
R&S	Spectrum Analyzer	FSP7	101131	Jul. 29, 2011	Jul. 28, 2012
R&S	Spectrum Analyzer	FSP7	101131	Jul. 23, 2012	Jul. 22, 2013

Table 5.1 Test Equipment List

Note:

1. The calibration certificate of DASY can be referred to appendix C of this report.
2. Referring to KDB 450824 D02, the dipole calibration interval can be extended to 3 years with justification. The dipoles are also not physically damaged, or repaired during the interval.
3. The justification data of dipole D2450V2, SN:736 can be found in appendix C. The return loss is < -20dB, within 20% of prior calibration, the impedance is within 5 ohm of prior calibration.

6. Tissue Simulating Liquids

For the measurement of the field distribution inside the SAM phantom with DASY, the phantom must be filled with around 25 liters of homogeneous body tissue simulating liquid. For head SAR testing, the liquid height from the ear reference point (ERP) of the phantom to the liquid top surface is larger than 15 cm, which is shown in Fig. 6.1. For body SAR testing, the liquid height from the center of the flat phantom to the liquid top surface is larger than 15 cm, which is shown in Fig. 6.2.

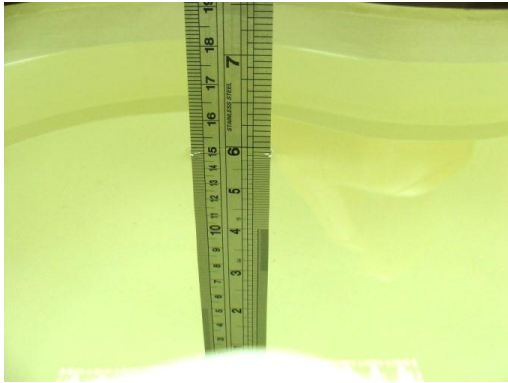

Fig 6.1 Photo of Liquid Height for Head SAR



Fig 6.2 Photo of Liquid Height for Body SAR

The following table gives the recipes for tissue simulating liquid.

Frequency (MHz)	Water (%)	Sugar (%)	Cellulose (%)	Salt (%)	Preventol (%)	DGBE (%)	Conductivity (σ)	Permittivity (ϵ_r)
For Head								
2450	55.0	0	0	0	0	45.0	1.80	39.2
For Body								
2450	68.6	0	0	0	0	31.4	1.95	52.7

Table 6.1 Recipes of Tissue Simulating Liquid

Simulating Liquid for 5G, Manufactured by SPEAG

Ingredients	(% by weight)
Water	64~78%
Mineral oil	11~18%
Emulsifiers	9~15%
Additives and Salt	2~3%



The dielectric parameters of the liquids were verified prior to the SAR evaluation using an Agilent 85070D Dielectric Probe Kit and an Agilent Network Analyzer.

The following table shows the measuring results for simulating liquid.

Freq. (MHz)	Liquid Type	Temp. (°C)	Conductivity (σ)	Permittivity (ϵ_r)	Conductivity Target (σ)	Permittivity Target (ϵ_r)	Delta (σ) (%)	Delta (ϵ_r) (%)	Limit (%)	Date
2450	Body	21.2	2.015	53.957	1.95	52.7	3.33	2.39	±5	Oct. 11, 2012
5200	Body	21.6	5.162	48.492	5.3	49	-2.60	-1.04	±5	May. 16, 2012
5200	Body	21.3	5.297	49.185	5.3	49	-0.06	0.38	±5	Oct. 19, 2012
5500	Body	21.6	5.587	47.93	5.65	48.6	-1.12	-1.38	±5	May. 16, 2012
5500	Body	21.5	5.52	47	5.65	48.6	-2.30	-3.29	±5	Oct. 08, 2012
5800	Body	21.5	5.99	46.5	6	48.2	-0.17	-3.53	±5	Oct. 08, 2012
5800	Body	21.5	6.113	47.156	6	48.2	1.88	-2.17	±5	Oct. 17, 2012

Table 6.2 Measuring Results for Simulating Liquid

7. SAR Measurement Evaluation

Each DASY system is equipped with one or more system validation kits. These units, together with the predefined measurement procedures within the DASY software, enable the user to conduct the system performance check and system validation. System validation kit includes a dipole, tripod holder to fix it underneath the flat phantom and a corresponding distance holder.

7.1 Purpose of System Performance check

The system performance check verifies that the system operates within its specifications. System and operator errors can be detected and corrected. It is recommended that the system performance check be performed prior to any usage of the system in order to guarantee reproducible results. The system performance check uses normal SAR measurements in a simplified setup with a well characterized source. This setup was selected to give a high sensitivity to all parameters that might fail or vary over time. The system check does not intend to replace the calibration of the components, but indicates situations where the system uncertainty is exceeded due to drift or failure.

7.2 System Setup

In the simplified setup for system evaluation, the EUT is replaced by a calibrated dipole and the power source is replaced by a continuous wave that comes from a signal generator. The calibrated dipole must be placed beneath the flat phantom section of the SAM twin phantom with the correct distance holder. The distance holder should touch the phantom surface with a light pressure at the reference marking and be oriented parallel to the long side of the phantom. The equipment setup is shown below:

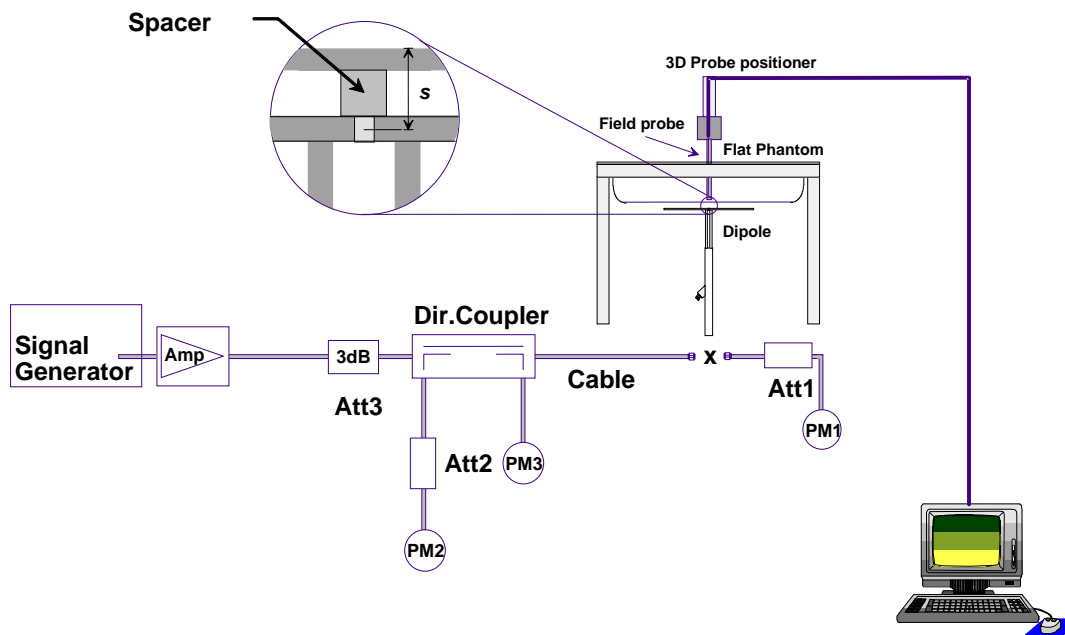

Fig 7.1 System Setup for System Evaluation

1. Signal Generator
2. Amplifier
3. Directional Coupler
4. Power Meter
5. Calibrated Dipole

The output power on dipole port must be calibrated to 24 dBm (250 mW) before dipole is connected.



Fig 7.2 Photo of Dipole Setup

7.3 Validation Results

Comparing to the original SAR value provided by SPEAG, the validation data should be within its specification of 10 %. Table 7.1 shows the target SAR and measured SAR after normalized to 1W input power. The table below indicates the system performance check can meet the variation criterion and the plots can be referred to Appendix A of this report.

Measurement Date	Frequency (MHz)	Liquid Type	Targeted SAR _{1g} (W/kg)	Measured SAR _{1g} (W/kg)	Normalized SAR _{1g} (W/kg)	Deviation (%)
Oct. 11, 2012	2450	Body	52.3	12.5	50.00	-4.40
May. 16, 2012	5200	Body	72.6	16.8	67.20	-7.44
Oct. 19, 2012	5200	Body	72.6	17.1	68..40	-5.79
May. 16, 2012	5500	Body	78.8	18.9	75.60	-4.06
Oct. 08, 2012	5500	Body	78.8	19.7	78.80	0.00
Oct. 08, 2012	5800	Body	73.10	18	72.00	-1.50
Oct. 17, 2012	5800	Body	73.10	17.4	69.60	-4.79

Table 7.1 Target and Measurement SAR after Normalized

8. EUT Testing Position

The EUT was tested in keypad-bottom directly touched the phantom. Please refer to Appendix E for the test setup photos.

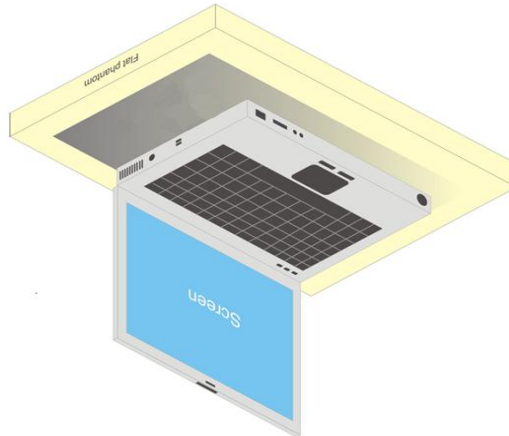

Fig 8.1 Illustration for Lap-touching Position

9. Measurement Procedures

The measurement procedures are as follows:

- (a) Use base station simulator (if applicable) or engineering software to transmit RF power continuously (continuous Tx) in the highest power channel.
- (b) Keep EUT to radiate maximum output power or 100% duty factor (if applicable)
- (c) Measure output power through RF cable and power meter.
- (d) Place the EUT in the positions as Appendix E demonstrates.
- (e) Set scan area, grid size and other setting on the DASY software.
- (f) Measure SAR results for the highest power channel on each testing position.
- (g) Find out the largest SAR result on these testing positions of each band
- (h) Measure SAR results for other channels in worst SAR testing position if the SAR of highest power channel is larger than 0.8 W/kg

According to the test standard, the recommended procedure for assessing the peak spatial-average SAR value consists of the following steps:

- (a) Power reference measurement
- (b) Area scan
- (c) Zoom scan
- (d) Power drift measurement

9.1 Spatial Peak SAR Evaluation

The procedure for spatial peak SAR evaluation has been implemented according to the test standard. It can be conducted for 1g and 10g, as well as for user-specific masses. The DASY software includes all numerical procedures necessary to evaluate the spatial peak SAR value.

The base for the evaluation is a "cube" measurement. The measured volume must include the 1g and 10g cubes with the highest averaged SAR values. For that purpose, the center of the measured volume is aligned to the interpolated peak SAR value of a previously performed area scan.

The entire evaluation of the spatial peak values is performed within the post-processing engine (SEMCAD). The system always gives the maximum values for the 1g and 10g cubes. The algorithm to find the cube with highest averaged SAR is divided into the following stages:

- (a) Extraction of the measured data (grid and values) from the Zoom Scan
- (b) Calculation of the SAR value at every measurement point based on all stored data (A/D values and measurement parameters)
- (c) Generation of a high-resolution mesh within the measured volume
- (d) Interpolation of all measured values from the measurement grid to the high-resolution grid
- (e) Extrapolation of the entire 3-D field distribution to the phantom surface over the distance from sensor to surface
- (f) Calculation of the averaged SAR within masses of 1g and 10g

9.2 Area & Zoom Scan Procedures

First Area Scan is used to locate the approximate location(s) of the local peak SAR value(s). The measurement grid within an Area Scan is defined by the grid extent, grid step size and grid offset. Next, in order to determine the EM field distribution in a three-dimensional spatial extension, Zoom Scan is required. The Zoom Scan measures 5x5x7 points with step size 8, 8 and 5 mm for 300 MHz to 3 GHz, and 8x8x8 points with step size 4, 4 and 2.5 mm for 3 GHz to 6 GHz. The Zoom Scan is performed around the highest E-field value to determine the averaged SAR-distribution over 10 g.



9.3 Volume Scan Procedures

The volume scan is used for assess overlapping SAR distributions for antennas transmitting in different frequency bands. It is equivalent to an oversized zoom scan used in standalone measurements. The measurement volume will be used to enclose all the simultaneous transmitting antennas. For antennas transmitting simultaneously in different frequency bands, the volume scan is measured separately in each frequency band. In order to sum correctly to compute the 1g aggregate SAR, the EUT remain in the same test position for all measurements and all volume scan use the same spatial resolution and grid spacing (step-size is 4, 4 and 2.5 mm). When all volume scan were completed, the software, SEMCAD postprocessor can combine and subsequently superpose these measurement data to calculating the multiband SAR.

9.4 SAR Averaged Methods

In DASYS, the interpolation and extrapolation are both based on the modified Quadratic Shepard's method. The interpolation scheme combines a least-square fitted function method and a weighted average method which are the two basic types of computational interpolation and approximation.

Extrapolation routines are used to obtain SAR values between the lowest measurement points and the inner phantom surface. The extrapolation distance is determined by the surface detection distance and the probe sensor offset. The uncertainty increases with the extrapolation distance. To keep the uncertainty within 1% for the 1 g and 10 g cubes, the extrapolation distance should not be larger than 5 mm.

9.5 Power Drift Monitoring

All SAR testing is under the EUT install full charged battery and transmit maximum output power. In DASYS measurement software, the power reference measurement and power drift measurement procedures are used for monitoring the power drift of EUT during SAR test. Both these procedures measure the field at a specified reference position before and after the SAR testing. The software will calculate the field difference in dB. If the power drift more than 5%, the SAR will be retested.

10. SAR Test Configurations

10.1 Exposure Positions Consideration

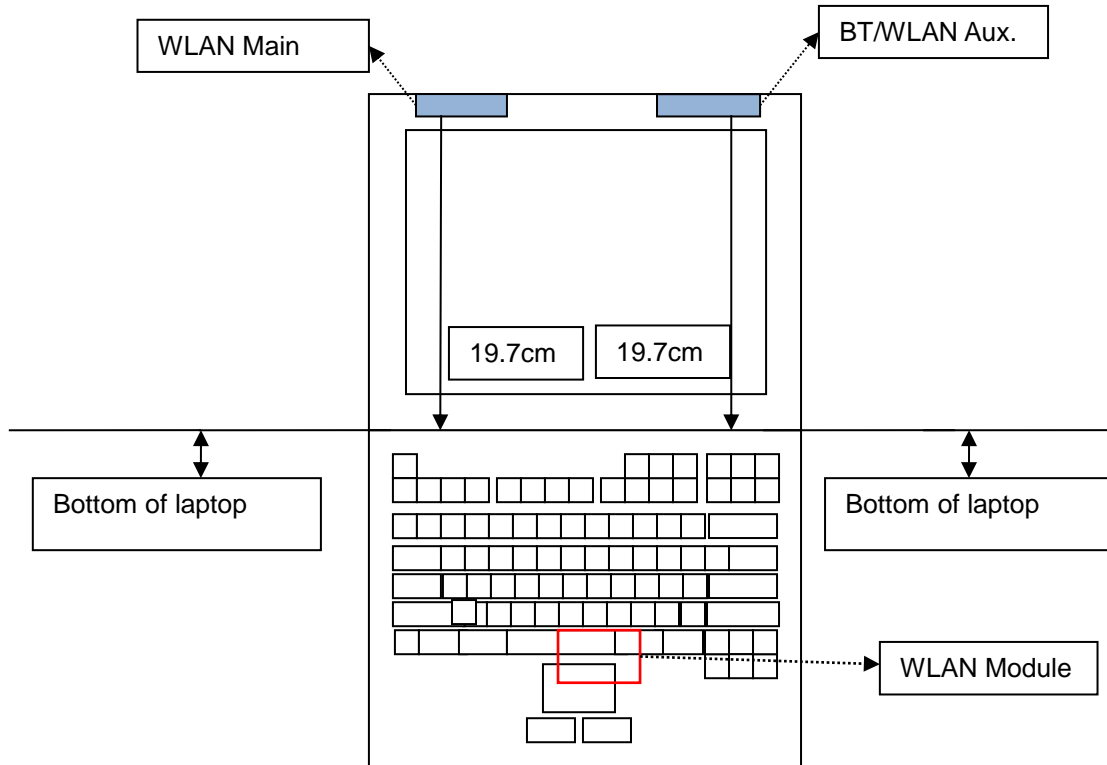

Label	Antenna	Wireless Interface
Ant. 0	WLAN Main (Tx / Rx)	WLAN2.4G and 5G Bluetooth
Ant. 1	BT/WLAN Aux. (Tx / Rx)	WLAN2.4G and 5G

Band \ Antenna	Ant0	Ant1	Ant0+1
Bluetooth	No	Yes	No
2.4GHz 802.11b/g	Yes	No	No
2.4GHz 802.11n	No	No	Yes
5GHz 802.11a	Yes	No	No
5GHz 802.11n	No	No	Yes

Note:

1. Ant.0 represents the WLAN Main Antenna transmission only; Ant.0+1 represents the WLAN Main and BT/WLAN Aux. Antennas simultaneous transmission.
2. Per KDB 447498 D01, Bluetooth output power $\leq 60/f(\text{GHz})$ mW thus standalone SAR is not required.

10.2 Conducted RF Output Power (Unit: dBm)

<WLAN 2.4GHz>

<Ant. 0>

WLAN 2.4G 802.11b Average Power (dBm)						
Power vs. Channel			Power vs. Data Rate			
Channel	Frequency (MHz)	Data Rate (bps)	Channel	Data Rate (bps)		
		1M		2M	5.5M	11M
CH 01	2412	17.53	01	17.44	17.42	17.48
CH 06	2437	16.47				
CH 11	2462	16.42				

WLAN 2.4G 802.11g Average Power (dBm)										
Power vs. Channel			Power vs. Data Rate							
Channel	Frequency (MHz)	Data Rate (bps)	Channel	Data Rate (bps)						
		6M		9M	12M	18M	24M	36M	48M	54M
CH 01	2412	12.76	06	19.00	18.86	18.93	18.91	18.88	18.85	18.87
CH 06	2437	19.03								
CH 11	2462	13.13								

Note:

1. Per KDB 248227, choose the highest output power channel to test SAR and determine further SAR exclusion
2. Per KDB 248227, 11g average output power is higher than 1/4 dB higher than 11b mode, SAR will be verified.
3. For each frequency band, testing at higher data rates and higher order modulations is not required when the maximum average output power for each of these configurations is less than 1/4 dB higher than those measured at the lowest data rate.

<Ant. 0+1>

WLAN 2.4G 802.11n (BW 20MHz) Average Power (dBm)										
Power vs. Channel			Power vs. Data Rate							
Channel	Frequency (MHz)	Data Rate (bps)	Channel	MCS Index						
		MCS8		MCS9	MCS10	MCS11	MCS12	MCS13	MCS14	MCS15
CH 01	2412	12.67	06	17.84	17.86	17.76	17.79	17.83	17.82	17.89
CH 06	2437	17.94								
CH 11	2462	12.66								

WLAN 2.4G 802.11n (BW 40MHz) Average Power (dBm)										
Power vs. Channel			Power vs. Data Rate							
Channel	Frequency (MHz)	Data Rate (bps)	Channel	MCS Index						
		MCS8		MCS9	MCS10	MCS11	MCS12	MCS13	MCS14	MCS15
CH 03	2422	12.41	06	14.07	14.02	14.13	14.12	14.06	14.05	14.02
CH 06	2437	14.14								
CH 09	2452	10.36								

Note:

4. Per KDB 248227, choose the highest output power channel to test SAR and determine further SAR exclusion
5. Per KDB 248227, 11n(40M) output power is less than 1/4 dB higher than 11n(20M) mode, thus the SAR can be excluded.
6. For each frequency band, testing at higher data rates and higher order modulations is not required when the maximum average output power for each of these configurations is less than 1/4 dB higher than those measured at the lowest data rate.



<WLAN 5GHz>
<Ant. 0>

WLAN 5G 802.11a Average Power (dBm)										
Power vs. Channel			Power vs. Data Rate							
Channel	Frequency (MHz)	Data Rate (bps)	Channel	Data Rate (bps)						
		6M		9M	12M	18M	24M	36M	48M	54M
CH 36	5180	13.49	44	13.79	13.82	13.85	13.77	13.86	13.84	13.83
CH 40	5200	13.54								
CH 44	5220	13.89								
CH 48	5240	13.69								
CH 52	5260	16.98	52	16.95	16.92	16.86	16.76	16.71	16.80	16.78
CH 56	5280	16.95								
CH 60	5300	15.86								
CH 64	5320	14.51								
CH 100	5500	16.76	108	17.24	17.21	17.18	17.16	17.26	17.28	17.23
CH 104	5520	17.07								
CH 108	5540	17.31								
CH 112	5560	17.12								
CH 116	5580	16.95								
CH 132	5660	17.20								
CH 136	5680	16.91								
CH 140	5700	16.97								
CH 149	5745	17.44	161	17.55	17.51	17.48	17.42	17.53	17.52	17.46
CH 153	5765	17.26								
CH 157	5785	17.49								
CH 161	5805	17.58								
CH 165	5825	17.53								

<Bluetooth>

Channel	Frequency (MHz)	Average power (dBm)		
		Mode		
		GFSK	π/4-DQPSK	8-DPSK
CH 0	2402	0.11	-3.45	-3.47
CH 39	2441	0.41	-3.12	-3.15
CH 78	2480	0.44	-3.06	-3.05

Note: Per KDB 447498, 2.4GHz Bluetooth SAR is excluded due to highest output power ≤ 60/f (GHz) mW, where 60/f (GHz) = 24mW = 13.8dBm.

Channel	Frequency (MHz)	Average power (dBm)
		Mode
		BT v4.0 LE, GFSK
CH 0	2402	3.76
CH 19	2440	3.98
CH 39	2480	3.95



<Ant 0+1>

WLAN 5G 802.11n (BW 20M) Average Power (dBm)										
Power vs. Channel			Power vs. Data Rate							
Channel	Frequency (MHz)	Data Rate (bps)	Channel	MCS Index						
		MCS8		MCS9	MCS10	MCS11	MCS12	MCS13	MCS14	MCS15
CH 36	5180	12.26	36	12.21	12.14	12.23	12.11	12.10	12.16	12.20
CH 40	5200	11.54								
CH 44	5220	11.56								
CH 48	5240	11.21								
CH 52	5260	15.22	60	19.08	19.00	18.96	18.98	19.02	19.01	18.87
CH 56	5280	18.89								
CH 60	5300	19.10								
CH 64	5320	17.37								
CH 100	5500	18.86	116	19.58	19.46	19.60	19.62	19.53	19.54	19.60
CH 104	5520	19.46								
CH 108	5540	19.56								
CH 112	5560	19.63								
CH 116	5580	19.66								
CH 132	5660	19.04								
CH 136	5680	18.79								
CH 140	5700	16.22								
CH 149	5745	17.82	165	18.71	18.76	18.70	18.73	18.82	18.80	18.79
CH 153	5765	18.26								
CH 157	5785	18.33								
CH 161	5805	18.74								
CH 165	5825	18.85								

WLAN 5G 802.11n (BW 40M) Average Power (dBm)										
Power vs. Channel			Power vs. Data Rate							
Channel	Frequency (MHz)	Data Rate (bps)	Channel	MCS Index						
		MCS8		MCS9	MCS10	MCS11	MCS12	MCS13	MCS14	MCS15
CH 38	5190	12.43	46	12.66	12.64	12.51	12.58	12.63	12.70	12.68
CH 46	5230	12.74								
CH 54	5270	19.55	54	19.52	19.42	19.46	19.40	19.44	19.51	19.53
CH 62	5310	11.33								
CH 102	5510	16.09	134	19.54	19.56	19.51	19.58	19.50	19.46	19.54
CH 110	5550	19.56								
CH 134	5670	19.61								
CH 151	5755	18.14	159	18.44	18.30	18.36	18.45	18.41	18.37	18.32
CH 159	5795	18.49								

Note:

- Per KDB 248227, choose the highest output power channel to test SAR and determine further SAR exclusion
- Since 11n(40M) 5180 MHz ~ 5240MHz power is 1/4dB higher than 11n(20M) 5180 MHz ~ 5240MHz , 11n(40M) SAR will be verified.
- Since 11n(40M) 5260 MHz ~ 5320MHz power is 1/4dB higher than 11n(20M) 5260 MHz ~ 5320MHz , 11n(40M) SAR will be verified.
- Per KDB 248227, 11n(40M) 5500 MHz ~ 5700MHz output power is less than 1/4 dB higher than 11n(20M) 5500 MHz ~ 5700 MHz, thus the SAR can be excluded.
- Per KDB 248227, 11n(40M) 5745 MHz ~ 5825MHz output power is less than 1/4 dB higher than 11n(20M) 5745 MHz ~ 5825 MHz, thus the SAR can be excluded.
- For each frequency band, testing at higher data rates and higher order modulations is not required when the maximum average output power for each of these configurations is less than 1/4 dB higher than those measured at the lowest data rate.



11. SAR Test Results

11.1 Test Records for Body SAR Test

Plot No.	Band	Mode	Test Position	Gap (cm)	Ch.	Freq. (MHz)	Ant Status	Average Power (dBm)	Tune-Up Limit (dBm)	Scaling Factor	Power Drift (dB)	SAR _{1g} (W/kg)	Scaled SAR _{1g} (W/kg)
17	WLAN2.4G	802.11b	Bottom	0	1	2412	0	17.53	18	1.114	-0.04	0.028	0.031
24	WLAN2.4G	802.11g	Bottom	0	6	2437	0	19.03	19.5	1.114	-0.049	0.02	0.022
20	WLAN2.4G	802.11n	Bottom	0	6	2437	0+1	17.94	18.5	1.138	-0.04	0.00323	0.004
1	WLAN5G	802.11a	Bottom	0	44	5220	0	13.89	14	1.026	-0.116	0.013	0.013
7	WLAN5G	802.11n(20M)	Bottom	0	36	5180	0+1	12.26	12.5	1.057	-0.17	0.012	0.013
25	WLAN5G	802.11n(40M)	Bottom	0	46	5230	0+1	12.74	13	1.062	0.089	0.00116	0.001
3	WLAN5G	802.11a	Bottom	0	52	5260	0	16.98	17.5	1.127	-0.145	0.015	0.017
10	WLAN5G	802.11n(20M)	Bottom	0	60	5300	0+1	19.1	19.5	1.096	0.12	0.013	0.014
26	WLAN5G	802.11n(40M)	Bottom	0	54	5270	0+1	19.55	20	1.109	0.071	0.022	0.024
5	WLAN5G	802.11a	Bottom	0	108	5540	0	17.31	17.5	1.045	0.01	0.048	0.050
13	WLAN5G	802.11n(20M)	Bottom	0	116	5580	0+1	19.66	20	1.081	-0.14	0.017	0.018
22	WLAN5G	802.11a	Bottom	0	161	5805	22	17.58	17	0.875	0.001	0.0346	0.032
15	WLAN5G	802.11n(20M)	Bottom	0	165	5825	0+1	18.85	19	1.035	0.02	0.09	0.093

Note: Per KDB 447498, if the highest output channel SAR for each exposure position ≤ 0.8 W/kg other channels SAR tests are not necessary.

11.2 Simultaneous Transmission SAR Analysis and Measurements

No.	Applicable Simultaneous Transmission Combination
1.	None

Note:

1. WLAN and BT share the same antenna, and cannot transmit simultaneously.
2. EUT will choose either WLAN2.4G or WLAN5G according to the network signal condition; therefore, they will not transmit simultaneously.

Test Engineer : San Lin, Michael Yang, and Nick Yu

12. Uncertainty Assessment

The component of uncertainty may generally be categorized according to the methods used to evaluate them. The evaluation of uncertainty by the statistical analysis of a series of observations is termed a Type A evaluation of uncertainty. The evaluation of uncertainty by means other than the statistical analysis of a series of observations is termed a Type B evaluation of uncertainty. Each component of uncertainty, however evaluated, is represented by an estimated standard deviation, termed standard uncertainty, which is determined by the positive square root of the estimated variance.

A Type A evaluation of standard uncertainty may be based on any valid statistical method for treating data. This includes calculating the standard deviation of the mean of a series of independent observations; using the method of least squares to fit a curve to the data in order to estimate the parameter of the curve and their standard deviations; or carrying out an analysis of variance in order to identify and quantify random effects in certain kinds of measurement.

A type B evaluation of standard uncertainty is typically based on scientific judgment using all of the relevant information available. These may include previous measurement data, experience and knowledge of the behavior and properties of relevant materials and instruments, manufacture’s specification, data provided in calibration reports and uncertainties assigned to reference data taken from handbooks. Broadly speaking, the uncertainty is either obtained from an outdoor source or obtained from an assumed distribution, such as the normal distribution, rectangular or triangular distributions indicated in Table 12.1

Uncertainty Distributions	Normal	Rectangular	Triangular	U-Shape
Multi-plying Factor ^(a)	1/k ^(b)	1/√3	1/√6	1/√2

(a) standard uncertainty is determined as the product of the multiplying factor and the estimated range of variations in the measured quantity

(b) κ is the coverage factor

Table 12.1 Standard Uncertainty for Assumed Distribution

The combined standard uncertainty of the measurement result represents the estimated standard deviation of the result. It is obtained by combining the individual standard uncertainties of both Type A and Type B evaluation using the usual “root-sum-squares” (RSS) methods of combining standard deviations by taking the positive square root of the estimated variances.

Expanded uncertainty is a measure of uncertainty that defines an interval about the measurement result within which the measured value is confidently believed to lie. It is obtained by multiplying the combined standard uncertainty by a coverage factor. Typically, the coverage factor ranges from 2 to 3. Using a coverage factor allows the true value of a measured quantity to be specified with a defined probability within the specified uncertainty range. For purpose of this document, a coverage factor two is used, which corresponds to confidence interval of about 95 %. The DASY uncertainty Budget is shown in the following tables.



Error Description	Uncertainty Value (±%)	Probability Distribution	Divisor	Ci (1g)	Ci (10g)	Standard Uncertainty (1g)	Standard Uncertainty (10g)
Measurement System							
Probe Calibration	6.0	Normal	1	1	1	± 6.0 %	± 6.0 %
Axial Isotropy	4.7	Rectangular	√3	0.7	0.7	± 1.9 %	± 1.9 %
Hemispherical Isotropy	9.6	Rectangular	√3	0.7	0.7	± 3.9 %	± 3.9 %
Boundary Effects	1.0	Rectangular	√3	1	1	± 0.6 %	± 0.6 %
Linearity	4.7	Rectangular	√3	1	1	± 2.7 %	± 2.7 %
System Detection Limits	1.0	Rectangular	√3	1	1	± 0.6 %	± 0.6 %
Readout Electronics	0.3	Normal	1	1	1	± 0.3 %	± 0.3 %
Response Time	0.8	Rectangular	√3	1	1	± 0.5 %	± 0.5 %
Integration Time	2.6	Rectangular	√3	1	1	± 1.5 %	± 1.5 %
RF Ambient Noise	3.0	Rectangular	√3	1	1	± 1.7 %	± 1.7 %
RF Ambient Reflections	3.0	Rectangular	√3	1	1	± 1.7 %	± 1.7 %
Probe Positioner	0.4	Rectangular	√3	1	1	± 0.2 %	± 0.2 %
Probe Positioning	2.9	Rectangular	√3	1	1	± 1.7 %	± 1.7 %
Max. SAR Eval.	1.0	Rectangular	√3	1	1	± 0.6 %	± 0.6 %
Test Sample Related							
Device Positioning	2.9	Normal	1	1	1	± 2.9 %	± 2.9 %
Device Holder	3.6	Normal	1	1	1	± 3.6 %	± 3.6 %
Power Drift	5.0	Rectangular	√3	1	1	± 2.9 %	± 2.9 %
Phantom and Setup							
Phantom Uncertainty	4.0	Rectangular	√3	1	1	± 2.3 %	± 2.3 %
Liquid Conductivity (Target)	5.0	Rectangular	√3	0.64	0.43	± 1.8 %	± 1.2 %
Liquid Conductivity (Meas.)	2.5	Normal	1	0.64	0.43	± 1.6 %	± 1.1 %
Liquid Permittivity (Target)	5.0	Rectangular	√3	0.6	0.49	± 1.7 %	± 1.4 %
Liquid Permittivity (Meas.)	2.5	Normal	1	0.6	0.49	± 1.5 %	± 1.2 %
Combined Standard Uncertainty						± 11.0 %	± 10.8 %
Coverage Factor for 95 %						K=2	
Expanded Uncertainty						± 22.0 %	± 21.5 %

Table 12.2 Uncertainty Budget of DASY for frequency range 300 MHz to 3 GHz



Error Description	Uncertainty Value (±%)	Probability Distribution	Divisor	Ci (1g)	Ci (10g)	Standard Uncertainty (1g)	Standard Uncertainty (10g)
Measurement System							
Probe Calibration	6.55	Normal	1	1	1	± 6.55 %	± 6.55 %
Axial Isotropy	4.7	Rectangular	√3	0.7	0.7	± 1.9 %	± 1.9 %
Hemispherical Isotropy	9.6	Rectangular	√3	0.7	0.7	± 3.9 %	± 3.9 %
Boundary Effects	2.0	Rectangular	√3	1	1	± 1.2 %	± 1.2 %
Linearity	4.7	Rectangular	√3	1	1	± 2.7 %	± 2.7 %
System Detection Limits	1.0	Rectangular	√3	1	1	± 0.6 %	± 0.6 %
Readout Electronics	0.3	Normal	1	1	1	± 0.3 %	± 0.3 %
Response Time	0.8	Rectangular	√3	1	1	± 0.5 %	± 0.5 %
Integration Time	2.6	Rectangular	√3	1	1	± 1.5 %	± 1.5 %
RF Ambient Noise	3.0	Rectangular	√3	1	1	± 1.7 %	± 1.7 %
RF Ambient Reflections	3.0	Rectangular	√3	1	1	± 1.7 %	± 1.7 %
Probe Positioner	0.8	Rectangular	√3	1	1	± 0.5 %	± 0.5 %
Probe Positioning	9.9	Rectangular	√3	1	1	± 5.7 %	± 5.7 %
Max. SAR Eval.	4.0	Rectangular	√3	1	1	± 2.3 %	± 2.3 %
Test Sample Related							
Device Positioning	2.9	Normal	1	1	1	± 2.9 %	± 2.9 %
Device Holder	3.6	Normal	1	1	1	± 3.6 %	± 3.6 %
Power Drift	5.0	Rectangular	√3	1	1	± 2.9 %	± 2.9 %
Phantom and Setup							
Phantom Uncertainty	4.0	Rectangular	√3	1	1	± 2.3 %	± 2.3 %
Liquid Conductivity (Target)	5.0	Rectangular	√3	0.64	0.43	± 1.8 %	± 1.2 %
Liquid Conductivity (Meas.)	2.5	Normal	1	0.64	0.43	± 1.6 %	± 1.1 %
Liquid Permittivity (Target)	5.0	Rectangular	√3	0.6	0.49	± 1.7 %	± 1.4 %
Liquid Permittivity (Meas.)	2.5	Normal	1	0.6	0.49	± 1.5 %	± 1.2 %
Combined Standard Uncertainty						± 12.8 %	± 12.6 %
Coverage Factor for 95 %						K=2	
Expanded Uncertainty						± 25.6 %	± 25.2 %

Table 12.3 Uncertainty Budget of DASY for frequency range 3 GHz to 6 GHz



13. References

- [1] FCC 47 CFR Part 2 “Frequency Allocations and Radio Treaty Matters; General Rules and Regulations”
- [2] ANSI/IEEE Std. C95.1-1992, “IEEE Standard for Safety Levels with Respect to Human Exposure to Radio Frequency Electromagnetic Fields, 3 kHz to 300 GHz”, September 1992
- [3] IEEE Std. 1528-2003, “Recommended Practice for Determining the Peak Spatial-Average Specific Absorption Rate (SAR) in the Human Head from Wireless Communications Devices: Measurement Techniques”, December 2003
- [4] FCC OET Bulletin 65 (Edition 97-01) Supplement C (Edition 01-01), “Evaluating Compliance with FCC Guidelines for Human Exposure to Radiofrequency Electromagnetic Fields”, June 2001
- [5] SPEAG DASY System Handbook
- [6] FCC KDB 248227 D01 v01r02, “SAR Measurement Procedures for 802.11 a/b/g Transmitters”, May 2007
- [7] FCC KDB 447498 D01 v04, “Mobile and Portable Device RF Exposure Procedures and Equipment Authorization Policies”, November 2009
- [8] FCC KDB 616217 D01 v01r01, "SAR Evaluation Considerations for Laptop Computers with Antennas Built-in on Display Screens", November 2009
- [9] FCC KDB 616217 D03 v01, “SAR Evaluation Considerations for Laptop/Notebook/Netbook and Tablet Computers”, November 2009
- [10] FCC KDB 941225 D01 v02, “SAR Measurement Procedures for 3G Devices – CDMA 2000 / Ev-Do / WCDMA / HSDPA / HSPA”, October 2007
- [11] FCC KDB 941225 D03 v01, “Recommended SAR Test Reduction Procedures for GSM / GPRS / EDGE”, December 2008
- [12] FCC KDB 941225 D04 v01, “Evaluating SAR for GSM/(E)GPRS Dual Transfer Mode”, January 27 2010



Appendix A. Plots of System Performance Check

The plots are shown as follows.



Appendix B. Plots of SAR Measurement

The plots are shown as follows.



Appendix C. DAS Y Calibration Certificate

The DAS Y calibration certificates are shown as follows.