

14. ANTENNA LOCATIONS AND SEPARATION DISTANCES

Laptop Mode

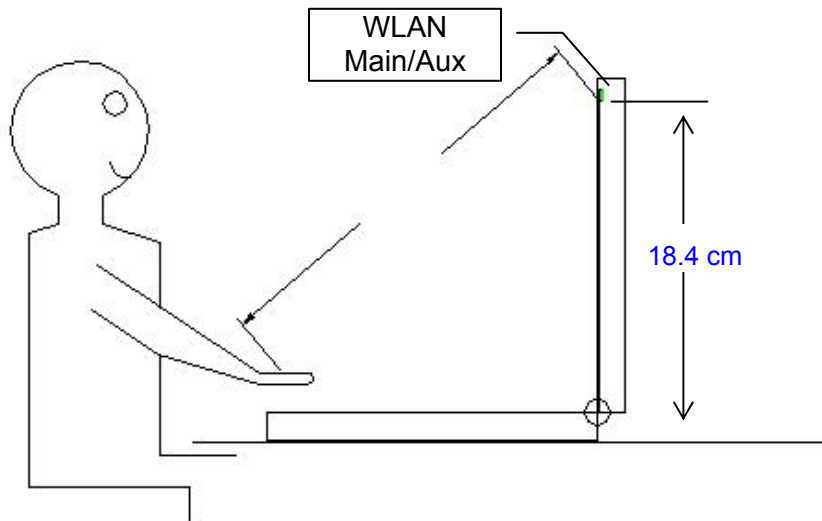

Tablet – Bottom Face

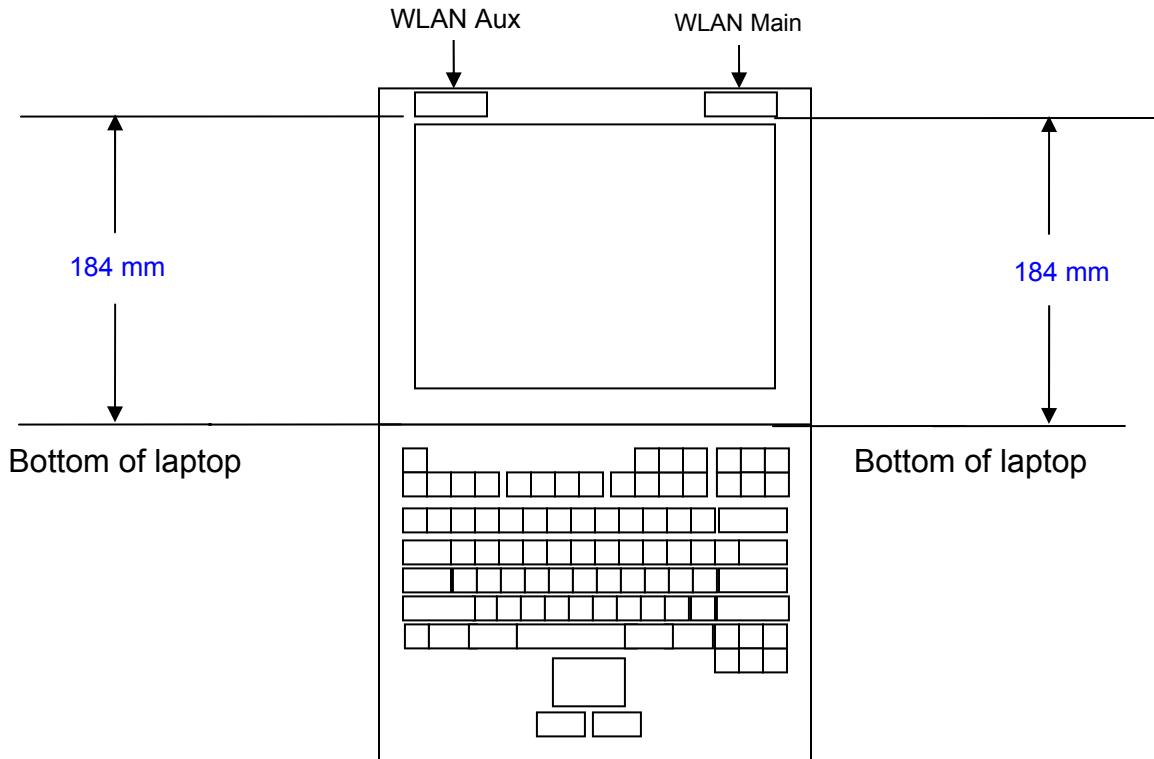
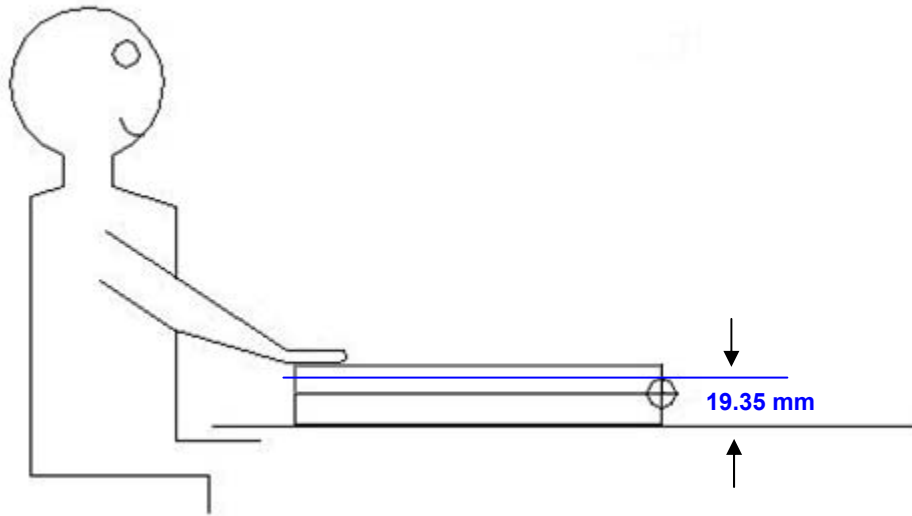

Tablet – Edges (Landscape & Portrait)

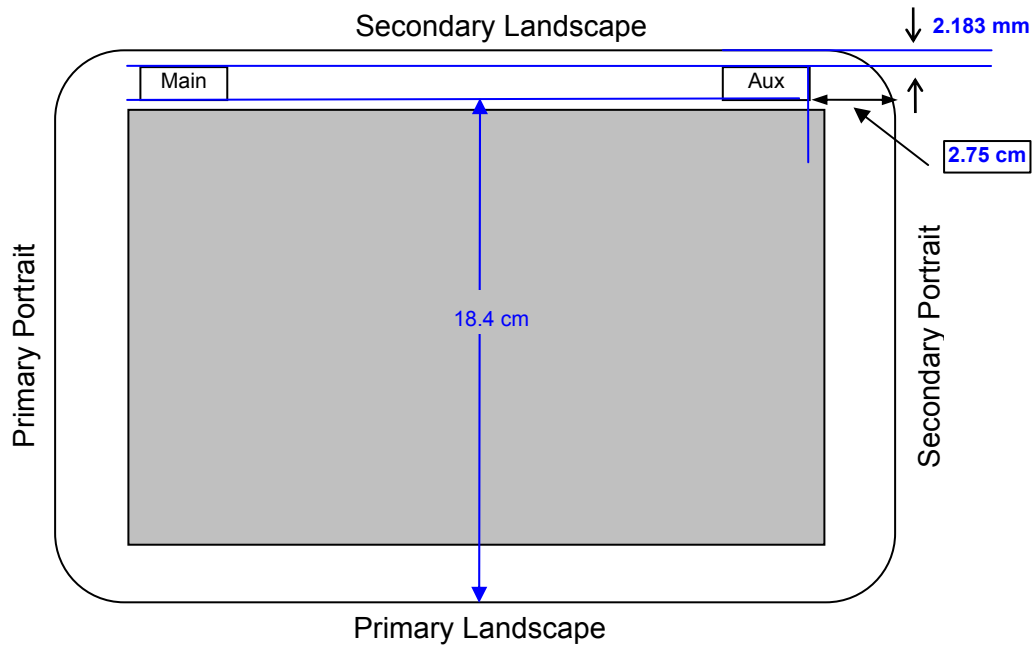

15. TEST SETUP PHOTOS

Laptop - Lap-held

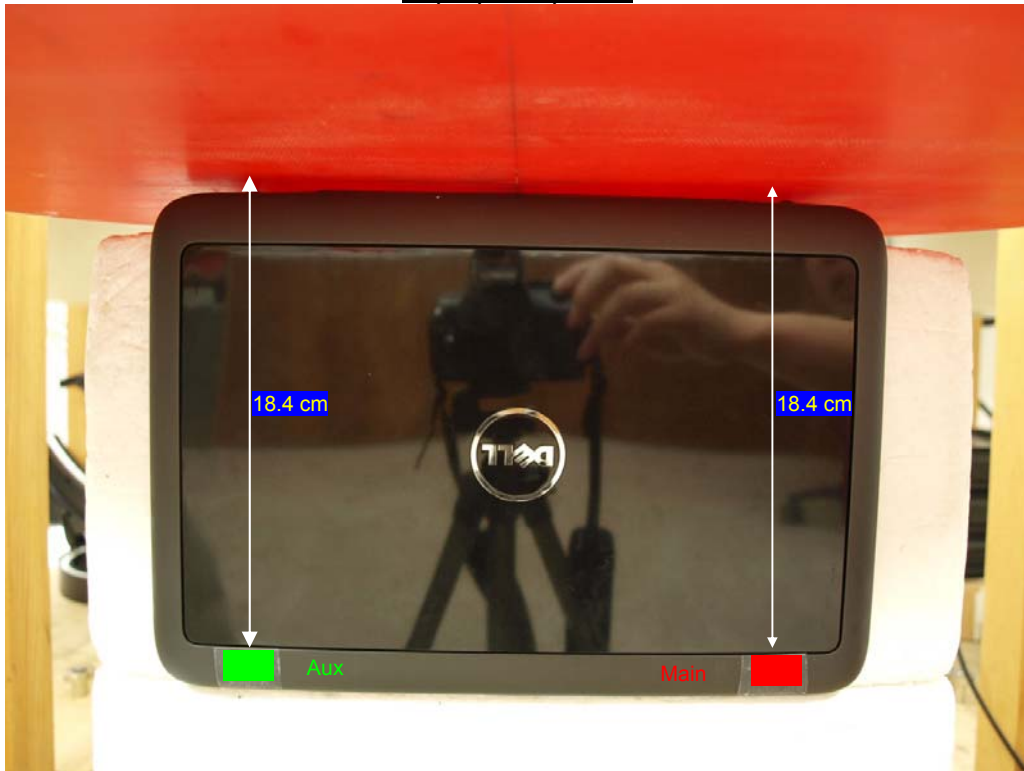

Tablet - Bottom face

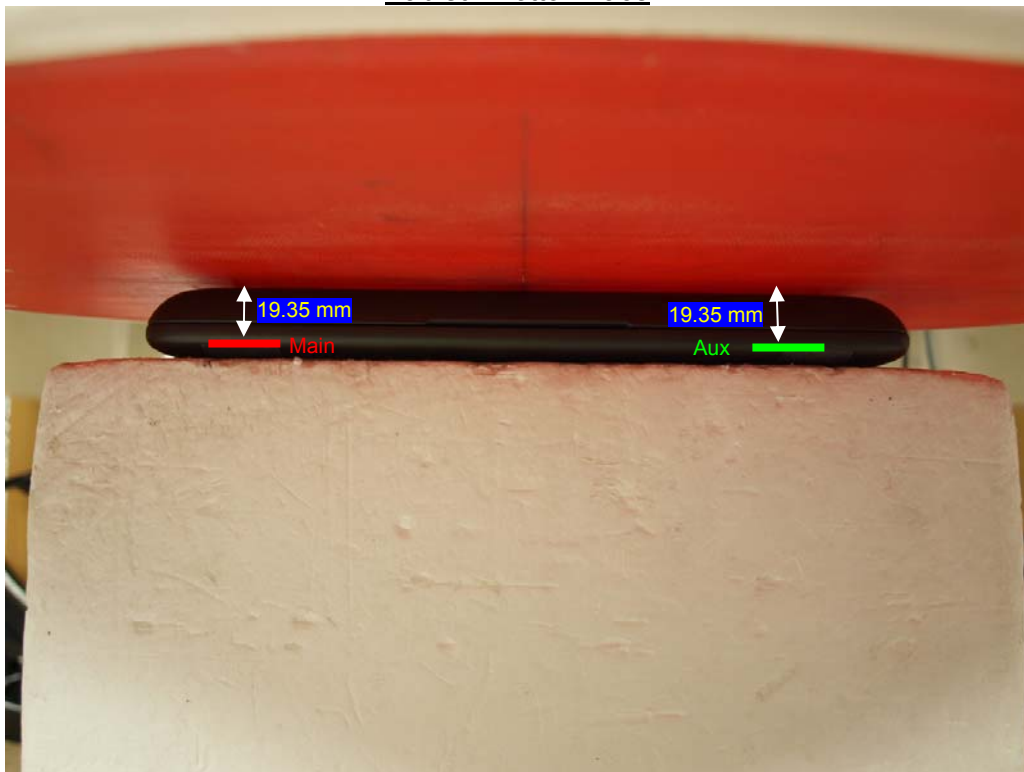

Tablet - Edge: Primary Landscape (No SAR due to large distance)

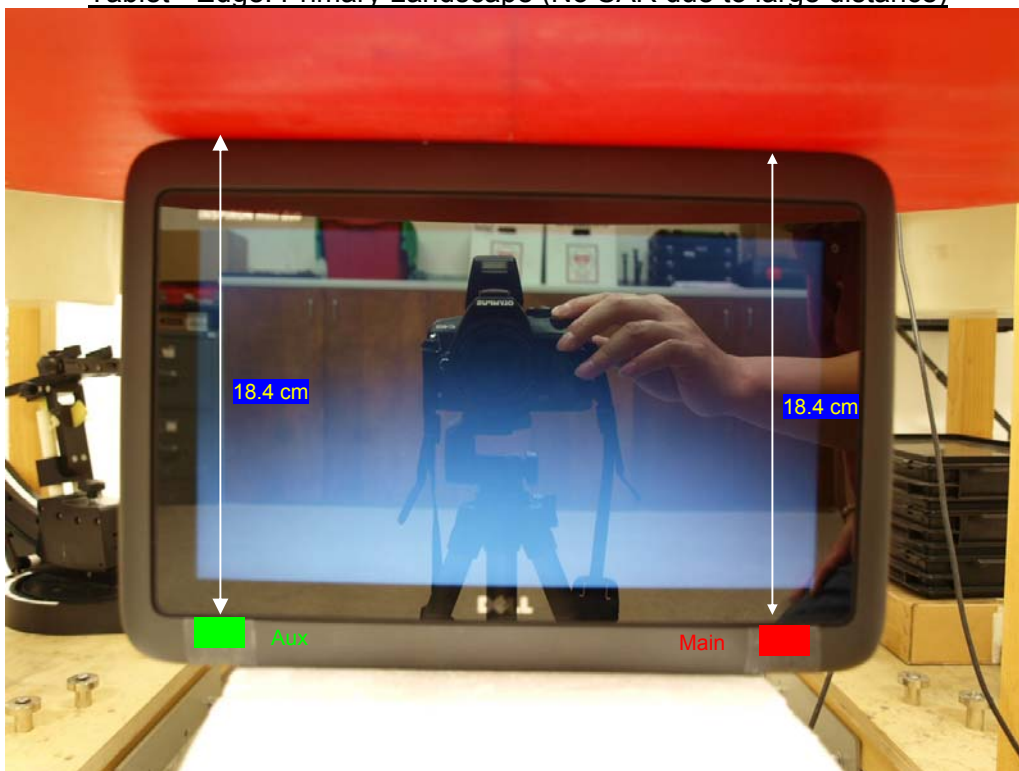

Tablet - Edge: Secondary Landscape



Tablet - Edge - Primary Portrait (SAR test at Aux antenna)

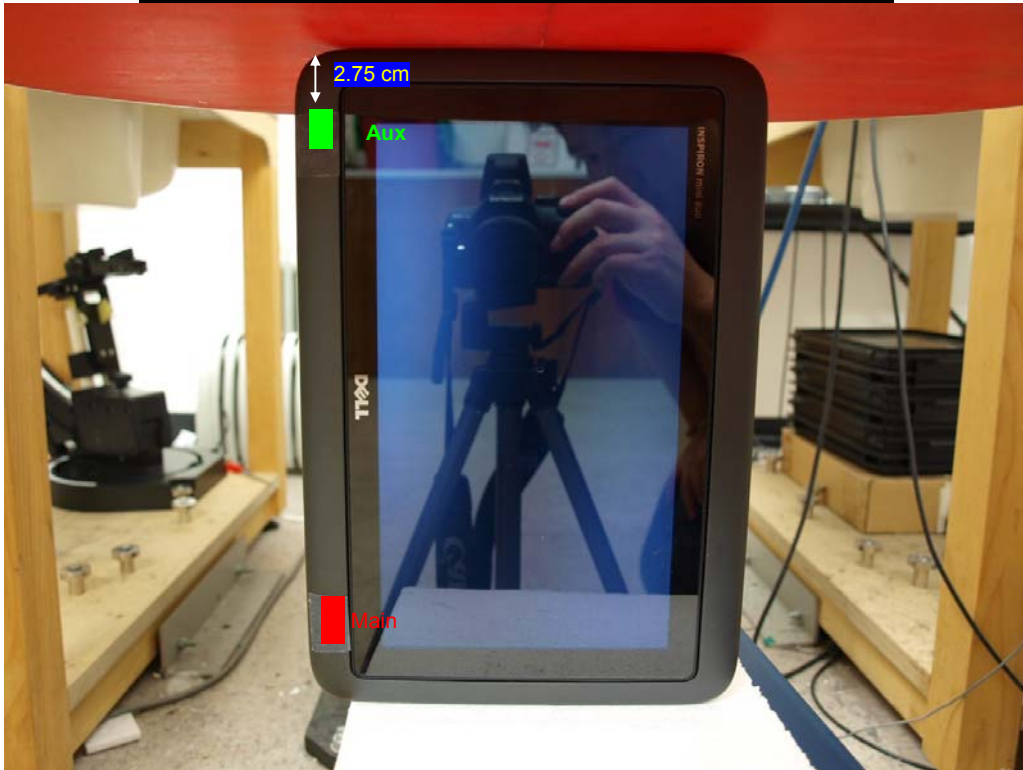

Tablet - Edge - Secondary Portrait (SAR test at Main antenna)

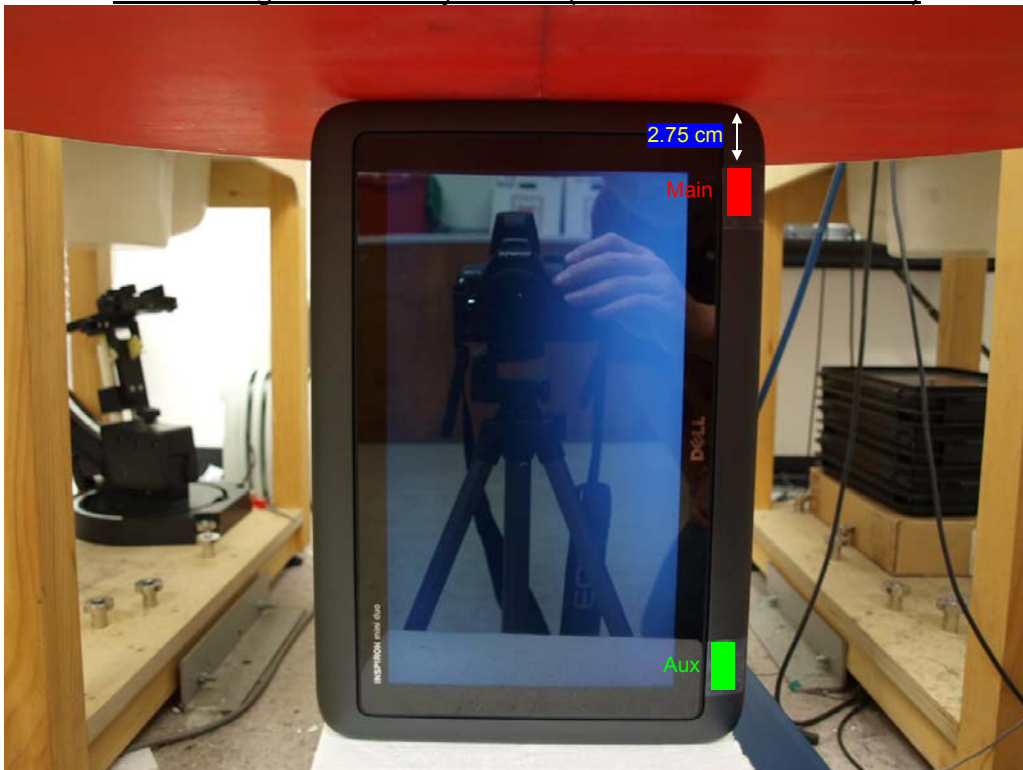

16. HOST DEVICE PHOTOS

Laptop Mode



Tablet Mode - Front View



Tablet Mode - Bottom View



END OF REPORT