

Regulatory WLAN Antenna Information

Platform	
Platform Owner	
Brand Name	DELL
Model Name	Pacino
ODM	Quanta
Target Launch Date	(YYYY/ MM/ DD)
Antenna	
Brand Name	ACON
Part Number	<input checked="" type="checkbox"/> Tx1 Antenna: AMP8P-700047
	<input checked="" type="checkbox"/> Tx2 Antenna: AMP8P-700047
	<input checked="" type="checkbox"/> Tx3 (or Rx3) Antenna: AMP8P-700047
Module	
With WLAN Module	<input type="checkbox"/> BCM4312
(Check Box)	<input type="checkbox"/> BCM4322
	<input type="checkbox"/>
	<input type="checkbox"/>

Antenna Sample / Antenna Data

Requirements for worldwide regulatory approval

Section	Description of Required OEM / ODM Antenna Information	US / IC	EU	Japan	Taiwan	S.Korea
1A	Part Number for Antenna only	Required	Required	Required	Required	Required
1B	Antenna Manufacturer Name	Required	Required	Required	Required	Required
1C	Description of Antenna Type	Required	N/A	N/A	N/A	N/A
1D	Part number of Antenna Assembly / cable impedance, length & diameter.	Required	Desired	Desired	Desired	Desired
1E	Tx1, Tx2 & Tx3 antenna (Peak Gain W/ cable loss) *	Required	Required	Required	Required	Required
	1E OR 1F, 1G, 1H					
1F	Tx1, Tx2 & Tx3 antenna (Peak Gain only) *	Required	Required	Required	Required	Required
1G	VSWR of cable including connector	Required	Required	Required	Required	Required
1H	Tx1, Tx2 & Tx3 antenna (Cable loss W/ connector) *	Required	Required	Required	Required	Required
2	Dimensioned Photographs and Drawings of Tx1, Tx2, and Tx3 (or Rx3) antennas	Required	Required	Required	Required	Required
3	Radiation patterns of antennas loaded in the host platform.	Required	Desired	Required	N/A	Required
4	Platform model name / number - correlated to antenna manufacturer and antenna part number	Required	Required	Desired	Required	Desired
5	Photograph(s) or Drawings showing location of antennas in platform. (S. Korea requires photographs of antennas for approval submission). Taiwan requires pictures of each antenna type shown in the system.	Required	Required	Desired	Required (Photos)	Required (Photos)
6	Mech. drawings / photos with dimensions of antenna locations and distance from end-user (For evaluation of SAR testing requirement).	Required	N/A	N/A	N/A	N/A
7	Photograph(s) or Drawings showing the location of all antennas (WLAN, other) and distance between those transmitting antennas. Information will be used to evaluate whether co-location testing is required.	Required	N/A	N/A	N/A	N/A
8	Local representative contact information for LMA/ PARS process.	Required	N/A	N/A	N/A	N/A

NOTE:

(*) if 3rd antenna is Rx only then peak gain and cable loss not required

Antenna Information

Section 1. Antenna Assembly Specifications

Antenna Assembly Summary:

1A Antenna Part Number	1B Manufacture	1C Antenna Type	1D Cable Assembly Part Number and Information	1E *Peak Gain W/ Cable loss (dBi)	1F Peak Gain w/o Cable Loss (dBi)	1G VSWR	1H Cable Loss (dBi)
AMP8P-700047 Tx1 antenna	ADVANCED-C ONNECTEK INC.	IFA	AMP8P-700047 50 ohm Coaxial. length: 688cm diameter: 1.13mm Connector: I-PEX	2400-2500MHz 0.36 dBi (peak)	2400-2500MHz 2.26 dBi (peak)	2400-2500MHz 2.0 max	2400-2500MHz -1.90 dBi (peak)
				5150-5350MHz -4.23 dBi (peak)	5150-5350MHz -1.57 dBi (peak)	5150-5350MHz 2.0 max	5150-5350MHz -2.66 dBi (peak)
				5470-5725MHz -2.3 dBi (peak)	5470-5725MHz 0.63 dBi (peak)	5470-5725MHz 2.0 max	5470-5725MHz -2.93 dBi (peak)
				5725-5850MHz -1.43 dBi (peak)	5725-5850MHz 1.57 dBi (peak)	5725-5850MHz 2.0 max	5725-5850MHz -3.0 dBi (peak)
AMP8P-700047 Tx2 antenna	ADVANCED-C ONNECTEK INC.	IFA	AMP8P-700047 50 ohm Coaxial. length: 674.5cm diameter: 1.13mm Connector: I-PEX	2400-2500MHz 0.42 dBi (peak)	2400-2500MHz 2.28 dBi (peak)	2400-2500MHz 2.0 max	2400-2500MHz -1.86 dBi (peak)
				5150-5350MHz -2.04 dBi (peak)	5150-5350MHz 0.57 dBi (peak)	5150-5350MHz 2.0 max	5150-5350MHz -2.61 dBi (peak)
				5470-5725MHz -1.95 dBi (peak)	5470-5725MHz 0.93 dBi (peak)	5470-5725MHz 2.0 max	5470-5725MHz -2.88 dBi (peak)
				5725-5850MHz -2.32 dBi (peak)	5725-5850MHz 0.62 dBi (peak)	5725-5850MHz 2.0 max	5725-5850MHz -2.94 dBi (peak)
AMP8P-700047 Tx3 (or Rx3) antenna	ADVANCED-C ONNECTEK INC.	IFA	AMP8P-700047 50 ohm Coaxial. length: 434cm diameter: 1.13mm Connector: I-PEX	2400-2500MHz -0.54 dBi (peak) *	2400-2500MHz 0.66 dBi (peak) *	2400-2500MHz 2.0 max	2400-2500MHz -1.20 dBi (peak) *
				5150-5350MHz -0.96 dBi (peak) *	5150-5350MHz 0.72 dBi (peak) *	5150-5350MHz 2.0 max	5150-5350MHz -1.68 dBi (peak) *
				5470-5725MHz 0.09 dBi (peak) *	5470-5725MHz 1.94 dBi (peak) *	5470-5725MHz 2.0 max	5470-5725MHz -1.85 dBi (peak) *
				5725-5850MHz 0.88 dBi (peak) *	5725-5850MHz 2.77 dBi (peak) *	5725-5850MHz 2.0 max	5725-5850MHz -1.89 dBi (peak) *

NOTE:

(*) If Rx3 only then the information marked with * is not required

Antenna Peak Gain Table:

Frequency (MHz)	Tx1 antenna		Tx2 Antenna		Tx3 (or Rx3) Antenna	
	Horizontal (dBi)	Vertical (dBi)	Horizontal (dBi)	Vertical (dBi)	Horizontal (dBi)	Vertical (dBi)
2412	-3.54	-2.99	-0.77	-0.1	-1.58	-1.32
2437	-1.36	-0.48	0.26	1.07	-0.54	-1.21
2462	-1.22	0.36	-0.68	0.42	-1.65	-2.15
5150	-5.52	-4.63	-2.04	-3.36	-2.28	-2.28
5350	-4.23	-5.79	-2.25	-2.62	-0.96	-2.07
5470	-4.06	-4.04	-1.95	-3	0.09	-3.15
5725	-2.44	-2.3	-2.32	-2.9	-0.23	-1.71
5875	-1.43	-2.99	-2.69	-4.44	0.88	-1.35

- Antenna Peak Gain required being test in system basis.
- 1E frame contend absolutely peak antenna gain include H/V
- If Rx3 only then the information is not required for Rx3.

Section 2. Dimensioned Photos or Drawings of Antennas

Include a dimensioned photo and dimensioned drawing of Tx1 antenna here.

Tx1 Antenna Dimensioned Drawing:

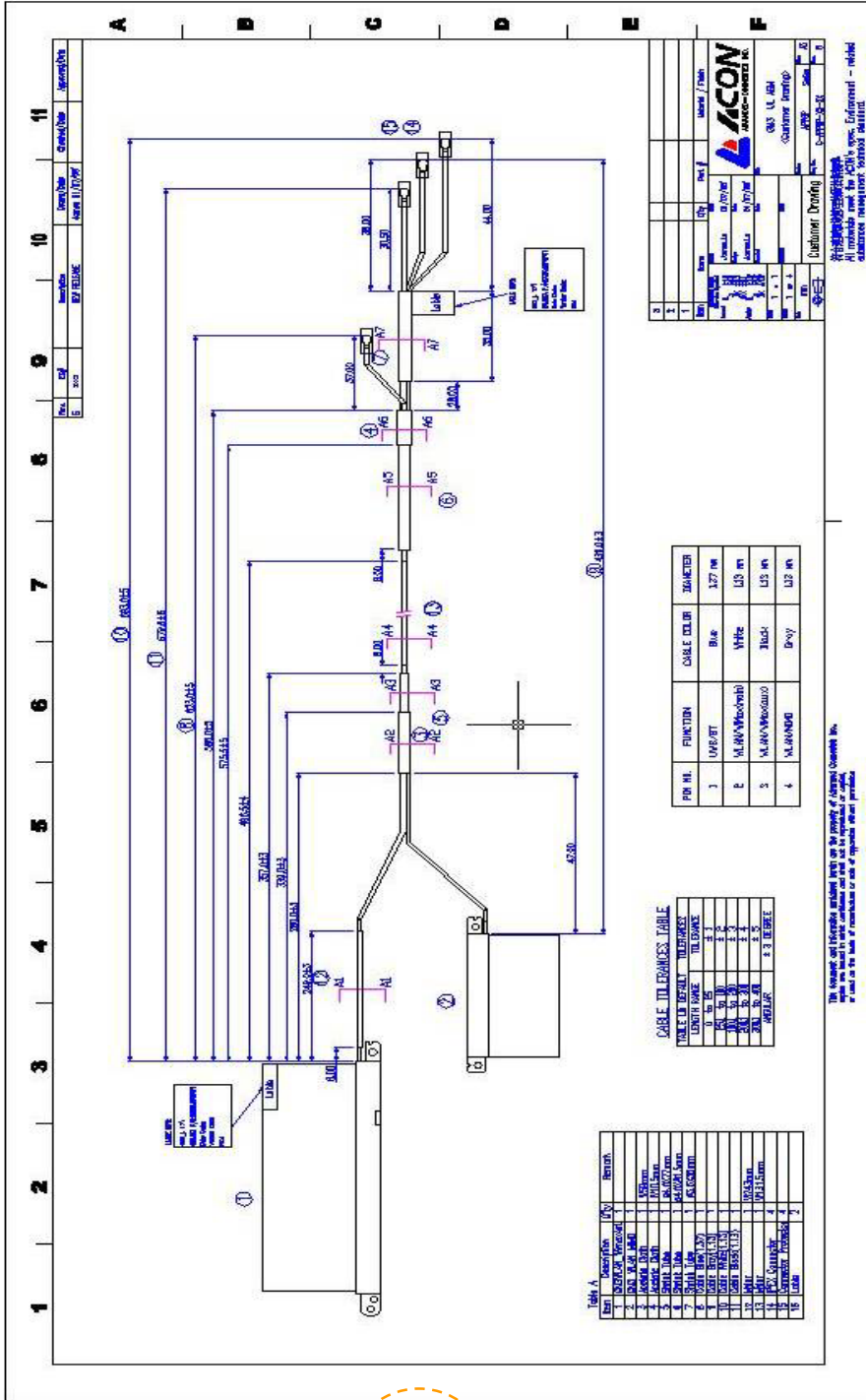

Tx1 Antenna Photo:



Include a dimensioned photo and dimensioned drawing of Tx2 antenna here.

Tx2 Antenna Dimensioned Drawing:

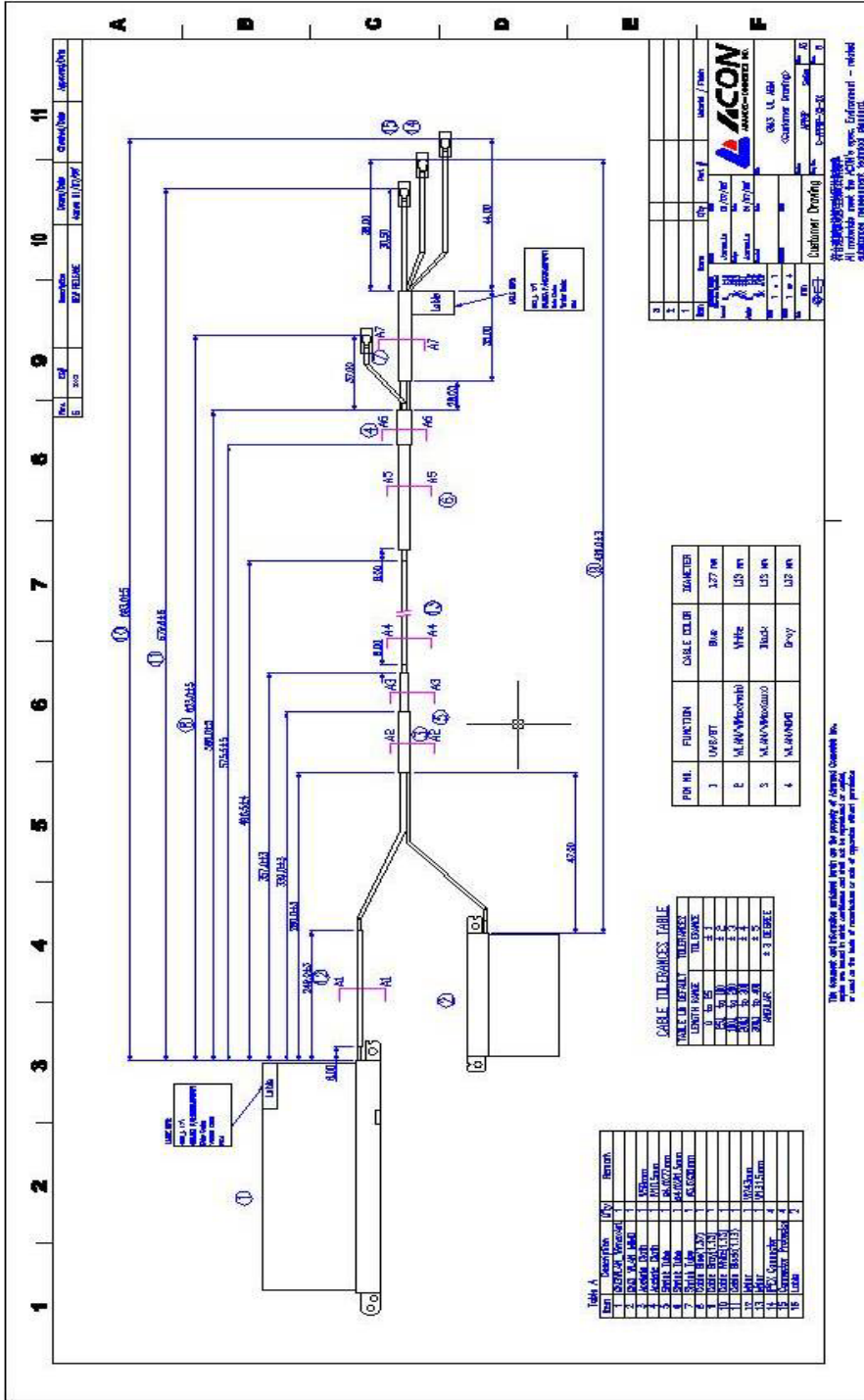

Tx2 Antenna Photo:



Include a dimensioned photo and dimensioned drawing of Tx3 (or Rx3) antenna here.

Tx3 (or Rx3) Antenna Dimensioned Drawing:

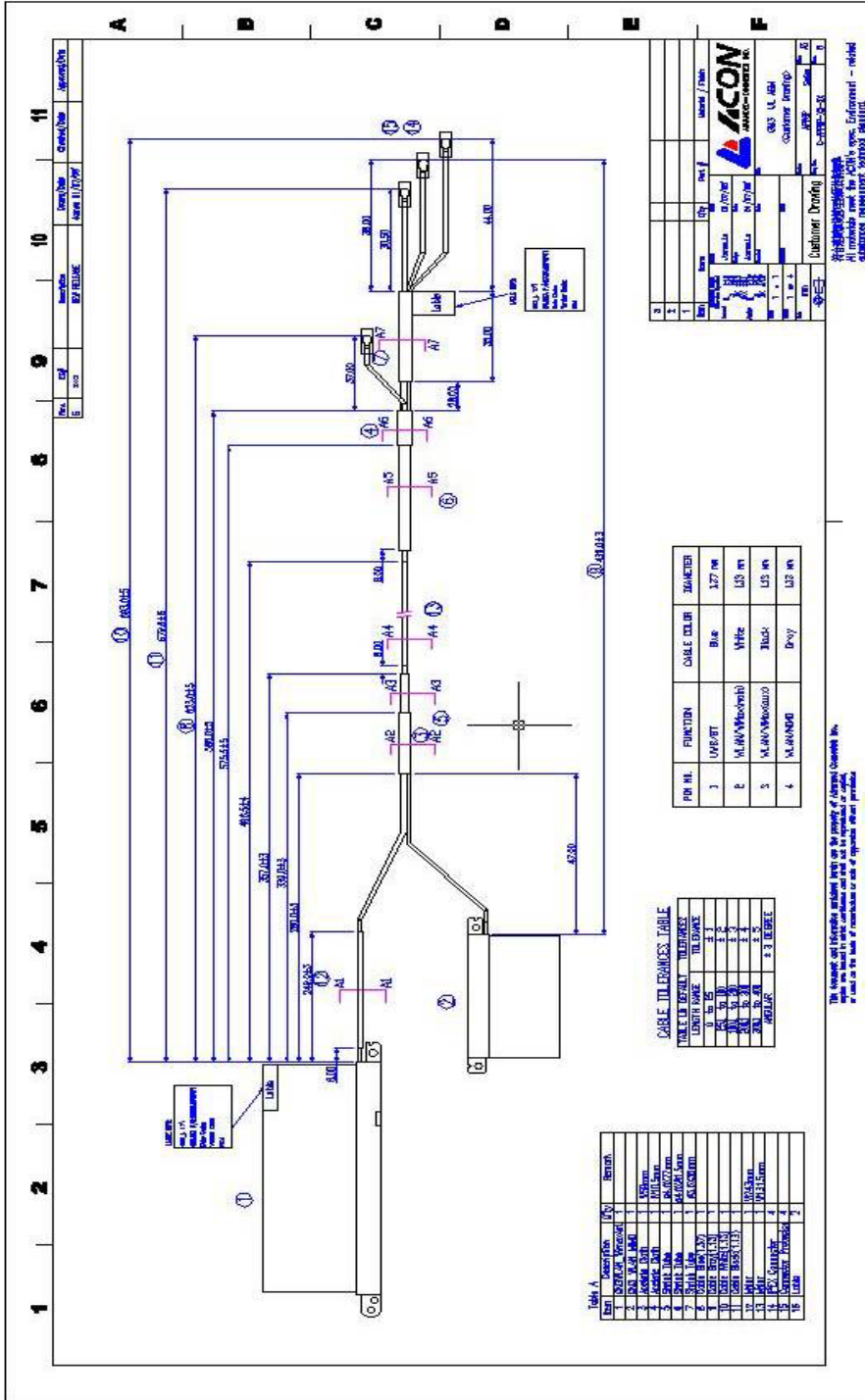

Tx3 (or Rx3) Antenna Photo:



Section 3. Radiation characteristics of antennae Loaded in Host Platform

2412-2462MHz radiation characteristic

Tx1 antenna: 2412 MHz

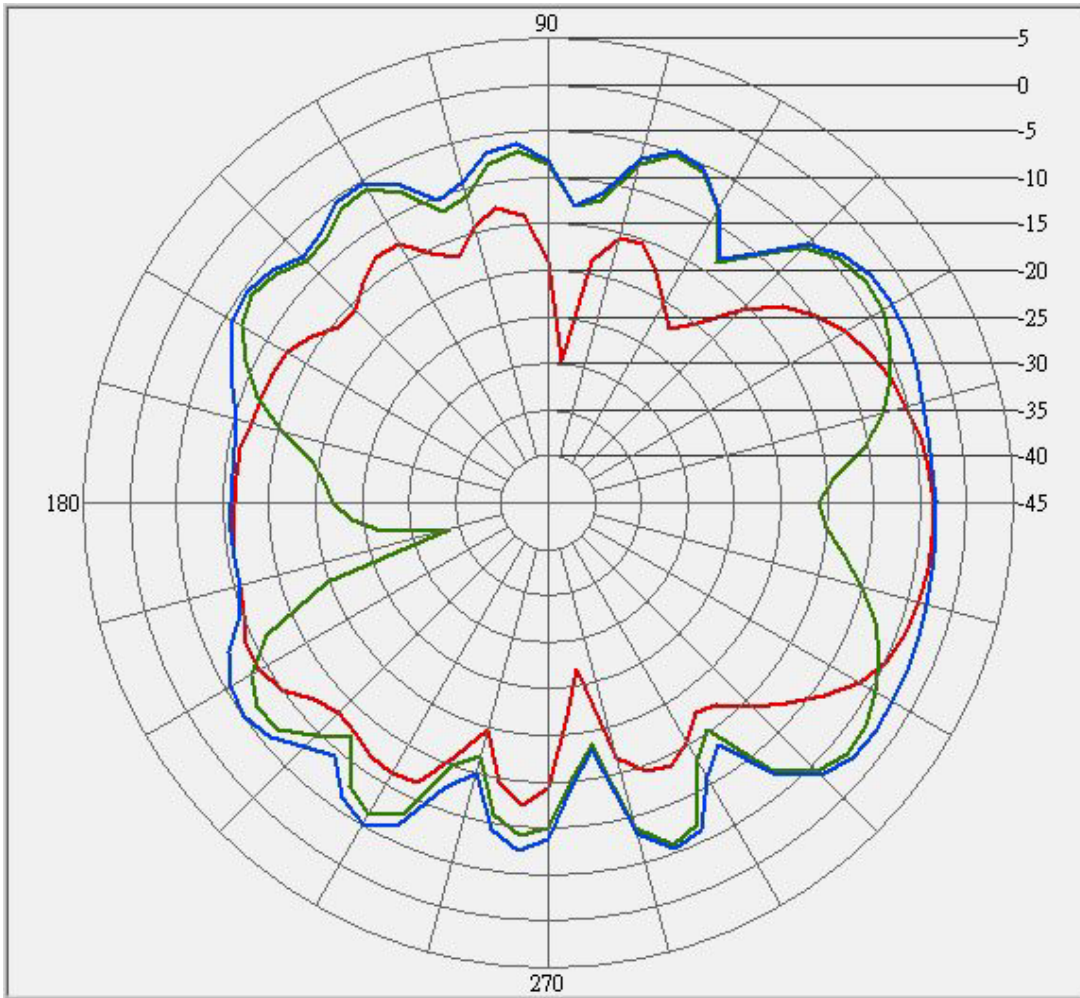

Center Frequency	2412 MHz
Horizontal (dBi) peak	-3.54
Vertical (dBi) peak	-2.99

Tx1 antenna: 2437 MHz

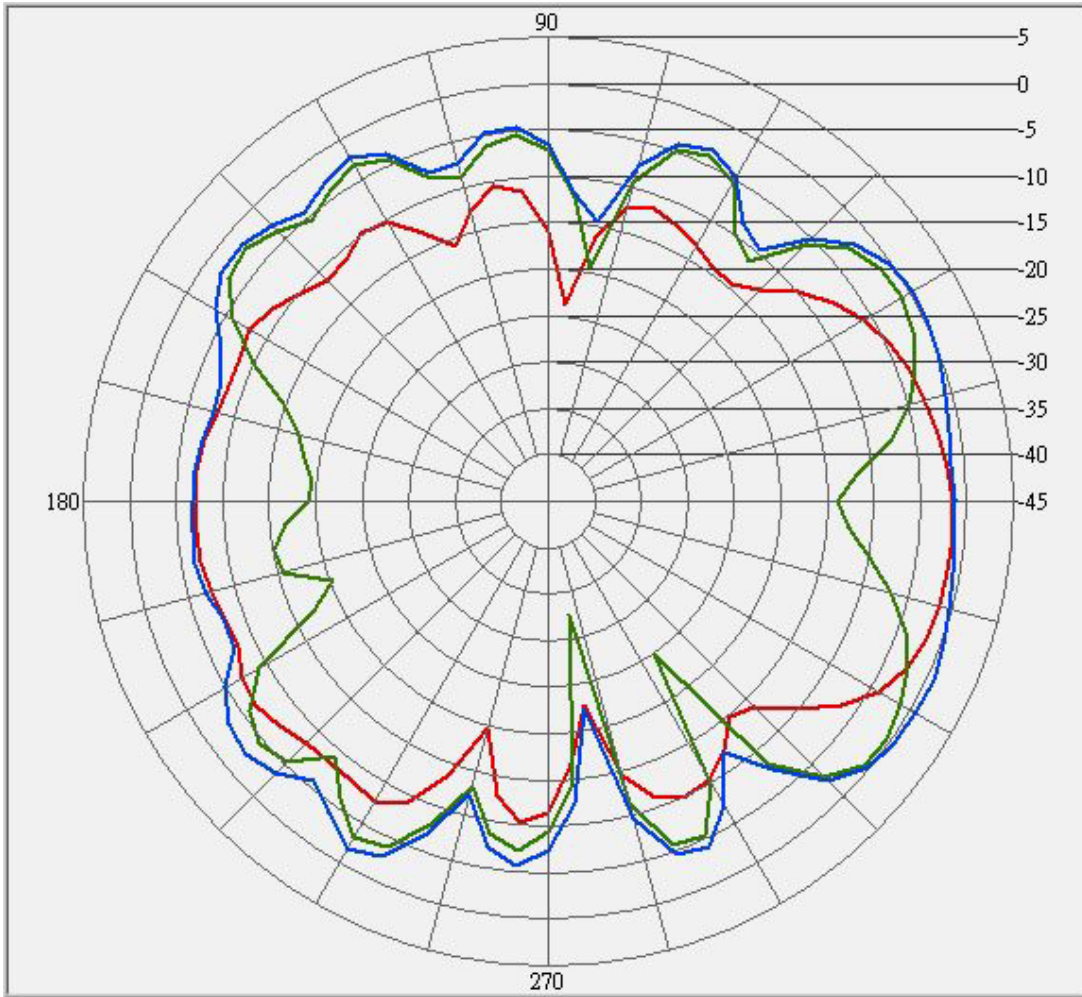

Center Frequency	2437 MHz
Horizontal (dBi) peak	-1.36
Vertical (dBi) peak	-0.48

Tx1 antenna: 2462 MHz

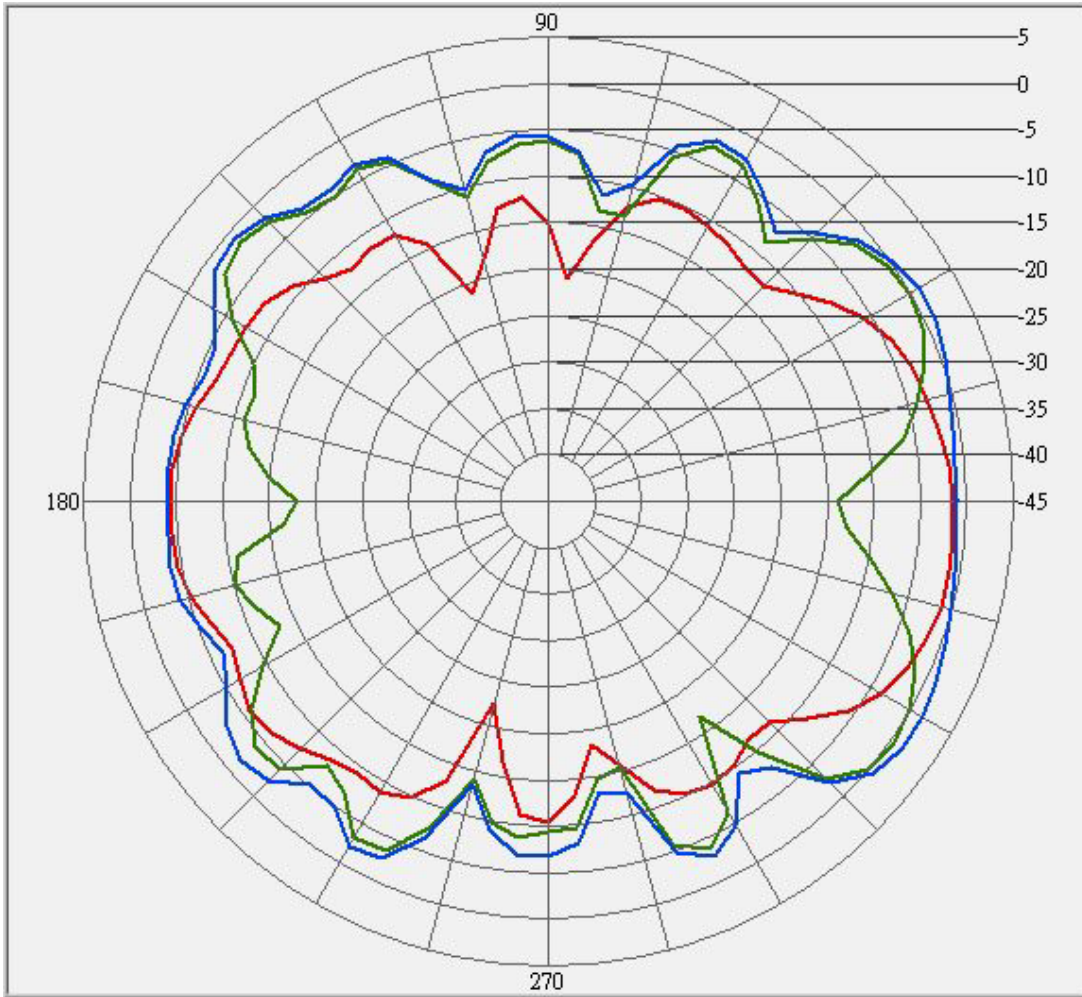

Center Frequency	2462 MHz
Horizontal (dBi) peak	-1.22
Vertical (dBi) peak	0.36

Tx2 antenna: 2412 MHz

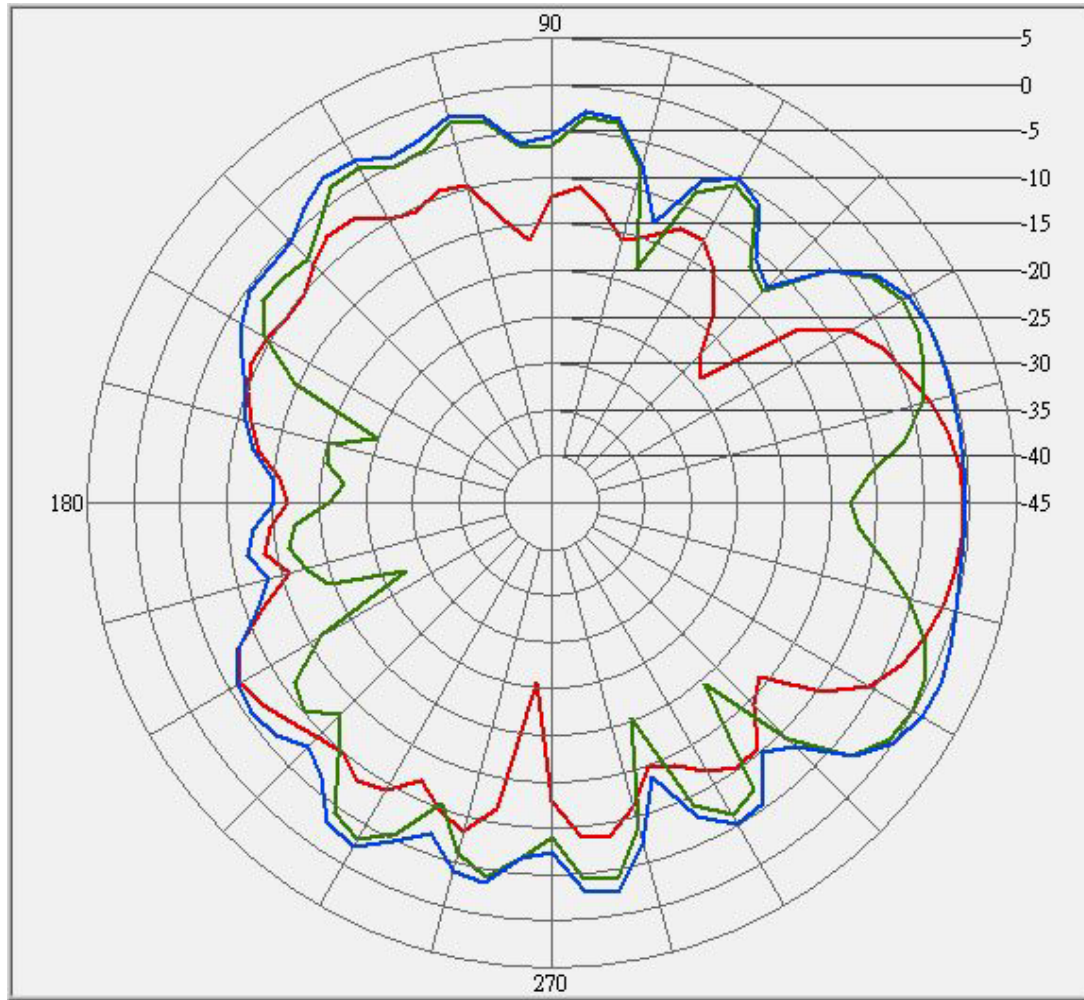

Center Frequency	2412 MHz
Horizontal (dBi) peak	-0.77
Vertical (dBi) peak	-0.1

Tx2 antenna: 2437 MHz

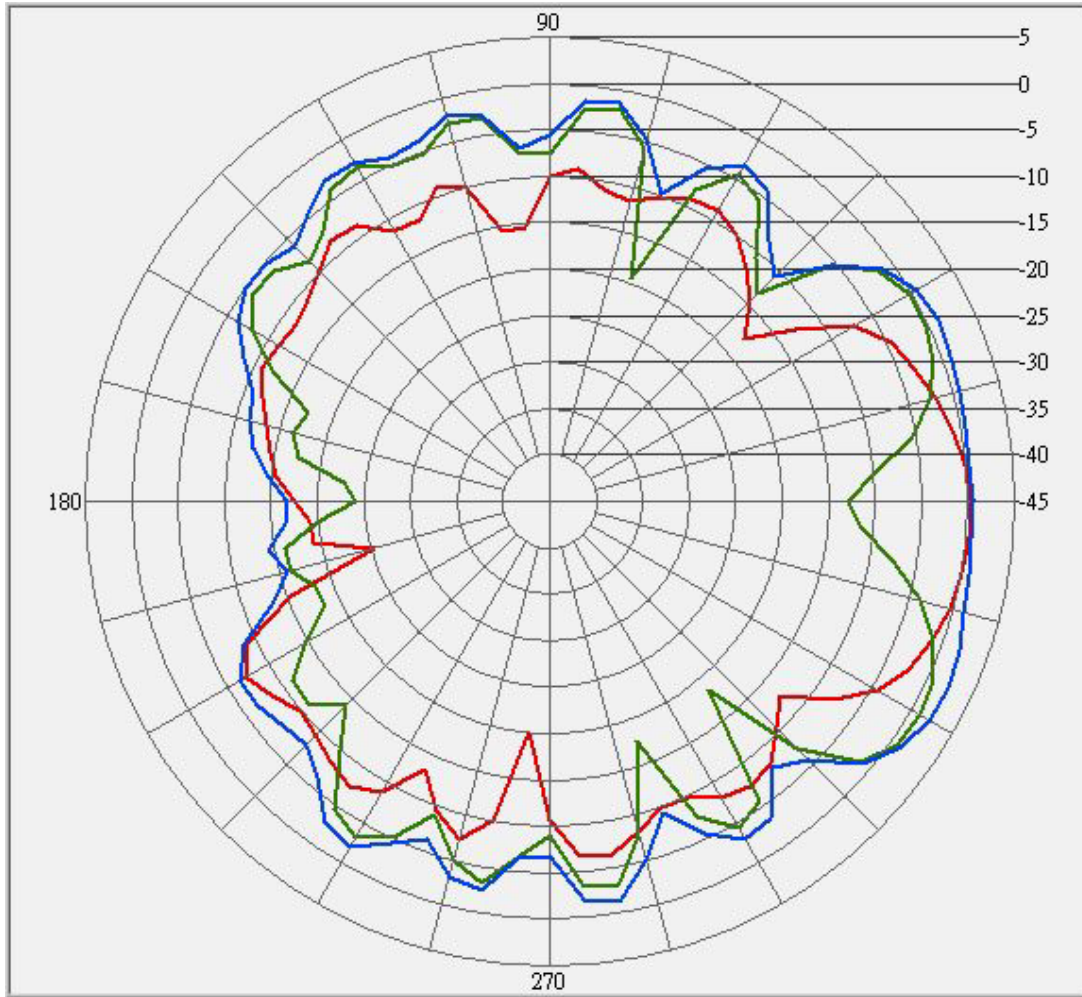

Center Frequency	2437 MHz
Horizontal (dBi) peak	0.26
Vertical (dBi) peak	1.07

Tx2 antenna: 2462 MHz

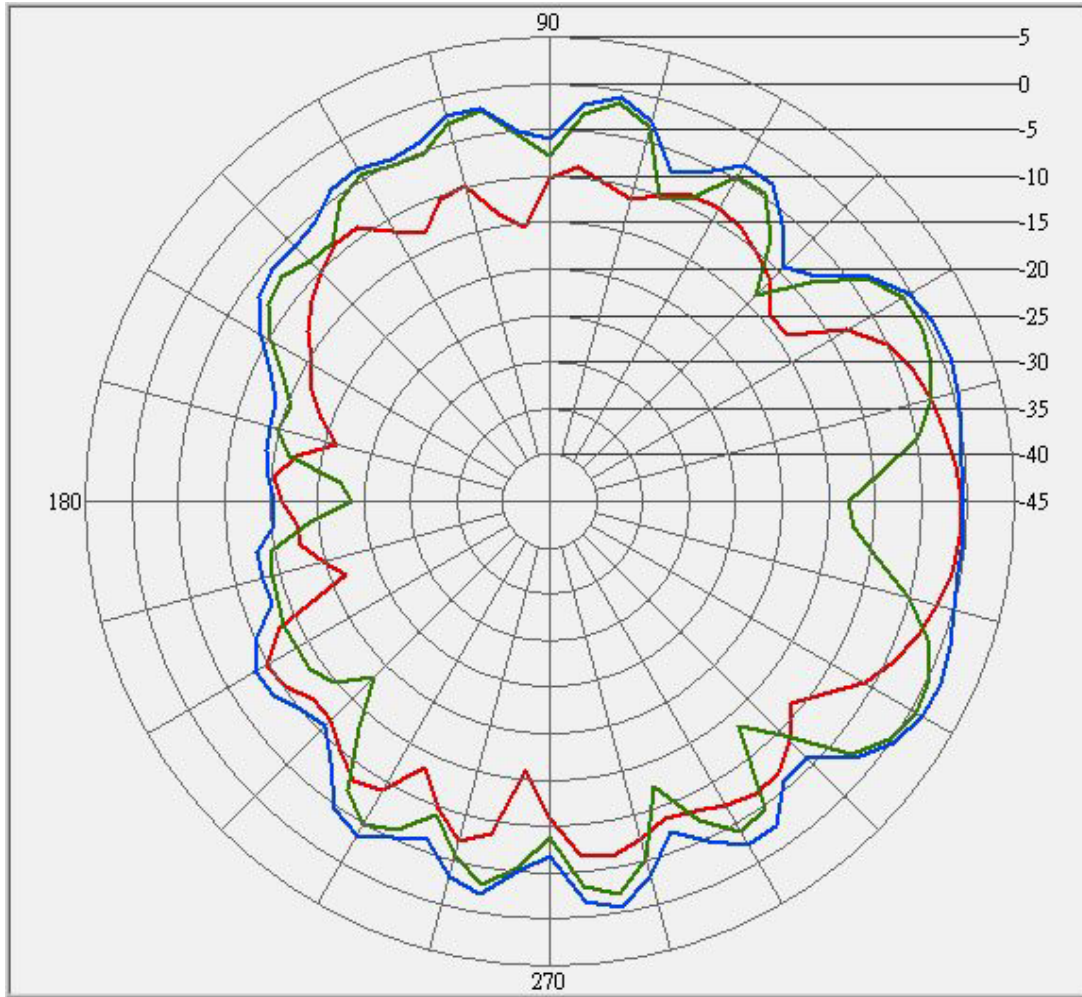

Center Frequency	2462 MHz
Horizontal (dBi) peak	-0.68
Vertical (dBi) peak	0.42

Tx3 (or Rx3) antenna: 2412 MHz (Plot is not required if 3rd Antenna is receive only)

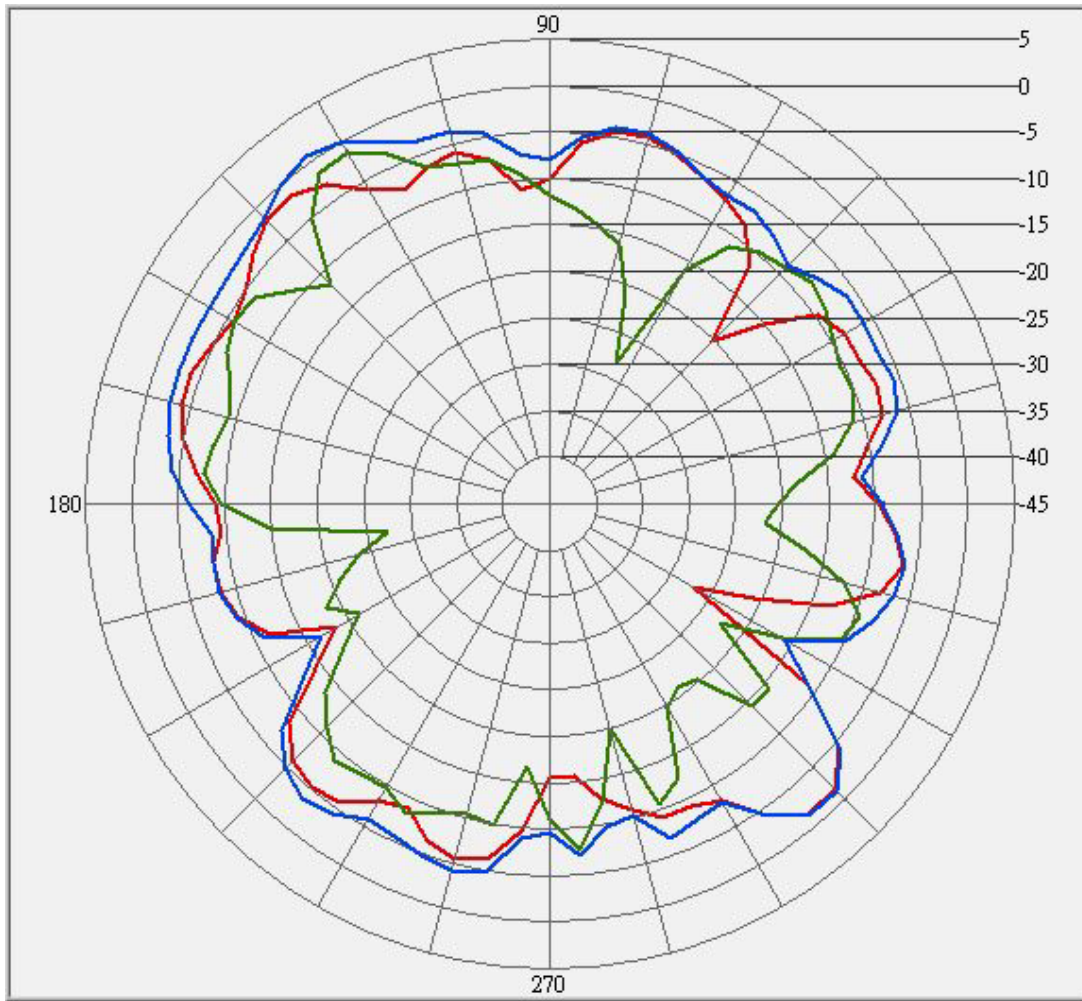

Center Frequency	2412 MHz
Horizontal (dBi) peak	-1.58
Vertical (dBi) peak	-1.32

Tx3 (or Rx3) antenna: 2437 MHz (Plot is not required if 3rd Antenna is receive only)

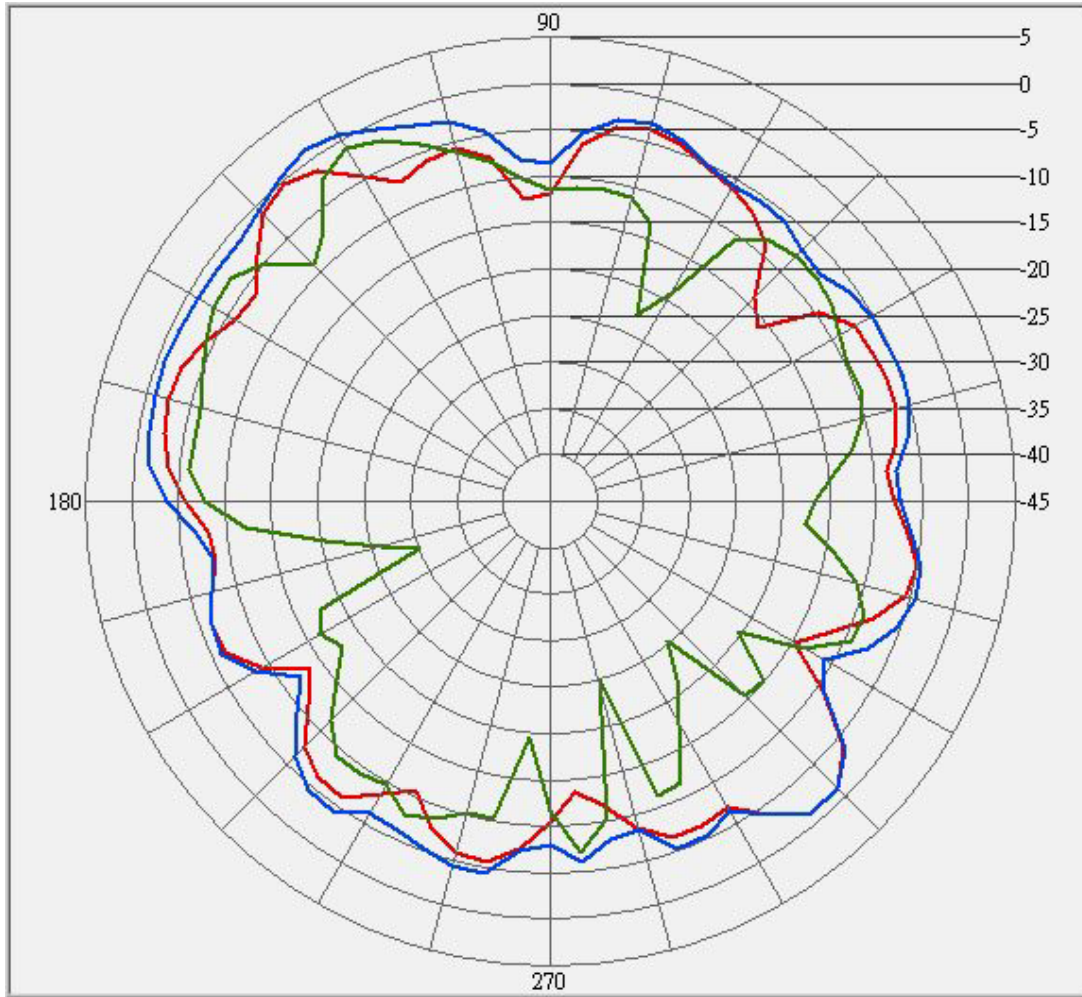

Center Frequency	2437 MHz
Horizontal (dBi) peak	-0.54
Vertical (dBi) peak	-1.21

Tx3 (or Rx3) antenna: 2462 MHz (Plot is not required if 3rd Antenna is receive only)

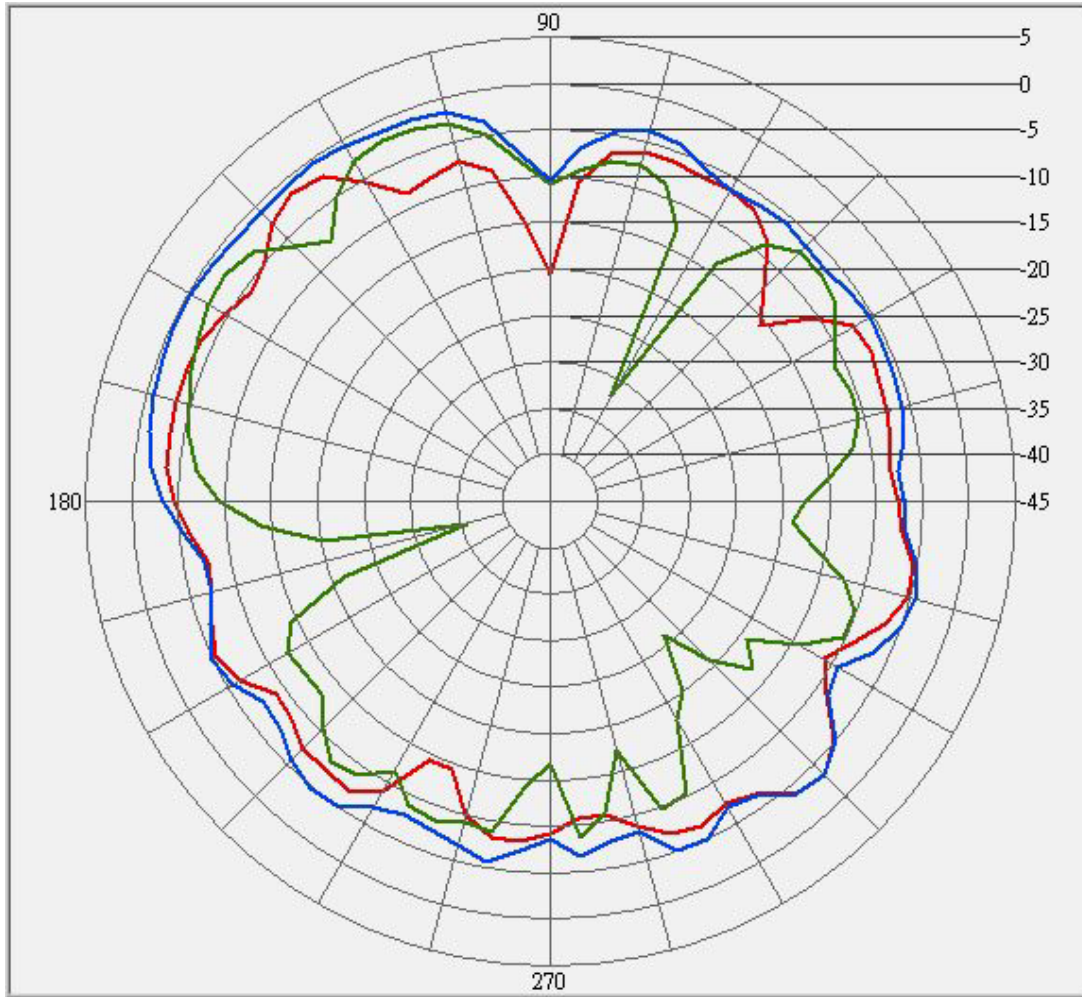

Center Frequency	2462 MHz
Horizontal (dBi) peak	-1.65
Vertical (dBi) peak	-2.15

5150-5350 MHz radiation characteristic

Tx1 antenna: 5150 MHz

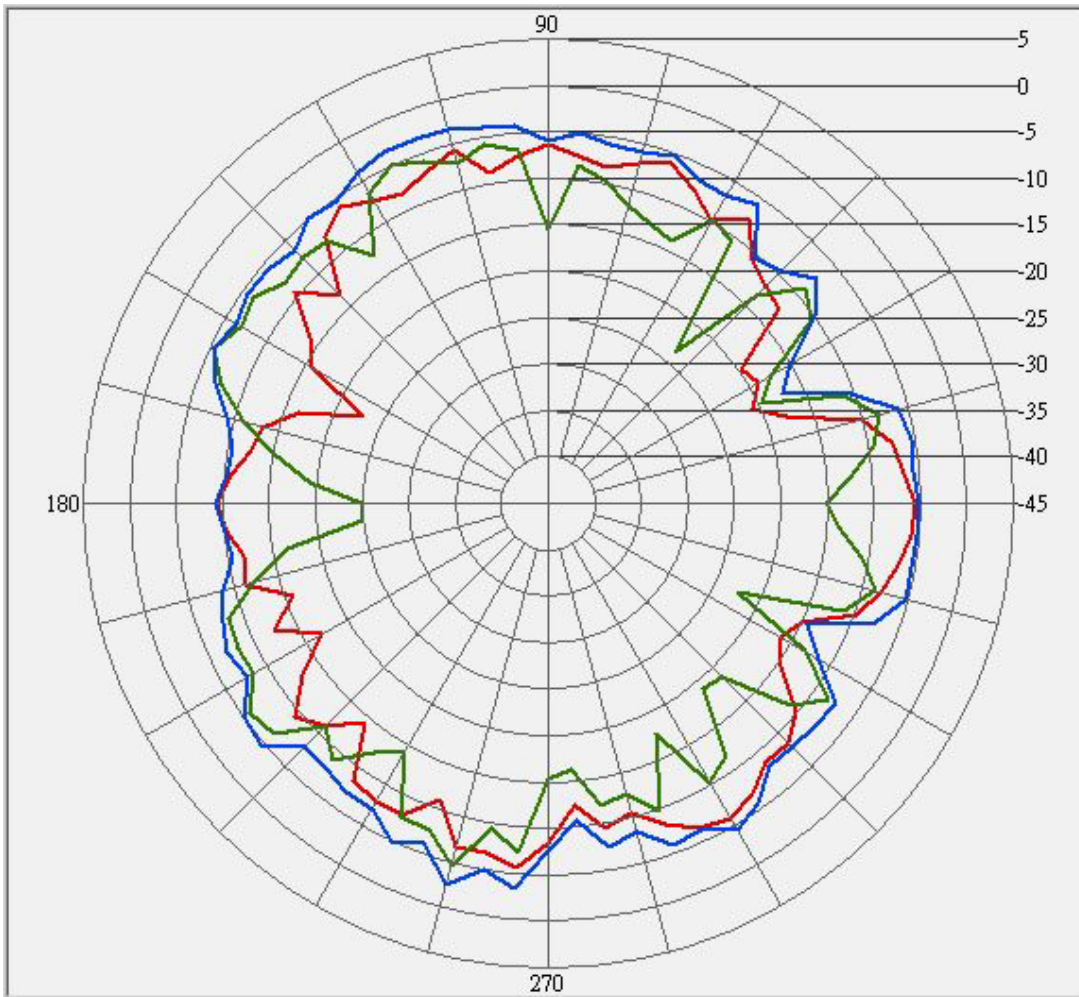

Center Frequency	5150 MHz
Horizontal (dBi) peak	-5.52
Vertical (dBi) peak	-4.63

Tx1 antenna: 5350 MHz

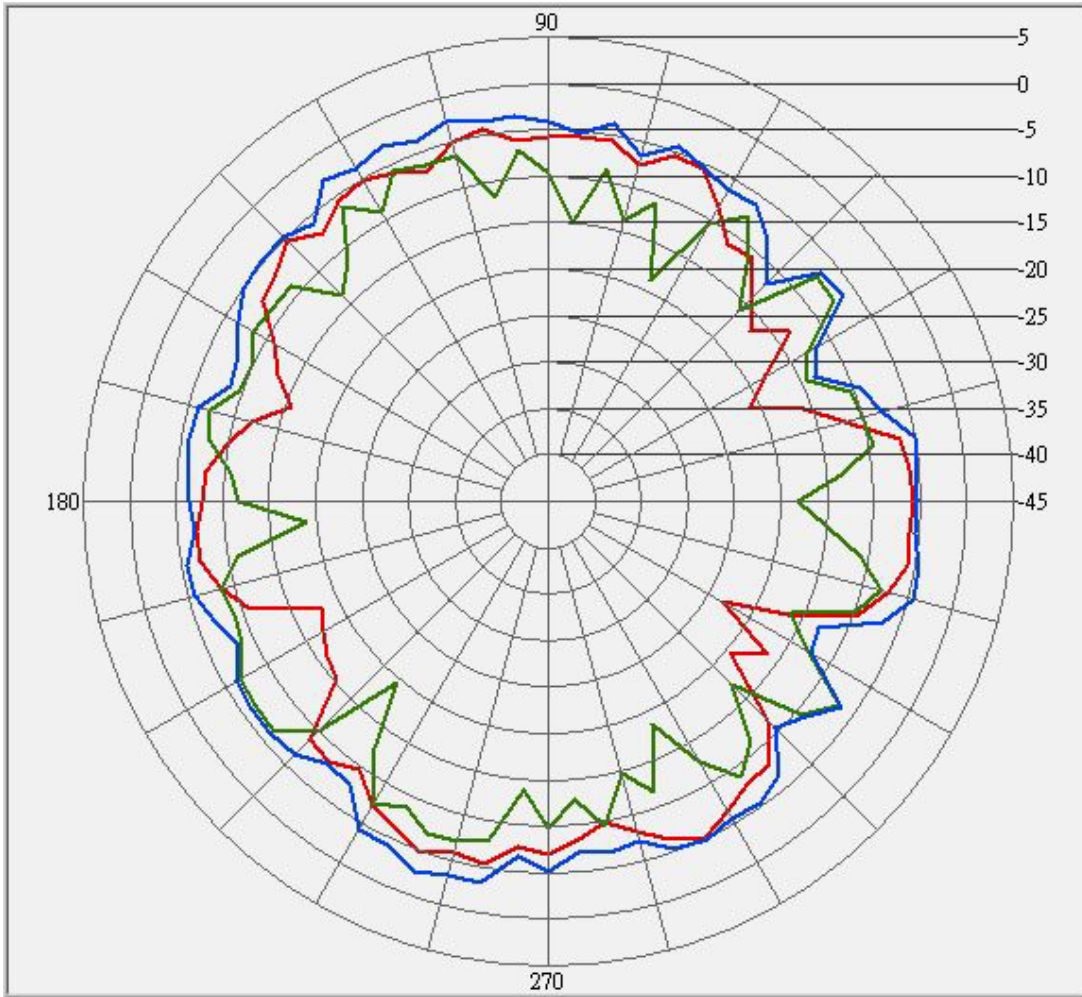

Center Frequency	5350 MHz
Horizontal (dBi) peak	-4.23
Vertical (dBi) peak	-5.79