



HP EliteBook 2740p User Guide

Antenna House XSL Formatter

© Copyright 2010 Hewlett-Packard Development Company, L.P.

Product notice

This user guide describes features that are common to most models. Some features may not be available on your computer.

Bluetooth is a trademark owned by its proprietor and used by Hewlett-Packard Company under license. Intel is a trademark of Intel Corporation in the U.S. and other countries or regions. Java is a U.S. trademark of Sun Microsystems, Inc. Microsoft, Windows, and Windows Vista are U.S. registered trademarks of Microsoft Corporation. SD Logo is a trademark of its proprietor.

The information contained herein is subject to change without notice. The only warranties for HP products and services are set forth in the express warranty statements accompanying such products and services. Nothing herein should be construed as constituting an additional warranty. HP shall not be liable for technical or editorial errors or omissions contained herein.

First Edition: February 2010

Document Part Number: 599104-001

Safety warning notice

⚠ WARNING! To reduce the possibility of heat-related injuries or of overheating the computer, do not place the computer directly on your lap or obstruct the computer air vents. Use the computer only on a hard, flat surface. Do not allow another hard surface, such as an adjoining optional printer, or a soft surface, such as pillows or rugs or clothing, to block airflow. Also, do not allow the AC adapter to contact the skin or a soft surface, such as pillows or rugs or clothing, during operation. The computer and the AC adapter comply with the user-accessible surface temperature limits defined by the International Standard for Safety of Information Technology Equipment (IEC 60950).

Antenna House XSL Formatter

Table of contents

1 Features

Identifying hardware	1
Top components	1
Pointing devices	1
Lights	3
Buttons and switches	4
Keys	5
Front components	6
Right-side components	7
Left-side components	8
Rear components	9
Bottom components	10
Display	11
Wireless antennas (select models only)	12
Additional hardware components	13
Identifying the labels	14

2 Using the tablet

Tablet display components	15
Rotating the display	16
Tablet mode	16
Notebook mode	18

3 Wireless, modem, and local area network

Using wireless devices (select models only)	20
Identifying wireless and network icons	21
Using the wireless controls	21
Using the wireless button	21
Using Wireless Assistant software (select models only)	22
Using HP Connection Manager (select models only)	22
Using operating system controls	23
Using a WLAN	24
Setting up a WLAN	24
Protecting your WLAN	24

Connecting to a WLAN	25
Roaming to another network	26
Using HP Mobile Broadband (select models only)	27
Inserting a SIM	27
Removing a SIM	28
Using Bluetooth wireless devices (select models only)	30
Bluetooth and Internet Connection Sharing (ICS)	30
Troubleshooting wireless connection problems	31
Cannot create a WLAN connection	31
Cannot connect to a preferred network	32
Network icon is not displayed	32
Current network security codes are unavailable	32
WLAN connection is very weak	33
Cannot connect to the wireless router	33
Using the modem (select models only)	34
Connecting a modem cable	34
Connecting a country-specific modem cable adapter	34
Selecting a location setting	35
Viewing the current location selection	35
Adding new locations when traveling	36
Solving travel connection problems	37
Connecting to a local area network (LAN)	39

4 Pointing devices and keyboard

Using pointing devices	40
Setting pointing device preferences	40
Using the TouchPad	40
Using the pointing stick	40
Connecting an external mouse	40
Using the keyboard	40
Using the keyboard light	40
Using hotkeys	42
Displaying system information	42
Initiating Sleep	43
Switching the screen image	43
Viewing battery charge information	44
Enabling/disabling the TouchPad (fn+f5)	44
Decreasing screen brightness	44
Increasing screen brightness	44
Activating the ambient light sensor	44
Using QuickLook (select models only)	45
Installing QuickLook	45
Using HP Quick Launch Buttons	46

Opening the Quick Launch Buttons control panel	47
Using HP QuickLook 3	48
Using the pen	48
Identifying the pen components	48
Holding the pen	48
Performing mouse clicks with the pen	49
Performing other procedures with the pen	49
Pressure sensitivity	49
Calibrating the pen	50
Using the pen holder	50
Setting pen preferences	51
Using the embedded numeric keypad	51
Using the embedded numeric keypad	51
Enabling and disabling the embedded numeric keypad	51
Switching key functions on the embedded numeric keypad	51
Cleaning the TouchPad and keyboard	52

5 Multimedia

Multimedia features	53
Adjusting the volume	53
Multimedia software	54
Accessing your preinstalled multimedia software	55
Installing your preloaded multimedia software	55
Installing multimedia software from a disc	55
Audio	56
Connecting external audio devices	56
Checking your audio functions	56
Video	58
Connecting an external monitor or projector	58
Using the external monitor port	58
Using the DreamColor display (select models only)	58
Webcam	59
Webcam tips	59
Adjusting webcam properties	59
Capturing business card images	60

6 Power management

Setting power options	62
Using power-saving states	62
Initiating and exiting Sleep	62
Initiating and exiting Hibernation	63
Using the battery meter	63
Using power plans	63

Viewing the current power plan	64
Selecting a different power plan	64
Customizing power plans	64
Setting password protection on wakeup	64
Using external AC power	65
Connecting the AC adapter	65
Using battery power	66
Finding battery information in Help and Support	66
Using Battery Check	67
Displaying the remaining battery charge	67
Inserting or removing the battery	67
Charging a battery	68
Maximizing battery discharge time	69
Managing low battery levels	69
Identifying low battery levels	69
Resolving a low battery level	71
Resolving a low battery level when external power is available	71
Resolving a low battery level when a charged battery is available	71
Resolving a low battery level when no power source is available	71
Resolving a low battery level when the computer cannot exit Hibernation	71
Calibrating a battery	71
Step 1: Fully charge the battery	71
Step 2: Disable Hibernation and Sleep	72
Step 3: Discharge the battery	72
Step 4: Fully recharge the battery	73
Step 5: Reenable Hibernation and Sleep	73
Conserving battery power	73
Storing a battery	74
Disposing of a used battery	74
Replacing the battery	74
Testing an AC adapter	75
Shutting down the computer	75
7 Drives	
Identifying installed drives	77
Handling drives	78
Improving hard drive performance	79
Using Disk Defragmenter	79
Using Disk Cleanup	79
Using HP 3D DriveGuard	80
Identifying HP 3D DriveGuard status	80

Using HP 3D DriveGuard software	81
Replacing the hard drive in the hard drive bay	82
8 External devices	
Using a USB device	86
Connecting a USB device	86
Stopping and removing a USB device	86
Using USB legacy support	87
Using a 1394 device	88
Connecting a 1394 device	88
Stopping and removing a 1394 device	88
Using external drives	89
Using optional external devices	89
Using the docking connector	90
9 External media cards	
Using Media Card Reader cards	91
Inserting a digital card	91
Stopping and removing a digital card	92
Using ExpressCards (select models only)	93
Configuring an ExpressCard	93
Inserting an ExpressCard	93
Stopping and removing an ExpressCard	94
Using Smart Cards (select models only)	96
Inserting a smart card	96
Removing a smart card	96
10 Memory modules	
Adding or replacing a memory module	98
11 Security	
Protecting the computer	101
Using passwords	102
Setting passwords in Windows	102
Setting passwords in Computer Setup	102
BIOS administrator password	103
Managing a BIOS administrator password	104
Entering a BIOS administrator password	105
Using Computer Setup DriveLock	105
Setting a DriveLock password	106
Entering a DriveLock password	106
Changing a DriveLock password	106
Removing DriveLock protection	107

Using Computer Setup Auto DriveLock	107
Entering an Automatic DriveLock password	108
Removing Automatic DriveLock protection	108
Using Computer Setup security features	109
Securing system devices	109
Viewing Computer Setup System Information	109
Using Computer Setup System IDs	110
Using antivirus software	111
Using firewall software	112
Installing critical updates	113
Using HP ProtectTools Security Manager (select models only)	114
Installing a security cable	115
12 Software updates	
Updating software	116
Updating the BIOS	118
Determining the BIOS version	118
Downloading a BIOS update	119
Updating programs and drivers	121
Using SoftPaq Download Manager	122
13 Backup and recovery	
Backing up your information	124
Performing a recovery	126
Using the Windows recovery tools	126
Using f11	127
Using a Windows 7 operating system DVD (purchased separately)	127
14 Computer Setup	
Starting Computer Setup	129
Using Computer Setup	129
Navigating and selecting in Computer Setup	129
Restoring factory settings in Computer Setup	130
Computer Setup menus	130
File menu	131
Security menu	131
Diagnostics menu	132
System Configuration menu	133
15 MultiBoot	
About the boot device order	136
Enabling boot devices in Computer Setup	138
Considering boot order changes	139

Choosing MultiBoot preferences	140
Setting a new boot order in Computer Setup	140
Dynamically choosing a boot device using the F9 prompt	140
Setting a MultiBoot Express prompt	141
Entering MultiBoot Express preferences	141
16 Management and printing	
Using Client Management Solutions	142
Configuring and deploying a software image	142
Managing and updating software	143
HP Client Manager for Altiris (select models only)	143
HP CCM (Client Configuration Manager) (select models only)	144
HP SSM (System Software Manager)	144
Using Intel Active Management Technology (select models only)	146
Enabling the iAMT solution	146
Using the MEBx setup utility menus	146
Using the HP Universal Print Driver (select models only)	148
Index	149

Antenna House XSL Formatter

1 Features

Identifying hardware

To see a list of hardware installed in the computer, follow these steps:

1. Select **Start > Computer > System properties**.
2. In the left pane, click **Device Manager**.

You can also add hardware or modify device configurations using Device Manager.

 **NOTE:** Windows® includes the User Account Control feature to improve the security of your computer. You may be prompted for your permission or password for tasks such as installing applications, running utilities, or changing Windows settings. Refer to Windows Help for more information.

Top components

Pointing devices

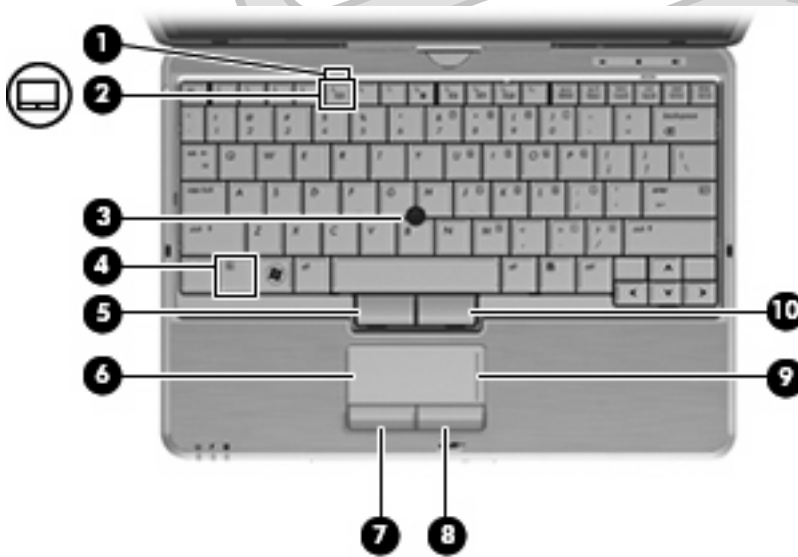

Component	Description
(1) TouchPad light	<ul style="list-style-type: none">• Off: TouchPad is enabled.• Amber: TouchPad is disabled.
(2) TouchPad on/off control	Enables/disables the TouchPad when pressed in combination with the fn key.

Component	Description
(3) Pointing stick*	Moves the pointer and selects or activates items on the screen.
(4) fn key	Enables/disables the TouchPad when pressed in combination with the f5 key.
(5) Left pointing stick button*	Functions like the left button on an external mouse.
(6) TouchPad*	Moves the pointer and selects or activates items on the screen.
(7) Left TouchPad button*	Functions like the left button on an external mouse.
(8) Right TouchPad button*	Functions like the right button on an external mouse.
(9) TouchPad scroll zone*	Scrolls up or down.
(10) Right pointing stick button*	Functions like the right button on an external mouse.
*This table describes factory settings. To view or change pointing device preferences, select Start > Control Panel > Hardware and Sound > Mouse .	

Lights

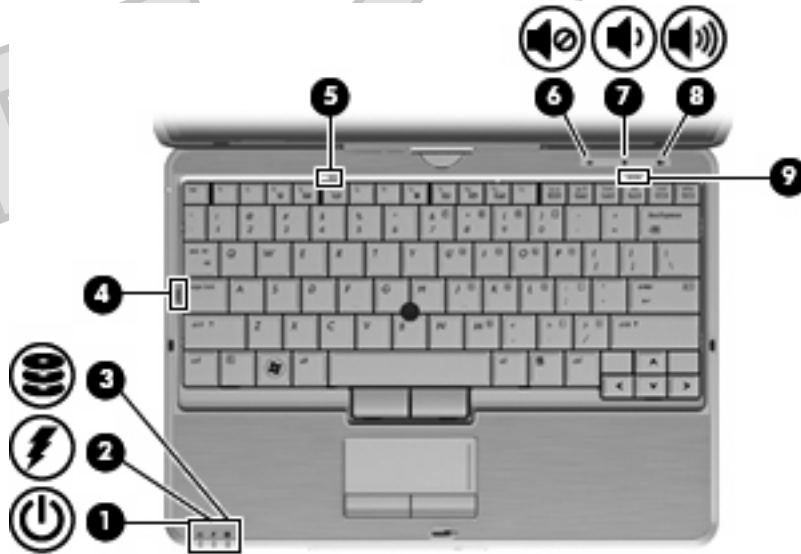

Component	Description
(1) Power light	<ul style="list-style-type: none"> On: The computer is on. Blinking: The computer is in the Sleep state. Off: The computer is off or in Hibernation.
(2) Battery light	<ul style="list-style-type: none"> Amber: A battery is charging. Turquoise: A battery is close to full charge capacity. Blinking amber: A battery that is the only available power source has reached a low battery level. When the battery reaches a critical battery level, the battery light begins blinking rapidly. Off: If the computer is plugged into an external power source, the light turns off when all batteries in the computer are fully charged. If the computer is not plugged into an external power source, the light stays off until the battery reaches a low battery level.
(3) Drive light	<ul style="list-style-type: none"> Blinking turquoise: The hard drive is being accessed. Amber: HP 3D DriveGuard has temporarily parked the internal hard drive.
(4) Caps lock light	On: Caps lock is on.
(5) TouchPad light	<ul style="list-style-type: none"> Off: TouchPad is enabled. Amber: TouchPad is disabled.
(6) Volume mute light	<ul style="list-style-type: none"> Turquoise: Computer sound is on. Amber: Computer sound is off.
(7) Volume down light	Blinking: The volume scroll zone is being used to decrease speaker volume.

Component	Description
(8) Volume up light	Blinking: The volume scroll zone is being used to increase speaker volume.
(9) Num lock light	On: Num lock is on or the embedded numeric keypad is enabled.

Buttons and switches



Component	Description
(1) Internal display switch	Turns off the display if the display is closed while the power is on.
(2) Volume mute button	Mutes and restores speaker sound.
(3) Volume down button	Decreases computer volume.
(4) Volume up button	Increases computer volume.

Keys

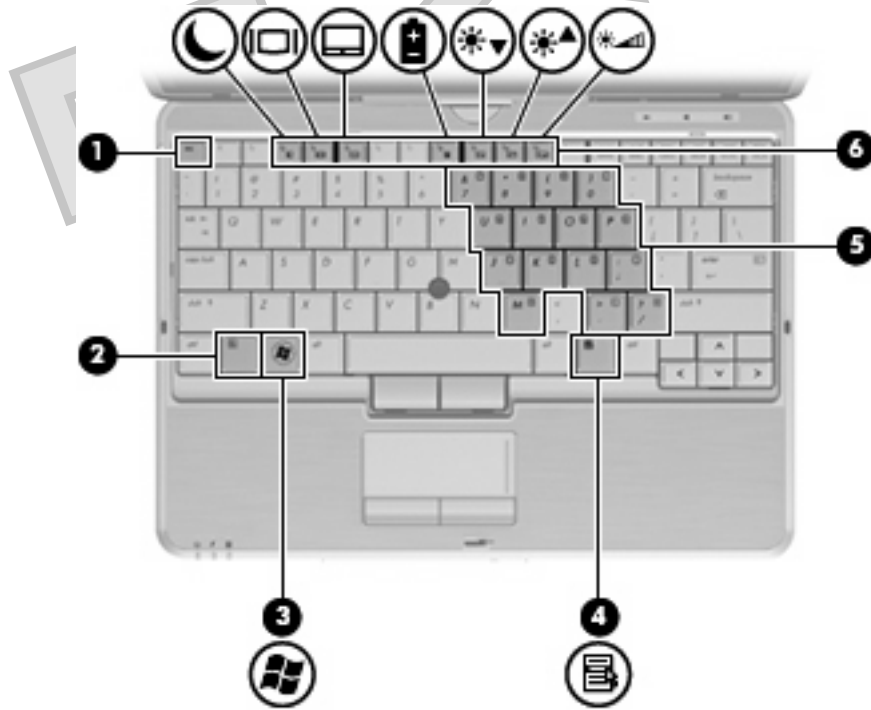

Component	Description
(1) <code>esc</code> key	Displays system information when pressed in combination with the <code>fn</code> key.
(2) <code>fn</code> key	Executes frequently used system functions when pressed in combination with a function key or the <code>esc</code> key.
(3) Windows logo key	Displays the Windows Start menu.
(4) Windows applications key	Displays a shortcut menu for items beneath the pointer.
(5) Embedded numeric keypad keys	Can be used like the keys on an external numeric keypad.
(6) Function keys	Execute frequently used system functions when pressed in combination with the <code>fn</code> key.

Front components

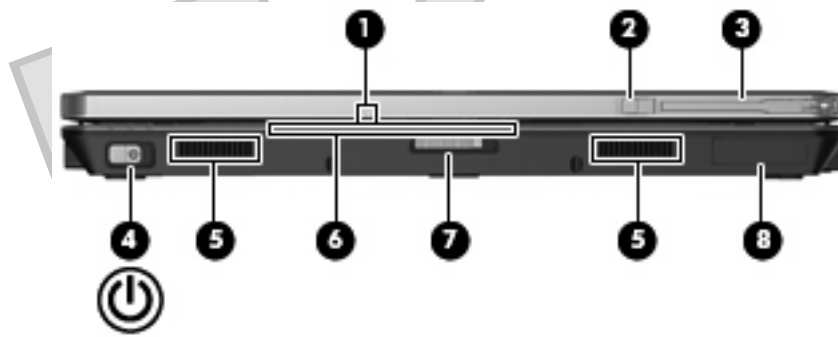

Component	Description
(1) Webcam light	On: The webcam is in use.
(2) External WWAN antenna button	Opens the external WWAN antenna.
(3) External WWAN antenna	Sends and receives wireless signals to communicate with WWANs.
(4) Power switch	<ul style="list-style-type: none"> When the computer is off, slide the switch to the right to turn on the computer. When the computer is on, slide the switch to the right to shut down the computer. When the computer is in the Sleep state, slide the switch to the right briefly to exit Sleep. When the computer is in Hibernation, slide the switch to the right briefly to exit Hibernation. <p>If the computer has stopped responding and Windows® shutdown procedures are ineffective, slide the switch to the right and hold for at least 5 seconds to turn off the computer.</p> <p>To learn more about your power settings, select Start > Control Panel > System and Maintenance > Power Options.</p>
(5) Vents (2)	<p>Enable airflow to cool internal components.</p> <p>NOTE: The computer fan starts up automatically to cool internal components and prevent overheating. It is normal for the internal fan to cycle on and off during routine operation.</p>
(6) Business card slot	Holds a business card in position so that the webcam can capture an image.
(7) Display release latch	Opens the computer.
(8) Bluetooth® compartment	Contains an optional Bluetooth device.

Right-side components

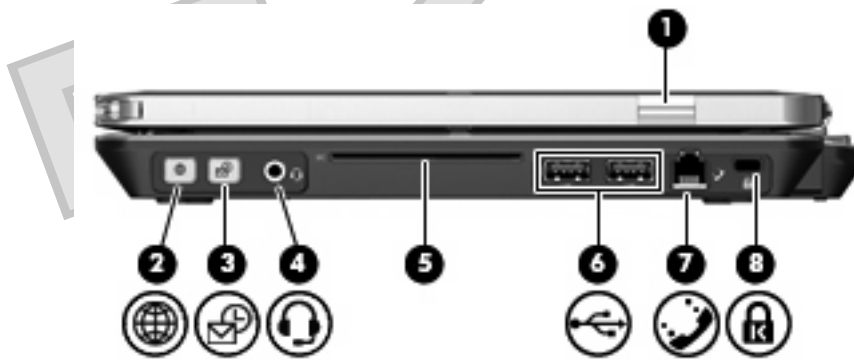

Component	Description
(1) HP Fingerprint Sensor (fingerprint reader)	Allows a fingerprint logon to Windows instead of a password logon.
(2) QuickWeb button	<ul style="list-style-type: none"> When the computer is off, press the button to open HP QuickWeb. When the computer is on, press the button to open the default Web browser.
(3) QuickLook button	<ul style="list-style-type: none"> When the computer is off, press the button to open HP QuickLook. When the computer is on, press the button to open Software Setup. <p>NOTE: If Software Setup is not available, the default Web browser opens.</p>
(4) Audio-out (headphone) jack/Audio-in (microphone) jack	<p>Produces sound when connected to optional powered stereo speakers, headphones, ear buds, a headset, or television audio. Also connects an optional headset microphone.</p> <p>NOTE: When a device is connected to the headphone jack, the computer speakers are disabled.</p>
(5) Smart card reader	Supports optional smart cards and Java™ Cards.
(6) USB ports (2)	Connect optional USB devices.
(7) RJ-11 (modem) jack	Connects a modem cable.
(8) Security cable slot	<p>Attaches an optional security cable to the computer.</p> <p>NOTE: The security cable is designed to act as a deterrent, but it may not prevent the computer from being mishandled or stolen.</p>

Left-side components

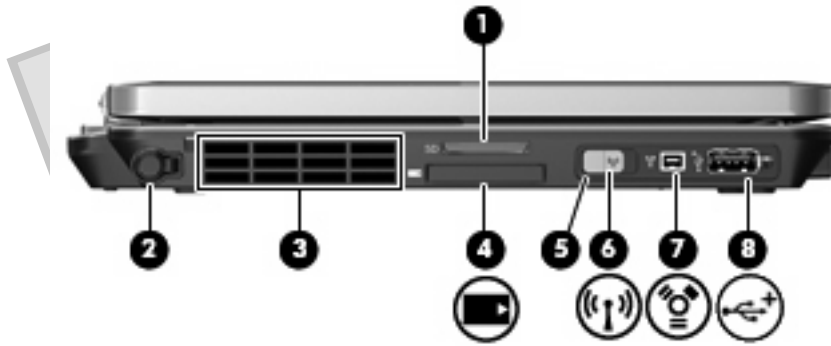

Component	Description
(1) Media Card Reader	<p>Supports the following optional digital card formats:</p> <ul style="list-style-type: none"> Memory Stick Memory Stick Duo (adapter required) Memory Stick Pro (adapter required) Secure Digital (SD) Memory Card MultiMediaCard (MMC) xD-Picture Card xD-Picture Card Type H xD-Picture Card Type M
(2) Pen holder	Stores the pen.
(3) Vent	<p>Enables airflow to cool internal components.</p> <p>NOTE: The computer fan starts up automatically to cool internal components and prevent overheating. It is normal for the internal fan to cycle on and off during routine operation.</p>
(4) ExpressCard slot (select models only)	Supports optional ExpressCards.
(5) Wireless light	<ul style="list-style-type: none"> Blue: An integrated wireless device, such as a wireless local area network (WLAN) device, the HP Mobile Broadband Module, and/or a Bluetooth device, is on. Amber: All wireless devices are off.
(6) Wireless switch	<p>Turns the wireless feature on or off, but does not create a wireless connection.</p> <p>NOTE: A wireless network must be set up in order to establish a wireless connection.</p>
(7) 1394 port	Connects an optional IEEE 1394 or 1394a device, such as a camcorder.
(8) Powered USB port	Provides power to a USB device, such as an optional external MultiBay, if used with a powered USB cable.

Rear components

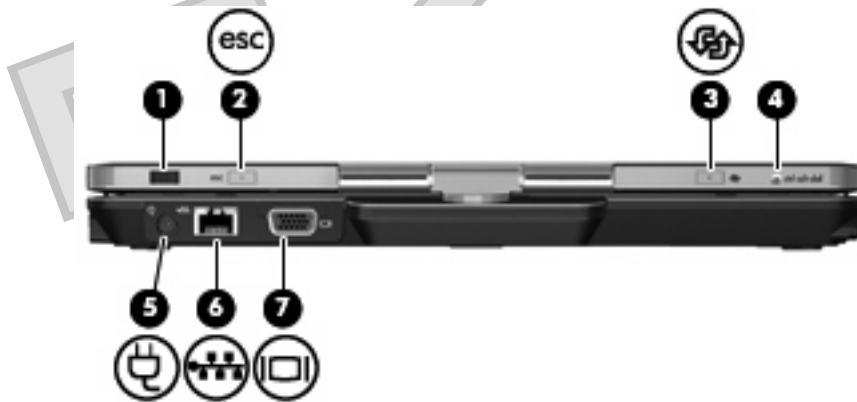

Component	Description
(1) Jog dial	In tablet mode, functions like the enter key and the up and down arrows on a standard keyboard. <ul style="list-style-type: none"> Press inward to enter a command. Rotate up to scroll up. Rotate down to scroll down.
(2) Esc button	In tablet mode, allows you to exit or escape out of an application.
(3) Rotate button	In tablet mode, switches the image between landscape and portrait orientation.
(4) Ctrl+alt+del button	In tablet mode: <ul style="list-style-type: none"> While Windows is running, press the button with the pen to enter the ctrl+alt+del command.* While the Computer Setup utility is running, press the button with the pen to enter the reset command. The computer resets and all unsaved information is lost. The reset function can be used to restore functionality when the system has become unresponsive.
(5) Power connector	Connects an AC adapter.
(6) RJ-45 (network) jack	Connects a network cable.
(7) External monitor port	Connects an external VGA monitor or projector.

*To protect your work and the system, the ctrl+alt+delete command cannot be entered using the [ctrl](#), [alt](#), and [del](#) keys on the on-screen keyboard.

Bottom components

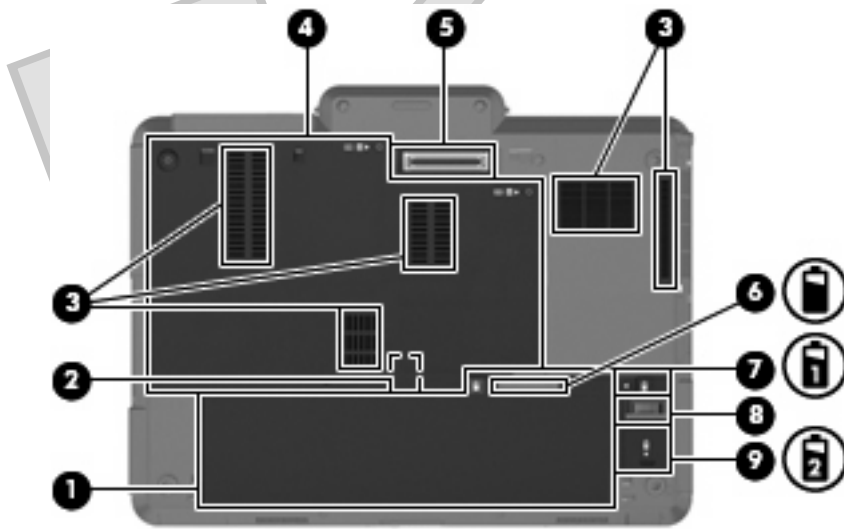

Component	Description
(1) Battery bay	Holds the battery and subscriber identity module (SIM).
(2) SIM slot	Contains a wireless subscriber identity module (SIM) (select models only). The SIM slot is located inside the battery bay.
(3) Vents (5)	Enable airflow to cool internal components. NOTE: The computer fan starts up automatically to cool internal components and prevent overheating. It is normal for the internal fan to cycle on and off during routine operation.
(4) Hard drive bay	Holds the hard drive, memory module slots, WLAN module (select models only), and WWAN module (select models only).
(5) Docking connector	Connects an optional docking device.
(6) Charge level indicator	Displays the approximate remaining battery charge.
(7) Battery release latch	Releases the battery from the battery bay.
(8) Accessory battery connector	Connects an optional accessory battery.
(9) Accessory battery connector door	Slides open to expose the accessory battery connector.

Display

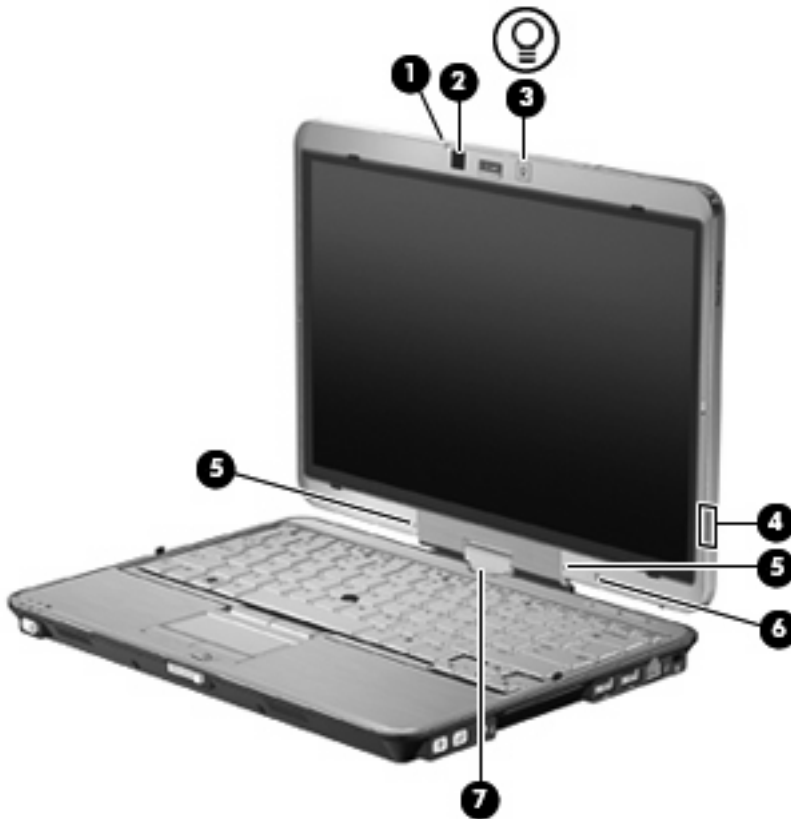

Component	Description
(1) Webcam light (select models only)	On: The webcam is in use.
(2) Webcam (select models only)	Records audio and video and captures still photographs.
(3) Keyboard light button	Opens and turns on the keyboard light.
(4) HP Fingerprint Sensor (fingerprint reader)	Allows a fingerprint logon to Windows instead of a password logon.
(5) Internal microphones (2)	Record sound and transmit sound for video conferencing and Voice Over IP (VoIP).
(6) Ambient light sensor	Automatically adjusts the display brightness based on the lighting conditions in your environment.
(7) Convertible hinge	Swivels the display and converts the computer from traditional notebook mode into tablet mode or vice versa.

Wireless antennas (select models only)

The antennas send and receive signals from one or more wireless devices. These antennas are not visible from the outside of the computer.

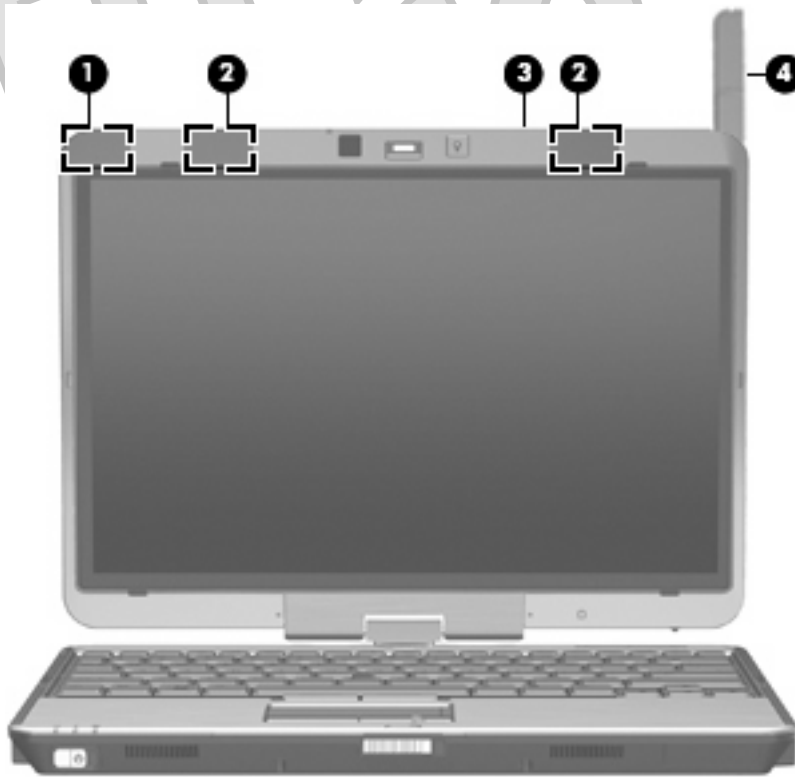

Component	Description
(1) WWAN antenna (1)*	Sends and receives wireless signals to communicate with wireless wide area networks (WWANs).
(2) WLAN antennas (2)*	Send and receive wireless signals to communicate with wireless local area networks (WLANS).
(3) External WWAN antenna button**	Press to open the external WWAN antenna.
(4) External WWAN antenna**	Sends and receives wireless signals to communicate with WWANs.

*The antennas are not visible from the outside of the computer. For optimal transmission, keep the areas immediately around the antennas free from obstructions.

**Before connecting to a WWAN, press the WWAN antenna button to open the external WWAN antenna to a vertical position. The external WWAN antenna allows you to connect to a WWAN, and then to the Internet, using the integrated HP Broadband Wireless Module and service from a supported Cellular network operator. Do not close the external WWAN antenna if you are connected to a WWAN.

To see wireless regulatory notices, refer to the section of the *Regulatory, Safety and Environmental Notices* that applies to your country or region. These notices are located in Help and Support.

Additional hardware components

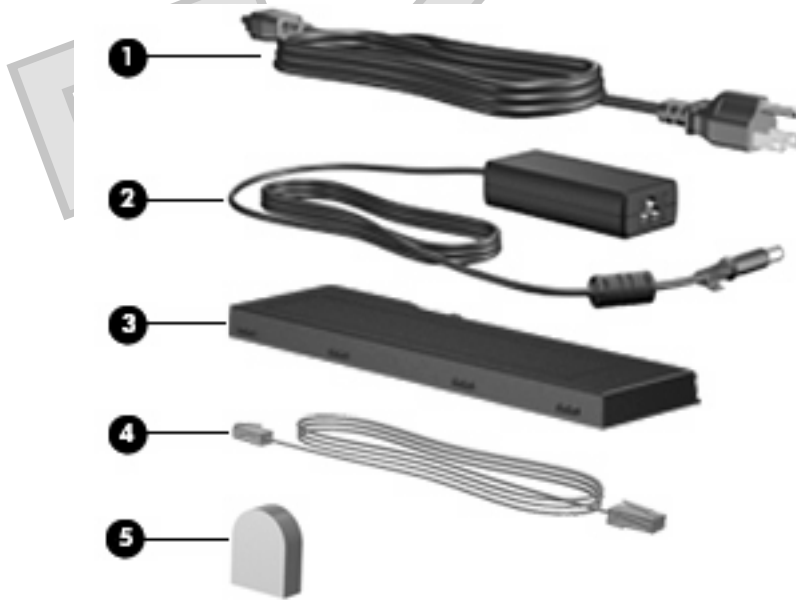

Component	Description
(1) Power cord*	Connects an AC adapter to an AC outlet.
(2) AC adapter	Converts AC power to DC power.
(3) Battery*	Powers the computer when the computer is not plugged into an external power source.
(4) Modem cable (select models only)*	Connects the internal modem to an RJ-11 telephone jack or to a country- or region-specific modem cable adapter.
(5) Country- or region-specific modem cable adapter (select models only)*	Adapts the modem cable to a non-RJ-11 telephone jack.

*Modem cables, batteries, modem cable adapters, and power cords vary in appearance by country or region.

Identifying the labels

The labels affixed to the computer provide information you may need when you troubleshoot system problems or travel internationally with the computer:

- Service tag—Provides important information, including the following:



- Product Name (1). This is the product name affixed to the front of your computer.
- Serial Number (s/n) (2). This is an alphanumeric identifier that is unique to each product.
- Part number/Product number (p/n) (3). This number provides specific information about the product's hardware components. The part number helps a service technician to determine what components and parts are needed.
- Model description (4). This is an alphanumeric identifier used to locate documents, drivers, and support for your computer.
- Warranty period (5). This number describes the duration (in years) of the warranty period for this computer.

Have this information available when you contact technical support. The service tag label is affixed to the bottom of the computer.

- Microsoft® Certificate of Authenticity—Contains the Windows Product Key. You may need the Product Key to update or troubleshoot the operating system. This certificate is affixed to the bottom of the computer.
- Regulatory label—Provides regulatory information about the computer. The regulatory label is affixed inside the battery bay.
- Modem approval label—Provides regulatory information about the modem and lists the agency approval markings required by some of the countries in which the modem has been approved for use. You may need this information when traveling internationally. The modem approval label is affixed inside the memory module compartment.
- Wireless certification label(s) (select models only)—Provide information about optional wireless devices and the approval markings of some of the countries or regions in which the devices have been approved for use. An optional device may be a wireless local area network (WLAN) device or an optional Bluetooth device. If your computer model includes one or more wireless devices, one or more certification labels are included with your computer. You may need this information when traveling internationally. Wireless certification labels are affixed to the bottom of the computer.
- SIM (subscriber identity module) label (select models only)—Provides the ICCID (Integrated Circuit Card Identifier) of your SIM. This label is located inside the battery bay.
- HP Mobile Broadband Module serial number label (select models only)—Provides the serial number of your HP Mobile Broadband Module. This label is located inside the battery bay.

2 Using the tablet

Tablet display components

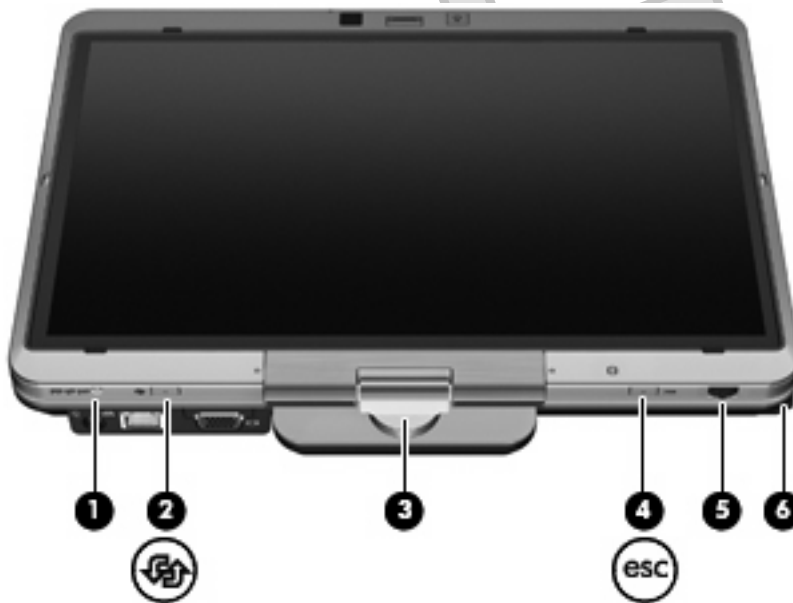

Component	Description
(1) Ctrl+alt+del button*	<ul style="list-style-type: none">• While Windows is running, press the button with the pen to enter the ctrl+alt+delete command.†• While the Computer Setup utility is running, press the button with the pen to enter the reset command. The computer resets and all unsaved information is lost. The reset function can be used to restore functionality when the system has become unresponsive.
(2) Rotate button	Switches the image between landscape and portrait orientation.
(3) Convertible hinge	Swivels the display and converts the computer from traditional notebook mode into tablet mode or vice versa.
(4) Esc button	Allows you to exit or escape out of a program.
(5) Jog dial*	Functions like the enter key and the up and down arrow keys on a standard keyboard: <ul style="list-style-type: none">• Press to enter a command.• Rotate up to scroll up.• Rotate down to scroll down.

(6)	Pen holder	Stores the pen.
-----	------------	-----------------

*This table describes default settings. For information about changing the functions of the Ctrl+alt+del button and jog dial, select **Start > Control Panel > Hardware and Sound > Tablet PC Settings**.

†To protect your work and the system, the ctrl+alt+delete command cannot be entered using the **ctrl**, **alt**, and **del** keys on the on-screen keyboard.

Rotating the display

The computer display can rotate from traditional notebook mode to tablet mode.

 **NOTE:** When the computer is docked in either notebook mode or tablet mode, the display will not rotate.

Tablet mode

To change the computer from notebook mode to tablet mode:

1. Slide the display release latch to release the display (1), and then open the computer display (2).



2. Rotate the computer display clockwise until it snaps into place facing away from the keyboard.

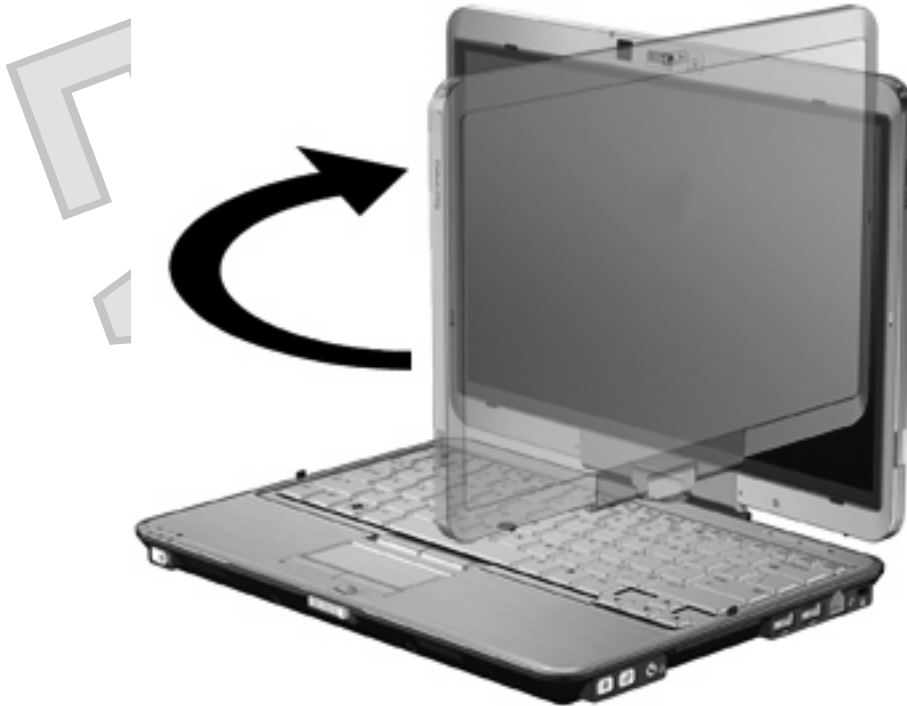

3. Tilt the computer display downward onto the keyboard until it snaps into place.



In tablet mode, the screen display automatically rotates from portrait to landscape as it is being turned.

 **NOTE:** If antennae on the computer are held in close proximity to the body, the antennae may disable automatic rotation of the screen display.

Notebook mode

To change the computer from tablet mode to notebook mode:

1. Slide the display release latch (1).
2. Open the computer display (2).



3. Rotate the computer display counterclockwise until it snaps into place facing the keyboard.



 **NOTE:** To prevent a lack of response when you turn on the computer, be sure that the battery is firmly seated.

3 Wireless, modem, and local area network

Using wireless devices (select models only)

Wireless technology transfers data across radio waves instead of wires. Your computer may be equipped with one or more of the following wireless devices:

- Wireless local area network (WLAN) device—Connects the computer to wireless local area networks (commonly referred to as Wi-Fi networks, wireless LANs, or WLANs) in corporate offices, your home, and public places such as airports, restaurants, coffee shops, hotels, and universities. In a WLAN, each mobile wireless device communicates with a wireless router or a wireless access point.
- HP Mobile Broadband Module—A wireless wide area network (WWAN) device that provides access to information wherever mobile network operator service is available. In a WWAN, each mobile device communicates to a mobile network operator's base station. Mobile network operators install networks of base stations (similar to cell phone towers) throughout large geographic areas, effectively providing coverage across entire states, regions, or even countries.
- Bluetooth device—Creates a personal area network (PAN) to connect to other Bluetooth-enabled devices such as computers, phones, printers, headsets, speakers, and cameras. In a PAN, each device communicates directly with other devices, and devices must be relatively close together—typically within 10 meters (approximately 33 feet) of each other.

Computers with WLAN devices support one or more of the following IEEE industry standards:

- 802.11b, the first popular standard, supports data rates of up to 11 Mbps and operates at a frequency of 2.4 GHz.
- 802.11g supports data rates of up to 54 Mbps and operates at a frequency of 2.4 GHz. An 802.11g WLAN device is backward compatible with 802.11b devices, so they can operate on the same network.
- 802.11a supports data rates of up to 54 Mbps and operates at a frequency of 5 GHz.









 **NOTE:** 802.11a is not compatible with 802.11b and 802.11g.

- 802.11n supports data rates of up to 450 Mbps and may operate at 2.4 GHz or 5 GHz, making it backward compatible with 802.11a, b, and g.

 **NOTE:** The specifications for the 802.11n WLAN are draft specifications and are not final. If the final specifications differ from the draft specifications, it may affect the ability of the computer to communicate with other 802.11n WLAN devices.

For more information on wireless technology, refer to the information and Web site links provided in Help and Support.

Identifying wireless and network icons

Icon	Name	Description
	Wireless (connected)	Identifies the location of the wireless lights and the wireless buttons on the computer. Also identifies the Wireless Assistant software on the computer and indicates that one or more of the wireless devices are on.
	Wireless (disconnected)	Identifies the Wireless Assistant software on the computer and indicates that all of the wireless devices are off.
	HP Connection Manager	Opens HP Connection Manager, which enables you to create a connection with an HP Mobile Broadband device (select models only).
	Wired network (connected)	Indicates that one or more of your network drivers are installed and one or more network devices are connected to the network.
	Network (connected)	Indicates that one or more of your network drivers are installed, one or more network devices are connected to a wireless network, and one or more network devices may be connected to a wired network.
	Network (disconnected)	Indicates that one or more of your network drivers are installed and wireless connections are available, but no network devices are connected to a wired or wireless network.
	Network (disabled/disconnected)	Indicates that one or more of your network drivers are installed, no wireless connections are available or all wireless network devices are disabled by the wireless button or Wireless Assistant, and no network devices are connected to a wired network.
	Wired network (disabled/disconnected)	Indicates that one or more of your network drivers are installed, all network devices or all wireless devices are disabled in Windows Control Panel, and no network devices are connected to a wired network.

Using the wireless controls

You can control the wireless devices in your computer using these features:

- Wireless button or wireless switch (referred to in this guide as the wireless button)
- Wireless Assistant software (select models only)
- HP Connection Manager software (select models only)
- Operating system controls

Using the wireless button

The computer has a wireless button, one or more wireless devices, and one or two wireless lights, depending on the model. All of the wireless devices on your computer are enabled at the factory, so the wireless light is on (blue) when you turn on the computer.

The wireless light indicates the overall power state of your wireless devices, not the status of individual devices. If the wireless light is blue, at least one wireless device is on. If the wireless light is off, all wireless devices are off.

 **NOTE:** On some models, the wireless light is amber when all wireless devices are off.

Because the wireless devices are enabled at the factory, you can use the wireless button to turn on or turn off the wireless devices simultaneously. Individual wireless devices can be controlled through Wireless Assistant software (select models only) or through Computer Setup.

 **NOTE:** If the wireless devices are disabled by Computer Setup, the wireless button will not work until you reenables your devices.

Using Wireless Assistant software (select models only)

A wireless device can be turned on or off using the Wireless Assistant software. If a wireless device is disabled by Computer Setup, it must be reenabled by Computer Setup before it can be turned on or off using Wireless Assistant.

 **NOTE:** Enabling or turning on a wireless device does not automatically connect the computer to a network or a Bluetooth-enabled device.

To view the state of the wireless devices, click the **Show hidden icons** icon, the arrow at the left of the notification area, and position the cursor over the wireless icon.

If the wireless icon is not displayed in the notification area, complete the following steps to change the Wireless Assistant properties:

1. Select **Start > Control Panel > Hardware and Sound > Windows Mobility Center**.
2. Click the wireless icon in the Wireless Assistant tile, which is located in the bottom row of Windows Mobility Center.
3. Click **Properties**.
4. Select the check box next to **HP Wireless Assistant icon in notification area**.
5. Click **Apply**.
6. Click **Close**.

For more information, refer to the Wireless Assistant software Help:

1. Open Wireless Assistant by clicking the wireless icon in Windows Mobility Center.
2. Click the **Help** button.

Using HP Connection Manager (select models only)

You can use HP Connection Manager to connect to WWANs using the HP Mobile Broadband device in your computer (select models only).

To start Connection Manager, click the **Connection Manager** icon in the notification area, at the far right of the taskbar.

– or –

Select **Start > All Programs > HP Connection Manager > HP Connection Manager**.

For more details about using Connection Manager, refer to the Connection Manager software Help.

Using operating system controls

Some operating systems also offer a way to manage integrated wireless devices and the wireless connection. For example, Windows provides the Network and Sharing Center that allows you to set up a connection or network, connect to a network, manage wireless networks, and diagnose and repair network problems.

To access the Network and Sharing Center, select **Start > Control Panel > Network and Internet > Network and Sharing Center**.

For more information, refer to Windows Help and Support. Select **Start > Help and Support**.

Using a WLAN

With a WLAN device, you can access a wireless local area network (WLAN), which is composed of other computers and accessories that are linked by a wireless router or a wireless access point.

 **NOTE:** The terms *wireless router* and *wireless access point* are often used interchangeably.

- A large-scale WLAN, such as a corporate or public WLAN, typically uses wireless access points that can accommodate a large number of computers and accessories and can separate critical network functions.
- A home or small office WLAN typically uses a wireless router, which allows several wireless and wired computers to share an Internet connection, a printer, and files without requiring additional pieces of hardware or software.

To use the WLAN device in your computer, you must connect to a WLAN infrastructure (provided through a service provider or a public or corporate network).

Setting up a WLAN

To set up a WLAN and connect to the Internet, you need the following equipment:

- A broadband modem (either DSL or cable) **(1)** and high-speed Internet service purchased from an Internet service provider (ISP)
- A wireless router (purchased separately) **(2)**
- The wireless computer **(3)**

The illustration below shows an example of a wireless network installation that is connected to the Internet.

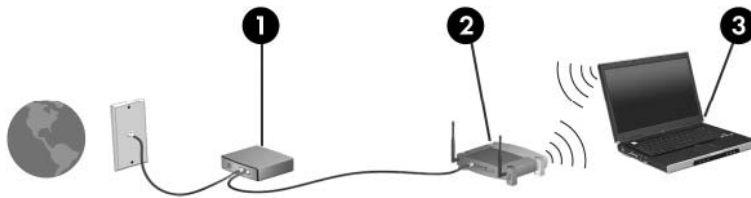

As your network grows, additional wireless and wired computers can be connected to the network to access the Internet.

For help in setting up your WLAN, refer to the information provided by your router manufacturer or your ISP.

Protecting your WLAN

Because the WLAN standard was designed with only limited security capabilities—basically to foil casual eavesdropping rather than more powerful forms of attack—it is essential to understand that WLANs are vulnerable to well-known and well-documented security weaknesses.

WLANs in public areas, or “hotspots,” like coffee shops and airports, may not provide any security. New technologies are being developed by wireless manufacturers and hotspot service providers that make the public environment more secure and anonymous. If you are concerned about the security of your computer in a hotspot, limit your network activities to noncritical e-mail and basic Internet surfing.

When you set up a WLAN or access an existing WLAN, always enable security features to protect your network from unauthorized access. The common security levels are Wi-Fi Protected Access (WPA) and Wired Equivalent Privacy (WEP). Because wireless radio signals travel outside the network, other WLAN devices can pick up unprotected signals and either connect to your network (uninvited) or capture information being sent across it. However, you can take precautions to protect your WLAN:

- **Use a wireless transmitter with built-in security**

Many wireless base stations, gateways, and routers provide built-in security features such as wireless security protocols and firewalls. With the correct wireless transmitter, you can protect your network from the most common wireless security risks.

- **Work behind a firewall**

A firewall is a barrier that checks both data and requests for data that are sent to your network and then discards any suspicious items. Firewalls are available in many varieties, both software and hardware. Some networks use a combination of both types.

- **Use wireless encryption**

A variety of sophisticated encryption protocols is available for your WLAN. Find the solution that works best for your network security:

- **Wired Equivalent Privacy (WEP)** is a wireless security protocol that uses a WEP key to encode or encrypt all network data before it is transmitted. Usually, you can allow the network to assign the WEP key. Alternatively, you can set up your own key, generate a different key, or choose other advanced options. Without the correct key, others will not be able to use the WLAN.
- **WPA (Wi-Fi Protected Access)**, like WEP, uses security settings to encrypt and decrypt data that is transmitted over the network. However, instead of using one static security key for encryptions as WEP does, WPA uses *temporal key integrity protocol* (TKIP) to dynamically generate a new key for every packet. It also generates different sets of keys for each computer on the network.

Connecting to a WLAN

To connect to the WLAN, follow these steps:

1. Be sure that the WLAN device is on. If it is on, the wireless light is on. If the wireless light is off, press the wireless button.

 **NOTE:** On some models, the wireless light is amber when all wireless devices are off.

2. Click the network icon in the notification area, at the far right of the taskbar.
3. Select your WLAN from the list.
4. Click **Connect**.

If the network is a security-enabled WLAN, you are prompted to enter a network security key, which is a security code. Type the code, and then click **OK** to complete the connection.

 **NOTE:** If no WLANs are listed, you are out of range of a wireless router or access point.

NOTE: If you do not see the network you want to connect to, click **Open Network and Sharing Center**, and then click **Set up a new connection or network**. A list of options is displayed. You can choose to manually search for and connect to a network or to set up a new network connection.

After the connection is made, place the mouse pointer over the network icon in the notification area, at the far right of the taskbar, to verify the name and status of the connection.

 **NOTE:** The functional range (how far your wireless signals travel) depends on WLAN implementation, router manufacturer, and interference from other electronic devices or structural barriers such as walls and floors.

More information about using a WLAN is available through the following resources:

- Information from your ISP and the manufacturer's instructions included with your wireless router and other WLAN equipment
- Information and Web site links provided in Help and Support

For a list of public WLANs near you, contact your ISP or search the Web. Web sites that list public WLANs include Cisco Internet Mobile Office Wireless Locations, Hotspotlist, and Geektools. Check with each public WLAN location for cost and connection requirements.

For additional information on connecting your computer to a corporate WLAN, contact your network administrator or IT department.

Roaming to another network

When you move your computer within range of another WLAN, Windows attempts to connect to that network. If the attempt is successful, your computer is automatically connected to the new network. If Windows does not recognize the new network, follow the same procedure you used initially to connect to your WLAN.

Using HP Mobile Broadband (select models only)

HP Mobile Broadband enables your computer to use wireless wide area networks (WWANs) to access the Internet from more places and over larger areas than it can by using WLANs. Using HP Mobile Broadband requires a network service provider (called a *mobile network operator*), which in most cases is a mobile phone network operator. Coverage for HP Mobile Broadband is similar to mobile phone voice coverage.

When used with mobile network operator service, HP Mobile Broadband gives you the freedom to stay connected to the Internet, send e-mail, or connect to your corporate network whether you are on the road or outside the range of Wi-Fi hotspots.

HP supports the following technologies:

- HSPA (High Speed Packet Access), which provides access to networks based on the Global System for Mobile Communications (GSM) telecommunications standard.
- EV-DO (Evolution Data Optimized), which provides access to networks based on the code division multiple access (CDMA) telecommunications standard.

You may need the HP Mobile Broadband Module serial number to activate mobile broadband service. The serial number is printed on a label inside the battery bay of your computer.

Some mobile network operators require the use of a subscriber identity module (SIM). A SIM contains basic information about you, such as a PIN, as well as network information. Some computers include a SIM that is preinstalled in the battery bay. If the SIM is not preinstalled, it may be provided in the HP Mobile Broadband information provided with your computer or the mobile network operator may provide it separately from the computer.

For information on inserting and removing the SIM, refer to the “Inserting a SIM” and “Removing a SIM” sections in this chapter.

For information on HP Mobile Broadband and how to activate service with a preferred mobile network operator, refer to the mobile broadband information included with your computer. For additional information, see the HP Web site at <http://www.hp.com/go/mobilebroadband> (US only).

Inserting a SIM

△ **CAUTION:** To prevent damage to the connectors, use minimal force when inserting a SIM.

To insert a SIM:

1. Shut down the computer. If you are not sure whether the computer is off or in Hibernation, turn the computer on by sliding the power switch to the right. Then shut down the computer through the operating system.
2. Close the display.
3. Disconnect all external devices connected to the computer.
4. Unplug the power cord from the AC outlet.
5. Turn the computer upside down on a flat surface, with the battery bay toward you.
6. Remove the battery.

7. Insert the SIM into the SIM slot, and gently push the SIM into the slot until it is firmly seated.

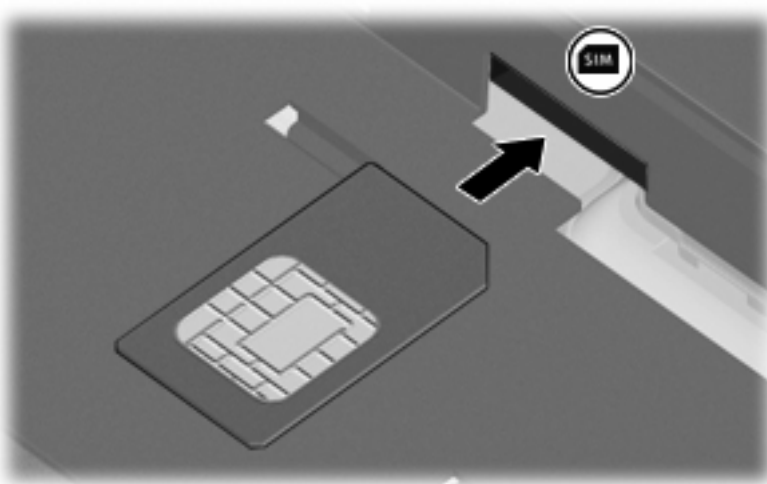

8. Replace the battery.

 **NOTE:** HP Mobile Broadband will be disabled if the battery is not replaced.

9. Turn the computer right-side up, and then reconnect external power and external devices.
10. Turn on the computer.

Removing a SIM

To remove a SIM:

1. Shut down the computer. If you are not sure whether the computer is off or in Hibernation, turn the computer on by sliding the power switch to the right. Then shut down the computer through the operating system.
2. Close the display.
3. Disconnect all external devices connected to the computer.
4. Unplug the power cord from the AC outlet.
5. Turn the computer upside down on a flat surface, with the battery bay toward you.
6. Remove the battery.

7. Press in on the SIM (1), and then remove it from the slot (2).

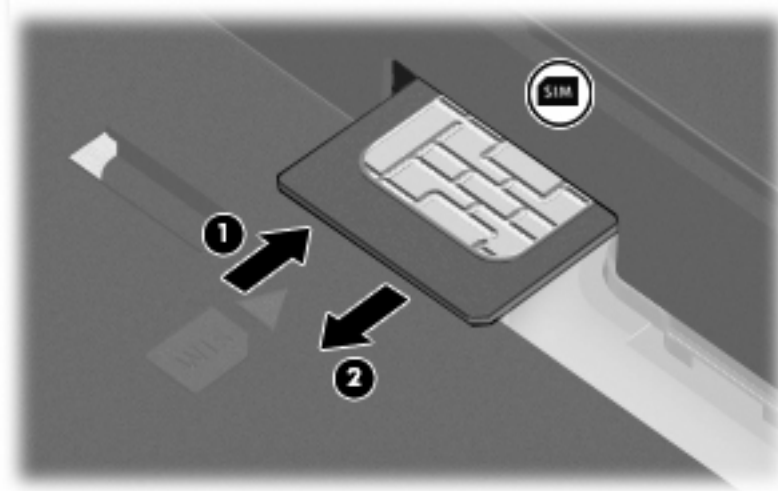

8. Replace the battery.
9. Turn the computer right-side up, and then reconnect external power and external devices.
10. Turn on the computer.

Using Bluetooth wireless devices (select models only)

A Bluetooth device provides short-range wireless communications that replace the physical cable connections that traditionally link electronic devices, such as the following:

- Computers (desktop, notebook, PDA)
- Phones (cellular, cordless, smart phone)
- Imaging devices (printer, camera)
- Audio devices (headset, speakers)

Bluetooth devices provide peer-to-peer capability that allows you to set up a personal area network (PAN) of Bluetooth devices. For information on configuring and using Bluetooth devices, refer to the Bluetooth software Help.

Bluetooth and Internet Connection Sharing (ICS)

HP does **not** recommend setting up one computer with Bluetooth as a host and using it as a gateway through which other computers may connect to the Internet. When two or more computers are connected using Bluetooth, and Internet Connection Sharing (ICS) is enabled on one of the computers, the other computers may not be able to connect to the Internet using the Bluetooth network.

The strength of Bluetooth is in synchronizing information transfers between your computer and wireless devices including cellular phones, printers, cameras, and PDAs. The inability to consistently connect two or more computers to share the Internet through Bluetooth is a limitation of Bluetooth and the Windows operating system.

Troubleshooting wireless connection problems

Some possible causes for wireless connection problems include the following:

- Wireless device is not installed correctly or has been disabled.
- Wireless device or router hardware has failed.
- Network configuration (SSID or security) has been changed.
- Wireless device encountered interference from other devices.

 **NOTE:** Wireless networking devices are included with select computer models only. If wireless networking is not listed in the feature list on the side of the original computer package, you may add wireless networking capability to the computer by purchasing a wireless networking device.

Before working your way through the sequence of possible solutions to your network connection problem, be sure that device drivers are installed for all wireless devices.

Use the procedures in this chapter to diagnose and repair a computer that does not connect to the network you want to use.

Cannot create a WLAN connection

If you have a problem connecting to a WLAN, confirm that the integrated WLAN device is properly installed on your computer:

 **NOTE:** Windows includes the User Account Control feature to improve the security of your computer. You may be prompted for your permission or password for tasks such as installing software, running utilities, or changing Windows settings. Refer to Windows Help and Support for more information.

1. Select **Start > Control Panel > System and Security**.
2. In the **System** area, click **Device Manager**.
3. Click the arrow next to **Network adapters** to expand the list and show all adapters.
4. Identify the WLAN device from the Network adapters list. The listing for a WLAN device may include the term *wireless*, *wireless LAN*, *WLAN*, *Wi-Fi*, or *802.11*.

If no WLAN device is listed, either your computer does not have an integrated WLAN device, or the driver for the WLAN device is not properly installed.

For more information on troubleshooting WLANs, refer to the Web site links provided in Help and Support.

Cannot connect to a preferred network

Windows can automatically repair a corrupted WLAN connection:

- If there is a network icon in the notification area, at the far right of the taskbar, right-click the icon, and then click **Troubleshoot problems**.

Windows resets your network device and attempts to reconnect to one of the preferred networks.

- If there is no network icon in the notification area, follow these steps:
 1. Select **Start > Control Panel > Network and Internet > Network and Sharing Center**.
 2. Click **Troubleshoot problems** and select the network you wish to repair.

Network icon is not displayed

If the network icon is not displayed in the notification area after you configure the WLAN, the software driver is either missing or corrupted. A Windows “Device not Found” error message may also be displayed. The driver must be reinstalled.

To get the latest version of the WLAN device software for your computer, follow these steps:

1. Open your Internet browser and go to <http://www.hp.com/support>.
2. Select your country or region.
3. Click the option for software and driver downloads, and then type your computer model number in the search box.
4. Press **enter**, and then follow the on-screen instructions.

 **NOTE:** If the WLAN device you are using was purchased separately, consult the manufacturer's Web site for the latest software.

Current network security codes are unavailable

If you are prompted for a network key or a name (SSID) when connecting to a WLAN, the network is protected by security. You must have the current codes to make a connection on a secure network. The SSID and network key are alphanumeric codes that you enter into your computer to identify your computer to the network.

- For a network connected to your personal wireless router, review the router user guide for instructions on setting up the same codes on both the router and the WLAN device.
- For a private network, such as a network in an office or at a public Internet chat room, contact the network administrator to obtain the codes, and then enter the codes when prompted to do so.

Some networks change the SSID or network keys used in their routers or access points on a regular basis to improve security. You must change the corresponding code in your computer accordingly.

If you are provided with new wireless network keys and SSID for a network, and if you have previously connected to that network, follow the steps below to connect to the network:

1. Select **Start > Control Panel > Network and Internet > Network and Sharing Center**.

2. Click **Manage wireless networks** in the left panel.

A list showing the available WLANs is displayed. If you are in a hotspot where several WLANs are active, several will be displayed.

3. Select the network in the list, right-click the network, and then click **Properties**.

 **NOTE:** If the network you want is not listed, check with the network administrator to be sure that the router or access point is operating.

4. Click the **Security** tab, and then enter the correct wireless encryption data into the **Network security key** field.

5. Click **OK** to save these settings.

WLAN connection is very weak

If the connection is very weak, or if your computer cannot make a connection to a WLAN, minimize interference from other devices, as follows:

- Move your computer closer to the wireless router or access point.
- Temporarily disconnect other wireless devices such as a microwave, cordless phone, or cellular phone to be sure that they are not interfering.

If the connection does not improve, try forcing the device to reestablish all connection values:

1. Select **Start > Control Panel > Network and Internet > Network and Sharing Center**.

2. Click **Manage wireless networks** in the left panel.

A list showing the available WLANs is displayed. If you are in a hotspot where several WLANs are active, several will be displayed.

3. Click a network, and then click **Remove**.

Cannot connect to the wireless router

If you are trying to connect to the wireless router and are unsuccessful, reset the wireless router by removing power from the router for 10 to 15 seconds.

If the computer still cannot make a connection to a WLAN, restart the wireless router. For details, refer to the router manufacturer's instructions.

Using the modem (select models only)

The modem must be connected to an analog telephone line using a 6-pin, RJ-11 modem cable (included with select models only). In some countries, a country-specific modem cable adapter (included with select models only) is also required. Jacks for digital PBX systems may resemble analog telephone jacks, but they are not compatible with the modem.

- ⚠ **WARNING!** Connecting the internal analog modem to a digital line can permanently damage the modem. Immediately disconnect the modem cable if you accidentally connect it to a digital line.

If the modem cable contains noise suppression circuitry (1), which prevents interference from TV and radio reception, orient the circuitry end (2) of the cable toward the computer.

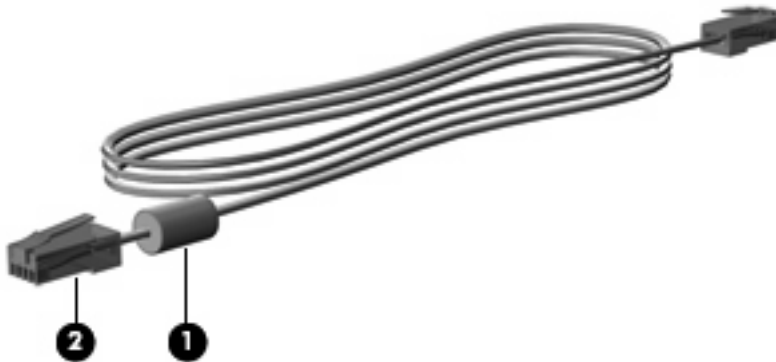

Connecting a modem cable

- ⚠ **WARNING!** To reduce the risk of electric shock, fire, or damage to the equipment, do not plug a modem cable (included with select models only) or telephone cable into the RJ-45 (network) jack.

To connect a modem cable:

1. Plug the modem cable into the modem jack (1) on the computer.
2. Plug the modem cable into the RJ-11 telephone wall jack (2).



Connecting a country-specific modem cable adapter

Telephone jacks vary by country. To use the modem and the modem cable (included with select models only) outside the country in which you purchased the computer, you must obtain a country-specific modem cable adapter (included with select models only).

To connect the modem to an analog telephone line that does not have an RJ-11 telephone jack, follow these steps:

1. Plug the modem cable into the modem jack (1) on the computer.
2. Plug the modem cable into the country-specific modem cable adapter (2).
3. Plug the country-specific modem cable adapter (3) into the telephone wall jack.

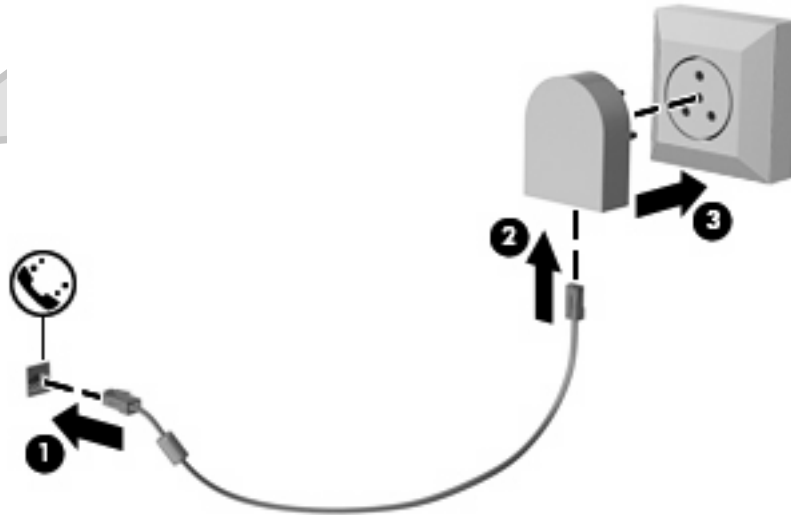

Selecting a location setting

Viewing the current location selection

To view the current location setting for the modem, follow these steps:

1. Select **Start > Control Panel**.
2. Click **Clock, Language, and Region**.
3. Click **Region and Language**.
4. Click the **Location** tab to display your location.

Adding new locations when traveling

By default, the only location setting available to the modem is a location setting for the country in which you purchased the computer. As you travel to different countries, set the internal modem to a location setting that meets the operating standards of the country in which you are using the modem.

As you add new location settings, they are saved by the computer so that you can switch among settings at any time. You can add multiple location settings for any country.

△ **CAUTION:** To prevent losing your home country settings, do not delete your current modem country settings. To enable modem use in other countries while preserving your home country configuration, add a new configuration for each location in which you will use the modem.

CAUTION: To prevent configuring the modem in a way that violates the telecommunications regulations and laws of the country you are visiting, select the country in which the computer is located. The modem may not function properly if the correct country selection is not made.

To add a location setting for the modem, follow these steps:

1. Select **Start > Devices and Printers**.

2. Right-click the device that represents your computer, and click **Modem settings**.

📝 **NOTE:** You must set up an initial (current) location area code before you can view the Dialing Rules tab. If you do not have a location set up, you will be prompted to enter the location when you click Modem settings.

3. Click the **Dialing Rules** tab.

4. Click **New**. (The New Location window is displayed.)

5. In the **Location name** box, type a name (such as “home” or “work”) for the new location setting.

6. Select a country or region from the **Country/region** drop-down list. (If you select a country or region that is not supported by the modem, the Country/region selection for *USA* or *UK* is displayed by default.)

7. Enter the area code, a carrier code (if necessary), and the number to access an outside line (if necessary).

8. Next to **Dial using**, click **Tone** or **Pulse**.

9. Click **OK** to save your new location setting. (The Phone and Modem window is displayed.)

10. Do one of the following:

- To set your new location setting as the current location, click **OK**.
- To select another location setting as the current location setting, select your preference from the settings in the **Location** list, and then click **OK**.

📝 **NOTE:** You can use the preceding procedure to add location settings for places within your own country as well as in other countries. For example, you could add a setting named “Work” that includes dialing rules for accessing an outside line.

Solving travel connection problems

If you experience modem connection problems when using the computer outside of the country in which you purchased it, try the following suggestions:

- **Check the telephone line type.**

The modem requires an analog, not a digital, telephone line. A line described as a PBX line is usually a digital line. A telephone line described as a data line, fax machine line, modem line, or standard telephone line is usually an analog line.

- **Check for pulse or tone dialing.**

An analog telephone line supports one of two dialing modes: pulse dialing or tone dialing. These dialing mode options are selected in the Phone and Modem settings. The dialing mode option selected must match the dialing mode supported by the telephone line in your location.

To determine the dialing mode supported by a telephone line, dial a few digits on the telephone, and then listen for clicks (pulses) or tones. Clicks indicate that the telephone line supports pulse dialing. Tones indicate that the telephone line supports tone dialing.

To change the dialing mode in your current modem location setting, follow these steps:

1. Select **Start > Devices and Printers**.
2. Right-click the device that represents your computer, and click **Modem settings**.
3. Click the **Dialing Rules** tab.
4. Select your modem location setting.
5. Click **Edit**.
6. Click either **Tone** or **Pulse**.
7. Click **OK** twice.

- **Check the telephone number you are dialing and the response of the remote modem.**

Dial a telephone number, make sure there is a response from the remote modem, and then hang up.

- **Set the modem to ignore dial tones.**

If the modem receives a dial tone it does not recognize, it does not dial and displays a “No Dial Tone” error message.

To set the modem to ignore all dial tones before dialing, follow these steps:

1. Select **Start > Devices and Printers**.
2. Right-click the device that represents your computer, and click **Modem settings**.
3. Click the **Modems** tab.
4. Click the listing for the modem.
5. Click **Properties**.
6. Click **Modem**.

7. Clear the check box for **Wait for dial tone before dialing**.
8. Click **OK** twice.

Antenna House XSL Formatter

Connecting to a local area network (LAN)

Connecting to a local area network (LAN) requires an 8-pin, RJ-45 network cable (purchased separately). If the network cable contains noise suppression circuitry (1), which prevents interference from TV and radio reception, orient the circuitry end of the cable (2) toward the computer.



To connect the network cable:

1. Plug the network cable into the network jack (1) on the computer.
2. Plug the other end of the cable into a network wall jack (2).



⚠ WARNING! To reduce the risk of electric shock, fire, or damage to the equipment, do not plug a modem or telephone cable into the RJ-45 (network) jack.

4 Pointing devices and keyboard

Using pointing devices

Setting pointing device preferences

Use Mouse Properties in Windows® to customize settings for pointing devices, such as button configuration, click speed, and pointer options.

To access Mouse Properties, select **Start > Control Panel > Hardware and Sound > Mouse**.

Using the TouchPad

To move the pointer, slide your finger across the TouchPad surface in the direction you want the pointer to go. Use the TouchPad buttons like the corresponding buttons on an external mouse. To scroll up and down using the TouchPad vertical scroll zone, slide your finger up or down over the lines.

 **NOTE:** If you are using the TouchPad to move the pointer, you must lift your finger off the TouchPad before moving it to the scroll zone. Simply sliding your finger from the TouchPad to the scroll zone will not activate the scrolling function.

Using the pointing stick

Press the pointing stick in the direction you want to move the pointer on the screen. Use the left and right pointing stick buttons as you would the left and right buttons on an external mouse.

Connecting an external mouse

You can connect an external USB mouse to the computer using one of the USB ports on the computer. A USB mouse can also be connected to the system using the ports on an optional docking device.

Using the keyboard

Using the keyboard light

The keyboard light illuminates the computer keyboard in low light conditions.

- ▲ To open and turn on the keyboard light, press the keyboard light button.



- ▲ To turn off and close the keyboard light, gently press the keyboard light button until it clicks into place.



Using hotkeys

Hotkeys are combinations of the **fn** key (1) and either the **esc** key (2) or one of the function keys (3).

The icons on the **f3** through **f5**, and **f8** through **f11** keys represent the hotkey functions. Hotkey functions and procedures are discussed in the following sections.



Function	Hotkey
Display system information.	fn+esc
Initiate Sleep.	fn+f3
Switch the screen image.	fn+f4
Enable/disable the TouchPad	Fn+f5
Display battery information.	fn+f8
Decrease screen brightness.	fn+f9
Increase screen brightness.	fn+f10
Activate the ambient light sensor.	fn+f11

To use a hotkey command on the computer keyboard, follow either of these steps:

- Briefly press the **fn** key, and then briefly press the second key of the hotkey command.
– or –
- Press and hold down the **fn** key, briefly press the second key of the hotkey command, and then release both keys at the same time.

Displaying system information

Press **fn+esc** to display information about system hardware components and the system BIOS version number.

In the Windows **fn+esc** display, the version of the system BIOS (basic input-output system) is displayed as the BIOS date. On some computer models, the BIOS date is displayed in decimal format. The BIOS date is sometimes called the system ROM version number.

Initiating Sleep

△ **CAUTION:** To reduce the risk of information loss, save your work before initiating Sleep.

Press **fn+f3** to initiate Sleep.

When Sleep is initiated, your information is stored in system memory, the screen is cleared, and power is conserved. While the computer is in the Sleep state, the power lights blink.

The computer must be on before you can initiate Sleep.

📝 **NOTE:** If a critical battery level occurs while the computer is in the Sleep state, the computer initiates Hibernation and the information stored in memory is saved to the hard drive. The factory setting for critical battery action is Hibernate, but this setting can be changed using Power Options in Windows Control Panel.

To exit Sleep, briefly slide the power switch to the right.

The function of the **fn+f3** hotkey can be changed. For example, you can set the **fn+f3** hotkey to initiate Hibernation instead of Sleep.

📝 **NOTE:** In all Windows operating system windows, references to the *sleep button* apply to the **fn+f3** hotkey.

Switching the screen image

Press **fn+f4** to switch the screen image among display devices connected to the system. For example, if a monitor is connected to the computer, pressing **fn+f4** alternates the screen image from computer display to monitor display to simultaneous display on both the computer and the monitor.

Most external monitors receive video information from the computer using the external VGA video standard. The **fn+f4** hotkey can also alternate images among other devices receiving video information from the computer.

The following video transmission types, with examples of devices that use them, are supported by the **fn+f4** hotkey:

- LCD (computer display)
- External VGA (most external monitors)
- S-Video (televisions, camcorders, DVD players, VCRs, and video capture cards with S-Video-in jacks)
- HDMI (televisions, camcorders, DVD players, VCRs, and video capture cards with HDMI ports)
- Composite video (televisions, camcorders, DVD players, VCRs, and video capture cards with composite-video-in jacks)

📝 **NOTE:** Composite video devices can be connected to the system only by using an optional docking device.

Viewing battery charge information

Press **fn+f8** to display charge information for all installed batteries. The display indicates which batteries are charging and reports the amount of charge remaining in each battery.

Enabling/disabling the TouchPad (fn+f5)

Press **fn+f5** to enable or disable the TouchPad.

Decreasing screen brightness

Press **fn+f9** to decrease screen brightness. Hold down the hotkey to decrease the brightness level incrementally.

Increasing screen brightness

Press **fn+f10** to increase screen brightness. Hold down the hotkey to increase the brightness level incrementally.

Activating the ambient light sensor

Press **fn+f11** to activate and deactivate the ambient light sensor.

Using QuickLook (select models only)

 **NOTE:** QuickLook must be installed before you can view the QuickLook information.

QuickLook saves Inbox e-mails and calendar, contact, and task information from Microsoft® Outlook to your computer's hard drive. When the computer is off, in the Sleep state, or in Hibernation, you can quickly view this information by pressing the info button on the computer.

 **NOTE:** If you have set a Windows logon password, you will be prompted to enter your password when you press the info button while the computer is off, in the Sleep state, or in Hibernation.

NOTE: For additional information about QuickLook and setting preferences, refer to the online Help.

Installing QuickLook

To install QuickLook:

1. Select **Start > All Programs > Software Setup**.
2. Clear all check boxes.
3. Expand **Optional Software Applications**, and then select **HP QuickLook**.
4. Click **Install**.

Using HP Quick Launch Buttons

The HP Quick Launch Buttons enable you to quickly open programs, files, or Web sites you use frequently. You can use the factory settings, which are described in the following table. Or you can reprogram the buttons by opening the Q Menu in the Quick Launch Buttons control panel.

The Quick Launch Buttons include the QuickWeb button (1), and the QuickLook button (2).

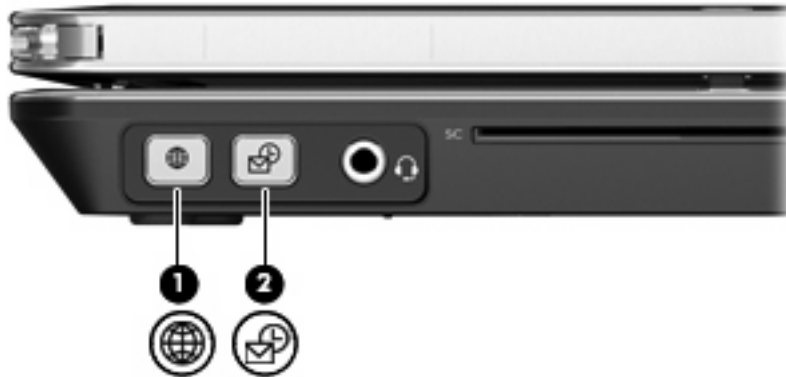

The following table describes the factory settings for the Quick Launch Buttons.

NOTE: Button functions vary, depending on the software installed on your computer.

Component	Description
(1) QuickWeb button	<ul style="list-style-type: none">When the computer is off, press the button to open HP QuickWeb.When the computer is on, press the button to open the default Web browser.
(2) QuickLook button	<ul style="list-style-type: none">When the computer is off, press the button to open HP QuickLook .When the computer is on, press the button to open Software Setup. <p>NOTE: If Software Setup is not available, the default Web browser opens.</p>

Opening the Quick Launch Buttons control panel

You can open the HP Quick Launch Buttons control panel in any of the following ways:

- Select **Start > Control Panel > Hardware and Sound > Quick Launch Buttons**.
- Double-click the **HP Quick Launch Buttons** icon in the notification area, at the far right of the taskbar.
- Right-click the **HP Quick Launch Buttons** icon in the notification area, and click **Adjust HP Quick Launch Buttons Properties**.

 **NOTE:** On some models, an icon is displayed on the desktop.

Using HP QuickLook 3

QuickLook 3 allows you to save calendar, contact, inbox, and task information from Microsoft Outlook to the hard drive of your computer. Then, when the computer is off or in Hibernation, you can press the QuickLook button on the computer to view this information without waiting for the operating system to restart.

Use QuickLook 3 to manage contact information, calendar events, e-mail information, and tasks without restarting your computer.

 **NOTE:** QuickLook 3 does not support the Sleep state in Windows.

For more information about setting up and using QuickLook 3, refer to the QuickLook 3 software Help.

Using the pen

You can write with the pen in pen-specific programs such as the Tablet PC Input Panel, in all Microsoft® Office applications, and in most other Windows programs and utilities. The information you write on the screen with the pen can be filed, searched, and shared among most Windows programs.

Identifying the pen components

The pen interacts with the tablet PC whenever the tip **(1)** or eraser **(3)** of the pen is approximately 1.27 cm (0.5 inch) from the screen. The pen button **(2)** emulates the functions of the right button on an external mouse.

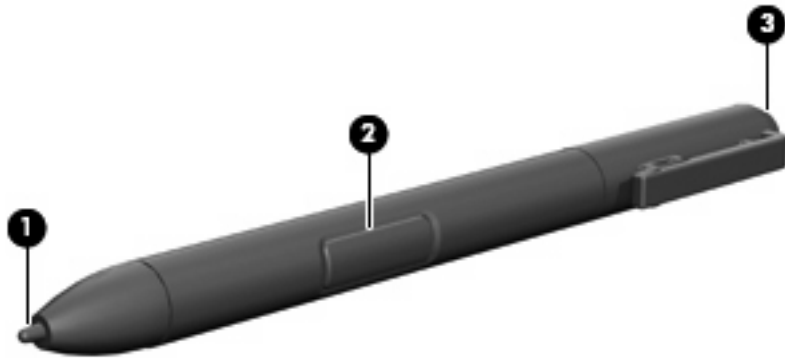

Holding the pen

Hold the pen as if you were writing with a standard pen or pencil. Position the pen in your hand so that you will not accidentally press the pen button.

As you monitor the movements of the pen, focus on the pointer, not on the tip of the pen.

Performing mouse clicks with the pen

- ▲ To select an item on the screen as you would with the left button of an external mouse, tap the item with the tip of the pen.
- ▲ To double-click an item on the screen as you would with the left button of an external mouse, tap the item twice with the tip of the pen.
- ▲ To select an item as you would with the right button of an external mouse, press and hold down the pen button, and then tap the item with the tip of the pen.

Performing other procedures with the pen

In addition to emulating mouse clicks, the pen can be used for the following tasks:

- To display the pointer location, hold the pen tip immediately over any location on the tablet PC screen without touching the screen with the pen tip.
- To display the menu options related to an item on the screen, tap the screen with the pen tip.
- To write with the pen, write on the screen with the tip of the pen.
- To press a pen-activated button, tap the button with the tip of the pen.
- To erase with the pen, hold the pen with the eraser side down and move the eraser over the writing that you want to delete.

Pressure sensitivity

The tablet PC pen is equipped with a pressure-sensitive feature. This means that you can manipulate the pen to create lines of various thickness, depending upon the amount of pressure you use to write.

 **NOTE:** This feature is available only if the Tablet PC Input Panel software is enabled.

Calibrating the pen

The pen can function at the default calibration or at a calibration set by another user. However, HP highly recommends that you use the pen only while it is calibrated to your personal handwriting and mouse action motions. Calibration optimizes pen performance for all users and particularly for left-handed users.

To calibrate the pen:

1. Select **Start > Control Panel > Hardware and Sound > Tablet PC Settings**.
2. At the bottom of the **General** tab, tap the **Calibrate** button.
3. Follow the instructions on the screen.
 - Tap the pen in the exact center of each of the calibration markers. The calibration markers are displayed on the screen as plus signs (+).
 - Be sure to calibrate the pen for use in both portrait and landscape orientations.

 **NOTE:** You can display information about any setting in the Tablet PC Settings window by selecting the Help button in the upper-right corner of the window, and then selecting a setting.

Using the pen holder

To remove the pen from the pen holder on the computer, press the pen in to eject it.

To protect the pen when you are not using it, insert the pen, tip first, into the pen holder on the computer.



Setting pen preferences

Pen preferences are set in the Tablet PC Settings window of the operating system. The preferences include setting the location of on-screen menus for either right-handed or left-handed users, calibrating the screen for pen use, and optimizing handwriting recognition.

To access pen preferences:

- ▲ Select **Start > Control Panel > Hardware and Sound > Tablet PC Settings**.

Pen options are set in the Pen and Input Devices window. The options include speed settings for double-tapping and press-and-hold pen use, pen pointer options, and flick settings.

To access pen options:

- ▲ Select **Start > Control Panel > Hardware and Sound > Pen and Input Devices**.

The preferences and options you set in the Tablet PC Settings and the Pen and Input Devices window are specific to the pen and the tablet PC. Pointing device preferences, such as pointer speed, click speed, and mouse trails, are set in the Mouse Properties window. These preferences apply to any pointing device in the system.

To access Mouse Properties:

- ▲ Select **Start > Control Panel > Hardware and Sound > Mouse**.

Using the embedded numeric keypad

Using the embedded numeric keypad

The 15 keys of the embedded numeric keypad can be used like the keys on an external keypad. When the embedded numeric keypad is turned on, each key on the keypad performs the function indicated by the icon in the upper-right corner of the key.

Enabling and disabling the embedded numeric keypad

Press **fn+num lk** to enable the embedded numeric keypad. Press **fn+num lk** again to return the keys to their standard keyboard functions.

 **NOTE:** The embedded numeric keypad will not function while an external keyboard or numeric keypad is connected to the computer.

Switching key functions on the embedded numeric keypad

You can temporarily alternate the functions of keys on the embedded numeric keypad between their standard keyboard functions and their keypad functions by using the **fn** key or the **fn+shift** key combination.

- To change the function of a keypad key to keypad functions while the keypad is off, press and hold the **fn** key while pressing the keypad key.
- To use the keypad keys temporarily as standard keys while the keypad is on:
 - Press and hold the **fn** key to type in lowercase.
 - Press and hold **fn+shift** to type in uppercase.

Cleaning the TouchPad and keyboard

Dirt and grease on the TouchPad can cause the pointer to jump around on the screen. To avoid this, clean the TouchPad with a damp cloth, and wash your hands frequently when using the computer.

- ⚠ **WARNING!** To reduce the risk of electric shock or damage to internal components, do not use a vacuum cleaner attachment to clean the keyboard. A vacuum cleaner can deposit household debris on the keyboard surface.

Clean the keyboard regularly to prevent keys from sticking and to remove dust, lint, and particles that can become trapped beneath the keys. A can of compressed air with a straw extension can be used to blow air around and under the keys to loosen and remove debris.



5 Multimedia

Multimedia features

Your computer includes multimedia features that allow you to listen to music, watch movies, and view pictures. Your computer may include the following multimedia components:

- Optical drive for playing audio and video discs
- Integrated speakers for listening to music
- Integrated microphone for recording your own audio
- Integrated webcam that allows you to capture and share video
- Preinstalled multimedia software that allows you to play and manage your music, movies, and pictures
- Hotkeys that provide fast access to multimedia tasks

 **NOTE:** Your computer may not include all of the components listed.

The following sections explain how to identify and use the multimedia components included with your computer.

Adjusting the volume

You can adjust the volume using the following controls:

- Computer volume buttons:
 - To mute or restore volume, press the mute button **(1)**.
 - To decrease volume, press and hold the volume down button **(2)** until the desired volume level is reached.

- To increase volume, press and hold the volume up button (3) until the desired volume level is reached.

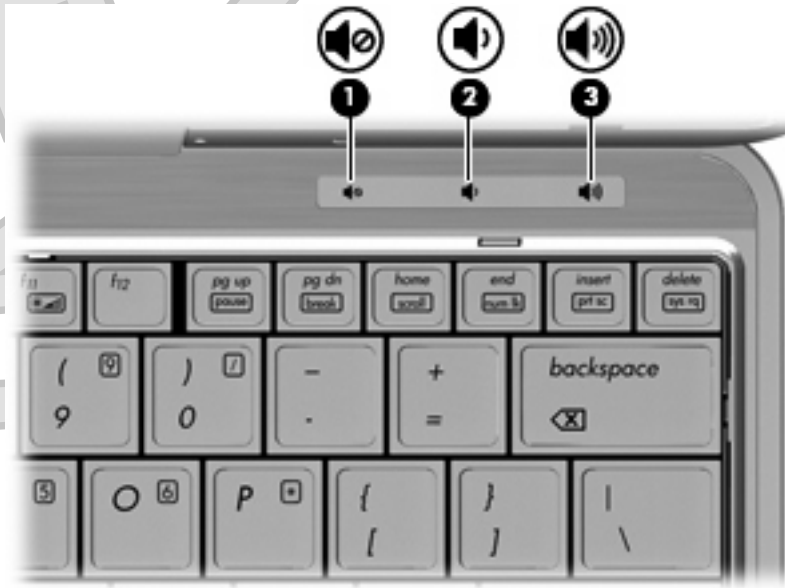

- Windows volume control:
 - Click the **Speakers** icon in the notification area, at the far right of the taskbar.
 - Increase or decrease the volume by moving the slider up or down. Click the **Mute Speakers** icon to mute the volume.

– or –

 - Right-click the **Speakers** icon in the notification area, and then click **Open Volume Mixer**.
 - In the Speakers column, you can increase or decrease the volume by moving the **Volume** slider up or down. You can also mute the volume by clicking the **Mute Speakers** icon.

If the **Speakers** icon is not displayed in the notification area, follow these steps to add it:

 - Right-click the **Show hidden icons** icon (the arrow at far left of the notification area).
 - Click **Customize notification icons**.
 - Under **Behaviors**, select **Show icon and notifications** for the Volume icon.
 - Click **OK**.
- Program volume control:

Volume can also be adjusted within some programs.

Multimedia software

 **NOTE:** To use optical discs (CDs and DVDs), you must use the optional HP 2740 Ultra-Slim Expansion Base or an optional external MultiBay with an optical drive.

The computer includes preinstalled multimedia software. Some computer models also include additional multimedia software on an optical disc.

Depending on the hardware and software included with the computer, the following multimedia tasks may be supported:

- Playing digital media, including audio and video CDs, audio and video DVDs, and Internet radio
- Creating or copying data CDs
- Creating, editing, and burning audio CDs
- Creating, editing, and burning a video or movie to a DVD or video CD

△ **CAUTION:** To prevent loss of information or damage to a disc, observe the following guidelines:

Before writing to a disc, connect the computer to a reliable external power source. Do not write to a disc while the computer is running on battery power.

Before writing to a disc, close all open programs except the disc software you are using.

Do not copy directly from a source disc to a destination disc or from a network drive to a destination disc. Instead, copy from a source disc or network drive to your hard drive, and then copy from your hard drive to the destination disc.

Do not use the computer keyboard or move the computer while the computer is writing to a disc. The write process is sensitive to vibration.

📄 **NOTE:** For information about using software included with the computer, refer to the software manufacturer's instructions that may be provided on disc, as online Help files, or on the software manufacturer's Web site.

Accessing your preinstalled multimedia software

To access your preinstalled multimedia software:

- ▲ Select **Start > All Programs**, and then open the multimedia program you want to use.

📄 **NOTE:** Some programs may be located in subfolders.

📄 **NOTE:** For details about using software included with the computer, refer to the software manufacturer's instructions, which may be provided with the software, on disc, or on the manufacturer's Web site.

Installing your preloaded multimedia software

To install your preloaded software from your hard drive, select **Start > All Programs > HP Software Setup**, and then follow the instructions on the screen.

Installing multimedia software from a disc

1. Insert the disc into the optical drive.
2. When the installation wizard opens, follow the on-screen instructions.
3. Restart the computer if prompted to do so.

Audio

Your computer enables you to use a variety of audio features:

- Play music using your computer speakers and/or connected external speakers
- Record sound using the internal microphone or connect an external microphone
- Download music from the Internet
- Create multimedia presentations using audio and images
- Transmit sound and images with instant messaging programs
- Stream radio programs (select models only) or receive FM radio signals
- Create or “burn” audio CDs (select models only)

Connecting external audio devices

⚠ WARNING! To reduce the risk of personal injury, adjust the volume before putting on headphones, earbuds, or a headset. For additional safety information, refer to the *Regulatory, Safety and Environmental Notices*.

To connect external devices such as external speakers, headphones, or a microphone, refer to the information provided with the device. For best results, remember the following tips:

- Be sure that the device cable is securely connected to the correct jack on your computer. (Cable connectors are normally color-coded to match the corresponding jacks on the computer.)
- Be sure to install any drivers required by the external device.

📝 NOTE: A driver is a required program that acts like a translator between the device and the programs that use the device.

Checking your audio functions

To check the system sound on your computer, follow these steps:

1. Select **Start > Control Panel**.
2. Click **Hardware and Sound**.
3. Click **Sound**.
4. When the Sound window opens, click the **Sounds** tab. Under **Program Events**, select any sound event, such as a beep or alarm, and click the **Test** button.

You should hear sound through the speakers or through connected headphones.

To check the record functions of the computer, follow these steps:

1. Select **Start > All Programs > Accessories > Sound Recorder**.
2. Click **Start Recording** and speak into the microphone. Save the file to your desktop.
3. Open Windows Media Player and play back the sound.

 **NOTE:** For best results when recording, speak directly into the microphone and record sound in a setting free of background noise.

To confirm or change the audio settings on your computer, select **Start > Control Panel > Hardware and Sound > Sound**.

Antenna House XSL Formatter

Video

Your computer enables you to use a variety of video features:

- Watch movies
- Play games over the Internet
- Edit pictures and video to create presentations
- Connect external video devices

Connecting an external monitor or projector

Your computer has an external monitor port that allows you to connect external monitors and projectors.

Using the external monitor port

The external monitor port connects an external display device, such as an external monitor or a projector, to the computer.

- ▲ To connect a display device, connect the device cable to the external monitor port.

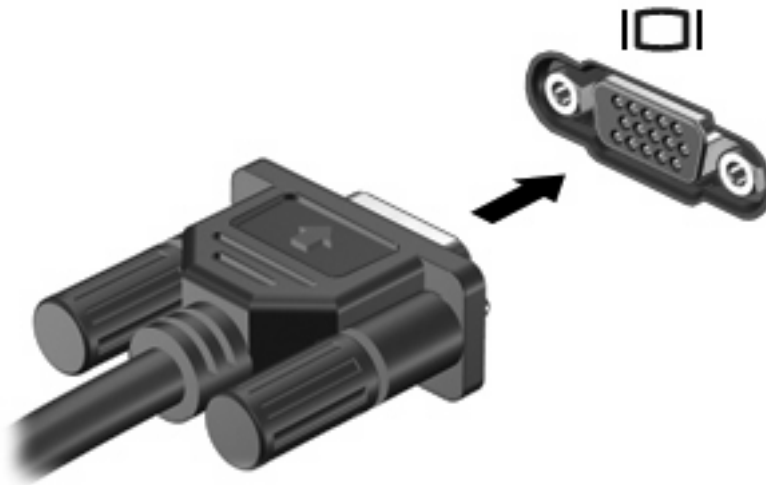

NOTE: If a properly connected external display device does not display an image, press **fn+f4** to transfer the image to the device. Repeatedly pressing **fn+f4** alternates the screen image between the computer display and the device.

Using the DreamColor display (select models only)

Computer models with the HP DreamColor display include the preinstalled HP Mobile Display Assistant software. You can use this program to adjust display color settings such as preset color space, white point/color temperature, and luminance/brightness.

- ▲ To access Mobile Display Assistant, click the Mobile Display Assistant icon in the notification area, at the far right of the taskbar or select **Start > All Programs > Mobile Display Assistant**.

For more information on using Mobile Display Assistant, refer to the software Help.

Webcam

 **NOTE:** This section describes features that are common to most models. Some features may not be available on your computer.

Your computer includes an integrated webcam, located at the top of the display. With the preinstalled software, you can use the webcam to take a photo, record a video, or make an audio recording. You can preview the photo, video recording, or audio recording, and save it on your computer hard drive.

To access the webcam and HP Webcam software, select **Start > All Programs > HP Webcam Application**.

The webcam software enables you to experiment with the following features:

- Video—Record and play back webcam video.
- Audio—Record and play back audio.
- Streaming video—Use with instant message software solutions that support UVC (Universal Video Class) cameras.
- Snapshots—Take still photos.
- HP Presto! Bizcard (select models only)—Use to transform business cards into a usable database of contact information.

Webcam tips

For optimum performance, observe the following guidelines while using the webcam:

- Be sure that you have the latest version of an instant message program before starting a video conversation.
- The webcam may not work properly across some network firewalls.

 **NOTE:** If you are having trouble viewing or sending multimedia files to someone on another LAN or outside your network firewall, temporarily disable the firewall, perform the task you want to perform, and then reenable the firewall. To permanently resolve the problem, reconfigure the firewall as necessary, and adjust the policies and settings of other intrusion detection systems. For additional information, contact your network administrator or IT department.

- Whenever possible, place bright light sources behind the webcam and out of the picture area.

 **NOTE:** For details about using your webcam, refer to the webcam software Help.

Adjusting webcam properties

You can adjust webcam properties using the Properties dialog box, which is accessible from various programs that use the integrated webcam, usually from a configuration, settings, or properties menu:

- **Brightness**—Controls the amount of light that is incorporated into the image. A higher brightness setting creates a brighter image; a lower brightness setting creates a darker image.
- **Contrast**—Controls the difference between lighter and darker areas on the image. A higher contrast setting intensifies the image; a lower contrast setting maintains more of the original information's dynamic range, but leads to a flatter image.

- **Hue**—Controls the aspect of color that distinguishes it from another color (what makes a color red, green, or blue). Hue is distinct from saturation, which measures the intensity of the hue.
- **Saturation**—Controls the strength of color in the final image. A higher saturation setting creates a bolder image; a lower saturation setting creates a more subtle image.
- **Sharpness**—Controls the definition of edges in an image. A higher sharpness setting creates a more defined image; a lower sharpness setting creates a softer image.
- **Gamma**—Controls the contrast affecting the mid-level grays or midtones of an image. Adjusting the gamma of an image allows you to change the brightness values of the middle range of gray tones without dramatically altering the shadows and highlights. A lower gamma setting makes grays look black, and makes dark colors even darker.

For information about using the webcam, select **Start > Help and Support**.

Capturing business card images

You can use the webcam with the Presto! BizCard program to capture business card images and export the text to many types of address book software, such as Microsoft® Outlook Contacts.

To capture a business card image:

1. Open Presto! BizCard by selecting **Start > All Programs > NewSoft > Presto! BizCard > Presto! BizCard**.
2. To capture one business card, select **File > Snap One Card and Recognize**.
– or –
To capture multiple business cards, select **File > Snap Cards and Recognize**.
The Preview window opens.
3. Slowly lower the display (1) until the webcam light (2) stops blinking and you hear a sound.



The webcam is now in focus.

4. Insert a business card into the business card slot on the front of the computer (1) and slide the card to the right (2) to align it with the webcam.

 **NOTE:** Be sure that text on the bottom of the card is not obscured by the slot. If any text is obscured by the slot, rotate the card 180 degrees.

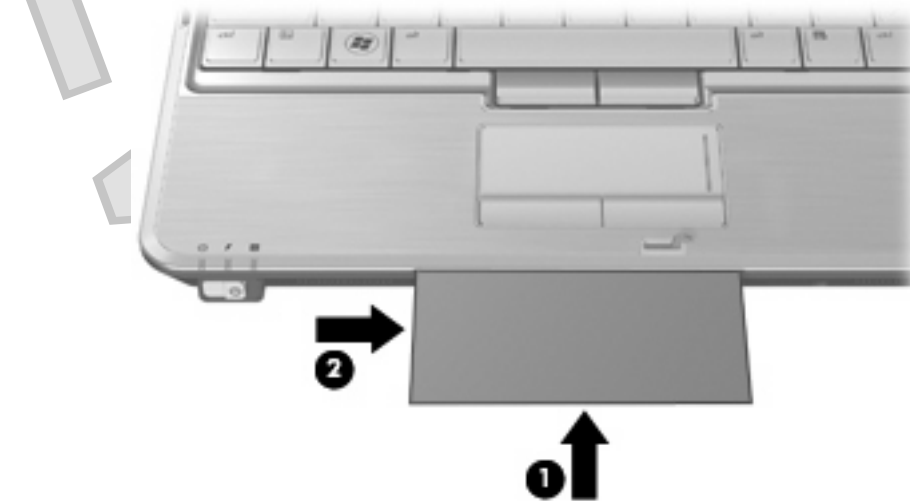

The webcam captures the business card image and the webcam light turns off.

5. If you are capturing multiple business card images, remove the business card and insert another one. The webcam light turns on when the card is in focus. The webcam then captures the business card image and the webcam light turns off.
Repeat this step for additional business cards.
6. When you have finished capturing one or more business card images, remove the business card from the slot and raise the display.
7. Review the data captured by Presto! BizCard to be sure that it is complete.

For more information on using Presto! BizCard, refer to the software Help.

6 Power management

Setting power options

Using power-saving states

The computer has two power-saving states enabled at the factory: Sleep and Hibernation.

When Sleep is initiated, the power lights blink and the screen clears. Your work is saved to memory. Exiting Sleep is faster than exiting Hibernation. If the computer is in the Sleep state for an extended period or if the battery reaches a critical battery level while in the Sleep state, the computer initiates Hibernation.

When Hibernation is initiated, your work is saved to a hibernation file on the hard drive and the computer turns off.

△ **CAUTION:** To prevent possible audio and video degradation, loss of audio or video playback functionality, or loss of information, do not initiate Sleep or Hibernation while reading from or writing to a disc or an external media card.

📝 **NOTE:** You cannot initiate any type of networking connection or perform any computer functions while the computer is in the Sleep state or in Hibernation.

NOTE: When HP 3D DriveGuard has parked a drive, the computer will not initiate Sleep or Hibernation, and the display will be turned off.

Initiating and exiting Sleep

The system is set at the factory to initiate Sleep after 15 minutes of inactivity when running on battery power and 30 minutes of inactivity when running on external power.

Power settings and timeouts can be changed using Power Options in Windows® Control Panel.

With the computer on, you can initiate Sleep in any of the following ways:

- Press **fn+f3**.
- Click **Start**, and then click the **Power** button.
- Click **Start**, click the arrow next to the Lock button, and then click **Sleep**.

To exit Sleep:

- ▲ Briefly slide the power switch to the right.

When the computer exits Sleep, the power lights turn on and your work returns to the screen where you stopped working.

 **NOTE:** If you have set a password to be required when the computer exits Sleep, you must enter your Windows password before your work will return to the screen.

Initiating and exiting Hibernation

The system is set at the factory to initiate Hibernation after 1080 minutes (18 hours) of inactivity when running on battery power, 1080 minutes (18 hours) of inactivity when running on external power, or when the battery reaches a critical battery level.

Power settings and timeouts can be changed using Power Options in Windows Control Panel.

To initiate Hibernation:

1. Click **Start**, and then click the arrow next to the Lock button.
2. Click **Hibernate**.

To exit Hibernation:

- ▲ Briefly slide the power switch to the right.

The power lights turn on and your work returns to the screen where you stopped working.

 **NOTE:** If you have set a password to be required when the computer exits Hibernation, you must enter your Windows password before your work will return to the screen.

Using the battery meter

The battery meter is located in the notification area, at the far right of the taskbar. The battery meter allows you to quickly access power settings, view remaining battery charge, and select a different power plan.

- To display the percentage of remaining battery charge and the current power plan, move the pointer over the battery meter icon.
- To access Power Options, or to change the power plan, click the battery meter icon and select an item from the list.

Different battery meter icons indicate whether the computer is running on battery or external power. The icon also displays a message if the battery has reached a critical battery level.

To hide or display the battery meter icon:

1. Right-click the taskbar, and then click **Properties**.
2. Click the **Notification Area** tab.
3. Under **System icons**, clear the **Power** check box to hide the battery meter icon, or select the **Power** check box to display the battery meter icon.
4. Click **OK**.

Using power plans

A power plan is a collection of system settings that manages how the computer uses power. Power plans can help you conserve power or maximize performance.

You can change power plan settings or create your own power plan.

Viewing the current power plan

- ▲ Move the pointer over the battery meter icon in the notification area, at the far right of the taskbar.
– or –
Select **Start > Control Panel > System and Maintenance > Power Options**.

Selecting a different power plan

- ▲ Click the battery meter icon in the notification area, and then select a power plan from the list.
– or –
Select **Start > Control Panel > System and Maintenance > Power Options**, and then select a power plan from the list.

Customizing power plans

1. Click the battery meter icon in the notification area and then click **More power options**.
– or –
Select **Start > Control Panel > System and Maintenance > Power Options**.
2. Select a power plan, and then click **Change plan settings**.
3. Change the **Turn off the display** and **Put the computer to sleep** timeout settings, as needed.
4. To change additional settings, click **Change advanced power settings** and make your changes.

Setting password protection on wakeup

To set the computer to prompt for a password when the computer exits Sleep or Hibernation, follow these steps:

1. Select **Start > Control Panel > System and Maintenance > Power Options**.
2. In the left pane, click **Require a password on wakeup**.
3. Click **Change Settings that are currently unavailable**.
4. Click **Require a password (recommended)**.
5. Click **Save changes**.

Using external AC power

External AC power is supplied through one of the following devices:

⚠ **WARNING!** To reduce potential safety issues, use only the AC adapter provided with the computer, a replacement AC adapter provided by HP, or a compatible AC adapter purchased from HP.

- Approved AC adapter
- Optional docking device

Connect the computer to external AC power under any of the following conditions:

⚠ **WARNING!** Do not charge the computer battery while you are onboard aircraft.

- When you are charging or calibrating a battery
- When you are installing or modifying system software
- When you are writing information to a CD or DVD

When you connect the computer to external AC power, the following events occur:

- The battery begins to charge.
- If the computer is turned on, the battery meter icon in the notification area changes appearance.

When you disconnect external AC power, the following events occur:

- The computer switches to battery power.
- The display brightness is automatically decreased to save battery life. To increase display brightness, press the **fn+f10** hotkey or reconnect the AC adapter.

Connecting the AC adapter

⚠ **WARNING!** To reduce the risk of electric shock or damage to the equipment:

Plug the power cord into an AC outlet that is easily accessible at all times.

Disconnect power from the computer by unplugging the power cord from the AC outlet (not by unplugging the power cord from the computer).

If provided with a 3-pin attachment plug on the power cord, plug the cord into a grounded (earthed) 3-pin outlet. Do not disable the power cord grounding pin, for example, by attaching a 2-pin adapter. The grounding pin is an important safety feature.

To connect the computer to external AC power:

1. Plug the AC adapter into the power connector **(1)** on the computer.
2. Plug the power cord into the AC adapter **(2)**.

3. Plug the other end of the power cord into an AC outlet (3).



Using battery power

When a charged battery is in the computer and the computer is not plugged into external power, the computer runs on battery power. When the computer is plugged into external AC power, the computer runs on AC power.

If the computer contains a charged battery and is running on external AC power supplied through the AC adapter, the computer switches to battery power if the AC adapter is disconnected from the computer.

NOTE: The display brightness is decreased to save battery life when you disconnect AC power. To increase display brightness, use the **fn+f10** hotkey or reconnect the AC adapter.

You can keep a battery in the computer or in storage, depending on how you work. Keeping the battery in the computer whenever the computer is plugged into AC power charges the battery and also protects your work in case of a power outage. However, a battery in the computer slowly discharges when the computer is off and unplugged from external power.

WARNING! To reduce potential safety issues, use only the battery provided with the computer, a replacement battery provided by HP, or a compatible battery purchased from HP.

Computer battery life varies, depending on power management settings, programs running on the computer, display brightness, external devices connected to the computer, and other factors.

Finding battery information in Help and Support

The Battery information section of the Help and Support Learning Center provides the following tools and information:

- Battery Check tool to test battery performance
- Information on calibration, power management, and proper care and storage to maximize battery life
- Information on battery types, specifications, life cycles, and capacity

To access Battery information:

- ▲ Select **Start > Help and Support > Learning Center > Battery information**.

Using Battery Check

Battery Check provides information on the status of the battery installed in the computer.

To run Battery Check:

1. Connect the AC adapter to the computer.

 **NOTE:** The computer must be connected to external power for Battery Check to function properly.

2. Select **Start > Help and Support > Troubleshoot > Power, Thermal and Mechanical**, and then click the **Power** tab.

Battery Check examines the battery and its cells to see if they are functioning properly, and then reports the results of the examination.

Displaying the remaining battery charge

- ▲ Move the pointer over the battery meter icon in the notification area, at the far right of the taskbar.

– or –

View the estimated number of minutes of battery charge remaining in Windows Mobility Center:

- ▲ Click the battery meter icon, and then click **Windows Mobility Center**.

– or –

Select **Start > Control Panel > Mobile PC > Windows Mobility Center**.

The time shown indicates the approximate running time remaining on the battery *if the battery continues to provide power at the current level*. For example, the time remaining will decrease when a DVD is playing and will increase when a DVD stops playing.

Inserting or removing the battery

- △ **CAUTION:** Removing a battery that is the sole power source can cause loss of information. To prevent loss of information, save your work, and initiate Hibernation or shut down the computer through Windows before removing the battery.

To insert the battery:

1. Turn the computer upside down on a flat surface, with the battery bay toward you.
2. Align the tabs (1) on the battery with the notches on the battery bay.

3. Press the battery (2) into the battery bay until the battery clicks into place.



To remove the battery:

1. Turn the computer upside down on a flat surface, with the battery bay toward you.
2. Slide the battery release latch (1) to release the battery.
3. Pivot the battery upward (2), and remove the battery from the computer (3).



Charging a battery

WARNING! Do not charge the computer battery while you are onboard aircraft.

The battery charges whenever the computer is plugged into external power through an AC adapter, an optional power adapter, an optional expansion product, or an optional docking device.

The battery charges whether the computer is off or in use, but it charges faster when the computer is off.

Charging may take longer if a battery is new, has been unused for 2 weeks or more, or is much warmer or cooler than room temperature.

To prolong battery life and optimize the accuracy of battery charge displays, follow these recommendations:

- If you are charging a new battery, charge it fully before turning on the computer.
 - Charge the battery until the battery light turns off.
-  **NOTE:** If the computer is on while the battery is charging, the battery meter in the notification area may show 100 percent charge before the battery is fully charged.
- Allow the battery to discharge below 5 percent of a full charge through normal use before charging it.
 - If the battery has been unused for one month or more, calibrate the battery instead of simply charging it.

The battery light displays charge status:

- **On:** The battery is charging.
- **Blinking:** The battery has reached a low battery level or critical battery level and is not charging.
- **Off:** The battery is fully charged, in use, or not installed.

Maximizing battery discharge time

Battery discharge time varies, depending on the features you use while on battery power. Maximum discharge time gradually shortens as the battery storage capacity naturally degrades.

Tips for maximizing battery discharge time:

- Lower the brightness on the display.
- Check the **Power saver** setting in Power Options.
- Remove the battery from the computer when it is not being used or charged.
- Store the battery in a cool, dry location.

Managing low battery levels

The information in this section describes the alerts and system responses set at the factory. Some low-battery alerts and system responses can be changed using Power Options in Windows Control Panel. Preferences set using Power Options do not affect lights.

Identifying low battery levels

When a battery that is the sole power source for the computer reaches a low battery level, the battery light blinks.

If a low battery level is not resolved, the computer enters a critical battery level, and the battery light blinks rapidly.

The computer takes the following actions for a critical battery level:

- If Hibernation is enabled and the computer is on or in the Sleep state, the computer initiates Hibernation.
- If Hibernation is disabled and the computer is on or in the Sleep state, the computer remains briefly in the Sleep state, and then shuts down and loses any unsaved information.

Resolving a low battery level

△ **CAUTION:** To reduce the risk of losing information when the computer reaches a critical battery level and has initiated Hibernation, do not restore power until the power lights turn off.

Resolving a low battery level when external power is available

▲ Connect one of the following devices:

- AC adapter
- Optional expansion product or docking device
- Optional power adapter

Resolving a low battery level when a charged battery is available

1. Turn off the computer or initiate Hibernation.
2. Remove the discharged battery, and then insert a charged battery.
3. Turn on the computer.

Resolving a low battery level when no power source is available

▲ Initiate Hibernation.

– or –

Save your work and shut down the computer.

Resolving a low battery level when the computer cannot exit Hibernation

When the computer lacks sufficient power to exit Hibernation, follow these steps:

1. Insert a charged battery or plug the computer into external power.
2. Exit Hibernation by briefly sliding the power switch to the right.

Calibrating a battery

Calibrate a battery under the following conditions:

- When battery charge displays seem inaccurate
- When you observe a significant change in battery run time

Even if a battery is heavily used, it should not need to be calibrated more than once a month. It is also not necessary to calibrate a new battery.

Step 1: Fully charge the battery

△ **WARNING!** Do not charge the computer battery while you are onboard aircraft.

📝 **NOTE:** The battery charges whether the computer is off or in use, but it charges faster when the computer is off.

To fully charge the battery:

1. Insert the battery into the computer.
2. Connect the computer to an AC adapter, optional power adapter, optional expansion product, or optional docking device, and then plug the adapter or device into external power.

The battery light on the computer turns on.

3. Leave the computer plugged into external power until the battery is fully charged.

The battery light on the computer turns off.

Step 2: Disable Hibernation and Sleep

1. Click the battery meter icon in the notification area, and then click **More power options**.

– or –

Select **Start > Control Panel > System and Security > Power Options**.

2. Under the current power plan, click **Change plan settings**.
3. Record the **Turn off the display** and **Put the computer to sleep** settings listed in the **On battery** column so that you can reset them after the calibration.
4. Change the **Turn off the display** and **Put the computer to sleep** settings to **Never**.
5. Click **Change advanced power settings**.
6. Click the plus sign (+) next to **Sleep**, and then click the plus sign (+) next to **Hibernate after**.
7. Record the **On battery** setting under **Hibernate after** so that you can reset it after the calibration.
8. Change the **On battery** setting to **Never**.
9. Click **OK**.
10. Click **Save changes**.

Step 3: Discharge the battery

The computer must remain on while the battery is being discharged. The battery can discharge whether or not you are using the computer, but the battery will discharge faster while you are using it.

- If you plan to leave the computer unattended during the discharge, save your information before beginning the discharge procedure.
- If you use the computer occasionally during the discharge procedure and have set energy-saving timeouts, expect the following performance from the system during the discharge process:
 - The monitor will not turn off automatically.
 - Hard drive speed will not decrease automatically when the computer is idle.
 - System-initiated Hibernation will not occur.

To discharge a battery:

1. Unplug the computer from its external power source, but do *not* turn off the computer.
2. Run the computer on battery power until the battery is discharged. The battery light begins to blink when the battery has discharged to a low battery level. When the battery is discharged, the battery light turns off and the computer shuts down.

Step 4: Fully recharge the battery

To recharge the battery:

1. Plug the computer into external power and maintain external power until the battery is fully recharged. When the battery is recharged, the battery light on the computer turns off.

You can use the computer while the battery is recharging, but the battery will charge faster if the computer is off.

2. If the computer is off, turn it on when the battery is fully charged and the battery light has turned off.

Step 5: Reenable Hibernation and Sleep

△ **CAUTION:** Failure to reenable Hibernation after calibration may result in a full battery discharge and information loss if the computer reaches a critical battery level.

1. Click the battery meter icon in the notification area, and then click **More power options**.

– or –

Select **Start > Control Panel > System and Security > Power Options**.

2. Under the current power plan, click **Change plan settings**.

3. Reenter the settings that you recorded for the items in the **On battery** column.

– or –

Click **Restore default settings for this plan**, and then follow the on-screen instructions.

 **NOTE:** If you restore default settings, omit steps 4 through 8.

4. Click **Change advanced power settings**.

5. Click the plus sign (+) next to **Sleep**, and then click the plus sign (+) next to **Hibernate after**.

6. Reenter the setting that you recorded for **On battery**.

7. Click **OK**.

8. Click **Save changes**.

Conserving battery power

- Select low power-use settings through Power Options in Windows Control Panel.
- Turn off wireless and local area network (LAN) connections and exit modem applications when you are not using them.

- Disconnect external devices that are not plugged into an external power source, when you are not using them.
- Stop, disable, or remove any external media cards that you are not using.
- Use the **fn+f9** and **fn+f10** hotkeys to adjust screen brightness as needed.
- If you leave your work, initiate Sleep or Hibernation, or shut down the computer.

Storing a battery

- △ **CAUTION:** To prevent damage to a battery, do not expose it to high temperatures for extended periods of time.

If a computer will be unused and unplugged from external power for more than two weeks, remove the battery and store it separately.

To prolong the charge of a stored battery, place it in a cool, dry place.

- 📄 **NOTE:** A stored battery should be checked every six months. If the capacity is less than 50 percent, recharge the battery before returning it to storage.

Calibrate a battery before using it if it has been stored for one month or more.

Disposing of a used battery

- △ **WARNING!** To reduce the risk of fire or burns, do not disassemble, crush, or puncture a battery; short the external contacts on a battery; or dispose of a battery in fire or water. Do not expose a battery to temperatures above 60°C (140°F). Replace the battery only with a battery approved for this computer.

Refer to the *Regulatory, Safety and Environmental Notices* for battery disposal information.

Replacing the battery

Computer battery life varies, depending on the power management settings, programs running on the computer, display brightness, external devices connected to the computer, and other factors.

Battery Check notifies you to replace the battery when an internal cell is not charging properly, or when the battery storage capacity has reached a “weak” condition. A message refers you to the HP Web site for more information about ordering a replacement battery. If the battery is possibly covered by an HP warranty, instructions include a warranty ID.

- 📄 **NOTE:** To ensure that you always have battery power when you need it, HP recommends purchasing a new battery when the storage capacity indicator turns green-yellow.

Testing an AC adapter

Test the AC adapter if the computer exhibits any of the following symptoms:

- The computer will not turn on when connected to the AC adapter.
- The display does not turn on when the computer is connected to the AC adapter and external power.
- The power light is off when the computer is connected to the AC adapter.

To test the AC adapter:

1. Remove the battery from the computer.
2. Connect the AC adapter to the computer and to an AC outlet.
3. Turn on the computer.
 - If the power light turns **on**, the AC adapter is functioning properly.
 - If the power light remains **off**, the AC adapter is not functioning and should be replaced.

Contact technical support for information on obtaining a replacement AC power adapter. Select **Start > Help and Support > Get assistance**.

Shutting down the computer

△ **CAUTION:** Unsaved information will be lost when the computer is shut down.

The Shut down command closes all open programs, including the operating system, and then turns off the display and computer.

Shut down the computer under any of the following conditions:

- When you need to replace the battery or access components inside the computer
- When you are connecting an external hardware device that does not connect to a USB port
- When the computer will be unused and disconnected from external power for an extended period

Although you can shut down the computer with the power switch, the recommended procedure is to use the Windows Shut down command.

To shut down the computer, follow these steps:

📄 **NOTE:** If the computer is in the Sleep state or in Hibernation, you must first exit Sleep or Hibernation before shutdown is possible.

1. Save your work and close all open programs.
2. Click **Start**.
3. Click **Shut down**.

If the computer is unresponsive and you are unable to use the preceding shutdown procedures, try the following emergency procedures in the sequence provided:

- Slide the power switch to the right and hold it for at least 5 seconds.
- Disconnect the computer from external power and remove the battery.

7 Drives

Identifying installed drives

Your computer includes a hard drive (with a rotating disc) or a solid-state drive (SSD) with solid-state memory. Because it has no moving parts, an SSD does not generate as much heat as a hard drive.

To view the drives installed on the computer, select **Start > Computer**.

 **NOTE:** Windows includes the User Account Control feature to improve the security of your computer. You may be prompted for your permission or password for tasks such as installing applications, running utilities, or changing Windows settings. Refer to Help and Support for more information.

Handling drives

Drives are fragile computer components that must be handled with care. Refer to the following cautions before handling drives. Additional cautions are included with the procedures to which they apply.

- △ **CAUTION:** To reduce the risk of damage to the computer, damage to a drive, or loss of information, observe these precautions:

Before you move a computer or external hard drive from one location, initiate Sleep, and allow the screen to clear.

Before handling a drive, discharge static electricity by touching the unpainted metal surface of the drive.

Do not touch the connector pins on a removable drive or on the computer.

Handle a drive carefully; do not drop a drive or place items on it.

Before removing or inserting a drive, shut down the computer. If you are unsure whether the computer is off or in Hibernation, turn the computer on and then shut it down through the operating system.

Do not use excessive force when inserting a drive into a drive bay.

Do not type on the keyboard or move the computer while the optical drive is writing to a disc. The write process is sensitive to vibration.

When the battery is the only source of power, be sure that the battery is sufficiently charged before writing to media.

Avoid exposing a drive to temperature or humidity extremes.

Avoid exposing a drive to liquids. Do not spray the drive with cleaning products.

Remove media from a drive before removing the drive from the drive bay, or traveling with, shipping, or storing a drive.

If a drive must be mailed, place the drive in a bubble-pack mailer or other suitable protective packaging and label the package "FRAGILE."

Avoid exposing a drive to magnetic fields. Security devices with magnetic fields include airport walk-through devices and security wands. The airport security devices that check carry-on luggage, such as conveyor belts, use X-rays instead of magnetism and will not damage a drive.

Improving hard drive performance

Using Disk Defragmenter

As you use the computer, files on the hard drive become fragmented. Disk Defragmenter consolidates the fragmented files and folders on the hard drive so that the system can run more efficiently.

After you start Disk Defragmenter, it works without supervision. Depending on the size of your hard drive and the number of fragmented files, Disk Defragmenter may take more than an hour to complete. You may want to set it to run during the night or another time when you do not need access to your computer.

HP recommends defragmenting your hard drive at least once a month. You may set Disk Defragmenter to run on a monthly schedule, but you can defragment your computer manually at any time.

To run Disk Defragmenter:

1. Select **Start > All Programs > Accessories > System Tools > Disk Defragmenter**.
2. Click **Defragment disk**.

 **NOTE:** Windows includes the User Account Control feature to improve the security of your computer. You may be prompted for your permission or password for tasks such as installing software, running utilities, or changing Windows settings. Refer to Help and Support for more information.

For additional information, access the Disk Defragmenter software Help.

Using Disk Cleanup

Disk Cleanup searches the hard drive for unnecessary files that you can safely delete to free up disk space and help the computer to run more efficiently.

To run Disk Cleanup:

1. Select **Start > All Programs > Accessories > System Tools > Disk Cleanup**.
2. Follow the on-screen instructions.

Using HP 3D DriveGuard

HP 3D DriveGuard protects the hard drive by parking the drive and halting I/O requests under either of the following conditions:

- You drop the computer.
- You move the computer with the display closed while the computer is running on battery power.

A short time after the end of one of these events, HP 3D DriveGuard returns the hard drive to normal operation.

 **NOTE:** If the upgrade bay contains a hard drive, the hard drive is protected by HP 3D DriveGuard. Hard drives installed in optional docking devices or connected to USB ports are not protected by HP 3D DriveGuard.

Because solid-state drives lack rotating parts, protection by HP 3D DriveGuard is unnecessary.

For more information, refer to the HP 3D DriveGuard software Help.

Identifying HP 3D DriveGuard status

The drive light on the computer changes to an amber color to show that the drive is parked. To determine whether drives are currently protected or whether a drive is parked, select **Start > Control Panel > Hardware and Sound > Windows Mobility Center**:

- If the software is enabled, a green check mark is superimposed over the hard drive icon.
- If the software is disabled, a white diagonal line is superimposed over the hard drive icon.
- If the drives are parked, a yellow moon is superimposed over the hard drive icon.

 **NOTE:** The icon in the Mobility Center may not show the most up-to-date status for the drive. For immediate updates after a change in status, you need to enable the notification area icon.

To enable the notification area icon:

1. Select **Start > Control Panel > Hardware and Sound > HP 3D DriveGuard**.

 **NOTE:** If prompted by User Account Control, click **Yes**.

2. On the **Icon in system tray** row, click **Show**.
3. Click **OK**.

If HP 3D DriveGuard has parked the drive, the computer will behave in the following ways:

- The computer will not shut down.
- The computer will not initiate Sleep or Hibernation, except as described in the following Note.

 **NOTE:** If the computer is running on battery power and reaches a critical battery level, HP 3D DriveGuard allows the computer to initiate Hibernation.

Before you move the computer, HP recommends that you either shut it down, or initiate Sleep or Hibernation.

Using HP 3D DriveGuard software

The HP 3D DriveGuard software enables you to perform the following tasks:

- Enable and disable HP 3D DriveGuard.

 **NOTE:** Permission to enable or disable HP 3D DriveGuard is dependent on certain user privileges. Members of an Administrator group can change privileges for non-Administrator users.

- Determine whether a drive in the system is supported.

To open the software and change settings, follow these steps:

1. In Mobility Center, click the hard drive icon to open the HP 3D DriveGuard window.

– or –

Select **Start > Control Panel > Hardware and Sound > HP 3D DriveGuard**.

 **NOTE:** If prompted by User Account Control, click **Yes**.

2. Click the appropriate button to change settings.
3. Click **OK**.

Replacing the hard drive in the hard drive bay

△ **CAUTION:** To prevent information loss or an unresponsive system:

Shut down the computer before removing the hard drive from the hard drive bay. Do not remove the hard drive while the computer is on, in the Sleep state, or in Hibernation.

If you are not sure whether the computer is off or in Hibernation, turn the computer on by sliding the power switch to the right. Then shut down the computer through the operating system.

To remove a hard drive:

1. Save your work.
2. Shut down the computer and close the display.
3. Disconnect all external hardware devices connected to the computer.
4. Unplug the power cord from the AC outlet.
5. Turn the computer upside down on a flat surface, with the hard drive bay toward you.
6. Remove the battery from the computer.
7. Loosen the 3 hard drive cover screws (1).
8. Remove the hard drive cover (2).

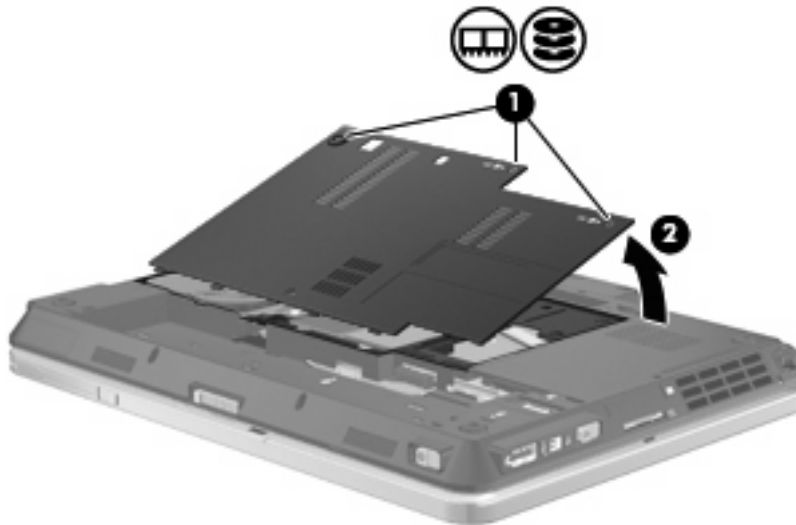

9. Remove the 2 hard drive bracket screws (1).

10. Remove the hard drive bracket (2).

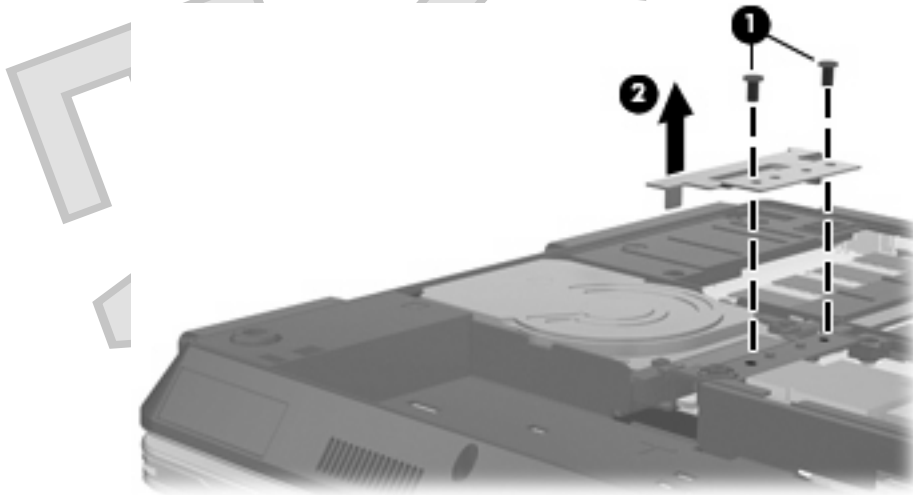

11. Grasp the mylar tab on the hard drive and pull upward (1) until the hard drive is at a 45-degree angle.
12. With the hard drive at a 45-degree angle, pull it forward (2) until the rear of the hard drive is clear of the computer back edge.
13. Lift the hard drive (3) out of the hard drive bay.

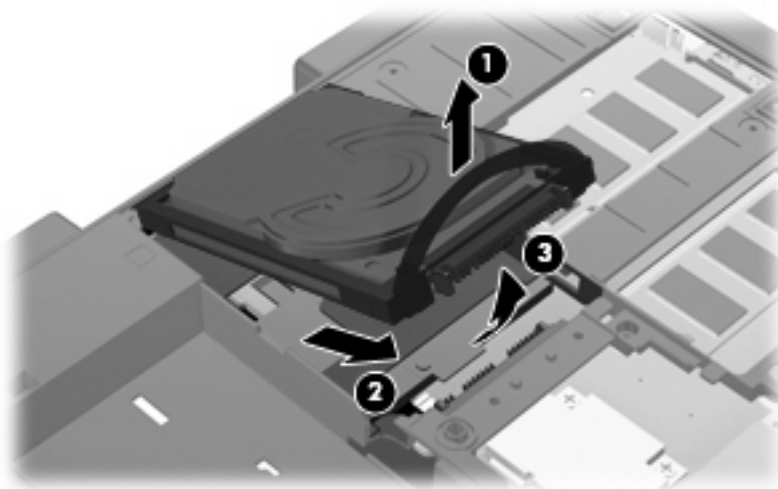

To install a hard drive:

1. Insert the rear of the hard drive at a 45-degree angle into the back of the hard drive bay (1).

2. Lower the front of the hard drive down onto the system board connector (2), and then press down (3) to connect the hard drive.

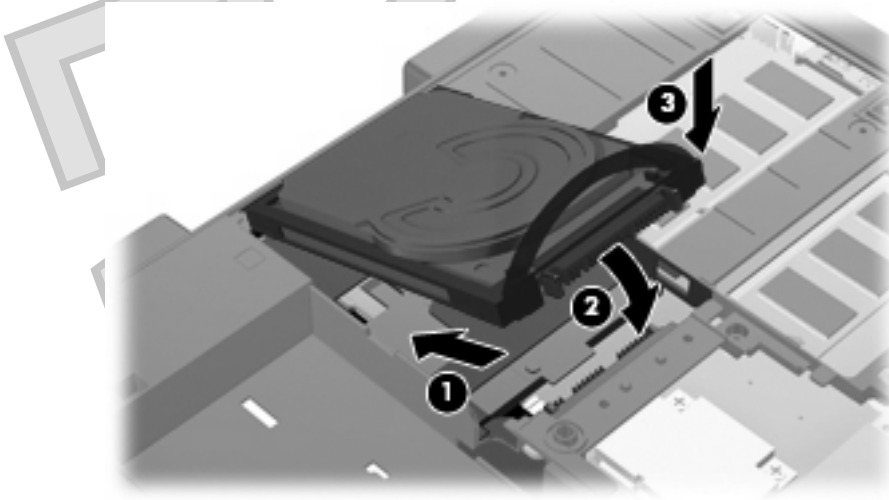

3. Replace the hard drive bracket (1).
4. Replace the 2 hard drive bracket screws (2).

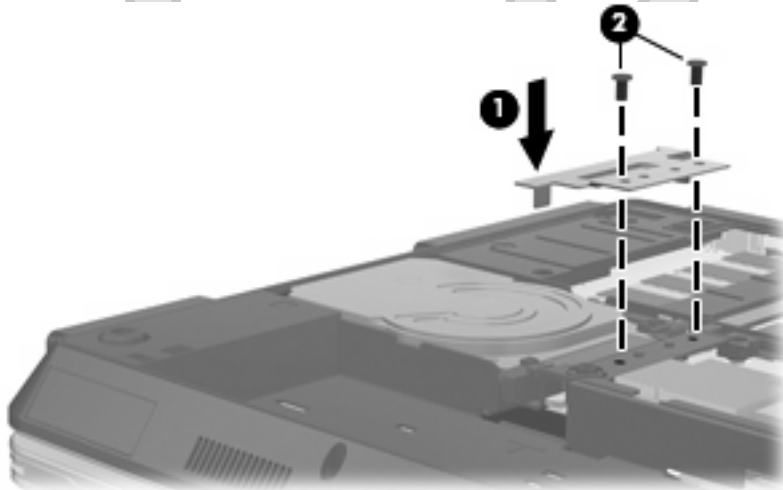

5. Align the tabs (1) on the hard drive cover with the notches on the computer.
6. Close the cover (2).

7. Tighten the 3 hard drive cover screws (3).

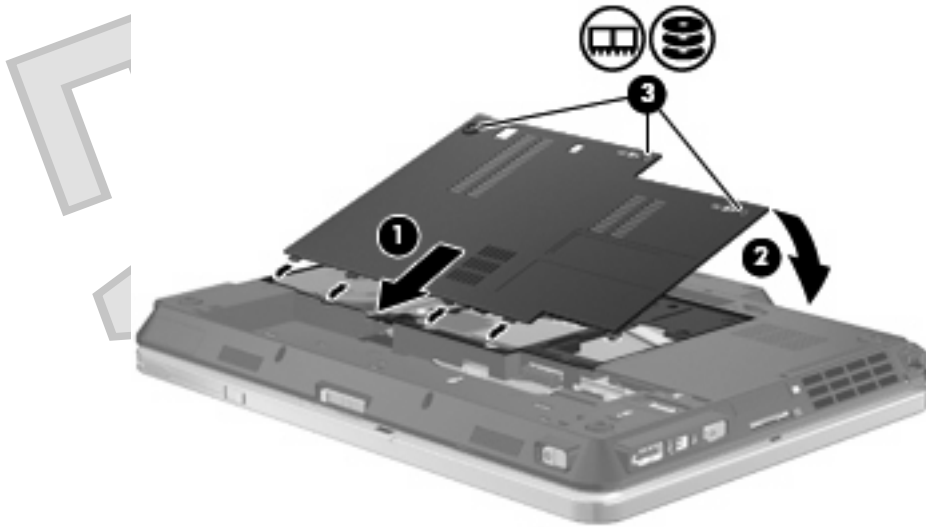

8. Replace the battery.
9. Turn the computer right-side up, and then reconnect external power and external devices.
10. Turn on the computer.

8 External devices

Using a USB device

Universal Serial Bus (USB) is a hardware interface that can be used to connect an optional external device, such as a USB keyboard, mouse, drive, printer, scanner, or hub.

Some USB devices may require additional support software, which is usually included with the device. For more information about device-specific software, refer to the manufacturer's instructions.

Your computer model has 3 USB ports, which support USB 1.0, USB 1.1, and USB 2.0 devices. A USB hub provides additional USB ports that can be used with the computer.

Connecting a USB device

△ **CAUTION:** To prevent damage to a USB connector, use minimal force to connect a USB device.

▲ To connect a USB device to the computer, connect the USB cable for the device to the USB port.

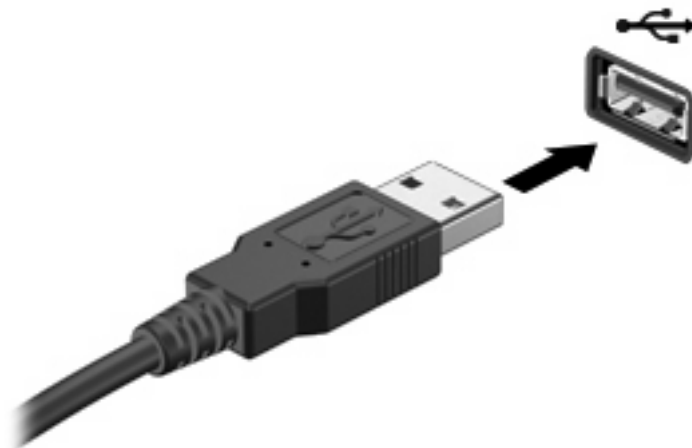

You will hear a sound when the device has been detected.

📄 **NOTE:** The first time you connect a USB device, a message is displayed in the notification area to let you know the device is recognized by the computer.

Stopping and removing a USB device

△ **CAUTION:** To prevent loss of information or an unresponsive system, stop a USB device before removing it.

CAUTION: To prevent damage to a USB connector, do not pull on the cable to remove the USB device.

To stop and remove a USB device:

1. Double-click the **Safely Remove Hardware** icon in the notification area, at the far right of the taskbar.

 **NOTE:** To display the Safely Remove Hardware icon, click the **Show Hidden Icons** icon (< or <<) in the notification area.

2. Click the name of the device in the list.

 **NOTE:** If the USB device is not listed, you do not have to stop the device before you remove it.

3. Click **Stop**, and then click **OK**.

4. Remove the device.

Using USB legacy support

USB legacy support (enabled at the factory) permits the following actions:

- Using a USB keyboard, mouse, or hub connected to a USB port on the computer during startup or in an MS-DOS-based program or utility
- Starting or restarting from an optional external MultiBay or an optional USB bootable device

To disable or reenble USB legacy support in Computer Setup, follow these steps:

1. Turn on or restart the computer, and then press **esc** while the “Press the ESC key for Startup Menu” message is displayed at the bottom of the screen.
2. Press **f10** to enter the BIOS Setup.
3. Use a pointing device or the arrow keys to select **System Configuration**, and then select **Device Configurations**.
4. To disable USB legacy support, click **Disabled** next to **USB legacy support**. To reenble USB legacy support, click **Enabled** next to **USB legacy support**.
5. To save your changes and exit Computer Setup, click **Save** in the lower-left corner of the screen, and then follow the on-screen instructions.

– or –

Use the arrow keys to select **File > Save changes and exit**, and then follow the on-screen instructions.

Your changes go into effect when the computer restarts.

Using a 1394 device

IEEE 1394 is a hardware interface that connects a high-speed multimedia or data storage device to the computer. Scanners, digital cameras, and digital camcorders often require a 1394 connection.

Some 1394 devices may require additional support software, which is usually included with the device. For more information about device-specific software, refer to the manufacturer's instructions.

The 1394 port also supports IEEE 1394a devices.

Connecting a 1394 device

- △ **CAUTION:** To prevent damage to a 1394 port connector, use minimal force when connecting a 1394 device.
- ▲ To connect a 1394 device to the computer, connect the 1394 cable for the device to the 1394 port.

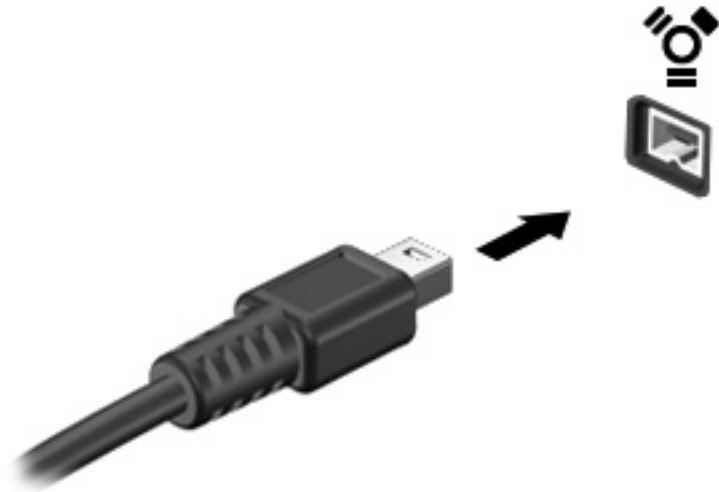

You will hear a sound when the device has been detected.

Stopping and removing a 1394 device

- △ **CAUTION:** To prevent loss of information or an unresponsive system, stop the 1394 device before removing it.

CAUTION: To prevent damage to a 1394 connector, do not pull on the cable to remove the 1394 device.

1. Double-click the **Safely Remove Hardware** icon in the notification area, at the far right of the taskbar.

📄 **NOTE:** To display the Safely Remove Hardware icon, click the **Show Hidden Icons** icon (< or <<) in the notification area.

2. Click the name of the device in the list.

📄 **NOTE:** If the device is not listed, you do not have to stop the device before you remove it.

3. Click **Stop**, and then click **OK**.
4. Remove the device.

Using external drives

Removable external drives expand your options for storing and accessing information. A USB drive can be added by connecting the drive to a USB port on the computer.

USB drives include the following types:

- 1.44-megabyte diskette drive
- Hard drive module (a hard drive with an adapter attached)
- DVD-ROM Drive
- DVD/CD-RW Combo Drive
- DVD±RW/CD-RW Combo Drive

Using optional external devices

 **NOTE:** For more information about required software and drivers, or to learn which computer port to use, refer to the manufacturer's instructions.

To connect an external device to the computer:

△ **CAUTION:** To reduce the risk of damage to the equipment when connecting a powered device, be sure that the device is turned off and the AC power cord is unplugged.

1. Connect the device to the computer.
2. If you are connecting a powered device, plug the device power cord into a grounded AC outlet.
3. Turn on the device.

To disconnect an unpowered external device, turn off the device, and then disconnect it from the computer. To disconnect a powered external device, turn off the device, disconnect it from the computer, and then unplug the AC power cord.

Using the docking connector

The docking connector connects the computer to an optional docking device. An optional docking device provides additional ports and connectors that can be used with the computer.

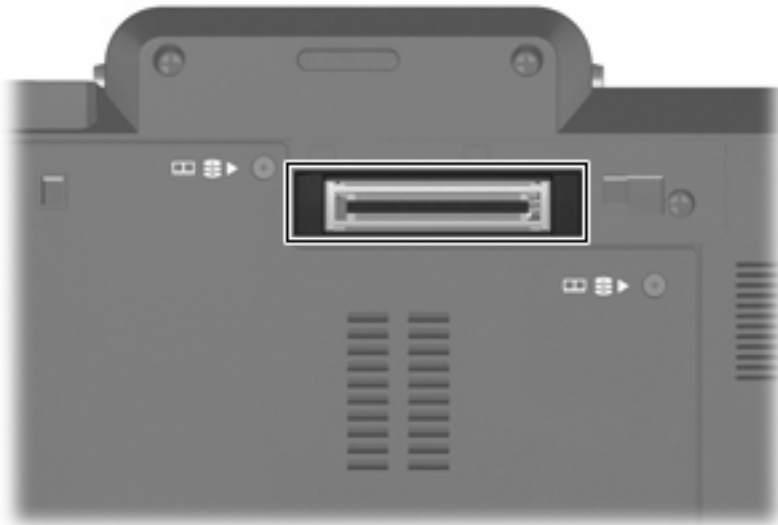

9 External media cards

Using Media Card Reader cards

Optional digital cards provide secure data storage and convenient data sharing. These cards are often used with digital media-equipped cameras and PDAs as well as with other computers.

The Digital Media Slot supports the following digital card formats:

- Memory Stick (MS)
- Memory Stick Pro (MSP)
- MultiMediaCard (MMC)
- Secure Digital Input/Output (SD I/O)
- Secure Digital (SD) Memory Card
- xD-Picture Card (XD)
- xD-Picture Card (XD) Type H
- xD-Picture Card (XD) Type M

Inserting a digital card

△ **CAUTION:** To avoid damaging the digital card or the computer, do not insert any type of adapter into the SD Card Reader.

CAUTION: To prevent damage to the digital card connectors, use minimal force to insert a digital card.

1. Hold the digital card label-side up, with the connectors facing the computer.

2. Insert the card into the Media Card Reader, and then push in on the card until it is firmly seated.

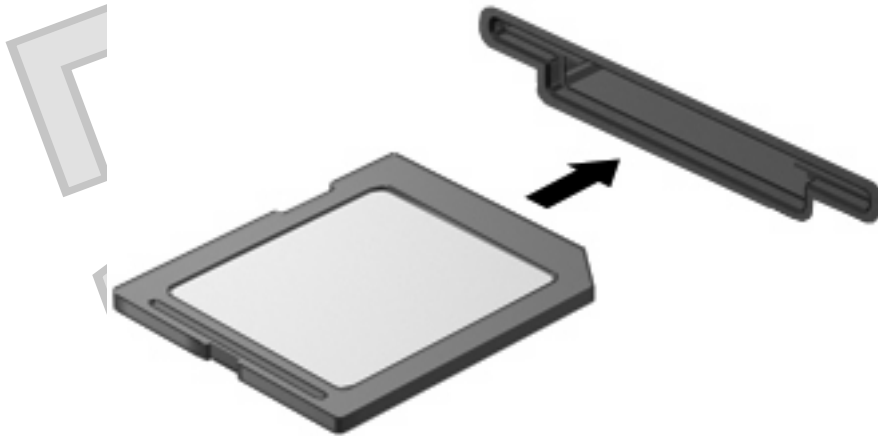

You will hear a sound when the device has been detected, and a menu of available options may be displayed.

Stopping and removing a digital card

△ **CAUTION:** To prevent loss of data or an unresponsive system, stop a digital card before removing it.

1. Save your information and close all programs associated with the digital card.

📝 **NOTE:** To stop a data transfer, click **Cancel** in the operating system Copying window.

2. Stop the digital card:

- a. Double-click the **Safely Remove Hardware** icon in the notification area, at the far right of the taskbar.

📝 **NOTE:** To display the Safely Remove Hardware icon, click the **Show Hidden Icons** icon (< or <<) in the notification area.

- b. Click the name of the digital card in the list.
- c. Click **Stop**, and then click **OK**.

3. Press in on the digital card (1), and then remove the card from the slot (2).

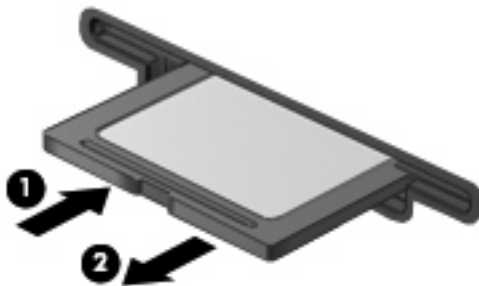

Using ExpressCards (select models only)

An ExpressCard is a high-performance PC Card that is inserted into the ExpressCard slot.

Like standard PC Cards, ExpressCards are designed to conform to the standard specifications of the Personal Computer Memory Card International Association (PCMCIA).

Configuring an ExpressCard

Install only the software required for your device. If you are instructed by the ExpressCard manufacturer to install device drivers:

- Install only the device drivers for your operating system.
- Do not install other software, such as card services, socket services, or enablers, supplied by the ExpressCard manufacturer.

Inserting an ExpressCard

△ **CAUTION:** To prevent damage to the computer and external media cards, do not insert a PC Card into an ExpressCard slot.

CAUTION: To prevent damage to the connectors:

Use minimal force when inserting an ExpressCard.

Do not move or transport the computer when an ExpressCard is in use.

The ExpressCard slot may contain a protective insert. To remove the insert:

1. Press in on the insert (1) to unlock it.
2. Pull the insert out of the slot (2).



To insert an ExpressCard:

1. Hold the card label-side up, with the connectors facing the computer.

2. Insert the card into the ExpressCard slot, and then push in on the card until it is firmly seated.

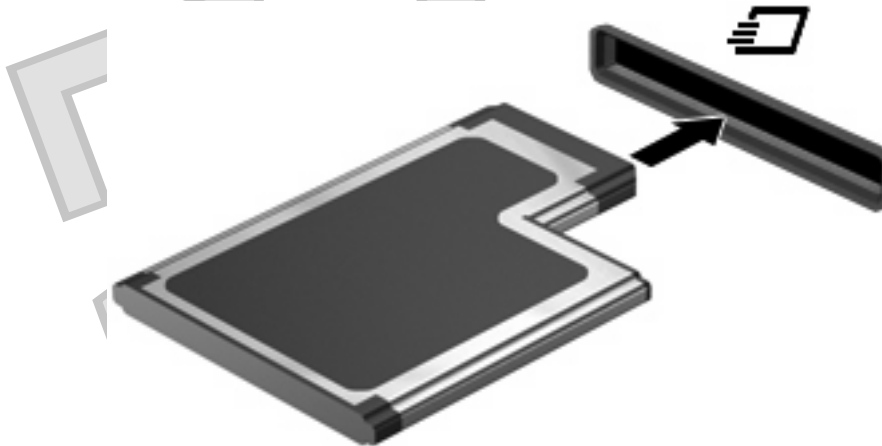

You will hear a sound when the device has been detected, and a menu of options may be displayed.

 **NOTE:** The first time you insert an ExpressCard, a message is displayed in the notification area to let you know the device is recognized by the computer.

 **NOTE:** An inserted ExpressCard uses power even when idle. To conserve power, stop or remove an ExpressCard when it is not in use.

Stopping and removing an ExpressCard

 **CAUTION:** To prevent loss of data or an unresponsive system, stop an ExpressCard before removing it.

1. Save your information and close all programs associated with the ExpressCard.

 **NOTE:** To stop a data transfer, click **Cancel** in the operating system Copying window.

2. Stop the ExpressCard:

- a. Double-click the **Safely Remove Hardware** icon in the notification area, at the far right of the taskbar.

 **NOTE:** To display the Safely Remove Hardware icon, click the **Show Hidden Icons** icon (< or <<) in the notification area.

- b. Click the name of the ExpressCard in the list.

- c. Click **Stop**, and then click **OK**.

3. Release and remove the ExpressCard:

- a. Gently press in on the ExpressCard **(1)** to unlock it.

- b. Pull the ExpressCard out of the slot **(2)**.

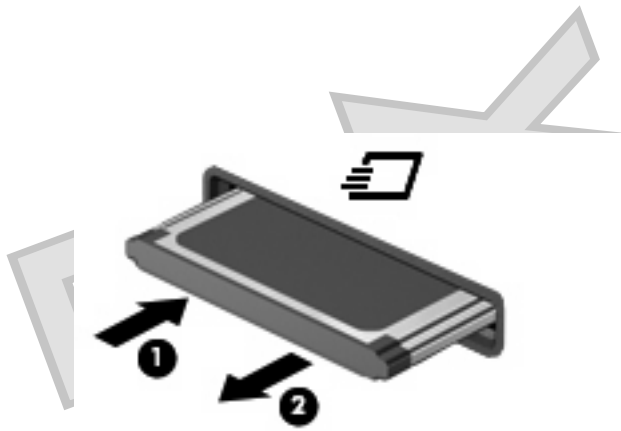

ANTENNA HOUSE XSL FORMATTER

Using Smart Cards (select models only)

 **NOTE:** The term *smart card* is used throughout this chapter to refer to both smart cards and Java™ Cards.

A smart card is a credit card–sized accessory that carries a microchip containing memory and a microprocessor. Like personal computers, smart cards have an operating system to manage input and output, and they include security features to protect against tampering. Industry-standard smart cards are used with the smart card reader (select models only).

A PIN is needed to gain access to the contents of the microchip. For more information about smart card security features, refer to Help and Support.

 **NOTE:** Your computer may look slightly different from the illustrations in this chapter.

Inserting a smart card

To insert a smart card:

1. Holding the smart card label-side up, gently slide the card into the smart card reader until the card is seated.

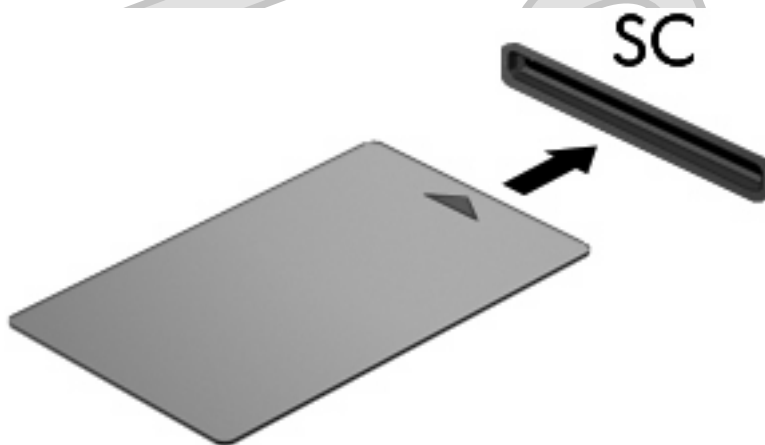

2. Follow the on-screen instructions for logging on to the computer using the smart card PIN.

Removing a smart card

To remove a smart card:

- ▲ Grasp the edge of the smart card, and pull it out of the smart card reader.



10 Memory modules

The computer has one memory module compartment located on the bottom of the computer.

The memory capacity of the computer can be upgraded by adding a memory module to the vacant expansion memory module slot or by upgrading the existing memory module in the memory module slot.

- ⚠ **WARNING!** To reduce the risk of electric shock and damage to the equipment, unplug the power cord and remove all batteries before installing a memory module.
- ⚠ **CAUTION:** Electrostatic discharge (ESD) can damage electronic components. Before beginning any procedure, touch a grounded metal object to be sure that you are discharged of static electricity.

Adding or replacing a memory module

To add or replace a memory module in the memory module slot, follow these steps:

1. Save your work.
2. Shut down the computer.

If you are not sure whether the computer is off or in Hibernation, turn the computer on by sliding the power switch to the right. Then shut down the computer through the operating system.

3. Disconnect all external devices connected to the computer.
4. Unplug the power cord from the AC outlet.
5. Turn the computer upside down on a flat surface.
6. Remove all batteries from the computer.
7. Loosen the 3 hard drive compartment cover screws (1).
8. Lift the hard drive compartment cover away from the computer (2).

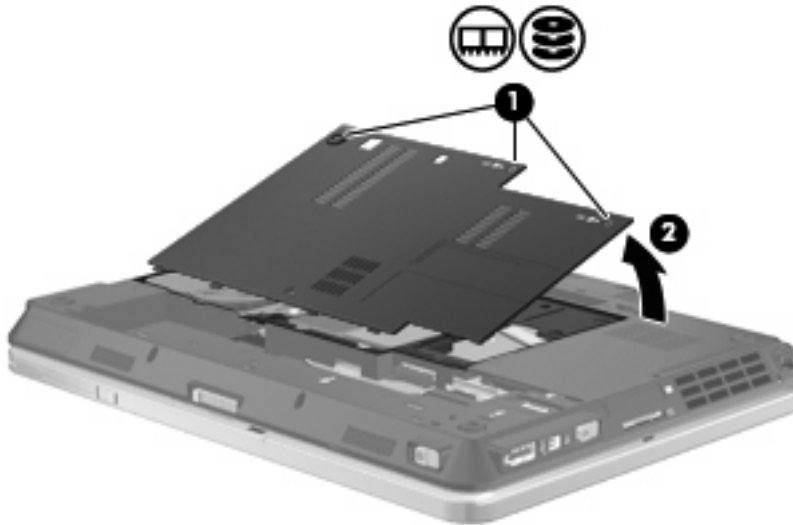

9. If you are replacing a memory module, remove the existing memory module:

- a. Pull away the retention clips (1) on each side of the memory module.
The memory module tilts up.

△ **CAUTION:** To prevent damage to the memory module, hold the memory module by the edges only. Do not touch the components on the memory module.

- b. Grasp the edge of the memory module (2), and gently pull the module out of the memory module slot.

To protect a memory module after removal, place it in an electrostatic-safe container.

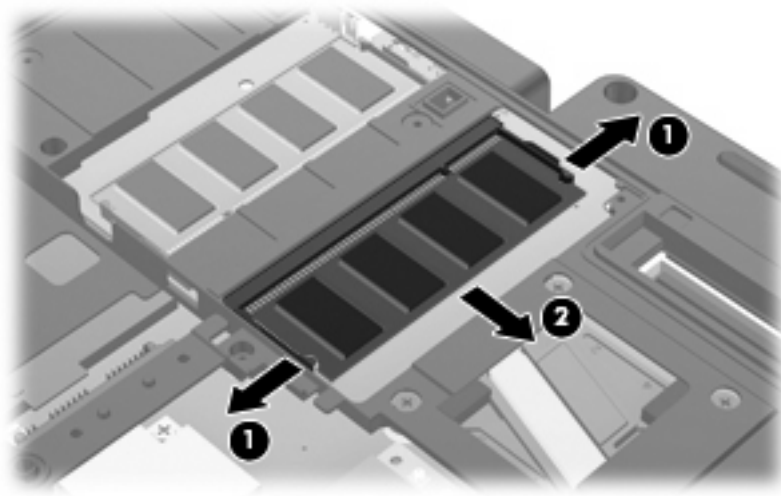

10. Insert a memory module:

 **NOTE:** If you are inserting a memory module and both memory module slots are vacant, be sure that you insert the memory module into the primary memory module slot.

- a. Align the notched edge (1) of the memory module with the tab in the memory module slot.
 - △ **CAUTION:** To prevent damage to the memory module, hold the memory module by the edges only. Do not touch the components on the memory module and do not bend the memory module.
- b. With the memory module at a 45-degree angle from the surface of the memory module compartment, press the module (2) into the memory module slot until it is seated.
- c. Gently press the memory module (3) down, applying pressure to both the left and right edges of the memory module, until the retention clips snap into place.

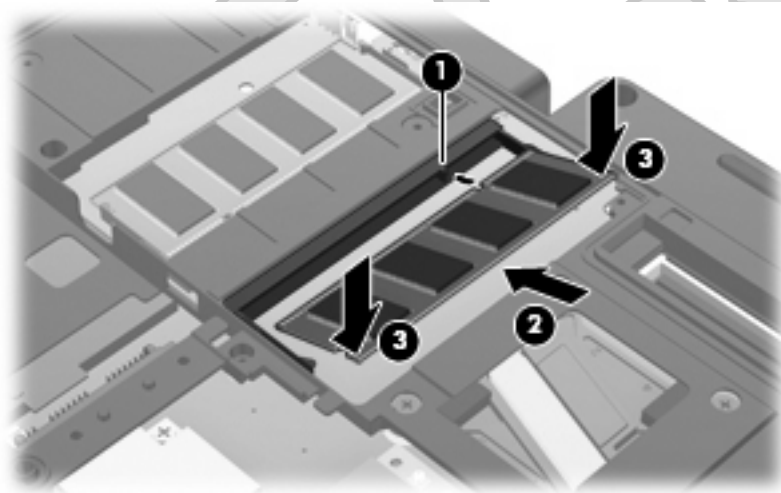

11. Align the tabs (1) on the hard drive compartment cover with the notches on the computer.

12. Close the cover (2).

13. Tighten the 3 hard drive compartment cover screws (3).

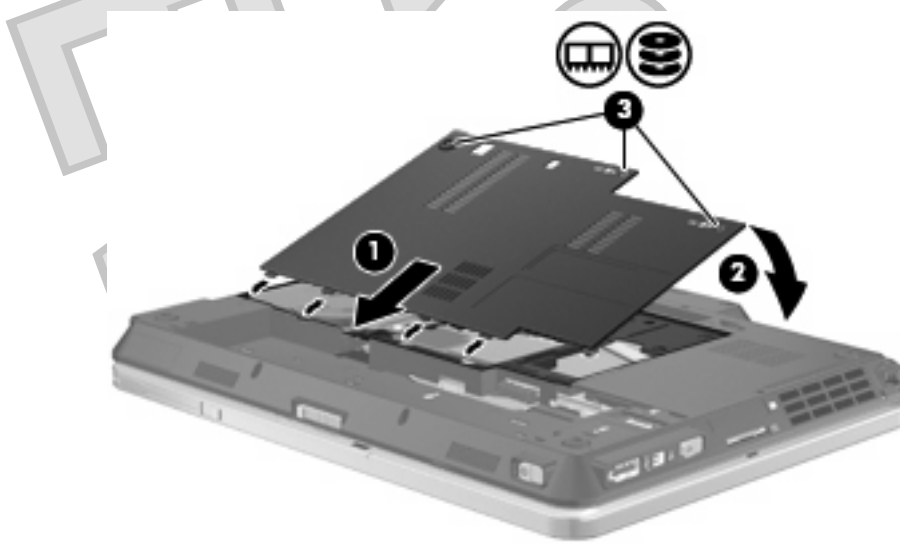

14. Replace the batteries.

15. Turn the computer right-side up, and then reconnect external power and external devices.

16. Turn on the computer.

11 Security

Protecting the computer

 **NOTE:** Security solutions are designed to act as deterrents. These deterrents may not prevent a product from being mishandled or stolen.

NOTE: Your computer supports CompuTrace, which is an online security-based tracking and recovery service available in select regions. If the computer is stolen, CompuTrace can track the computer if the unauthorized user accesses the Internet. You must purchase the software and subscribe to the service in order to use CompuTrace. For information about ordering the CompuTrace software, go to the HP Web site at <http://www.hpshopping.com>.

Security features provided with your computer can protect the computer, personal information, and data from a variety of risks. The way you use your computer will determine which security features you need to use.

The Windows operating system offers certain security features. Additional security features are listed in the following table. Most of these additional security features can be configured in the Computer Setup utility (referred to hereafter as Computer Setup).

To protect against	Use this security feature
Unauthorized use of the computer	HP ProtectTools Security Manager, in combination with a password, smart card, and/or fingerprint reader
Unauthorized access to Computer Setup (F10)	BIOS administrator password in Computer Setup*
Unauthorized access to the contents of a hard drive	DriveLock password in Computer Setup*
Unauthorized startup from an optical drive, diskette drive, or internal network adapter	Boot options feature in Computer Setup*
Unauthorized access to a Windows user account	HP ProtectTools Security Manager
Unauthorized access to data	<ul style="list-style-type: none">• Firewall software• Windows updates• Drive encryption for HP ProtectTools
Unauthorized access to Computer Setup settings and other system identification information	BIOS administrator password in Computer Setup*
Unauthorized removal of the computer	Security cable slot (used with an optional security cable)

*Computer Setup is a preinstalled, ROM-based utility that can be used even when the operating system is not working or will not load. You can use either a pointing device (TouchPad, pointing stick, or USB mouse) or the keyboard to navigate and make selections in Computer Setup.

Using passwords

Most security features use passwords. Whenever you set a password, write down the password and store it in a secure location away from the computer. Note the following password considerations:

- Setup and DriveLock passwords are set in Computer Setup and are managed by the system BIOS.
- The embedded security password, which is an HP ProtectTools Security Manager password, can be enabled in Computer Setup to provide BIOS password protection in addition to their normal HP ProtectTools functions. The embedded security password is used with the optional embedded security chip.
- Windows passwords are set only in the Windows operating system.
- If you forget the BIOS administrator password set in Computer Setup, you can use HP SpareKey to access the utility.
- If you forget both the DriveLock user password and the DriveLock master password set in Computer Setup, the hard drive that is protected by the passwords is permanently locked and can no longer be used.

You can use the same password for a Computer Setup feature and for a Windows security feature. You can also use the same password for more than one Computer Setup feature.

Use the following tips for creating and saving passwords:

- When creating passwords, follow requirements set by the program.
- Write down your passwords and store them in a secure place away from the computer.
- Do not store passwords in a file on the computer.

The following tables list commonly used Windows and BIOS administrator passwords and describe their functions.

Setting passwords in Windows

Windows passwords	Function
Administrator password*	Protects access to a Windows administrator-level account.
User password*	Protects access to a Windows user account.

*For information about setting a Windows administrator password or a Windows user password, select **Start > Help and Support**.

Setting passwords in Computer Setup

BIOS administrator passwords	Function
BIOS administrator password	Protects access to Computer Setup.
DriveLock master password	Protects access to the internal hard drive that is protected by DriveLock. It is also used to remove DriveLock protection. This password is set under DriveLock Passwords during the enable process.

BIOS administrator passwords	Function
DriveLock user password	Protects access to the internal hard drive that is protected by DriveLock, and is set under DriveLock Passwords during the enable process.
TPM embedded security password	When enabled as a BIOS administrator password, protects access to the computer contents when the computer turns on, restarts, or exits Hibernation. This password requires the optional embedded security chip to support this security feature.

BIOS administrator password

The Computer Setup BIOS administrator password protects the configuration settings and system identification information in Computer Setup. After this password is set, it must be entered to access Computer Setup and to make changes using Computer Setup.

Note the following characteristics of the BIOS administrator password:

- It is not interchangeable with a Windows administrator password, although both passwords can be identical.
- It is not displayed as it is set, entered, changed, or deleted.
- It must be set and entered with the same keys. For example, a BIOS administrator password set with keyboard number keys will not be recognized if you enter it thereafter with embedded numeric keypad number keys.
- It can include any combination of up to 32 letters and numbers and is not case sensitive unless mandated by the administrator.

Managing a BIOS administrator password

A BIOS administrator password is set, changed, and deleted in Computer Setup.

To set or change this password in Computer Setup, follow these steps:

1. Turn on or restart the computer, and then press **esc** while the “Press the ESC key for Startup Menu” message is displayed at the bottom of the screen.
2. Press **f10** to enter BIOS Setup.
3. Use a pointing device or the arrow keys to select **Security > Change Password**, and then press **enter**.
4. When prompted, type your current password.
5. When prompted, type your new password.
6. When prompted, type your new password again to confirm.
7. To save your changes and exit Computer Setup, click **Save** in the lower-left corner of the screen, and then follow the on-screen instructions.

– or –

Use the arrow keys to select **File > Save changes and exit**, and then press **enter**.

Your changes go into effect when the computer restarts.

To delete this password in Computer Setup, follow these steps:

1. Turn on or restart the computer, and then press **esc** while the “Press the ESC key for Startup Menu” message is displayed at the bottom of the screen.
2. Press **f10** to enter BIOS Setup.
3. Use a pointing device or the arrow keys to select **Security > Change Password**, and then press **enter**.
4. When prompted, type your current password.
5. When prompted for the new password, leave the field empty, and then press **enter**.
6. Read the warning. To continue, select **YES**.
7. When prompted to type your new password again, leave the field empty, and then press **enter**.
8. To save your changes and exit Computer Setup, click **Save** in the lower-left corner of the screen, and then follow the on-screen instructions.

– or –

Use the arrow keys to select **File > Save changes and exit**, and then press **enter**.

Your changes go into effect when the computer restarts.

Entering a BIOS administrator password

At the **BIOS administrator password** prompt, type your password (using the same kind of keys you used to set the password), and then press **enter**. After three unsuccessful attempts to enter the BIOS administrator password, you must restart the computer and try again.

Using Computer Setup DriveLock

△ **CAUTION:** To prevent the DriveLock-protected hard drive from becoming permanently unusable, record the DriveLock user password and the DriveLock master password in a safe place away from your computer. If you forget both DriveLock passwords, the hard drive will be permanently locked and can no longer be used.

DriveLock protection prevents unauthorized access to the contents of a hard drive. DriveLock can be applied only to the internal hard drive(s) of the computer. After DriveLock protection is applied to a drive, a password must be entered to access the drive. The drive must be inserted into the computer or an advanced port replicator in order for it to be accessed by the DriveLock passwords.

To apply DriveLock protection to an internal hard drive, a user password and a master password must be set in Computer Setup. Note the following considerations about using DriveLock protection:

- After DriveLock protection is applied to a hard drive, the hard drive can be accessed only by entering either the user password or the master password.
- The owner of the user password should be the day-to-day user of the protected hard drive. The owner of the master password may be either a system administrator or the day-to-day user.
- The user password and the master password can be identical.
- You can delete a user password or master password only by removing DriveLock protection from the drive. DriveLock protection can be removed from the drive only with the master password.

Setting a DriveLock password

To set a DriveLock password in Computer Setup, follow these steps:

1. Turn on the computer, and then press **esc** while the “Press the ESC key for Startup Menu” message is displayed at the bottom of the screen.
2. Press **f10** to enter BIOS Setup.
3. Use a pointing device or the arrow keys to select **Security > DriveLock passwords**, and then press **enter**.
4. Use a pointing device to click the hard drive you want to protect.

– or –

Use the arrow keys to select the hard drive you want to protect, and then press **enter**.

5. Read the warning. To continue, select **YES**.
6. Type your master password in the **New password** and **Verify new password** fields, and then press **enter**.
7. Type your user password in the **New password** and **Verify new password** fields, and then press **enter**.
8. To confirm DriveLock protection on the drive you have selected, type **DriveLock** in the confirmation field, and then press **enter**.

 **NOTE:** The DriveLock confirmation is case sensitive.

9. To save your changes and exit Computer Setup, click **Save** in the lower-left corner of the screen, and then follow the on-screen instructions.

– or –

Use the arrow keys to select **File > Save changes and exit**, and then press **enter**.

Your changes go into effect when the computer restarts.

Entering a DriveLock password

Be sure that the hard drive is inserted into the computer (not into an optional docking device or external MultiBay).

At the **DriveLock Password** prompt, type your user or master password (using the same kind of keys you used to set the password), and then press **enter**.

After two incorrect attempts to enter the password, you must shut down the computer and try again.

Changing a DriveLock password

To change a DriveLock password in Computer Setup, follow these steps:

1. Turn on the computer, and then press **esc** while the “Press the ESC key for Startup Menu” message is displayed at the bottom of the screen.
2. Press **f10** to enter BIOS Setup.

3. Use a pointing device or the arrow keys to select **Security > DriveLock passwords**, and then press [enter](#).
4. Use a pointing device to select an internal hard drive.
– or –
Use the arrow keys to select an internal hard drive, and then press [enter](#).
5. Use a pointing device or the arrow keys to select the password you want to change.
6. Type your current password in the **Old password** field, type a new password in the **New password** and **Verify new password** fields, and then press [enter](#).
7. To save your changes and exit Computer Setup, click **Save** in the lower-left corner of the screen, and then follow the on-screen instructions.
– or –
Use the arrow keys to select **File > Save changes and exit**, and then press [enter](#).

Your changes go into effect when the computer restarts.

Removing DriveLock protection

To remove DriveLock protection in Computer Setup, follow these steps:

1. Turn on the computer, and then press [esc](#) while the “Press the ESC key for Startup Menu” message is displayed at the bottom of the screen.
2. Press [f10](#) to enter BIOS Setup.
3. Use a pointing device or the arrow keys to select **Security > DriveLock password**, and then press [enter](#).
4. Use a pointing device or the arrow keys to select an internal hard drive, and then press [enter](#).
5. Use a pointing device or the arrow keys to select **Disable protection**.
6. Type your master password, and then press [enter](#).
7. To save your changes and exit Computer Setup, click **Save** in the lower-left corner of the screen, and then follow the on-screen instructions.
– or –
Use the arrow keys to select **File > Save changes and exit**, and then press [enter](#).

Your changes go into effect when the computer restarts.

Using Computer Setup Auto DriveLock

In a multiple-user environment, you can set an Automatic DriveLock password. When the Automatic DriveLock password is enabled, a random user password and a DriveLock master password will be created for you. When any user passes the password credential, the same random user and DriveLock master password will be used to unlock the drive.

 **NOTE:** You must have a BIOS administrator password before you can access the Automatic DriveLock features.

Entering an Automatic DriveLock password

To enable an Automatic DriveLock password in Computer Setup, follow these steps:

1. Turn on or restart the computer, and then press **esc** while the “Press the ESC key for Startup Menu” message is displayed at the bottom of the screen.
2. Press **f10** to enter BIOS Setup.
3. Use a pointing device or the arrow keys to select **Security > Automatic DriveLock**, and then press **enter**.
4. Use a pointing device or the arrow keys to select an internal hard drive, and then press **enter**.
5. Read the warning. To continue, select **YES**.
6. To save your changes and exit Computer Setup, click **Save** in the lower-left corner of the screen, and then follow the on-screen instructions.

– or –

Use the arrow keys to select **File > Save changes and exit**, and then press **enter**.

Removing Automatic DriveLock protection

To remove DriveLock protection in Computer Setup, follow these steps:

1. Turn on or restart the computer, and then press **esc** while the “Press the ESC key for Startup Menu” message is displayed at the bottom of the screen.
2. Press **f10** to enter BIOS Setup.
3. Use a pointing device or the arrow keys to select **Security > Automatic DriveLock**, and then press **enter**.
4. Use a pointing device or the arrow keys to select an internal hard drive, and then press **enter**.
5. Use a pointing device or the arrow keys to select **Disable protection**.
6. To save your changes and exit Computer Setup, click **Save** in the lower-left corner of the screen, and then follow the on-screen instructions.

– or –

Use the arrow keys to select **File > Save changes and exit**, and then press **enter**.

Using Computer Setup security features

Securing system devices

You can disable or enable system devices from the following menus in Computer Setup:

- Boot Options
- Device Configurations
- Built-In Device Options
- Port Options

To disable or reenablen system devices in Computer Setup, follow these steps:

1. Turn on or restart the computer, and then press **esc** while the “Press the ESC key for Startup Menu” message is displayed at the bottom of the screen.
2. Press **f10** to enter BIOS Setup.
3. Use a pointing device or the arrow keys to select **System Configuration > Boot Options**, or **System Configuration > Device Configurations** or, **System Configuration > Built-In Device Options**, or **System Configuration > Port Options**.
4. Press **enter**.
5. To disable an option, use a pointing device to click **Disabled** next to the option.
– or –
Use the arrow keys to select **Disabled** next to the option, and then press **enter**.
6. To reenablen an option, use a pointing device to click **Enabled** next to the option.
– or –
Use the arrow keys to select **Enabled** next to the option, and then press **enter**.
7. To save your changes and exit Computer Setup, click **Save** in the lower-left corner of the screen, and then follow the on-screen instructions.
– or –
Use the arrow keys to select **File > Save changes and exit**, and then press **enter**.

Your changes go into effect when the computer restarts.

Viewing Computer Setup System Information

The System Information feature in Computer Setup provides two types of system information:

- Identification information about the computer model and the batteries
- Specification information about the processor, cache, memory, ROM, video revision, and keyboard controller revision

To view this general system information in Computer Setup, follow these steps:

1. Turn on or restart the computer, and then press **esc** while the “Press the ESC key for Startup Menu” message is displayed at the bottom of the screen.
2. Press **f10** to enter BIOS Setup.
3. Use a pointing device or the arrow keys to select **File > System Information**, and then press **enter**.

 **NOTE:** To prevent unauthorized access to this information, you must create a BIOS administrator password in Computer Setup.

Using Computer Setup System IDs

The System IDs feature in Computer Setup allows you to display or enter the computer asset tag and ownership tag.

 **NOTE:** To prevent unauthorized access to this information, you must create a BIOS administrator password in Computer Setup.

To manage this feature in Computer Setup, follow these steps:

1. Turn on or restart the computer, and then press **esc** while the “Press the ESC key for Startup Menu” message is displayed at the bottom of the screen.
2. Press **f10** to enter BIOS Setup.
3. Use a pointing device or the arrow keys to select **Security > System IDs**, and then press **enter**.
4. Use a pointing device or the arrow keys to select **Notebook Asset Tag** or **Notebook Ownership Tag**, and then enter the information.
5. Press **enter** when finished.
6. To save your changes and exit Computer Setup, click **Save** in the lower-left corner of the screen, and then follow the on-screen instructions.

– or –

Use the arrow keys to select **File > Save changes and exit**, and then press **enter**.

Your changes go into effect when the computer restarts.

Using antivirus software

When you use the computer to access e-mail, a network, or the Internet, you expose the computer to computer viruses. Computer viruses can disable the operating system, programs, or utilities, or cause them to function abnormally.

Antivirus software can detect most viruses, destroy them, and in most cases, repair any damage they have caused. To provide ongoing protection against newly discovered viruses, antivirus software must be kept up to date.

McAfee Total Protection antivirus software is either preinstalled or preloaded on the computer.

If the antivirus software is preinstalled, select **Start > All Programs > McAfee > Managed Services > Total Protection**.

If the software is preloaded, select **Start > All Programs > HP Software Setup**, and then follow the instructions on the screen to load the **McAfee Total Protection** software.

For more information about computer viruses, type `viruses` in the Search box in Help and Support.

Using firewall software

When you use the computer to access e-mail, a network, or the Internet, unauthorized persons may be able to gain access to the computer, your personal files, and information about you. Use the firewall software preinstalled on the computer to protect your privacy. McAfee Total Protection antivirus software is preinstalled on the computer. To access your software, select **Start > All Programs > McAfee > Managing Services > Total Protection**.

Firewall features include logging and reporting of network activity, and automatic monitoring of all incoming and outgoing traffic. For more information, refer to the software manufacturer's instructions. These instructions may be provided with the software, on disc, or on the manufacturer's Web site.

 **NOTE:** Under some circumstances a firewall can block access to Internet games, interfere with printer or file sharing on a network, or block authorized e-mail attachments. To temporarily resolve the problem, disable the firewall, perform the task that you want to perform, and then reenables the firewall. To permanently resolve the problem, reconfigure the firewall as necessary, and adjust the policies and settings of other intrusion detection systems. For additional information, contact your network administrator or IT department.

Installing critical updates

△ **CAUTION:** Microsoft sends alerts regarding critical updates. To protect the computer from security breaches and computer viruses, install all critical updates from Microsoft as soon as you receive an alert.

Updates to the operating system and other software may have become available *after* the computer was shipped. To be sure that all available updates are installed on the computer, observe these guidelines:

- Run Windows Update monthly to install the latest software from Microsoft.
- Obtain updates, as they are released, from the Microsoft Web site and through the updates link in Help and Support.

Using HP ProtectTools Security Manager (select models only)

HP ProtectTools Security Manager software is preinstalled on select computer models. This software can be accessed through Windows Control Panel. It provides security features that help protect against unauthorized access to the computer, networks, and critical data. For more information, refer to the HP ProtectTools online Help.

Installing a security cable

 **NOTE:** A security cable is designed to act as a deterrent, but it may not prevent the computer from being mishandled or stolen.

1. Loop the security cable around a secured object.
2. Insert the key (1) into the cable lock (2).
3. Insert the cable lock into the security cable slot on the computer (3), and then lock the cable lock with the key.

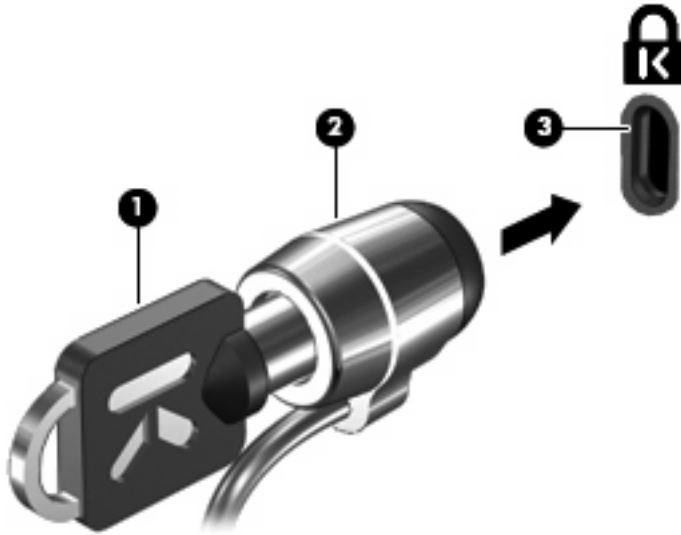

 **NOTE:** The location of the security cable slot varies by computer model.

12 Software updates

Updating software

Updated versions of the software provided with your computer are available either through the HP Assistant utility or on the HP Web site.

HP Assistant automatically checks for updates from HP. The utility runs at a specified interval and provides a list of support alerts, such as security enhancements, and optional software and driver updates.

You can manually check for updates at any time by selecting **Start > Help and Support > Maintain**, and then follow the on-screen instructions.

Most software on the HP Web site is packaged in compressed files called *SoftPaqs*. Some BIOS updates may be packaged in compressed files called *ROMPaqs*.

Some download packages contain a file named *Readme.txt*, which contains information regarding installing and troubleshooting the file. (*Readme.txt* files included with *ROMPaqs* are provided in English only.)

You can also access software updates by obtaining the *Support Software* disc (purchased separately). This disc includes device drivers, BIOS updates, and utilities.

To purchase the current *Support Software* disc or a subscription that provides both the current version and future versions of the disc, follow these steps:

1. Open your Internet browser, and go to <http://www.hp.com/support>.
2. Select your country or region.
3. Click the option for software and driver downloads, and then type your computer model number in the product box.
4. Press **enter**.
5. Follow the on-screen instructions.

To update the software using a *Support Software* disc, follow these steps:

1. Insert the *Support Software* disc into the optical drive.
2. Follow the on-screen instructions.

To update the software using the HP Web site, follow these steps:

1. Identify your computer model, product category, and series or family. Prepare for a system BIOS update by identifying the BIOS version currently installed on the computer. For details, refer to the "Determining the BIOS version" section.

If your computer is connected to a network, consult the network administrator before installing any software updates, especially system BIOS updates.

 **NOTE:** The computer system BIOS is stored on the system ROM. The BIOS initializes the operating system, determines how the computer will interact with the hardware devices, and provides for data transfer among hardware devices, including the time and date.

NOTE: Windows includes the User Account Control feature to improve the security of your computer. You may be prompted for your permission or password for tasks such as installing software, running utilities, or changing Windows settings. Refer to Help and Support for more information.

2. Open your Internet browser, and go to <http://www.hp.com/support>.
3. Select your country or region.
4. Click the option for software and driver downloads, and then type your computer model number in the product box.
5. Press [enter](#).
6. Follow the on-screen instructions.

Updating the BIOS

To update the BIOS, first determine what BIOS version you currently have, and then download and install the new BIOS.

Determining the BIOS version

BIOS version information (also known as *ROM date* and *System BIOS*) can be displayed by pressing **fn+esc** (if you are already in Windows) or by using Computer Setup.

To use Computer Setup for displaying BIOS information, follow these steps:

1. Turn on or restart the computer, and then press **esc** while the “Press the ESC key for Startup Menu” message is displayed at the bottom of the screen.
2. Press **f10** to enter BIOS Setup.
3. Use a pointing device or the arrow keys to select **File > System Information**.
4. Press **esc** to return to the **File** menu.
5. Click **Exit** in the lower-left corner of the screen, and then follow the on-screen instructions.

– or –

Use the arrow keys to select **File > Ignore changes and exit**, and then press **enter**.

Downloading a BIOS update

△ **CAUTION:** To prevent damage to the computer or an unsuccessful installation, download and install a BIOS update only when the computer is connected to reliable external power using the AC adapter. Do not download or install a BIOS update while the computer is running on battery power, docked in an optional docking device, or connected to an optional power source. During the download and installation, follow these guidelines:

Do not disconnect power from the computer by unplugging the power cord from the AC outlet.

Do not shut down the computer or initiate Sleep or Hibernation.

Do not insert, remove, connect, or disconnect any device, cable, or cord.

To download a BIOS update:

📄 **NOTE:** BIOS updates are posted as needed. A newer BIOS update may not be available for your computer. It is recommended that you check the HP Web site periodically for BIOS updates.

1. Open your Internet browser, go to <http://www.hp.com/support>, and then select your country or region.
2. Click the option for software and driver downloads, type your computer model number in the product box, and then press **enter**.
3. Click your specific product from the models listed.
4. Click your operating system.
5. Follow the on-screen instructions to access the BIOS update you want to download. Make a note of the download date, name, or other identifier. You may need this information to locate the update later, after it has been downloaded to your hard drive.
6. At the download area, perform these steps:
 - a. Identify the BIOS update that is newer than the BIOS version currently installed on your computer.
 - b. Follow the instructions on the screen to download your selection to the hard drive.

Make a note of the path to the location on your hard drive where the BIOS update will be downloaded. You will need to access this path when you are ready to install the update.

📄 **NOTE:** If you connect your computer to a network, consult the network administrator before installing any software updates, especially system BIOS updates.

BIOS installation procedures vary. Follow any instructions that are displayed on the screen after the download is complete. If no instructions are displayed, follow these steps:

1. Open Windows Explorer by selecting **Start > Computer**.
2. Double-click your hard drive designation. The hard drive designation is typically Local Disk (C:).
3. Using the hard drive path you recorded earlier, open the folder on your hard drive that contains the update.
4. Double-click the file that has an .exe extension (for example, *filename.exe*).

The BIOS installation begins.

 **NOTE:** Windows includes the User Account Control feature to improve the security of your computer. You may be prompted for your permission or password for tasks such as installing software, running utilities, or changing Windows settings. Refer to Help and Support for more information.

5. Complete the installation by following the on-screen instructions.

 **NOTE:** After a message on the screen reports a successful installation, you may delete the downloaded file from your hard drive.

Updating programs and drivers

1. Open your Internet browser, go to <http://www.hp.com/support>, and then select your country or region.
2. Click the option for software and driver downloads, type your computer model number in the product box, and then press **enter**.

– or –

If you want a specific SoftPaq, type the SoftPaq number in the **Search** box, at the top-right corner of the screen. Then press **enter**, and follow the instructions provided. Proceed to step 6.

3. Click your specific product from the models listed.
4. Click your operating system.
5. When the list of updates is displayed, click an update to open a window containing additional information.
6. Click **Download**.
7. Click **Run** to install the updated software without downloading the file.

– or –

Click **Save** to save the file to your computer. When prompted, select a storage location on your hard drive.

After the file is downloaded, navigate to the folder where the file was stored, and then double-click the file to install the update.

8. If prompted to do so, restart your computer after the installation is complete.

Using SoftPaq Download Manager

HP SoftPaq Download Manager (SDM) is a tool that provides quick access to SoftPaq information for HP business computers without requiring the SoftPaq number. Using this tool, you can easily search for SoftPaqs and then download and unpack them.

SoftPaq Download Manager works by reading and downloading, from the HP FTP site, a published database file containing computer model and SoftPaq information. SoftPaq Download Manager allows you to specify one or more computer models to determine which SoftPaqs are available for download.

SoftPaq Download Manager checks the HP FTP site for updates to the database and software. If updates are found, they are downloaded and applied automatically.

SoftPaq Download Manager is available on the HP Web site. To use SoftPaq Download Manager to download SoftPaqs, you must first download and install the program. Go to the HP Web site at <http://www.hp.com/go/sdm>, and follow the instructions to download and install SoftPaq Download Manager.

To download SoftPaqs:

1. Click **Start > All Programs > HP > HP SoftPaq Download Manager**.
2. When the SoftPaq Download Manager opens for the first time, a window is displayed asking if you want to show only software for the computer you are using or to show the software for all supported models. Select **Show software for all supported models**. If you have used HP SoftPaq Download Manager previously, go to Step 3.
 - a. Select your operating system and language filters in the Configuration Options window. The filters limit the number of options that are listed in the Product Catalog pane. For example, if only Windows 7 Professional is selected in the operating system filter, the only operating system that is displayed in the Product Catalog is Windows 7 Professional.
 - b. To add other operating systems, change the filter settings in the Configuration Options window. Refer to the HP SoftPaq Download Manager software Help for more information.
3. In the left pane, click the (+) sign to expand the model list, and then select the model or models of the products you want to update.
4. Click **Find Available SoftPaqs** to download a list of available SoftPaqs for the selected computer.
5. Select from the list of available SoftPaqs, and then click **Download Only** if you have many SoftPaqs to download, because the SoftPaq selection and Internet connection speed determine how long the download process will take.

If you want to download only one or two SoftPaqs and have a high-speed Internet connection, click **Download & Unpack**.

6. Right-click **Install SoftPaq** in the SoftPaq Download Manager software to install the selected SoftPaqs on the computer.

13 Backup and recovery

To protect your information, use Windows Backup and Restore to back up individual files and folders, back up your entire hard drive (select models only), create system repair discs (select models only), or create system restore points. In case of system failure, you can use the backup files to restore the contents of your computer.

Windows Backup and Restore provides the following options:

- Creating a system repair disc (select models only)
- Backing up individual files and folders
- Creating a system image (select models only)
- Scheduling automatic backups (select models only)
- Creating system restore points
- Recovering individual files
- Restoring the computer to a previous state
- Recovering information using recovery tools

 **NOTE:** For detailed instructions, perform a search for these topics in Help and Support.

NOTE: In case of system instability, HP recommends that you print the recovery procedures and save them for later use.

Backing up your information

Recovery after a system failure is as complete as your most current backup. You should create system repair discs (select models only) and your initial backup immediately after software setup. As you add new software and data files, you should continue to back up your system on a regular basis to maintain a reasonably current backup. The system repair discs (select models only) are used to start up (boot) the computer and repair the operating system in case of system instability or failure. Your initial and subsequent backups allow you to restore your data and settings if a failure occurs.

You can back up your information to an optional external hard drive, a network drive, or discs.

Note the following when backing up:

- Store personal files in the Documents library, and back it up regularly.
- Back up templates that are stored in their associated programs.
- Save customized settings that appear in a window, toolbar, or menu bar by taking a screen shot of your settings. The screen shot can be a time-saver if you have to reset your preferences.

To create a screen shot:

1. Display the screen you want to save.
2. Copy the screen image:

To copy only the active window, press **alt+fn+prt sc**.

To copy the entire screen, press **fn+prt sc**.

3. Open a word-processing document, and then select **Edit > Paste**.

The screen image is added to the document.

4. Save the document.

- When backing up to discs, use any of the following types of discs (purchased separately): CD-R, CD-RW, DVD+R, DVD+R DL, DVD-R, DVD-R DL, or DVD±RW. The discs you use will depend on the type of optical drive installed in your computer.

 **NOTE:** DVDs and DVDs with double-layer (DL) support store more information than CDs, so using them for backup reduces the number of recovery discs required.

- When backing up to discs, number each disc before inserting it into the optical drive of the computer.

To create a backup using Backup and Restore, follow these steps:

 **NOTE:** Be sure that the computer is connected to AC power before you start the backup process.

NOTE: The backup process may take over an hour, depending on file size and the speed of the computer.

1. Select **Start > All Programs > Maintenance > Backup and Restore**.
2. Follow the on-screen instructions to set up your backup, create a system image (select models only), or create a system repair disc (select models only).

 **NOTE:** Windows includes the User Account Control feature to improve the security of your computer. You may be prompted for your permission or password for tasks such as installing software, running utilities, or changing Windows settings. Refer to Help and Support for more information.

Antenna House XSL Formatter

Performing a recovery

In case of system failure or instability, the computer provides the following tools to recover your files:

- Windows recovery tools: You can use Windows Backup and Restore to recover information you have previously backed up. You can also use Windows Startup Repair to fix problems that might prevent Windows from starting correctly.
- **f11** recovery tools: You can use the **f11** recovery tools to recover your original hard drive image. The image includes the Windows operating system and software programs installed at the factory.

 **NOTE:** If you are unable to boot (start up) your computer and you cannot use the system repair discs you previously created (select models only), you must purchase a Windows 7 operating system DVD to reboot the computer and repair the operating system. For additional information, refer to the “Using a Windows 7 operating system DVD (purchased separately)” section in this guide.

Using the Windows recovery tools

To recover information you previously backed up, follow these steps:

1. Select **Start > All Programs > Maintenance > Backup and Restore**.
2. Follow the on-screen instructions to recover your system settings, your computer (select models only), or your files.

 **NOTE:** Windows includes the User Account Control feature to improve the security of your computer. You may be prompted for your permission or password for tasks such as installing software, running utilities, or changing Windows settings. Refer to Help and Support for more information.

To recover your information using Startup Repair, follow these steps:

 **CAUTION:** Using Startup Repair completely erases hard drive contents and reformats the hard drive. All files you have created and any software installed on the computer are permanently removed. When reformatting is complete, the recovery process restores the operating system, as well as the drivers, software, and utilities from the backup used for recovery.

1. If possible, back up all personal files.
2. If possible, check for the presence of the Windows partition and the HP Recovery partition.

To check for the Windows partition, select **Start > Computer**.

To check for the HP Recovery partition, select **Start**, right-click **Computer**, click **Manage**, and then click **Disk Management**.

 **NOTE:** If the Windows partition and the HP Recovery partition are not listed, you must recover your operating system and programs using the Windows 7 operating system DVD and the *Driver Recovery* disc (both purchased separately). For additional information, refer to the “Using a Windows 7 operating system DVD (purchased separately)” section in this guide.

3. If the Windows partition and the HP Recovery partition are listed, restart the computer, and then press **f8** before the Windows operating system loads.
4. Select **Startup Repair**.
5. Follow the on-screen instructions.

 **NOTE:** For additional information on recovering information using the Windows tools, perform a search for these topics in Help and Support.

Using f11

△ **CAUTION:** Using **f11** completely erases hard drive contents and reformats the hard drive. All files you have created and any software installed on the computer are permanently removed. The **f11** recovery tool reinstalls the operating system and HP programs and drivers that were installed at the factory. Software not installed at the factory must be reinstalled.

To recover the original hard drive image using **f11**, follow these steps:

1. If possible, back up all personal files.
2. If possible, check for the presence of the HP Recovery partition: select **Start**, right-click **Computer**, click **Manage**, and then click **Disk Management**.

 **NOTE:** If the HP Recovery partition is not listed, you must recover your operating system and programs using the Windows 7 operating system DVD and the *Driver Recovery* disc (both purchased separately). For additional information, refer to the “Using a Windows 7 operating system DVD (purchased separately)” section in this guide.

3. If the HP Recovery partition is listed, restart the computer, and then press **esc** while the “Press the ESC key for Startup Menu” message is displayed at the bottom of the screen.
4. Press **f11** while the “Press <F11> for recovery” message is displayed on the screen.
5. Follow the on-screen instructions.

Using a Windows 7 operating system DVD (purchased separately)

If you are unable to boot (start up) your computer and you cannot use the system repair discs you previously created (select models only), you must purchase a Windows 7 operating system DVD to reboot the computer and repair the operating system. Make sure that your most recent backup (stored on discs or on an external drive) is easily accessible. To order a Windows 7 operating system DVD, go to <http://www.hp.com/support>, select your country or region, and then follow the on-screen instructions. You can also order the DVD by calling technical support. For contact information, refer to the *Worldwide Telephone Numbers* booklet included with the computer.

△ **CAUTION:** Using a Windows 7 operating system DVD completely erases hard drive contents and reformats the hard drive. All files you have created and any software installed on the computer are permanently removed. When reformatting is complete, the recovery process helps you restore the operating system, as well as drivers, software, and utilities.

To initiate recovery using a Windows 7 operating system DVD, follow these steps:

 **NOTE:** This process takes several minutes.

1. If possible, back up all personal files.
2. Restart the computer, and then insert the Windows 7 operating system DVD into the optical drive before the Windows operating system loads.
3. When prompted, press any keyboard key.
4. Follow the on-screen instructions.
5. Click **Next**.

6. Select **Repair your computer**.
7. Follow the on-screen instructions.

Antenna House XSL Formatter

14 Computer Setup

Starting Computer Setup

Computer Setup is a preinstalled, ROM-based utility that can be used even when the operating system is not working or will not load.

 **NOTE:** Some of the Computer Setup menu items listed in this guide may not be supported by your computer.

NOTE: An external keyboard or mouse connected to a USB port can be used with Computer Setup only if USB legacy support is enabled.

To start Computer Setup, follow these steps:

1. Turn on or restart the computer, and then press **esc** while the “Press the ESC key for Startup Menu” message is displayed at the bottom of the screen.
2. Press **f10** to enter BIOS Setup.

Using Computer Setup

Navigating and selecting in Computer Setup

The information and settings in Computer Setup are accessed from the File, Security, Diagnostics, and System Configuration menus.

To navigate and select in Computer Setup, follow these steps:

1. Turn on or restart the computer, and then press **esc** while the “Press the ESC key for Startup Menu” message is displayed at the bottom of the screen.
 - To select a menu or a menu item, use the tab key and the keyboard arrow keys, and then press **enter**, or use a pointing device to click the item.
 - To scroll up and down, click the up arrow or the down arrow in the upper-right corner of the screen, or use the up arrow key or the down arrow key.
 - To close open dialog boxes and return to the main Computer Setup screen, press **esc**, and then follow the on-screen instructions.

 **NOTE:** You can use either a pointing device (TouchPad, pointing stick, or USB mouse) or the keyboard to navigate and make selections in Computer Setup.

2. Press **f10** to enter BIOS Setup.
3. Select the **File**, **Security**, **Diagnostics**, or **System Configuration** menu.

To exit Computer Setup menus, choose one of the following methods:

- To exit Computer Setup menus without saving your changes, click the **Exit** icon in the lower-left corner of the screen, and then follow the on-screen instructions.
 - or –
- Use the tab key and the arrow keys to select **File > Ignore changes and exit**, and then press **enter**.
- or –
- To save your changes and exit Computer Setup menus, click the **Save** icon in the lower-left corner of the screen, and then follow the on-screen instructions.
 - or –
- Use the tab key and the arrow keys to select **File > Save changes and exit**, and then press **enter**.

Your changes go into effect when the computer restarts.

Restoring factory settings in Computer Setup

 **NOTE:** Restoring defaults will not change the hard drive mode.

To return all settings in Computer Setup to the values that were set at the factory, follow these steps:

1. Turn on or restart the computer, and then press **esc** while the “Press the ESC key for Startup Menu” message is displayed at the bottom of the screen.
2. Press **f10** to enter BIOS Setup.
3. Use a pointing device or the arrow keys to select **File > Restore defaults**.
4. Follow the on-screen instructions.
5. To save your changes and exit, click the **Save** icon in the lower-left corner of the screen, and then follow the on-screen instructions.

– or –

Use the arrow keys to select **File > Save changes and exit**, and then press **enter**.

Your changes go into effect when the computer restarts.

 **NOTE:** Your password settings and security settings are not changed when you restore the factory settings.

Computer Setup menus

The menu tables in this section provide an overview of Computer Setup options.

 **NOTE:** Some of the Computer Setup menu items listed in this chapter may not be supported by your computer.

File menu

Select	To do this
System Information	<ul style="list-style-type: none"> View identification information for the computer and the batteries in the system. View specification information for the processor, cache and memory size, system ROM, video revision, and keyboard controller version.
Set System Date and Time	Set or change the date and time on the computer.
Restore defaults	Replace the configuration settings in Computer Setup with the original factory settings. (Hard drive mode, password settings, and security settings are not changed when you restore the factory settings.)
Ignore changes and exit	Cancel any changes entered during the current session. Then exit and restart the computer.
Save changes and exit	Save any changes entered during the current session. Then exit and restart the computer. Your changes go into effect when the computer restarts.

Security menu



NOTE: Some of the menu items listed in this section may not be supported by your computer.

Select	To do this
Setup BIOS Administrator Password	Set up a BIOS administrator password.
User Management (requires a BIOS administrator password)	<ul style="list-style-type: none"> Create a new BIOS user account. View a list of ProtectTools users.
Password Policy (requires a BIOS administrator password)	Revise password policy criteria.
HP SpareKey	Enable/disable HP SpareKey (enabled by default).
Always Prompt for HP SpareKey Enrollment	Enable/disable HP SpareKey enrollment (enabled by default).
Fingerprint Reset on Reboot (if present)	Reset/clear the fingerprint reader ownership (select models only; disabled by default).
Allow Reset of HP ProtectTools security keys	Enable/disable reset of HP ProtectTools security keys.
Change Password	Enter, change, or delete a BIOS administrator password.
HP SpareKey Enrollment	Enroll or reset HP SpareKey, which is a set of security questions and answers used if you forget your password.
DriveLock Passwords	<ul style="list-style-type: none"> Enable/disable DriveLock on any computer hard drive (enabled by default). Change a DriveLock user password or master password. <p>NOTE: DriveLock settings are accessible only when you enter Computer Setup by turning on (not restarting) the computer.</p>

Select	To do this
TPM Embedded Security	<p>Enable/disable support for Trusted Platform Module (TPM) Embedded Security, which protects the computer from unauthorized access to owner functions available in Embedded Security for ProtectTools. For more information, refer to the ProtectTools software Help.</p> <p>NOTE: You must have a setup password to change this setting.</p>
Automatic DriveLock	Enable/disable Automatic DriveLock support.
Disk Sanitizer	<p>Run Disk Sanitizer to destroy all existing data on the primary hard drive or the drive in the upgrade bay.</p> <p>CAUTION: If you run Disk Sanitizer, the data on the selected drive is destroyed permanently.</p>
System IDs	Enter a user-defined computer asset tracking number and ownership tag.

Diagnostics menu

Select	To do this
System Diagnostics menu	<p>Displays the following information:</p> <ul style="list-style-type: none"> • System Information <ul style="list-style-type: none"> ◦ Identification information for the computer and the batteries in the system. ◦ Specification information for the processor, cache and memory size, system ROM, video revision, and keyboard controller version. • Start-up Test—Verifies the system components needed for starting the computer. • Run-In Test—Runs a comprehensive check on system memory. • Hard Disk Test—Runs a comprehensive self-test on any hard drive in the system. • Memory Test—Runs a comprehensive test on any memory installed in the computer. • Battery Test—Runs a comprehensive test on any batteries installed in the computer. • Error Log—Displays a log file if any errors have occurred.

System Configuration menu

 **NOTE:** Some of the listed System Configuration options may not be supported by your computer.

Select	To do this
Language	Change the Computer Setup language.
Boot Options	<ul style="list-style-type: none">• Set a Startup Menu delay (in seconds).• Enable/disable Custom Logo (disabled by default).• Enable/disable Display Diagnostic URL (enabled by default).• Enable/disable CD-ROM boot (enabled by default).• Enable/disable SD Card boot (enabled by default).• Enable/disable floppy boot (enabled by default).• Enable/disable PXE Internal NIC boot (enabled by default).• Set the Express Boot Popup delay in seconds.• Set the boot order.
Device Configurations	<ul style="list-style-type: none">• Enable/disable USB legacy support (enabled by default). When enabled, USB legacy support allows the following:<ul style="list-style-type: none">◦ Use of a USB keyboard in Computer Setup even when a Windows operating system is not running.◦ Startup from bootable USB devices, including a hard drive, diskette drive, or optical drive connected by a USB port to the computer.• Select a parallel port mode: ECP (Enhanced Capabilities Port), standard, bidirectional, or EPP (Enhanced Parallel Port).• Enable/disable fan always on while connected to an AC outlet (enabled by default).• Enable/disable LAN Power Save (select models only). When enabled, saves power by turning off the LAN when not in use (enabled by default).• Enable/disable Data Execution Prevention. When enabled, the processor can disable some virus code execution, which helps to improve computer security.• SATA (Serial Advanced Technology Attachment) device mode. The following options are available:<ul style="list-style-type: none">◦ AHCI (Advanced Host Controller Interface)◦ IDE (Integrated Drive Electronics)◦ RAID (Redundant Array of Independent Disks) (select models only)

Select	To do this
	<p>NOTE: Availability of the options above varies by computer model.</p> <ul style="list-style-type: none"> • Enable/disable secondary battery fast charge (enabled by default). • Enable/disable HP QuickLook 2 (enabled by default). • Enable/disable Virtualization Technology (select models only; disabled by default). • Enable/disable TXT (Intel® Trusted Execution Technology) (select models only; disabled by default). • Enable/disable Dual Core CPU (select models only; enabled by default). • Enable/Disable Unified Extensible Firmware Interface (UEFI) mode (disabled by default).
Built-In Device Options	<ul style="list-style-type: none"> • Enable/disable the wireless button state (enabled by default). • Enable/disable embedded WWAN device radio (select models only; enabled by default). • Enable/disable embedded Bluetooth device radio (enabled by default). • Enable/disable the Network Interface Controller (LAN) (enabled by default). • Set the wake on LAN state. Options include the following: <ul style="list-style-type: none"> ◦ Disabled ◦ Boot to Network (set by default) ◦ Follow Boot Order • Enable/disable the fingerprint device (enabled by default). • Enable/disable a modem device (enabled by default). • Enable/disable the embedded WLAN device (enabled by default). • Enable/disable LAN/WLAN switching (disabled by default). • Enable the ambient light sensor (enabled by default). • Enable/disable the Notebook Multibay device (enabled by default). • Enable/disable the integrated camera (select models only; enabled by default).

Select	To do this
Port Options	<p>NOTE: All port options are enabled by default.</p> <ul style="list-style-type: none"> • Enable/disable the Smart Card slot. • Enable/disable the ExpressCard slot. • Enable/disable the serial port. • Enable/disable the parallel port. • Enable/disable the flash media reader. • Enable/disable the USB port. <p>CAUTION: Disabling the USB port also disables MultiBay devices and ExpressCard devices on the advanced port replicator.</p> <ul style="list-style-type: none"> • Enable/disable the 1394 port.
AMT Options	<p>NOTE: All AMT options are disabled by default.</p> <ul style="list-style-type: none"> • Enable/disable Firmware Verbosity. • Enable/disable AMT Setup Prompt (CTRL-P). • Enable/disable USB Key Provisioning Support. • Enable/disable Unconfigure AMT on Next Boot. • Enable/disable Terminal Emulation Mode • Enable/disable Firmware Progress Event Support. • Enable/disable include TYPE-131 in SMBIOS.
Set Security Level	Change, view, or hide security levels for all BIOS menu items.
Restore Security Defaults	Restore the default security settings.

15 MultiBoot

About the boot device order

As the computer starts, the system attempts to boot from enabled boot devices. The MultiBoot utility, which is enabled at the factory, controls the order in which the system selects a boot device. Boot devices can include optical drives, diskette drives, a network interface card (NIC), hard drives, and USB devices. Boot devices contain bootable media or files that the computer needs to start and operate properly.

 **NOTE:** Some boot devices must be enabled in Computer Setup before they can be included in the boot order.

The factory setting is for the computer to select the boot device by searching enabled boot devices and drive bay locations in the following order:

 **NOTE:** Some of the boot devices and drive bay locations listed may not be supported on your computer.

- Notebook MultiBay
- Internal hard drive
- USB diskette drive
- USB CD-ROM
- USB hard drive
- Notebook Ethernet
- Secure Digital (SD) Memory Card
- Docking station MultiBay
- External SATA drive

You can change the order in which the computer searches for a boot device by changing the boot order in Computer Setup. You can also press **esc** while the “Press the ESC key for Startup Menu” message is displayed at the bottom of the screen, and then press **f9**. Pressing **f9** displays a menu that shows the current boot devices and allows you to select a boot device. Or, you can use MultiBoot Express to set the computer to prompt you for a boot location each time the computer turns on or restarts.

If MultiBoot is disabled, the computer uses a fixed boot order that consists of first searching for a drive A boot device. If none is found, the computer looks for a drive C boot device. Drive A boot devices include optical drives and diskette drives. Drive C boot devices include optical drives and hard drives.

The NIC does not have an assigned drive letter.

 **NOTE:** An optical drive (such as a CD-ROM drive) can boot either as drive A or drive C, depending on the format of the boot CD.

The following list describes the factory setting for boot order in which drive letters A and C are assigned when MultiBoot is disabled. (The actual order varies by configuration.)

- Boot order for drive A boot devices:
 1. Optical drive in an optional docking device or in an optional external MultiBay that contains a disc formatted as drive A
 2. Optical drive in the internal MultiBay (select models only) that contains a disc formatted as drive A
 3. Diskette drive in an optional docking device or in an optional external MultiBay
- Boot order for drive C boot devices:
 1. Optical drive in an optional docking device or in an optional external MultiBay that contains a disc formatted as drive C
 2. Optical drive in the internal MultiBay (select models only) that contains a disc formatted as drive C
 3. Hard drive in the computer hard drive bay
 4. Hard drive in an optional docking device or in an optional external MultiBay

 **NOTE:** Because no drive letter is associated with the NIC, changing the boot order of a NIC does not affect the drive letters of the other devices.

Enabling boot devices in Computer Setup

The computer will boot to a USB device or a NIC device only if the device has first been enabled in Computer Setup.

To start Computer Setup and enable a USB device or a NIC device as a boot device, follow these steps:

1. Turn on or restart the computer, and then press **esc** while the “Press the ESC key for Startup Menu” message is displayed at the bottom of the screen.
2. Press **f10** to enter BIOS Setup.
3. To enable bootable media in USB drives or in drives inserted into an optional docking device (select models only), use a pointing device or the arrow keys to select **System Configuration > Device Configurations**. Confirm that **Enabled** is selected next to **USB legacy support**.

 **NOTE:** The USB Port option must be enabled in order to use USB legacy support. It is enabled at the factory. If the port becomes disabled, reenable it by selecting **System Configuration > Port Options**, and then clicking **Enabled** next to **USB Port**.

– or –

To enable a NIC device, select **System Configuration > Boot Options**, and then click **Enabled** next to **PXE Internal NIC boot**.

4. To save your changes and exit Computer Setup, click **Save** in the lower-left corner of the screen, and then follow the on-screen instructions.

– or –

Use the arrow keys to select **File > Save changes and exit**, and then press **enter**.

Your changes go into effect when the computer restarts.

 **NOTE:** To connect a NIC to a Preboot eXecution Environment (PXE) or Remote Program Load (RPL) server without using MultiBoot, press **esc** while the “Press the ESC key for Startup Menu” message is displayed at the bottom of the screen, and then quickly press **f12**.

Considering boot order changes

Before changing the boot order, note the following considerations:

- When the computer restarts after the boot order has been changed, the computer attempts to start using the new boot order.
- If there is more than one type of boot device, the computer attempts to boot using the first of each type of boot device (except for optical devices). For example, if the computer is connected to an optional docking device (select models only) that contains a hard drive, this hard drive will be shown in the boot order as a USB hard drive. If the system attempts to boot from this USB hard drive and fails, it will not attempt to boot to the hard drive in the hard drive bay. Instead, it will try to boot to the next type of device in the boot order. However, if there are two optical devices, and the first optical device does not boot (either because it does not contain media or the media is not a boot disc), the system will try to boot to the second optical device.
- Changing the boot order also changes the logical drive designations. For example, if you start up from a CD-ROM drive with a disc formatted as drive C, that CD-ROM drive becomes drive C and the hard drive in the hard drive bay becomes drive D.
- The computer will boot from a NIC device only if the device has been enabled in the Built-In Device Options menu of Computer Setup and if booting from the device has been enabled in the Boot Options menu of Computer Setup. Booting from a NIC does not affect logical drive designations because no drive letter is associated with the NIC.
- Drives in an optional docking device (select models only) are treated like external USB devices in the boot order.

Choosing MultiBoot preferences

You can use MultiBoot in the following ways:

- To set a new boot order that the computer uses each time it is turned on, by changing the boot order in Computer Setup.
- To dynamically choose the boot device, by pressing **esc** while the “Press the ESC key for Startup Menu” message is displayed at the bottom of the screen, and then pressing **f9** to enter the Boot Device Options menu.
- To use MultiBoot Express to set variable boot orders. This feature prompts you for a boot device each time the computer is turned on or restarted.

Setting a new boot order in Computer Setup

To start Computer Setup and set a boot device order that the computer uses each time it is turned on or restarted, follow these steps:

1. Turn on or restart the computer, and then press **esc** while the “Press the ESC key for Startup Menu” message is displayed at the bottom of the screen.
2. Press **f10** to enter BIOS Setup.
3. Use a pointing device or the arrow keys to select **System Configuration > Boot Options**. Confirm that **Enabled** is selected next to **MultiBoot**.

 **NOTE:** MultiBoot is enabled at the factory.

4. Use a pointing device or the arrow keys to select a device in the list.
5. To move the device up in the boot order, use a pointing device to click the plus sign (+) or press the **+** key.
– or –
To move the device down in the boot order, click the minus sign (-) or press the **-** key.
6. To save your changes and exit Computer Setup, click **Save** in the lower-left corner of the screen, and then follow the on-screen instructions.

– or –

Use the arrow keys to select **File > Save changes and exit**, and then press **enter**.

Your changes go into effect when the computer restarts.

Dynamically choosing a boot device using the F9 prompt

To dynamically choose a boot device for the current startup sequence, follow these steps:

1. Open the Select Boot Device menu by turning on or restarting the computer, and then pressing **esc** while the “Press the ESC key for Startup Menu” message is displayed at the bottom of the screen.
2. Press **f9**.
3. Use a pointing device or the arrow keys to select a boot device, and then press **enter**.

Your changes go into effect immediately.

Setting a MultiBoot Express prompt

To start Computer Setup and set the computer to display the MultiBoot startup location menu each time the computer is started or restarted, follow these steps:

1. Turn on or restart the computer, and then press **esc** while the “Press the ESC key for Startup Menu” message is displayed at the bottom of the screen.
2. Press **f10** to enter BIOS Setup.
3. Use a pointing device or the arrow keys to select **System Configuration > Boot Options**, and then press **enter**.
4. In the **Express Boot Popup Delay (Sec)** field, enter the length of time in seconds that you want the computer to display the startup location menu before it defaults to the current MultiBoot setting. (When 0 is selected, the Express Boot startup location menu is not displayed).
5. To save your changes and exit Computer Setup, click **Save** in the lower-left corner of the screen, and then follow the on-screen instructions.

– or –

Use the arrow keys to select **File > Save changes and exit**, and then press **enter**.

Your changes go into effect when the computer restarts.

Entering MultiBoot Express preferences

When the Express Boot menu displays during startup, you have the following choices:

- To specify a boot device from the Express Boot menu, select your preference within the allotted time, and then press **enter**.
- To prevent the computer from defaulting to the current MultiBoot setting, press any key before the allotted time expires. The computer will not start until you select a boot device and press **enter**.
- To allow the computer to start according to the current MultiBoot settings, wait for the allotted time to expire.

16 Management and printing

Using Client Management Solutions

Client Management Solutions software provides standards-based solutions for managing client (user) desktop, workstation, notebook, and tablet computers in a networked environment.

Client management includes the following key capabilities and features:

- Initial software image deployment
- Remote system software installation
- Software management and updates
- ROM updates
- Tracking and security of computer assets (the hardware and software installed on the computer)
- Fault notification and recovery of certain system software and hardware components

 **NOTE:** Support for specific features described in this section may vary, depending on computer model and/or version of management software installed on the computer.

Configuring and deploying a software image

The computer is shipped with a preinstalled system software image. The initial software image is configured during the first-time setup of the computer. After a brief software "unbundling" occurs, the computer is ready to be used.

A customized software image can be deployed (distributed) in one of the following ways:

- Installing additional software applications after unbundling the preinstalled software image
- Using software deployment tools, such as Altiris Deployment Solutions, to replace the preinstalled software with a customized software image
- Using a disk-cloning process to copy the contents from one hard drive to another

The deployment method you use depends on your organization's technology environment and processes.

 **NOTE:** The Computer Setup utility and other system features provide further assistance with configuration management and troubleshooting, power management, and the recovery of system software.

Managing and updating software

HP provides several tools for managing and updating software on client computers:

- HP Client Manager for Altiris (select models only)

 **NOTE:** To download HP Client Manager for Altiris or to obtain more information about HP Client Manager for Altiris, see the HP Web site at <http://www.hp.com>.

- HP CCM (Client Configuration Manager) (select models only)
- HP SSM (System Software Manager)

HP Client Manager for Altiris (select models only)

HP Client Manager for Altiris integrates Intelligent Manageability technology into Altiris software. HP Client Manager for Altiris provides superior hardware management capabilities for HP devices:

- Detailed views of hardware inventory for asset management
- System Checkup monitoring and diagnostics
- Web-accessible reporting of business-critical details such as thermal warnings and memory alerts
- Remote updating of system software such as device drivers and the system BIOS

 **NOTE:** Additional functionality can be added when HP Client Manager for Altiris is used with optional Altiris Solutions software (purchased separately).

When HP Client Manager for Altiris (installed on a client computer) is used with Altiris Solutions software (installed on an administrator computer), HP Client Manager for Altiris provides increased management functionality and centralized hardware management of client devices for the following IT life-cycle areas:

- Inventory and asset management
 - Software license compliance
 - Computer tracking and reporting
 - Computer lease contract information and fixed asset tracking
- System software deployment and migration
 - Windows migration
 - System deployment
 - Personality (personal user settings) migration

- Help desk and problem resolution
 - Management of help desk tickets
 - Remote troubleshooting
 - Remote problem resolution
 - Client disaster recovery
- Software and operations management
 - Ongoing client management
 - HP system software deployment
 - Application self-healing (the ability to identify and repair certain application problems)

Altiris Solutions software provides easy-to-use software distribution capabilities. HP Client Manager for Altiris enables communication with the Altiris Solutions software, which can be used to complete new hardware deployment or personality migration to a new operating system using easy-to-follow wizards. HP Client Manager for Altiris is available for download from the HP Web site.

When Altiris Solutions software is used in conjunction with HP System Software Manager or HP Client Manager for Altiris, administrators can also update the system BIOS and device driver software from a central console.

HP CCM (Client Configuration Manager) (select models only)

HP CCM (Client Configuration Manager) automates the management of software such as operating systems, programs, software updates, and content and configuration settings to ensure that each computer is maintained in the correct configuration. With these automated management solutions, you can manage software throughout the life cycle of the computer.

CCM enables you to perform the following tasks:

- Collect hardware and software inventory across multiple platforms
- Prepare a software package and conduct impact analysis prior to distribution
- Target individual computers, workgroups, or entire populations of computers for deployment and maintenance of software and content according to policies
- Provision and manage operating systems, applications, and content on distributed computers from any location
- Integrate CCM with help desks and other system management tools for seamless operations
- Leverage a common infrastructure for management of software and content on standard computing devices across any network for all enterprise users
- Scale to meet enterprise needs

HP SSM (System Software Manager)

HP SSM (System Software Manager) lets you remotely update system-level software on multiple systems simultaneously. When executed on a client computer, SSM detects versions of both hardware and software, and then updates designated software from a central repository, known as a file store. Driver versions that are supported by SSM are denoted with a special icon on the HP driver download

Web site and on the *Support Software* CD. To download the SSM utility or to obtain more information on SSM, see the HP Web site at <http://www.hp.com/go/ssm> (English only).

Antenna House XSL Formatter

Using Intel Active Management Technology (select models only)

Intel® Active Management Technology (iAMT) allows discovery, repair, and protection of networked computing assets. With iAMT, computers can be managed whether they are on or off. The iAMT solution is available on computers with Intel Centrino® with vPro mobile technology.

Features of iAMT include:

- Hardware inventory information
- Event notification
- Power management
- Remote diagnosis and repair
- Hardware-based isolation and recovery—limit or cut off computer network access if virus-like activity is detected

Enabling the iAMT solution

To configure iAMT settings:

 **NOTE:** The **ctrl+p** prompt is visible only if the AMT Setup Prompt option is enabled in Computer Setup.

1. Turn on or restart the computer.
2. Before Windows starts up, press **ctrl+p**.

 **NOTE:** If you do not press **ctrl+p** at the appropriate time, you must repeat steps 1 and 2 to access the MEBx setup utility.

3. Enter the ME password. The factory setting for the password is `admin`.
The MEBx setup utility opens. Use the arrow keys to navigate.
4. Choose to configure Intel ME, configure iAMT, or change the Intel ME password.
5. When you have made your selections, select **Exit** to close the MEBx setup utility.

Using the MEBx setup utility menus

 **NOTE:** For more information on iAMT, go to the Intel Web site at <http://www.intel.com>, and then search for iAMT.

Intel ME Configuration

Select	To do this
Intel ME State Control	Disable/enable the management engine.
Intel ME Firmware Local Update	Disable/enable local management of firmware updates.
LAN Controller	Disable/enable the integrated network controller.
Intel ME Features Control	Enable AMT or none.
Intel ME Power Control	Configure the management engine power policies.

iAMT Configuration

Select	To do this
Host Name	Assign a host name to the computer.
TCP/IP	Disable/enable network interface or DHCP (assigns an IP address if DHCP has been disabled) or change the domain name.
Provision Model	Assign Enterprise or Small Business iAMT model.
Setup and Configuration	Set options to control remote configuration of AMT.
Un-Provision	Reset the AMT configuration to factory defaults.
SOL/IDE-R	Enable remote boot control to IDE diskette or CD-ROM and assign a user name and password.
Password Policy	Set options to control requirements for the network password and the MEBx password.
Secure Firmware Update	Enable or disable updating firmware remotely.
Set PRTC	Set the real-time clock.
Idle Timeout	Set a time-out value.

Change Intel ME Password

Select	To do this
Change ME Password	Change the password. NOTE: The default password is admin .

Using the HP Universal Print Driver (select models only)

The HP Universal Print Driver Series for Windows is a single intelligent driver that replaces individual drivers for HP networked printers.

 **NOTE:** The HP Universal Print Driver is preinstalled on select computer models only. To download the HP Universal Print Driver or obtain more information about using it, see the HP Web site at <http://www.hp.com/go/universalprintdriver> (English only).

To print using the HP Universal Print Driver:

1. Select **File > Print** from any application.
2. Select **HP Universal Printing PS** from the list of printers.
3. Click **Print**.
4. Enter the printer's IP address or network path.

 **NOTE:** If you cannot identify the printer's IP address or network path, contact your IT administrator for help.

5. Select the **Make a permanent instance of this printer in my Printers folder** check box.
6. Click **Print**.

Index

Symbols/Numerics

- 1394 cable, connecting 88
- 1394 devices
 - connecting 88
 - stopping 88
- 1394 port
 - identifying 8
 - using 88

A

- AC adapter
 - connecting 65
 - identifying 13
- accessory battery connector, identifying 10
- Active Management Technology, Intel 146
- administrator password 102
- airport security devices 78
- Altiris Deployment Solutions 142
- ambient light sensor
 - hotkey 44
 - identifying 11
- AMT options
 - AMT setup prompt (CTRL-P) 135
 - firmware progress event support 135
 - firmware verbosity 135
 - terminal emulation mode 135
 - TYPE-131 in SMBIOS 135
 - unconfigure AMT on next boot 135
 - USB key provisioning support 135
- antennas
 - external WWAN 12
 - WLAN 12
 - WWAN 12
- applications key, Windows 5

- audio devices, connecting
 - external 56
- audio functions, checking 56
- audio-in (microphone) jack, identifying 7
- audio-out (headphone) jack, identifying 7
- Automatic DriveLock password
 - entering 108
 - removing 108

B

- backing up files 124
- Backup and Restore 123, 124
- battery
 - calibrating 71
 - charging 68, 71
 - conserving power 73
 - disposing 74
 - identifying 13
 - inserting 67
 - low battery levels 69
 - recharging 73
 - removing 67
 - replacing 74
 - storing 74
- battery bay 10, 14
- battery charge information 44
- battery charge, maximizing 69
- battery light 3, 68, 69
- battery power 66
- battery release latch, identifying 10, 67
- battery temperature 74
- battery test 132
- bays
 - battery 10, 14
 - hard drive 10
- BIOS administrator password 131

- BIOS update
 - downloading 119
 - installing 119
- Bluetooth compartment, identifying 6
- Bluetooth device 20, 30
- Bluetooth label 14
- boot devices, enabling 138
- boot options 133
- boot order 133
- built-in device
 - ambient light sensor 134
 - Bluetooth device radio 134
 - embedded WLAN 134
 - fingerprint reader 134
 - integrated camera 134
 - LAN/WLAN switching 134
 - modem 134
 - Network Interface Controller (LAN) 134
 - Notebook Multibay 134
 - Wake on LAN 134
 - wireless button 134
 - WWAN device radio 134
- built-in device options 134
- business card reader software 60
- business card slot 6
- buttons
 - ctrl+alt+del 9, 15
 - esc 9, 15
 - external WWAN antenna 6, 12
 - keyboard light 11
 - pointing stick 2
 - Quick Launch 46
 - QuickLook 7, 46
 - QuickWeb 7, 46
 - rotate 9, 15
 - TouchPad 2

- volume down 4
 - volume mute 4, 53
 - volume up 4
- C**
- cables
 - 1394 88
 - LAN 39
 - modem 34
 - USB 86
 - calibrating battery 71
 - caps lock light, identifying 3
 - CD
 - protecting 55
 - writing to 55
 - CD drive 89
 - Certificate of Authenticity label 14
 - changing boot order 140
 - charge level indicator, identifying 10
 - charging batteries 68, 71
 - checking audio functions 56
 - components
 - additional hardware 13
 - bottom 10
 - display 11
 - front 6
 - left-side 8
 - rear 9
 - right-side 7
 - top 1
 - composite video 43
 - computer information 118
 - Computer Setup
 - BIOS administrator password 103
 - device security 109
 - Diagnostics menu 132
 - DriveLock password 105
 - enabling bootable devices 138
 - File menu 131
 - navigating and selecting 129
 - restoring factory settings 130
 - Security menu 131
 - setting boot order 140
 - setting MultiBoot Express prompt 141
 - System Configuration menu 133
 - Computer Setup utility 142
 - configuring ExpressCards 93
 - connecting to a LAN 39
 - connecting to a WLAN 25
 - Connection Manager icon 21
 - connection, external power 65
 - connector, power 9
 - conservation, power 73
 - convertible hinge, identifying 11, 15
 - cord, power 13
 - corporate WLAN connection 25
 - country- or region-specific modem cable adapter, identifying 13
 - country-specific modem cable adapter 34
 - creating a backup 124
 - critical battery level 70
 - ctrl+alt+del button 9, 15
- D**
- deployment, software 142
 - device configurations 133
 - device security 109
 - Diagnostics menu 132
 - digital card
 - inserting 91
 - removing 92
 - stopping 92
 - Disk Cleanup software 79
 - Disk Defragmenter software 79
 - Disk Sanitizer 132
 - diskette drive 89
 - display
 - image, switching 43
 - notebook mode 18
 - rotating 16
 - screen brightness hotkeys 44
 - tablet mode 16
 - display release latch, identifying 6
 - display switch, identifying 4
 - docking connector
 - identifying 10
 - using 90
 - drive light
 - identifying 3
 - status 80
 - drive media 62
 - DriveLock password
 - changing 106
 - description 105
 - entering 106
 - removing 107
 - setting 106
 - DriveLock, automatic 132
 - drives
 - boot order 133, 136
 - caring for 78
 - diskette 89
 - external 89
 - hard 82, 83, 89
 - optical 89
 - Dual Core CPU 134
 - DVD
 - protecting 55
 - writing to 55
 - DVD drive 89
- E**
- encryption 25
 - error log 132
 - esc button 9, 15
 - esc key, identifying 5
 - Execution Disable 133
 - ExpressCard
 - configuring 93
 - inserting 93
 - removing 94
 - removing insert 93
 - stopping 94
 - ExpressCard slot 8
 - external audio devices, connecting 56
 - external drive 89
 - external monitor port
 - identifying 9
 - using 58
 - external WWAN antenna button, identifying 6
- F**
- f11 recovery 127
 - File menu 131
 - fingerprint reader, identifying 7, 11
 - firewall 25

- fn key
 - identifying 5
 - using 2
- function keys
 - identifying 5
 - using 42
- H**
- hard disk drive
 - HP 3D DriveGuard 80
 - installing 83
 - replacing 82
- hard disk test 132
- hard drive
 - external 89
 - HP 3D DriveGuard 80
 - installing 83
 - replacing 82
- hard drive bay, identifying 10
- hard drive recovery 127
- HDMI 43
- headphone (audio-out) combo jack 7
- Hibernation
 - exiting 63
 - initiated during critical battery level 70
 - initiating 63
- hinge, convertible 11, 15
- holder, pen 16
- hotkeys
 - ambient light sensor 44
 - battery charge information 44
 - decreasing screen brightness 44
 - description 42
 - displaying system information 42
 - enabling/disabling the TouchPad 42
 - increasing screen brightness 44
 - initiating Sleep 43
 - switching screen image 43
 - using 42
- HP 3D DriveGuard 80
- HP Client Configuration Manager 143, 144
- HP Client Manager for Altiris 143

- HP Connection Manager software 22
- HP Mobile Broadband Module 27
- HP QuickLook 2 134
- HP SpareKey enrollment 131
- HP System Software Manager 143, 144
- HP Universal Print Driver, using 148
- hubs 86

- I**
- icons
 - Connection Manager 21
 - network 32
 - network status 21
 - wireless 21
- IEEE 1394 port, identifying 8
- image, computer 142
- inserting a memory module 99
- Intel Centrino Pro technology 146
- interference, minimizing 33
- internal display switch, identifying 4
- internal microphone, identifying 11
- Internet connection setup 24

- J**
- jacks
 - audio-in (microphone) 7
 - audio-out (headphone) 7
 - RJ-11 (modem) 7
 - RJ-45 (network) 9
- Java Card
 - defined 96
 - inserting 96
 - removing 96
- jog dial 9, 15

- K**
- keyboard hotkeys, identifying 42
- keyboard light
 - using 40
- keyboard light button, identifying 11
- keypad keys, identifying 5
- keypad, embedded
 - enabling and disabling 51

- switching key functions 51
- using 51
- keys
 - esc 5
 - fn 5
 - function 5
 - keypad 5
 - Windows applications 5
 - Windows logo 5

- L**
- labels
 - Bluetooth 14
 - HP Mobile Broadband Module 14
 - Microsoft Certificate of Authenticity 14
 - modem approval 14
 - regulatory 14
 - service tag 14
 - SIM 14
 - wireless certification 14
 - WLAN 14
- LAN Power Save 133
- LAN, connecting 39
- language, changing in Computer Setup 133
- latch, battery release 10
- legacy support, USB 129, 133
- lights
 - battery 3
 - caps lock 3
 - drive 3, 80
 - keyboard 40
 - mute 3
 - num lock 4
 - power 3
 - TouchPad 1, 3
 - volume down 3
 - volume mute 3
 - volume up 4
 - webcam 6, 11
 - wireless 8
- local area network (LAN)
 - cable required 39
 - connecting cable 39
- logical drive designations 139
- low battery level 69

M

maintenance

- Disk Cleanup 79
- Disk Defragmenter 79
- McAfee Total Protection 111, 112
- Media Card Reader, identifying 8
- memory module
 - adding 98
 - inserting 99
 - removing 98
 - replacing 98

memory test 132

microphone (audio-in) combo

- jack 7

microphone, internal 11

Microsoft Certificate of Authenticity

- label 14

minimizing interference 33

modem approval label 14

modem cable

- connecting 34
- country-specific cable adapter 34
- noise suppression circuitry 34

modem cable adapter, identifying 13

modem cable, identifying 13

modem software

- setting/adding location 35
- travel connection problems 37

monitor port, external 9

monitor, connecting 58

mouse, external

- connecting 40
- setting preferences 40

MultiBoot Express 136, 141

multimedia software

- accessing 55

mute button, identifying 4, 53

mute light, identifying 3

N

network cable

- connecting 39
- noise suppression circuitry 39

network icon 32

network key 32

network security codes

- network key 32
- SSID 32

Network Service Boot 138

network status icon 21

NIC boot device 136, 138

noise suppression circuitry

- modem cable 34
- network cable 39

num lock light, identifying 4

O

operating system

Microsoft Certificate of Authenticity label 14

Product Key 14

optical disc

- writing to 55

optical drive

- protecting 55

P

parallel port mode 133

passwords

- administrator 102
- BIOS administrator 103
- DriveLock 105
- user 102

pen

- calibrating 50
- identifying 48
- setting preferences 51
- using 48

pen holder

- identifying 8, 16
- using 50

pointing devices

- setting preferences 40
- using 40

pointing stick

- identifying 2
- using 40

pointing stick buttons, identifying 2

port options

- 1394 port 135
- ExpressCard slot 135
- flash media reader 135
- parallel port 135
- serial port 135

Smart Card slot 135

USB port 135

ports

- 1394 8, 88
- external monitor 9, 58
- USB 7, 86

power

- connecting 65
- conserving 73

power connector, identifying 9

power cord, identifying 13

power light, identifying 3

power plans 63

power switch, identifying 6

Product Key 14

product name and number, computer 14

projector, connecting 58

public WLAN connection 25

PXE server 138

Q

Quick Launch Buttons 46

Quick Launch Buttons control panel 46

QuickLook button, identifying 7, 46

QuickWeb button, identifying 7, 46

R

RAID (Redundant Array of Independent Disks)

devices 133

readable media 62

reader, fingerprint 7, 11

recovery partition 127

regulatory information

- modem approval label 14

regulatory label 14

wireless certification labels 14

release latch, battery 10, 67

replacing a memory module 98

restore security defaults 135

restore the factory settings 131

restoring the hard drive 127

RJ-11 (modem) jack,

- identifying 7

RJ-45 (network) jack,

- identifying 9

rotate button 9, 15
run-in test 132

S

S-Video 43
SATA (Serial Advanced Technology Attachment) devices
 AHCI (Advanced Host Controller Interface) 133
 IDE (Integrated Drive Electronics) 133
screen brightness hotkeys 44
screen image, switching 43
scroll zone, TouchPad 2
Secondary Battery Fast Charge 134
security cable slot, identifying 7
Security menu
 allow reset of HP ProtectTools security keys 131
 always prompt for HP SpareKey enrollment 131
 Automatic DriveLock 132
 change password 131
 Disk Sanitizer 132
 DriveLock 131
 fingerprint reader reset 131
 HP Sparekey 131
 HP Sparekey enrollment 131
 password policy 131
 set up BIOS administrator password 131
 System IDs 132
 user management 131
security, wireless 24
serial number, computer 14
service tag 14
set security level 135
setup of WLAN 24
setup utility
 Diagnostics menu 132
 File menu 131
 navigating and selecting 129
 restoring factory settings 130
 Security menu 131
 System Configuration menu 133
setup, computer 1
shutdown 75
shutting down 75

SIM

 inserting 27
 removing 28
SIM slot, identified 10
Sleep
 exiting 62
 initiating 62
Sleep hotkey 43
slots
 business card 6
 ExpressCard 8
 Media Card Reader 8
 memory 97
 memory module 10
 security cable 7
 SIM 10
 smart card reader 7
smart card
 defined 96
 inserting 96
 removing 96
smart card reader, identifying 7
SoftPaqs, downloading 121, 122
software
 BIOS update 119
 business card reader 60
 deployment 142
 Disk Cleanup 79
 Disk Defragmenter 79
 HP Connection Manager 22
 recovery 142
 updates 143
 updating programs and drivers 121
 Wireless Assistant 22
start-up test 132
storing battery 74
switches
 internal display 4
 power 6
 wireless 8
System Configuration menu 133
system date and time 131
System Diagnostics menu 132
system fan 133
system IDs 132
system information 131
system information hotkey 42

T

tablet display components 15
temperature 74
tips, webcam 59
TouchPad
 buttons 2
 enabling/disabling 42
 identifying 2
 scroll zone 2
 using 40
TouchPad light 1, 3
TouchPad on/off control 1
TPM Embedded Security 132
traveling with the computer
 modem approval label 14
troubleshooting 31
troubleshooting modem 37
turning off the computer 75
TXT (Intel® Trusted Execution Technology) 134

U

Unified Extensible Firmware Interface (UEFI) mode 134
Universal Print Driver, using 148
unresponsive system 75
updates, software 143
USB cable, connecting 86
USB devices
 connecting 86
 description 86
 removing 86
 stopping 86
USB hubs 86
USB legacy support 87, 129, 133
USB port, powered 8
USB ports, identifying 7, 86
user password 102
using the webcam 59

V

vents, identifying 6, 8, 10
video transmission types 43
Virtualization Technology 134
volume buttons 53
volume down button, identifying 4
volume down light, identifying 3

- volume mute button,
 - identifying 4, 53
- volume mute light, identifying 3
- volume up button, identifying 4
- volume up light, identifying 4
- volume, adjusting 53

W

- Web sites
 - HP System Software Manager 145
 - HP Universal Print Driver 148
 - Intel Centrino Pro 146
 - Intel Pro technology for AMT 146
- webcam
 - capturing business cards 60
 - identifying 11
 - tips 59
 - using 59
- webcam light, identifying 6, 11
- webcam properties, adjusting 59
- Windows 7 operating system
 - DVD 127
- Windows applications key,
 - identifying 5
- Windows logo key, identifying 5
- wireless antennas 12
- Wireless Assistant software 21, 22
- wireless button 21
- wireless certification label 14
- wireless controls
 - button 21
 - Connection Manager software 21
 - operating system 21
 - Wireless Assistant software 21
- wireless devices
 - location 10
 - types 20
- wireless icon 21
- wireless light, identifying 8, 21
- wireless network (WLAN)
 - connecting 25
 - corporate WLAN connection 25
 - described 20
 - equipment needed 24
 - functional range 26
 - public WLAN connection 25
 - security 24
 - using 24
- wireless switch, identifying 8
- wireless wide area network (WWAN) 27
- WLAN antennas, identifying 12
- WLAN device 14, 20, 24
- WLAN label 14
- writable media 62
- WWAN antenna button,
 - external 12
- WWAN antenna, external 6, 12
- WWAN antennas, identifying 12
- WWAN device 20, 27

EXSLT
ANTENNA HOUSE
XSL FORMATTER