

Regulatory WLAN Antenna Information

(English Language Required for Intel Regulatory Review / Approval)

Platform	
Platform Owner	Hewlett-Packard International Pte. Ltd.
Brand Name	Hewlett-Packard International Pte. Ltd.
Model Name	Harbour
ODM	Inventec Corporation
Target Launch Date	(2008 / 09 / 12)
Antenna	
Brand Name	Wistron Neweb Corp.
Part Number	<input checked="" type="checkbox"/> Main Antenna: 6036B0044201
	<input checked="" type="checkbox"/> Aux Antenna: 6036B0044301
Module	
With WLAN Module	<input type="checkbox"/> WM3B2200BG
(Check Box)	<input type="checkbox"/> WM3B2915ABG
	<input type="checkbox"/> WM3945ABG
	<input type="checkbox"/> 4965AGN
	<input type="checkbox"/> 4965AG_
	<input type="checkbox"/> 533ANX Family
	<input type="checkbox"/> 512ANX Family
	<input type="checkbox"/> 533AN Family
	<input type="checkbox"/> 512AN Family
	<input checked="" type="checkbox"/> Demi (Broadcom 4312)

Antenna Sample / Antenna Data Requirements for worldwide regulatory approval

Section	Description of Required OEM / ODM Antenna Information	US / IC	EU	Japan	Taiwan	S.Korea
1A	Part Number for Antenna only	Required	Required	Required	Required	Required
1B	Antenna Manufacturer Name	Required	Required	Required	Required	Required
1C	Description of Antenna Type	Required	N/A	N/A	N/A	N/A
1D	Part number of Antenna Assembly / cable impedance, length & diameter.	Required	Desired	Desired	Desired	Desired
1E	Tx1, Tx2 & Tx3 antenna (Peak Gain W/ cable loss) *	Required	Required	Required	Required	Required
	1E OR 1F, 1G, 1H					
1F	Tx1, Tx2 & Tx3 antenna (Peak Gain only) *	Required	Required	Required	Required	Required
1G	VSWR of cable including connector	Required	Required	Required	Required	Required
1H	Tx1, Tx2 & Tx3 antenna (Cable loss W/ connector) *	Required	Required	Required	Required	Required
2	Dimensioned Photographs <u>and</u> Drawings of Tx1, Tx2, and Tx3 (or Rx3) antennas	Required	Required	Required	Required	Required
3	Radiation patterns of antennas loaded in the host platform.	Required	Desired	Required	N/A	Required
4	Platform model name / number - correlated to antenna manufacturer and antenna part number	Required	Required	Desired	Required	Desired
5	Photograph(s) or Drawings showing location of antennas in platform. <u>(S. Korea requires photographs of antennas for approval submission). Taiwan requires pictures of each antenna type shown in the system.</u>	Required	Required	Desired	<u>Required (Photos)</u>	<u>Required (Photos)</u>
6	Mech. drawings / photos with dimensions of antenna locations and distance from end-user (For evaluation of SAR testing requirement).	Required	N/A	N/A	N/A	N/A
7	Photograph(s) or Drawings showing the location of all antennas (WLAN, other) and distance between those transmitting antennas. Information will be used to evaluate whether co-location testing is required.	Required	N/A	N/A	N/A	N/A
8	Local representative contact information for LMA/ PARS process.	Required	N/A	N/A	N/A	N/A

NOTE:

(*) if 3rd antenna is Rx only (e.g. receive only for 4965AGN) then peak gain and cable loss not required

Antenna Information

Section 1. Antenna Assembly Specifications

Antenna Assembly Summary:

1A	1B	1C	1D	1E	1F	1G	1H
Antenna Part Number	Manufacture	Antenna Type	Cable Assembly Part Number and Information	Peak Gain W/ Cable loss (dBi)	Peak Gain w/o Cable Loss (dBi)	VSWR	Cable Loss (dBi)
Main Antenna (WNC P/N:81.EDG15.052) (customer P/N:6036B0044201)	Wistron Neweb Corporation	PIFA	P/N: 1371411B(221) 50 ohm Coaxial. length: 411 mm diameter: 1.37 mm Connector: IPEX	2400-2500MHz 2.08 dBi (peak)	2400-2500MHz 3.16 dBi (peak)	2400-2500MHz 2.0 max	2400-2500MHz 1.08 dBi (peak)
				5150-5350MHz 0.16 dBi (peak)	5150-5350MHz 1.84 dBi (peak)	5150-5350MHz 2.5 max	5150-5350MHz 1.67 dBi (peak)
				5470-5725MHz 1.89 dBi (peak)	5470-5725MHz 3.66 dBi (peak)	5470-5725MHz 2.5 max	5470-5725MHz 1.77 dBi (peak)
				5725-5850MHz 1.82 dBi (peak)	5725-5850MHz 3.61 dBi (peak)	5725-5850MHz 2.5 max	5725-5850MHz 1.80 dBi (peak)
AUX Antenna (WNC P/N:81.EDG15.053) (customer P/N:6036B0044301)	Wistron Neweb Corporation	PIFA	P/N: 1371585G(221) 50 ohm Coaxial. length: 585 mm diameter: 1.37 mm Connector: IPEX	2400-2500MHz 1.57 dBi (peak)	2400-2500MHz 3.02 dBi (peak)	2400-2500MHz 2.0 max	2400-2500MHz 1.45 dBi (peak)
				5150-5350MHz -0.27 dBi (peak)	5150-5350MHz 2.01 dBi (peak)	5150-5350MHz 2.5 max	5150-5350MHz 2.28 dBi (peak)
				5470-5725MHz 0.73 dBi (peak)	5470-5725MHz 3.14 dBi (peak)	5470-5725MHz 2.5 max	5470-5725MHz 2.41 dBi (peak)
				5725-5850MHz 1.59 dBi (peak)	5725-5850MHz 4.04 dBi (peak)	5725-5850MHz 2.5 max	5725-5850MHz 2.45 dBi (peak)

NOTE:

(*) If Rx3 only (3rd antenna receives only, e.g. for 4965AGN) then the information marked with * is not required

Antenna Peak Gain Table:

Frequency (MHz)	Main Antenna		Aux Antenna	
	Horizontal	Vertical	Horizontal	Vertical
	(dBi)	(dBi)	(dBi)	(dBi)
2400	1.08	0.30	1.57	-0.55
2450	1.46	-0.66	1.53	-0.39
2500	2.08	-0.80	1.48	-0.29
5150	-0.42	-2.56	-0.47	-4.75
5250	0.16	-1.75	-1.11	-2.72
5350	-0.51	-3.45	-0.27	-1.67
5470	-1.29	-1.23	0.23	-1.12
5600	-0.67	1.48	-0.61	-1.01
5725	1.69	1.89	0.67	0.73
5785	1.13	1.82	0.87	0.47
5850	1.58	1.60	1.59	0.56

- Antenna Peak Gain required being test in system basis.
- 1E frame contend absolutely peak antenna gain include H/V
- If Rx3 only (3rd antenna receives only, e.g. for 4965AGN) then the information is not required for Rx3.

Section 2. Dimensioned Photos or Drawings of Antennas

Include a dimensioned photo and dimensioned drawing of Main and AUX antenna here.

Main Antenna Dimensioned Drawing:

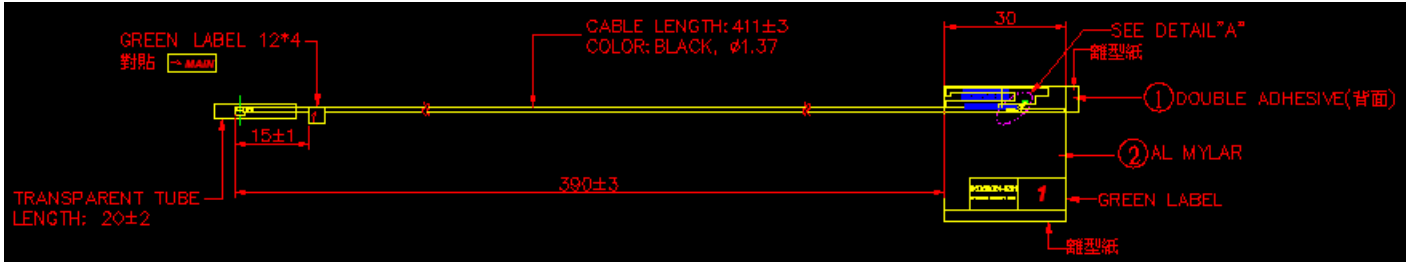

Main Antenna Photo:



Auxiliary Antenna Dimensioned Drawing:

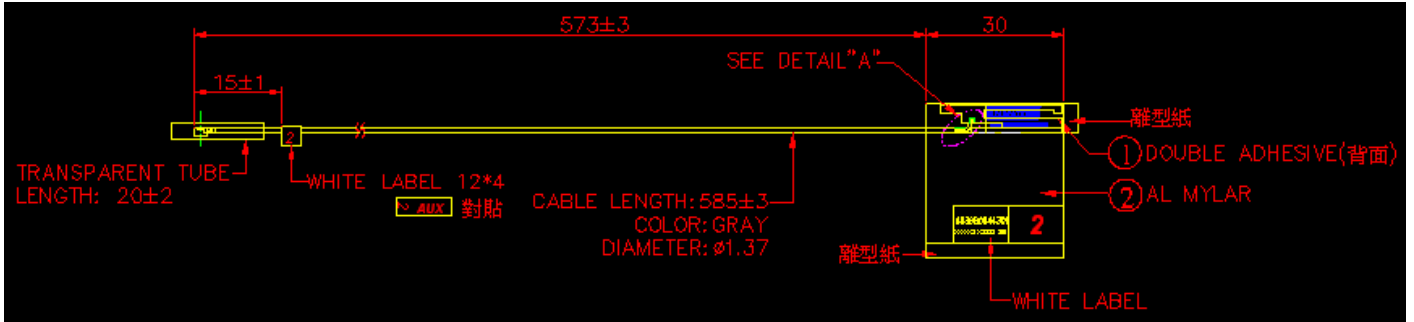

Auxiliary Antenna Photo:



Section 3. Radiation characteristics of antennae Loaded in Host Platform

2400-2500MHz radiation characteristic

Main antenna: 2400 MHz

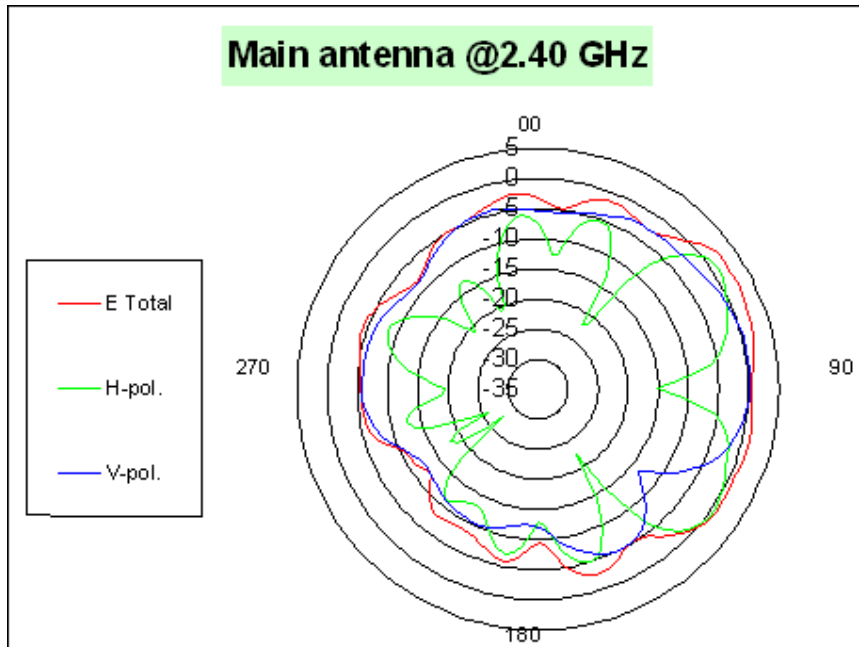

	H-pol	V pol
Peak Gain	1.08	0.30

Main antenna: 2450 MHz

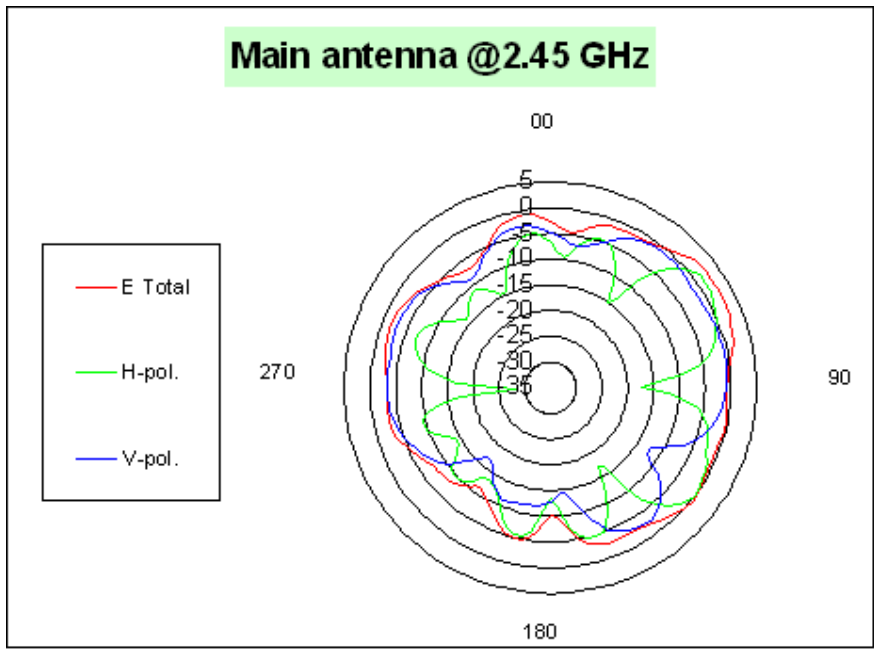

	H-pol	V pol
Peak Gain	1.46	-0.66

Main antenna: 2500 MHz

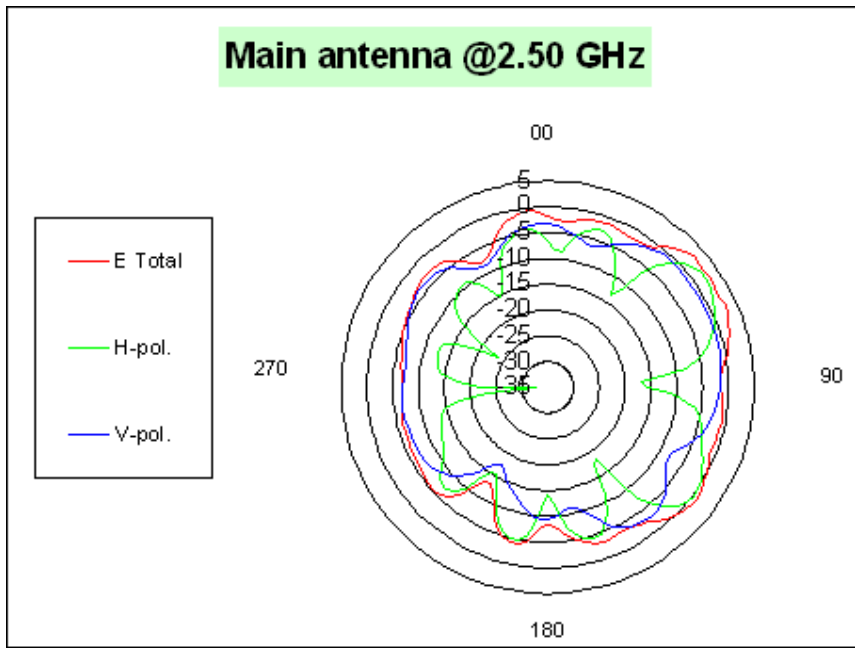

	H-pol	V pol
Peak Gain	2.08	-0.80

Auxiliary antenna: 2400 MHz

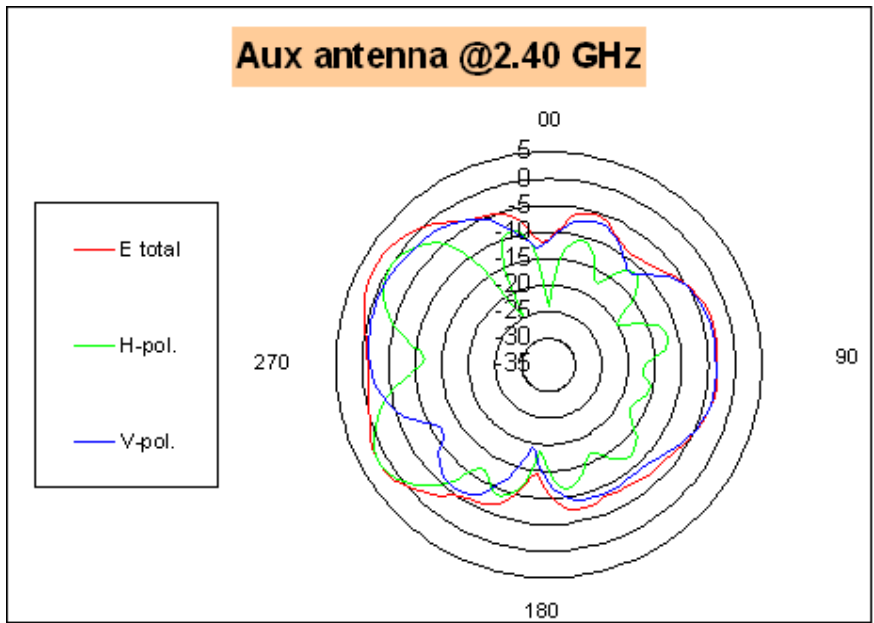

	H-pol	V pol
Peak Gain	1.57	-0.55

Auxiliary antenna: 2450 MHz

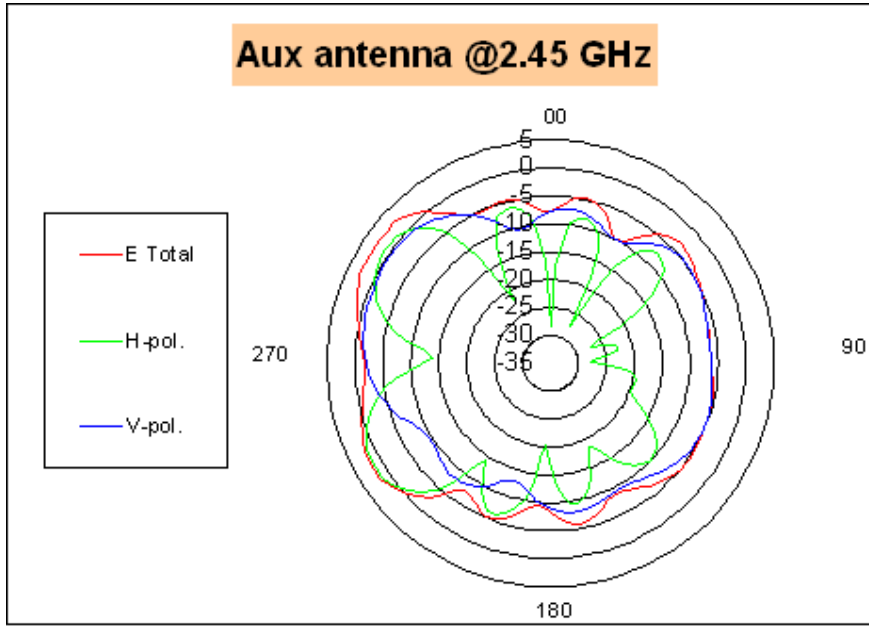

	H-pol	V pol
Peak Gain	1.53	-0.39

Auxiliary antenna: 2500 MHz

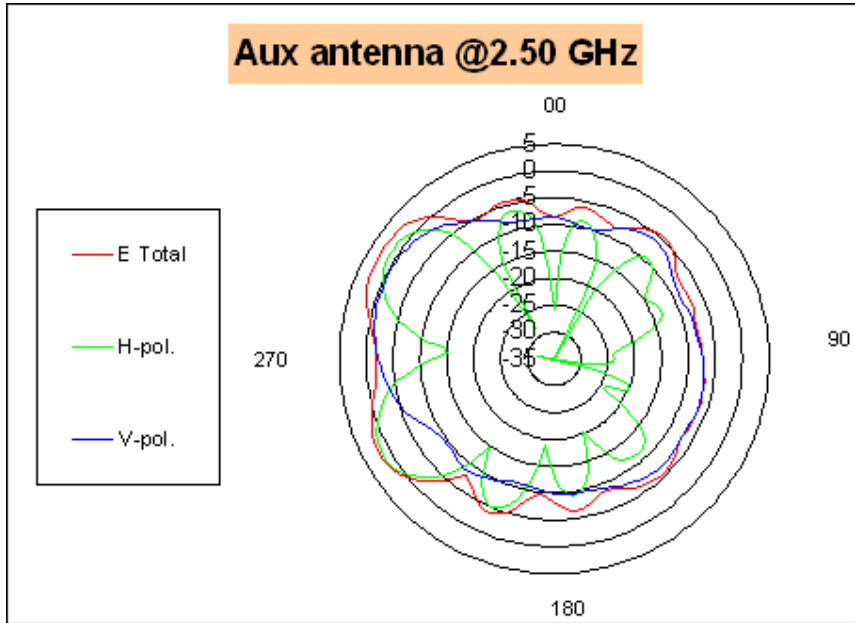

	H-pol	V pol
Peak Gain	1.48	-0.29

5150-5350 MHz radiation characteristic

Main antenna: 5150 MHz

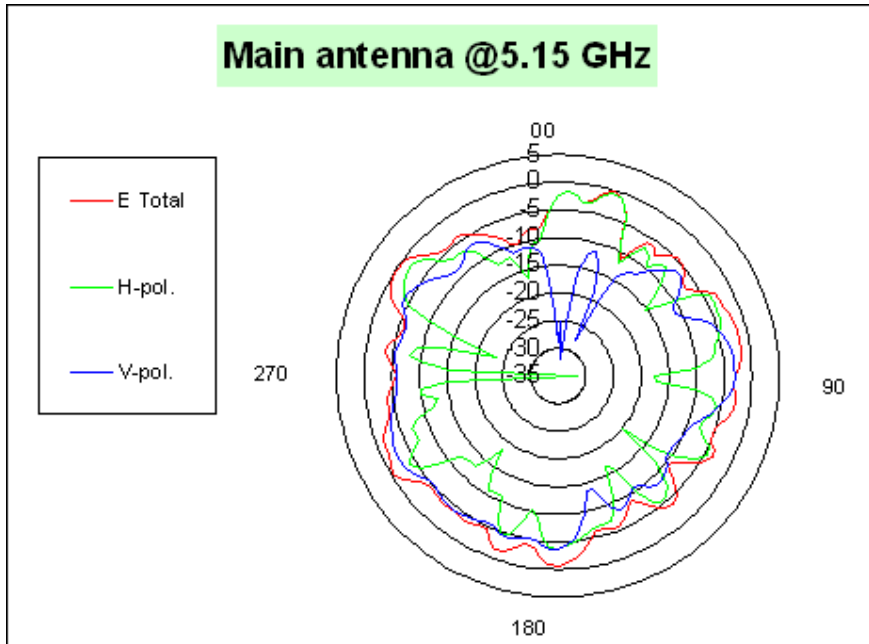

	H-pol	V pol
Peak Gain	-0.42	-2.56

Main antenna: 5250 MHz

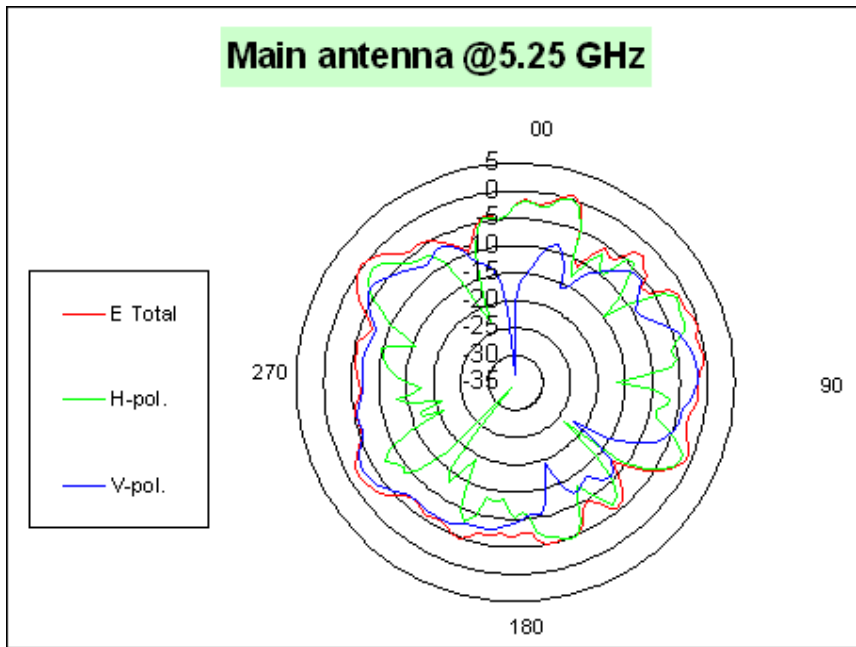

	H-pol	V pol
Peak Gain	0.16	-1.75

Main antenna: 5350 MHz

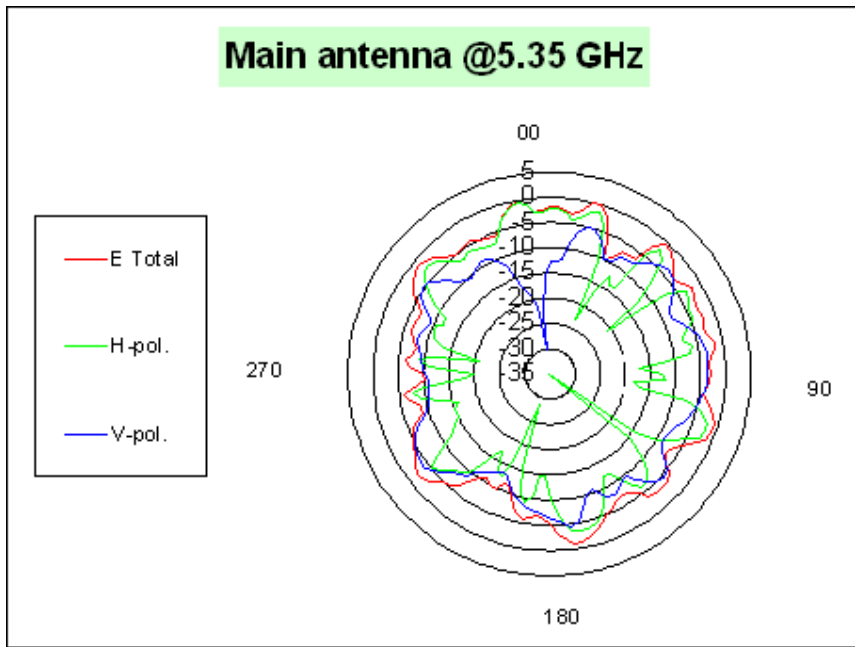

	H-pol	V pol
Peak Gain	-0.51	-3.45

Auxiliary antenna: 5150 MHz

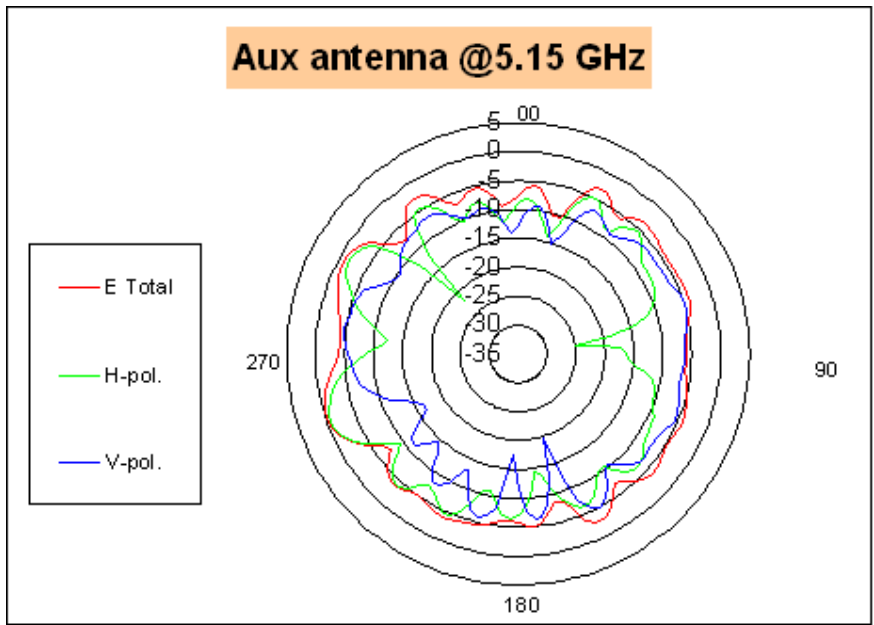

	H-pol	V pol
Peak Gain	-0.47	-4.75

Auxiliary antenna: 5250 MHz

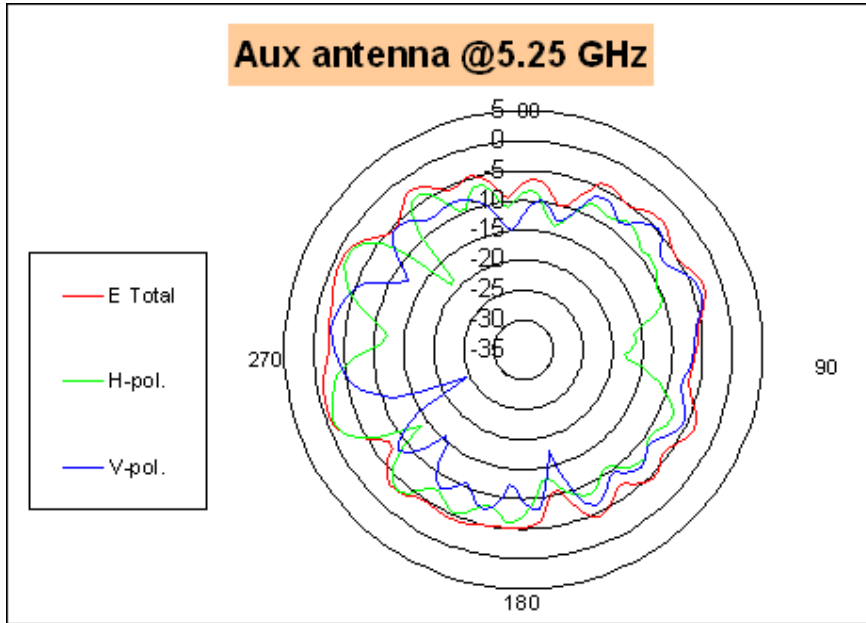

	H-pol	V pol
Peak Gain	-1.11	-2.72

Auxiliary antenna: 5350 MHz

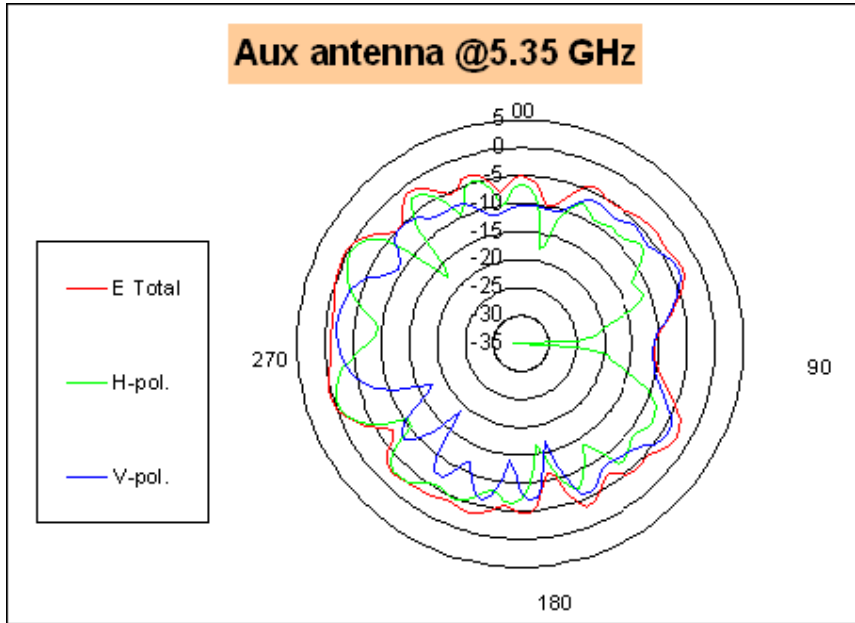

	H-pol	V pol
Peak Gain	-0.27	-1.67

5470-5725MHz radiation characteristic

Main antenna: 5470 MHz

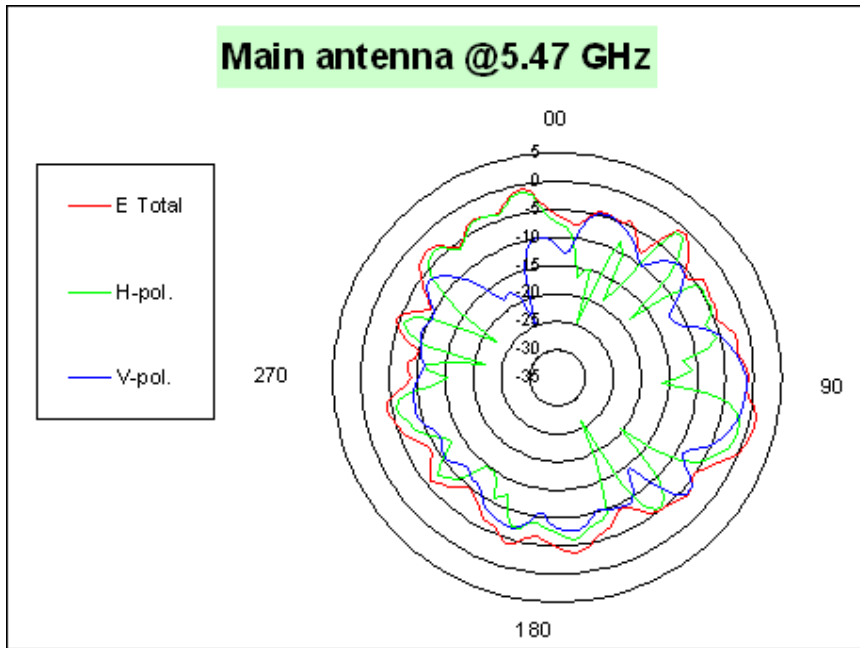

	H-pol	V pol
Peak Gain	-1.29	-1.23

Main antenna: 5600 MHz

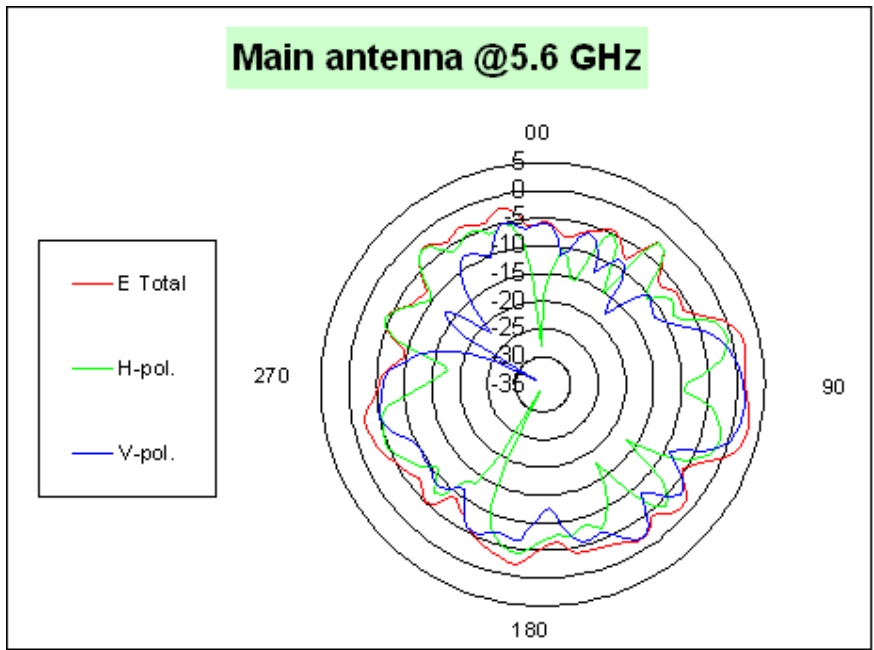

	H-pol	V pol
Peak Gain	-0.67	1.48

Main antenna: 5725 MHz

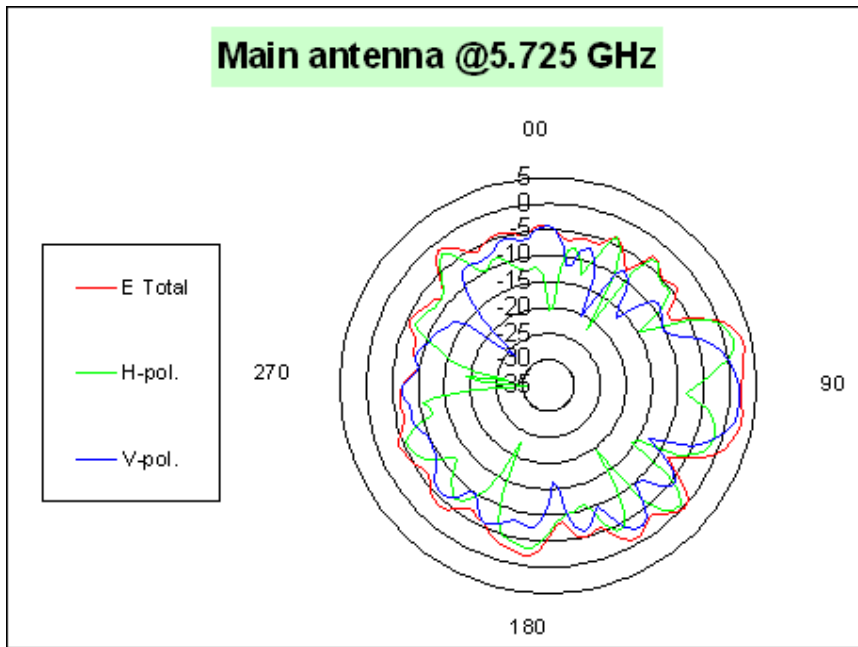

	H-pol	V pol
Peak Gain	1.69	1.89

Auxiliary antenna: 5470 MHz

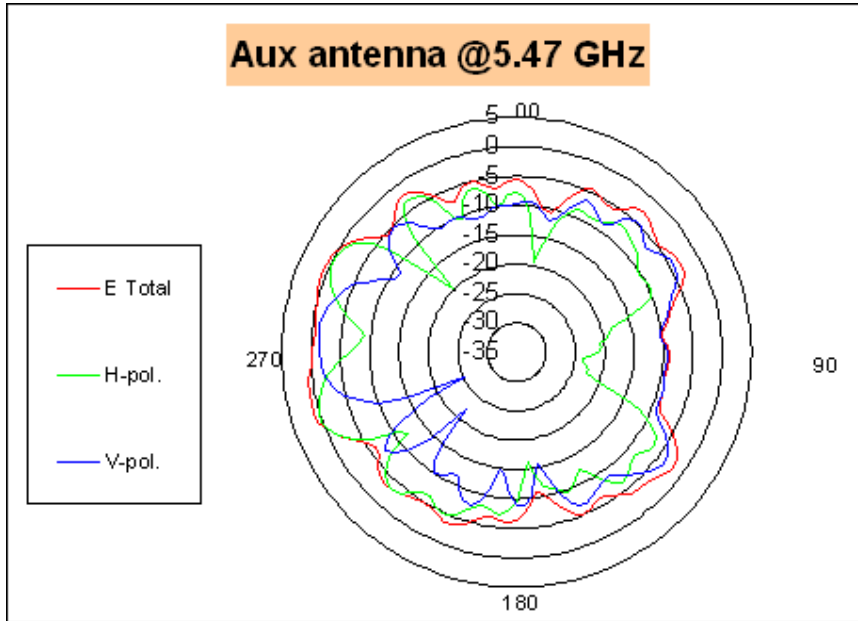

	H-pol	V pol
Peak Gain	0.23	-1.12

Auxiliary antenna: 5600 MHz

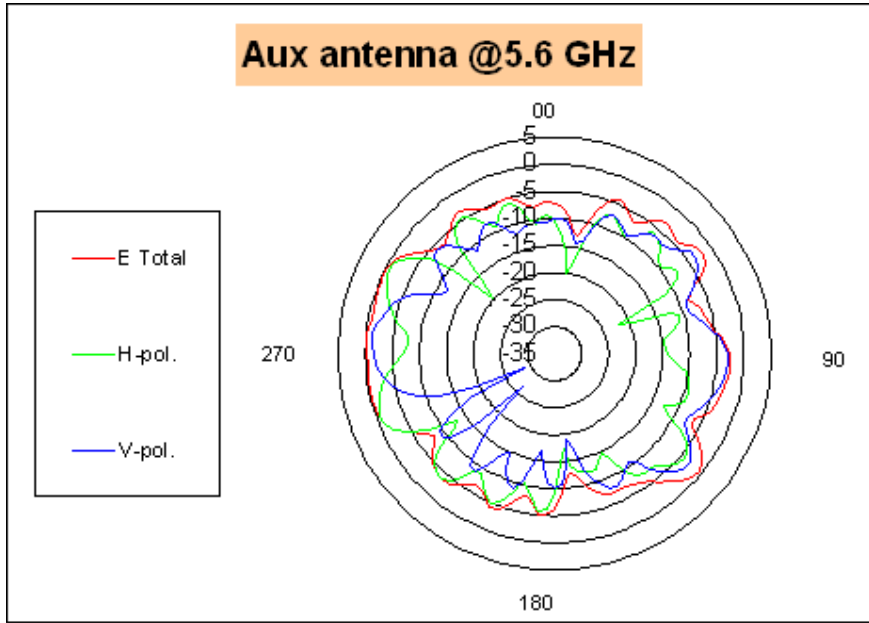

	H-pol	V pol
Peak Gain	-0.61	-1.01

Auxiliary antenna: 5725 MHz

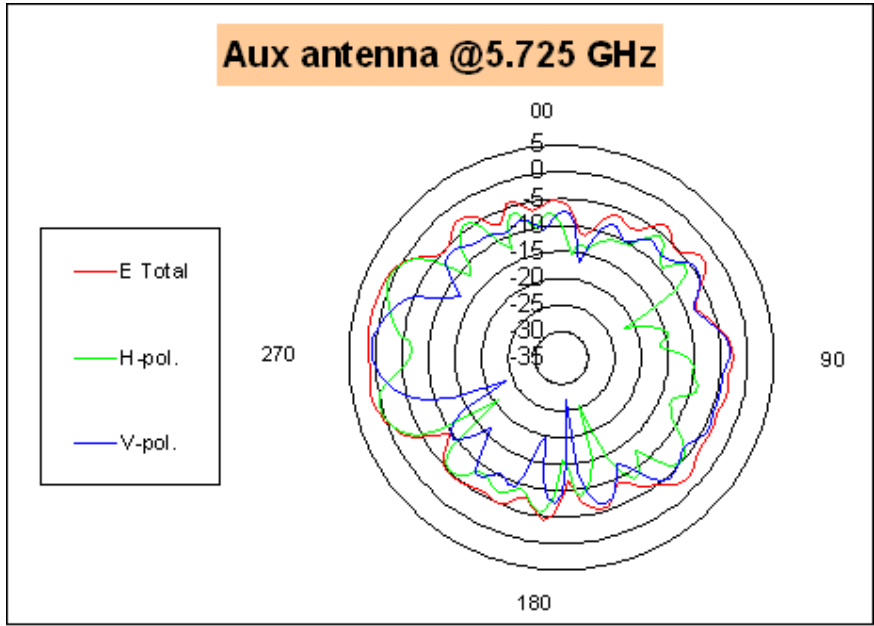

	H-pol	V pol
Peak Gain	0.67	0.73

5785-5850MHz radiation characteristic

Main antenna: 5785 MHz

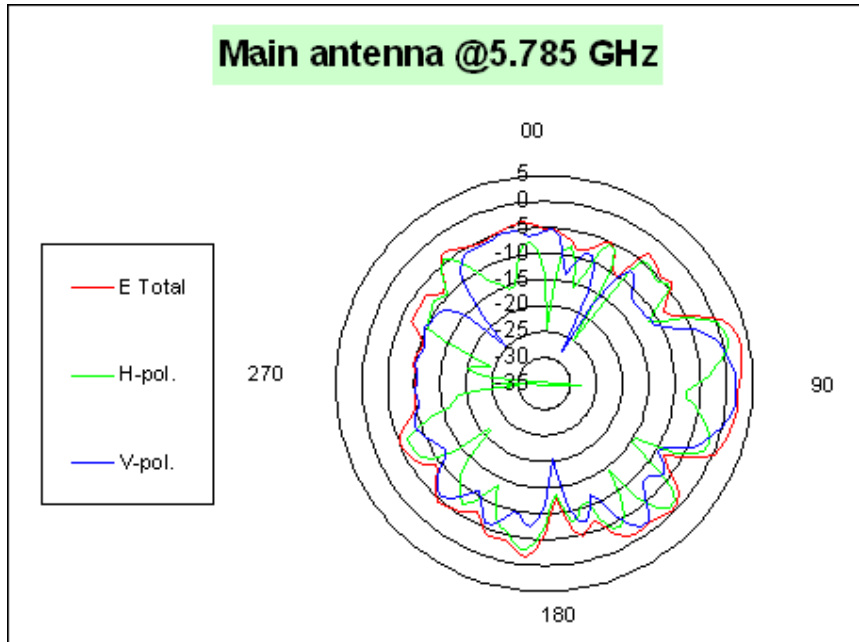

	H-pol	V pol
Peak Gain	1.13	1.82

Main antenna: 5850 MHz

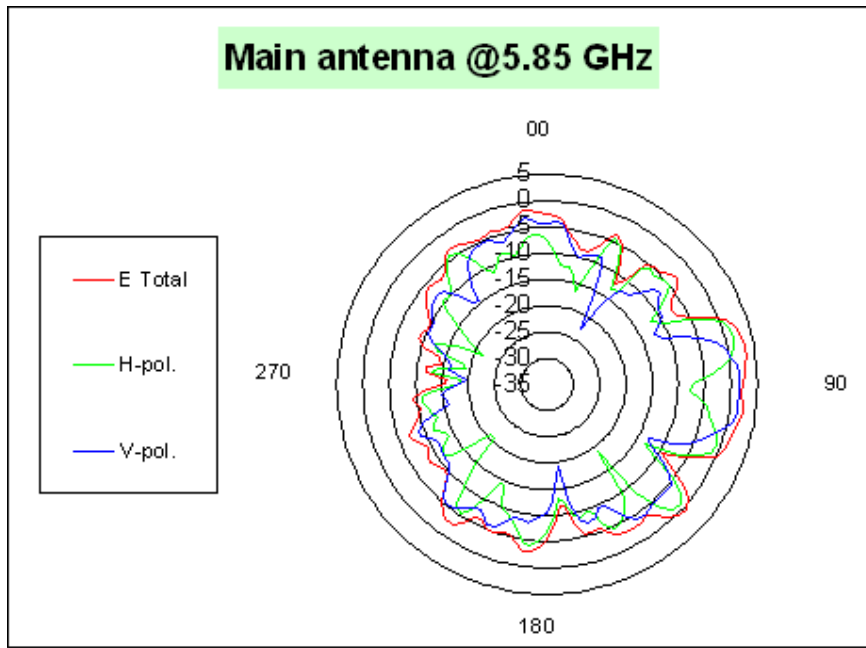

	H-pol	V pol
Peak Gain	1.58	1.60

Auxiliary antenna: 5785 MHz

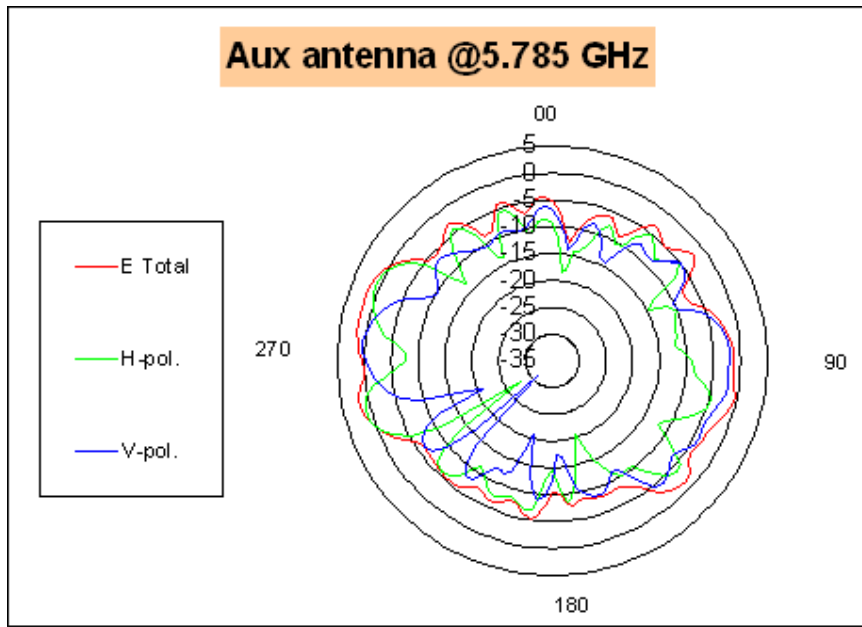

	H-pol	V pol
Peak Gain	0.87	0.47

Auxiliary antenna: 5850 MHz

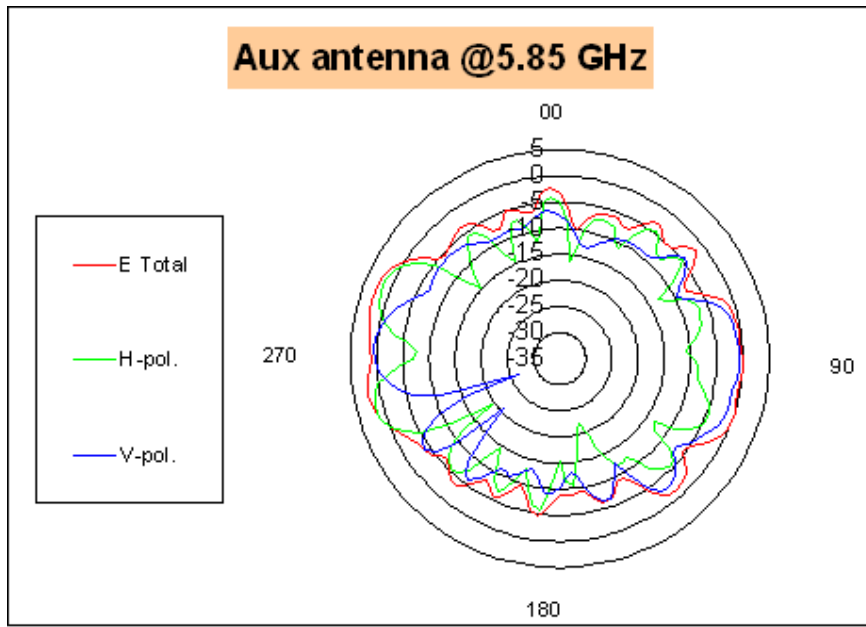

	H-pol	V pol
Peak Gain	1.59	0.56

Section 4. Host Platform Information

OEM / ODM Host platform: (XXXXXXX) platform correlated to antenna data
Rating Label Photo:

Section 5. Antenna Host Platform Location Information

Include a **dimensioned photo or dimensioned drawing** of Tx1, Tx2 and Tx3 antenna placements. (Not applicable for receive-only antenna e.g. Rx3 for 4965AGN)

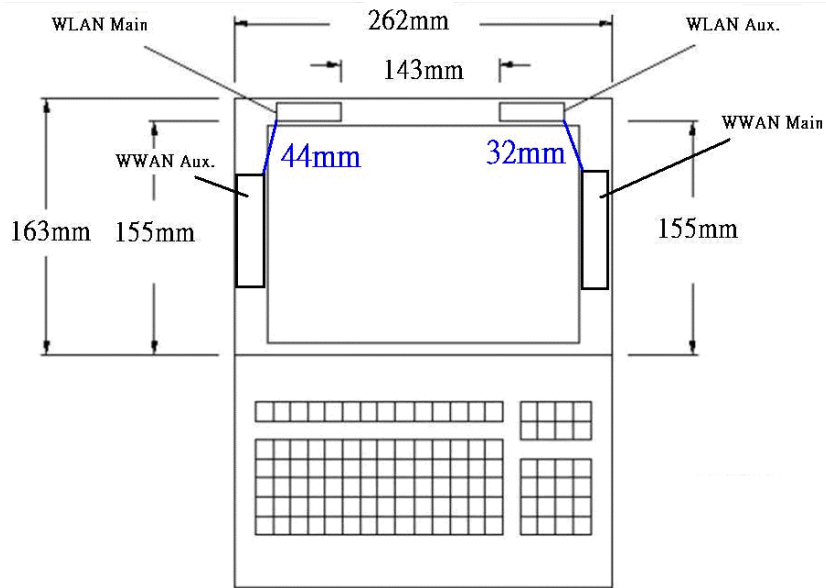

Section 6. Antenna dimensional information for SAR evaluation

Include a **dimensioned photo or dimensioned drawing** showing the distance (mm) between the transmit antennas and the user (excluding hands, wrist, feet, lap/ thigh, and ankle)

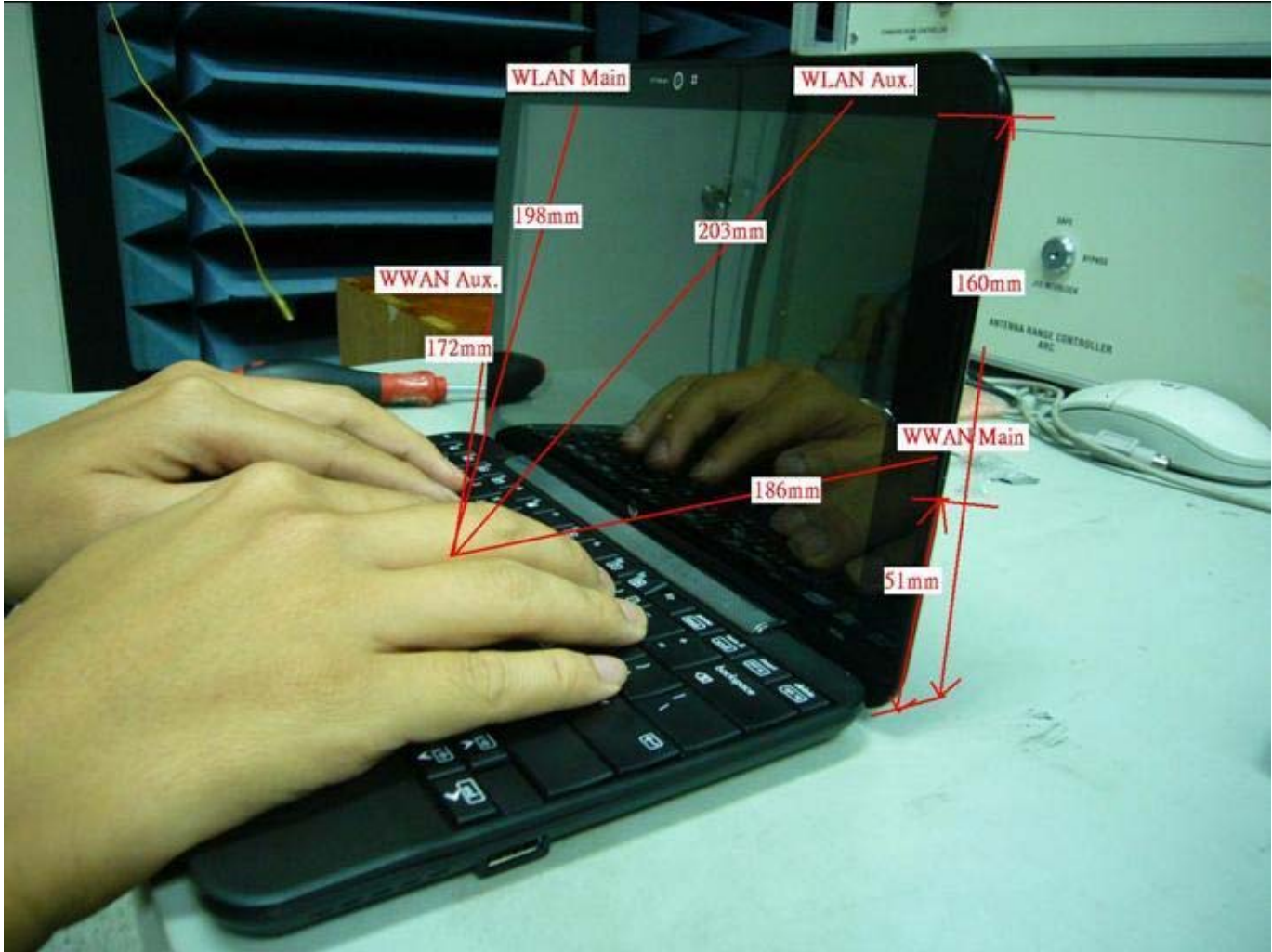

Section 7. Diagram Example of Co-Location Antenna Separation

Include a **dimensioned photo or dimensioned drawing** showing the distance (mm) between **all WLAN transmit antennas** and other co-located radiator transmit antenna such as Bluetooth, WWAN,..

(Note: Due to the evolving rules regarding co-location, each platform will need to be reviewed on a case by case basis)

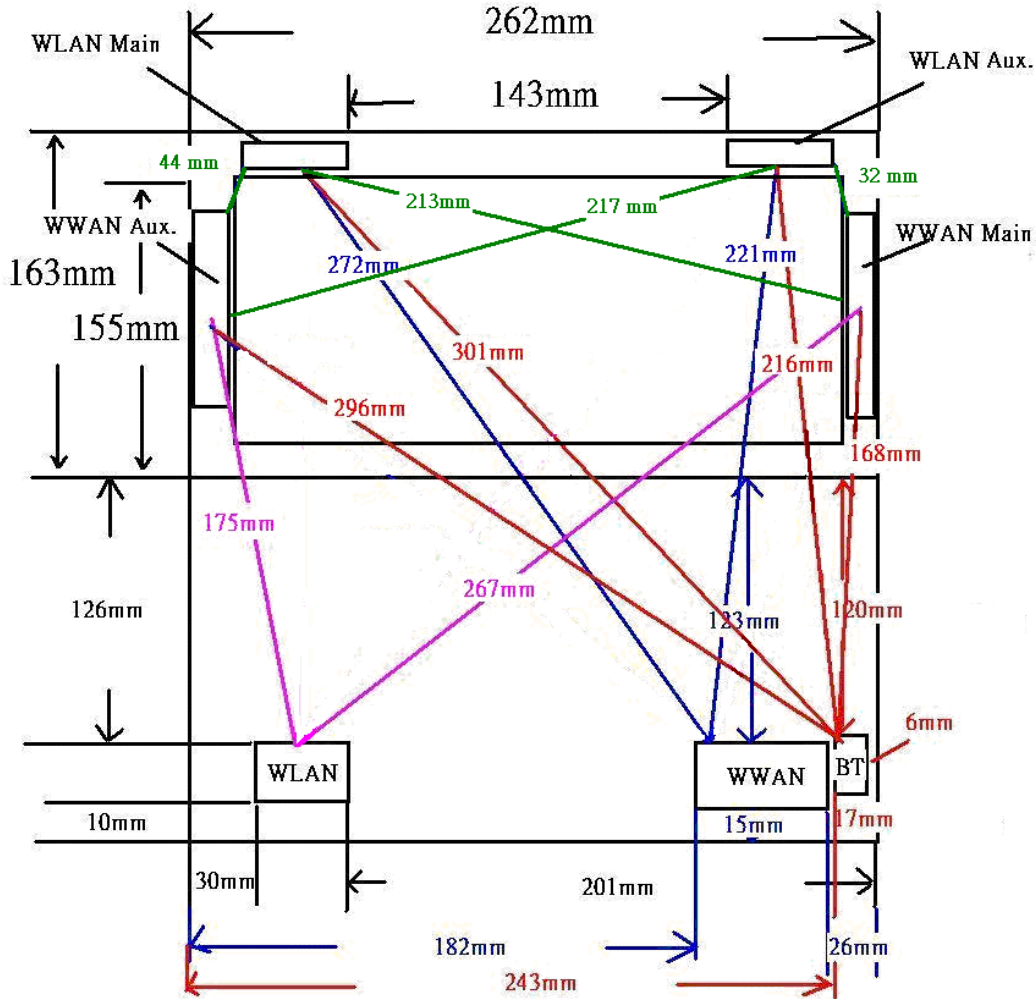

Section 8. Local representative contact information

Local representative contact information is required for regulatory support for target countries below.

	Local company name	Contact name	Phone number	FAX Number	e-Mail Address	Notes
Argentina						
Brazil						
Indonesia						
Israel						
Malaysia						
Mexico						
Singapore						Telecommunication Equipment Dealer License Required
South Africa						
USA, Canada						