



**IMMERSIBLE SAR PROBE**

**CALIBRATION REPORT**

**Part Number: IXP – 050**

**S/N 0116**

**October 2006**

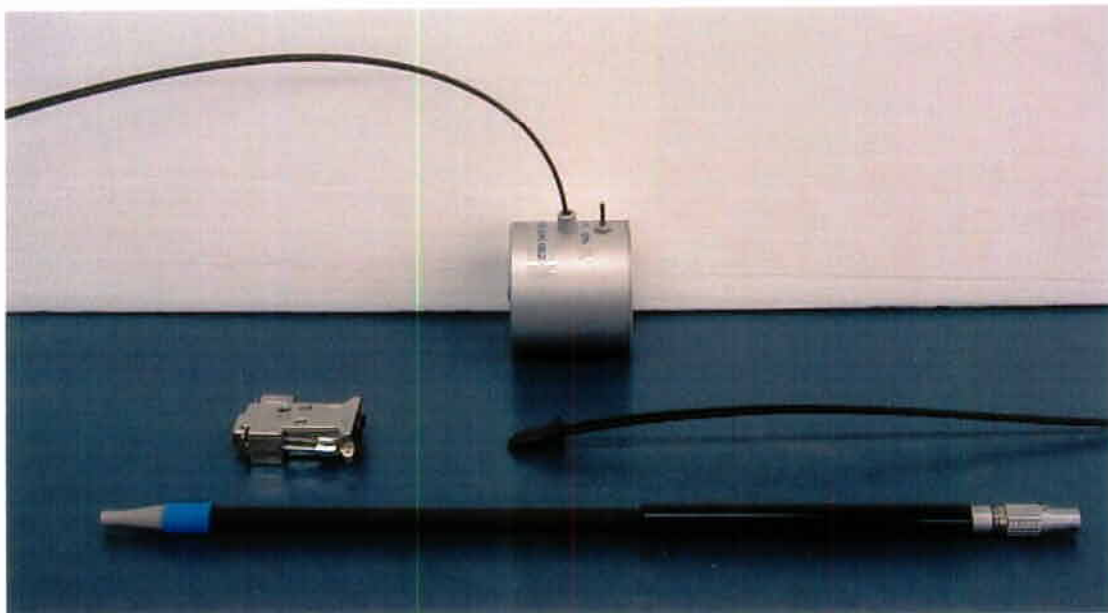

**Indexsar Limited  
Oakfield House  
Cudworth Lane  
Newdigate  
Surrey RH5 5BG**

**Tel: +44 (0) 1306 632 870**

**Fax: +44 (0) 1306 631 834**

**e-mail: [enquiries@indexsar.com](mailto:enquiries@indexsar.com)**



**Indexsar Limited**  
**Oakfield House**  
**Cudworth Lane**  
**Newdigate**  
**Surrey RH5 5BG**  
Tel: +44 (0) 1306 632 870  
Fax: +44 (0) 1306 631 834  
e-mail: [enquiries@indexsar.com](mailto:enquiries@indexsar.com)

**Calibration Certificate 0610/0116**  
**Dosimetric E-field Probe**

Type: **IXP-050**

Manufacturer: **IndexSAR, UK**

Serial Number: **0116**

Place of Calibration: **IndexSAR, UK**

**IndexSAR Limited hereby declares that the IXP-050 Probe named above has been calibrated for conformity to the IEEE 1528 and CENELEC EN 50361 standards on the date shown below.**

Date of Initial Calibration: **20<sup>th</sup> October 2006**

**The probe named above will require a calibration check on the date shown below.**

Next Calibration Date: **October 2007**

**The calibration was carried out using the methods described in the calibration document.**

**Where applicable, the standards used in the calibration process are traceable to the UK's National Physical Laboratory.**

Calibrated By: **A. Brinklow**

Approved By: **M.J. Mann**

*Please keep this certificate with the calibration document. When the probe is sent for a calibration check, please include the calibration document.*

## INTRODUCTION

This Report presents measured calibration data for a particular Indexsar SAR probe (S/N 0116) and describes the procedures used for characterisation and calibration.

Indexsar probes are characterised using procedures that, where applicable, follow the recommendations of CENELEC [1] and IEEE [2] standards. The procedures incorporate techniques for probe linearisation, isotropy assessment and determination of liquid factors (conversion factors). Calibrations are determined by comparing probe readings with analytical computations in canonical test geometries (waveguides) using normalised power inputs.

Each step of the calibration procedure and the equipment used is described in the sections below.

## CALIBRATION PROCEDURE

### 1. Objectives

The calibration process comprises four stages

- 1) Determination of the channel sensitivity factors which optimise the probe's overall rotational isotropy in 900MHz brain fluid
- 2) Determination of the channel sensitivity factors and angular offset of the X channel which together optimise the probe's spherical isotropy in 900MHz brain fluid
- 3) Numerical averaging of the two sets of channel sensitivity factors to give both acceptable rotational isotropy and acceptable spherical isotropy values
- 4) At each frequency of interest, application of these channel sensitivity factors to model the exponential decay of SAR in a waveguide fluid cell, and hence derive the liquid conversion factors at that frequency

### 2. Probe output

The probe channel output signals are linearised in the manner set out in Refs [1] and [2]. The following equation is utilized for each channel:

$$U_{lin} = U_{o/p} + U_{o/p}^2 / DCP \quad (1)$$

where  $U_{lin}$  is the linearised signal,  $U_{o/p}$  is the raw output signal in voltage units and DCP is the diode compression potential in similar voltage units.

DCP is determined from fitting equation (1) to measurements of  $U_{lin}$  versus source feed power over the full dynamic range of the probe. The DCP is a characteristic of the Schottky diodes used as the sensors. For the IXP-050 probes with CW signals the DCP values are typically 0.10V (or 20 in the voltage units used by Indexsar software, which are  $V*200$ ).

In turn, measurements of E-field are determined using the following equation (where output voltages are also in units of V\*200):

$$E_{liq}^2 \text{ (V/m)} = U_{linx} * \text{Air Factor}_x * \text{Liq Factor}_x + U_{liny} * \text{Air Factor}_y * \text{Liq Factor}_y + U_{linz} * \text{Air Factor}_z * \text{Liq Factor}_z \quad (3)$$

Here, “Air Factor” represents each channel’s sensitivity, while “Liq Factor” represents the enhancement in signal level when the probe is immersed in tissue-simulant liquids at each frequency of interest.

### 3. Selecting channel sensitivity factors to optimise isotropic response

After manufacture, the first stage of the calibration process is to balance the three channels’ Air Factor values, thereby optimising the probe’s overall axial response (“rotational isotropy”).

To do this, a 900MHz waveguide containing head-fluid simulant is selected. Like all waveguides used during probe calibration, this particular waveguide contains two distinct sections: an air-filled launcher section, and a liquid cell section, separated by a dielectric matching window designed to minimise reflections at the air-liquid interface.

The waveguide stands in an upright position and the liquid cell section is filled with 900MHz brain fluid to within 10 mm of the open end. The depth of liquid ensures there is negligible radiation from the waveguide open top and that the probe calibration is not influenced by reflections from nearby objects.

During the measurement, a TE<sub>01</sub> mode is launched into the waveguide by means of an N-type-to-waveguide adapter. The probe is then lowered vertically into the liquid until the tip is exactly 10mm above the centre of the dielectric window. This particular separation ensures that the probe is operating in a part of the waveguide where boundary corrections are not necessary.

Care must also be taken that the probe tip is centred while rotating.

The exact power applied to the input of the waveguide during this stage of the probe calibration is immaterial since only relative values are of interest while the probe rotates. However, the power must be sufficiently above the noise floor and free from drift.

The dedicated Indexsar calibration software rotates the probe in 10 degree steps about its axis, and at each position, an Indexsar ‘Fast’ amplifier samples the probe channels 500 times per second for 0.4 s. The raw U<sub>o/p</sub> data from each sample are packed into 10 bytes and transmitted back to the PC controller via an optical cable. U<sub>linx</sub>, U<sub>liny</sub> and U<sub>linz</sub> are derived from the raw U<sub>o/p</sub> values and written to an Excel template.

Once data have been collected from a full probe rotation, the Air Factors are adjusted using a special Excel Solver routine to equalise the output from each

channel and hence minimise the rotational isotropy. This automated approach to optimisation removes the effect of human bias.

Figure 5 represents the output from each diode sensor as a function of probe rotation angle. The directionality of the orthogonally-arranged sensors can be checked by analysing the data using dedicated Indexsar software, which displays the data in 3D format, a representative image of which is shown in Figure 3. The left-hand side of this diagram shows the individual channel outputs after linearisation (see above). The program uses these data to balance the channel outputs and then applies an optimisation process, which makes fine adjustments to the channel factors for optimum isotropic response.

#### 4. Determination of Conversion ("Liquid") Factors at each frequency of interest

A lookup table of conversion factors for a probe allows a SAR value to be derived at the measured frequencies, and for either brain or body fluid-simulant.

The method by which the conversion factors are assessed is based on the comparison between measured and analytical rates of decay of SAR with height above a dielectric window. This way, not only can the conversion factors for that frequency/fluid combination be determined, but an allowance can also be made for the scale and range of boundary layer effects.

The theoretical relationship between the SAR at the cross-sectional centre of the lossy waveguide as a function of the longitudinal distance ( $z$ ) from the dielectric separator is given by Equation 4:

$$SAR(z) = \frac{4(P_f - P_b)}{\rho ab \delta} e^{-2z/\delta} \quad (4)$$

Here, the density  $\rho$  is conventionally assumed to be  $1000 \text{ kg/m}^3$ ,  $ab$  is the cross-sectional area of the waveguide, and  $P_f$  and  $P_b$  are the forward and reflected power inside the lossless section of the waveguide, respectively. The penetration depth  $\delta$  (which is the reciprocal of the waveguide-mode attenuation coefficient) is a property of the lossy liquid and is given by Equation (5).

$$\delta = \left[ \text{Re} \left\{ \sqrt{(\pi/a)^2 + j\omega\mu_o(\sigma + j\omega\epsilon_o\epsilon_r)} \right\} \right]^{-1} \quad (5)$$

where  $\sigma$  is the conductivity of the tissue-simulant liquid in S/m,  $\epsilon_r$  is its relative permittivity, and  $\omega$  is the radial frequency (rad/s). Values for  $\sigma$  and  $\epsilon_r$  are obtained prior to each waveguide test using an Indexsar DiLine measurement kit, which uses the TEM method as recommended in [2].  $\sigma$  and  $\epsilon_r$  are both temperature- and fluid-dependent, so are best measured using a sample of the tissue-simulant fluid immediately prior to the actual calibration.

Wherever possible, all DiLine and calibration measurements should be made in the open laboratory at  $22 \pm 2.0^\circ\text{C}$ ; if this is not possible, the values of  $\sigma$  and  $\epsilon_r$  should reflect the actual temperature. Values employed for calibration are listed in the tables below.

By ensuring the liquid height in the waveguide is at least three penetration depths, reflections at the upper surface of the liquid are negligible. The power absorbed in the liquid is therefore determined solely from the waveguide forward and reflected power.

Different waveguides are used for 835/900MHz, 1800/1900MHz, 2450MHz and 5200/5800MHz measurements. Table A.1 of [1] can be used for designing calibration waveguides with a return loss greater than 20 dB at the most important frequencies used for personal wireless communications, and better than 15dB for frequencies greater than 5GHz. Values for the penetration depth for these specific fixtures and tissue-simulating mixtures are also listed in Table A.1.

According to [1], this calibration technique provides excellent accuracy, with standard uncertainty of less than 3.6% depending on the frequency and medium. The calibration itself is reduced to power measurements traceable to a standard calibration procedure. The practical limitation to the frequency band of 800 to 5800 MHz because of the waveguide size is not severe in the context of compliance testing.

During calibration, the probe is lowered carefully until it is just touching the cross-sectional centre of the dielectric window. 200 samples are then taken and written to an Excel template file before moving the probe vertically upwards. This cycle is repeated 50 times. The vertical separation between readings is determined from practical considerations of the expected SAR decay rate, and range from 1mm steps at low frequency, through 0.5mm at 2450MHz, down to 0.2mm at 5GHz.

Once the data collection is complete, a Solver routine is run which optimises the measured-theoretical fit by varying the conversion factor, and the boundary correction size and range.

#### 5. Measurement of Spherical Isotropy

The setup for measuring the probe's spherical isotropy is shown in Figure 2.

A box phantom containing 900MHz head fluid is irradiated by a vertically-polarised, tuned dipole, mounted to the side of the phantom on the robot's seventh axis. During calibration, the spherical response is generated by rotating the probe about its axis in 20 degree steps and changing the dipole polarisation in 10 degree steps.

By using the VPM technique discussed below, an allowance can also be made for the effect of E-field gradient across the probe's spatial extent. This permits values for the probe's effective tip radius and X-channel angular offset to be modelled until the overall spherical isotropy figure is optimised.

The dipole is connected to a signal generator and amplifier via a directional coupler and power meter. As with the determination of rotational isotropy, the absolute power level is not important as long as it is stable.

The probe is positioned within the fluid so that its sensors are at the same vertical height as the centre of the source dipole. The line joining probe to dipole should be perpendicular to the phantom wall, while the horizontal separation between the two should be small enough for VPM corrections to be applicable, without encroaching near the boundary layer of the phantom wall. VPM corrections require a knowledge of the fluid skin depth. This is measured during the calibration by recording the E-field strength while systematically moving the probe away from the dipole in 2mm steps over a 20mm range.

#### **VPM (Virtual Probe Miniaturisation)**

SAR probes with 3 diode-sensors in an orthogonal arrangement are designed to display an isotropic response when exposed to a uniform field. However, the probes are ordinarily used for measurements in non-uniform fields and isotropy is not assured when the field gradients are significant compared to the dimensions of the tip containing the three orthogonally-arranged dipole sensors.

It becomes increasingly important to assess the effects of field gradients on SAR probe readings when higher frequencies are being used. For Indexsar IXP-050 probes, which are of 5mm tip diameter, field gradient effects are minor at GSM frequencies, but are major above 5GHz. Smaller probes are less affected by field gradients and so probes, which are significantly less than 5mm diameter, would be better for applications above 5GHz.

The IndexSAR report IXS0223 describes theoretical and experimental studies to evaluate the issues associated with the use of probes at arbitrary angles to surfaces and field directions. Based upon these studies, the procedures and uncertainty analyses referred to in P1528 are addressed for the full range of probe presentation angles.

In addition, generalized procedures for correcting for the finite size of immersible SAR probes are developed. Use of these procedures enables application of schemes for virtual probe miniaturization (VPM) – allowing probes of a specific size to be used where physically-smaller probes would otherwise be required.

Given the typical dimensions of 3-channel SAR probes presently available, use of the VPM technique extends the satisfactory measurement range to higher frequencies.

#### **CALIBRATION FACTORS MEASURED FOR PROBE S/N 0116**

The probe was calibrated at 835, 900, 1800, 1900 and 2450 MHz in liquid samples representing brain and body liquid at these frequencies. The calibration was for CW signals only, and the axis of the probe was parallel to the direction of propagation of the incident field i.e. end-on to the incident radiation. The axial isotropy of the probe was measured by rotating the probe about its axis in 10 degree steps through 360 degrees in this orientation.

The reference point for the calibration is in the centre of the probe's cross-section at a distance of 2.7 mm from the probe tip in the direction of the probe amplifier. A value of 2.7 mm should be used for the tip to sensor offset distance in the software. The distance of 2.7mm for assembled probes has been confirmed by taking X-ray images of the probe tips (see Figure 8).

It is important that the diode compression point and air factors used in the software are the same as those quoted in the results tables, as these are used to convert the diode output voltages to a SAR value.



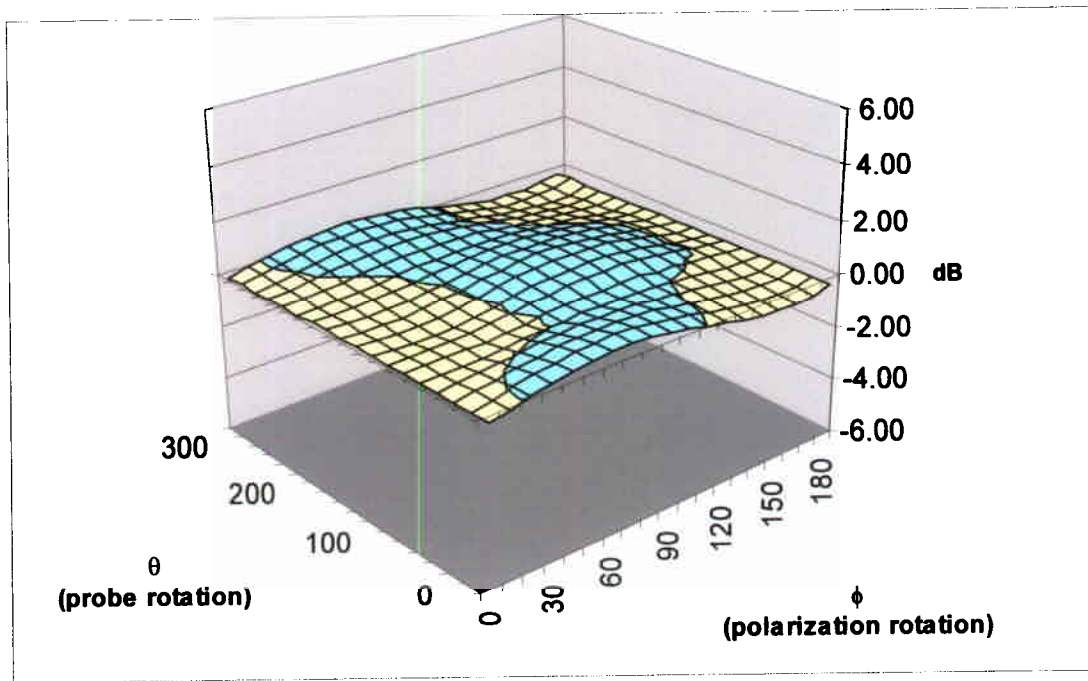

**Surface Isotropy diagram of IXP-050 Probe S/N 0116 at 900MHz after VPM (rotational isotropy axial +/-0.12dB, spherical isotropy +/-0.48dB)**

Probe tip radius 1.25  
 X Ch. Angle to red dot -2.5

| Frequency | Head              |                    | Body              |                    |
|-----------|-------------------|--------------------|-------------------|--------------------|
|           | Bdy. Corm. - f(0) | Bdy. Corm. - d(mm) | Bdy. Corm. - f(0) | Bdy. Corm. - d(mm) |
| 835       | 1.38              | 1.2                | 1.51              | 1.2                |
| 900       | 1.21              | 1.3                | 1.43              | 1.2                |
| 1800      | 1.21              | 1.2                | 1.23              | 1.3                |
| 1900      | 1.13              | 1.3                | 0.94              | 1.5                |
| 2450      | 1.30              | 1.2                | 0.87              | 1.6                |

## SUMMARY OF CALIBRATION FACTORS FOR PROBE IXP-050 S/N 0116

|                                       |      |          |
|---------------------------------------|------|----------|
| Spherical isotropy measured at 900MHz | 0.48 | (+/-) dB |
|---------------------------------------|------|----------|

|             | X   | Y   | Z   |         |
|-------------|-----|-----|-----|---------|
| Air Factors | 488 | 373 | 340 | (V*200) |
| CW DCPs     | 20  | 20  | 20  | (V*200) |

| Freq (MHz) | Axial Isotropy<br>(+/- dB) |      | SAR ConvF<br>(liq/air) |       | Notes |
|------------|----------------------------|------|------------------------|-------|-------|
|            | Head                       | Body | Head                   | Body  |       |
|            | 835                        | -    | -                      | 0.474 |       |
| 900        | 0.12                       | -    | 0.478                  | 0.475 | 1,2   |
| 1800       | -                          | -    | 0.559                  | 0.603 | 1,2   |
| 1900       | -                          | -    | 0.565                  | 0.630 | 1,2   |
| 2450       | -                          | -    | 0.613                  | 0.692 | 1,2   |

| Notes |                                  |
|-------|----------------------------------|
| 1)    | Calibrations done at 22°C +/-2°C |
| 2)    | Waveguide calibration            |

## PROBE SPECIFICATIONS

Indexsar probe 0116, along with its calibration, is compared with CENELEC and IEEE standards recommendations (Refs [1] and [2]) in the Tables below. A listing of relevant specifications is contained in the tables below:

| <b>Dimensions</b>                              | <b>S/N 0116</b> | <b>CENELEC [1]</b> | <b>IEEE [2]</b> |
|--|-----------------|--------------------|-----------------|
| Overall length (mm)                            | 350             |                    |                 |
| Tip length (mm)                                | 10              |                    |                 |
| Body diameter (mm)                             | 12              |                    |                 |
| Tip diameter (mm)                              | 5.2             | 8                  | 8               |
| Distance from probe tip to dipole centers (mm) | 2.7             |                    |                 |

| <b>Dynamic range</b>  | <b>S/N 0116</b> | <b>CENELEC [1]</b> | <b>IEEE [2]</b> |
|---|-----------------|--------------------|-----------------|
| Minimum (W/kg)  | 0.01            | <0.02              | 0.01            |
| Maximum (W/kg)<br>N.B. only measured to > 100 W/kg on representative probes | >100            | >100               | 100             |

| <b>Isotropy (measured at 900MHz)</b>                            | <b>S/N 0116</b>           | <b>CENELEC [1]</b> | <b>IEEE [2]</b> |
|---|---------------------------|--------------------|-----------------|
| Axial rotation with probe normal to source (+/- dB)             | 0.12<br>(See table above) | 0.5                | 0.25            |
| Spherical isotropy covering all orientations to source (+/- dB) | 0.48                      | 1.0                | 0.50            |

|                            |  |
|----------------------------|--|
| <b>Construction</b>        | Each probe contains three orthogonal dipole sensors arranged on a triangular prism core, protected against static charges by built-in shielding, and covered at the tip by PEEK cylindrical enclosure material. No adhesives are used in the immersed section. Outer case materials are PEEK and heat-shrink sleeving. |
| <b>Chemical resistance</b> | Tested to be resistant to glycol and alcohol containing simulant liquids but probes should be removed, cleaned and dried when not in use.  |

## **REFERENCES**

[1] CENELEC, EN 50361, July 2001. Basic Standard for the measurement of specific absorption rate related to human exposure to electromagnetic fields from mobile phones.

[2] IEEE 1528, Recommended practice for determining the spatial-peak specific absorption rate (SAR) in the human body due to wireless communications devices: Experimental techniques.

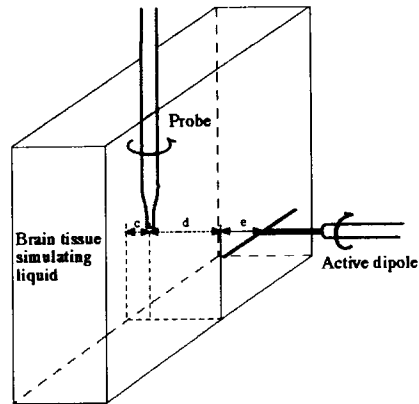
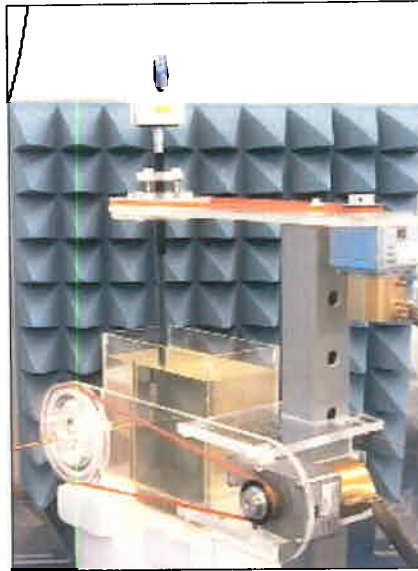

Figure 1. Spherical isotropy jig showing probe, dipole and box filled with simulated brain liquid (see Ref [2], Section A.5.2.1)

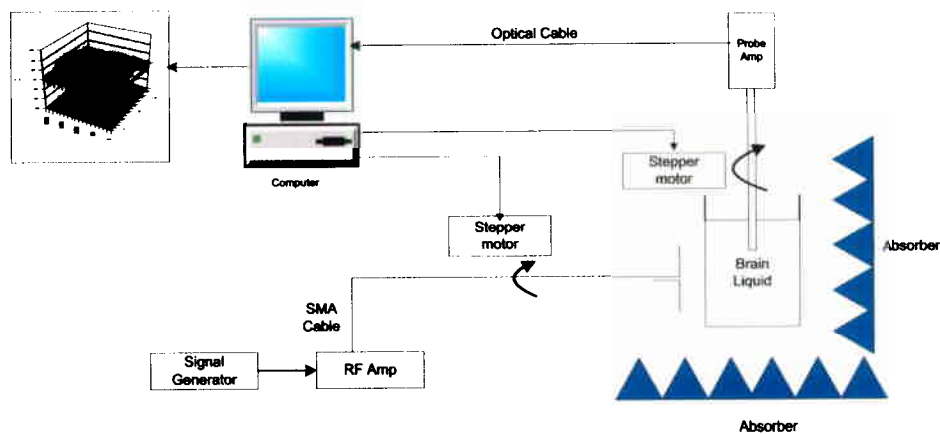

Figure 2. Schematic diagram of the test geometry used for isotropy determination

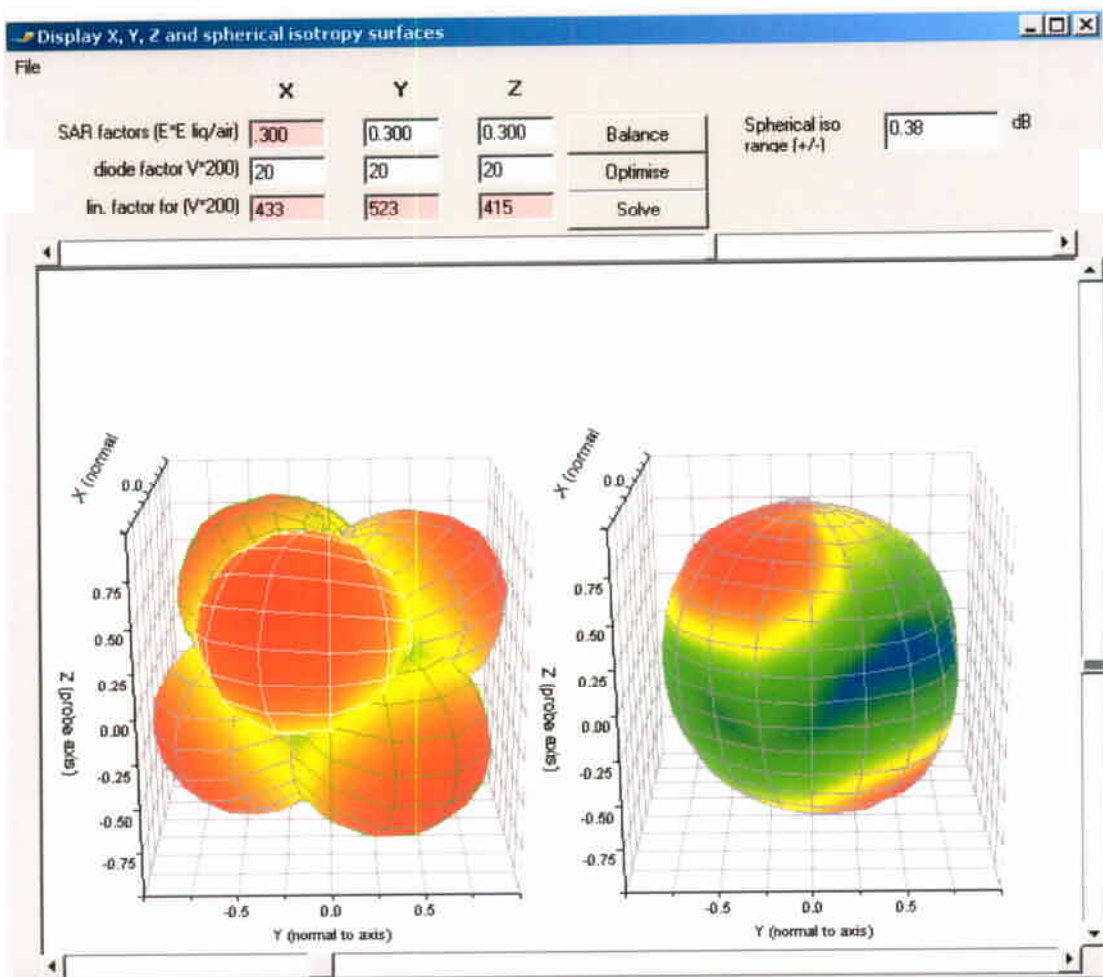

Figure 3. Graphical representation of a probe's response to fields applied from each direction. The diagram on the left shows the individual response characteristics of each of the three channels and the diagram on the right shows the resulting probe sensitivity in each direction. The colour range in the figure images the lowest values as blue and the maximum values as red. For the probe S/N 0116, this range is (+/-) 0.48dB.

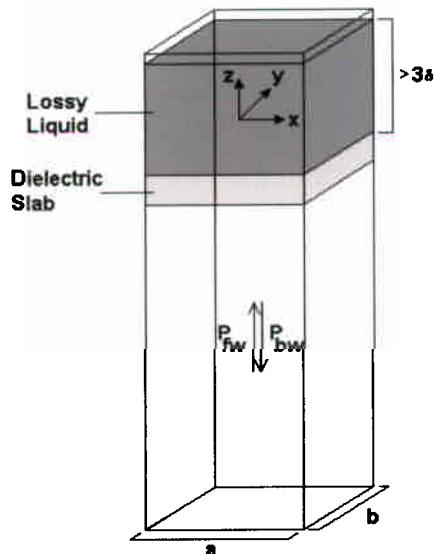

Figure 4. Geometry used for waveguide calibration (after Ref [2]. Section A.3.2.2)

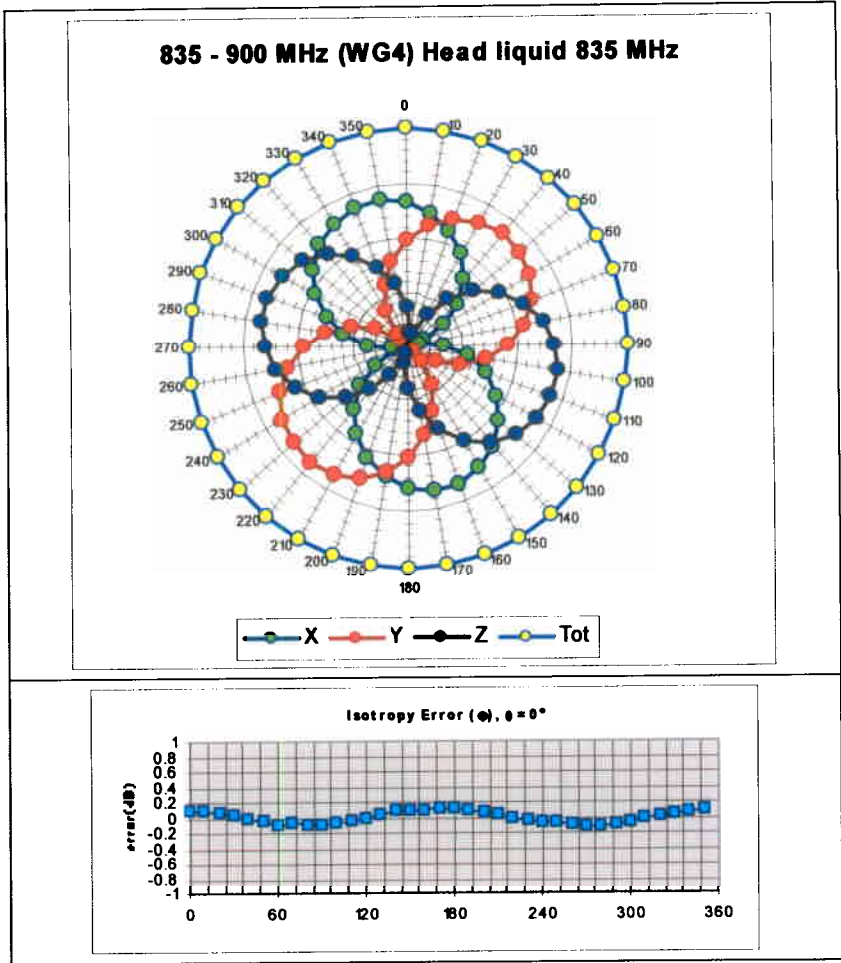

Figure 5. The rotational isotropy of probe S/N 0116 obtained by rotating the probe in a liquid-filled waveguide at 900 MHz.

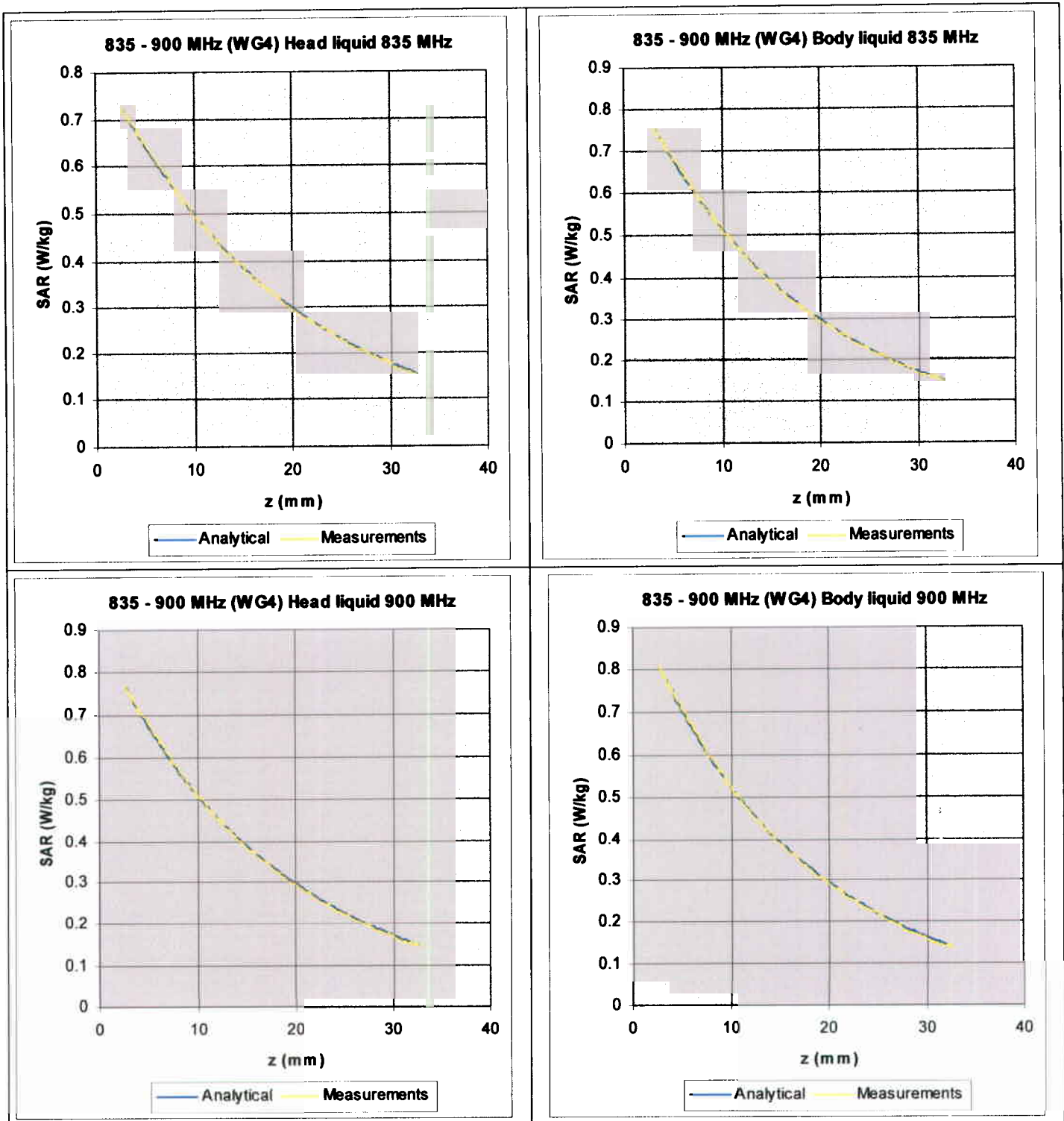
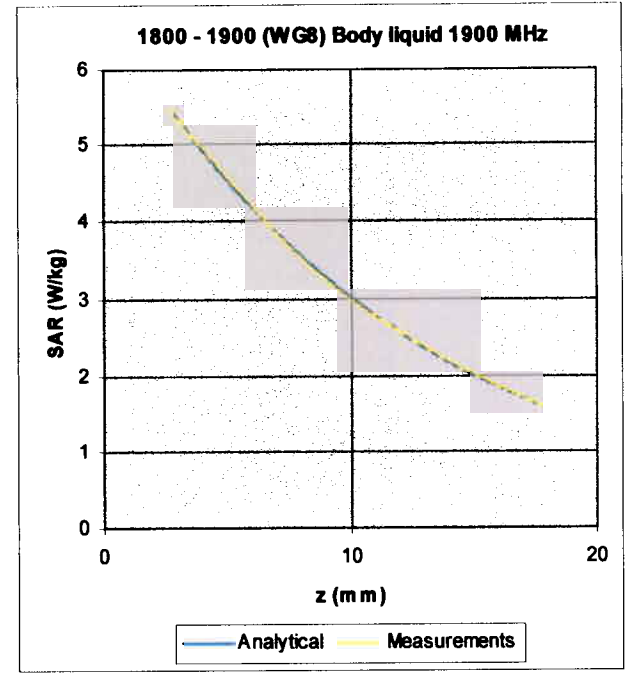
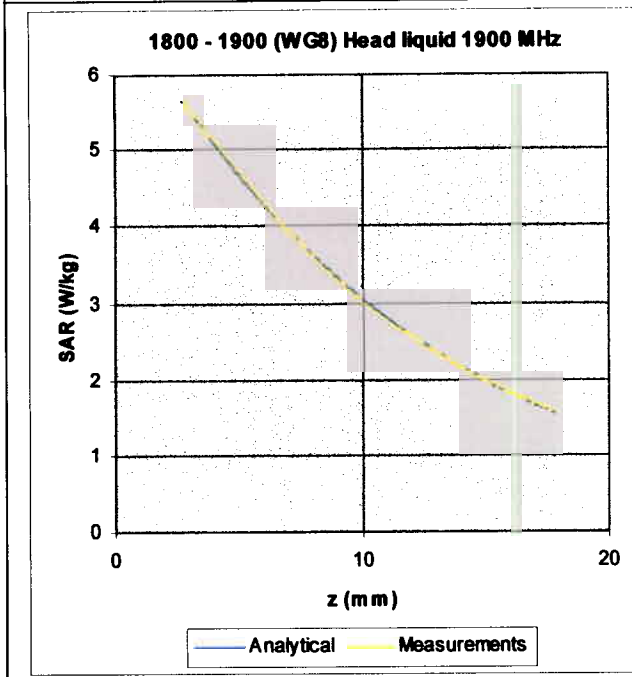
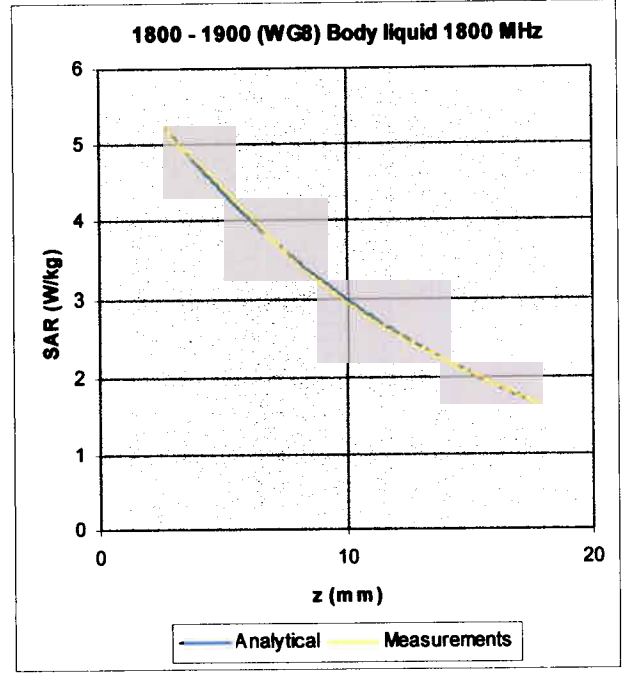
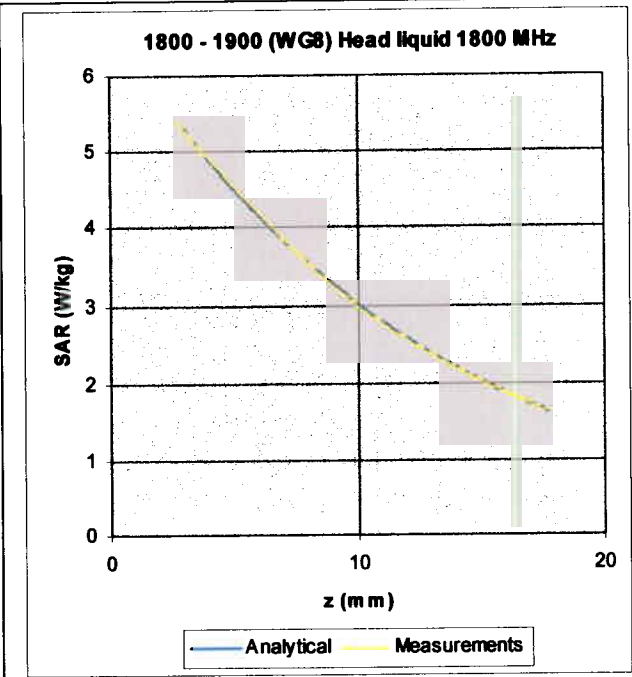
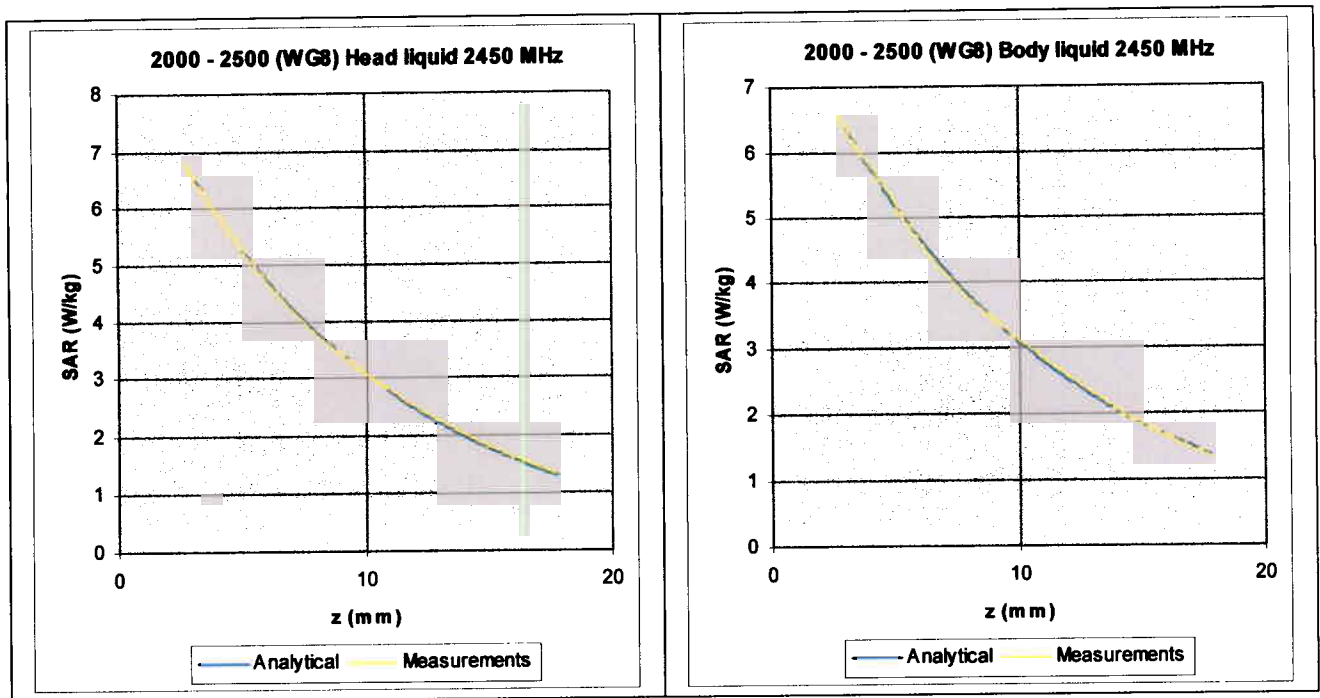

Figure 6. The measured SAR decay function along the centreline of the WG4 waveguide with conversion factors adjusted to fit to the theoretical function for the particular dimension, frequency, power and liquid properties employed.







*Figure 7. The measured SAR decay function along the centreline of the R22 waveguide with conversion factors adjusted to fit to the theoretical function for the particular dimension, frequency, power and liquid properties employed.*

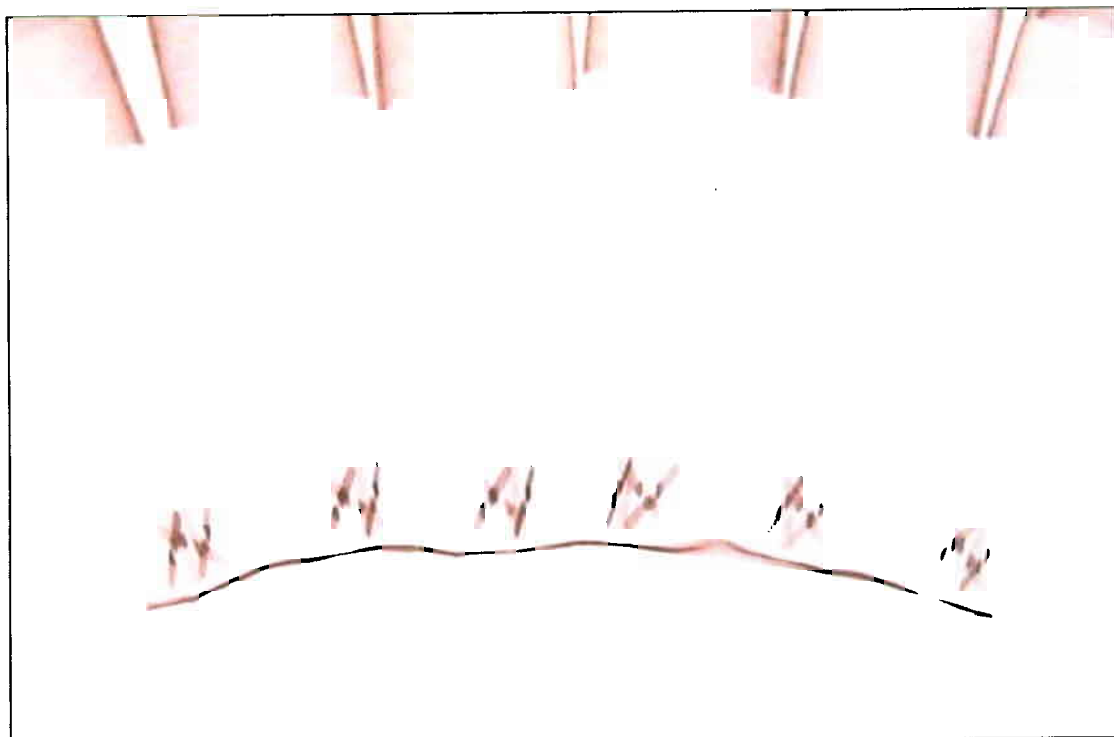

*Figure 8: X-ray positive image of 5mm probes*

**Table indicating the dielectric parameters of the liquids used for calibrations at each frequency**

| <b>Liquid used</b> | <b>Relative permittivity<br/>(measured)</b> | <b>Conductivity (S/m)<br/>(measured)</b> |
|--------------------|---|--|
| 835 MHz BRAIN      | 42.82                                       | 0.92                                     |
| 835 MHz BODY       | 49.17                                       | 1.06                                     |
| 900 MHz BRAIN      | 41.98                                       | 0.98                                     |
| 900 MHz BODY       | 48.40                                       | 1.12                                     |
| 1800 MHz BRAIN     | 38.95                                       | 1.35                                     |
| 1800 MHz BODY      | 53.98                                       | 1.51                                     |
| 1900 MHz BRAIN     | 38.55                                       | 1.44                                     |
| 1900 MHz BODY      | 53.70                                       | 1.61                                     |
| 2450 MHz BRAIN     | 39.04                                       | 1.85                                     |
| 2450 MHz BODY      | 53.58                                       | 2.05                                     |