

Notebook Tour

User Guide

© Copyright 2007 Hewlett-Packard
Development Company, L.P.

Windows is a U.S. registered trademark of
Microsoft Corporation. Bluetooth is a
trademark owned by its proprietor and used
by Hewlett-Packard Company under license.
SD Logo is a trademark of its proprietor.

The information contained herein is subject
to change without notice. The only
warranties for HP products and services are
set forth in the express warranty statements
accompanying such products and services.
Nothing herein should be construed as
constituting an additional warranty. HP shall
not be liable for technical or editorial errors
or omissions contained herein.

First Edition: March 2007

Document Part Number: 435751-001

Product notice

This user guide describes features that are common to most models. Some features may not be available on your computer.

Table of contents

1 Identifying Hardware

2 Components

Top components	3
TouchPad	3
Lights	4
Buttons, switches, and fingerprint reader	7
Keys	9
Front components	10
Rear components	11
Right-side components	12
Left-side components	13
Bottom components	14
Wireless antennae (select models only)	15
Additional hardware components	16

3 Labels

Index	18
-------------	----

1 Identifying Hardware

To see a list of hardware installed in the computer, follow these steps:

1. Select **Start > My Computer**.
2. In the left pane of the System Tasks window, select **View system information**.
3. Select **Hardware** tab > **Device Manager**.

You can also add hardware or modify device configurations using Device Manager.

2 Components

Top components

TouchPad

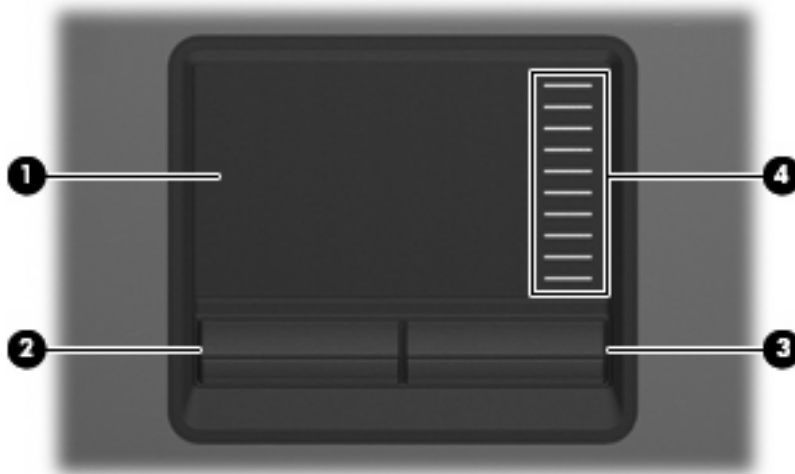

Component	Description
(1) TouchPad*	Moves the pointer and selects or activates items on the screen.
(2) Left TouchPad button*	Functions like the left button on an external mouse.
(3) Right TouchPad button*	Functions like the right button on an external mouse.
(4) TouchPad scroll zone*	Scrolls up or down.

*This table describes factory settings. To view or change pointing device preferences, select **Start > Control Panel > Printers and Other Hardware > Mouse**.

Lights



NOTE: Refer to the illustration that most closely matches your computer.



Component	Description
(1) Power lights (2)*	<ul style="list-style-type: none"> On: The computer is on. Blinking: The computer is in Standby. Blinking rapidly: An AC adapter with a higher power rating should be connected. Off: The computer is off or in Hibernation.
(2) Wireless lights (2)†	<ul style="list-style-type: none"> On: An integrated wireless device, such as a wireless local area network (WLAN) device, the HP Broadband Wireless Module, and/or a Bluetooth® device, is on. Off: All wireless devices are off.
(3) Caps lock light	On: Caps lock is on.
(4) Num lock light	On: Num lock is on or the embedded numeric keypad is enabled.
(5) Volume mute light	<ul style="list-style-type: none"> Off: Computer sound is on. On: Computer sound is off.
(6) Volume down light	Blinking: The volume scroll zone is being used to decrease speaker volume.
(7) Volume up light	Blinking: The volume scroll zone is being used to increase speaker volume.

Component	Description
(8) Battery light	<ul style="list-style-type: none"> • Amber: A battery is charging. • Green: A battery is close to full charge capacity. • Blinking amber: A battery that is the only available power source has reached a low battery level. When the battery reaches a critical battery level, the battery light begins blinking rapidly. • Off: If the computer is plugged into an external power source, the light turns off when all batteries in the computer are fully charged. If the computer is not plugged into an external power source, the light stays off until the battery reaches a low battery level.
(9) Drive light	<ul style="list-style-type: none"> • Blinking green: The hard drive or optical drive is being accessed. • Amber: HP 3D DriveGuard has temporarily parked the internal hard drive.

*The 2 power lights display the same information. The light on the power button is visible only when the computer is open. The power light on the front of the computer is visible whether the computer is open or closed.

†The 2 wireless lights display the same information. The light on the wireless button is visible only when the computer is open. The wireless light on the front of the computer is visible whether the computer is open or closed.



Component	Description
(1) Power lights (2)*	<ul style="list-style-type: none"> • On: The computer is on. • Blinking: The computer is in Standby. • Blinking rapidly: An AC adapter with a higher power rating should be connected. • Off: The computer is off or in Hibernation.
(2) Wireless lights (2)†	<ul style="list-style-type: none"> • On: An integrated wireless device, such as a wireless local area network (WLAN) device, the HP Broadband Wireless Module, and/or Bluetooth device, is on. • Off: All wireless devices are off.
(3) Caps lock light	On: Caps lock is on.
(4) Num lock light	Blinking: Num lock is on or the embedded numeric keypad is enabled.
(5) Battery light	<ul style="list-style-type: none"> • On: A battery is charging. • Green: A battery is close to full charge capacity. • Blinking amber: A battery that is the only available power source has reached a low battery level. When the battery reaches a critical battery level, the battery light begins blinking rapidly. • Off: If the computer is plugged into an external power source, the light turns off when all batteries in the computer are fully charged. If the computer is not plugged into an external power source, the light stays off until the battery reaches a low battery level.
(6) Drive light	Blinking green: The hard drive or optical drive is being accessed.

*The 2 power lights display the same information. The light on the power button is visible only when the computer is open. The power light on the front of the computer is visible whether the computer is open or closed.

†The 2 wireless lights display the same information. The light on the wireless button is visible only when the computer is open. The wireless light on the front of the computer is visible whether the computer is open or closed.

Buttons, switches, and fingerprint reader



NOTE: Refer to the illustration that most closely matches your computer.



Component	Description
(1) Power button	<ul style="list-style-type: none"> When the computer is off, press the button to turn on the computer. When the computer is on, press the button to shut down the computer. When the computer is in Standby, press the button briefly to exit Standby. When the computer is in Hibernation, press the button briefly to exit Hibernation. <p>If the computer has stopped responding and Windows® shutdown procedures are ineffective, press and hold the power button for at least 5 seconds to turn off the computer.</p> <p>To learn more about your power settings, select Start > Control Panel > Performance and Maintenance > Power Options.</p>
(2) Internal display switch	Turns off the display if the display is closed while the power is on.
(3) Info button	Launches Info Center, which enables you to open various software solutions.
(4) Wireless button	Turns the wireless feature on or off, but does not establish a wireless connection.
(5) Presentation button	Starts the presentation feature.
(6) Volume mute button	Mutes and restores speaker sound.



NOTE: A wireless network must be set up in order to establish a wireless connection.

Component	Description
(7) Volume scroll zone	Adjusts speaker volume. Slide your finger to the left to decrease volume and to the right to increase volume. You can also tap the minus sign on the scroll zone to decrease volume, or tap the plus sign on the scroll zone to increase volume.
(8) Internal microphone	Records sound.
(9) Fingerprint reader	Allows a fingerprint logon to Windows, instead of a password logon.



Component	Description
(1) Power button	<ul style="list-style-type: none"> When the computer is off, press the button to turn on the computer. When the computer is on, press the button to shut down the computer. When the computer is in Standby, press the button briefly to exit Standby. When the computer is in Hibernation, press the button briefly to exit Hibernation. <p>If the computer has stopped responding and Windows shutdown procedures are ineffective, press and hold the power button for at least 5 seconds to turn off the computer.</p> <p>To learn more about your power settings, select Start > Control Panel > Performance and Maintenance > Power Options.</p>
(2) Internal display switch	Turns off the display if the display is closed while the power is on.
(3) Wireless button	Turns the wireless feature on or off, but does not create a wireless connection.
	<p> NOTE: A wireless network must be set up in order to establish a wireless connection.</p>

Keys



NOTE: Your computer may look slightly different from the illustration in this section.

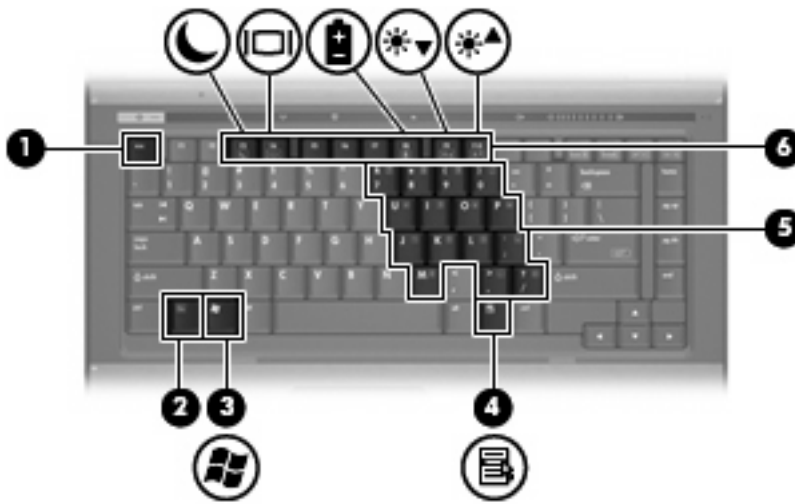

Component	Description
(1) esc key	Displays system information when pressed in combination with the fn key.
(2) fn key	Executes frequently used system functions when pressed in combination with a function key or the esc key.
(3) Windows logo key	Displays the Windows Start menu.
(4) Windows applications key	Displays a shortcut menu for items beneath the pointer.
(5) Embedded numeric keypad keys	Can be used like the keys on an external numeric keypad.
(6) Function keys	Execute frequently used system functions when pressed in combination with the fn key.

Front components

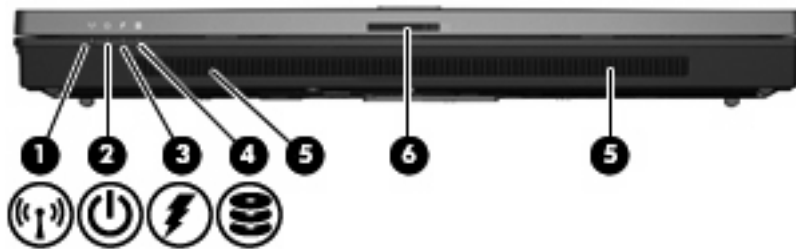

Component	Description
(1) Wireless light	<ul style="list-style-type: none"> On: An integrated wireless device, such as a wireless local area network (WLAN) device, the HP Broadband Wireless Module, and/or a Bluetooth device, is on. Off: All wireless devices are off.
(2) Power light	<ul style="list-style-type: none"> On: The computer is on. Blinking: The computer is in Standby. Blinking rapidly: An AC adapter with a higher power rating should be connected. Off: The computer is off or in Hibernation.
(3) Battery light	<ul style="list-style-type: none"> Amber: A battery is charging. Green: A battery is close to full charge capacity. Blinking amber: A battery that is the only available power source has reached a low battery level. When the battery reaches a critical battery level, the battery light begins blinking rapidly. Off: If the computer is plugged into an external power source, the light turns off when all batteries in the computer are fully charged. If the computer is not plugged into an external power source, the light stays off until the battery reaches a low battery level.
(4) Drive light	<ul style="list-style-type: none"> Blinking green: The hard drive or optical drive is being accessed. Amber (select models only): HP 3D DriveGuard has temporarily parked the hard drive.
(5) Speakers	Produce sound.
(6) Display release latch	Opens the computer.

Rear components



Component	Description
(1) Security cable slot	Attaches an optional security cable to the computer.  NOTE: The security cable is designed to act as a deterrent, but it may not prevent the computer from being mishandled or stolen.
(2) RJ-45 (network) jack	Connects a network cable.
(3) External monitor port	Connects an external VGA monitor or projector.
(4) S-Video-out jack (select models only)	Connects an optional S-Video device such as a television, VCR, camcorder, overhead projector, or video capture card.

Right-side components

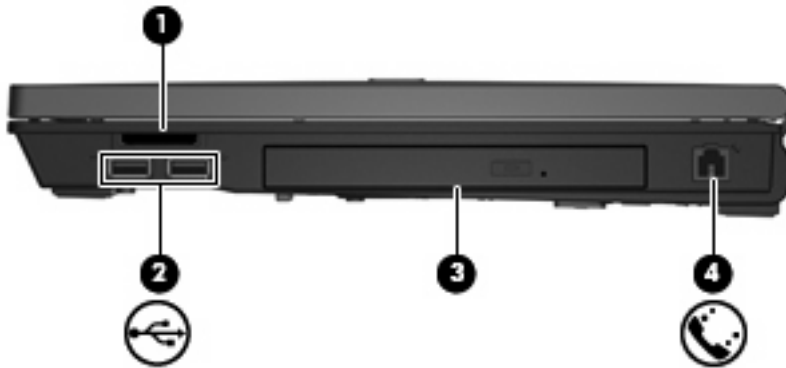

Component	Description
(1) Media Card Reader (select models only)	Supports the following optional digital card formats: Secure Digital (SD) Memory Card, MultiMediaCard (MMC), Memory Stick (MS), Memory Stick Pro (MSPro), Memory Stick Duo Adapter, xD-Picture Card (XD).
(2) USB ports (2) (select models only)	Connect an optional USB device.
(3) Optical drive	Reads an optical disc.
(4) RJ-11 (modem) jack	Connects a modem cable.

Left-side components

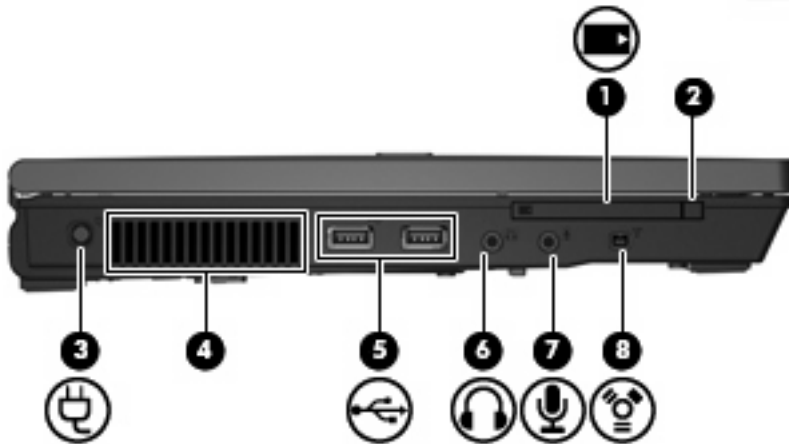

Component	Description
(1) PC Card slot	Supports optional Type I or Type II 32-bit (CardBus) or 16-bit PC Cards.
(2) PC Card eject button	Ejects a PC Card from the PC Card slot.
(3) Power connector	Connects an AC adapter.
(4) Vent	Enables airflow to cool internal components.
<p>CAUTION: To prevent overheating, do not obstruct vents. Use the computer only on a hard, flat surface. Do not allow another hard surface, such as an adjoining optional printer, or a soft surface, such as pillows or thick rugs or clothing, to block airflow.</p>	
<p>NOTE: The computer fan starts up automatically to cool internal components and prevent overheating. It is normal for the internal fan to cycle on and off during routine operation.</p>	
(5) USB ports (2)	Connect optional USB devices.
(6) Audio-out (headphone) jack	Produces sound when connected to optional powered stereo speakers, headphones, ear buds, a headset, or television audio.
(7) Audio-in (microphone) jack	Connects an optional computer headset microphone, stereo array microphone, or monaural microphone.
(8) 1394 port (select models only)	Connects an optional IEEE 1394 or 1394a device, such as a camcorder.

Bottom components

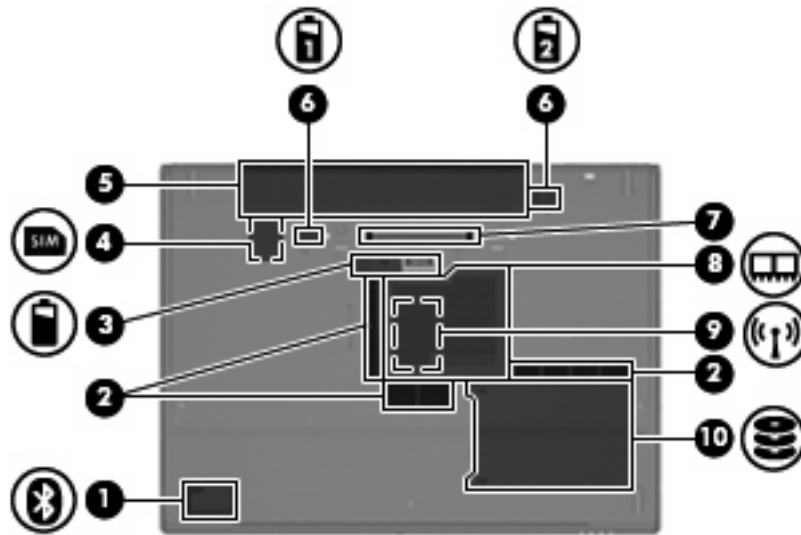

Component	Description
(1) Bluetooth compartment (select models only)	Contains a Bluetooth device.
(2) Vents	Enable airflow to cool internal components.
	<p>CAUTION: To prevent overheating, do not obstruct vents. Use the computer only on a hard, flat surface. Do not allow another hard surface, such as an adjoining optional printer, or a soft surface, such as pillows or thick rugs or clothing, to block airflow.</p> <p>NOTE: The computer fan starts up automatically to cool internal components and prevent overheating. It is normal for the internal fan to cycle on and off during routine operation.</p>
(3) Accessory battery connector	Connects an optional accessory battery.
(4) SIM slot (select models only)	Contains a subscriber identity module (SIM). The SIM slot is located inside the battery bay.
(5) Battery bay	Holds the battery.
(6) Battery release latches (2)	Release the battery from the battery bay.
(7) Docking connector (select models only)	Connects an optional docking device.
(8) Memory module compartment	Contains the memory module slot.
(9) WLAN module compartment (select models only)	Contains a WLAN (wireless local area network) module slot.
(10) Hard drive bay	Holds the hard drive.

Wireless antennae (select models only)

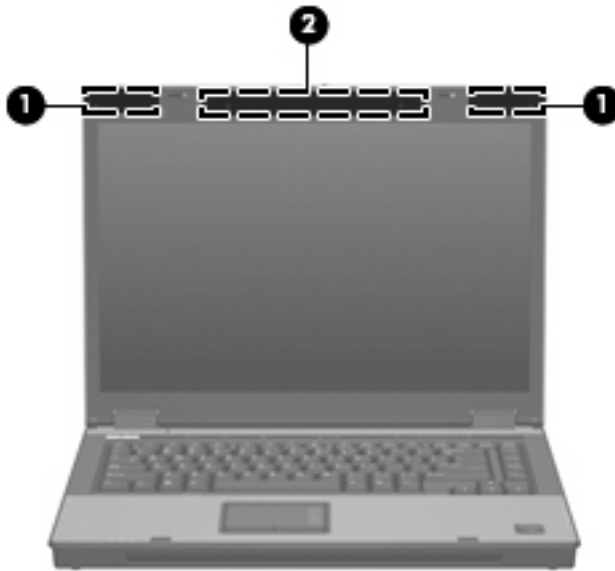

Component	Description
(1) WLAN antennae (2) (select models only)*	Send and receive wireless signals to communicate with wireless local area networks (WLAN).
(2) WWAN antenna (select models only)*	Sends and receives wireless signals to communicate with wireless wide-area networks (WWAN).

*The antennae are not visible from the outside of the computer. For optimal transmission, keep the areas immediately around the antennae free from obstructions.

Additional hardware components



Component	Description
(1) Power cord*	Connects an AC adapter to an AC outlet.
(2) AC adapter	Converts AC power to DC power.
(3) Battery*	Powers the computer when the computer is not plugged into external power.
(4) Modem cable (select models only)*	Connects the internal modem to an RJ-11 telephone jack or to a country-specific modem adapter.
(5) Country-specific modem cable adapter (select models only)*	Adapts the modem cable to a non-RJ-11 telephone jack.

*Modem cables, batteries, and power cords vary in appearance by region and country.

3 Labels

The labels affixed to the computer provide information you may need when you troubleshoot system problems or travel internationally with the computer.

- Service tag—Provides the product brand and series name, serial number (s/n), and product number (p/n) of your computer. Have this information available when you contact technical support. The service tag label is affixed to the bottom of the computer.
- Microsoft® Certificate of Authenticity (select models only)—Contains the Windows® Product Key. You may need the Product Key to update or troubleshoot the operating system. This certificate is affixed to the bottom of the computer.
- Regulatory label—Provides regulatory information about the computer. The regulatory label is affixed to the bottom of the computer.
- Modem approval label—Provides regulatory information about the modem and lists the agency approval markings required by some of the countries in which the modem has been approved for use. You may need this information when traveling internationally. The modem approval label is affixed inside the memory module compartment.
- Wireless certification label(s) (select models only)—Provide information about optional wireless devices and the approval markings of some of the countries in which the devices have been approved for use. An optional device may be a wireless local area network (WLAN) device, an HP Broadband Wireless Module, or an optional Bluetooth® device. If your computer model includes one or more wireless devices, one or more certification labels are included with your computer. You may need this information when traveling internationally. Wireless certification labels are affixed inside the memory module compartment.
- SIM (subscriber identity module) label (select models only)—Provides the ICCID (Integrated Circuit Card Identifier) of your SIM. This label is located inside the battery bay.
- HP Broadband Wireless Module serial number label (select models only)—Provides the serial number of your HP Broadband Wireless Module. This label is located inside the battery bay.

Index

Symbols/Numerics

1394 port, identifying 13

A

AC adapter, identifying 16
accessory battery connector,
identifying 14
applications key, Windows 9
audio-in (microphone) jack,
identifying 13
audio-out (headphone) jack,
identifying 13

B

battery bay 14, 17
battery light, identifying 5, 6, 10
battery release latch,
identifying 14
battery, identifying 16
bays
battery 14, 17
hard drive 14
Bluetooth compartment,
identifying 14
Bluetooth label 17
buttons
info 7
PC Card eject 13
power 7, 8
Presentation 7
TouchPad 3
volume mute 7
wireless 7, 8

C

caps lock light, identifying 4, 6
Certificate of Authenticity label 17
compartment
memory module 14
WLAN module 14

components
additional hardware 16
bottom 14
front 10
left-side 13
rear 11
right-side 12
top 3
wireless antennae 15
connector, power 13
cord, power 16
country-specific modem cable
adapter 16

D

display release latch,
identifying 10
display switch, identifying 7
docking connector, identifying 14
drive light, identifying 5, 6, 10

E

esc key, identifying 9
external monitor port,
identifying 11

F

fingerprint reader, identifying 8
fn key, identifying 9
function keys, identifying 9

H

hard drive bay, identifying 14
headphone (audio-out) jack 13
HP Broadband Wireless Module
label 17

I

IEEE 1394 port, identifying 13
info button, identifying 7

internal display switch,
identifying 7
internal microphone, identifying 8

J

jacks
audio-in (microphone) 13
audio-out (headphone) 13
RJ-11 (modem) 12
RJ-45 (network) 11
S-Video-out 11

K

keypad keys, identifying 9
keys
esc 9
fn 9
function 9
keypad 9
Windows applications 9
Windows logo 9

L

labels
Bluetooth 17
HP Broadband Wireless
Module 17
Microsoft Certificate of
Authenticity 17
modem approval 17
regulatory 17
service tag 17
SIM 17
wireless certification 17
WLAN 17
latch, battery release 14
lights
battery 5, 6, 10
caps lock 4, 6
drive 5, 6, 10

- mute 4
- num lock 4, 6
- power 4, 6, 10
- volume down 4
- volume mute 4
- volume up 4
- wireless 4, 10

M

- Media Card Reader, identifying 12
- memory module compartment, identifying 14
- microphone (audio-in) jack 13
- Microsoft Certificate of Authenticity label 17
- modem approval label 17
- modem cable 16
- monitor port, external 11
- mute button, identifying 7
- mute light, identifying 4

N

- num lock light, identifying 4, 6

O

- operating system
 - Microsoft Certificate of Authenticity label 17
 - Product Key 17
- optical drive, identifying 12

P

- PC Card eject button, identifying 13
- PC Card slot, identifying 13
- ports
 - 1394 13
 - external monitor 11
 - USB 12, 13
- power button, identifying 7, 8
- power connector, identifying 13
- power cord, identifying 16
- power light, identifying 10
- power lights, identifying 4, 6
- Presentation button, identifying 7
- Product Key 17
- product name and number, computer 17

R

- regulatory information
 - modem approval label 17
 - regulatory label 17
 - wireless certification labels 17
- release latch, battery 14
- RJ-11 (modem) jack, identifying 12
- RJ-45 (network) jack, identifying 11

S

- S-Video-out jack, identifying 11
- scrolling regions, TouchPad 3
- security cable slot, identifying 11
- serial number, computer 17
- service tag 17
- SIM label 17
- SIM slot, identifying 14
- slots
 - Media Card Reader 12
 - memory module 14
- speaker, identifying 10

T

- TouchPad
 - buttons 3
 - identifying 3
 - scrolling regions 3
- traveling with the computer
 - modem approval label 17
 - wireless certification labels 17

U

- USB ports, identifying 12, 13

V

- vent 13
- vents, identifying 14
- volume down light, identifying 4
- volume mute button, identifying 7
- volume mute light, identifying 4
- volume scroll zone, identifying 8
- volume up light, identifying 4

W

- Windows applications key, identifying 9
- Windows logo key, identifying 9
- wireless button, identifying 7, 8
- wireless certification label 17

- wireless light, identifying 4, 10
- WLAN antennae, identifying 15
- WLAN device 17
- WLAN label 17
- WLAN module compartment, identifying 14
- WWAN antenna, identifying 15

