

Linbergh/Kapalua Antenna Regulatory Information

Description : Triple-band Antenna(Main+Aux)
Compal P/N: DC330005300
DC330005310
Wistron NeWeb P/N: 81.CA915.001
81.CA915.002

Wistron NeWeb Corporation

No. 10-1,Li-hsin Road I,
Science-base Industrial Park,
Hsinchu 300,Taiwan, R.O.C.
Tel: 886-3-6667799#6545
Fax: 886-3-6667711

Provided by Wistron NeWeb Corp.	Reviewed by Wistron NeWeb Corp.
<i>David Tau</i>	<i>Weili Cheng</i>

I. Antenna Type

Position	Main Antenna (Right-side Antenna)	Aux Antenna (Left-side Antenna)
Antenna Type	PIFA	PIFA
Material	Metal sheet	Metal sheet

II. Peak Gain and Average Gain

Antenna Gain		2G4 ISM (2.400 GHz - 2.4835 GHz)			U-NII (5.150 GHz - 5.350 GHz)			HyperLAN (5.470 GHz - 5.725 GHz)		
		2.40 GHz	2.45 GHz	2.50GHz	5.15 GHz	5.25 GHz	5.35 GHz	5.47 GHz	5.5975 GHz	5.725 GHz
MAIN	Peak dBi	2.34	2.39	2.07	2.18	3.29	2.54	1.82	2.29	1.35
	Avg dBi	-2.16	-2.35	-2.25	-3.66	-2.79	-3.13	-2.65	-2.13	-3.05
AUX	Peak dBi	0.38	1.32	0.97	3.12	3.39	3.47	2.65	3.38	2.63
	Avg dBi	-2.96	-3.07	-2.88	-3.60	-2.67	-2.43	-2.63	-2.28	-2.40

III. Antenna Model Number

Model number: CA9-C

IV. Manufacturing Info

Wistron NeWeb Corporation
No. 10-1, Li-hsin Road I,
Science-base Industrial Park,
Hsinchu 300, Taiwan, R.O.C.

V. Antenna Dimensions (Mechanical drawings)

(See Next 2 Pages)

1

2

PART NUMBER BLOCK	
PART NUMBER	REV

REVISIONS				
ZONE	REV	DESCRIPTION	DATE	APPROVED

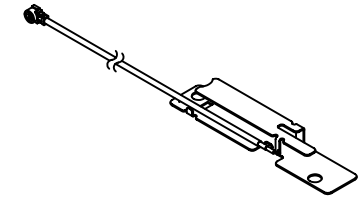
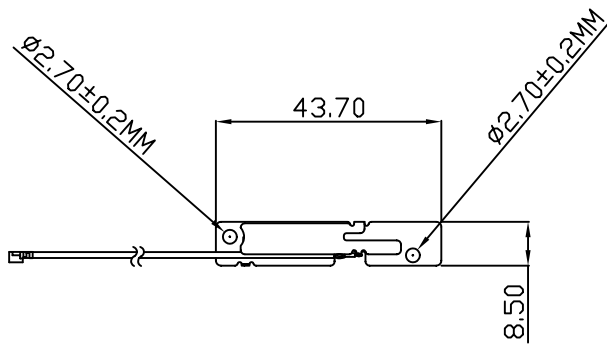
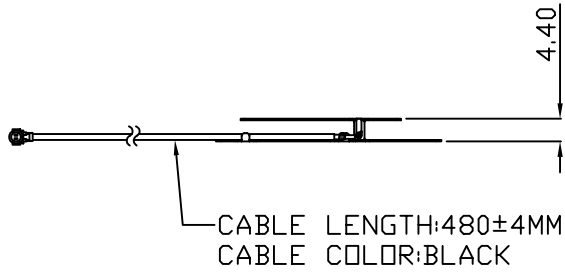

		UNLESS OTHERWISE SPECIFIED ALL DIMENSIONS ARE IN mm AND TOLERANCES ARE:				wistron 啟基科技股份有限公司	
		INTEGRAL DIMENSIONS ±0.2		ANGULAR DIMENSIONS ±1°		No. 10-1, Li-hsin Road I, Science-based Industrial Park, Hsinchu 300, Taiwan, R.O.C.	
		1 PLACE DECIMAL ±0.1		HOLES UNDER Ø5.00 ±0.05		Tel: 886-3-6667799 Fax: 886-3-6667711	
		MATERIAL: SEE NOTES				DWG TITLE	
		FINISH: SEE NOTES				OUTLINE, Main, CA9-C	
NEXT ASSY		USED ON		THIRD ANGLE PROJECTION	DRAWN	GUO CHANG	12/26/02
APPLICATION					ENGR	DAVID WS TAU	12/26/02
					APVD		
					SIZE	DWG NO.	
					A3	3A.CA945.112	
					SCALE	1/1	SHEET 1 OF 1
							REV NO

1

2

A

A

B

B

1

2

PART NUMBER BLOCK	
PART NUMBER	REV

REVISIONS				
ZONE	REV	DESCRIPTION	DATE	APPROVED

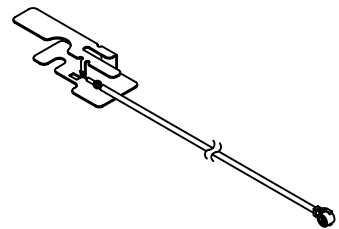
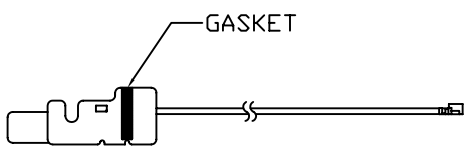
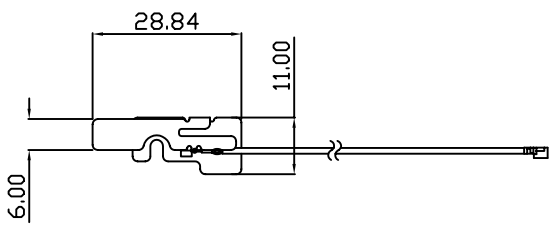
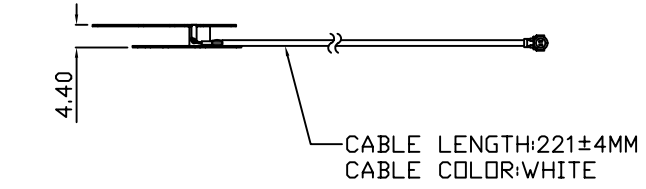

		UNLESS OTHERWISE SPECIFIED ALL DIMENSIONS ARE IN mm AND TOLERANCES ARE:				wistron 啟基科技股份有限公司	
		INTEGRAL DIMENSIONS ±0.2		ANGULAR DIMENSIONS ±1°		No. 10-1, Li-hsin Road I, Science-based Industrial Park, Hsinchu 300, Taiwan, R.O.C.	
		1 PLACE DECIMAL ±0.1		HOLES UNDER Ø5.00 ±0.05		Tel: 886-3-6667799 Fax: 886-3-6667711	
		MATERIAL: SEE NOTES				DWG TITLE	
		FINISH: SEE NOTES				OUTLINE, AUX, CA9-C	
NEXT ASSY		USED ON		THIRD ANGLE PROJECTION	DRAWN	GUO CHANG	12/26/02
APPLICATION					ENGR	DAVID WS TAU	12/26/02
					SCALE	1/1	SHEET 1 OF 1
					SIZE	DWG NO.	REV NO
					A3	3A.CA945.111	

1

2

A

A

B

B

VI. Pictures of Antennas

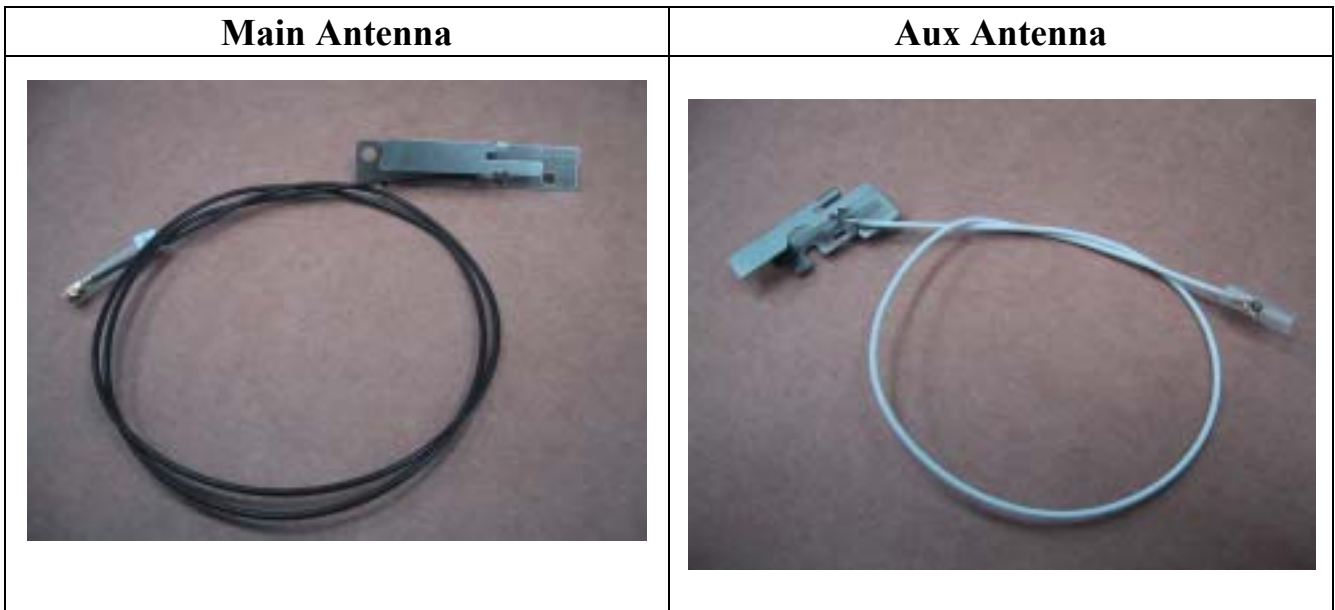

VII. Cable Length

Left-side antenna: 221mm Φ 1.13mm
 Right-side antenna: 480mm Φ 1.13mm
 (From the center of connector to the end of cable)

VIII. Cable Loss (including connector)

Unit: dB	2G4 band	U-NII band	HyperLAN band
221mm	1.03	1.34	1.44
480mm	1.81	2.61	2.77

XI. Antenna Material

Main antenna	Aux antenna
<ol style="list-style-type: none"> 1. Stamped metal 2. Junkosha cable and IPEX connector (Nissei cable and HRS connector) 3. Sponge 4. Tape 	<ol style="list-style-type: none"> 1. Stamped metal 2. Junkosha cable and IPEX connector (Nissei cable and HRS connector) 3. Sponge 4. Tape 5. Gasket e

XII. Connector Info (general description)

Description (Cable)	Inner Conductor: AWG#32(7/0.8), Silver plating annealed copper wire or its performance equivalent Dielectric core: D0.68mm Outer conductor: 16/4/0.05 D0.93mm, Silver plating annealed copper wire or its performance equivalent Jacket: D1.13mm		
Requirements	Characteristic impedance: 50(+2,-2)ohm Nominal capacitance: 97pF/m Conductor resistance of inner conductor at 293K(20): 520ohm/km MAX Insulation resistance: 1500mega-ohm.km MIN Dielectric withstand voltage: no breakdown at AC1000V for 1min.		
Ratings	Rated voltage: AC60Vrms Nominal characteristics impedance: 50ohm VSWR: 1.3MAX DC~3GHz, 1.7MAX 3~6GHz		
Electric characteristics	Contact resistance	10mA MAX(DC or 1000Hz)	Center contact 74mohm MAX. Outer contact 27mohm MAX.
	Insulation resistance	100V DC	500Mohm MIN
	Voltage proof	200V AC for 1 min. Current leakage 2mA MAX	No flashover or breakdown

XIII. Radiation Pattern

Platform: Linbergh PT4
 Supplier: Wistron NeWeb coporation
 Date: 2003/1/15

2G4 ISM (2.400 GHz - 2.4835 GHz) Antenna Radiation Patterns

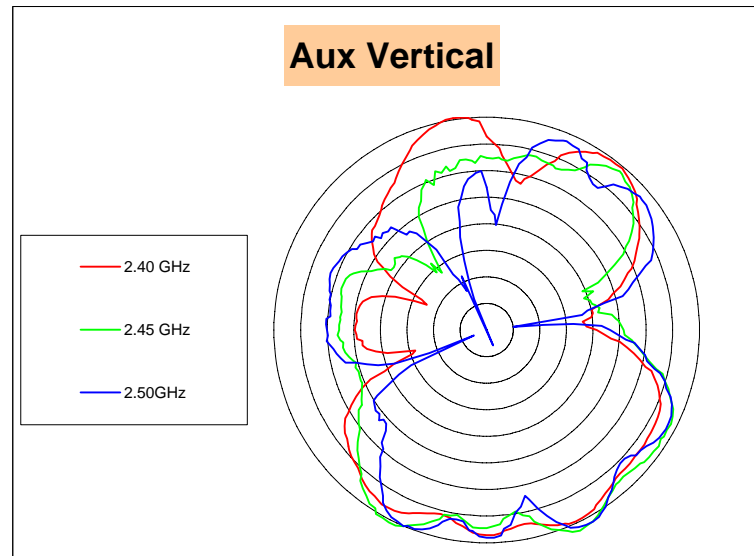
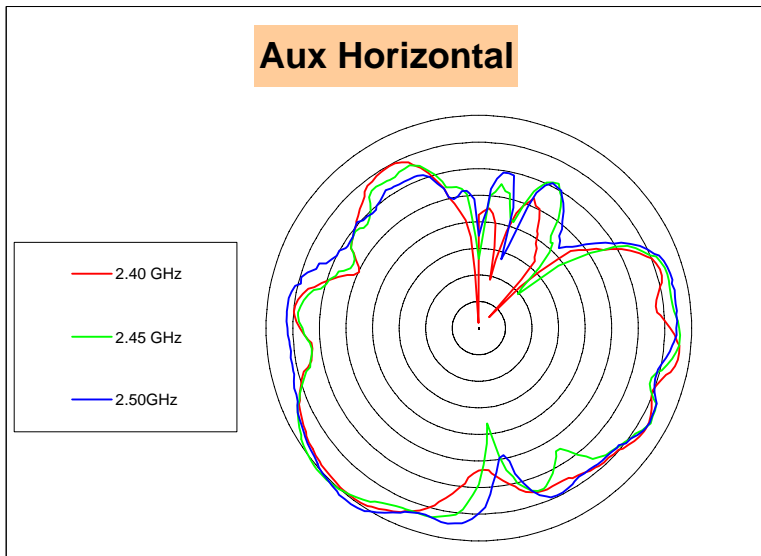
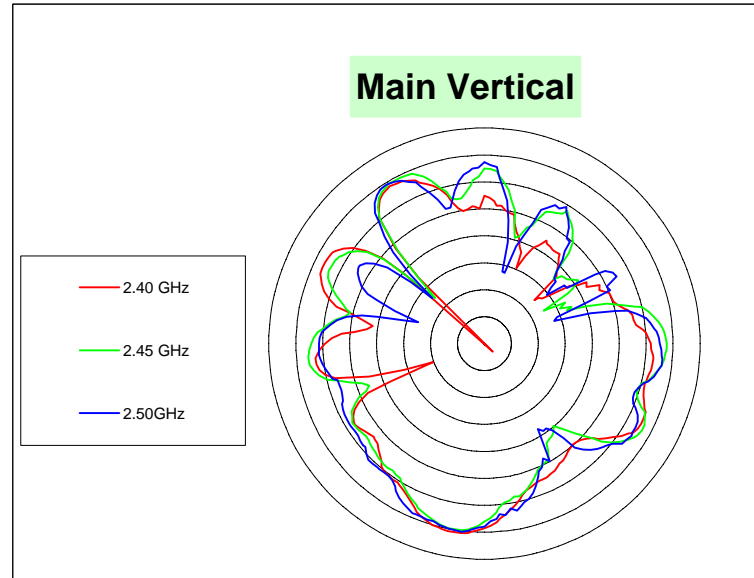
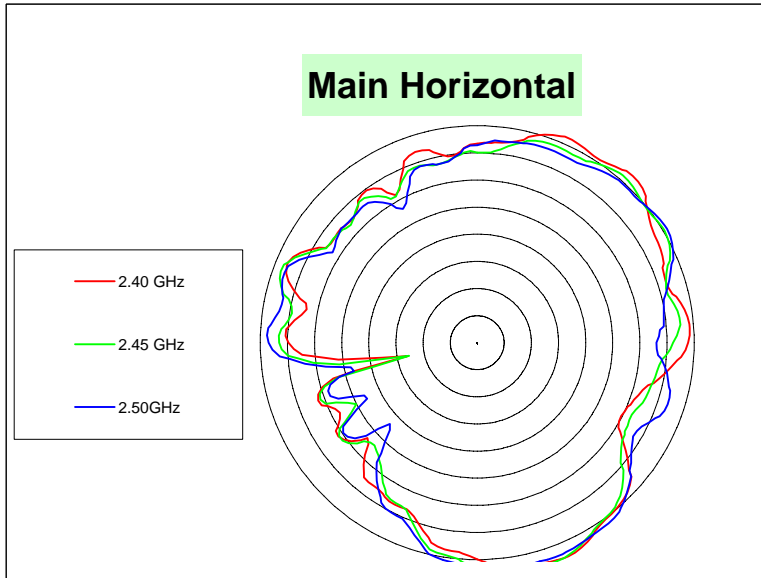

2G4 ISM (2.400 GHz - 2.4835 GHz)			
CONFIG	FREQ GHz	Avg dBi	Pk dBi
Main Horz	2.4	-2.36	2.34
	2.45	-2.57	2.38
	2.5	-2.45	2.06
Main Vert	2.4	-9.95	0.86
	2.45	-9.78	-5.10
	2.5	-9.89	-4.89
Aux Horz	2.4	-5.85	-0.27
	2.45	-5.66	0.11
	2.5	-4.93	0.61
Aux Vert	2.4	-4.60	0.32
	2.45	-4.94	1.60
	2.5	-5.18	1.18

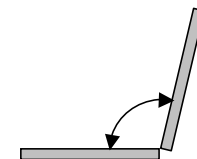

VSWR open = lid/keyboard angle 110°

Note: The outer circle approximately represents the 0 dBi gain circle

Platform: Platform: Linbergh PT4
 Supplier: Supplier: Wistron NeWeb coporation
 Date: Date: 2003/1/15

U-NII (5.150 GHz - 5.350 GHz) Antenna Radiation Patterns

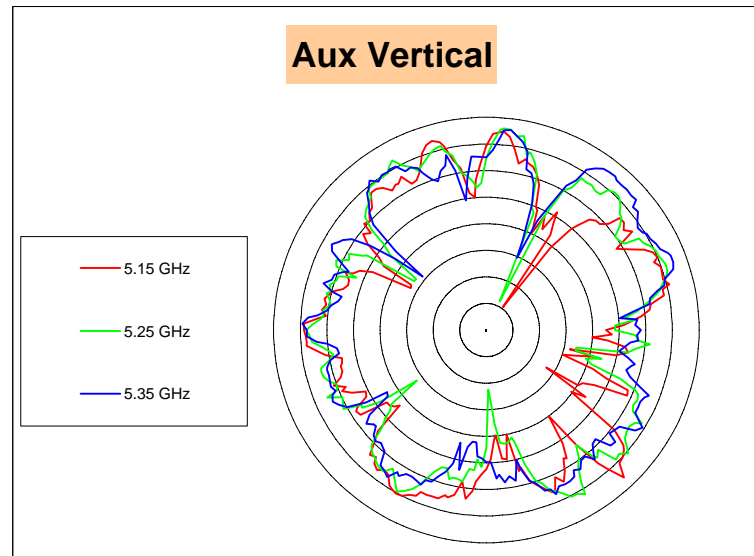
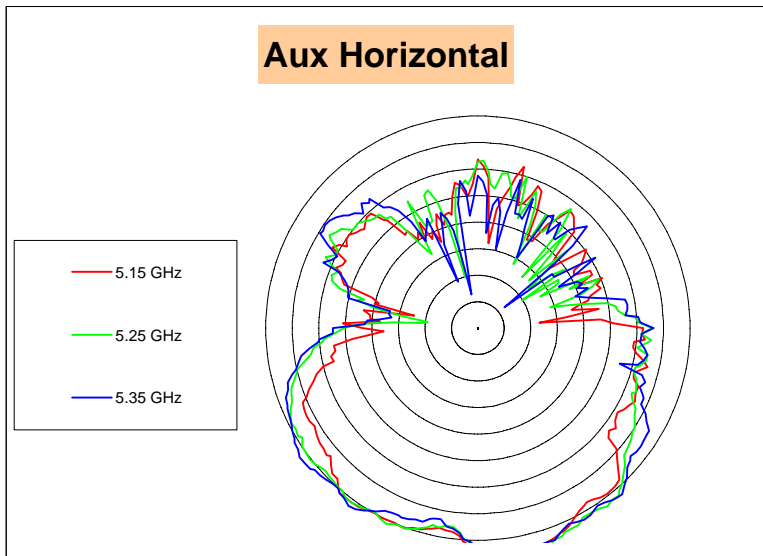
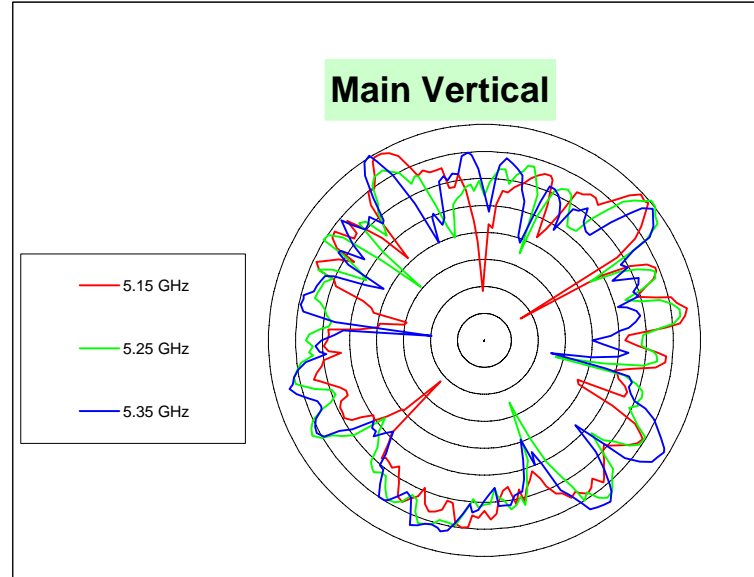
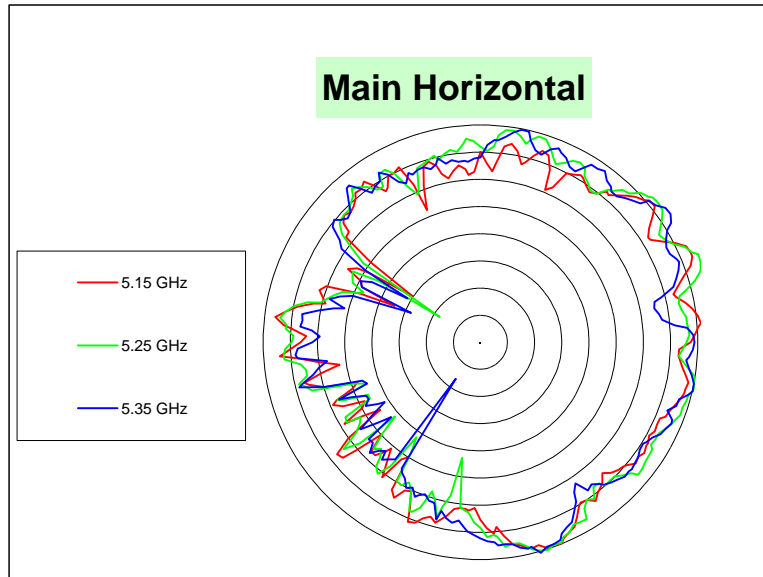

U-NII (5.150 GHz - 5.350 GHz)			
CONFIG	FREQ GHz	Avg dBi	Pk dBi
Main Horz	5.15	-4.37	2.12
	5.25	-3.45	3.26
	5.35	-4.10	2.22
Main Vert	5.15	-7.77	-0.37
	5.25	-7.35	0.28
	5.35	-7.12	0.27
Aux Horz	5.15	-4.47	3.12
	5.25	-3.50	3.39
	5.35	-3.36	3.46
Aux Vert	5.15	-8.72	-2.07
	5.25	-8.03	-1.96
	5.35	-7.67	-2.09

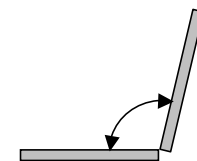

VSWR open = lid/keyboard angle 110°

Note: The outer circle approximately represents the 0 dBi gain circle

Platform: Platform: Linbergh PT4
 Supplier: Supplier: Wistron NeWeb coporation
 Date: Date: 2003/1/15

HyperLAN (5.470 GHz - 5.725 GHz) Antenna Radiation Patterns

Main Horizontal

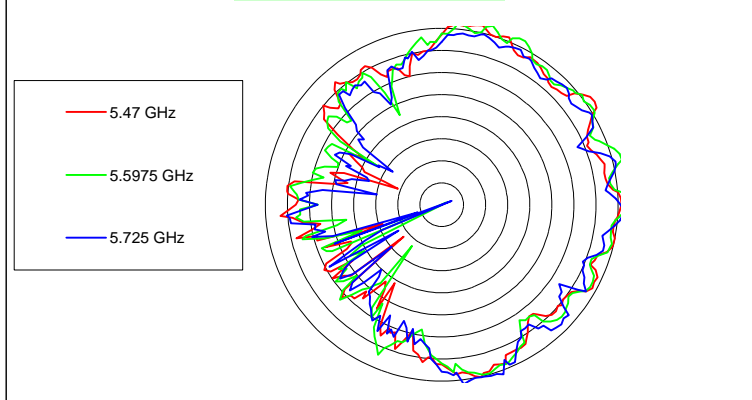

Main Vertical

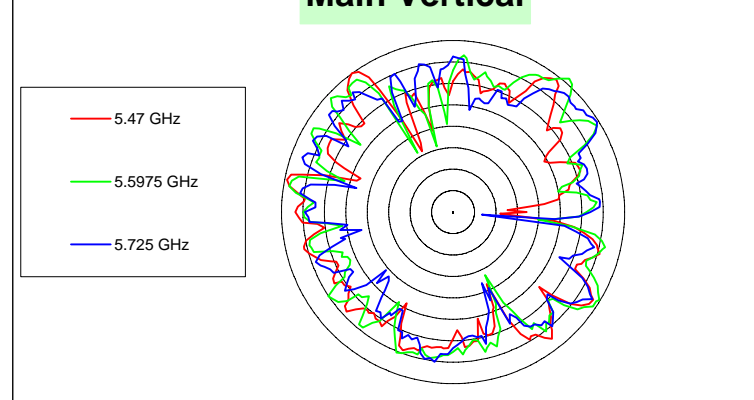

Aux Horizontal

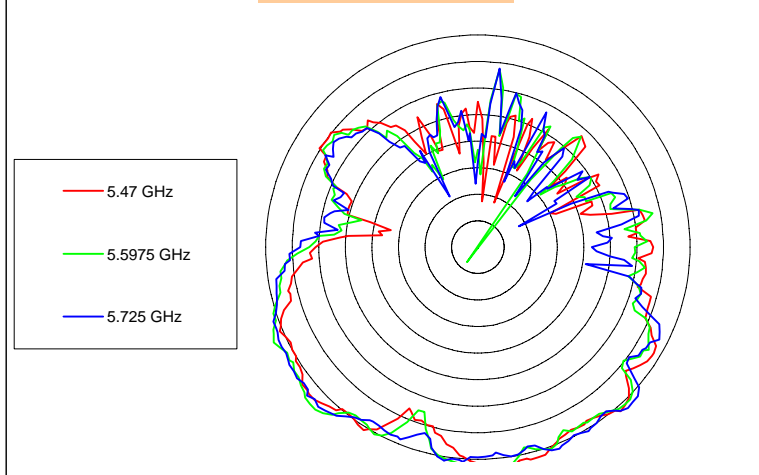

Aux Vertical

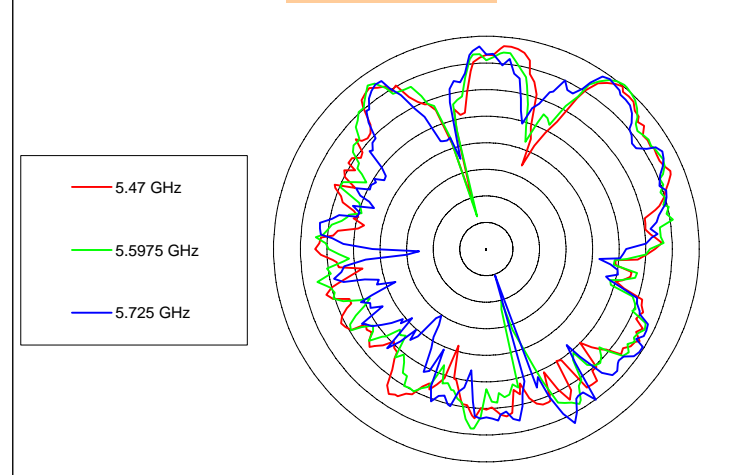

HyperLAN (5.470 GHz - 5.725 GHz)			
CONFIG	FREQ GHz	Avg dBi	Pk dBi
Main Horz	5.47	-3.46	1.81
	5.5975	-3.12	2.28
	5.725	-4.01	1.35
Main Vert	5.47	-7.01	0.07
	5.5975	-5.74	1.29
	5.725	-6.83	-0.36
Aux Horz	5.47	-3.77	2.64
	5.5975	-3.34	3.38
	5.725	-3.37	2.63
Aux Vert	5.47	-7.30	-0.14
	5.5975	-7.31	0.30
	5.725	-7.71	-0.54

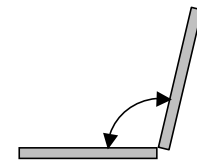

VSWR open = lid/keyboard angle 110°

Note: The outer circle approximately represents the 0 dBi gain circle