



**FCC CFR47 CLASS II PERMISSIVE CHANGE  
CERTIFICATION**

**TEST REPORT**

**FOR**

**BROADCOM 802.11b WLAN MINI PCI CARD IN PP2210**

**MODEL NUMBER: BCM94301MPL**

**FCC ID: QDS-BRCM1002-H**

**REPORT NUMBER: 03U2257-1**

**ISSUE DATE: SEPT 26, 2003**

*Prepared for*

**BROADCOM CORPORATION  
190 MATHILDA PLACE  
SUNNYVALE, CA 94086**

*Prepared by*

**COMPLIANCE CERTIFICATION SERVICES  
561F MONTEREY ROAD,  
MORGAN HILL, CA 95037, USA  
TEL: (408) 463-0885  
FAX: (408) 463-0888**



## TABLE OF CONTENTS

<b>1. TEST RESULT CERTIFICATION .....</b>	<b>3</b>
<b>2. FCC CLASS II CHANGE .....</b>	<b>4</b>
<b>3. TEST METHODOLOGY.....</b>	<b>5</b>
<b>4. FACILITIES AND ACCREDITATION.....</b>	<b>5</b>
<b>5. CALIBRATION AND UNCERTAINTY .....</b>	<b>6</b>
5.1. <i>MEASURING INSTRUMENT CALIBRATION .....</i>	<i>6</i>
5.2. <i>MEASUREMENT UNCERTAINTY.....</i>	<i>6</i>
<b>6. CALIBRATION AND UNCERTAINTY .....</b>	<b>7</b>
6.1. <i>MEASURING INSTRUMENT CALIBRATION .....</i>	<i>7</i>
6.2. <i>MEASUREMENT UNCERTAINTY.....</i>	<i>7</i>
6.3. <i>TEST AND MEASUREMENT EQUIPMENT.....</i>	<i>8</i>
<b>7. SETUP OF EQUIPMENT UNDER TEST.....</b>	<b>9</b>
7.1. <i>RADIATED EMISSIONS .....</i>	<i>11</i>
7.1.1. <i>RADIATED EMISSIONS ABOVE 1 GHZ.....</i>	<i>14</i>
7.1.2. <i>RADIATED EMISSIONS BELOW 1 GHZ .....</i>	<i>25</i>
7.2. <i>POWERLINE CONDUCTED EMISSIONS.....</i>	<i>27</i>
<b>8. SETUP PHOTOS .....</b>	<b>30</b>

# 1. TEST RESULT CERTIFICATION

**COMPANY NAME:** BROADCOM CORPORATION  
190 MATHILDA PLACE  
SUNNYVALE, CA 94086

**EUT DESCRIPTION:** 802.11b WLAN MINI PCI CARD

**MODEL:** BCM94301MPL

**DATE TESTED:** 9/24/2003, 9/25/2003

APPLICABLE STANDARDS	
STANDARD	TEST RESULTS
FCC PART 15 SUBPART C	NO NON-COMPLIANCE NOTED

Compliance Certification Services, Inc. tested the above equipment in accordance with the requirements set forth in the above standards. The test results show that the equipment tested is capable of demonstrating compliance with the requirements as documented in this report.

**Note:** This document reports conditions under which testing was conducted and results of tests performed. This document may not be altered or revised in any way unless done so by Compliance Certification Services and all revisions are duly noted in the revisions section. Any alteration of this document not carried out by Compliance Certification Services will constitute fraud and shall nullify the document.

Approved & Released For CCS By:



---

THU CHAN  
EMC SUPERVISOR  
COMPLIANCE CERTIFICATION SERVICES

Tested By:



---

YAN ZHENG  
EMC ENGINEER  
COMPLIANCE CERTIFICATION SERVICES

## 2. FCC CLASS II CHANGE

The EUT is an 802.11b WLAN Mini PCI Card operating in the 2400 – 2483.5 MHz band with a peak output power of 19.36dBm (86.3 mW). The changes are as follows:

1. Adding additional host, HP model PP2210;
- 2.
3. Adding two antenna options:
  - a. SmartAnt Telecom Co., Inverted F P/N: R0322-031R (main), P/N: R0322-031L (Aux).  
Peak gain: 1.27dBi
  - b. Wistron NeWeb, Metal PIFA, P/N: 81.EBC15.002 (main), P/N: 81.EBC15.001 (aux)  
Peak gain: 2.97dBi

### 3. TEST METHODOLOGY

The tests documented in this report were performed in accordance with ANSI C63.4/1992, FCC CFR 47 Part 2 and FCC CFR 47 Part 15.

### 4. FACILITIES AND ACCREDITATION

The open area test sites and conducted measurement facilities used to collect data are located at 561F Monterey Road, Morgan Hill, California, USA. The sites are constructed in conformance with the requirements of ANSI C63.4, ANSI C63.7 and CISPR Publication 22. All receiving equipment conforms to CISPR Publication 16-1, "Radio Interference Measuring Apparatus and Measurement Methods."

CCS is accredited by NVLAP, Laboratory Code 200065-0. The full scope of accreditation can be viewed at <http://www.ccsemc.com>.



No part of this report may be used to claim or imply product endorsement by NVLAP or any agency of the US Government.

## 5. CALIBRATION AND UNCERTAINTY

### 5.1. MEASURING INSTRUMENT CALIBRATION

The measuring equipment utilized to perform the tests documented in this report has been calibrated in accordance with the manufacturer's recommendations, and is traceable to recognized national standards.

### 5.2. MEASUREMENT UNCERTAINTY

Where relevant, the following measurement uncertainty levels have been estimated for tests performed on the apparatus:

Radiated Emission, 30 to 200 MHz	+/- 3.3 dB
Radiated Emission, 200 to 1000 MHz	+4.5 / -2.9 dB
Radiated Emission, 1000 to 2000 MHz	+4.5 / -2.9 dB
Power Line Conducted Emission	+/- 2.9 dB

Uncertainty figures are valid to a confidence level of 95%.

## 6. CALIBRATION AND UNCERTAINTY

### 6.1. MEASURING INSTRUMENT CALIBRATION

The measurement instruments utilized to perform the tests documented in this report have been calibrated in accordance with the manufacturer's recommendations, and are traceable to national standards.

### 6.2. MEASUREMENT UNCERTAINTY

Where relevant, the following measurement uncertainty levels have been estimated for tests performed on the apparatus:

Radiated Emission, 30 to 200 MHz	+/- 3.3 dB
Radiated Emission, 200 to 1000 MHz	+4.5 / -2.9 dB
Radiated Emission, 1000 to 2000 MHz	+4.5 / -2.9 dB
Power Line Conducted Emission	+/- 2.9 dB

Uncertainty figures are valid to a confidence level of 95%.

### 6.3. TEST AND MEASUREMENT EQUIPMENT

The following test and measurement equipment was utilized for the tests documented in this report:

TEST AND MEASUREMENT EQUIPMENT LIST				
Name of Equipment	Manufacturer	Model	Serial Number	Calibration Due Date
EMI Test Receiver	R & S	ESHS 20	827129/006	7/17/2004
LISN, 10 kHz ~ 30 MHz	FCC	50/250-25-2	114	9/6/2004
Spectrum Analyzer	AGILENT	E4446A	US42070220	1/13/04
Pre-amplifier	MITEQ	NSP2600-SP	924341	4/25/04
Horn Antenna	EMCO	3115	6717	2/04/04
Power Meter	AGILENT	E4416A	0841291160	11/07/04
Power Sensor	Agilent	E9327A	US40440755	11/07/04
Antenna, Biconical	Eaton	94455-1	1214	3/06/04
Antenna, Log Periodic	EMCO	3146	9107-3163	3/06/04
Preamplifier	Miteq	NSP10023988	646456	4/26/04
Band Reject 2.4GHz	Micro-Tronics	BRM50702	003	N.C.R.
High Pass Filter (1.5GHz)	Micro-Tronics	HPM13193	001	N.C.R.



## 7. SETUP OF EQUIPMENT UNDER TEST

### SUPPORT EQUIPMENT

PERIPHERAL SUPPORT EQUIPMENT LIST				
Device Type	Manufacturer	Model	Serial Number	FCC ID
<b>Laptop</b>	<b>HP</b>	<b>PP2210</b>	<b>CAT000069915</b>	<b>DoC</b>
<b>AC adapter</b>	<b>HP</b>	<b>PA-1121-02H</b>	<b>587630ALLOR2CW</b>	<b>DoC</b>

### I/O CABLES

Cable No.	Port	# of Identical Ports	Connector Type	Cable Type	Cable Length	Remarks
<b>1</b>	<b>AC</b>	<b>1</b>	<b>US115</b>	<b>Unshielded</b>	<b>1.8m</b>	<b>No</b>
<b>2</b>	<b>DC</b>	<b>1</b>	<b>DC Jack</b>	<b>Unshielded</b>	<b>1.8m</b>	<b>No</b>

### TEST SETUP

The EUT is installed in the host laptop.

**SETUP DIAGRAM**

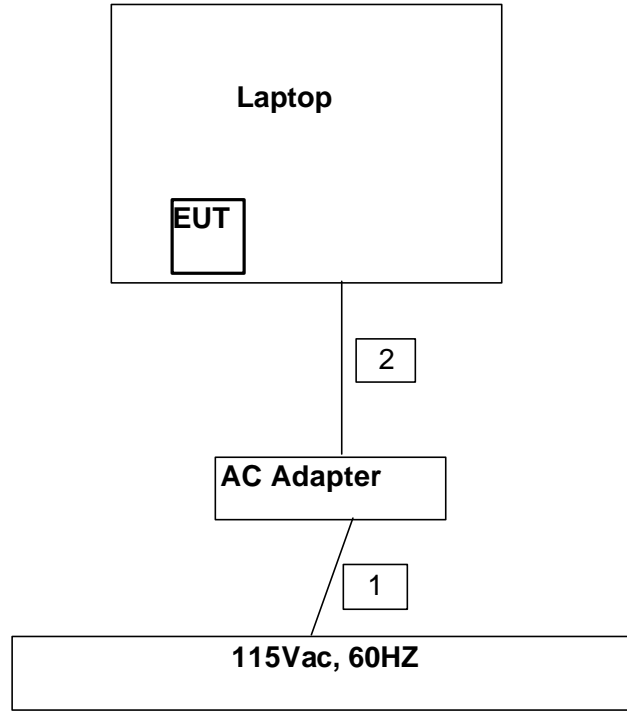

## 7.1. RADIATED EMISSIONS

### LIMITS

§15.205 (a) Except as shown in paragraph (d) of this section, only spurious emissions are permitted in any of the frequency bands listed below:

MHz	MHz	MHz	GHz
0.090 - 0.110	16.42 - 16.423	399.9 - 410	4.5 - 5.15
<sup>1</sup> 0.495 - 0.505	16.69475 - 16.69525	608 - 614	5.35 - 5.46
2.1735 - 2.1905	16.80425 - 16.80475	960 - 1240	7.25 - 7.75
4.125 - 4.128	25.5 - 25.67	1300 - 1427	8.025 - 8.5
4.17725 - 4.17775	37.5 - 38.25	1435 - 1626.5	9.0 - 9.2
4.20725 - 4.20775	73 - 74.6	1645.5 - 1646.5	9.3 - 9.5
6.215 - 6.218	74.8 - 75.2	1660 - 1710	10.6 - 12.7
6.26775 - 6.26825	108 - 121.94	1718.8 - 1722.2	13.25 - 13.4
6.31175 - 6.31225	123 - 138	2200 - 2300	14.47 - 14.5
8.291 - 8.294	149.9 - 150.05	2310 - 2390	15.35 - 16.2
8.362 - 8.366	156.52475 - 156.52525	2483.5 - 2500	17.7 - 21.4
8.37625 - 8.38675	156.7 - 156.9	2655 - 2900	22.01 - 23.12
8.41425 - 8.41475	162.0125 - 167.17	3260 - 3267	23.6 - 24.0
12.29 - 12.293	167.72 - 173.2	3332 - 3339	31.2 - 31.8
12.51975 - 12.52025	240 - 285	3345.8 - 3358	36.43 - 36.5
12.57675 - 12.57725	322 - 335.4	3600 - 4400	( <sup>2</sup> )
13.36 - 13.41			

<sup>1</sup> Until February 1, 1999, this restricted band shall be 0.490-0.510 MHz.

<sup>2</sup> Above 38.6

§15.205 (b) Except as provided in paragraphs (d) and (e), the field strength of emissions appearing within these frequency bands shall not exceed the limits shown in Section 15.209. At frequencies equal to or less than 1000 MHz, compliance with the limits in Section 15.209 shall be demonstrated using measurement instrumentation employing a CISPR quasi-peak detector. Above 1000 MHz, compliance with the emission limits in Section 15.209 shall be demonstrated based on the average value of the measured emissions. The provisions in Section 15.35 apply to these measurements.

§15.209 (a) Except as provided elsewhere in this Subpart, the emissions from an intentional radiator shall not exceed the field strength levels specified in the following table:

Frequency (MHz)	Field Strength (microvolts/meter)	Measurement Distance (meters)
30 - 88	100 **	3
88 - 216	150 **	3
216 - 960	200 **	3
Above 960	500	3

\*\* Except as provided in paragraph (g), fundamental emissions from intentional radiators operating under this Section shall not be located in the frequency bands 54-72 MHz, 76-88 MHz, 174-216 MHz or 470-806 MHz. However, operation within these frequency bands is permitted under other sections of this Part, e.g., Sections 15.231 and 15.241.

§15.209 (b) In the emission table above, the tighter limit applies at the band edges.

## **TEST PROCEDURE**

The EUT is placed on a non-conducting table 80 cm above the ground plane. The antenna to EUT distance is 3 meters. The EUT is configured in accordance with ANSI C63.4. The EUT is set to transmit in a continuous mode.

For measurements below 1 GHz the resolution bandwidth is set to 100 kHz for peak detection measurements or 120 kHz for quasi-peak detection measurements. Peak detection is used unless otherwise noted as quasi-peak.

For measurements above 1 GHz the resolution bandwidth is set to 1 MHz, then the video bandwidth is set to 1 MHz for peak measurements and 10 Hz for average measurements.

The spectrum from 30 MHz to 26 GHz is investigated with the transmitter set to the lowest, middle, and highest channels.

The frequency range of interest is monitored at a fixed antenna height and EUT azimuth. The EUT is rotated through 360 degrees to maximize emissions received. The antenna is scanned from 1 to 4 meters above the ground plane to further maximize the emission. Measurements are made with the antenna polarized in both the vertical and the horizontal positions.

## **RESULTS**

No non-compliance noted:

### 7.1.1. RADIATED EMISSIONS ABOVE 1 GHZ

#### RESTRICTED BANDEDGE (b MODE, LOW CHANNEL, HORIZONTAL)

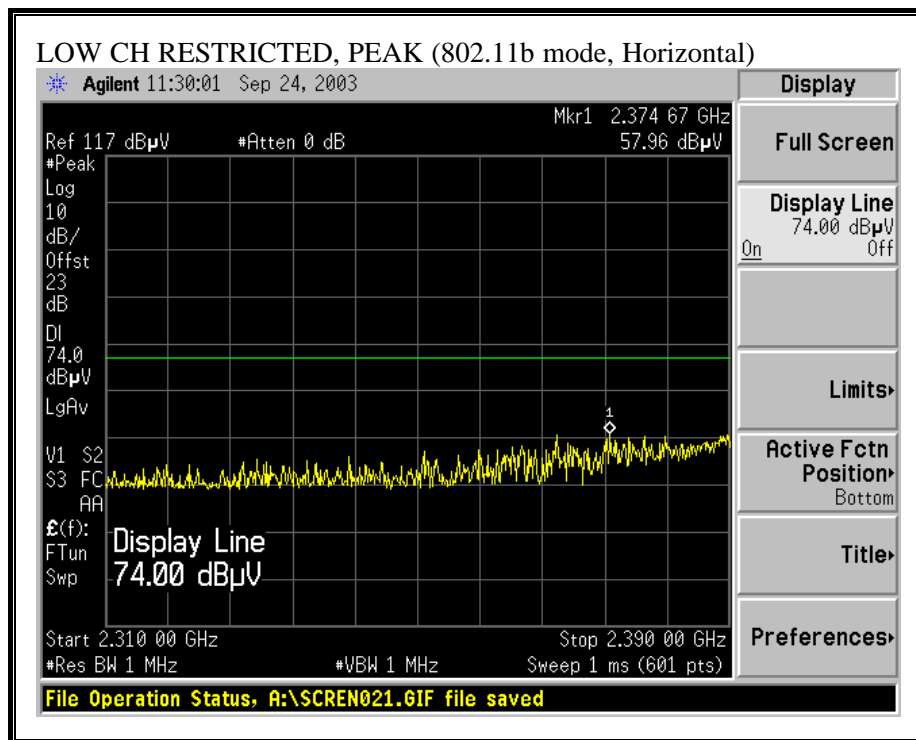

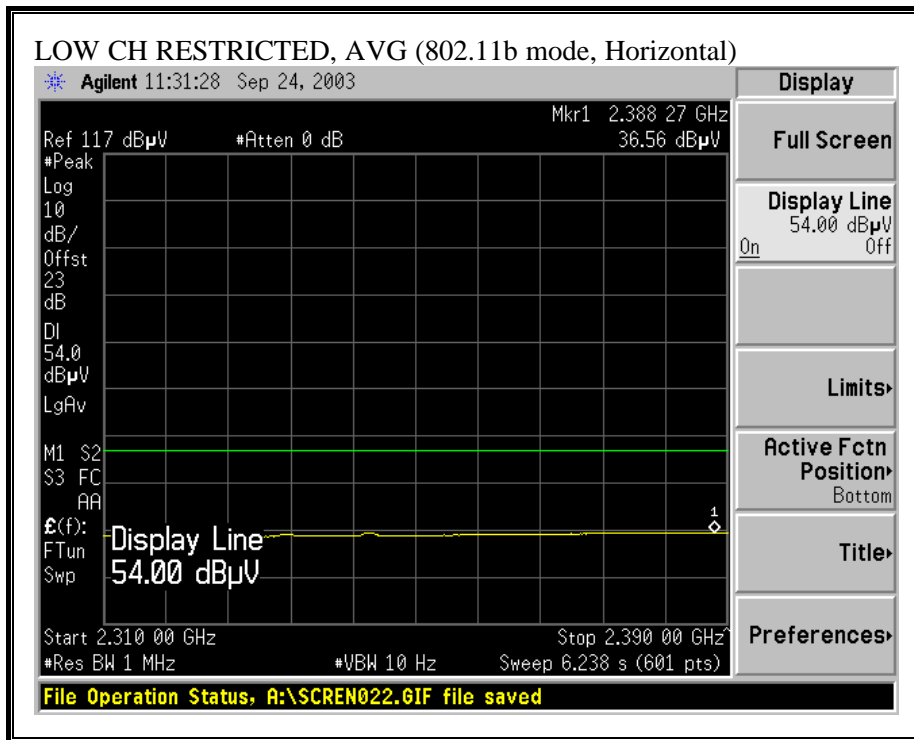

**RESTRICTED BANDEDGE (b MODE, LOW CHANNEL, VERTICAL)**

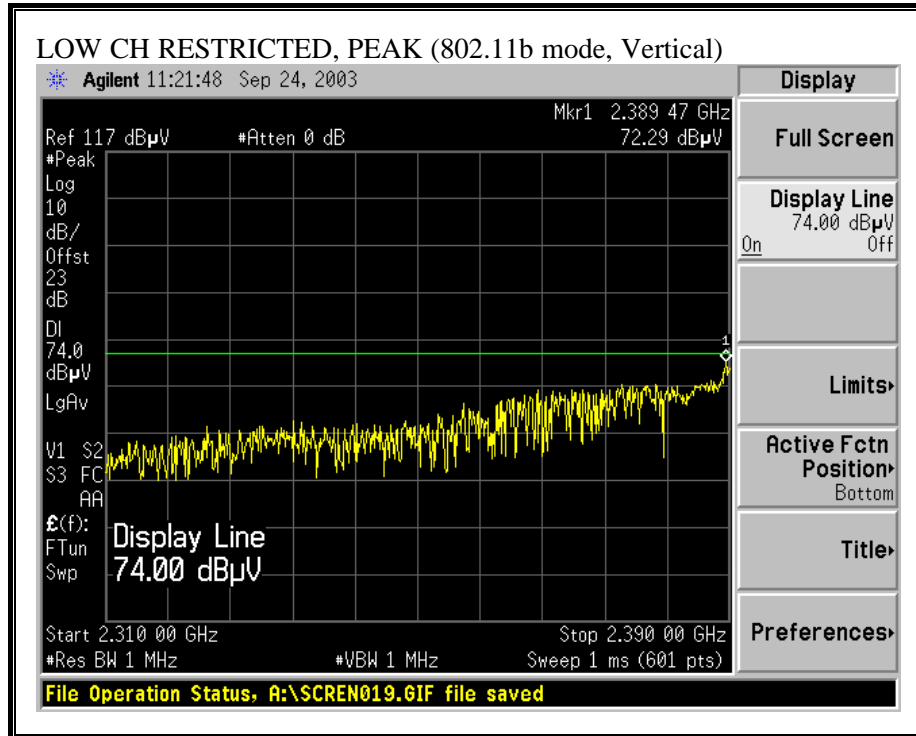



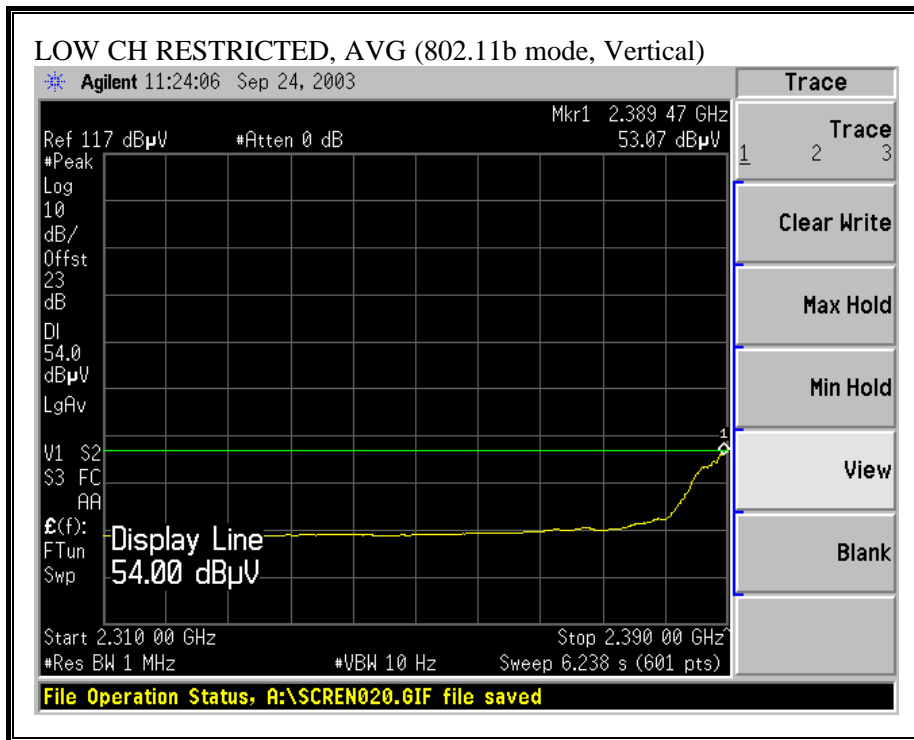

**RESTRICTED BANDEDGE (b MODE, HIGH CHANNEL, HORIZONTAL)**

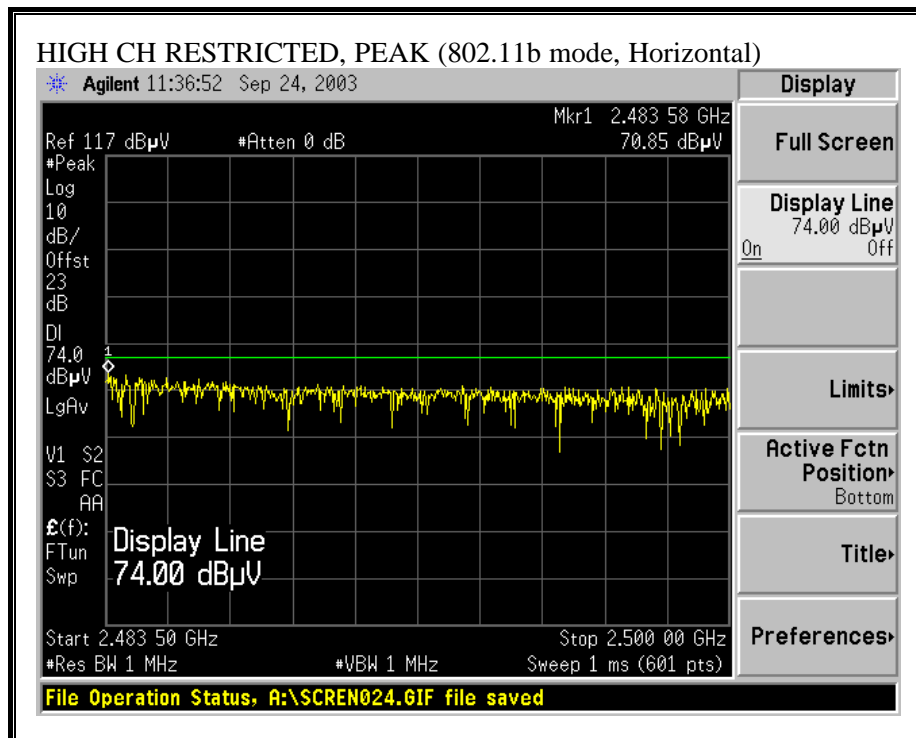

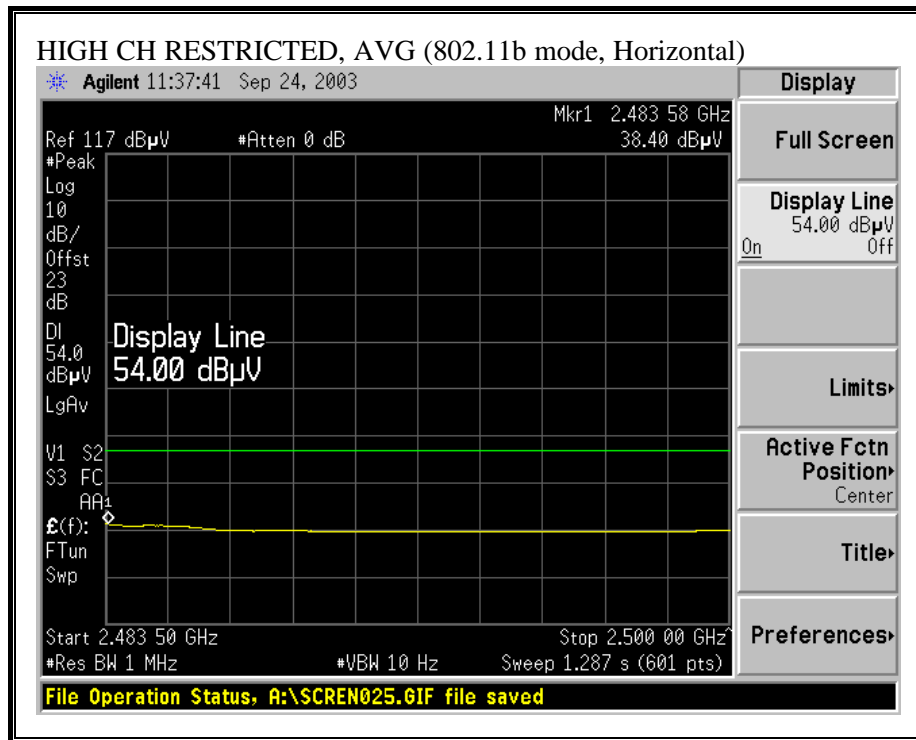

**RESTRICTED BANDEDGE (b MODE, HIGH CHANNEL, VERTICAL)**

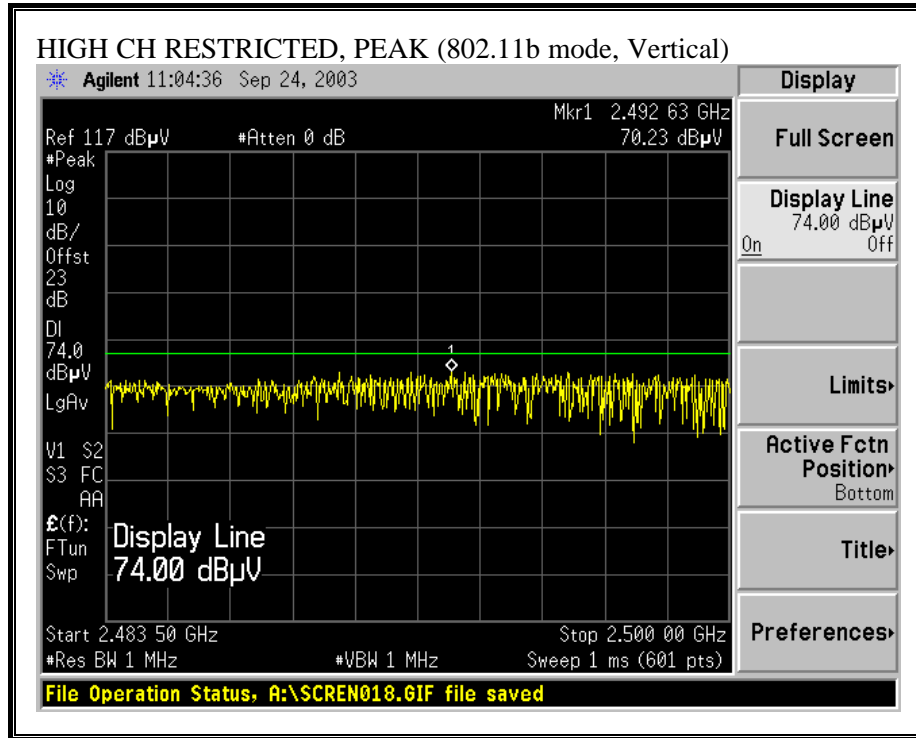

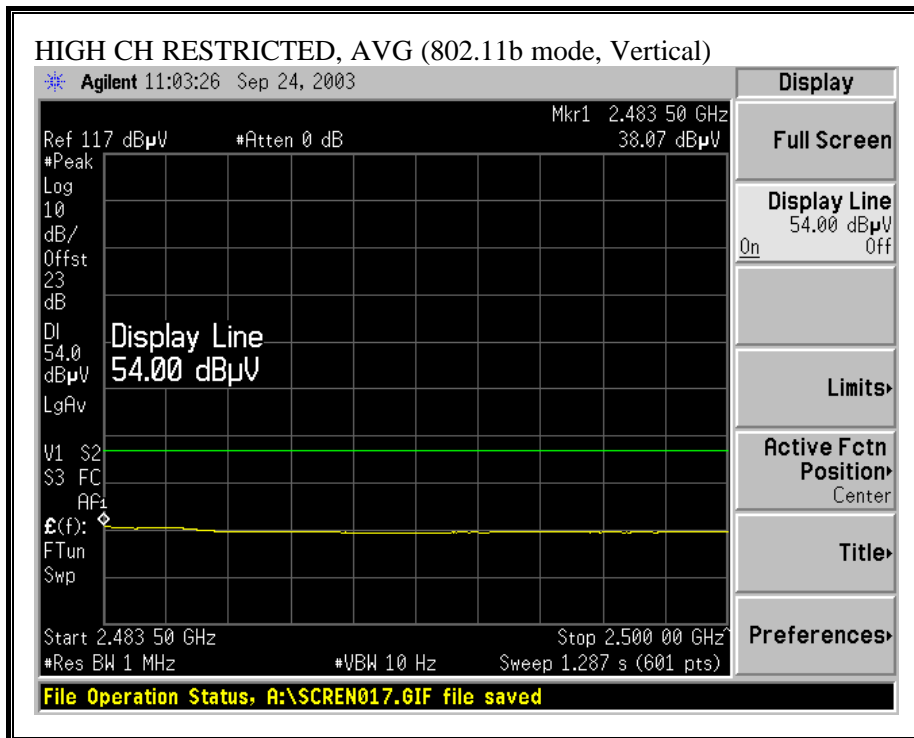

**HARMONICS AND SPURIOUS EMISSIONS (b MODE, LOW CHANNEL), TRANSMIT**

09/24/03 High Frequency Measurement  
 Compliance Certification Services, Morgan Hill Open Field Site

Test Engr: Yan Zheng  
 Project #: 03U2257  
 Company: Bourdon  
 EUT Descr.: 802.11b WLAN Mini PCI Card in PF2210  
 EUT M/N: BCM9-001MPL  
 Test Target: FCC CLASS B  
 Mode Oper: Transmit

Test Equipment:

EMCO Horn 1-18GHz T59; S/N: 3245 @1m	Pre-amplifier 1-26GHz TB7 Ming 924342	Spectrum Analyzer Agilent E4446A Analyzer	Horn > 18GHz T117; ARA 18-26GHz; S/N:1013	Limit FCC 15.205
---	--	--	--	---------------------

High Frequency Cables:  
 (2 ft)  (2 ~ 3 ft)  (4 ~ 6 ft)  (12 ft)

Peak Measurements: 1 MHz Resolution Bandwidth, 100Hz Video Bandwidth  
 Average Measurements: 1 MHz Resolution Bandwidth, 100Hz Video Bandwidth

f GHz	Dist feet	Read Pk dBuV	Read Avg dBuV	AF dB/m	CL dB	Amp dB	D Corr dB	HPF	Peak dBuV/m	Avg dBuV/m	Pk Lim dBuV/m	Avg Lim dBuV/m	Pk Mar dB	Avg Mar dB	Notes
Channel 1 (2412MHz)															
1.597	9.8	58.3	48.6	26.9	1.9	-43.3	0.0	1.0	44.8	27.1	74.0	54.0	-29.2	-26.9	H
1.597	9.8	58.8	48.6	26.9	1.9	-43.3	0.0	1.0	45.3	27.1	74.0	54.0	-28.7	-26.9	V
4.824	9.8	57.6	41.9	33.8	4.4	-44.7	0.0	1.0	52.1	36.3	74.0	54.0	-21.9	-17.7	H
4.824	9.8	57.9	42.9	33.8	4.4	-44.7	0.0	1.0	52.4	37.4	74.0	54.0	-21.6	-16.6	V
NO RADIATED EMISSION FOUND ABOVE 5GHz															

f	Measurement Frequency	Amp	Preamp Gain	Avg Lim	Average Field Strength Limit
Dist	Distance to Antenna	D Corr	Distance Correct to 3 meters	Pk Lim	Peak Field Strength Limit
Read	Analyzer Reading	Avg	Average Field Strength @ 3 m	Avg Mar	Margin vs. Average Limit
AF	Antenna Factor	Peak	Calculated Peak Field Strength	Pk Mar	Margin vs. Peak Limit
CL	Cable Loss	HPF	High Pass Filter		

**HARMONICS AND SPURIOUS EMISSIONS (b MODE, MID CHANNEL), TRANSMIT**

09/24/03 High Frequency Measurement  
 Compliance Certification Services, Morgan Hill Open Field Site

Test Eng: Yan Zheng  
 Project #: 03U2257  
 Company: Boardcon  
 EUT Descr: 802.11b WLAN Mini PCI Card in PP2210  
 EUT M/N: BC309-001MPL  
 Test Target: FCC CLASS B  
 Mode Oper: Transmit

Test Equipment:

EMCO Horn 1-18GHz TS91 S/N: 3245 @1m	Pre-amplifier 1-26GHz TB7 Mirq 924342	Spectrum Analyzer Agilent E4446A Analyzer	Horn > 18GHz TI17; ARA 18-26GHz; S/N:1013	Limit FCC 15.205
---	--	--	--	---------------------

RF Frequency Cables:  
 (0 ft)  (2 ~ 3 ft)  (4 ~ 6 ft)  (12 ft)

Peak Measurements: 1 MHz Resolution Bandwidth, 1MHz Video Bandwidth  
 Average Measurements: 1 MHz Resolution Bandwidth, 10Hz Video Bandwidth

f GHz	Dist feet	Read Pk dBuV	Read Avg dBuV	AF dB/m	CL dB	Amp dB	D Corr dB	HPF	Peak dBuV/m	Avg dBuV/m	Pk Lim dBuV/m	Avg Lim dBuV/m	Pk Mar dB	Avg Mar dB	Notes
Channel 6 (2437MHz)															
1.297	9.8	57.4	39.7	26.9	1.9	-43.3	0.0	1.0	43.9	26.2	74.0	54.0	-30.1	-27.8	H
1.297	9.8	58.5	39.3	26.9	1.9	-43.3	0.0	1.0	45.0	25.8	74.0	54.0	-29.0	-28.2	Y
4.874	9.8	57.3	41.4	33.8	4.4	-44.7	0.0	1.0	51.8	35.9	74.0	54.0	-22.2	-18.1	H
4.874	9.8	55.8	41.0	33.8	4.4	-44.7	0.0	1.0	50.3	35.5	74.0	54.0	-23.7	-19.5	Y
7.311	9.8	49.6	37.4	37.0	5.7	-44.5	0.0	1.0	48.7	36.5	74.0	54.0	-25.3	-17.5	H
7.311	9.8	50.0	37.3	37.0	5.7	-44.5	0.0	1.0	49.1	36.4	74.0	54.0	-24.9	-17.6	V
NO RADIATED EMISSION FOUND ABOVE 7.5GHz															

f Measurement Frequency      Amp Preamp Gain      Avg Lim Average Field Strength Limit  
 Dist Distance to Antenna      D Corr Distance Correct to 3 meters      Pk Lim Peak Field Strength Limit  
 Read Analyzer Reading      Avg Average Field Strength @ 3 m      Avg Mar Margin vs. Average Limit  
 AF Antenna Factor      Peak Calculated Peak Field Strength      Pk Mar Margin vs. Peak Limit  
 CL Cable Loss      HPF High Pass Filter

**HARMONICS AND SPURIOUS EMISSIONS (b MODE, HIGH CHANNEL), TRANSMIT**

09/24/03 High Frequency Measurement  
 Compliance Certification Services, Morgan Hill Open Field Site

Test Eng: Yan Zheng  
 Project #: 03U2257  
 Company: Boardcon  
 EUT Descr: 802.11b WLAN Mini PCI Card in PP2210  
 EUT M/N: BC309-001MPL  
 Test Target: FCC CLASS B  
 Mode Oper: Transmit

Test Equipment:

EMCO Horn 1-18GHz TS91 S/N: 3245 @1m	Pre-amplifier 1-26GHz TB7 Miniq 924342	Spectrum Analyzer Agilent E4446A Analyzer	Horn > 18GHz TI17; ARA 18-26GHz; S/N:1013	Limit FCC 15.205
---	---	--	--	---------------------

RF Frequency Cables:  
 (0 ft)  (2-3 ft)  (4-6 ft)  (12 ft)

Peak Measurements: 1 MHz Resolution Bandwidth, 1MHz Video Bandwidth  
 Average Measurements: 1 MHz Resolution Bandwidth, 10Hz Video Bandwidth

f GHz	Dist feet	Read Pk dBuV	Read Avg dBuV	AF dB/m	CL dB	Amp dB	D Corr dB	HPF	Peak dBuV/m	Avg dBuV/m	Pk Lim dBuV/m	Avg Lim dBuV/m	Pk Mar dB	Avg Mar dB	Notes
Channel 11 (2462MHz)															
1.297	9.8	53.9	38.6	26.9	1.9	-43.3	0.0	1.0	40.4	25.1	74.0	54.0	-33.6	-28.9	H
1.297	9.8	57.1	42.1	26.9	1.9	-43.3	0.0	1.0	43.6	28.6	74.0	54.0	-30.4	-25.4	Y
4.924	9.8	56.4	39.5	33.8	4.5	-44.8	0.0	1.0	50.9	34.0	74.0	54.0	-23.1	-20.0	H
4.924	9.8	57.1	41.9	33.8	4.5	-44.8	0.0	1.0	51.6	36.4	74.0	54.0	-22.4	-17.6	V
7.386	9.8	50.4	37.1	37.1	5.7	-44.5	0.0	1.0	49.7	36.4	74.0	54.0	-24.3	-17.6	H
7.386	9.8	49.8	37.4	37.1	5.7	-44.5	0.0	1.0	49.1	36.7	74.0	54.0	-24.9	-17.3	V
NO RADIATED EMISSION FOUND ABOVE 7.5GHz															

f Measurement Frequency      Amp Preamp Gain      Avg Lim Average Field Strength Limit  
 Dist Distance to Antenna      D Corr Distance Correct to 3 meters      Pk Lim Peak Field Strength Limit  
 Read Analyzer Reading      Avg Average Field Strength @ 3 m      Avg Mar Margin vs. Average Limit  
 AF Antenna Factor      Peak Calculated Peak Field Strength      Pk Mar Margin vs. Peak Limit  
 CL Cable Loss      HPF High Pass Filter



### 7.1.2. RADIATED EMISSIONS BELOW 1 GHZ

#### SPURIOUS EMISSIONS 30 TO 1000 MHz (WORST-CASE CONFIGURATION, HORIZONTAL)

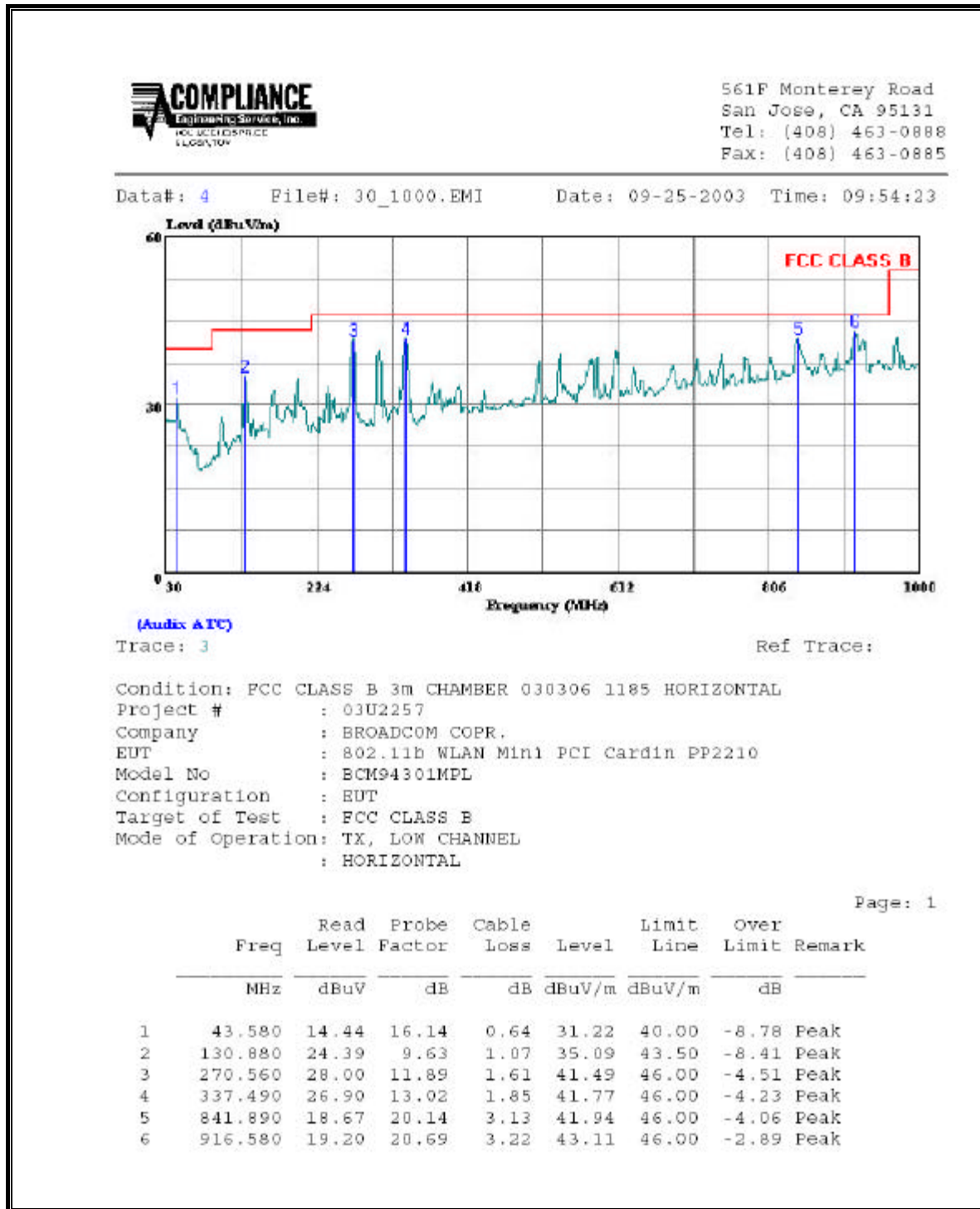

Data#: 4 File#: 30\_1000.EMI Date: 09-25-2003 Time: 09:54:23



561F Monterey Road  
 San Jose, CA 95131  
 Tel: (408) 463-0888  
 Fax: (408) 463-0885

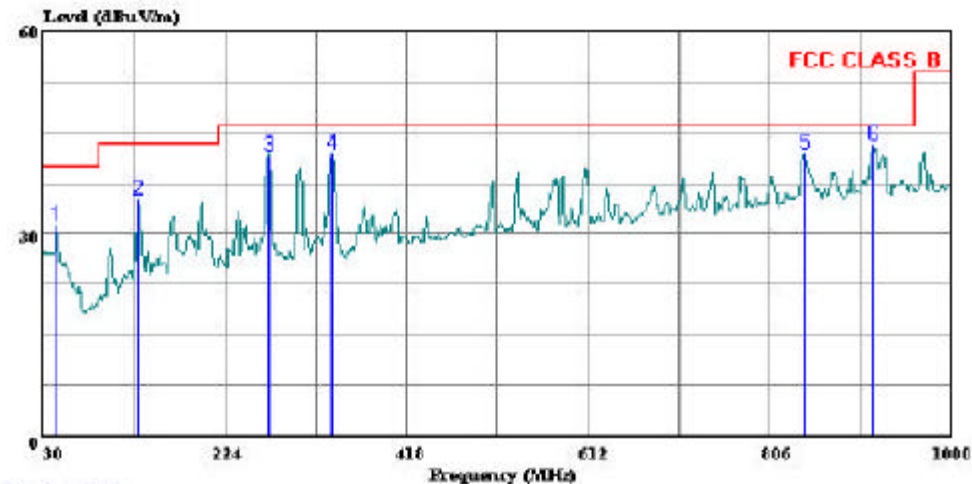

(Auxiliary A/C)

Trace: 3

Ref Trace:

Condition: FCC CLASS B 3m CHAMBER 030306 1185 HORIZONTAL  
 Project # : 03U2257  
 Company : BROADCOM COPR.  
 EUT : 802.11b WLAN Mini PCI Cardin PP2210  
 Model No : BCM94301MPL  
 Configuration : EUT  
 Target of Test : FCC CLASS B  
 Mode of Operation: TX, LOW CHANNEL  
 : HORIZONTAL

Page: 1

	Freq	Read Level	Probe Factor	Cable Loss	Level	Limit	Over Limit	Remark
	MHz	dBuV	dB	dB	dBuV/m	dBuV/m	dB	
1	43.580	14.44	16.14	0.64	31.22	40.00	-8.78	Peak
2	130.880	24.39	9.63	1.07	35.09	43.50	-8.41	Peak
3	270.560	28.00	11.89	1.61	41.49	46.00	-4.51	Peak
4	337.490	26.90	13.02	1.85	41.77	46.00	-4.23	Peak
5	841.890	18.67	20.14	3.13	41.94	46.00	-4.06	Peak
6	916.580	19.20	20.69	3.22	43.11	46.00	-2.89	Peak

**SPURIOUS EMISSIONS 30 TO 1000 MHz (WORST-CASE CONFIGURATION, VERTICAL)**



561F Monterey Road  
 San Jose, CA 95131  
 Tel: (408) 463-0888  
 Fax: (408) 463-0885

Data#: 2 File#: 30\_1000.EMI Date: 09-25-2003 Time: 09:43:43

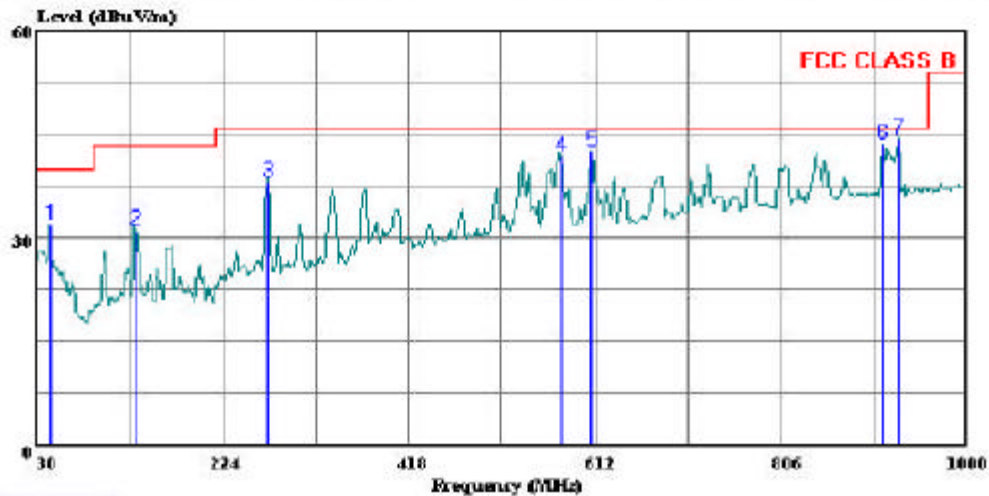

(Auxiliary ATC)

Trace: 1

Ref Trace:

Condition: FCC CLASS B 3m CHAMBER 030306 1185 VERTICAL  
 Project # : 03U2257  
 Company : BROADCOM COPR.  
 EUT : 802.11b WLAN Mini PCI Cardin PP2210  
 Model No : BCM94301MPL  
 Configuration : EUT  
 Target of Test : FCC CLASS B  
 Mode of Operation: TX, LOW CHANNEL  
 : VERTICAL

Page: 1

	Freq	Read Level	Probe Factor	Cable Loss	Level	Limit	Over Limit	Remark
	MHz	dBuV	dB	dB	dBuV/m	dBuV/m	dB	
1	44.550	15.26	16.04	0.65	31.94	40.00	-8.06	Peak
2	132.820	20.59	9.48	1.10	31.16	43.50	-12.34	Peak
3	270.560	24.57	11.89	1.61	38.07	46.00	-7.93	Peak
4	577.080	21.74	17.45	2.53	41.72	46.00	-4.28	Peak
5	609.090	22.23	17.78	2.55	42.56	46.00	-3.44	Peak
6	911.730	19.66	20.66	3.24	43.56	46.00	-2.44	Peak
7	929.190	20.36	20.77	3.26	44.39	46.00	-1.61	Peak

## 7.2. POWERLINE CONDUCTED EMISSIONS

### LIMIT

§15.207 (a) Except as shown in paragraphs (b) and (c) of this section, for an intentional radiator that is designed to be connected to the public utility (AC) power line, the radio frequency voltage that is conducted back onto the AC power line on any frequency or frequencies within the band 150 kHz to 30 MHz shall not exceed the limits in the following table, as measured using a 50  $\mu$ H/50 ohms line impedance stabilization network (LISN). Compliance with the provisions of this paragraph shall be based on the measurement of the radio frequency voltage between each power line and ground at the power terminal.

The lower limit applies at the boundary between the frequency ranges.

Frequency of Emission (MHz)	Conducted Limit (dBuV)	
	Quasi-peak	Average
0.15-0.5	66 to 56	56 to 46
0.5-5	56	46
5-30	60	50

\*Decreases with the logarithm of the frequency.

### TEST PROCEDURE

The EUT is placed on a non-conducting table 40 cm from the vertical ground plane and 80 cm above the horizontal ground plane. The EUT is configured in accordance with ANSI C63.4.

The resolution bandwidth is set to 9 kHz for both peak detection and quasi-peak detection measurements. Peak detection is used unless otherwise noted as quasi-peak.

Line conducted data is recorded for both NEUTRAL and HOT lines.

### RESULTS

No non-compliance noted:

**6 WORST EMISSIONS**

CONDUCTED EMISSIONS DATA									
Freq. (MHz)	Reading			Class (dB)	Limit QP	EN B AV	Margin		Remark L1 / L2
	PK (dBuV)	QP (dBuV)	AV (dBuV)				QP (dB)	AV (dB)	
0.63	40.16	--	--	0.00	56.00	46.00	-15.84	-5.84	L1
0.75	40.84	--	--	0.00	56.00	46.00	-15.16	-5.16	L1
0.99	40.94	--	--	0.00	56.00	46.00	-15.06	-5.06	L1
0.65	44.27	--	--	0.00	56.00	46.00	-11.73	-1.73	L2
0.72	43.99	--	--	0.00	56.00	46.00	-12.01	-2.01	L2
0.98	45.32	--	--	0.00	56.00	46.00	-10.68	-0.68	L2
6 Worst Data									

**LINE 1 AND LINE 2 RESULTS**

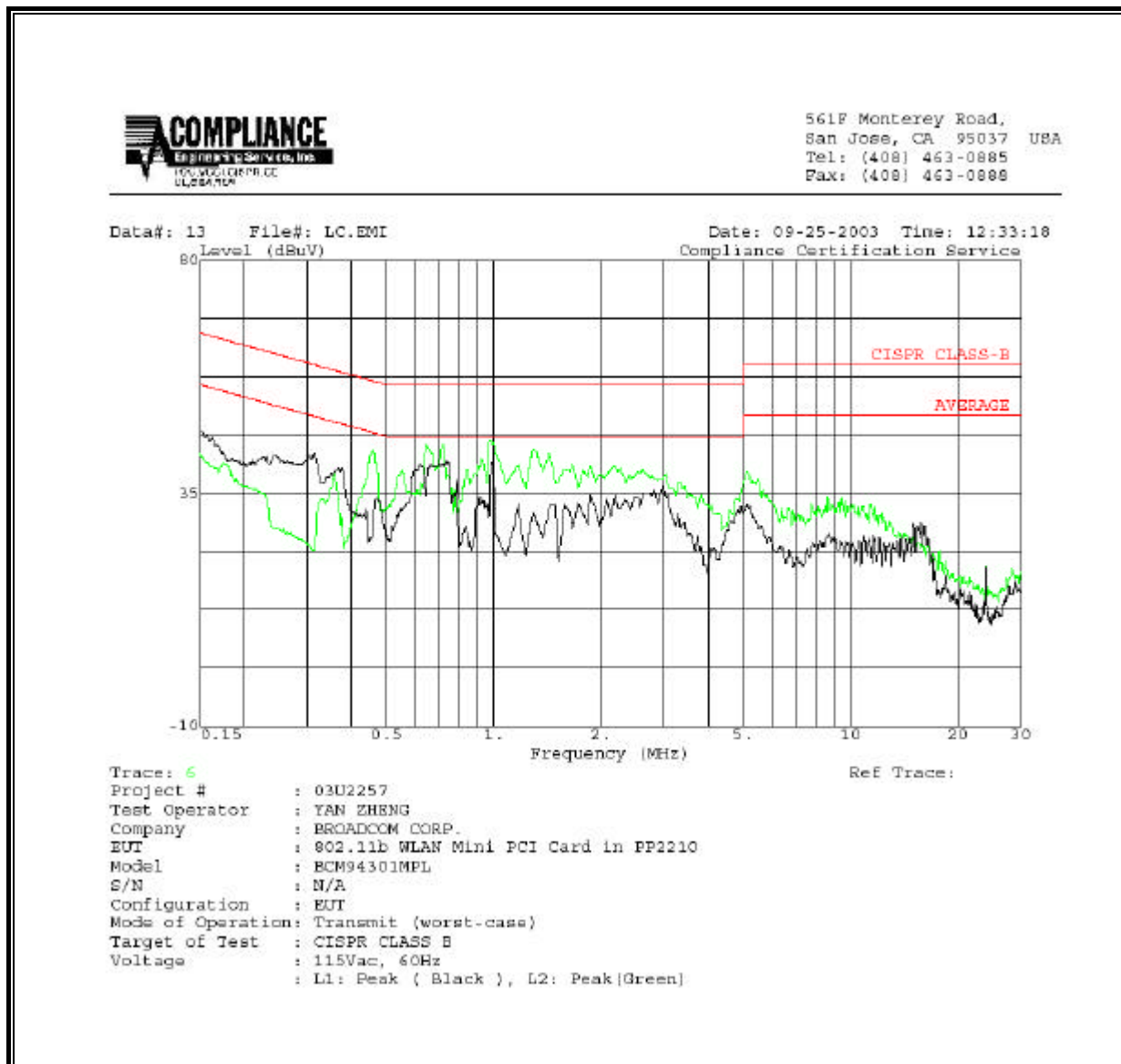

## 8. SETUP PHOTOS

### RADIATED RF MEASUREMENT SETUP



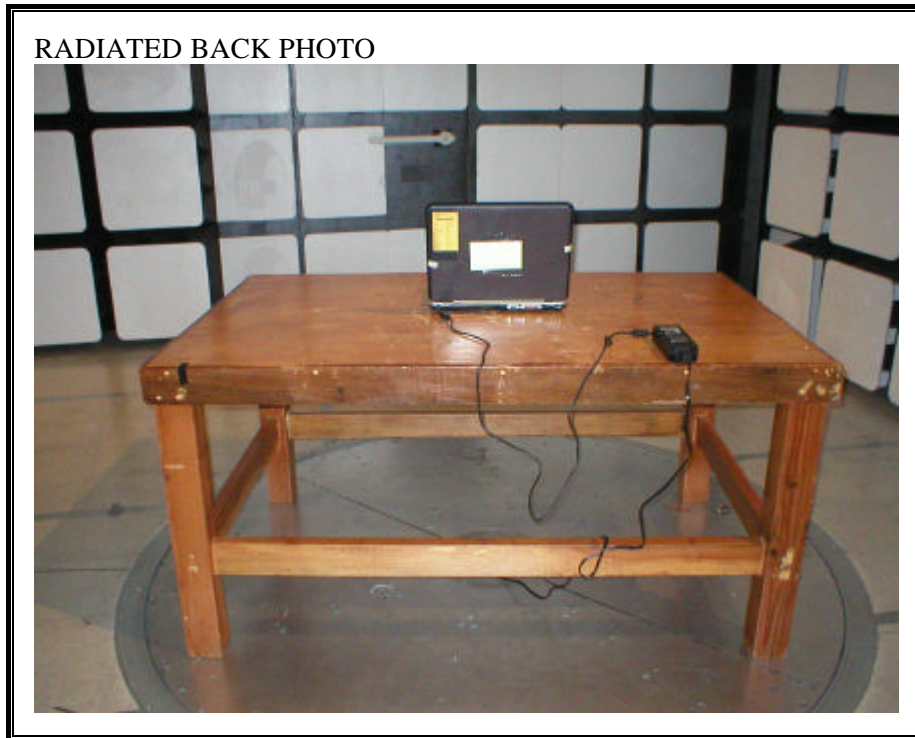

**POWERLINE CONDUCTED EMISSIONS MEASUREMENT SETUP**





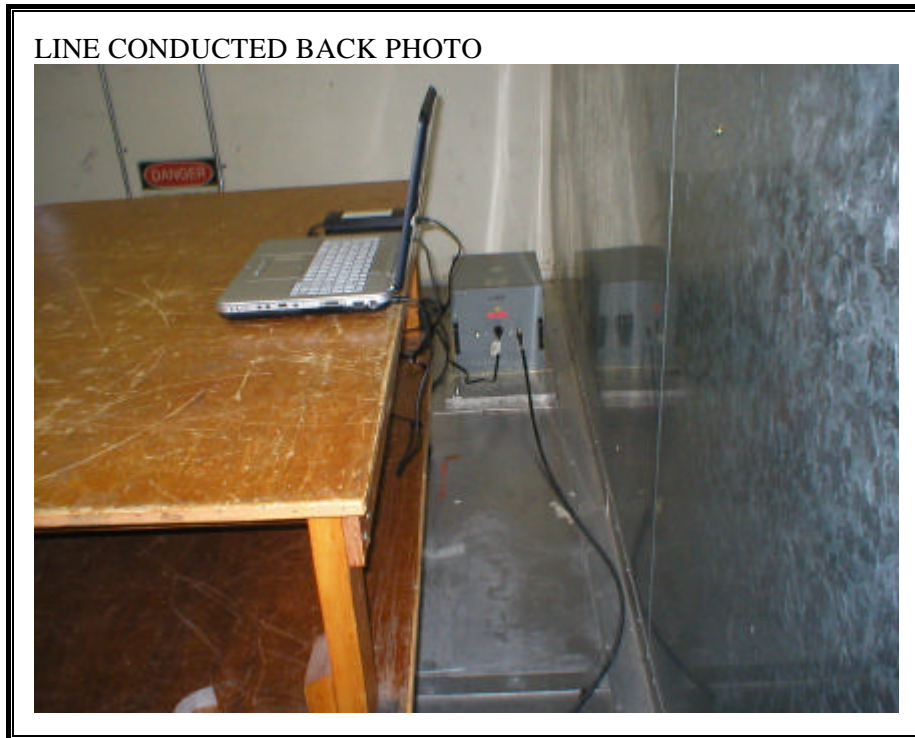

**END OF REPORT**