





# TEST REPORT

<p><b>KCTL Inc.</b> 65, Sinwon-ro, Yeongtong-gu, Suwon-si, Gyeonggi-do, 16677, Korea Tel: 82-31-285-0894 Fax: 82-505-299-8311 <a href="http://www.kctl.co.kr">www.kctl.co.kr</a></p>	<p>Report No.: KR17-SPF0002 Page (1) of (50)</p>	
<p><b>1. Client</b></p> <ul style="list-style-type: none"> <li>◦ Name : IRIVER LIMITED</li> <li>◦ Address : Iriverhouse, 5, Bangbae-ro 18-gil, Seocho-gu, Seoul, Korea</li> <li>◦ Date of Receipt : 2017-02-13</li> </ul> <p><b>2. Name of Product and Model</b> : AK KANN / PPM41</p> <p><b>Variant Model</b> : -</p> <p><b>3. Manufacturer and Country of Origin</b> : IRIVER LIMITED / Korea</p> <p><b>4. Date of Test</b> : 2017-03-23</p> <p><b>5. FCC ID</b> : QDMPPM41</p> <p><b>6. FCC Rule Part</b> : CFR §2.1093</p> <p><b>7. Test method used</b> : IEEE 1528-2013, ANSI/IEEE C95.1, KDB Publication</p> <p><b>8. Test Results</b> : Refer to the test result in the test report</p>		
<p>Affirmation</p>	<p>Tested by  Name : Gyuhyun, Shim (Signature)</p>	<p>Technical Manager  Name : Cheonsig, Choi (Signature)</p>
<p style="text-align: right;">2017-04-04</p> <p style="text-align: center;"><b>KCTL Inc.</b></p> <p>As a test result of the sample which was submitted from the client, this report does not guarantee the whole product quality. This test report should not be used and copied without a written agreement by KCTL Inc.</p>		

**KCTL Inc.**

65, Sinwon-ro, Yeongtong-gu,  
Suwon-si, Gyeonggi-do, 16677, Korea  
Tel : 82-31-285-0894 Fax : 82-505-299-8311  
[www.kctl.co.kr](http://www.kctl.co.kr)

Report No.:  
KR17-SPF0002

Page (2) of (50)

**REPORT REVISION HISTORY**

Date	Revision	Page No
2017-04-04	Originally issued	-

*This report shall not be reproduced except in full, without the written approval of KCTL Inc. This document may be altered or revised by KCTL Inc. personnel only, and shall be noted in the revision section of the document. Any alteration of this document not carried out by KCTL Inc. will constitute fraud and shall nullify the document.*

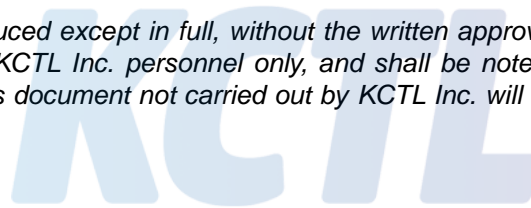

**KCTL Inc.**

65, Sinwon-ro, Yeongtong-gu,  
Suwon-si, Gyeonggi-do, 16677, Korea  
Tel : 82-31-285-0894 Fax : 82-505-299-8311  
[www.kctl.co.kr](http://www.kctl.co.kr)

Report No.:  
KR17-SPF0002

Page (3) of (50)



## Contents

1. Client information .....	4
2. Laboratory information .....	5
3. Identification of Sample .....	6
4. Test Result Summary .....	8
5. Report Overview.....	8
6. Test Lab Declaration or Comments .....	8
7. Applicant Declaration or Comments.....	8
8. Measurement Uncertainty .....	9
9. The SAR Measurement System.....	10
10. System Verification.....	14
11. Operation Configurations.....	16
12. SAR Measurement Procedures .....	17
13. Test Equipment Information .....	19
14. RF Average Conducted Output Power .....	20
15. SAR Test Exclusions Applied .....	21
16. SAR Test Results .....	22
17. Test System Verification Results .....	23
18. Test Results .....	24
Appendix A. Calibration certificate .....	25
Appendix B. EUT Photo .....	44
Appendix C. Test Photo.....	47

**KCTL Inc.**

65, Sinwon-ro, Yeongtong-gu,  
Suwon-si, Gyeonggi-do, 16677, Korea  
Tel : 82-31-285-0894 Fax : 82-505-299-8311  
[www.kctl.co.kr](http://www.kctl.co.kr)

Report No.:  
KR17-SPF0002

Page (4) of (50)

**KCTL**

## 1. Client information

**Client:** IRIVER LIMITED

**Address:** Iriverhouse, 5, Bangbae-ro 18-gil, Seocho-gu, Seoul, Korea

**Telephone:** 82-2-3019-7514

**Fax:** 82-2-3019-7575

**E-mail:** dabin.wang@iriver.com

**Contact name:** Dabin, Wang

**Manufacturer:** IRIVER LIMITED

**Address:** Iriverhouse, 5, Bangbae-ro 18-gil, Seocho-gu, Seoul, Korea

## KCTL Inc.

65, Sinwon-ro, Yeongtong-gu,  
Suwon-si, Gyeonggi-do, 16677, Korea  
Tel : 82-31-285-0894 Fax : 82-505-299-8311  
[www.kctl.co.kr](http://www.kctl.co.kr)

Report No.:  
KR17-SPF0002

Page (5) of (50)

# KCTL

## 2. Laboratory information

### Address

**KCTL Inc.**

65, Sinwon-ro, Yeongtong-gu, Suwon-si, Gyeonggi-do, Korea

TEL: 82-31-285-0894 FAX: 82-505-299-8311

### Certificate

KOLAS No.: KT231

FCC Site Designation No.: KR0040

FCC Site Registration No.: 687132

VCCI Site Registration No.: R-3327, G-198, C-3706, T-1849

IC Site Registration No.: 8035A-2

### SITE MAP

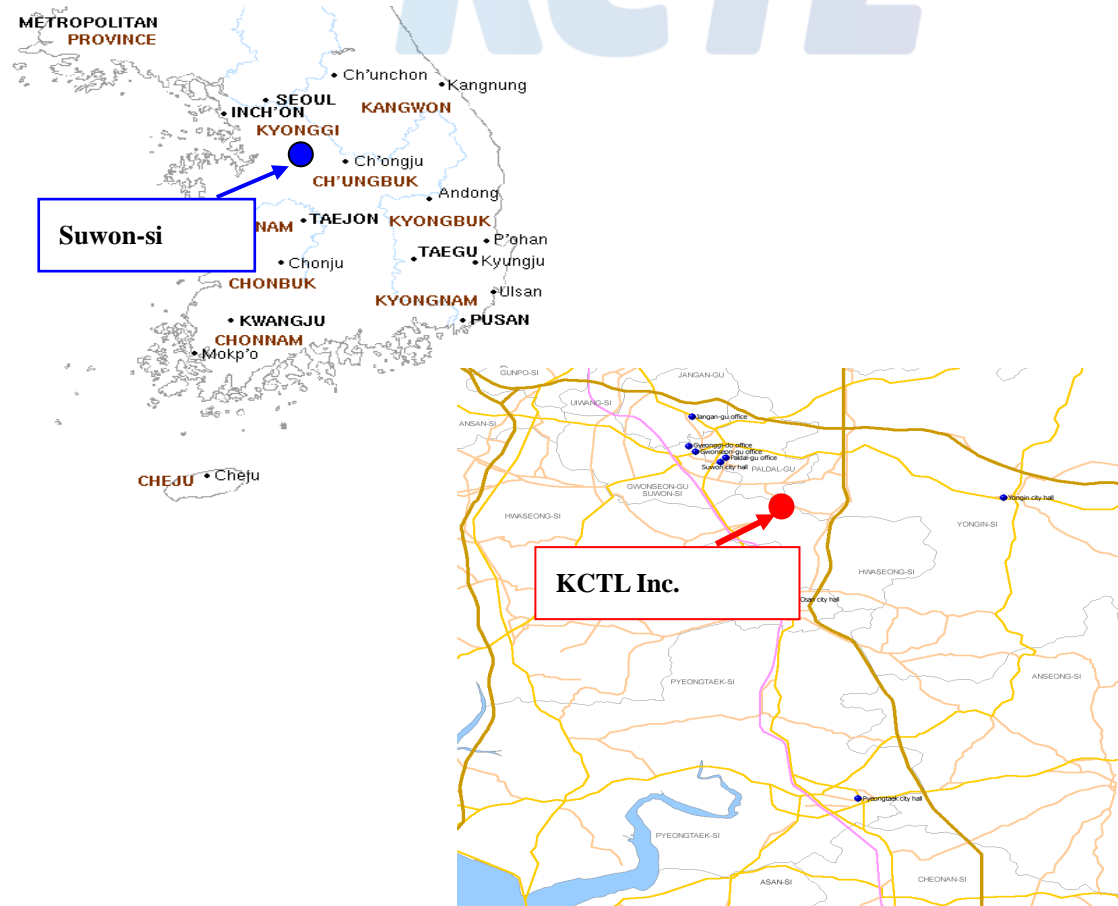

This test report shall not be reproduced, except in full, without the written approval.

KCTL-TIA002-004/1

**KCTL Inc.**

65, Sinwon-ro, Yeongtong-gu,  
Suwon-si, Gyeonggi-do, 16677, Korea  
Tel : 82-31-285-0894 Fax : 82-505-299-8311  
[www.kctl.co.kr](http://www.kctl.co.kr)

Report No.:  
KR17-SPF0002

Page (6) of (50)



### 3. Identification of Sample

EUT Type	AK KANN
Brand Name	IRIVER LIMITED
Mode of Operation	WLAN 802.11b/g/n, Bluetooth
Model Number	PPM41
Serial Number	N/A
Max. Power	15.5 dBm
Tx Freq.Range	2 412 ~ 2 462 MHz
Rx Freq.Range	2 412 ~ 2 462 MHz
Antenna Type	PCB Type
Antenna Size	22.4 mm x 4.6 mm
Normal Voltage	DC 3.7 V
H/W Version	ES
S/W Version	ENG.0.530

### 3.1 Antenna Diagram

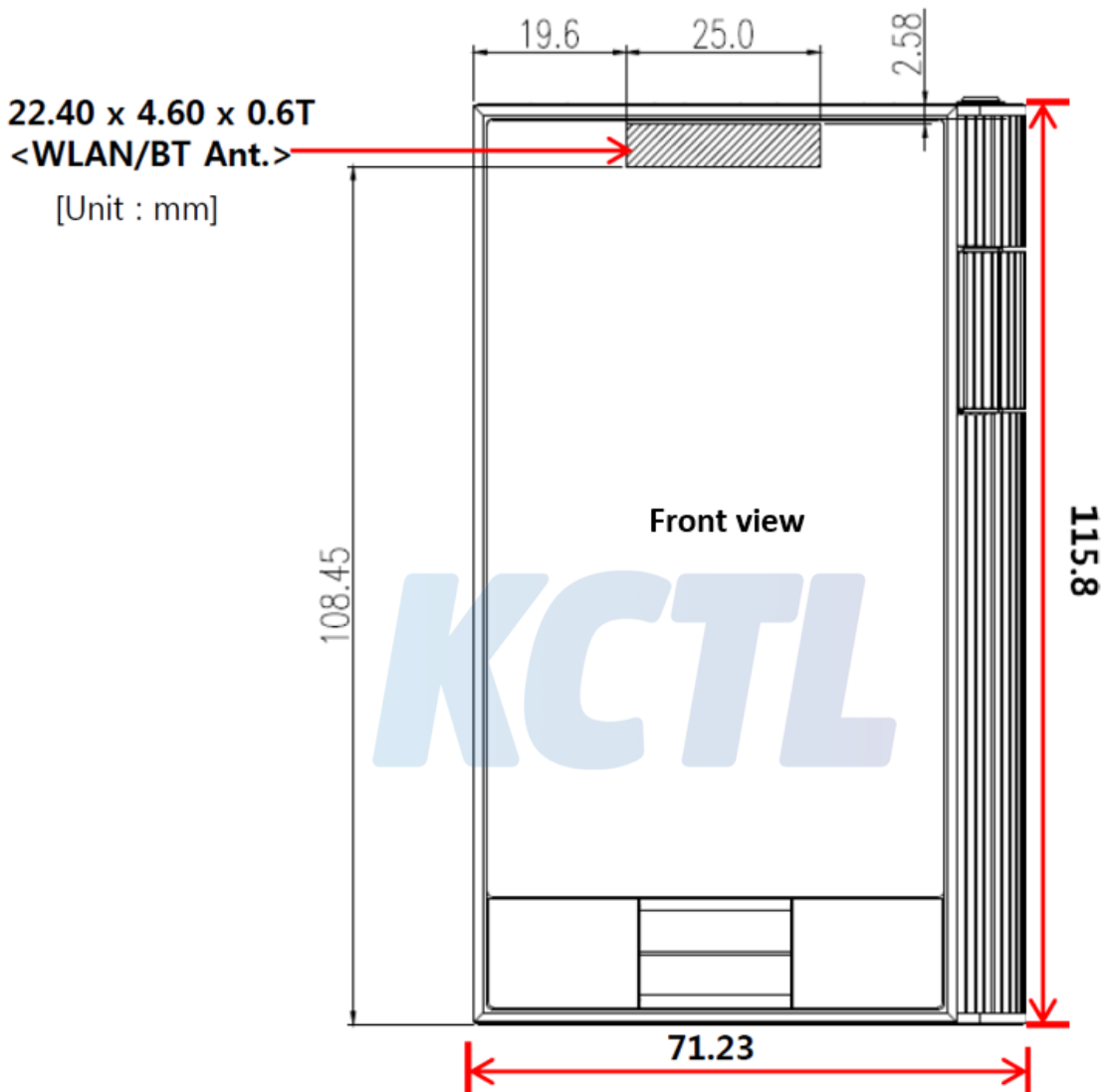

**KCTL Inc.**

65, Sinwon-ro, Yeongtong-gu,  
Suwon-si, Gyeonggi-do, 16677, Korea  
Tel : 82-31-285-0894 Fax : 82-505-299-8311  
[www.kctl.co.kr](http://www.kctl.co.kr)

Report No.:  
KR17-SPF0002

Page (8) of (50)



## 4. Test Result Summary

### 4.1 Body SAR

Frequency		Average Power (dBm)	Max. tune up power (dBm)	Scaling Factor	EUT Position	Separation Distance (mm)	Measured 1 g SAR (W/kg)	Scaled 1 g SAR (W/kg)
MHz	Ch.							
2 462	11	13.62	15.50	1.542	Top	5	0.256	<b>0.395</b>

\* Contain the results of the worst test SAR including battery.

## 5. Report Overview

This report details the results of testing carried out on the samples listed in section 3, the results contained in this test report do not relate to other samples of the same product. The manufacturer should ensure that all products in series production are in conformity with the product sample detailed in this report.

This report may only be reproduced and distributed in full. If the product in this test report is used in any configuration other than that detailed in the test report, the manufacturer must ensure the new configuration complies with all relevant standards and certification requirements. Any mention of KCTL Inc. Wireless lab or testing done by KCTL Inc. Wireless lab made in connection with the distribution or use of the tested product must be approved in writing by KCTL Inc. Wireless lab.

## 6. Test Lab Declaration or Comments

None

## 7. Applicant Declaration or Comments

None



**KCTL Inc.**

65, Sinwon-ro, Yeongtong-gu,  
Suwon-si, Gyeonggi-do, 16677, Korea  
Tel : 82-31-285-0894 Fax : 82-505-299-8311  
[www.kctl.co.kr](http://www.kctl.co.kr)

Report No.:  
KR17-SPF0002

Page (9) of (50)



## 8. Measurement Uncertainty

All measurements and results are recorded and maintained at the laboratory performing the tests and measurement uncertainties are taken into account when comparing measurements to pass/ fail criteria.

### Uncertainty of SAR equipments for measurement 300 MHz to 3 GHz (Body)

<i>A</i>	<i>b</i>	<i>c</i>	<i>D</i>	<i>e = f(d,k)</i>	<i>g</i>	<i>i = c x g / e</i>	<i>k</i>
Source of Uncertainty	Description IEEE P1528 BODY (0.3 ~ 3 GHz)	Tolerance/ Uncertainty value ± %	Probability Distribution	Div.	Ci	Standard uncertainty	Vi or Veff
	(1 g)	± %, (1 g)					
<b>Measurement System</b>							
Probe calibration(k=1)	E.2.1	6.30	N	1	1	6.30	∞
Axial isotropy	E.2.2	0.50	R	1.73	0.71	0.20	∞
Hemispherical isotropy	E.2.2	2.60	R	1.73	0.71	1.06	∞
Linearity	E.2.4	0.60	R	1.73	1	0.35	∞
Boundary effect	E.2.3	1.00	R	1.73	1	0.58	∞
System detection limits	E.2.5	1.00	R	1.73	1	0.58	∞
Readout electronics	E.2.6	0.30	N	1	1	0.30	∞
Response time	E.2.7	0.80	R	1.73	1	0.46	∞
Integration time	E.2.8	2.60	R	1.73	1	1.50	∞
RF ambient conditions—noise	E.6.1	3.00	R	1.73	1	1.73	∞
RF ambient conditions— reflections	E.6.1	3.00	R	1.73	1	1.73	∞
Probe positioner mechanical tolerance	E.6.2	0.40	R	1.73	1	0.23	∞
Probe positioning with respect to phantom shell	E.6.3	2.90	R	1.73	1	1.67	∞
Extrapolation, interpolation, and integration algorithms for max. SAR evaluation	E.5	2.00	R	1.73	1	1.15	∞
<b>Test Sample Related</b>							
Test sample positioning	E.4.2	4.71	N	1	1	4.71	9
Device holder uncertainty	E.4.1	3.60	N	1	1	3.60	5
Output power variation—SAR drift measurement	6.6.2	5.00	R	1.73	1	2.89	∞
<b>Phantom and Tissue Parameters</b>							
Phantom uncertainty (shape and thickness tolerances)	E.3.1	7.50	R	1.73	1	4.33	∞
Liquid conductivity-measurement uncertainty	E.3.3	1.53	N	1	0.64	0.98	5
Liquid permittivity-measurement uncertainty	E.3.3	3.07	N	1	0.6	1.84	5
Liquid conductivity-deviation from target values	E.3.2	5.00	R	1.73	0.64	1.85	∞
Liquid permittivity-deviation from target values	E.3.2	5.00	R	1.73	0.6	1.73	∞
Combined standard uncertainty				RSS		11.29	183
Expanded uncertainty (95% CONFIDENCE INTERVAL)				K=2		22.57	

This test report shall not be reproduced, except in full, without the written approval.

## 9. The SAR Measurement System

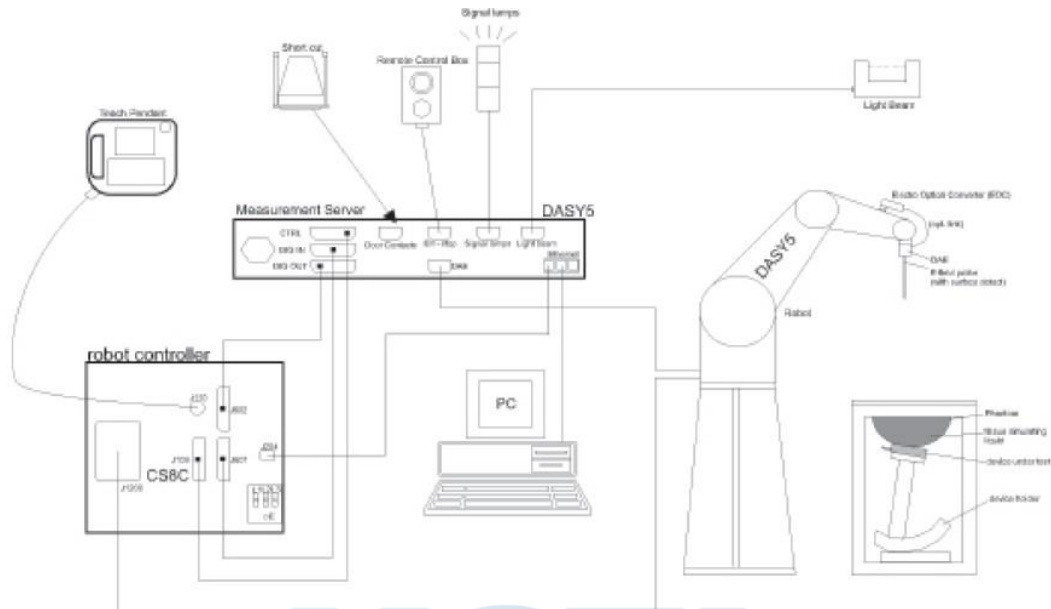

### <SAR System Configuration>

- A standard high precision 6-axis robot with controller, teach pendant and software. An arm extension for accommodating the data acquisition electronics (DAE).
- An isotropic Field probe optimized and calibrated for the targeted measurement.
- Data acquisition electronics (DAE) which performs the signal amplification, signal multiplexing, AD-conversion, offset measurements, mechanical surface detection, collision detection, etc. The unit is battery powered with standard or rechargeable batteries. The signal is optically transmitted to the EOC.
- The Electro-optical converter (EOC) performs the conversion from optical to electrical signals for the digital communication to the DAE. To use optical surface detection, a special version of the EOC is required. The EOC signal is transmitted to the measurement server.
- The function of the measurement server is to perform the time critical tasks such as signal filtering, control of the robot operation and fast movement interrupts.
- The Light Beam used is for probe alignment. This improves the (absolute) accuracy of the probe positioning.
- A computer running WinXP or Win7 and the DASY5 software.
- Remote control and teach pendant as well as additional circuitry for robot safety such as warning lamps, etc.
- The phantom, the device holder and other accessories according to the targeted measurement.

**KCTL Inc.**

65, Sinwon-ro, Yeongtong-gu,  
Suwon-si, Gyeonggi-do, 16677, Korea  
Tel : 82-31-285-0894 Fax : 82-505-299-8311  
[www.kctl.co.kr](http://www.kctl.co.kr)

Report No.:  
KR17-SPF0002

Page (11) of (50)

**KCTL****9.1 Isotropic E-field Probe**

<b>ES3DV3 Isotropic E-Field Probe for Dosimetric Measurements</b>	
	Symmetrical design with triangular core Interleaved sensors Built-in shielding against static charges PEEK enclosure material (resistant to organic solvents, e.g., DGBE)
<b>Calibration</b>	ISO/IEC 17025 <a href="#">calibration service</a> available.
<b>Frequency</b>	10 MHz to 4 GHz; Linearity: $\pm 0.2$ dB (30 MHz to 4 GHz)
<b>Directivity</b>	$\pm 0.2$ dB in TSL (rotation around probe axis) $\pm 0.3$ dB in TSL (rotation normal to probe axis)
<b>Dynamic Range</b>	5 $\mu$ W/g to > 100 mW/g; Linearity: $\pm 0.2$ dB
<b>Dimensions</b>	Overall length: 337 mm (Tip: 20 mm) Tip diameter: 3.9 mm (Body: 12 mm) Distance from probe tip to dipole centers: 2.0 mm
<b>Application</b>	General dosimetry up to 4 GHz Dosimetry in strong gradient fields Compliance tests of mobile phones
<b>Compatibility</b>	DASY3, DASY4, DASY52 SAR and higher, EASY4/MRI

<b>EX3DV4 Smallest Isotropic E-Field Probe for Dosimetric Measurements (Preliminary Specifications)</b>	
	Symmetrical design with triangular core Built-in shielding against static charges PEEK enclosure material (resistant to organic solvents, e.g., DGBE)
<b>Calibration</b>	ISO/IEC 17025 <a href="#">calibration service</a> available.
<b>Frequency</b>	10 MHz to > 6 GHz Linearity: $\pm 0.2$ dB (30 MHz to 6 GHz)
<b>Directivity</b>	$\pm 0.3$ dB in TSL (rotation around probe axis) $\pm 0.5$ dB in TSL (rotation normal to probe axis)
<b>Dynamic Range</b>	10 $\mu$ W/g to > 100 mW/g Linearity: $\pm 0.2$ dB (noise: typically < 1 $\mu$ W/g)
<b>Dimensions</b>	Overall length: 337 mm (Tip: 20 mm) Tip diameter: 2.5 mm (Body: 12 mm) Typical distance from probe tip to dipole centers: 1 mm
<b>Application</b>	High precision dosimetric measurements in any exposure scenario (e.g., very strong gradient fields); the only probe that enables compliance testing for frequencies up to 6 GHz with precision of better 30%.
<b>Compatibility</b>	DASY3, DASY4, DASY52 SAR and higher, EASY4/MRI

**KCTL Inc.**

65, Sinwon-ro, Yeongtong-gu,  
Suwon-si, Gyeonggi-do, 16677, Korea  
Tel : 82-31-285-0894 Fax : 82-505-299-8311  
[www.kctl.co.kr](http://www.kctl.co.kr)

Report No.:  
KR17-SPF0002

Page (12) of (50)

**KCTL**

## 9.2 Phantom

<b>Twin SAM</b>	
	<p>The shell corresponds to the specifications of the Specific Anthropomorphic Mannequin (SAM) phantom defined in IEEE 1528 and IEC 62209-1. It enables the dosimetric evaluation of left and right hand phone usage as well as body mounted usage at the flat phantom region. A cover prevents evaporation of the liquid. Reference markings on the phantom allow the complete setup of all predefined phantom positions and measurement grids by teaching three points with the robot.</p> <p>Twin SAM V5.0 has the same shell geometry and is manufactured from the same material as Twin SAM V4.0, but has reinforced top structure.</p>
<b>Material</b>	Vinylester, glass fiber reinforced (VE-GF)
<b>Liquid Compatibility</b>	Compatible with all SPEAG tissue simulating liquids (incl. DGBE type)
<b>Shell Thickness</b>	2 ± 0.2 mm (6 ± 0.2 mm at ear point)
<b>Dimensions (incl. Wooden Support)</b>	Length: 1000 mm Width: 500 mm Height: adjustable feet
<b>Filling Volume</b>	approx. 25 liters
<b>Wooden Support</b>	SPEAG standard phantom table
<b>Accessories</b>	<a href="#">Mounting Device and Adaptors</a>

<b>ELI</b>	
	<p>Phantom for compliance testing of handheld and body-mounted wireless devices in the frequency range of 30 MHz to 6 GHz. ELI is fully compatible with the IEC 62209-2 standard and all known tissue simulating liquids. ELI has been optimized regarding its performance and can be integrated into our standard phantom tables. A cover prevents evaporation of the liquid. Reference markings on the phantom allow installation of the complete setup, including all predefined phantom positions and measurement grids, by teaching three points. The phantom is compatible with all SPEAG dosimetric probes and dipoles.</p> <p>ELI V5.0 has the same shell geometry and is manufactured from the same material as ELI4, but has reinforced top structure. ELI V6.0, released in August 2014, has the same shell geometry as ELI4 but offers increased longterm stability.</p>
<b>Material</b>	Vinylester, glass fiber reinforced (VE-GF)
<b>Liquid Compatibility</b>	Compatible with all SPEAG tissue simulating liquids (incl. DGBE type)
<b>Shell Thickness</b>	2.0 ± 0.2 mm (bottom plate)
<b>Dimensions</b>	Major axis: 600 mm Minor axis: 400 mm
<b>Filling Volume</b>	approx. 30 liters
<b>Wooden Support</b>	SPEAG standard phantom table
<b>Accessories</b>	<a href="#">Mounting Device and Adaptors</a>

### 9.3 Device Holder for Transmitters

#### Mounting Devices and Adaptors



Mounting Device for Hand-Held Transmitters

##### MD4HHTV5 - Mounting Device for Hand-Held Transmitters

In combination with the Twin SAM V5.0/V5.0c or ELI Phantoms, the Mounting Device for Hand-Held Transmitters enables rotation of the mounted transmitter device to specified spherical coordinates. At the heads, the rotation axis is at the ear opening. Transmitter devices can be easily and accurately positioned according to IEC 62209-1, IEEE 1528, FCC, or other specifications. The device holder can be locked for positioning at different phantom sections (left head, right head, flat).

**Material:** Polyoxymethylene (POM)



Mounting Device for Laptops

##### MD4LAPV5 - Mounting Device for Laptops and other Body-Worn Transmitters

In combination with the Twin SAM V5.0/V5.0c or ELI Phantoms, the Mounting Device (Body-Worn) enables testing of transmitter devices according to IEC 62209-2 specifications. The device holder can be locked for positioning at flat phantom section.

**Material:** Polyoxymethylene (POM), PET-G, Foam

## 10. System Verification

### 10.1 Tissue Verification

The dielectric properties for this Tissue Simulant Liquids were measured by using the SPEAG Model DAK3.5 Dielectric Probe in conjunction with Agilent E5071B Network Analyzer (300 kHz – 8 500 MHz). The Conductivity ( $\sigma$ ) and Permittivity ( $\rho$ ) are listed in Table 1. For the SAR measurement given in this report.

Freq. (MHz)	Tissue Type	Limit/Measured	Permittivity ( $\rho$ )	Conductivity ( $\sigma$ )	Temp (°C)
2 412	MSL	Recommended Limit	52.75 ± 5 % (50.11 ~ 55.39)	1.91 ± 5 % (1.81 ~ 2.01)	22 ± 2
		Measured, 2017-03-23	53.45	1.92	21.07
2 437	MSL	Recommended Limit	52.72 ± 5 % (50.08 ~ 55.36)	1.94 ± 5 % (1.83 ~ 2.03)	22 ± 2
		Measured, 2017-03-23	53.42	1.96	21.07
2 450	MSL	Recommended Limit	52.70 ± 5 % (50.07 ~ 55.34)	1.95 ± 5 % (1.85 ~ 2.05)	22 ± 2
		Measured, 2017-03-23	53.44	1.97	21.07
2 462	MSL	Recommended Limit	52.69 ± 5 % (50.06 ~ 55.32)	1.97 ± 5 % (1.87 ~ 2.07)	22 ± 2
		Measured, 2017-03-23	53.44	1.98	21.07

<Table 1.Measurement result of Tissue electric parameters>

## 10.2 Test System Verification

The microwave circuit arrangement for system verification is sketched below picture. The daily system accuracy verification occurs within the flat section of the SAM phantom. A SAR measurement was performed to see if the measured SAR was within  $\pm 10\%$  from the target SAR values. The tests were conducted on the samedays as the measurement of the EUT. The obtained results from the system accuracy verification are displayed in the Table 2. During the tests, the ambient temperature of the laboratory was in the range  $(22 \pm 2) ^\circ\text{C}$ , the relative humidity was in the range  $(50 \pm 20)\%$  and the liquid depth Above the ear/grid reference points was above 15 cm in all the cases. It is seen that the system is operating within its specification, as the results are within acceptable tolerance of the reference values.

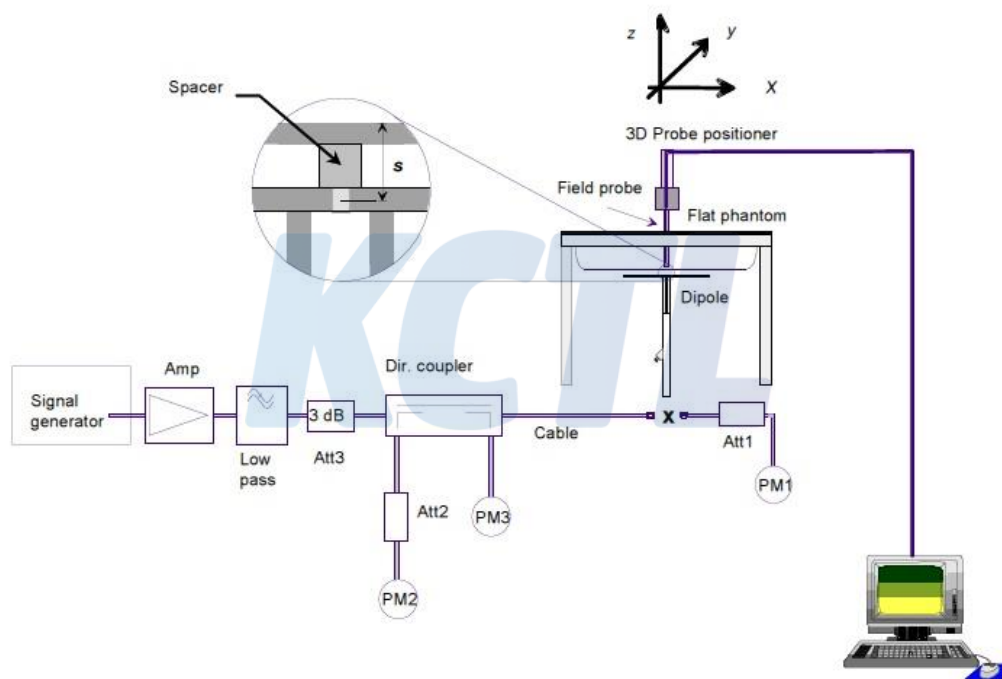

Validation Kit	Dipole Ant. S/N	Frequency (MHz)	Tissue Type	Limit/Measurement (Normalized to 1 W)	
					1 g
D2450V2	895	2 450	MSL	Recommended Limit (Normalized)	$50.80 \pm 10 \%$ (45.72 ~ 55.88)
				Measured, 2017-03-23	52.00

<Table 2. Test System Verification Result>

**KCTL Inc.**

65, Sinwon-ro, Yeongtong-gu,  
Suwon-si, Gyeonggi-do, 16677, Korea  
Tel : 82-31-285-0894 Fax : 82-505-299-8311  
[www.kctl.co.kr](http://www.kctl.co.kr)

Report No.:  
KR17-SPF0002

Page (16) of (50)

**KCTL**

## 11. Operation Configurations

Measurements were performed at the lowest, middle and highest channels of the operating band. The EUT was set to maximum power level during all tests and at the beginning of each test the battery was fully charged.

**KCTL**



## 12. SAR Measurement Procedures

### Step 1: Power Reference Measurement

The Power Reference Measurement and Power Drift Measurements are for monitoring the power drift of the device under test in the batch process. The Minimum distance of probe sensors to surface determines the closest measurement point to phantom surface. The minimum distance of probe sensor to surface is 2 mm. This distance cannot be smaller than the Distance of sensor calibration points to probe tip as defined in the probe properties.

### Step 2: Area Scan

The Area Scan is used as a fast scan in two dimensions to find the area of high field values, before doing a fine measurement around the hot spot. The sophisticated interpolation routines implemented in DASYS software can find the maximum locations even in relatively coarse grids. When an Area Scan has measured all reachable points, it computes the field maximal found in the scanned area, within a range of the global maximum. The range (in dB) is specified in the standards for compliance testing. For example, a 2 dB range is required in IEEE Standard 1528 and IEC 62209 standards, whereby 3 dB is a requirement when compliance is assessed in accordance with the ARIB standard (Japan). If only one Zoom Scan follows the Area Scan, then only the absolute maximum will be taken as reference. For cases where multiple maximums are detected, the number of Zoom Scans has to be increased accordingly.

Area Scan Parameters extracted from KDB 865664 D01 SAR Measurement 100 MHz to 6 GHz v01r04.

	≤ 3 GHz	> 3 GHz
Maximum distance from closest measurement point (geometric center of probe sensors) to phantom surface	5 ± 1 mm	$\frac{1}{2} \cdot \delta \cdot \ln(2) \pm 0.5$ mm
Maximum probe angle from probe axis to phantom surface normal at the measurement location	30° ± 1°	20° ± 1°
Maximum area scan spatial resolution: $\Delta x_{Area}$ , $\Delta y_{Area}$	≤ 2 GHz: ≤ 15 mm 2 – 3 GHz: ≤ 12 mm	3 – 4 GHz: ≤ 12 mm 4 – 6 GHz: ≤ 10 mm
	When the x or y dimension of the test device, in the measurement plane orientation, is smaller than the above, the measurement resolution must be ≤ the corresponding x or y dimension of the test device with at least one measurement point on the test device.	

### Step 3: Zoom Scan

Zoom Scans are used to assess the peak spatial SAR values within a cubic averaging volume containing 1 g and 10 g of simulated tissue. The Zoom Scan measures 5x5x7 points within a cube whose base faces are centered on the maxima found in a preceding area scan job within the same procedure. When the measurement is done, the Zoom Scan evaluates the averaged SAR for 1 g and 10 g and displays these values next to the job's label.

Zoom Scan Parameters extracted from KDB 865664 D01 SAR Measurement 100 MHz to 6 GHz v01r04.

		≤ 3 GHz	> 3 GHz
Maximum distance from closest measurement point (geometric center of probe sensors) to phantom surface		5 mm ± 1 mm	$\frac{1}{2} \cdot \delta \cdot \ln(2)$ mm 0.5 mm
Maximum probe angle from probe axis to phantom surface normal at the measurement location		30° ± 1°	20° ± 1°
Maximum area scan spatial resolution: $\Delta x_{Area}$ , $\Delta y_{Area}$		≤ 2 GHz: ≤ 15 mm 2 – 3 GHz: ≤ 12 mm	3 – 4 GHz: ≤ 12 mm 4 – 6 GHz: ≤ 10 mm
		When the x or y dimension of the test device, in the measurement plane orientation, is smaller than the above, the measurement resolution must be ≤ the corresponding x or y dimension of the test device with at least one measurement point on the test device.	
Maximum zoom scan spatial resolution: $\Delta x_{Zoom}$ , $\Delta y_{Zoom}$		≤ 2 GHz: ≤ 8 mm 2 – 3 GHz: ≤ 5 mm*	3 – 4 GHz: ≤ 5 mm* 4 – 6 GHz: ≤ 4 mm*
Maximum zoom scan spatial resolution, normal to phantom surface	uniform grid: $\Delta z_{Zoom}(n)$	≤ 5 mm	3 – 4 GHz: ≤ 4 mm 4 – 5 GHz: ≤ 3 mm 5 – 6 GHz: ≤ 2 mm
	graded grid	$\Delta z_{Zoom}(1)$ : between 1st two points closest to phantom surface	≤ 4 mm
		$\Delta z_{Zoom}(n>1)$ : between subsequent points	≤ 1.5 · $\Delta z_{Zoom}(n-1)$ mm
Minimum zoom scan volume	x, y, z	≥ 30 mm	3 – 4 GHz: ≥ 28 mm 4 – 5 GHz: ≥ 25 mm 5 – 6 GHz: ≥ 22 mm
Note: $\delta$ is the penetration depth of a plane-wave at normal incidence to the tissue medium; see IEEE Std 1528-2013 for details. * When zoom scan is required and the reported SAR from the area scan based 1-g SAR estimation procedures of KDB Publication 447498 is ≤ 1.4 W/kg, ≤ 8 mm, ≤ 7 mm and ≤ 5 mm zoom scan resolution may be applied, respectively, for 2 GHz to 3 GHz, 3 GHz to 4 GHz and 4 GHz to 6 GHz.			

### Step 4: Power drift measurement

The Power Drift Measurement measures the field at the same location as the most recent power reference measurement within the same procedure, and with the same settings. The Power Drift Measurement gives the field difference in dB from the reading conducted within the last Power Reference Measurement. This allows a user to monitor the power drift of the device under test within a batch process. The measurement procedure is the same as Step 1.

### Step 5: Z-Scan

The Z Scan measures points along a vertical straight line. The line runs along the Z-axis of a one-dimensional grid. In order to get a reasonable extrapolation, the extrapolated distance should not be larger than the step size in Z-direction.

\* Z Scan Report on Liquid Measure the height Appendix C. Liquid Depth photo to replace

**KCTL Inc.**

65, Sinwon-ro, Yeongtong-gu,  
Suwon-si, Gyeonggi-do, 16677, Korea  
Tel : 82-31-285-0894 Fax : 82-505-299-8311  
[www.kctl.co.kr](http://www.kctl.co.kr)

Report No.:  
KR17-SPF0002  
Page (19) of (50)



### 13. Test Equipment Information

Test Platform	SPEAG DASY5 System			
Version	DASY5 : Version 52.8.8.1222 SEMCAD : Version 14.6.10 (7331)			
Location	KCTL Inc.			
Manufacture	SPEAG			
Hardware Reference				
Equipment	Model	Serial Number	Date of Calibration	Due date of next Calibration
Shield Room	Shield Room	None	N/A	N/A
DASY5 Robot	TX90XL Speag	F12/5L7FA1/A/01	N/A	N/A
DASY5 Controller	TX90XL Speag	F12/5L7FA1/C/01	N/A	N/A
Phantom	Twin SAM Phantom	1728	N/A	N/A
Mounting Device	Mounting Device	None	N/A	N/A
DAE	DAE4	1342	2016-07-26	2017-07-26
Probe	EX3DV4	3865	2016-08-30	2017-08-30
Signal Generator	E4438C	MY42080486	2017-01-06	2018-01-06
Dual Power Meter	E4419B	GB43312301	2016-07-12	2017-07-12
Power Sensor	8481H	3318A19377	2016-07-20	2017-07-20
Power Sensor	8481H	3318A19379	2016-07-20	2017-07-20
Power Amplifier	2055 BBS3Q7E9I	1005D/C0521	2016-05-18	2017-05-18
Dual Directional Coupler	772D	2839A00719	2016-07-12	2017-07-12
Low Pass Filter	LA-30N	36543	2016-07-14	2017-07-14
Dipole Validation Kits	D2450V2	895	2016-07-25	2018-07-25
Network Analyzer	E5071B	MY42403524	2017-01-06	2018-01-06
Dielectric Assessment kit	DAK-3.5	1078	2016-08-25	2017-08-25
Humidity/Barometer/ Temp. Data Recorder	MHB-382SD	73871	2016-07-15	2017-07-15

**KCTL Inc.**

65, Sinwon-ro, Yeongtong-gu,  
Suwon-si, Gyeonggi-do, 16677, Korea  
Tel : 82-31-285-0894 Fax : 82-505-299-8311  
[www.kctl.co.kr](http://www.kctl.co.kr)

Report No.:  
KR17-SPF0002

Page (20) of (50)



## 14. RF Average Conducted Output Power

### 14.1 WLAN 2.4 GHz

Mode	Conducted Powers (dBm)		
	Low	Mid.	High
802.11b_1 Mbps	13.60	13.79	13.62
802.11g_6 Mbps	12.34	11.86	12.38
802.11n(HT-20)_MCS0	12.37	12.52	12.42

### 14.2 Bluetooth

Mode	Conducted Powers (dBm)		
	Low	Mid.	High
BDR(GFSK)	-0.91	-1.53	-2.03
EDR(π/4DQPSK)	-0.61	-1.28	-1.76
EDR(8DPSK)	-1.00	-1.52	-1.98

### 14.3 Max. tune up power

Mode	Target Power	Tolerance	Max. Allowed Power
IEEE 802.11b	14.00 dBm	± 1.50 dB	15.50 dBm
IEEE 802.11g	12.00 dBm	± 1.50 dB	13.50 dBm
IEEE 802.11n(HT-20)	12.00 dBm	± 1.50 dB	13.50 dBm

Mode	Target Power	Tolerance	Max. Allowed Power
BDR(GFSK)	-2.50 dBm	± 2.00 dB	-0.50 dBm
EDR(π/4DQPSK)	-2.00 dBm	± 2.00 dB	0.00 dBm
EDR(8DPSK)	-2.00 dBm	± 2.00 dB	0.00 dBm

## 15. SAR Test Exclusions Applied

Per FCC KDB 447498 D01v06, The SAR exclusion threshold for distance < 50 mm is defined by the following equation:

$$\frac{\text{Max Power of Channel (mW)}}{\text{Test Separation Distance (mm)}} * \sqrt{\text{Frequency (GHz)}} \leq 3.0$$

Mode	Frequency (MHz)	Maximum Allowed Power (mW)	Separation Distance (mm)	≤ 3.0
Bluetooth	2 402	1.00	5	0.310

Based on the maximum conducted power of Bluetooth and antenna to use separation distance, Bluetooth SAR was not required.

This device contains transmitters that may operate simultaneously. Therefore simultaneous transmission analysis is required. Per FCC KDB 447498 D01v06, simultaneous transmission SAR test exclusion may be applied when the sum of the 1-g SAR for all the simultaneous transmitting antennas in a specific a physical test configuration is ≤ 1.6W/kg. When standalone SAR is not required to be measured per FCC KDB 447498 D01v06, the following equation must be used to estimate the standalone 1-g SAR for simultaneous transmission assessment involving that transmitter.

$$\text{Estimated SAR} = \frac{\sqrt{f \text{ (GHz)}}}{7.5} * \frac{\text{(Max Power of Channel mW)}}{\text{Min Separation Distance}}$$

Mode	Frequency (MHz)	Maximum Allowed Power (mW)	Separation Distance (Body) (mm)	Estimated SAR (Body) (W/kg)
Bluetooth	2 402	1.00	5	0.041

**KCTL Inc.**

65, Sinwon-ro, Yeongtong-gu,  
Suwon-si, Gyeonggi-do, 16677, Korea  
Tel : 82-31-285-0894 Fax : 82-505-299-8311  
[www.kctl.co.kr](http://www.kctl.co.kr)

Report No.:  
KR17-SPF0002

Page (22) of (50)



## 16. SAR Test Results

### 16.1 WLAN Body SAR Test Results

Frequency		Average Power (dBm)	Max. tune up power (dBm)	Scaling Factor	EUT Position	Separation Distance (mm)	Measured 1 g SAR (W/kg)	Scaled 1 g SAR (W/kg)	1 g SAR Limit (W/kg)
MHz	Ch.								
2 437	6	13.79	15.50	1.483	Front	5	0.016	0.024	1.6
2 437	6	13.79	15.50	1.483	Rear	5	0.140	0.208	
2 437	6	13.79	15.50	1.483	Left	5	0.014	0.021	
2 437	6	13.79	15.50	1.483	Right	5	0.000	0.000	
2 437	6	13.79	15.50	1.483	Top	5	0.218	0.323	
2 437	6	13.79	15.50	1.483	Bottom	5	0.009	0.013	
2 412	1	13.60	15.50	1.549	Top	5	0.159	0.246	
2 462	11	13.62	15.50	1.542	Top	5	0.256	<b>0.395</b>	

<Note>

- \* SAR values were scaled to the maximum allowed power to determine compliance per KDB Publication 447498 D01v06.
- \* For WLAN 2.4 GHz, the highest measured maximum output power channel for DSSS was selected for SAR measurement. When the reported SAR is  $\leq 0.8$  W/kg, no further SAR testing is required. Otherwise, SAR is evaluated at the next highest measured output power channel. When any reported SAR is  $> 1.2$  W/kg, SAR is required for the third channel. For OFDM modes (802.11g/n), SAR is not required when the highest reported SAR for DSSS is adjusted by the ratio of OFDM to DSSS specified maximum output power and it is  $\leq 1.2$  W/kg.

### 16.2 WLAN + Bluetooth Simultaneous Transmission

Band	EUT Position	Separation Distance (mm)	Scaled 1 g SAR (W/kg)	BT Estimated SAR (W/kg)	$\Sigma$ 1 g SAR (W/kg)	1 g SAR Limit (W/kg)
WLAN + BT	Top	5	0.395	0.041	<b>0.436</b>	1.6

<Note>

- \* The above numerical summed SAR results for all the worst-case simultaneous transmission conditions were below the SAR limit. Therefore, the above analysis is sufficient to determine that simultaneous transmission cases will not exceed the SAR limit. And therefore no measured volumetric simultaneous SAR summation is required per FCC KDB Publication 447498 D01v06.

## 17. Test System Verification Results

2 450 MHz

**Procedure Name: d=10 mm, Pin=250 mW, dist=2.0mm (EX-Probe)**

Frequency: 2450 MHz; Duty Cycle: 1:1

Medium parameters used:  $f = 2450$  MHz;  $\sigma = 1.968$  S/m;  $\epsilon_r = 53.436$ ;  $\rho = 1000$  kg/m<sup>3</sup>

Phantom section: Flat Section

DASY5 Configuration:

- Probe: EX3DV4 - SN3865; ConvF(7.86, 7.86, 7.86); Calibrated: 2016-08-30;
- Sensor-Surface: 2mm (Mechanical Surface Detection)
- Electronics: DAE4 Sn1342; Calibrated: 2016-07-26
- Phantom: SAM twin 1728; Type: QD000P40CD; Serial: TP:1728
- Measurement SW: DASY52, Version 52.8 (8);

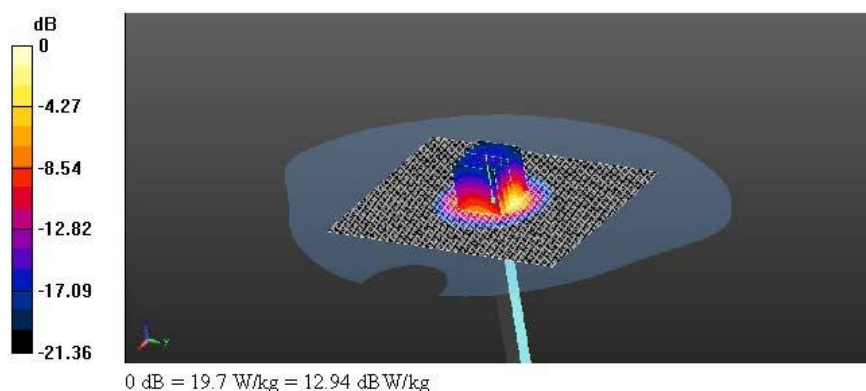
**System Performance Check (without Area Scan)/d=10 mm, Pin=250 mW, dist=2.0mm (EX-Probe)/Area Scan (101x131x1):** Interpolate d grid:  $dx=1.200$  mm,  $dy=1.200$  mm  
Maximum value of SAR (interpolated) = 20.4 W/kg**System Performance Check (without Area Scan)/d=10 mm, Pin=250 mW, dist=2.0mm (EX-Probe)/Zoom Scan (7x7x7)/Cube 0:** Measurement grid:  $dx=5$ mm,  $dy=5$ mm,  $dz=5$ mm  
Reference Value = 99.95 V/m; Power Drift = 0.04 dB  
Peak SAR (extrapolated) = 26.3 W/kg  
**SAR(1 g) = 13 W/kg; SAR(10 g) = 6.07 W/kg**  
Maximum value of SAR (measured) = 19.7 W/kg

## 18. Test Results

**Procedure Name: 802.11b\_f.2 462\_Top\_5 mm**

Frequency: 2462 MHz; Duty Cycle: 1:1

Medium parameters used:  $f = 2462$  MHz;  $\sigma = 1.984$  S/m;  $\epsilon_r = 53.441$ ;  $\rho = 1000$  kg/m<sup>3</sup>

Phantom section: Flat Section

DASY5 Configuration:

- Probe: EX3DV4 - SN3865; ConvF(7.86, 7.86, 7.86); Calibrated: 2016-08-30;
- Sensor-Surface: 2mm (Mechanical Surface Detection)
- Electronics: DAE4 Sn1342; Calibrated: 2016-07-26
- Phantom: SAM twin 1728; Type: QD000P40CD; Serial: TP:1728
- Measurement SW: DASY52, Version 52.8 (8);

**Configuration/802.11b\_f.2 462\_Top\_5 mm/Area Scan (81x111x1):** Interpolated grid:

dx=1.200 mm, dy=1.200 mm

Maximum value of SAR (interpolated) = 0.459 W/kg

**Configuration/802.11b\_f.2 462\_Top\_5 mm/Zoom Scan (7x7x7)/Cube 0:** Measurement

grid: dx=5mm, dy=5mm, dz=5mm

Reference Value = 11.85 V/m; Power Drift = -0.16 dB

Peak SAR (extrapolated) = 0.493 W/kg

**SAR(1 g) = 0.256 W/kg; SAR(10 g) = 0.120 W/kg**

Maximum value of SAR (measured) = 0.370 W/kg

