



FCC TEST REPORT (BLUETOOTH LE)

REPORT NO.: RF141013D01-3
MODEL NO.: AM30
FCC ID: QCIAM30
RECEIVED: Oct. 13, 2014
TESTED: Oct. 30 ~ Dec. 15, 2014
ISSUED: Dec. 23, 2014

APPLICANT: SMART Technologies Inc.

ADDRESS: 3636 Research Road NW Calgary, AB T2L 1Y1
CANADA

ISSUED BY: Bureau Veritas Consumer Products Services
(H.K.) Ltd., Taoyuan Branch

LAB ADDRESS: No. 47-2, 14th Ling, Chia Pau Vil., Lin Kou Dist.,
New Taipei City, Taiwan (R.O.C.)

This report should not be used by the client to claim product certification, approval, or endorsement by TAF or any government agencies.



This report is for your exclusive use. Any copying or replication of this report to or for any other person or entity, or use of our name or trademark, is permitted only with our prior written permission. This report sets forth our findings solely with respect to the test samples identified herein. The results set forth in this report are not indicative or representative of the quality or characteristics of the lot from which a test sample was taken or any similar or identical product unless specifically and expressly noted. Our report includes all of the tests requested by you and the results thereof based upon the information that you provided to us. You have 60 days from date of issuance of this report to notify us of any material error or omission caused by our negligence, provided, however, that such notice shall be in writing and shall specifically address the issue you wish to raise. A failure to raise such issue within the prescribed time shall constitute your unqualified acceptance of the completeness of this report, the tests conducted and the correctness of the report contents. Unless specific mention, the uncertainty of measurement has been explicitly taken into account to declare the compliance or non-compliance to the specification.



Table of Contents

RELEASE CONTROL RECORD	4
1. CERTIFICATION.....	5
2. SUMMARY OF TEST RESULTS	6
2.1 MEASUREMENT UNCERTAINTY	6
3. GENERAL INFORMATION	7
3.1 GENERAL DESCRIPTION OF EUT	7
3.2 DESCRIPTION OF TEST MODES	8
3.2.1 TEST MODE APPLICABILITY AND TESTED CHANNEL DETAIL.....	9
3.3 DUTY CYCLE OF TEST SIGNAL	11
3.4 DESCRIPTION OF SUPPORT UNITS	12
3.4.1 CONFIGURATION OF SYSTEM UNDER TEST.....	13
3.5 GENERAL DESCRIPTION OF APPLIED STANDARDS.....	14
4. TEST TYPES AND RESULTS	15
4.1 RADIATED EMISSION AND BANDEDGE MEASUREMENT	15
4.1.1 LIMITS OF RADIATED EMISSION AND BANDEDGE MEASUREMENT	15
4.1.2 TEST INSTRUMENTS.....	16
4.1.3 TEST PROCEDURES	17
4.1.4 DEVIATION FROM TEST STANDARD.....	17
4.1.5 TEST SETUP.....	18
4.1.6 EUT OPERATING CONDITIONS	18
4.1.7 TEST RESULTS	19
4.2 CONDUCTED EMISSION MEASUREMENT.....	23
4.2.1 LIMITS OF CONDUCTED EMISSION MEASUREMENT	23
4.2.2 TEST INSTRUMENTS.....	23
4.2.3 TEST PROCEDURES	24
4.2.4 DEVIATION FROM TEST STANDARD.....	24
4.2.5 TEST SETUP.....	24
4.2.6 EUT OPERATING CONDITIONS	24
4.2.7 TEST RESULTS	25
4.3 6dB BANDWIDTH MEASUREMENT	27
4.3.1 LIMITS OF 6dB BANDWIDTH MEASUREMENT	27
4.3.2 TEST SETUP.....	27
4.3.3 TEST INSTRUMENTS.....	27
4.3.4 TEST PROCEDURE.....	27
4.3.5 DEVIATION FROM TEST STANDARD.....	27
4.3.6 EUT OPERATING CONDITIONS	27
4.3.7 TEST RESULTS	28
4.4 CONDUCTED OUTPUT POWER.....	29
4.4.1 LIMITS OF CONDUCTED OUTPUT POWER MEASUREMENT.....	29
4.4.2 TEST SETUP.....	29
4.4.3 TEST INSTRUMENTS.....	29



A D T

4.4.4	TEST PROCEDURES	29
4.4.5	DEVIATION FROM TEST STANDARD	29
4.4.6	EUT OPERATING CONDITIONS	29
4.4.7	TEST RESULTS	30
4.5	POWER SPECTRAL DENSITY MEASUREMENT	31
4.5.1	LIMITS OF POWER SPECTRAL DENSITY MEASUREMENT	31
4.5.2	TEST SETUP	31
4.5.3	TEST INSTRUMENTS	31
4.5.4	TEST PROCEDURE	31
4.5.5	DEVIATION FROM TEST STANDARD	31
4.5.6	EUT OPERATING CONDITION	31
4.5.7	TEST RESULTS	32
4.6	CONDUCTED OUT OF BAND EMISSION MEASUREMENT	33
4.6.1	LIMITS OF CONDUCTED OUT OF BAND EMISSION MEASUREMENT	33
4.6.2	TEST SETUP	33
4.6.3	TEST INSTRUMENTS	33
4.6.4	TEST PROCEDURE	33
4.6.5	DEVIATION FROM TEST STANDARD	34
4.6.6	EUT OPERATING CONDITION	34
4.6.7	TEST RESULTS	34
5.	PHOTOGRAPHS OF THE TEST CONFIGURATION	36
6.	INFORMATION ON THE TESTING LABORATORIES	37
7.	APPENDIX A - MODIFICATIONS RECORDERS FOR ENGINEERING CHANGES TO THE EUT BY THE LAB	38



A D T

RELEASE CONTROL RECORD

ISSUE NO.	REASON FOR CHANGE	DATE ISSUED
RF141013D01-3	Original release	Dec. 23, 2014



A D T

1. CERTIFICATION

PRODUCT: PC Device
BRAND NAME: SMART
MODEL NO.: AM30
APPLICANT: SMART Technologies Inc.
TESTED: Oct. 30 ~ Dec. 15, 2014
TEST SAMPLE: ENGINEERING SAMPLE
STANDARDS: **FCC Part 15, Subpart C (Section 15.247)**
ANSI C63.10-2009

The above equipment has been tested by **Bureau Veritas Consumer Products Services (H.K.) Ltd., Taoyuan Branch**, and found compliance with the requirement of the above standards. The test record, data evaluation & Equipment Under Test (EUT) configurations represented herein are true and accurate accounts of the measurements of the sample's EMC characteristics under the conditions specified in this report.

PREPARED BY : Annie Chang , **DATE:** Dec. 23, 2014
(Annie Chang / Supervisor)

APPROVED BY : Rex Lai , **DATE:** Dec. 23, 2014
(Rex Lai / Assistant Manager)

2. SUMMARY OF TEST RESULTS

The EUT has been tested according to the following specifications:

APPLIED STANDARD: FCC PART 15, SUBPART C			
STANDARD SECTION	TEST TYPE	RESULT	REMARK
15.207	AC Power Conducted Emission	PASS	Meet the requirement of limit. Minimum passing margin is -11.24dB at 0.17997MHz.
15.205 & 15.209	Radiated Emissions	PASS	Meet the requirement of limit. Minimum passing margin is -6.6dB at 35.53MHz.
15.247(d)	Band Edge Measurement	PASS	Meet the requirement of limit. Minimum passing margin is -13.5dB at 2400.00MHz.
15.247(d)	Antenna Port Emission	PASS	Meet the requirement of limit.
15.247(a)(2)	6dB bandwidth	PASS	Meet the requirement of limit.
15.247(b)	Conducted power	PASS	Meet the requirement of limit.
15.247(e)	Power Spectral Density	PASS	Meet the requirement of limit.
15.203	Antenna Requirement	PASS	No antenna connector is used.

2.1 MEASUREMENT UNCERTAINTY

Where relevant, the following measurement uncertainty levels have been estimated for tests performed on the EUT as specified in CISPR 16-4-2:

This uncertainty represents an expanded uncertainty expressed at approximately the 95% confidence level using a coverage factor of k=2.

Measurement	Frequency	Uncertainty
Conducted emissions	150kHz~30MHz	3.43 dB
Radiated emissions	30MHz ~ 1GHz	4.00 dB
	Above 1GHz	3.36 dB

3. GENERAL INFORMATION

3.1 GENERAL DESCRIPTION OF EUT

EUT	PC Device
MODEL NO.	AM30
POWER SUPPLY	19Vdc, 5A
MODULATION TYPE	GFSK
TRANSFER RATE	1Mbit/sec.
NUMBER OF CHANNEL	40
OPERATING FREQUENCY	2402-2480MHz
MAX. OUTPUT POWER	1.6mW
ANTENNA TYPE	Dipole antenna with 2.18dBi gain
ANTENNA CONNECTOR	N/A
I/O PORTS	Refer to user's manual
DATA CABLE	N/A
ACCESSORY DEVICES	N/A

NOTE:

1. The EUT was configured with the following key components:

Component	Brand	Model No.	Spec.
Processor	Qualcomm	APQ8074AC	4 cores /2.45GHz
RAM	Samsung	K3QF7F70DM-QGCF	3GB LPDDR3 SDRAM
Flash Storage	Toshiba	THGBMBG6D1KBAIL	8GB
Wi-Fi/BT Chip	Qualcomm	WCN3680	Dual -band 2.4GHz and 5GHz WLAN / BT 4.0

2. The above EUT information is declared by manufacturer and for more detailed features description, please refer to the manufacturer's specifications or User's Manual.

3.2 DESCRIPTION OF TEST MODES

40 channels are provided to this EUT:

CHANNEL	FREQ. (MHz)	CHANNEL	FREQ. (MHz)	CHANNEL	FREQ. (MHz)	CHANNEL	FREQ. (MHz)
0	2402	10	2422	20	2442	30	2462
1	2404	11	2424	21	2444	31	2464
2	2406	12	2426	22	2446	32	2466
3	2408	13	2428	23	2448	33	2468
4	2410	14	2430	24	2450	34	2470
5	2412	15	2432	25	2452	35	2472
6	2414	16	2434	26	2454	36	2474
7	2416	17	2436	27	2456	37	2476
8	2418	18	2438	28	2458	38	2478
9	2420	19	2440	29	2460	39	2480



3.2.1 TEST MODE APPLICABILITY AND TESTED CHANNEL DETAIL

EUT CONFIGURE MODE	APPLICABLE TO					DESCRIPTION
	PLC	RE < 1G	RE ≥ 1G	APCM	OB	
-	√	√	√	√	√	-

Where **PLC**: Power Line Conducted Emission **RE < 1G**: Radiated Emission below 1GHz
RE ≥ 1G: Radiated Emission above 1GHz **APCM**: Antenna Port Conducted Measurement
OB: Conducted Out-Band Emission Measurement

RADIATED EMISSION TEST (BELOW 1 GHz):

- Pre-Scan has been conducted to determine the worst-case mode from all possible combinations between available modulations, data rates and antenna ports (if EUT with antenna diversity architecture).
- Following channel(s) was (were) selected for the final test as listed below.

EUT CONFIGURE MODE	AVAILABLE CHANNEL	TESTED CHANNEL	MODULATION TYPE
-	0 to 39	19	GFSK

RADIATED EMISSION TEST (ABOVE 1 GHz):

- Pre-Scan has been conducted to determine the worst-case mode from all possible combinations between available modulations, data rates and antenna ports (if EUT with antenna diversity architecture).
- Following channel(s) was (were) selected for the final test as listed below.

EUT CONFIGURE MODE	AVAILABLE CHANNEL	TESTED CHANNEL	MODULATION TYPE
-	0 to 39	0, 19, 39	GFSK

POWER LINE CONDUCTED EMISSION TEST:

- Pre-Scan has been conducted to determine the worst-case mode from all possible combinations between available modulations, data rates and antenna ports (if EUT with antenna diversity architecture).
- Following channel(s) was (were) selected for the final test as listed below.

EUT CONFIGURE MODE	AVAILABLE CHANNEL	TESTED CHANNEL	MODULATION TYPE
-	0 to 39	19	GFSK

ANTENNA PORT CONDUCTED MEASUREMENT:

- Pre-Scan has been conducted to determine the worst-case mode from all possible combinations between available modulations, data rates and antenna ports (if EUT with antenna diversity architecture).
- Following channel(s) was (were) selected for the final test as listed below.

EUT CONFIGURE MODE	AVAILABLE CHANNEL	TESTED CHANNEL	MODULATION TYPE
-	0 to 39	0, 19, 39	GFSK

CONDUCTED OUT-BAND EMISSION MEASUREMENT:

- Pre-Scan has been conducted to determine the worst-case mode from all possible combinations between available modulations, data rates and antenna ports (if EUT with antenna diversity architecture).
- Following channel(s) was (were) selected for the final test as listed below.

EUT CONFIGURE MODE	AVAILABLE CHANNEL	TESTED CHANNEL	MODULATION TYPE
-	0 to 39	0, 19, 39	GFSK

TEST CONDITION:

APPLICABLE TO	ENVIRONMENTAL CONDITIONS	INPUT POWER	TESTED BY
RE<1G	26deg. C, 73% RH	120Vac, 60Hz	Aaron You
RE≥1G	21deg. C, 79% RH	120Vac, 60Hz	Aaron You
PLC	21deg. C, 73% RH	120Vac, 60Hz	Aaron You
APCM	20deg. C, 70% RH	120Vac, 60Hz	Saxon Lee
OB	20deg. C, 70% RH	120Vac, 60Hz	Saxon Lee

3.3 DUTY CYCLE OF TEST SIGNAL

Duty cycle of test signal is < 98%

Duty cycle = $0.377/0.626 = 0.602$, Duty factor = $10 * \log(1/0.602) = 2.20$

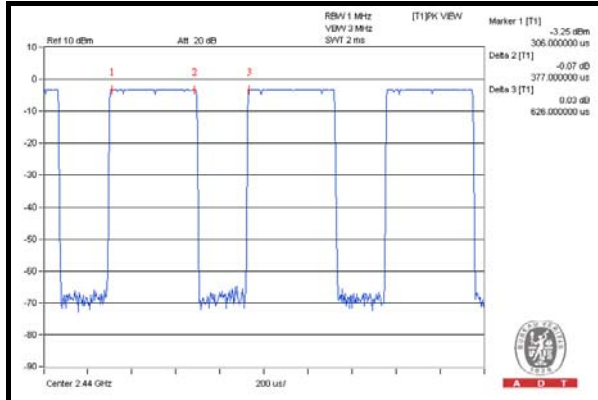

3.4 DESCRIPTION OF SUPPORT UNITS

The EUT has been tested as an independent unit together with other necessary accessories or support units. The following support units or accessories were used to form a representative test configuration during the tests.

NO.	PRODUCT	BRAND	MODEL NO.	SERIAL NO.	FCC ID
1	Mechanical tool	N/A	N/A	N/A	N/A
2	ADAPTER	FPS	FSP120-AAB	N/A	N/A
3	LCD MONITOR	DELL	U2410	CN082WXD728 720CC0KDL	FCC DoC Approved
4	USB KEYBOARD	BTC	5200U	G09302046353	E5XKB5122U
5	USB Mouse	Microsoft	1113	9170515772226	FCC DoC Approved

NO.	SIGNAL CABLE DESCRIPTION OF THE ABOVE SUPPORT UNITS
1	N/A
2	DC cable (1.5m)
3	1.8m shielded HDMI cable
4	1.5 m braid shielded wire, terminated with USB connector via drain wire, w/o core.
5	1.5 m braid shielded wire, terminated with USB connector via drain wire, w/o core.

- NOTE:** 1. All power cords of the above support units are non shielded (1.8m).
2. The support units 1-2 were provided by client.

3.4.1 CONFIGURATION OF SYSTEM UNDER TEST

For Conduction test only:

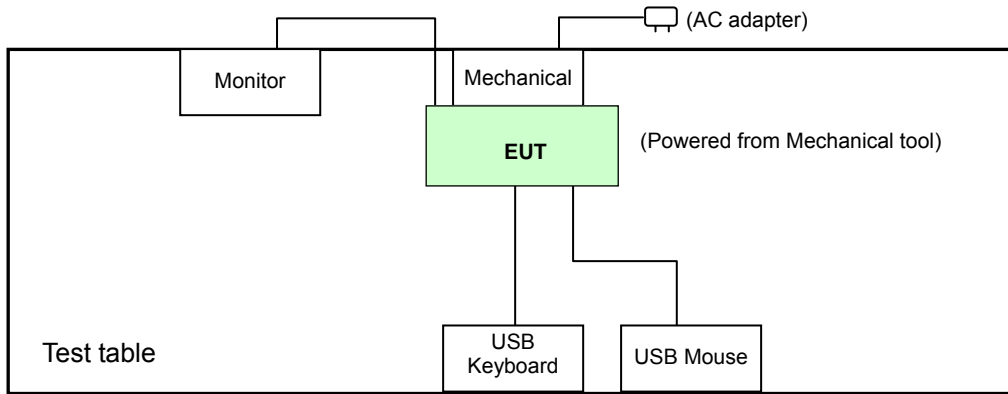

For Other tests except for Conduction test:

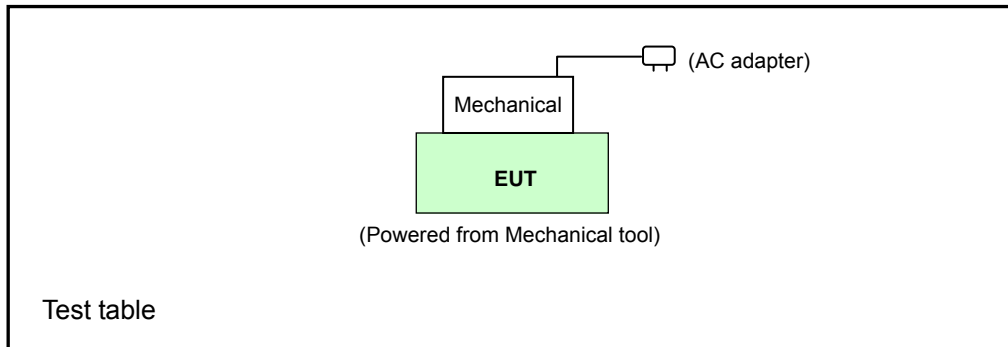



3.5 GENERAL DESCRIPTION OF APPLIED STANDARDS

The EUT is a RF Product. According to the specifications of the manufacturer, it must comply with the requirements of the following standards:

FCC Part 15, Subpart C. (15.247)

558074 D01 DTS Meas Guidance v03r02

ANSI C63.10-2009

All test items have been performed and recorded as per the above standards.

NOTE: The product has been verified to comply with the requirements of FCC Part 15, Subpart B, Class B (DoC). The test report has been issued separately.

4. TEST TYPES AND RESULTS

4.1 RADIATED EMISSION AND BANDEDGE MEASUREMENT

4.1.1 LIMITS OF RADIATED EMISSION AND BANDEDGE MEASUREMENT

Radiated emissions which fall in the restricted bands must comply with the radiated emission limits specified as below table. Other emissions shall be at least 20dB below the highest level of the desired power:

FREQUENCIES (MHz)	FIELD STRENGTH (microvolts/meter)	MEASUREMENT DISTANCE (meters)
0.009 ~ 0.490	2400/F(kHz)	300
0.490 ~ 1.705	24000/F(kHz)	30
1.705 ~ 30.0	30	30
30 ~ 88	100	3
88 ~ 216	150	3
216 ~ 960	200	3
Above 960	500	3

NOTE:

1. The lower limit shall apply at the transition frequencies.
2. Emission level (dBuV/m) = 20 log Emission level (uV/m).
3. For frequencies above 1000MHz, the field strength limits are based on average detector, however, the peak field strength of any emission shall not exceed the maximum permitted average limits, specified above by more than 20dB under any condition of modulation.



4.1.2 TEST INSTRUMENTS

DESCRIPTION & MANUFACTURER	MODEL NO.	SERIAL NO.	CALIBRATED DATE	CALIBRATED UNTIL
HP Preamplifier	8447D	2432A03504	Feb. 26, 2014	Feb. 25, 2015
HP Preamplifier	8449B	3008A01201	Feb. 26, 2014	Feb. 25, 2015
MITEQ Preamplifier	AMF-6F-260400-3 3-8P	892164	Mar. 01, 2014	Feb. 28, 2015
Agilent Spectrum	E4446A	MY51100050	Oct. 24, 2014	Oct. 23, 2015
Agilent TEST RECEIVER	N9038A	MY51210129	Jan. 18, 2014	Jan. 17, 2015
Schwarzbeck Antenna	VULB 9168	139	Feb. 24, 2014	Feb. 23, 2015
Schwarzbeck Antenna	VHBA 9123	480	May 29, 2013	May 28, 2015
Schwarzbeck Horn Antenna	BBHA-9170	212	Aug. 26, 2014	Aug. 25, 2015
Schwarzbeck Horn Antenna	BBHA 9120-D1	D130	Aug. 26, 2014	Aug. 25, 2015
ADT. Turn Table	TT100	0306	NA	NA
ADT. Tower	AT100	0306	NA	NA
Software	ADT_Radiated_V7. 6.15.9.4	NA	NA	NA
SUHNER RF cable	SF104	CABLE-CH6	Aug. 15, 2014	Aug. 14, 2015
SUHNER RF cable	SF102	Cable-CH8-3.6m	Aug. 15, 2014	Aug. 14, 2015
EMCO Horn Antenna	3115	00028257	Aug. 28, 2014	Aug. 27, 2015
ROHDE & SCHWARZ Spectrum Analyzer	FSV40	101042	Sep. 29, 2014	Sep. 28, 2015
Anritsu Power Sensor	MA2411B	0738404	Apr. 21, 2014	Apr. 20, 2015
Anritsu Power Meter	ML2495A	0842014	Apr. 21, 2014	Apr. 20, 2015

- NOTE:** 1. The calibration interval of the above test instruments is 12/24 months. And the calibrations are traceable to NML/ROC and NIST/USA.
 2. The horn antenna and HP preamplifier (model: 8449B) are used only for the measurement of emission frequency above 1GHz if tested.
 3. The test was performed in Chamber No. 6.
 4. The Industry Canada Reference No. IC 7450E-6.
 5. The FCC Site Registration No. is 447212.

4.1.3 TEST PROCEDURES

- a. The EUT was placed on the top of a rotating table 0.8 meters above the ground at a 3 meter semi-anechoic chamber. The table was rotated 360 degrees to determine the position of the highest radiation.
- b. The EUT was set 3 meters away from the interference-receiving antenna, which was mounted on the top of a variable-height antenna tower.
- c. The height is varied from one meter to four meters above the ground to determine the maximum value of the field strength. Both horizontal and vertical polarizations of the antenna are set to make the measurement.
- d. For each suspected emission, the EUT was arranged to its worst case and then the antenna was tuned to heights from 1 meter to 4 meters and the rotatable table was turned from 0 degrees to 360 degrees to find the maximum reading.
- e. The test-receiver system was set to Peak Detect Function and Specified Bandwidth with Maximum Hold Mode.
- f. If the emission level of the EUT in peak mode was lower than the limit specified, then testing could be stopped and the peak values of the EUT would be reported. Otherwise the emissions would be re-tested one by one using peak, quasi-peak or average method as specified and then reported in a data sheet.

NOTE:

1. The resolution bandwidth and video bandwidth of test receiver/spectrum analyzer is 120kHz for Quasi-peak detection at frequency below 1GHz.
2. The resolution bandwidth of test receiver/spectrum analyzer is 1MHz and video bandwidth is 3MHz for Peak detection at frequency above 1GHz.
3. The resolution bandwidth of test receiver/spectrum analyzer is 1MHz and the video bandwidth is $\geq 1/T$ (Duty cycle < 98%) or 10Hz (Duty cycle > 98%) for Average detection (AV) at frequency above 1GHz.
4. All modes of operation were investigated and the worst-case emissions are reported.

4.1.4 DEVIATION FROM TEST STANDARD

No deviation.

4.1.5 TEST SETUP

Frequency range 30MHz~1GHz

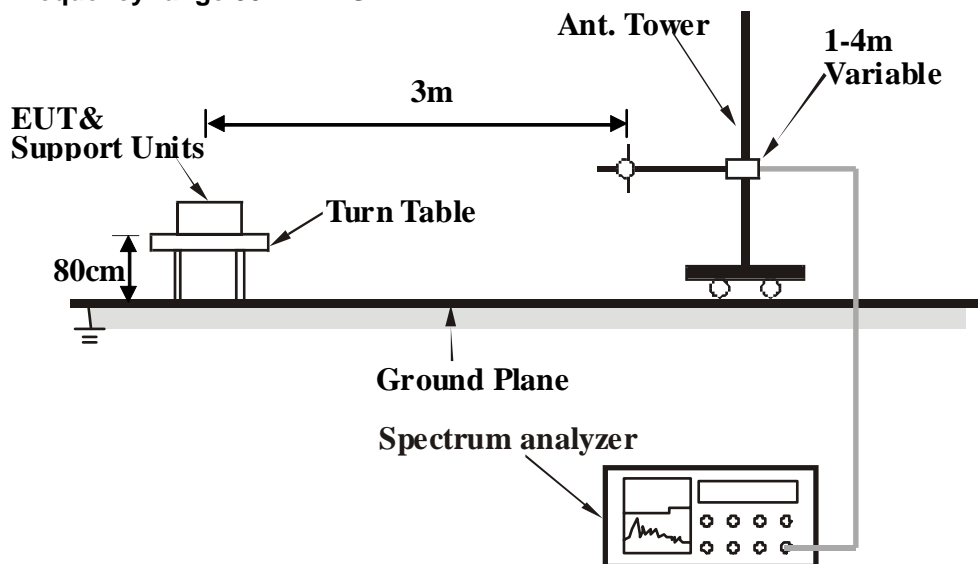

Frequency range above 1GHz

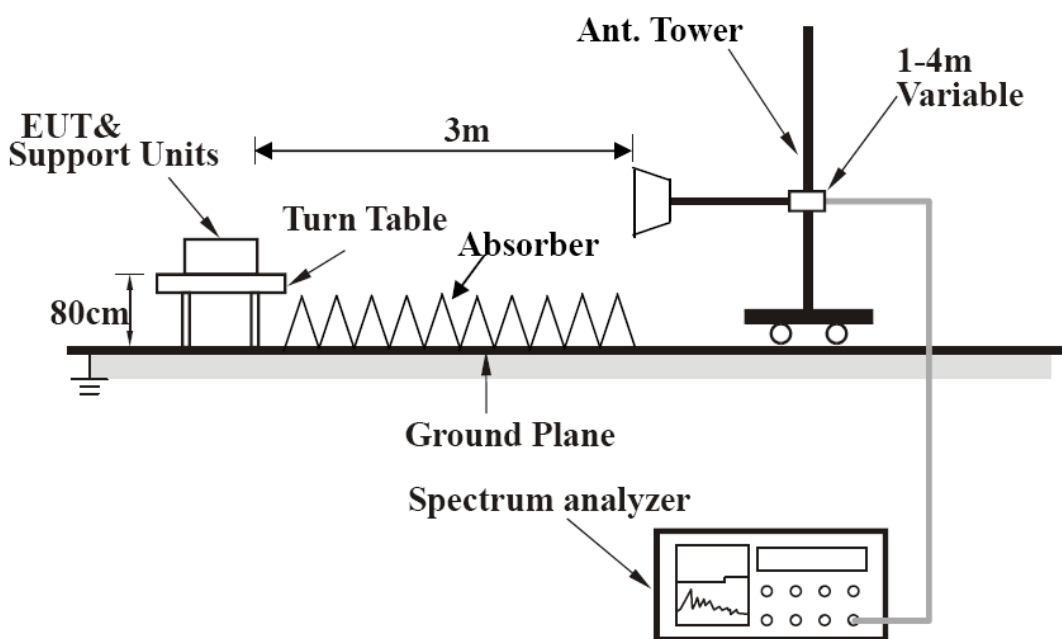

For the actual test configuration, please refer to the attached file (Test Setup Photo).

4.1.6 EUT OPERATING CONDITIONS

Set the EUT under transmission condition continuously at specific channel frequency.

4.1.7 TEST RESULTS

ABOVE 1GHz DATA

CHANNEL	TX Channel 0	DETECTOR FUNCTION	Peak (PK)
FREQUENCY RANGE	1GHz ~ 25GHz		Average (AV)

ANTENNA POLARITY & TEST DISTANCE: HORIZONTAL AT 3 M								
NO.	FREQ. (MHz)	EMISSION LEVEL (dBuV/m)	LIMIT (dBuV/m)	MARGIN (dB)	ANTENNA HEIGHT (m)	TABLE ANGLE (Degree)	RAW VALUE (dBuV)	CORRECTION FACTOR (dB/m)
1	2390.00	51.8 PK	74.0	-22.2	1.00 H	311	55.96	-4.20
2	2390.00	38.4 AV	54.0	-15.7	1.00 H	311	42.55	-4.20
3	#2400.00	60.9 PK	74.2	-13.3	1.00 H	311	65.05	-4.14
4	#2400.00	48.6 AV	70.4	-21.8	1.00 H	311	52.69	-4.14
5	*2402.00	94.2 PK			1.00 H	311	98.35	-4.13
6	*2402.00	90.4 AV			1.00 H	311	94.52	-4.13
7	4804.00	44.9 PK	74.0	-29.1	1.21 H	227	42.51	2.35
8	4804.00	32.6 AV	54.0	-21.5	1.21 H	227	30.20	2.35

ANTENNA POLARITY & TEST DISTANCE: VERTICAL AT 3 M								
NO.	FREQ. (MHz)	EMISSION LEVEL (dBuV/m)	LIMIT (dBuV/m)	MARGIN (dB)	ANTENNA HEIGHT (m)	TABLE ANGLE (Degree)	RAW VALUE (dBuV)	CORRECTION FACTOR (dB/m)
1	2390.00	52.2 PK	74.0	-21.8	1.00 V	330	56.36	-4.20
2	2390.00	38.5 AV	54.0	-15.5	1.00 V	330	42.71	-4.20
3	#2400.00	64.7 PK	78.2	-13.5	1.00 V	330	68.88	-4.14
4	#2400.00	52.1 AV	73.9	-21.8	1.00 V	330	56.24	-4.14
5	*2402.00	98.2 PK			1.00 V	330	102.32	-4.13
6	*2402.00	93.9 AV			1.00 V	330	98.02	-4.13
7	4804.00	45.4 PK	74.0	-28.6	1.05 V	293	43.08	2.35
8	4804.00	33.7 AV	54.0	-20.3	1.05 V	293	31.31	2.35

REMARKS:

1. Emission Level(dBuV/m) = Raw Value(dBuV) + Correction Factor(dB/m)
2. Correction Factor(dB/m) = Antenna Factor(dB/m) + Cable Factor(dB) – Pre-Amplifier Factor(dB)
3. The other emission levels were very low against the limit.
4. Margin value = Emission Level – Limit value
5. " * ": Fundamental frequency.
6. " # ": The radiated frequency is out of the restricted band.



A D T

CHANNEL	TX Channel 19	DETECTOR FUNCTION	Peak (PK)
FREQUENCY RANGE	1GHz ~ 25GHz		Average (AV)

ANTENNA POLARITY & TEST DISTANCE: HORIZONTAL AT 3 M								
NO.	FREQ. (MHz)	EMISSION LEVEL (dBuV/m)	LIMIT (dBuV/m)	MARGIN (dB)	ANTENNA HEIGHT (m)	TABLE ANGLE (Degree)	RAW VALUE (dBuV)	CORRECTION FACTOR (dB/m)
1	*2440.00	92.6 PK			1.11 H	285	96.55	-3.95
2	*2440.00	88.6 AV			1.11 H	285	92.56	-3.95
3	4880.00	45.1 PK	74.0	-28.9	1.02 H	253	42.65	2.46
4	4880.00	32.7 AV	54.0	-21.4	1.02 H	253	30.19	2.46
ANTENNA POLARITY & TEST DISTANCE: VERTICAL AT 3 M								
NO.	FREQ. (MHz)	EMISSION LEVEL (dBuV/m)	LIMIT (dBuV/m)	MARGIN (dB)	ANTENNA HEIGHT (m)	TABLE ANGLE (Degree)	RAW VALUE (dBuV)	CORRECTION FACTOR (dB/m)
1	*2440.00	96.2 PK			1.74 V	273	100.16	-3.95
2	*2440.00	92.1 AV			1.74 V	273	96.07	-3.95
3	4880.00	45.3 PK	74.0	-28.7	1.00 V	126	42.88	2.46
4	4880.00	33.6 AV	54.0	-20.4	1.00 V	126	31.15	2.46

REMARKS:

1. Emission Level(dBuV/m) = Raw Value(dBuV) + Correction Factor(dB/m)
2. Correction Factor(dB/m) = Antenna Factor(dB/m) + Cable Factor(dB) – Pre-Amplifier Factor(dB)
3. The other emission levels were very low against the limit.
4. Margin value = Emission Level – Limit value
5. " * ": Fundamental frequency.



A D T

CHANNEL	TX Channel 39	DETECTOR FUNCTION	Peak (PK)
FREQUENCY RANGE	1GHz ~ 25GHz		Average (AV)

ANTENNA POLARITY & TEST DISTANCE: HORIZONTAL AT 3 M

NO.	FREQ. (MHz)	EMISSION LEVEL (dBuV/m)	LIMIT (dBuV/m)	MARGIN (dB)	ANTENNA HEIGHT (m)	TABLE ANGLE (Degree)	RAW VALUE (dBuV)	CORRECTION FACTOR (dB/m)
1	*2480.00	92.7 PK			1.09 H	285	96.50	-3.78
2	*2480.00	88.7 AV			1.09 H	285	92.47	-3.78
3	2483.50	51.4 PK	74.0	-22.7	1.09 H	285	55.12	-3.77
4	2483.50	38.4 AV	54.0	-15.6	1.09 H	285	42.20	-3.77
5	4960.00	45.3 PK	74.0	-28.7	1.02 H	230	42.71	2.59
6	4960.00	33.0 AV	54.0	-21.0	1.02 H	230	30.38	2.59

ANTENNA POLARITY & TEST DISTANCE: VERTICAL AT 3 M

NO.	FREQ. (MHz)	EMISSION LEVEL (dBuV/m)	LIMIT (dBuV/m)	MARGIN (dB)	ANTENNA HEIGHT (m)	TABLE ANGLE (Degree)	RAW VALUE (dBuV)	CORRECTION FACTOR (dB/m)
1	*2480.00	96.4 PK			1.69 V	272	100.18	-3.78
2	*2480.00	92.3 AV			1.69 V	272	96.03	-3.78
3	2483.50	51.7 PK	74.0	-22.4	1.69 V	272	55.42	-3.77
4	2483.50	38.5 AV	54.0	-15.5	1.69 V	272	42.28	-3.77
5	4960.00	45.8 PK	74.0	-28.2	1.15 V	193	43.24	2.59
6	4960.00	33.7 AV	54.0	-20.3	1.15 V	193	31.08	2.59

REMARKS:

1. Emission Level(dBuV/m) = Raw Value(dBuV) + Correction Factor(dB/m)
2. Correction Factor(dB/m) = Antenna Factor(dB/m) + Cable Factor(dB) – Pre-Amplifier Factor(dB)
3. The other emission levels were very low against the limit.
4. Margin value = Emission Level – Limit value
5. " * ": Fundamental frequency.



A D T

BELOW 1GHz WORST-CASE DATA

CHANNEL	TX Channel 19	DETECTOR FUNCTION	Quasi-Peak (QP)
FREQUENCY RANGE	30MHz ~ 1GHz		

ANTENNA POLARITY & TEST DISTANCE: HORIZONTAL AT 3 M								
NO.	FREQ. (MHz)	EMISSION LEVEL (dBuV/m)	LIMIT (dBuV/m)	MARGIN (dB)	ANTENNA HEIGHT (m)	TABLE ANGLE (Degree)	RAW VALUE (dBuV)	CORRECTION FACTOR (dB/m)
1	34.46	29.7 QP	40.0	-10.4	2.75 H	258	44.82	-15.17
2	178.46	19.6 QP	43.5	-24.0	2.61 H	240	34.20	-14.65
3	265.71	25.8 QP	46.0	-20.2	1.73 H	34	39.02	-13.23
4	327.35	30.3 QP	46.0	-15.7	2.04 H	49	41.78	-11.44
5	370.03	31.5 QP	46.0	-14.5	2.20 H	266	42.13	-10.64
6	749.98	27.8 QP	46.0	-18.2	1.07 H	247	31.51	-3.68

ANTENNA POLARITY & TEST DISTANCE: VERTICAL AT 3 M								
NO.	FREQ. (MHz)	EMISSION LEVEL (dBuV/m)	LIMIT (dBuV/m)	MARGIN (dB)	ANTENNA HEIGHT (m)	TABLE ANGLE (Degree)	RAW VALUE (dBuV)	CORRECTION FACTOR (dB/m)
1	35.53	33.4 QP	40.0	-6.6	1.26 V	34	48.55	-15.12
2	79.47	24.1 QP	40.0	-15.9	1.13 V	360	42.19	-18.05
3	116.38	24.5 QP	43.5	-19.0	1.00 V	242	40.78	-16.30
4	178.12	26.4 QP	43.5	-17.1	1.00 V	244	41.00	-14.63
5	326.38	25.7 QP	46.0	-20.3	1.00 V	111	37.14	-11.44
6	749.98	27.9 QP	46.0	-18.2	2.51 V	171	31.53	-3.68

REMARKS:

1. Emission Level(dBuV/m) = Raw Value(dBuV) + Correction Factor(dB/m)
2. Correction Factor(dB/m) = Antenna Factor(dB/m) + Cable Factor(dB) – Pre-Amplifier Factor(dB)
3. The other emission levels were very low against the limit.
4. Margin value = Emission Level – Limit value

4.2 CONDUCTED EMISSION MEASUREMENT

4.2.1 LIMITS OF CONDUCTED EMISSION MEASUREMENT

FREQUENCY OF EMISSION (MHz)	CONDUCTED LIMIT (dB μ V)	
	Quasi-peak	Average
0.15 ~ 0.5	66 to 56	56 to 46
0.5 ~ 5	56	46
5 ~ 30	60	50

- NOTE:** 1. The lower limit shall apply at the transition frequencies.
 2. The limit decreases in line with the logarithm of the frequency in the range of 0.15 to 0.50MHz.

4.2.2 TEST INSTRUMENTS

Description & Manufacturer	Model No.	Serial No.	Cal. Date	Cal. Due
ROHDE & SCHWARZ TEST RECEIVER	ESCS 30	100276	Apr. 18, 2014	Apr. 17, 2015
ROHDE & SCHWARZ Artificial Mains Network (for EUT)	ENV216	101197	Apr. 18, 2014	Apr. 17, 2015
LISN With Adapter (for EUT)	AD10	C10Ada-002	Apr. 18, 2014	Apr. 17, 2015
ROHDE & SCHWARZ Artificial Mains Network (for peripherals)	ESH3-Z5	100218	Nov. 25, 2014	Nov. 24, 2015
SCHWARZBECK Artificial Mains Network (For EUT)	NNLK8129	8129229	May 08, 2014	May 07, 2015
Software	ADT_Cond_V7.3.7	NA	NA	NA
RF cable (JYEBAO)	5D-FB	Cable-C10.01	Feb. 18, 2014	Feb. 17, 2015
SUHNER Terminator (For ROHDE & SCHWARZ LISN)	65BNC-5001	E1-011484	May 27, 2014	May 26, 2015
ROHDE & SCHWARZ Artificial Mains Network (For TV EUT)	ESH3-Z5	100220	Nov. 20, 2014	Nov. 19, 2015
LISN With Adapter (for TV EUT)	100220	N/A	Nov. 20, 2014	Nov. 19, 2015

- Notes: 1. The calibration interval of the above test instruments is 12 months and the calibrations are traceable to NML/ROC and NIST/USA.
 2. The test was performed in Shielded Room No. 10.
 3. The VCCI Site Registration No. C-1852.

4.2.3 TEST PROCEDURES

- The EUT was placed 0.4 meters from the conducting wall of the shielded room with EUT being connected to the power mains through a line impedance stabilization network (LISN). Other support units were connected to the power mains through another LISN. The two LISNs provide 50 ohm/ 50uH of coupling impedance for the measuring instrument.
- Both lines of the power mains connected to the EUT were checked for maximum conducted interference.
- The frequency range from 150kHz to 30MHz was searched. Emission levels under (Limit - 20dB) was not recorded.

NOTE: All modes of operation were investigated and the worst-case emissions are reported.

4.2.4 DEVIATION FROM TEST STANDARD

No deviation.

4.2.5 TEST SETUP

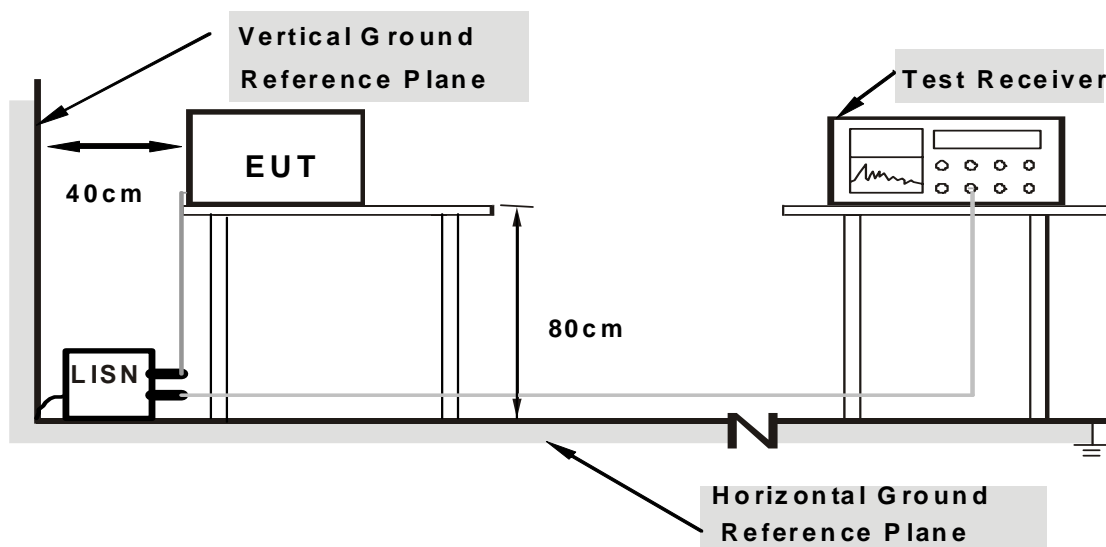

Note: Support units were connected to second LISN.

For the actual test configuration, please refer to the attached file (Test Setup Photo).

4.2.6 EUT OPERATING CONDITIONS

- Set the EUT under transmission condition continuously at specific channel frequency.
- EUT sent messages to monitor and monitor displayed it on screen.

4.2.7 TEST RESULTS

CONDUCTED WORST-CASE DATA :

PHASE	Line 1	6dB BANDWIDTH	9kHz
-------	--------	---------------	------

Phase Of Power : Line (L)										
No	Frequency (MHz)	Correction Factor (dB)	Reading Value (dBuV)		Emission Level (dBuV)		Limit (dBuV)		Margin (dB)	
			Q.P.	AV.	Q.P.	AV.	Q.P.	AV.	Q.P.	AV.
1	0.17997	9.66	42.51	33.58	52.17	43.24	64.49	54.49	-12.31	-11.24
2	0.23984	9.66	34.08	24.00	43.74	33.66	62.10	52.10	-18.36	-18.44
3	0.35958	9.67	32.84	25.61	42.51	35.28	58.74	48.74	-16.23	-13.46
4	0.59930	9.68	21.67	19.19	31.35	28.87	56.00	46.00	-24.65	-17.13
5	1.37500	9.69	20.94	16.32	30.63	26.01	56.00	46.00	-25.37	-19.99
6	4.05469	9.73	19.04	6.50	28.77	16.23	56.00	46.00	-27.23	-29.77
7	18.78125	9.95	19.86	12.69	29.81	22.64	60.00	50.00	-30.19	-27.36

Remarks:

1. Q.P. and AV. are abbreviations of quasi-peak and average individually.
2. The emission levels of other frequencies were very low against the limit.
3. Margin value = Emission level – Limit value
4. Correction factor = Insertion loss + Cable loss
5. Emission Level = Correction Factor + Reading Value

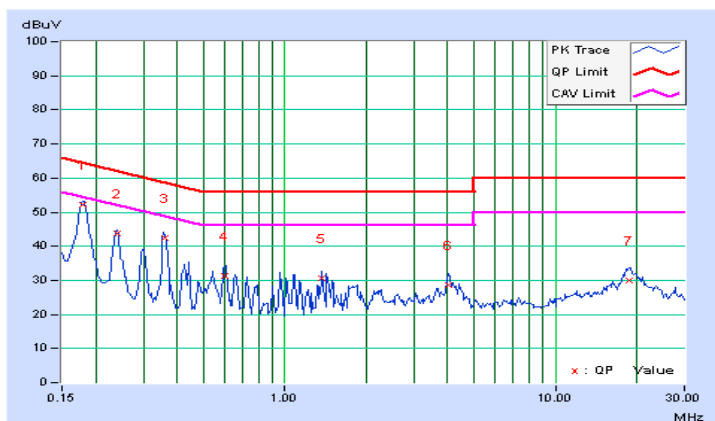



A D T

PHASE	Line 2	6dB BANDWIDTH	9kHz
-------	--------	---------------	------

Phase Of Power : Neutral (N)										
No	Frequency (MHz)	Correction Factor (dB)	Reading Value (dBuV)		Emission Level (dBuV)		Limit (dBuV)		Margin (dB)	
			Q.P.	AV.	Q.P.	AV.	Q.P.	AV.	Q.P.	AV.
1	0.18125	9.67	43.11	32.93	52.78	42.60	64.43	54.43	-11.65	-11.83
2	0.23984	9.67	34.96	24.22	44.63	33.89	62.10	52.10	-17.47	-18.21
3	0.35703	9.68	32.66	25.27	42.34	34.95	58.80	48.80	-16.46	-13.85
4	1.42969	9.69	20.41	15.86	30.10	25.55	56.00	46.00	-25.90	-20.45
5	4.10938	9.74	18.59	8.27	28.33	18.01	56.00	46.00	-27.67	-27.99
6	18.67969	9.97	18.94	11.45	28.91	21.42	60.00	50.00	-31.09	-28.58

Remarks:

1. Q.P. and AV. are abbreviations of quasi-peak and average individually.
2. The emission levels of other frequencies were very low against the limit.
3. Margin value = Emission level – Limit value
4. Correction factor = Insertion loss + Cable loss
5. Emission Level = Correction Factor + Reading Value

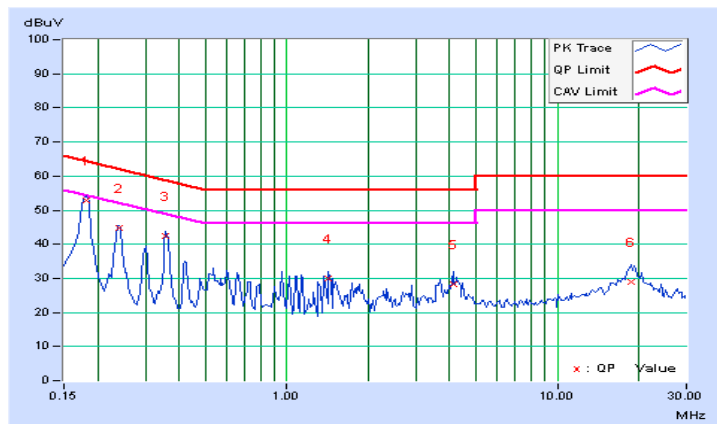

4.3 6dB BANDWIDTH MEASUREMENT

4.3.1 LIMITS OF 6dB BANDWIDTH MEASUREMENT

The minimum of 6dB Bandwidth Measurement is 0.5 MHz.

4.3.2 TEST SETUP

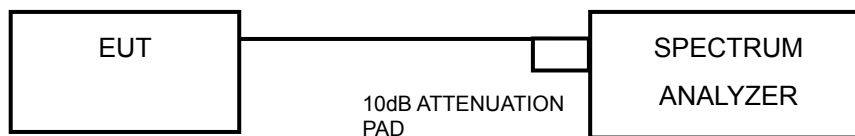

4.3.3 TEST INSTRUMENTS

Refer to section 4.1.2 to get information of above instrument.

4.3.4 TEST PROCEDURE

- Set resolution bandwidth (RBW) = 100kHz
- Set the video bandwidth (VBW) $\geq 3 \times$ RBW, Detector = Peak.
- Trace mode = max hold.
- Sweep = auto couple.
- Measure the maximum width of the emission that is constrained by the frequencies associated with the two amplitude points (upper and lower) that are attenuated by 6 dB relative to the maximum level measured in the fundamental emission

4.3.5 DEVIATION FROM TEST STANDARD

No deviation.

4.3.6 EUT OPERATING CONDITIONS

The software provided by client to enable the EUT under transmission condition continuously at lowest, middle and highest channel frequencies individually.



A D T

4.3.7 TEST RESULTS

CHANNEL	CHANNEL FREQUENCY (MHz)	6dB BANDWIDTH (MHz)	MINIMUM LIMIT (MHz)	PASS / FAIL
0	2402	0.69	0.5	PASS
19	2440	0.69	0.5	PASS
39	2480	0.69	0.5	PASS

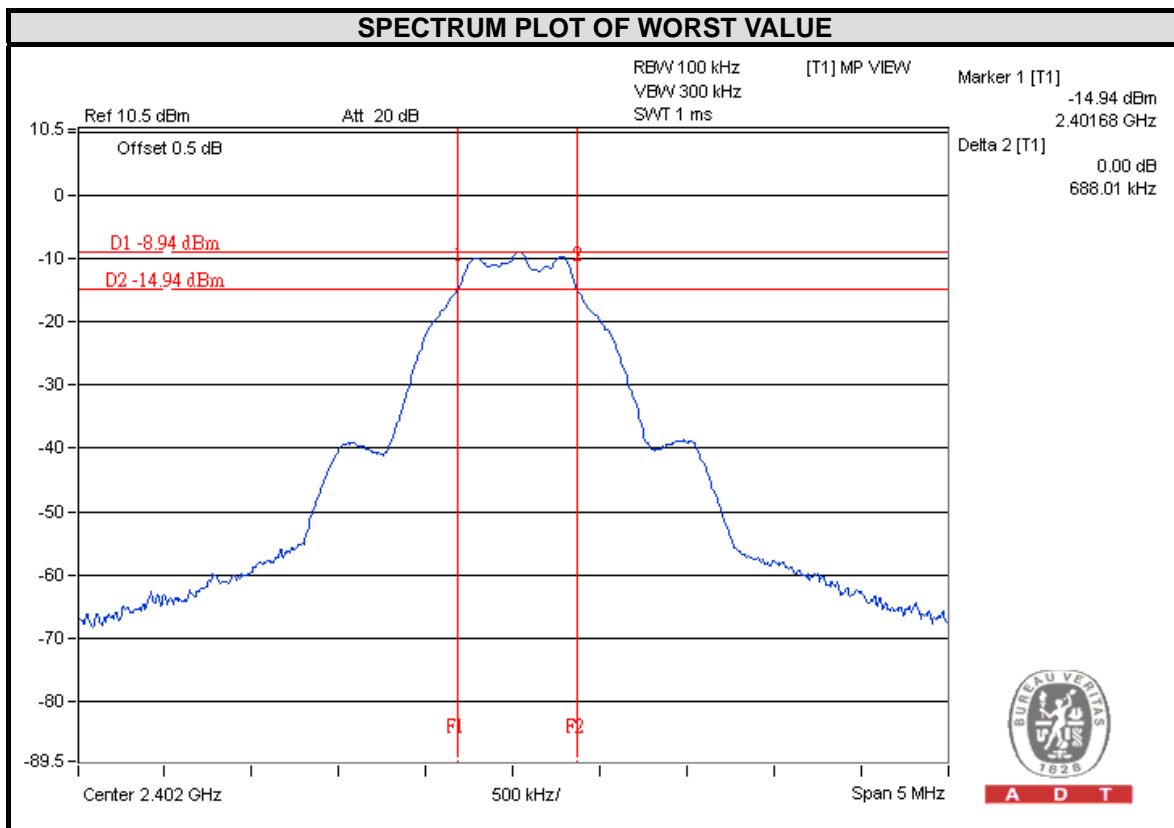

4.4 CONDUCTED OUTPUT POWER

4.4.1 LIMITS OF CONDUCTED OUTPUT POWER MEASUREMENT

For systems using digital modulation in the 2400–2483.5 MHz bands: 1 Watt (30dBm)

4.4.2 TEST SETUP

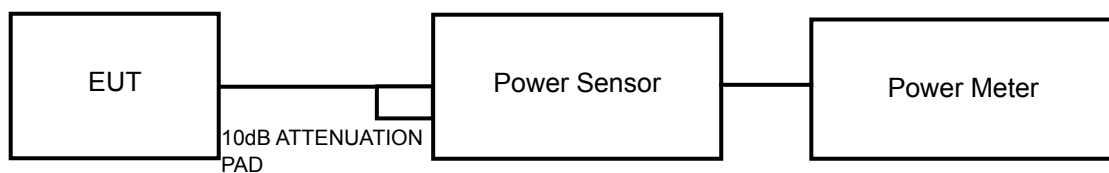

4.4.3 TEST INSTRUMENTS

Refer to section 4.1.2 to get information of above instrument.

4.4.4 TEST PROCEDURES

A peak / average power sensor were used on the output port of the EUT. A power meter was used to read the response of the peak / average power sensor. Record the power level.

4.4.5 DEVIATION FROM TEST STANDARD

No deviation.

4.4.6 EUT OPERATING CONDITIONS

Same as Item 4.3.6.



A D T

4.4.7 TEST RESULTS

FOR PEAK POWER

CHANNEL	FREQUENCY (MHz)	PEAK POWER (dBm)	PEAK POWER (mW)	LIMIT (dBm)	PASS/FAIL
0	2402	1.33	1.4	30	PASS
19	2440	1.95	1.6	30	PASS
39	2480	1.32	1.4	30	PASS

FOR AVERAGE POWER

CHANNEL	FREQUENCY (MHz)	AVERAGE POWER (dBm)
0	2402	1.11
19	2440	1.71
39	2480	1.12

4.5 POWER SPECTRAL DENSITY MEASUREMENT

4.5.1 LIMITS OF POWER SPECTRAL DENSITY MEASUREMENT

The Maximum of Power Spectral Density Measurement is 8dBm.

4.5.2 TEST SETUP

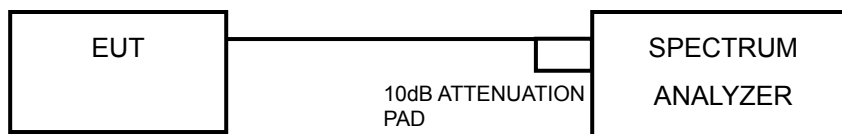

4.5.3 TEST INSTRUMENTS

Refer to section 4.1.2 to get information of above instrument.

4.5.4 TEST PROCEDURE

- Set the RBW = 3 kHz, VBW = 10 kHz, Detector = peak.
- Sweep time = auto couple, Trace mode = max hold, allow trace to fully stabilize.
- Use the peak marker function to determine the maximum power level in any 100 kHz band segment within the fundamental EBW.

4.5.5 DEVIATION FROM TEST STANDARD

No deviation.

4.5.6 EUT OPERATING CONDITION

Same as Item 4.3.6



A D T

4.5.7 TEST RESULTS

Channel	FREQ. (MHz)	PSD (dBm/3kHz)	Limit (dBm/3kHz)	PASS /FAIL
0	2402	-23.83	8	PASS
19	2440	-23.47	8	PASS
39	2480	-25.50	8	PASS

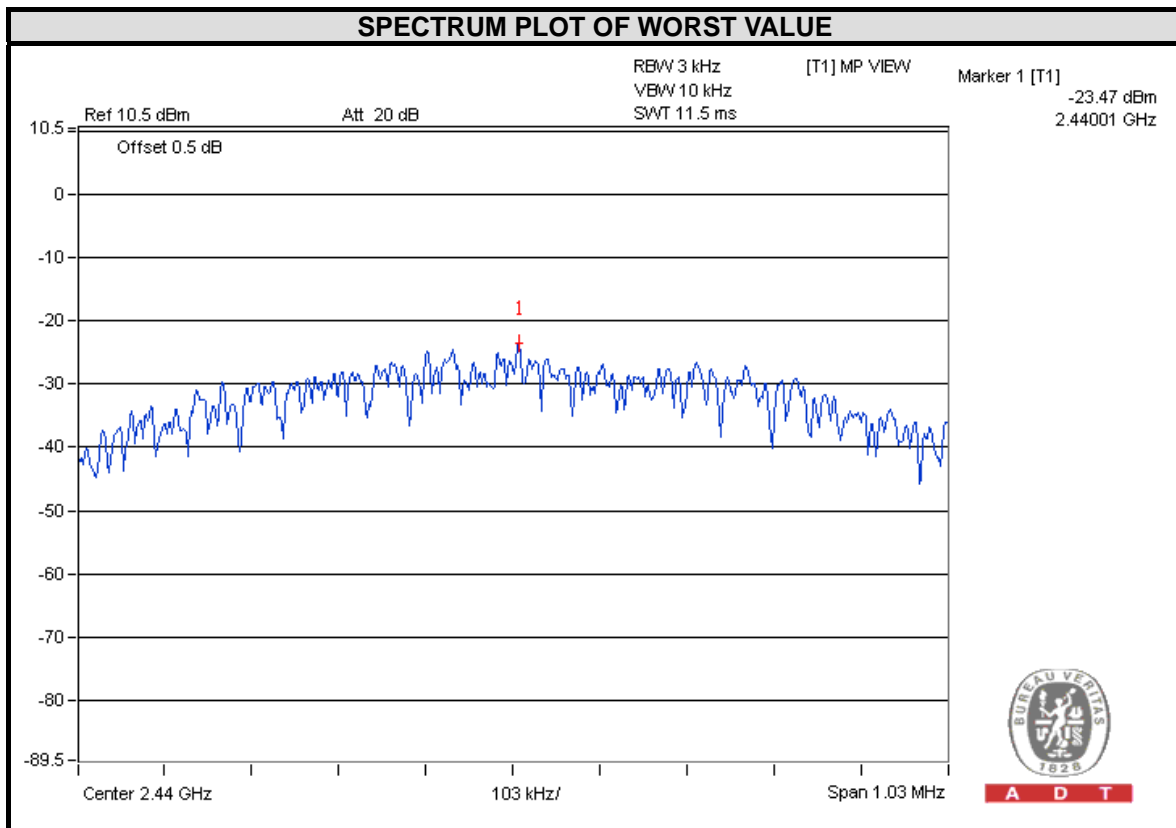

4.6 CONDUCTED OUT OF BAND EMISSION MEASUREMENT

4.6.1 LIMITS OF CONDUCTED OUT OF BAND EMISSION MEASUREMENT

Below -20dB of the highest emission level of operating band (in 100kHz Resolution Bandwidth).

4.6.2 TEST SETUP

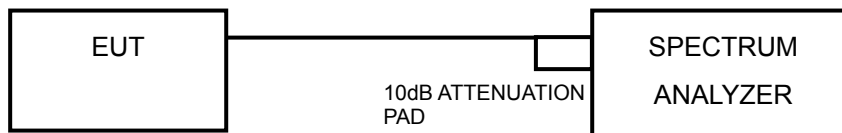

4.6.3 TEST INSTRUMENTS

Refer to section 4.1.2 to get information of above instrument.

4.6.4 TEST PROCEDURE

MEASUREMENT PROCEDURE REF

1. Set the RBW = 100 kHz.
2. Set the VBW \geq 300 kHz.
3. Detector = peak.
4. Sweep time = auto couple.
5. Trace mode = max hold.
6. Allow trace to fully stabilize.
7. Use the peak marker function to determine the maximum power level in any 100 kHz band segment within the fundamental EBW.

MEASUREMENT PROCEDURE OOB

1. Set RBW = 100 kHz.
2. Set VBW \geq 300 kHz.
3. Detector = peak.
4. Sweep = auto couple.
5. Trace Mode = max hold.
6. Allow trace to fully stabilize.
7. Use the peak marker function to determine the maximum amplitude level.

4.6.5 DEVIATION FROM TEST STANDARD

No deviation.

4.6.6 EUT OPERATING CONDITION

Same as Item 4.3.6

4.6.7 TEST RESULTS

The spectrum plots are attached on the following pages. D1 line indicates the highest level, and D2 line indicates the 20dB offset below D1. It shows compliance with the requirement.



A D T

CH 0

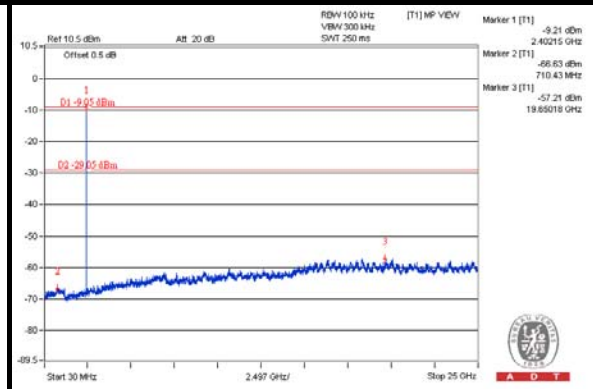
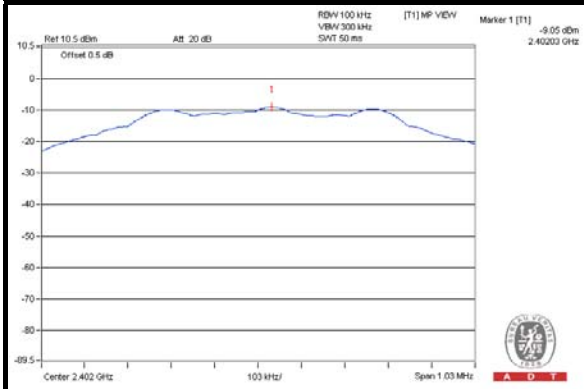

CH 19

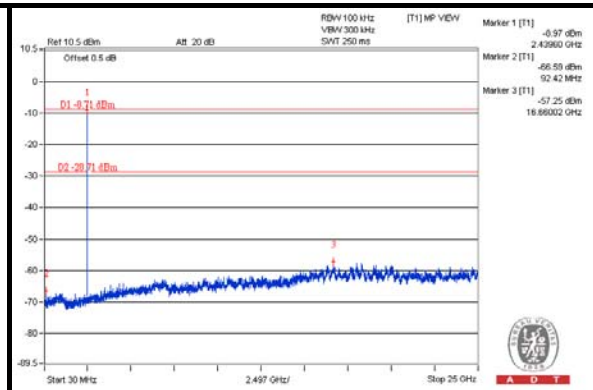
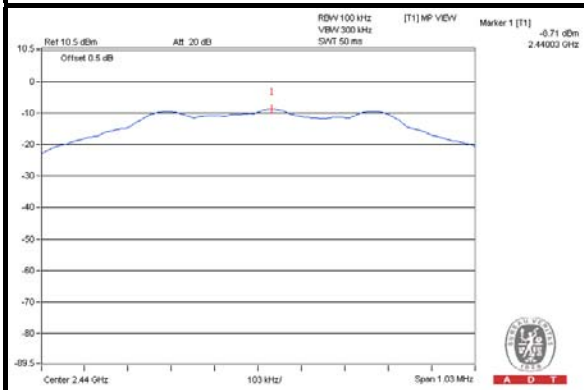

CH 39

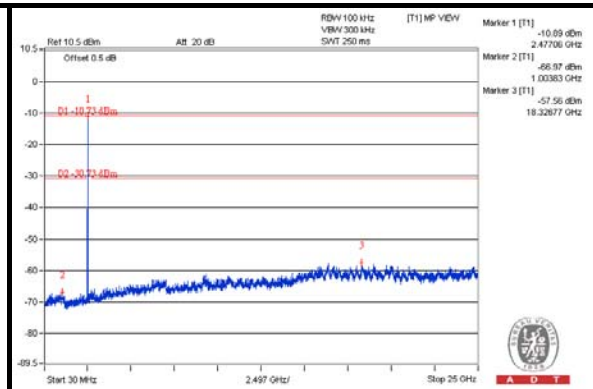
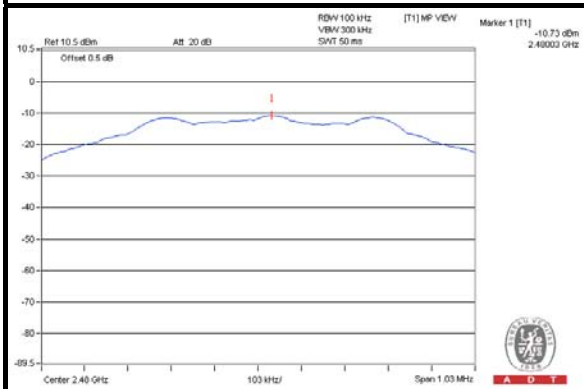

CH 0 Band edge

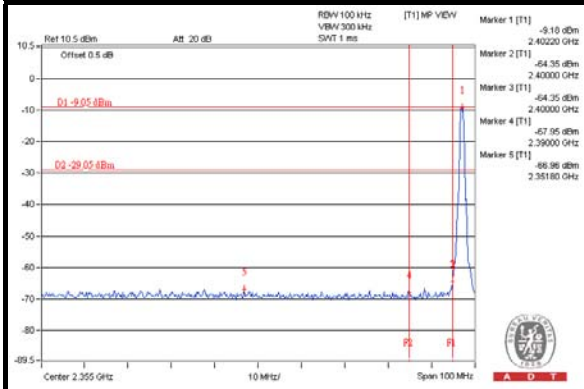

CH 39 Band edge

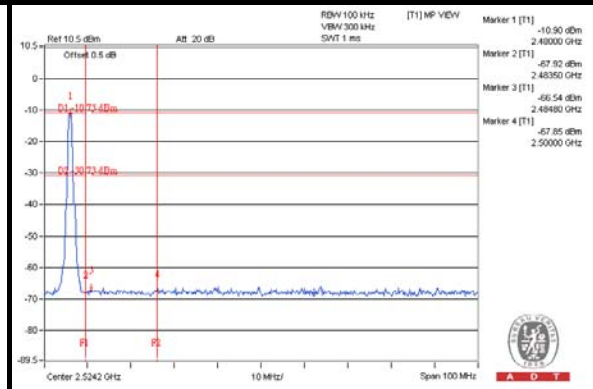



A D T

5. PHOTOGRAPHS OF THE TEST CONFIGURATION

Please refer to the attached file (Test Setup Photo).



6. INFORMATION ON THE TESTING LABORATORIES

We, Bureau Veritas Consumer Products Services (H.K.) Ltd., Taoyuan Branch, were founded in 1988 to provide our best service in EMC, Radio, Telecom and Safety consultation. Our laboratories are accredited and approved according to ISO/IEC 17025.

If you have any comments, please feel free to contact us at the following:

Linko EMC/RF Lab:

Tel: 886-2-26052180

Fax: 886-2-26051924

Hsin Chu EMC/RF/Telecom Lab:

Tel: 886-3-5935343

Fax: 886-3-5935342

Hwa Ya EMC/RF/Safety Lab:

Tel: 886-3-3183232

Fax: 886-3-3270892

Email: service.adt@tw.bureauveritas.com

Web Site: www.bureauveritas-adt.com

The address and road map of all our labs can be found in our web site also.



A D T

7. APPENDIX A - MODIFICATIONS RECORDERS FOR ENGINEERING CHANGES TO THE EUT BY THE LAB

No modifications were made to the EUT by the lab during the test.

--- END ---