

FCC Radio Test Report

FCC ID: QCI2075

This report concerns (check one): Original Grant Class I Change Class II Change

Project No. : 1703C171
Equipment : LCD MONITOR
Model Name : SBD-2075
Applicant : SMART Technologies Inc.
Address : 3636 Research Road, Calgary NT AB T2L
1Y1,CANADA

Date of Receipt : Mar. 21, 2017
Date of Test : Mar. 21, 2017 ~ Apr. 21, 2017
Issued Date : Apr. 24, 2017
Tested by : BTL Inc.

Testing Engineer : Shawn Xiao
(Shawn Xiao)

Technical Manager : David Mao
(David Mao)

Authorized Signatory : Steven Lu
(Steven Lu)

B T L I N C .

No.3, Jinshagang 1st Road, Shixia, Dalang Town, Dongguan,
Guangdong, China.

TEL: +86-769-8318-3000 FAX: +86-769-8319-6000

Declaration

BTL represents to the client that testing is done in accordance with standard procedures as applicable and that test instruments used has been calibrated with standards traceable to international standard(s) and/or national standard(s).

BTL's reports apply only to the specific samples tested under conditions. It is manufacture's responsibility to ensure that additional production units of this model are manufactured with the identical electrical and mechanical components. **BTL** shall have no liability for any declarations, inferences or generalizations drawn by the client or others from **BTL** issued reports.

BTL's report must not be used by the client to claim product certification, approval, or endorsement by NVLAP, NIST, or any agency of the Federal Government.

This report is the confidential property of the client. As a mutual protection to the clients, the public and **BTL-self**, extracts from the test report shall not be reproduced except in full with **BTL's** authorized written approval.

BTL's laboratory quality assurance procedures are in compliance with the **ISO Guide 17025** requirements, and accredited by the conformity assessment authorities listed in this test report.

Limitation

For the use of the authority's logo is limited unless the Test Standard(s)/Scope(s)/Item(s) mentioned in this test report is (are) included in the conformity assessment authorities acceptance respective.

Table of Contents	Page
1 . CERTIFICATION	6
2 . SUMMARY OF TEST RESULTS	7
2.1 TEST FACILITY	8
2.2 MEASUREMENT UNCERTAINTY	8
3 . GENERAL INFORMATION	9
3.1 GENERAL DESCRIPTION OF EUT	9
3.2 DESCRIPTION OF TEST MODES	10
3.3 TABLE OF PARAMETERS OF TEXT SOFTWARE SETTING	12
3.4 BLOCK DIAGRAM SHOWING THE CONFIGURATION OF SYSTEM TESTED	13
3.5 DESCRIPTION OF SUPPORT UNITS	13
4 . EMC EMISSION TEST	14
4.1 CONDUCTED EMISSION MEASUREMENT	14
4.1.1 POWER LINE CONDUCTED EMISSION LIMITS	14
4.1.2 TEST PROCEDURE	14
4.1.3 DEVIATION FROM TEST STANDARD	14
4.1.4 TEST SETUP	15
4.1.5 EUT OPERATING CONDITIONS	15
4.1.6 EUT TEST CONDITIONS	15
4.1.7 TEST RESULTS	15
4.2 RADIATED EMISSION MEASUREMENT	16
4.2.1 RADIATED EMISSION LIMITS	16
4.2.2 TEST PROCEDURE	17
4.2.3 DEVIATION FROM TEST STANDARD	17
4.2.4 TEST SETUP	18
4.2.5 EUT OPERATING CONDITIONS	19
4.2.6 EUT TEST CONDITIONS	19
4.2.7 TEST RESULTS (9KHZ TO 30MHZ)	19
4.2.8 TEST RESULTS (30MHZ TO 1000 MHZ)	19
4.2.9 TEST RESULTS (ABOVE 1000 MHZ)	19
5 . BANDWIDTH TEST	20
5.1 APPLIED PROCEDURES	20
5.1.1 TEST PROCEDURE	20
5.1.2 DEVIATION FROM STANDARD	20
5.1.3 TEST SETUP	20
5.1.4 EUT OPERATION CONDITIONS	20
5.1.5 EUT TEST CONDITIONS	20
5.1.6 TEST RESULTS	20
6 . MAXIMUM PEAK CONDUCTED OUTPUT POWER TEST	21

Table of Contents	Page
6.1 APPLIED PROCEDURES / LIMIT	21
6.1.1 TEST PROCEDURE	21
6.1.2 DEVIATION FROM STANDARD	21
6.1.3 TEST SETUP	21
6.1.4 EUT OPERATION CONDITIONS	21
6.1.5 EUT TEST CONDITIONS	21
6.1.6 TEST RESULTS	21
7 . ANTENNA CONDUCTED SPURIOUS EMISSION	22
7.1 APPLIED PROCEDURES / LIMIT	22
7.1.1 TEST PROCEDURE	22
7.1.2 DEVIATION FROM STANDARD	22
7.1.3 TEST SETUP	22
7.1.4 EUT OPERATION CONDITIONS	22
7.1.5 EUT TEST CONDITIONS	22
7.1.6 TEST RESULTS	22
8 . POWER SPECTRAL DENSITY TEST	23
8.1 APPLIED PROCEDURES / LIMIT	23
8.1.1 TEST PROCEDURE	23
8.1.2 DEVIATION FROM STANDARD	23
8.1.3 TEST SETUP	23
8.1.4 EUT OPERATION CONDITIONS	23
8.1.5 EUT TEST CONDITIONS	23
8.1.6 TEST RESULTS	23
9 . MEASUREMENT INSTRUMENTS LIST	24
10 . EUT TEST PHOTO	26
ATTACHMENT A - CONDUCTED EMISSION	30
ATTACHMENT B - RADIATED EMISSION (9KHZ TO 30MHZ)	33
ATTACHMENT C - RADIATED EMISSION (30MHZ TO 1000MHZ)	38
ATTACHMENT D - RADIATED EMISSION (ABOVE 1000MHZ)	45
ATTACHMENT E - BANDWIDTH	82
ATTACHMENT F – MAXIMUM PEAK CONDUCTED OUTPUT POWER	89
ATTACHMENT G - ANTENNA CONDUCTED SPURIOUS EMISSION	91
ATTACHMENT H - POWER SPECTRAL DENSITY	110

REPORT ISSUED HISTORY

Issued No.	Description	Issued Date
BTL-FCCP-3-1703C171	Original Issue.	Apr. 24, 2017

1. CERTIFICATION

Equipment : LCD MONITOR
Brand Name : SMART
Model Name : SBD-2075
Applicant : SMART Technologies Inc.
Manufacturer : MART TECHNOLOGIES ULC
Address : 3636 Research Road, Calgary NT AB T2L 1Y1,CANADA
Factory : HONGFUJIN PRECISION ELECTRONICS (CHONGQING) CO.,LTD
Address : NO.1 EAST DISTRICT 1ST RD.,SHAPINGBA
DISTRICT,CHONGQING,401332
Date of Test : Mar. 21, 2017 ~ Apr. 21, 2017
Test Sample : Engineering Sample
Standard(s) : FCC Part15, Subpart C:(15.247) / ANSI C63.10-2013

The above equipment has been tested and found compliance with the requirement of the relative standards by BTL Inc.

The test data, data evaluation, and equipment configuration contained in our test report (Ref No. BTL-FCCP-3-1703C171) were obtained utilizing the test procedures, test instruments, test sites that has been accredited by the Authority of TAF according to the ISO-17025 quality assessment standard and technical standard(s).

Test results included in this report is only for the WLAN 2.4GHz part.

2. SUMMARY OF TEST RESULTS

Test procedures according to the technical standard(s):

Applied Standard(s): FCC Part15 (15.247) , Subpart C				
Standard(s)	Section	Test Item	Judgment	Remark
	15.207	Conducted Emission	PASS	
	15.247(d)	Antenna conducted Spurious Emission	PASS	
	15.247(a)(2)	6dB Bandwidth	PASS	
	15.247(b)(3)	Peak Output Power	PASS	
	15.247(e)	Power Spectral Density	PASS	
	15.203	Antenna Requirement	PASS	
	15.247(d)/ 15.205/ 15.209	Transmitter Radiated Emissions	PASS	

NOTE:

(1) "N/A" denotes test is not applicable in this test report.

2.1 TEST FACILITY

The test facilities used to collect the test data in this report is at the location of No.3,Jinshagang 1st Road, Shixia, Dalang Town, Dongguan, Guangdong, China.
 BTL's test firm number for FCC: 319330

2.2 MEASUREMENT UNCERTAINTY

Where relevant, the following measurement uncertainty levels have been estimated for tests performed on the EUT as specified in CISPR 16-4-2. The BTL measurement uncertainty is less than the CISPR 16-4-2 U_{cispr} requirement.

The reported uncertainty of measurement $y \pm U$, where expanded uncertainty U is based on a standard uncertainty multiplied by a coverage factor of $k=2$, providing a level of confidence of approximately 95 %.

A. Conducted Measurement:

Test Site	Method	Measurement Frequency Range	U, (dB)
DG-C02	CISPR	150 KHz ~ 30MHz	2.32

B. Radiated Measurement:

Test Site	Method	Measurement Frequency Range	Ant. H / V	U, (dB)
DG-CB03	CISPR	9KHz~30MHz	V	3.79
		9KHz~30MHz	H	3.57
		30MHz ~ 200MHz	V	3.82
		30MHz ~ 200MHz	H	3.78
		200MHz ~ 1,000MHz	V	4.10
		200MHz ~ 1,000MHz	H	4.06
		1GHz~18GHz	V	3.12
		1GHz~18GHz	H	3.68
		18GHz~40GHz	V	4.15
		18GHz~40GHz	H	4.14

Note: Unless specifically mentioned, the uncertainty of measurement has not been taken into account to declare the compliance or non-compliance to the specification.

3. GENERAL INFORMATION

3.1 GENERAL DESCRIPTION OF EUT

Equipment	LCD MONITOR	
Brand Name	SMART	
Model Name	SBD-2075	
Model Difference	N/A	
Product Description	Operation Frequency	2412~2462 MHz
	Modulation Technology	802.11b:DSSS 802.11g:OFDM 802.11n:OFDM
	Bit Rate of Transmitter	802.11b: 11/5.5/2/1 Mbps 802.11g: 54/48/36/24/18/12/9/6 Mbps 802.11n up to 150 Mbps
	Output Power (Max.)	802.11b: 16.80dBm 802.11g: 22.42dBm 802.11n(20MHz): 22.02dBm
Power Source	AC Mains.	
Power Rating	Input: 100-240V~, 3.5-1.5A, 50-60Hz Output: 100-240V~, 50-60Hz,1A max	

Note:

- For a more detailed features description, please refer to the manufacturer's specifications or the user's manual.
- Channel List:

CH01 – CH11 for 802.11b, 802.11g, 802.11n(20MHz)							
Channel	Frequency (MHz)	Channel	Frequency (MHz)	Channel	Frequency (MHz)	Channel	Frequency (MHz)
01	2412	04	2427	07	2442	10	2457
02	2417	05	2432	08	2447	11	2462
03	2422	06	2437	09	2452		

3. Table for Filed Antenna

Ant.	Brand	Model Name	Antenna Type	Connector	Gain (dBi)
1	FOXCONN	ANTS2M2-CZZ02-EF	Internal	N/A	2.732

3.2 DESCRIPTION OF TEST MODES

To investigate the maximum EMI emission characteristics generates from EUT, the test system was pre-scanning tested base on the consideration of following EUT operation mode or test configuration mode which possible have effect on EMI emission level. Each of these EUT operation mode(s) or test configuration mode(s) mentioned above was evaluated respectively.

Pretest Mode	Description
Mode 1	TX B MODE CHANNEL 01/06/11
Mode 2	TX G MODE CHANNEL 01/06/11
Mode 3	TX N-20MHZ MODE CHANNEL 01/06/11
Mode 4	TX Mode

The EUT system operated these modes were found to be the worst case during the pre-scanning test as following:

For Conducted Test	
Final Test Mode	Description
Mode 5	TX Mode

For Radiated Test	
Final Test Mode	Description
Mode 1	TX B MODE CHANNEL 01/06/11
Mode 2	TX G MODE CHANNEL 01/06/11
Mode 3	TX N-20MHZ MODE CHANNEL 01/06/11

For Band Edge Test	
Final Test Mode	Description
Mode 1	TX B MODE CHANNEL 01/06/11
Mode 2	TX G MODE CHANNEL 01/06/11
Mode 3	TX N-20MHZ MODE CHANNEL 01/06/11

6dB Spectrum Bandwidth	
Final Test Mode	Description
Mode 1	TX B MODE CHANNEL 01/06/11
Mode 2	TX G MODE CHANNEL 01/06/11
Mode 3	TX N-20MHZ MODE CHANNEL 01/06/11

Maximum Conducted Output Power	
Final Test Mode	Description
Mode 1	TX B MODE CHANNEL 01/06/11
Mode 2	TX G MODE CHANNEL 01/06/11
Mode 3	TX N-20MHZ MODE CHANNEL 01/06/11

Power Spectral Density	
Final Test Mode	Description
Mode 1	TX B MODE CHANNEL 01/06/11
Mode 2	TX G MODE CHANNEL 01/06/11
Mode 3	TX N-20MHZ MODE CHANNEL 01/06/11

Note:

- (1) The measurements are performed at the high, middle, low available channels.
- (2) 802.11b mode: DBPSK (1Mbps)
 802.11g mode: OFDM (6Mbps)
 802.11n HT20 mode : BPSK (6.5Mbps)
 For radiated emission tests, the highest output powers were set for final test.
- (3) For radiated below 1G test, the 802.11b is found to be the worst case and recorded.
- (4) The EUT was programmed to be in continuously transmitting mode and the transmit duty cycle is not less than 98%.

3.3 TABLE OF PARAMETERS OF TEXT SOFTWARE SETTING

During testing, channel & power controlling software provided by the customer was used to control the operating channel as well as the output power level. The RF output power selection is for the setting of RF output power expected by the customer and is going to be fixed on the firmware of the final end product power parameters of WLAN

Test software version	RFTestTool		
Frequency (MHz)	2412	2437	2462
802.11b	N/A	N/A	N/A
802.11g	N/A	N/A	N/A
802.11n (20MHz)	N/A	N/A	N/A

3.4 BLOCK DIAGRAM SHOWING THE CONFIGURATION OF SYSTEM TESTED

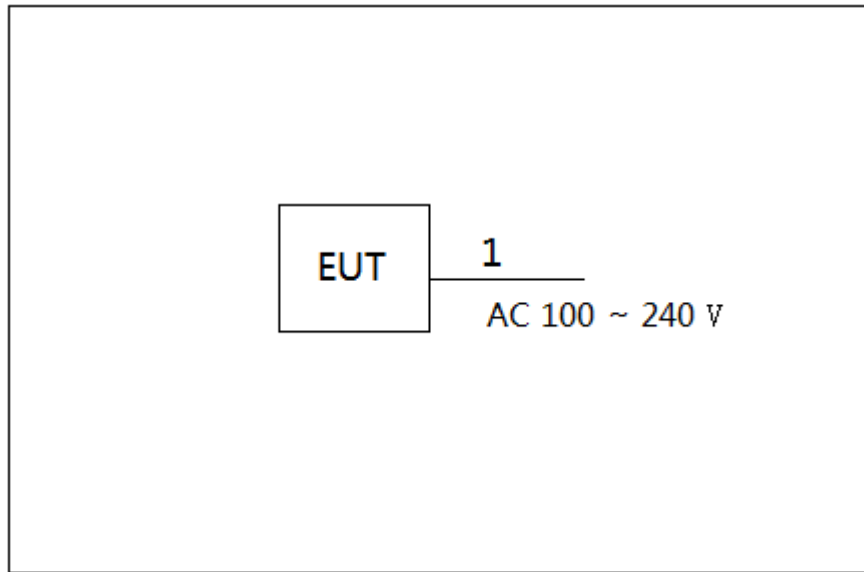

3.5 DESCRIPTION OF SUPPORT UNITS

The EUT has been tested as an independent unit together with other necessary accessories or support units. The following support units or accessories were used to form a representative test configuration during the tests.

Item	Equipment	Mfr/Brand	Model/Type No.	FCC ID
-	-	-	-	-

Item	Shielded Type	Ferrite Core	Length	Note
1	NO	NO	1.8m	AC Cable

4. EMC EMISSION TEST

4.1 CONDUCTED EMISSION MEASUREMENT

4.1.1 POWER LINE CONDUCTED EMISSION LIMITS (Frequency Range 150KHz-30MHz)

Frequency of Emission (MHz)	Conducted Limit (dBµV)	
	Quasi-peak	Average
0.15 -0.50	66 to 56*	56 to 46*
0.50 -5.0	56	46
5.0 -30.0	60	50

Note:

- (1) The limit of " * " decreases with the logarithm of the frequency
- (2) The test result calculated as following:
 Measurement Value = Reading Level + Correct Factor
 Correct Factor = Insertion Loss + Cable Loss + Attenuator Factor(if use)
 Margin Level = Measurement Value - Limit Value

The following table is the setting of the receiver

Receiver Parameters	Setting
Attenuation	10 dB
Start Frequency	0.15 MHz
Stop Frequency	30 MHz
IF Bandwidth	9 KHz

4.1.2 TEST PROCEDURE

- a. The EUT was placed 0.8 meters from the horizontal ground plane with EUT being connected to the power mains through a line impedance stabilization network (LISN). All other support equipments powered from additional LISN(s). The LISN provide 50 Ohm/ 50uH of coupling impedance for the measuring instrument.
- b. Interconnecting cables that hang closer than 40 cm to the ground plane shall be folded back and forth in the center forming a bundle 30 to 40 cm long.
- c. I/O cables that are not connected to a peripheral shall be bundled in the center. The end of the cable may be terminated, if required, using the correct terminating impedance. The overall length shall not exceed 1 m.
- d. LISN at least 80 cm from nearest part of EUT chassis.
- e. For the actual test configuration, please refer to the related Item –EUT Test Photos.

4.1.3 DEVIATION FROM TEST STANDARD

No deviation

4.1.4 TEST SETUP

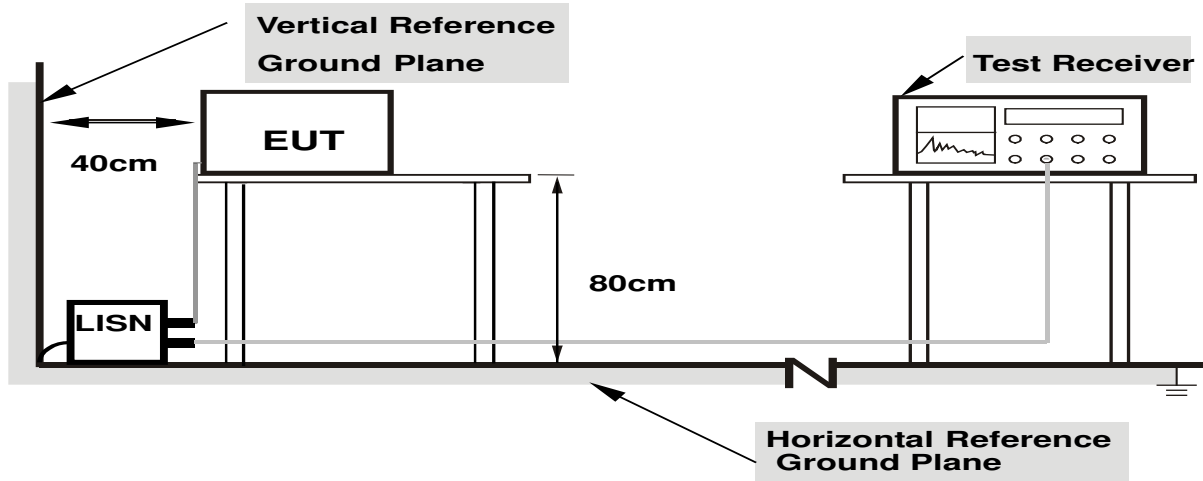

- Note:**
1. Support units were connected to second LISN.
 2. Both of LISNs (AMN) are 80 cm from EUT and at least 80 from other units and other metal planes

4.1.5 EUT OPERATING CONDITIONS

The EUT was placed on the test table and programmed in normal function.

4.1.6 EUT TEST CONDITIONS

Temperature: 25°C Relative Humidity: 55% Test Voltage: AC 120V/60Hz

4.1.7 TEST RESULTS

Please refer to the Attachment A.

4.2 RADIATED EMISSION MEASUREMENT

4.2.1 RADIATED EMISSION LIMITS

In case the emission fall within the restricted band specified on 15.205(a), then the 15.209(a) limit in the table below has to be followed.

LIMITS OF RADIATED EMISSION MEASUREMENT (9KHz-1000MHz)

Frequency (MHz)	Field Strength (microvolts/meter)	Measurement Distance (meters)
0.009~0.490	2400/F(KHz)	300
0.490~1.705	24000/F(KHz)	30
1.705~30.0	30	30
30~88	100	3
88~216	150	3
216~960	200	3
960~1000	500	3

LIMITS OF RADIATED EMISSION MEASUREMENT (Above 1000MHz)

Frequency (MHz)	(dBuV/m) (at 3 meters)	
	PEAK	AVERAGE
Above 1000	74	54

Notes:

- (1) The limit for radiated test was performed according to FCC PART 15C.
- (2) The tighter limit applies at the band edges.
- (3) Emission level (dBuV/m)=20log Emission level (uV/m).
- (4) The test result calculated as following:
 Measurement Value = Reading Level + Correct Factor
 Correct Factor = Antenna Factor + Cable Loss - Amplifier Gain(if use)
 Margin Level = Measurement Value - Limit Value

Spectrum Parameter	Setting
Attenuation	Auto
Start Frequency	1000 MHz
Stop Frequency	10th carrier harmonic
RBW / VBW (Emission in restricted band)	1MHz / 3MHz for Peak, 1MHz / 1/T for Average

Receiver Parameter	Setting
Attenuation	Auto
Start ~ Stop Frequency	9KHz~90KHz for PK/AVG detector
Start ~ Stop Frequency	90KHz~110KHz for QP detector
Start ~ Stop Frequency	110KHz~490KHz for PK/AVG detector
Start ~ Stop Frequency	490KHz~30MHz for QP detector
Start ~ Stop Frequency	30MHz~1000MHz for QP detector

4.2.2 TEST PROCEDURE

- a. The measuring distance of 3 m shall be used for measurements. The EUT was placed on the top of a rotating table 0.8 meter above the ground at a 3 meter semi-anechoic chamber. The table was rotated 360 degrees to determine the position of the highest radiation.(below 1GHz)
- b. The measuring distance of 3 m shall be used for measurements. The EUT was placed on the top of a rotating table 1.5 meter above the ground at a 3 meter semi-anechoic chamber. The table was rotated 360 degrees to determine the position of the highest radiation.(above 1GHz)
- c. The height of the equipment or of the substitution antenna shall be 0.8m or 1.5m; the height of the test antenna shall vary between 1 m to 4 m. Both horizontal and vertical polarizations of the antenna are set to make the measurement.
- d. For each suspected emission, the EUT was arranged to its worst case and then the antenna was tuned to heights find the maximum reading (used Bore sight function).
- e. The receiver system was set to peak and average detect function and specified bandwidth with maximum hold mode when the test frequency is above 1GHz.
- f. The initial step in collecting radiated emission data is a receiver peak detector mode pre-scanning the measurement frequency range. Significant peaks are then marked and then Quasi Peak detector mode re-measured.
- g. All readings are Peak unless otherwise stated QP in column of Note. Peak denotes that the Peak reading compliance with the QP Limits and then QP Mode measurement didn't perform. (below 1GHz)
- h. All readings are Peak Mode value unless otherwise stated AVG in column of Note. If the Peak Mode Measured value compliance with the Peak Limits and lower than AVG Limits, the EUT shall be deemed to meet both Peak & AVG Limits and then only Peak Mode was measured, but AVG Mode didn't perform. (above 1GHz)
- i. For the actual test configuration, please refer to the related Item –EUT Test Photos.

4.2.3 DEVIATION FROM TEST STANDARD

No deviation

4.2.4 TEST SETUP

(A) Radiated Emission Test Set-Up Frequency Below 1 GHz

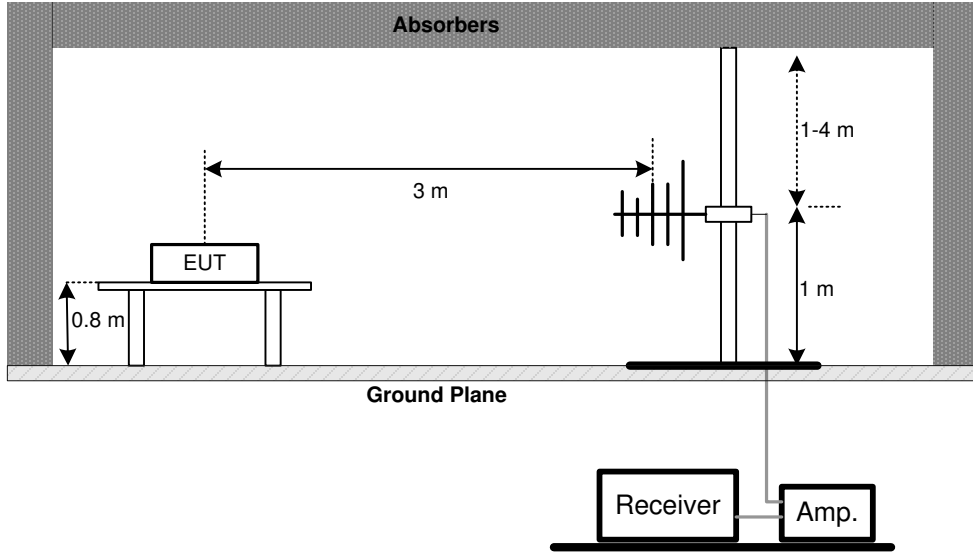

(B) Radiated Emission Test Set-Up Frequency Above 1 GHz

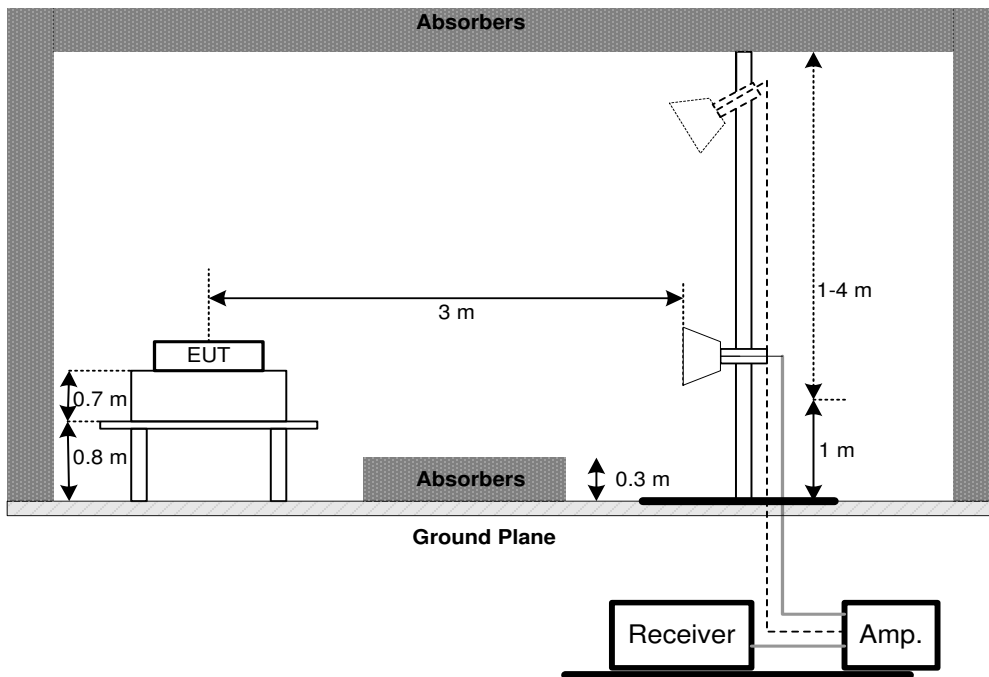

(C) For Radiated Emissions Below 30MHz

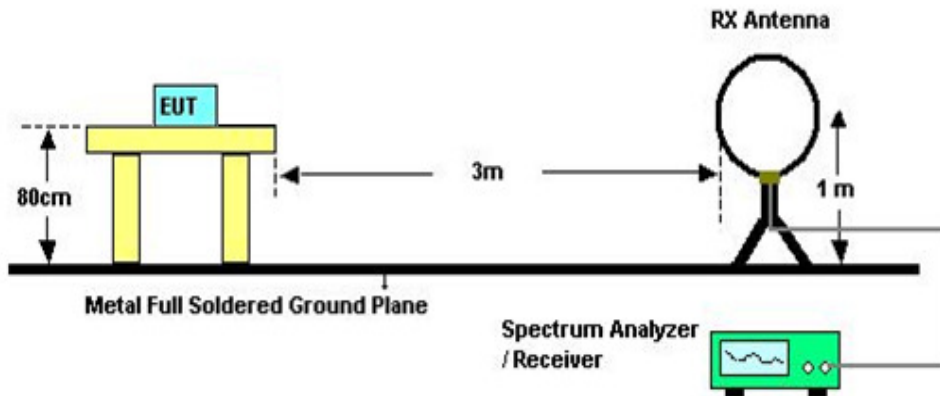

4.2.5 EUT OPERATING CONDITIONS

The EUT was programmed to be in continuously transmitting mode.

4.2.6 EUT TEST CONDITIONS

Temperature: 25°C Relative Humidity: 55% Test Voltage: AC 120V/60Hz

4.2.7 TEST RESULTS (9KHZ TO 30MHZ)

Please refer to the Attachment B

Remark:

- (1) The amplitude of spurious emissions which are attenuated by more than 20 dB below the permissible value has no need to be reported.
- (2) Distance extrapolation factor = $40 \log(\text{specific distance} / \text{test distance})$ (dB).
- (3) Limit line = specific limits (dBuV) + distance extrapolation factor.

4.2.8 TEST RESULTS (30MHZ TO 1000 MHZ)

Please refer to the Attachment C.

4.2.9 TEST RESULTS (ABOVE 1000 MHZ)

Please refer to the Attachment D.

Remark:

- (1) No limit: This is fundamental signal, the judgment is not applicable. For fundamental signal judgment was referred to Peak output test.

5. BANDWIDTH TEST

5.1 APPLIED PROCEDURES

FCC Part15 (15.247) , Subpart C			
Section	Test Item	Frequency Range (MHz)	Result
15.247(a)(2)	Bandwidth	2400-2483.5	PASS

5.1.1 TEST PROCEDURE

- a. The EUT was directly connected to the spectrum analyzer and antenna output port as show in the block diagram below,
- b. Spectrum Setting: RBW= 100KHz, VBW=300KHz, Sweep time = 2.5 ms.

5.1.2 DEVIATION FROM STANDARD

No deviation.

5.1.3 TEST SETUP

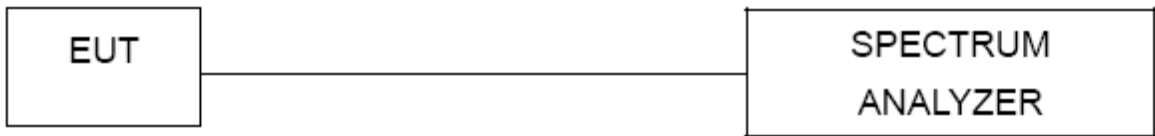

5.1.4 EUT OPERATION CONDITIONS

The EUT was programmed to be in continuously transmitting mode.

5.1.5 EUT TEST CONDITIONS

Temperature: 25°C Relative Humidity: 55% Test Voltage: AC 120V/60Hz

5.1.6 TEST RESULTS

Please refer to the Attachment E.

6. MAXIMUM PEAK CONDUCTED OUTPUT POWER TEST

6.1 APPLIED PROCEDURES / LIMIT

FCC Part15 (15.247) , Subpart C				
Section	Test Item	Limit	Frequency Range (MHz)	Result
15.247(b)(3)	Maximum Output Power	1 Watt or 30dBm	2400-2483.5	PASS

6.1.1 TEST PROCEDURE

- a. The EUT was directly connected to the power meter and antenna output port as show in the block diagram below,
- b. The maximum peak conducted output power was performed in accordance with method 9.1.2 of FCC KDB 558074 D01 DTS Meas Guidance.

6.1.2 DEVIATION FROM STANDARD

No deviation.

6.1.3 TEST SETUP



6.1.4 EUT OPERATION CONDITIONS

The EUT was programmed to be in continuously transmitting mode.

6.1.5 EUT TEST CONDITIONS

Temperature: 25°C Relative Humidity: 55% Test Voltage: AC 120V/60Hz

6.1.6 TEST RESULTS

Please refer to the Attachment F.

7. ANTENNA CONDUCTED SPURIOUS EMISSION

7.1 APPLIED PROCEDURES / LIMIT

In any 100 kHz bandwidth outside the frequency band in which the spread spectrum or digitally modulated device is operating, the RF power that is produced shall be at least 20 dB below that in the 100 kHz bandwidth within the band that contains the highest level of the desired power, based on either an RF conducted or a radiated measurement, provided that the transmitter demonstrates compliance with the peak conducted power limits.

7.1.1 TEST PROCEDURE

- a. The EUT was directly connected to the spectrum analyzer and antenna output port as show in the block diagram below,
- b. Spectrum Setting: RBW= 100KHz, VBW=300KHz, Sweep time = Auto.
- c. Offset=antenna gain+cable loss

7.1.2 DEVIATION FROM STANDARD

No deviation.

7.1.3 TEST SETUP

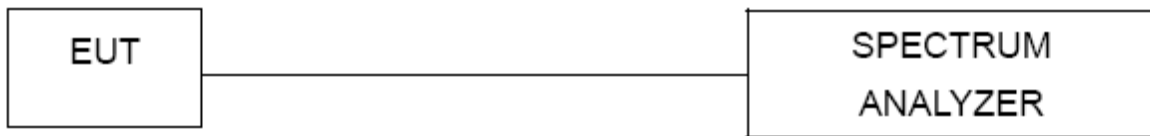

7.1.4 EUT OPERATION CONDITIONS

The EUT was programmed to be in continuously transmitting mode.

7.1.5 EUT TEST CONDITIONS

Temperature: 25°C Relative Humidity: 55% Test Voltage: AC 120V/60Hz

7.1.6 TEST RESULTS

Please refer to the Attachment G.

8. POWER SPECTRAL DENSITY TEST

8.1 APPLIED PROCEDURES / LIMIT

FCC Part15 (15.247) , Subpart C				
Section	Test Item	Limit	Frequency Range (MHz)	Result
15.247(e)	Power Spectral Density	8 dBm (in any 3KHz)	2400-2483.5	PASS

8.1.1 TEST PROCEDURE

- a. The EUT was directly connected to the spectrum analyzer and antenna output port as show in the block diagram below,
- b. Spectrum Setting: RBW=3KHz, VBW=10KHz, Sweep time = Auto.

8.1.2 DEVIATION FROM STANDARD

No deviation.

8.1.3 TEST SETUP

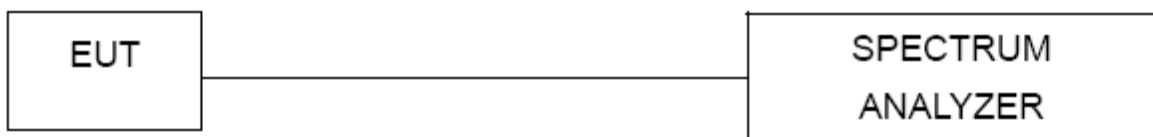

8.1.4 EUT OPERATION CONDITIONS

The EUT was programmed to be in continuously transmitting mode.

8.1.5 EUT TEST CONDITIONS

Temperature: 25°C Relative Humidity: 55% Test Voltage: AC 120V/60Hz

8.1.6 TEST RESULTS

Please refer to the Attachment H.

9. MEASUREMENT INSTRUMENTS LIST

Conducted Emission Measurement					
Item	Kind of Equipment	Manufacturer	Type No.	Serial No.	Calibrated until
1	LISN	EMCO	3816/2	0052765	Mar. 26, 2018
2	LISN	R&S	ENV216	101447	Mar. 26, 2018
3	Test Cable	emci	RG223(9KHz-30MHz)	C_17	Mar. 09, 2018
4	EMI Test Receiver	R&S	ESCI	100382	Mar. 26, 2018
5	50Ω Terminator	SHX	TF2-3G-A	08122901	Mar. 26, 2018
6	Measurement Software	Farad	EZ-EMC Ver.NB-03A1-01	N/A	N/A

Radiated Emission Measurement					
Item	Kind of Equipment	Manufacturer	Type No.	Serial No.	Calibrated until
1	Antenna	Schwarzbeck	VULB9160	9160-3232	Mar. 26, 2018
2	Amplifier	HP	8447D	2944A09673	Feb. 22, 2018
3	Receiver	AGILENT	N9038A	MY52130039	Jun. 23, 2017
4	Test Cable	emci	LMR-400(30MHz-1GHz)	C-01	Jun. 26, 2017
5	Control	CT	SC100	N/A	N/A
6	Position Control	MF	MF-7802	MF780208416	N/A
7	Antenna	ETS	3115	00075789	Mar. 26, 2018
8	Amplifier	Agilent	8449B	3008A02274	Feb. 22, 2018
9	Receiver	AGILENT	N9038A	MY52130039	Jun. 23, 2017
10	Test Cable	emci	EMC104-SM-SM-10000(1GHz-26.5GHz)	C-68	Jun. 26, 2017
11	Controller	CT	SC100	N/A	N/A
12	Broad-Band Horn Antenna	Schwarzbeck	BBHA 9170	9170319	Apr. 23, 2017
13	Microwave Pre-amplifier With Adaptor	EMC INSTRUMENT	EMC2654045	980039 & HA01	Mar. 26, 2018
14	Active Loop Antenna	R&S	HFH2-Z2	830749/020	Sep. 06, 2017
15	Measurement Software	Farad	EZ-EMC Ver.NB-03A1-01	N/A	N/A

6dB Bandwidth Measurement					
Item	Kind of Equipment	Manufacturer	Type No.	Serial No.	Calibrated until
1	Spectrum Analyzer	R&S	FSP 40	100185	Sep. 04, 2017

Peak Output Power Measurement					
Item	Kind of Equipment	Manufacturer	Type No.	Serial No.	Calibrated until
1	P-series Power meter	Agilent	N1911A	MY45100473	Sep. 04, 2017
2	Wireband Power sensor	Agilent	N1921A	MY51100041	Sep. 04, 2017

Antenna Conducted Spurious Emission Measurement					
Item	Kind of Equipment	Manufacturer	Type No.	Serial No.	Calibrated until
1	Spectrum Analyzer	R&S	FSP 40	100185	Sep. 04, 2017

Power Spectral Density Measurement					
Item	Kind of Equipment	Manufacturer	Type No.	Serial No.	Calibrated until
1	Spectrum Analyzer	R&S	FSP 40	100185	Sep. 04, 2017

Remark: "N/A" denotes no model name, serial no. or calibration specified.
 All calibration period of equipment list is one year.

ATTACHMENT A - CONDUCTED EMISSION

Test Mode : TX Mode

Line

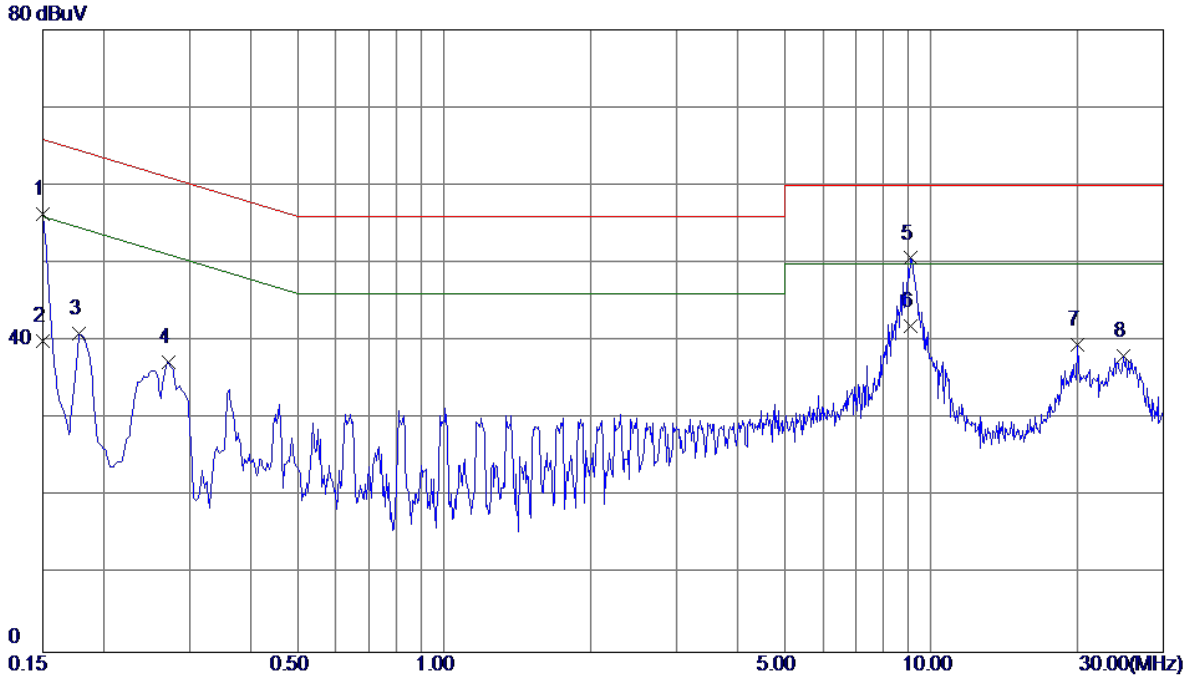

No.	Freq. MHz	Reading Level dBuV	Correct Factor dB	Measure ment dBuV	Limit dBuV	Margin dB	Detector	Comment
1	0.1500	46.74	9.57	56.31	66.00	-9.69	Peak	
2	0.1500	30.50	9.57	40.07	56.00	-15.93	AVG	
3	0.1780	31.33	9.57	40.90	64.58	-23.68	Peak	
4	0.2714	27.66	9.57	37.23	61.07	-23.84	Peak	
5	9.0700	40.18	10.46	50.64	60.00	-9.36	Peak	
6 *	9.0700	31.50	10.46	41.96	50.00	-8.04	AVG	
7	20.0220	28.74	10.80	39.54	60.00	-20.46	Peak	
8	24.8860	27.20	10.84	38.04	60.00	-21.96	Peak	

Test Mode : TX Mode

Neutral

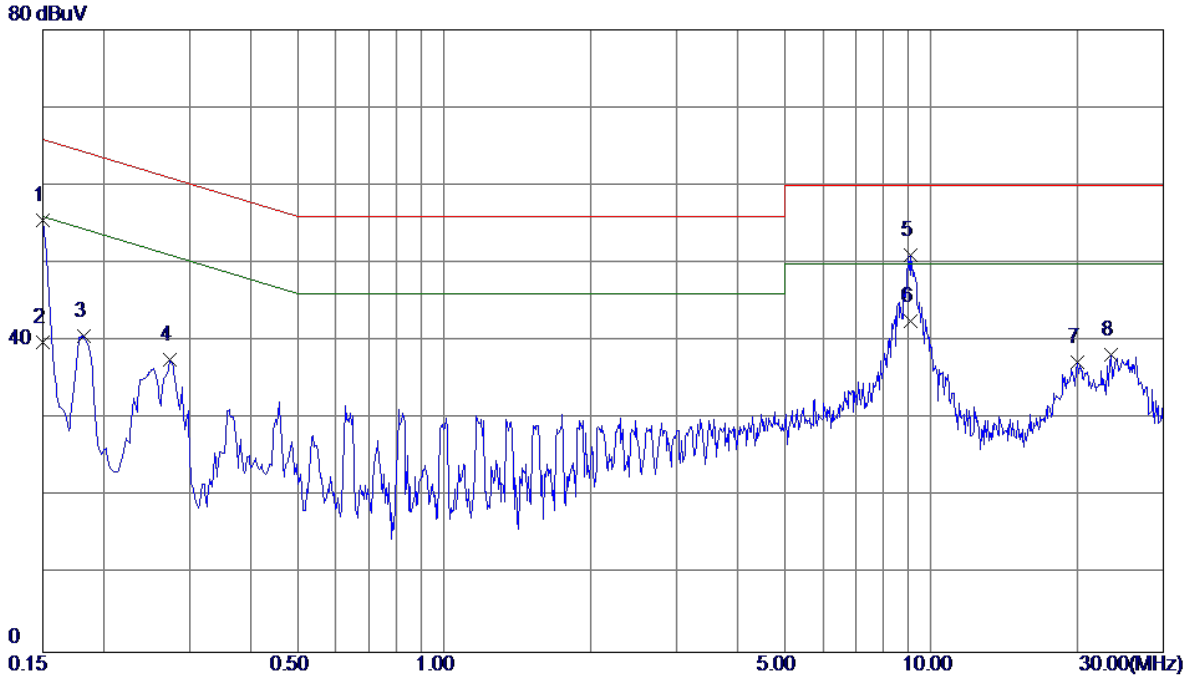

No.	Freq. MHz	Reading Level dBuV	Correct Factor dB	Measure ment dBuV	Limit dBuV	Margin dB	Detector	Comment
1	0.1500	45.95	9.57	55.52	66.00	-10.48	Peak	
2	0.1500	30.30	9.57	39.87	56.00	-16.13	AVG	
3	0.1819	31.07	9.51	40.58	64.40	-23.82	Peak	
4	0.2740	28.01	9.57	37.58	61.00	-23.42	Peak	
5	9.0700	40.55	10.47	51.02	60.00	-8.98	Peak	
6 *	9.0700	32.10	10.47	42.57	50.00	-7.43	AVG	
7	19.9780	26.45	10.90	37.35	60.00	-22.65	Peak	
8	23.3940	27.34	10.96	38.30	60.00	-21.70	Peak	

ATTACHMENT B - RADIATED EMISSION (9KHZ TO 30MHZ)

Test Mode: TX B MODE CHANNEL 01

Ant 0°

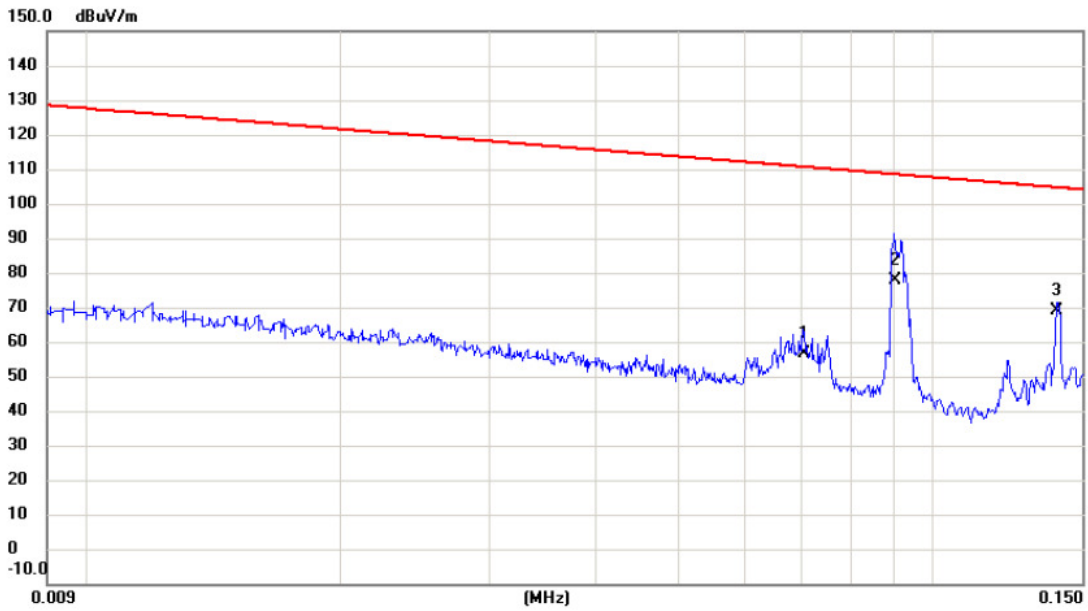

No.	Mk.	Freq. MHz	Reading Level dBuV	Correct Factor dB	Measure- ment dBuV/m	Limit dBuV/m	Margin dB	Detector	Comment
1		0.0704	37.16	19.59	56.75	110.65	-53.90	AVG	
2	*	0.0901	59.00	18.87	77.87	108.51	-30.64	AVG	
3		0.1402	50.50	18.68	69.18	104.67	-35.49	AVG	

Test Mode: TX B MODE CHANNEL 01

Ant 0°

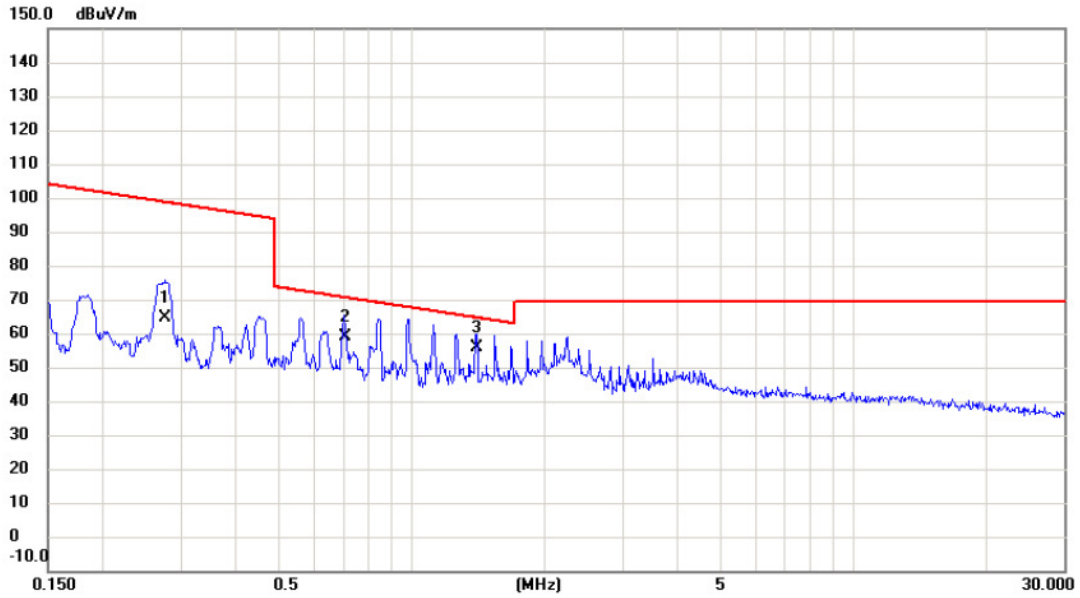

No.	Mk.	Freq. MHz	Reading Level dBuV	Correct Factor dB	Measure- ment dBuV/m	Limit dBuV/m	Margin dB	Detector	Comment
1		0.2760	46.10	18.62	64.72	98.79	-34.07	AVG	
2		0.7047	40.70	18.45	59.15	70.64	-11.49	QP	
3	*	1.4032	37.97	17.77	55.74	64.66	-8.92	QP	

Test Mode: TX B MODE CHANNEL 01

Ant 90°

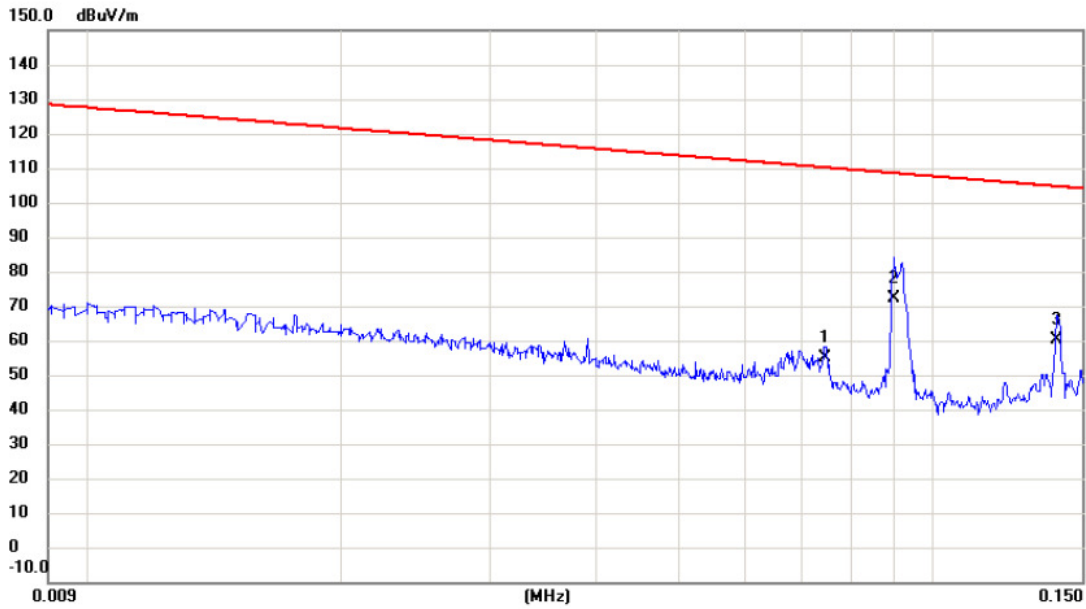

No.	Mk.	Freq. MHz	Reading Level dBuV	Correct Factor dB	Measure- ment dBuV/m	Limit dBuV/m	Margin dB	Detector	Comment
1		0.0744	35.56	19.54	55.10	110.17	-55.07	AVG	
2	*	0.0900	53.24	18.87	72.11	108.52	-36.41	AVG	
3		0.1402	41.72	18.68	60.40	104.67	-44.27	AVG	

Test Mode: TX B MODE CHANNEL 01

Ant 90°

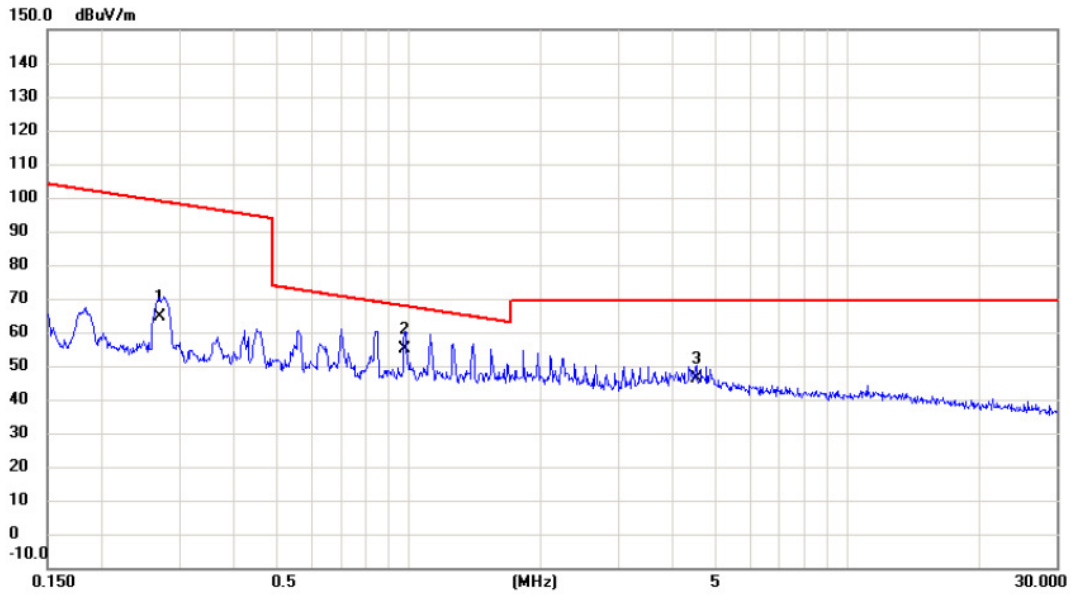

No.	Mk.	Freq. MHz	Reading Level dBuV	Correct Factor dB	Measure- ment dBuV/m	Limit dBuV/m	Margin dB	Detector	Comment
1		0.2701	45.83	18.63	64.46	98.97	-34.51	AVG	
2	*	0.9787	37.43	17.75	55.18	67.79	-12.61	QP	
3		4.5254	28.54	17.67	46.21	69.54	-23.33	QP	

ATTACHMENT C - RADIATED EMISSION (30MHZ TO 1000MHZ)

Test Mode: TX B MODE CHANNEL 01

Vertical

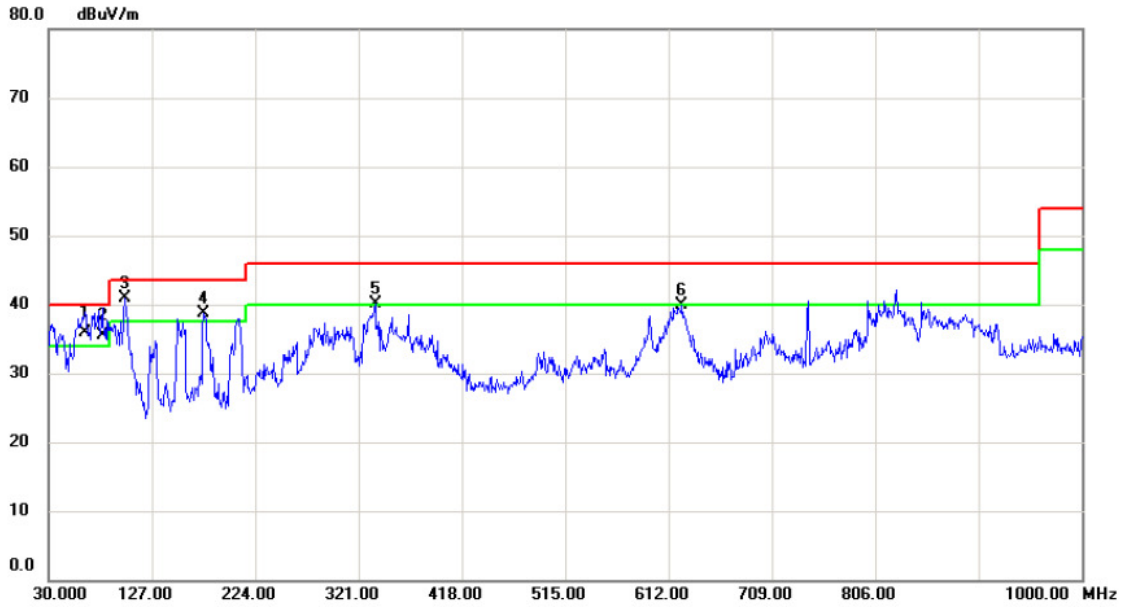

No.	Mk.	Freq. MHz	Reading Level dBuV	Correct Factor dB	Measure- ment dBuV/m	Limit dBuV/m	Margin dB	Detector	Comment
1	!	63.950	50.68	-14.87	35.81	40.00	-4.19	QP	
2	!	80.440	51.70	-16.16	35.54	40.00	-4.46	QP	
3	*	101.780	56.19	-15.32	40.87	43.50	-2.63	peak	
4	!	175.500	51.30	-12.57	38.73	43.50	-4.77	peak	
5	!	336.520	51.08	-10.93	40.15	46.00	-5.85	peak	
6		624.610	45.46	-5.65	39.81	46.00	-6.19	peak	

Test Mode: TX B MODE CHANNEL 01

Horizontal

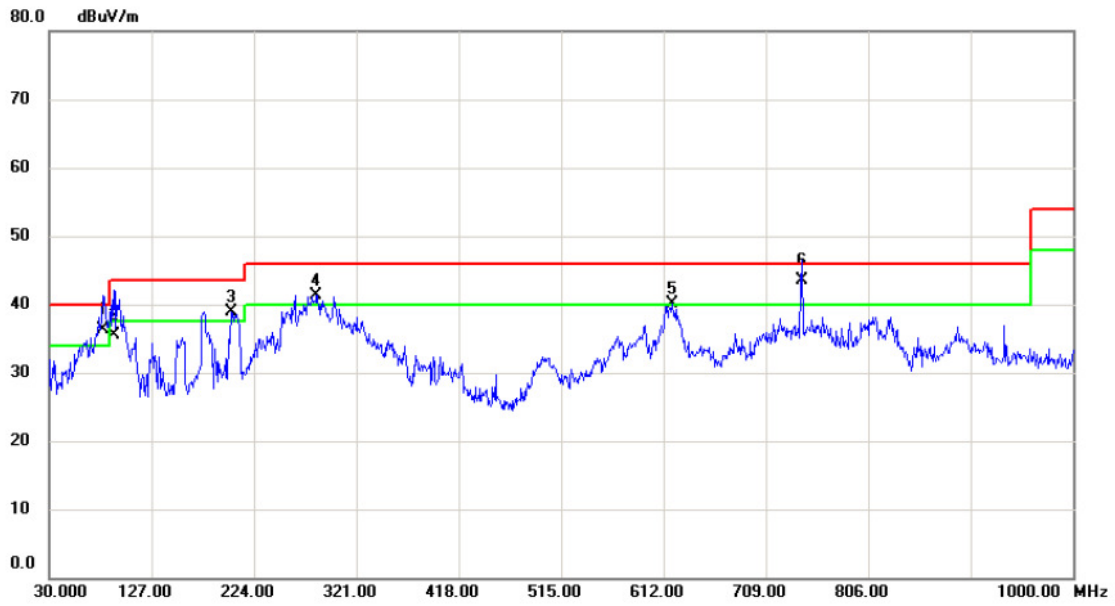

No.	Mk.	Freq. MHz	Reading Level dBuV	Correct Factor dB	Measure- ment dBuV/m	Limit dBuV/m	Margin dB	Detector	Comment
1	!	80.440	52.39	-16.16	36.23	40.00	-3.77	QP	
2		91.110	52.90	-17.42	35.48	43.50	-8.02	QP	
3	!	202.660	53.47	-14.48	38.99	43.50	-4.51	peak	
4	!	283.170	53.10	-11.78	41.32	46.00	-4.68	peak	
5	!	619.760	46.12	-5.92	40.20	46.00	-5.80	peak	
6	*	742.950	45.52	-1.99	43.53	46.00	-2.47	QP	

Test Mode: TX B MODE CHANNEL 06

Vertical

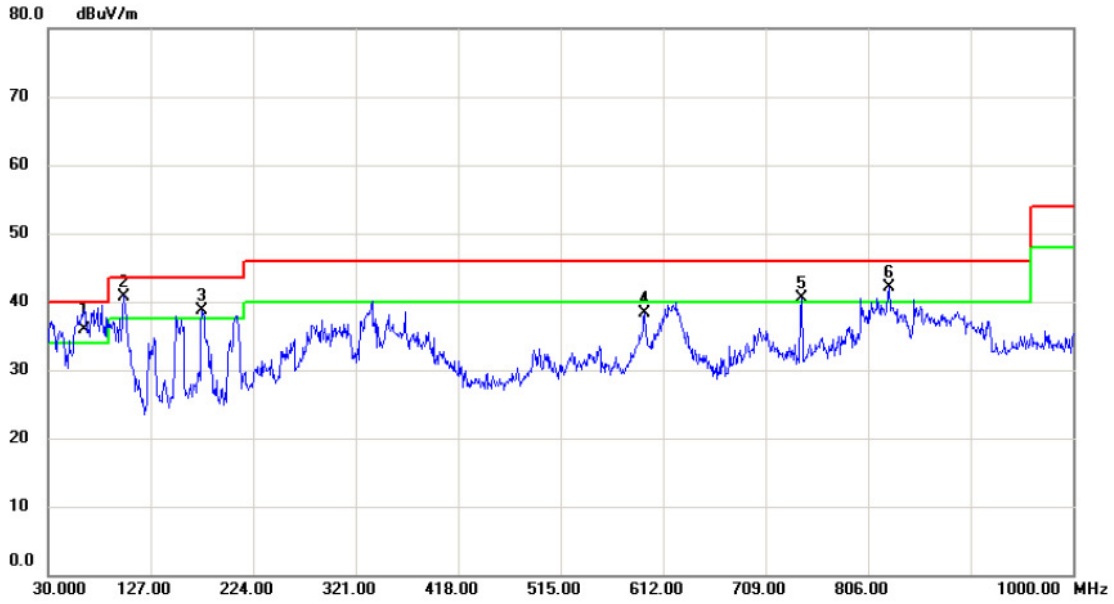

No.	Mk.	Freq. MHz	Reading Level dBuV	Correct Factor dB	Measure- ment dBuV/m	Limit dBuV/m	Margin dB	Detector	Comment
1	!	63.950	50.68	-14.87	35.81	40.00	-4.19	QP	
2	*	101.780	56.05	-15.32	40.73	43.50	-2.77	peak	
3	!	175.500	51.30	-12.57	38.73	43.50	-4.77	peak	
4		594.540	45.03	-6.79	38.24	46.00	-7.76	peak	
5	!	742.950	42.40	-1.99	40.41	46.00	-5.59	peak	
6	!	826.370	42.55	-0.54	42.01	46.00	-3.99	peak	

Test Mode: TX B MODE CHANNEL 06

Horizontal

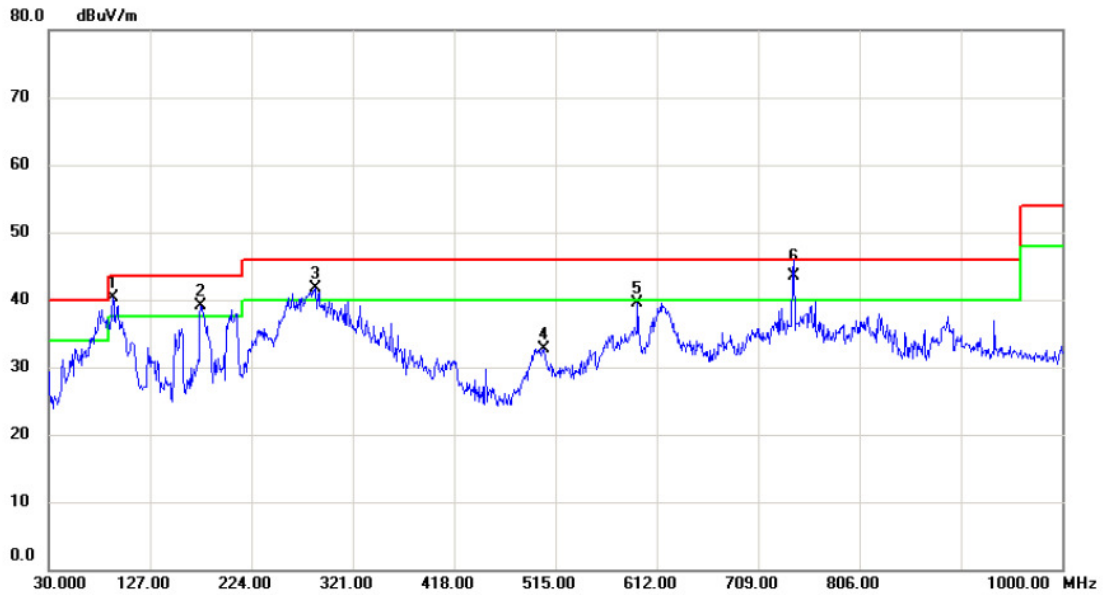

No.	Mk.	Freq. MHz	Reading Level dBuV	Correct Factor dB	Measure- ment dBuV/m	Limit dBuV/m	Margin dB	Detector	Comment
1	!	91.110	57.79	-17.42	40.37	43.50	-3.13	peak	
2	!	175.500	51.61	-12.57	39.04	43.50	-4.46	peak	
3	!	285.110	53.26	-11.63	41.63	46.00	-4.37	peak	
4		504.330	42.06	-9.28	32.78	46.00	-13.22	peak	
5		593.570	46.27	-6.74	39.53	46.00	-6.47	peak	
6	*	742.950	45.58	-1.99	43.59	46.00	-2.41	QP	

Test Mode: TX B MODE CHANNEL 11

Vertical

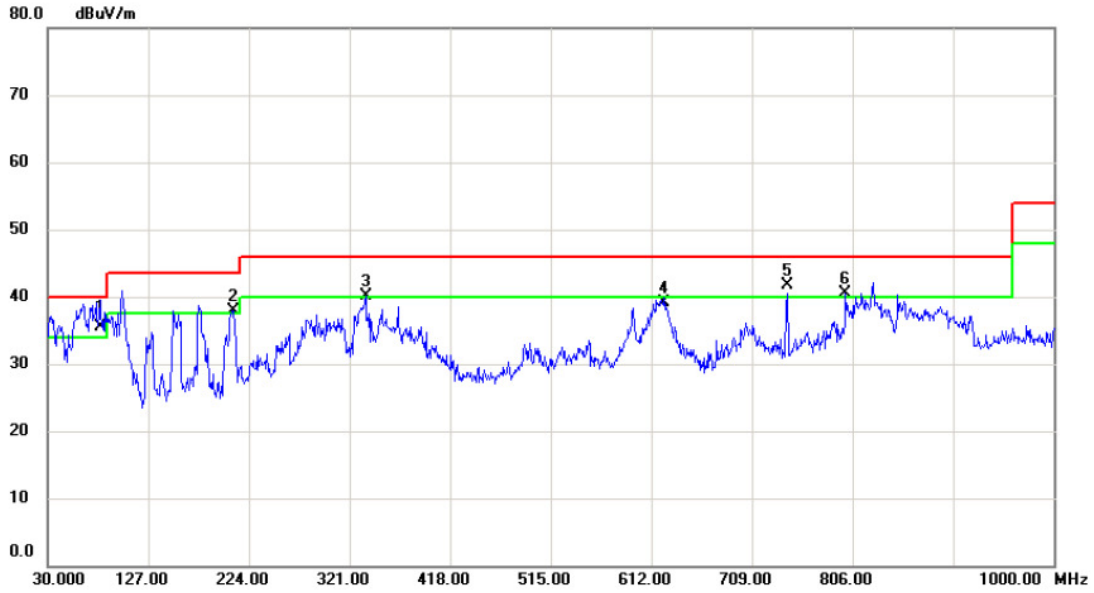

No. Mk.	Freq. MHz	Reading Level dBuV	Correct Factor dB	Measurement dBuV/m	Limit dBuV/m	Margin dB	Detector	Comment
1 !	80.440	51.60	-16.16	35.44	40.00	-4.56	QP	
2 !	208.480	52.52	-14.60	37.92	43.50	-5.58	peak	
3 !	336.520	51.08	-10.93	40.15	46.00	-5.85	peak	
4	624.243	44.85	-5.67	39.18	46.00	-6.82	peak	
5 *	742.950	43.70	-1.99	41.71	46.00	-4.29	peak	
6 !	799.210	40.31	0.23	40.54	46.00	-5.46	peak	

Test Mode: TX B MODE CHANNEL 11

Horizontal

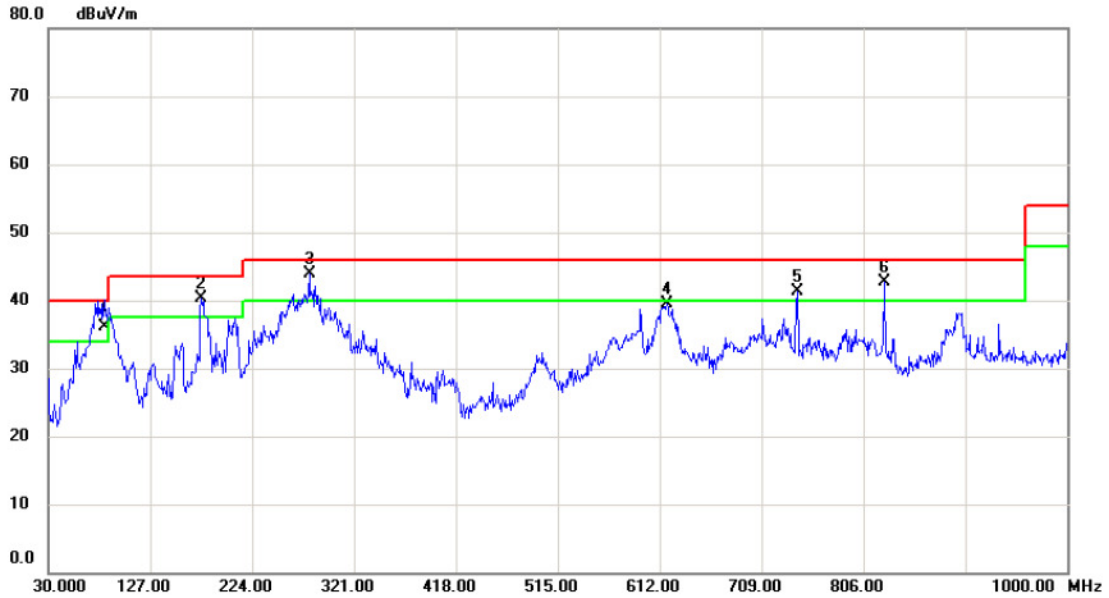

No.	Mk.	Freq. MHz	Reading Level dBuV	Correct Factor dB	Measure- ment dBuV/m	Limit dBuV/m	Margin dB	Detector	Comment
1	!	83.350	52.98	-16.96	36.02	40.00	-3.98	QP	
2	!	175.500	52.85	-12.57	40.28	43.50	-3.22	peak	
3	*	278.320	56.14	-12.27	43.87	46.00	-2.13	peak	
4		618.790	45.39	-5.98	39.41	46.00	-6.59	peak	
5	!	742.950	43.26	-1.99	41.27	46.00	-4.73	peak	
6	!	825.400	43.30	-0.51	42.79	46.00	-3.21	peak	

ATTACHMENT D - RADIATED EMISSION (ABOVE 1000MHZ)

Orthogonal Axis :	X
Test Mode :	TX B MODE 2412MHz

Vertical

115 dBuV/m

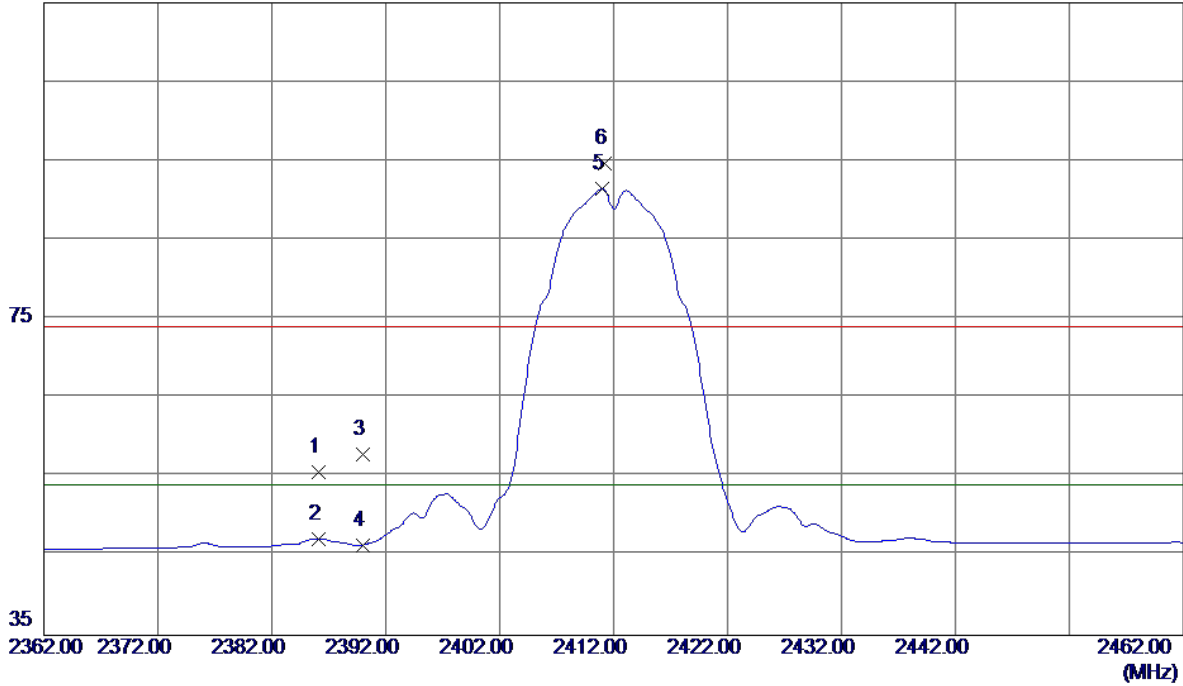

No.	Freq. MHz	Reading Level dBuV/m	Correct Factor dB	Measure ment dBuV/m	Limit dBuV/m	Margin dB	Detector	Comment
1	2386.1000	22.69	32.99	55.68	74.00	-18.32	Peak	
2	2386.1000	14.21	32.99	47.20	54.00	-6.80	AVG	
3	2390.0000	24.89	33.01	57.90	74.00	-16.10	Peak	
4	2390.0000	13.41	33.01	46.42	54.00	-7.58	AVG	
5 *	2411.0000	58.33	33.10	91.43	54.00	37.43	AVG	No Limit
6	2411.2000	61.57	33.10	94.67	74.00	20.67	Peak	No Limit

Orthogonal Axis :	X
Test Mode :	TX B MODE 2412MHz

Vertical



No.	Freq. MHz	Reading Level dBuV/m	Correct Factor dB	Measure ment dBuV/m	Limit dBuV/m	Margin dB	Detector	Comment
1	4823.1650	24.27	4.85	29.12	74.00	-44.88	Peak	
2 *	4825.9049	13.10	4.86	17.96	54.00	-36.04	AVG	

Orthogonal Axis :	X
Test Mode :	TX B MODE 2412MHz

Horizontal

115 dBuV/m

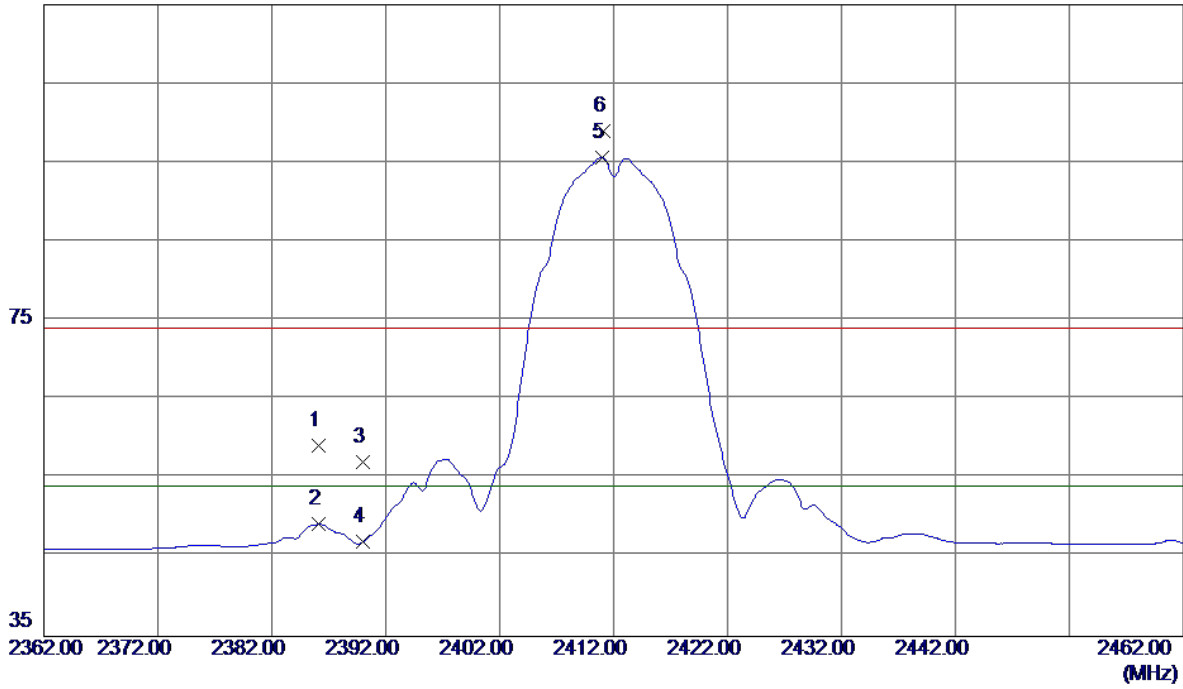

No.	Freq. MHz	Reading Level dBuV/m	Correct Factor dB	Measure ment dBuV/m	Limit dBuV/m	Margin dB	Detector	Comment
1	2386.1000	26.10	32.99	59.09	74.00	-14.91	Peak	
2	2386.1000	16.20	32.99	49.19	54.00	-4.81	AVG	
3	2390.0000	24.08	33.01	57.09	74.00	-16.91	Peak	
4	2390.0000	13.94	33.01	46.95	54.00	-7.05	AVG	
5 *	2411.0000	62.58	33.10	95.68	54.00	41.68	AVG	No Limit
6	2411.1000	65.84	33.10	98.94	74.00	24.94	Peak	No Limit

Orthogonal Axis :	X
Test Mode :	TX B MODE 2412MHz

Horizontal

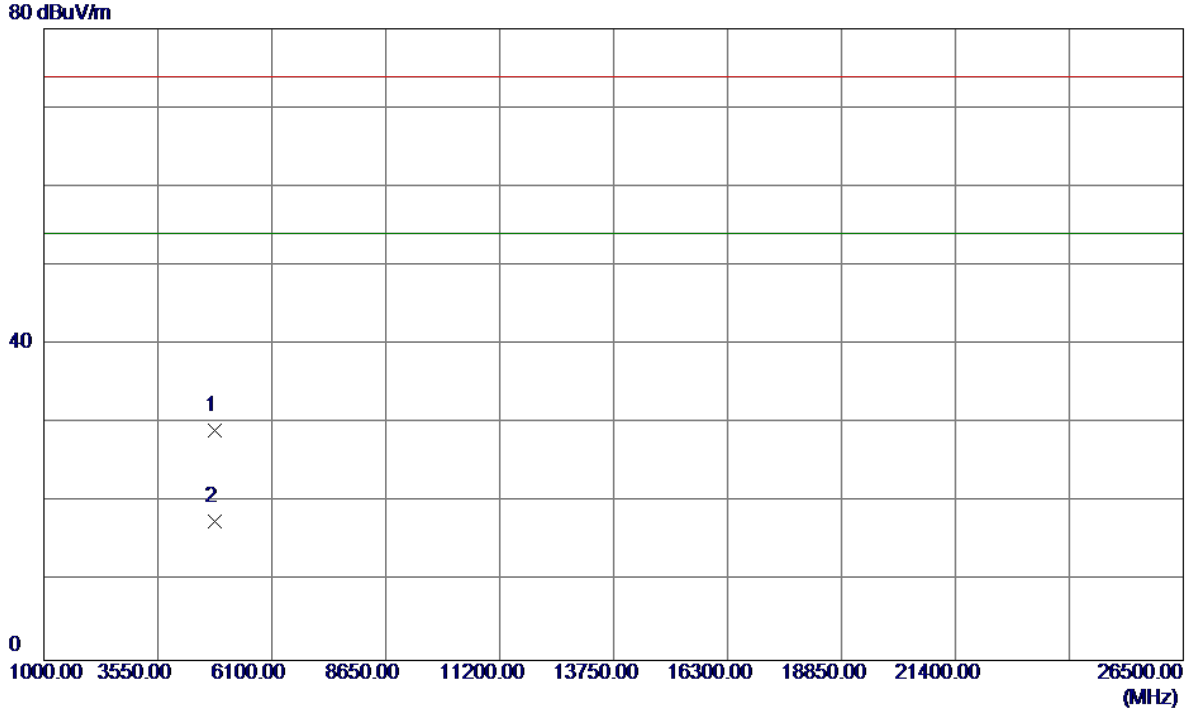

No.	Freq. MHz	Reading Level dBuV/m	Correct Factor dB	Measure ment dBuV/m	Limit dBuV/m	Margin dB	Detector	Comment
1	4824.5700	24.30	4.86	29.16	74.00	-44.84	Peak	
2 *	4824.9350	12.71	4.86	17.57	54.00	-36.43	AVG	

Orthogonal Axis :	X
Test Mode :	TX B MODE 2437MHz

Vertical

115 dBuV/m

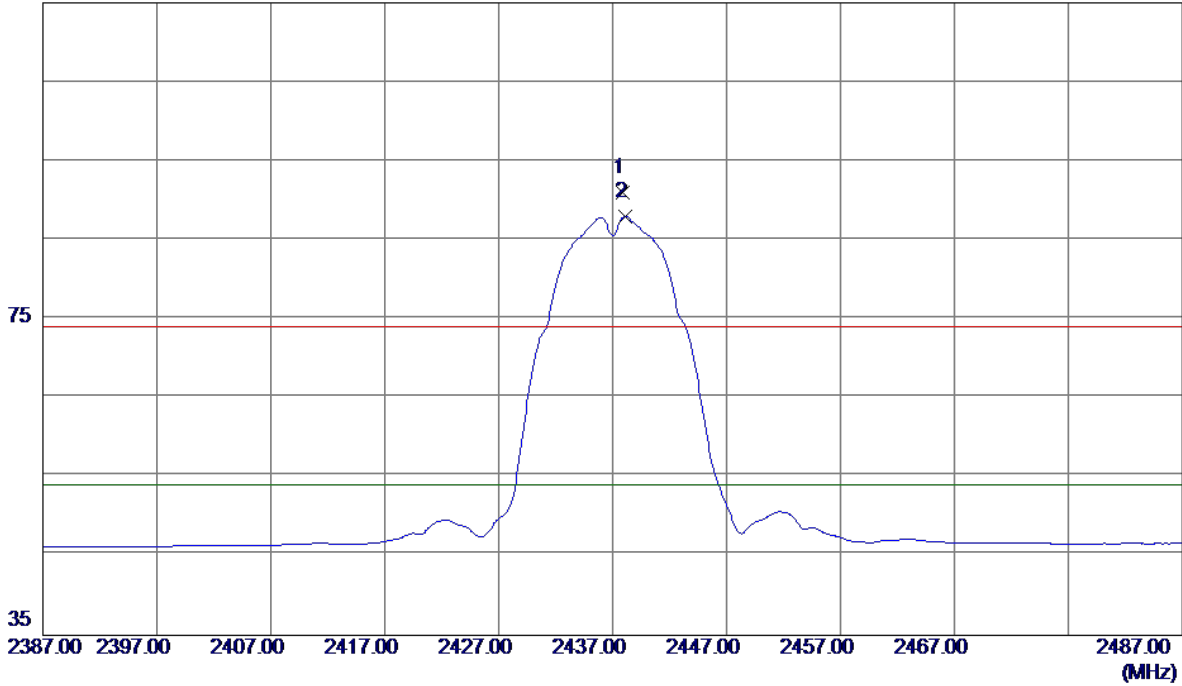

No.	Freq. MHz	Reading Level dBuV/m	Correct Factor dB	Measure ment dBuV/m	Limit dBuV/m	Margin dB	Detector	Comment
1	2437.9000	57.74	33.21	90.95	74.00	16.95	Peak	No Limit
2 *	2438.1000	54.74	33.21	87.95	54.00	33.95	AVG	No Limit

Orthogonal Axis :	X
Test Mode :	TX B MODE 2437MHz

Vertical

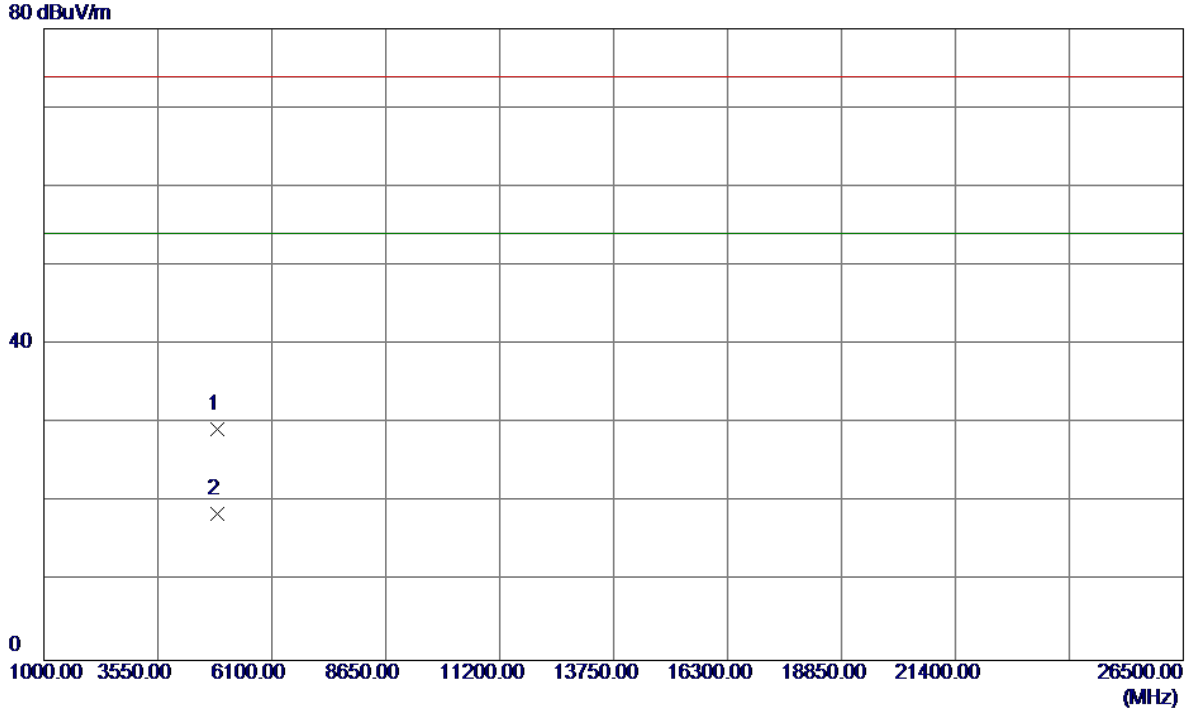

No.	Freq. MHz	Reading Level dBuV/m	Correct Factor dB	Measure ment dBuV/m	Limit dBuV/m	Margin dB	Detector	Comment
1	4875.0550	24.28	5.07	29.35	74.00	-44.65	Peak	
2 *	4875.1050	13.49	5.07	18.56	54.00	-35.44	AVG	

Orthogonal Axis :	X
Test Mode :	TX B MODE 2437MHz

Horizontal

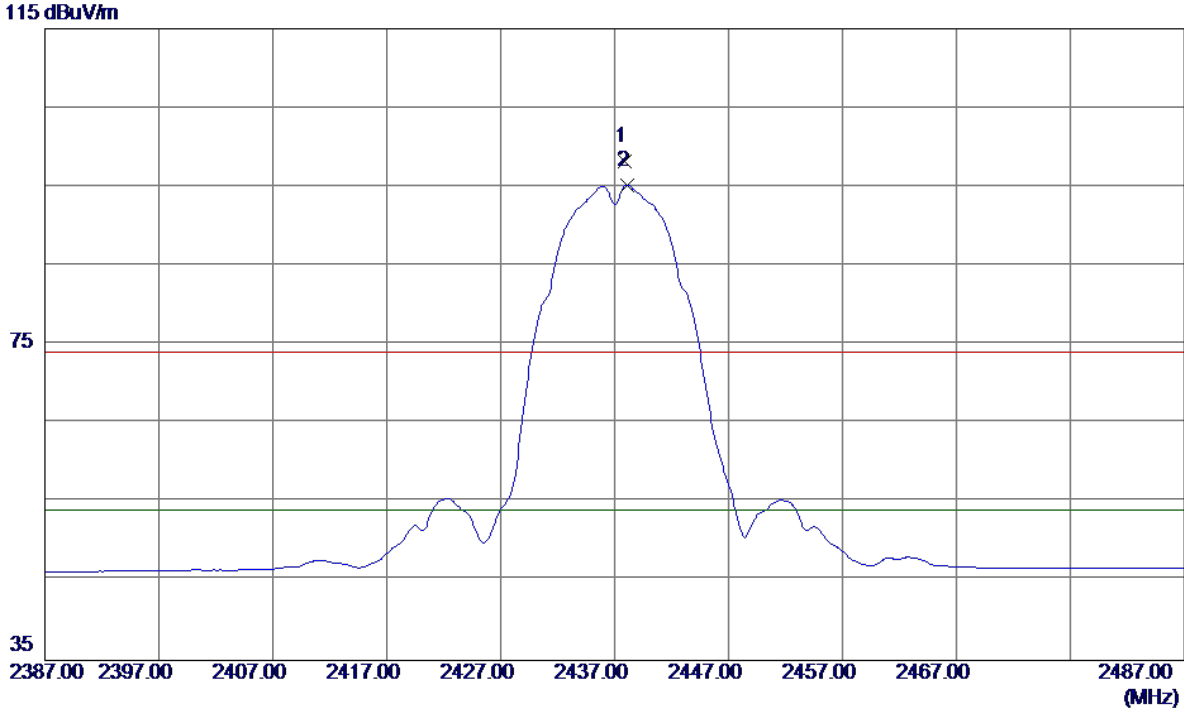

No.	Freq. MHz	Reading Level dBuV/m	Correct Factor dB	Measure ment dBuV/m	Limit dBuV/m	Margin dB	Detector	Comment
1	2437.9000	64.98	33.21	98.19	74.00	24.19	Peak	No Limit
2 *	2438.1000	62.00	33.21	95.21	54.00	41.21	AVG	No Limit

Orthogonal Axis :	X
Test Mode :	TX B MODE 2437MHz

Horizontal

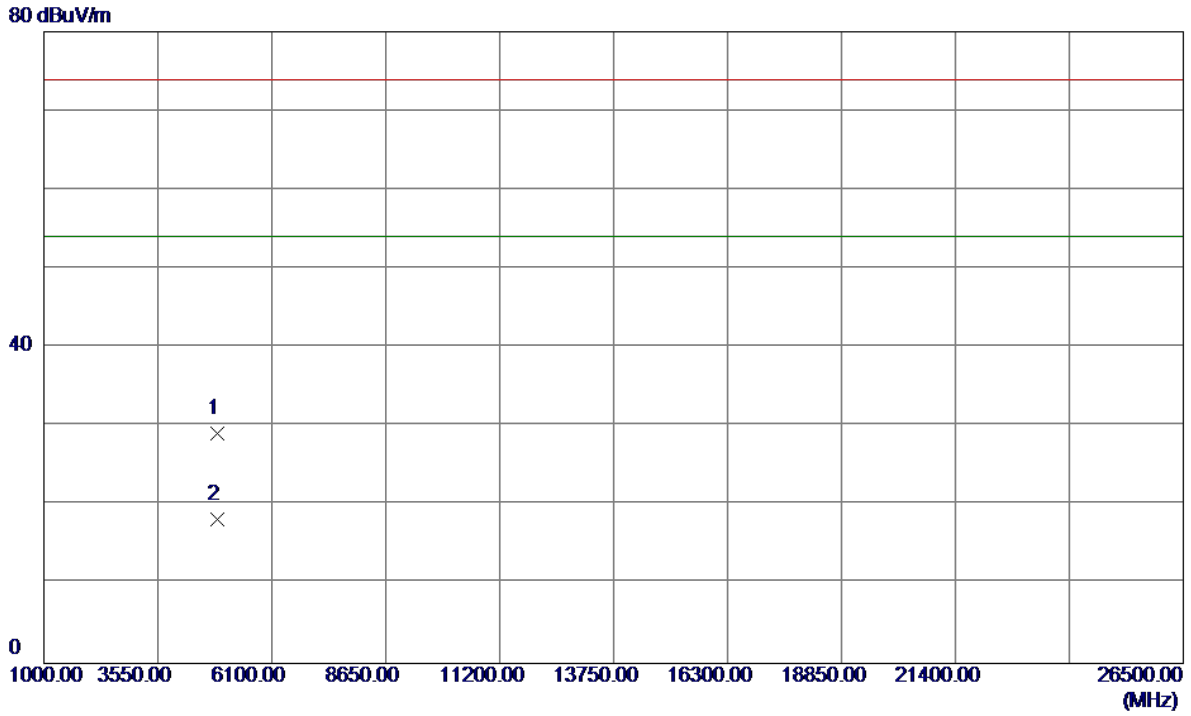

No.	Freq. MHz	Reading Level dBuV/m	Correct Factor dB	Measure ment dBuV/m	Limit dBuV/m	Margin dB	Detector	Comment
1	4875.0900	23.98	5.07	29.05	74.00	-44.95	Peak	
2 *	4875.8600	13.14	5.07	18.21	54.00	-35.79	AVG	

Orthogonal Axis :	X
Test Mode :	TX B MODE 2462MHz

Vertical

115 dBuV/m

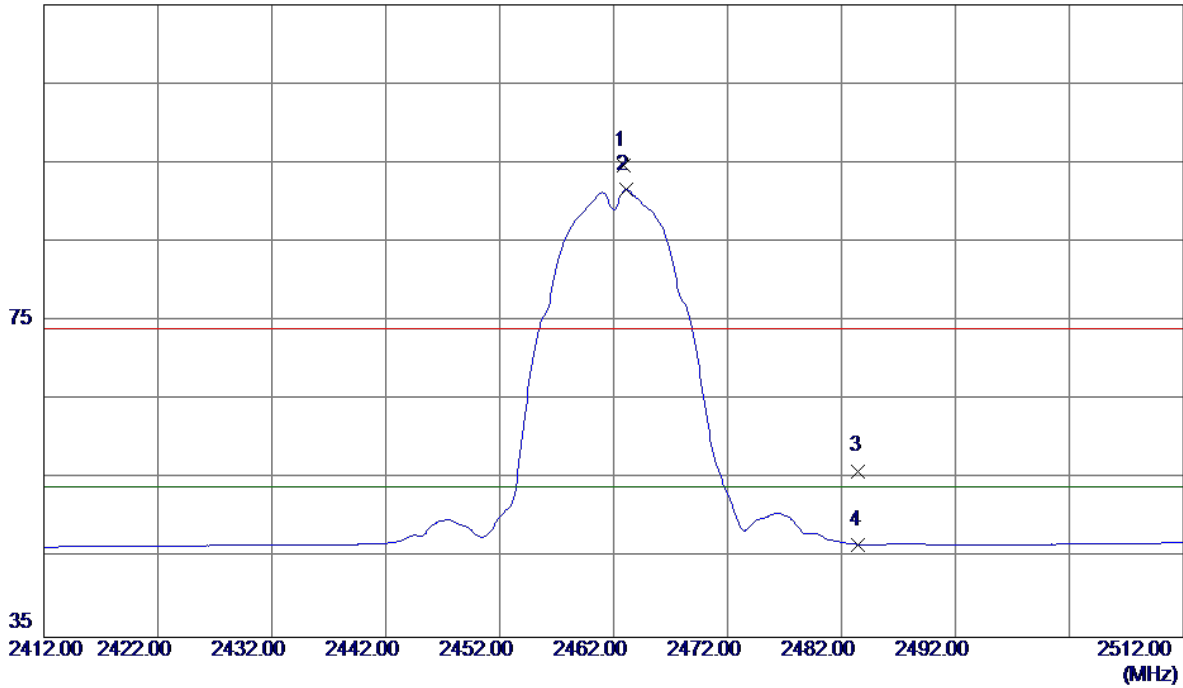

No.	Freq. MHz	Reading Level dBuV/m	Correct Factor dB	Measure ment dBuV/m	Limit dBuV/m	Margin dB	Detector	Comment
1	2462.9000	61.31	33.31	94.62	74.00	20.62	Peak	No Limit
2 *	2463.1000	58.27	33.32	91.59	54.00	37.59	AVG	No Limit
3	2483.5000	22.64	33.40	56.04	74.00	-17.96	Peak	
4	2483.5000	13.34	33.40	46.74	54.00	-7.26	AVG	

Orthogonal Axis :	X
Test Mode :	TX B MODE 2462MHz

Vertical

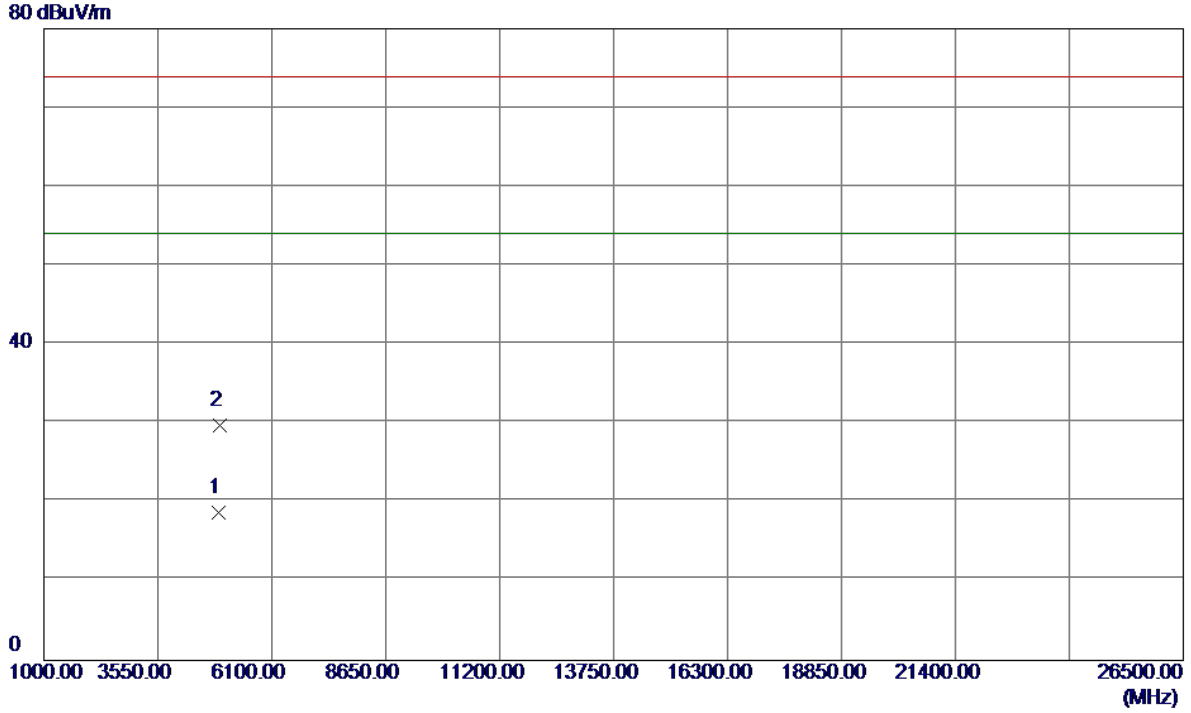

No.	Freq. MHz	Reading Level dBuV/m	Correct Factor dB	Measure ment dBuV/m	Limit dBuV/m	Margin dB	Detector	Comment
1 *	4922.6900	13.43	5.27	18.70	54.00	-35.30	AVG	
2	4926.1050	24.40	5.29	29.69	74.00	-44.31	Peak	

Orthogonal Axis :	X
Test Mode :	TX B MODE 2462MHz

Horizontal

115 dBuV/m

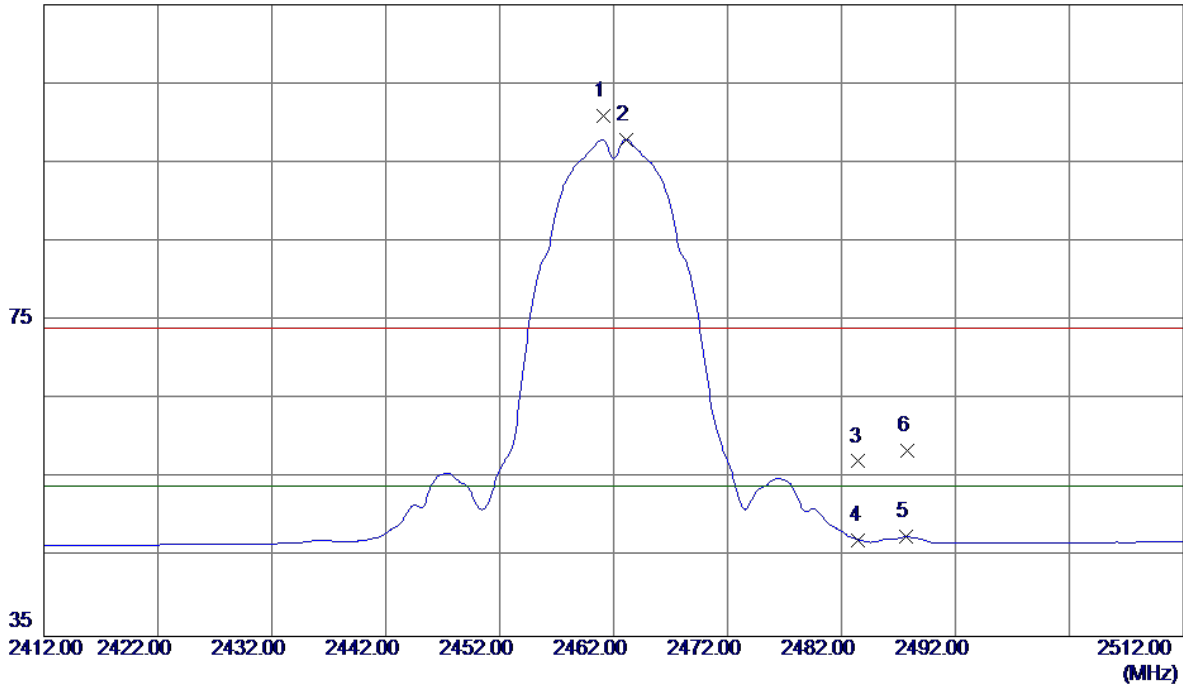

No.	Freq. MHz	Reading Level dBuV/m	Correct Factor dB	Measure ment dBuV/m	Limit dBuV/m	Margin dB	Detector	Comment
1	2461.1000	67.68	33.31	100.99	74.00	26.99	Peak	No Limit
2 *	2463.1000	64.58	33.32	97.90	54.00	43.90	AVG	No Limit
3	2483.5000	23.76	33.40	57.16	74.00	-16.84	Peak	
4	2483.5000	13.83	33.40	47.23	54.00	-6.77	AVG	
5	2487.7000	14.18	33.42	47.60	54.00	-6.40	AVG	
6	2487.8000	25.15	33.42	58.57	74.00	-15.43	Peak	

Orthogonal Axis :	X
Test Mode :	TX B MODE 2462MHz

Horizontal

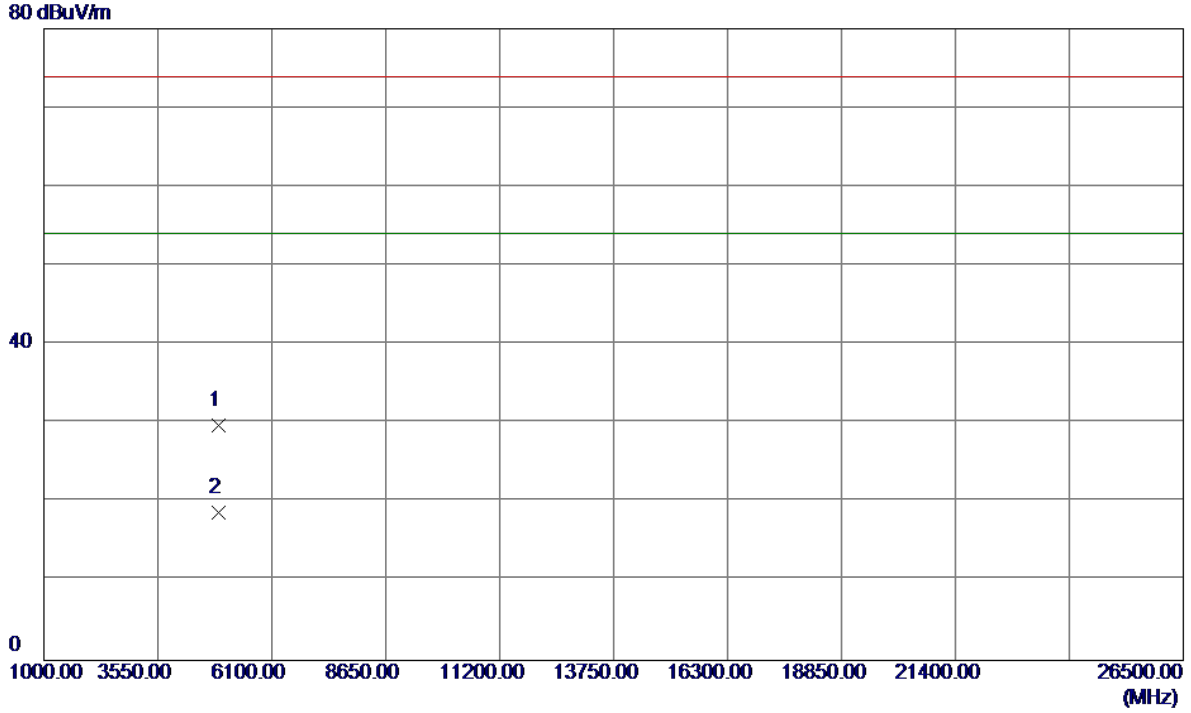

No.	Freq. MHz	Reading Level dBuV/m	Correct Factor dB	Measure ment dBuV/m	Limit dBuV/m	Margin dB	Detector	Comment
1	4921.8550	24.54	5.27	29.81	74.00	-44.19	Peak	
2 *	4922.2700	13.48	5.27	18.75	54.00	-35.25	AVG	

Orthogonal Axis :	X
Test Mode :	TX G MODE 2412MHz

Vertical

115 dBuV/m

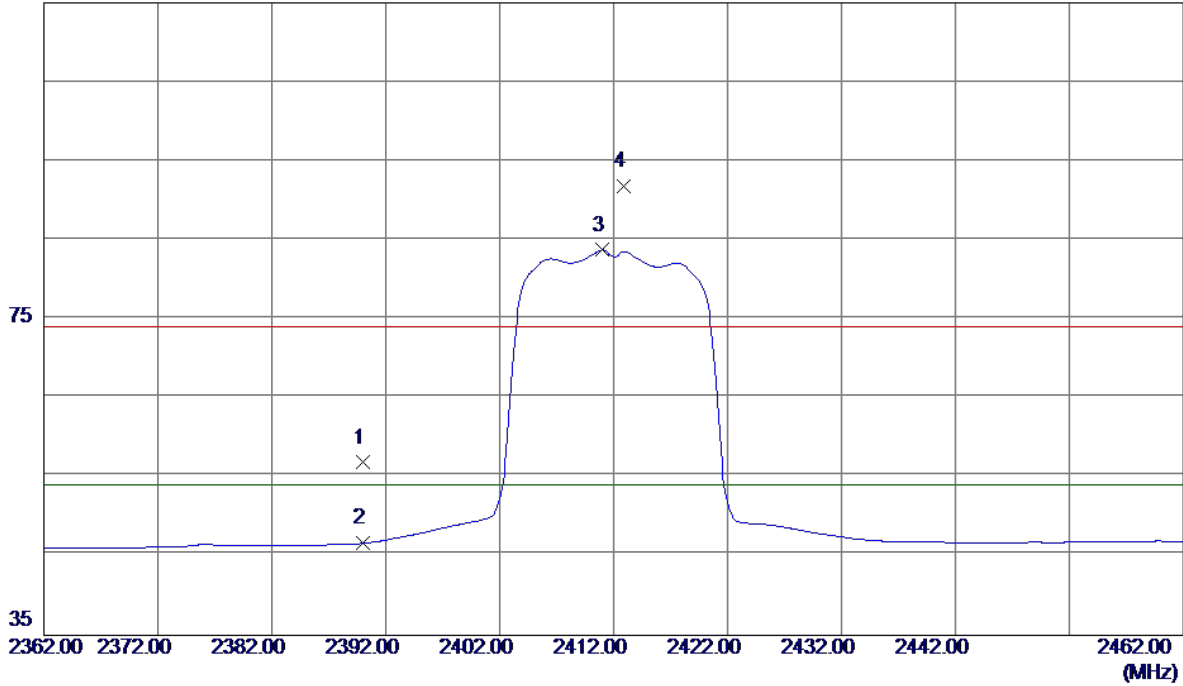

No.	Freq. MHz	Reading Level dBuV/m	Correct Factor dB	Measure ment dBuV/m	Limit dBuV/m	Margin dB	Detector	Comment
1	2390.0000	23.83	33.01	56.84	74.00	-17.16	Peak	
2	2390.0000	13.63	33.01	46.64	54.00	-7.36	AVG	
3 *	2411.0000	50.62	33.10	83.72	54.00	29.72	AVG	No Limit
4	2412.9000	58.68	33.11	91.79	74.00	17.79	Peak	No Limit

Orthogonal Axis :	X
Test Mode :	TX G MODE 2412MHz

Vertical



No.	Freq. MHz	Reading Level dBuV/m	Correct Factor dB	Measure ment dBuV/m	Limit dBuV/m	Margin dB	Detector	Comment
1	4821.9800	24.18	4.85	29.03	74.00	-44.97	Peak	
2 *	4824.7400	13.14	4.86	18.00	54.00	-36.00	AVG	

Orthogonal Axis :	X
Test Mode :	TX G MODE 2412MHz

Horizontal

115 dBuV/m

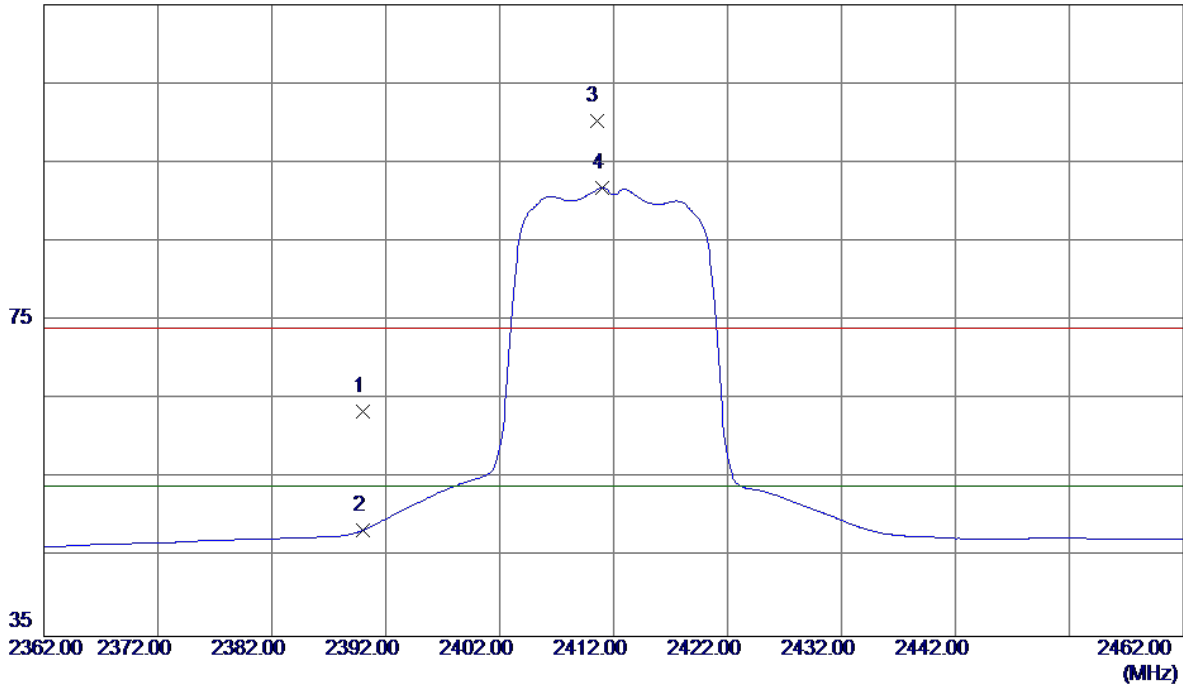

No.	Freq. MHz	Reading Level dBuV/m	Correct Factor dB	Measure ment dBuV/m	Limit dBuV/m	Margin dB	Detector	Comment
1	2390.0000	30.51	33.01	63.52	74.00	-10.48	Peak	
2	2390.0000	15.43	33.01	48.44	54.00	-5.56	AVG	
3	2410.5000	67.16	33.10	100.26	74.00	26.26	Peak	No Limit
4 *	2411.0000	58.67	33.10	91.77	54.00	37.77	AVG	No Limit

Orthogonal Axis :	X
Test Mode :	TX G MODE 2412MHz

Horizontal

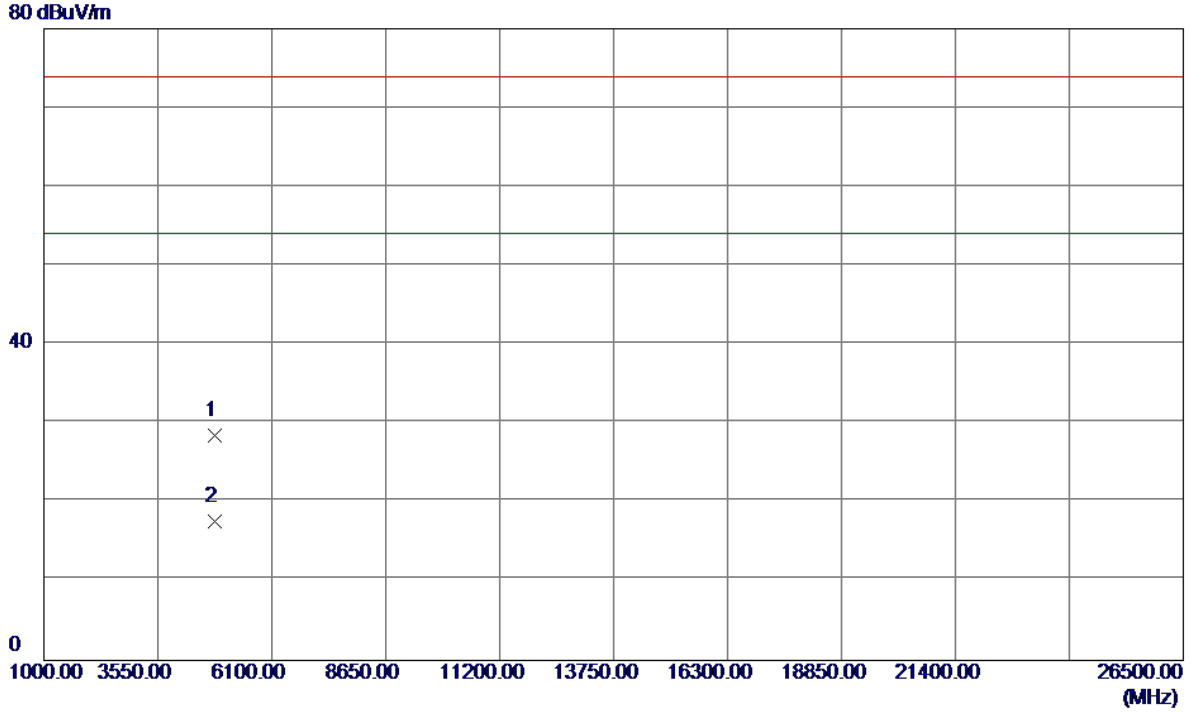

No.	Freq. MHz	Reading Level dBuV/m	Correct Factor dB	Measure ment dBuV/m	Limit dBuV/m	Margin dB	Detector	Comment
1	4823.4300	23.64	4.85	28.49	74.00	-45.51	Peak	
2 *	4824.5550	12.70	4.86	17.56	54.00	-36.44	AVG	

Orthogonal Axis :	X
Test Mode :	TX G MODE 2437MHz

Vertical

115 dBuV/m

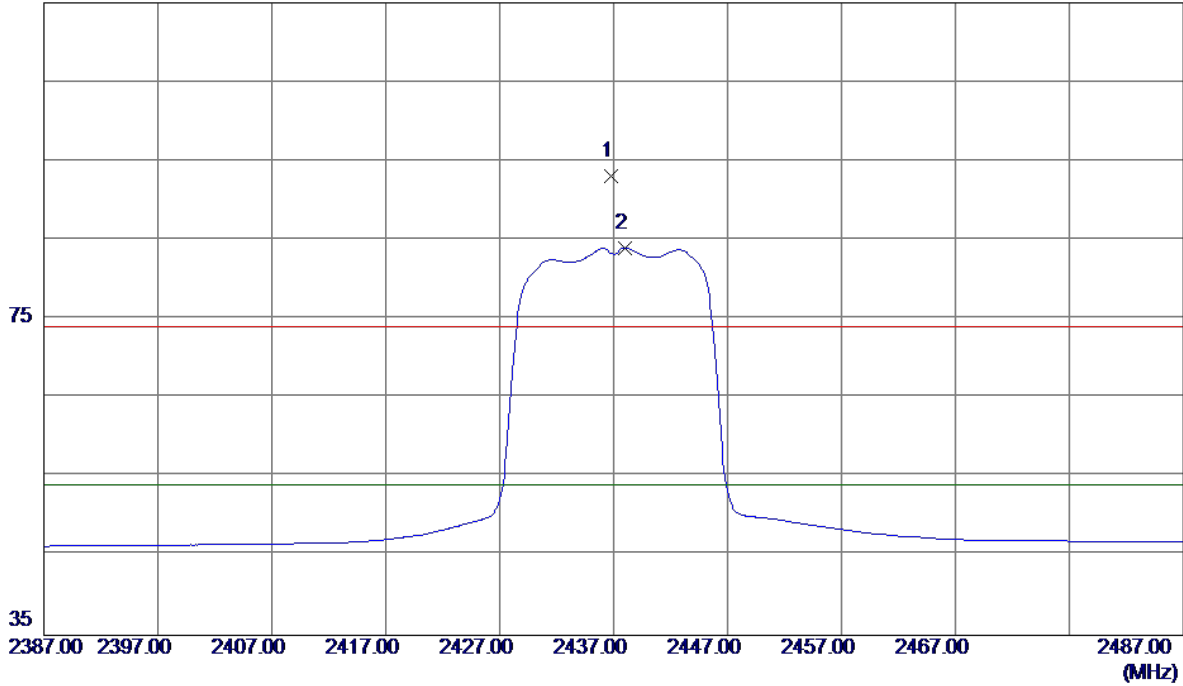

No.	Freq. MHz	Reading Level dBuV/m	Correct Factor dB	Measure ment dBuV/m	Limit dBuV/m	Margin dB	Detector	Comment
1	2436.8000	59.85	33.21	93.06	74.00	19.06	Peak	No Limit
2 *	2438.0000	50.81	33.21	84.02	54.00	30.02	AVG	No Limit

Orthogonal Axis :	X
Test Mode :	TX G MODE 2437MHz

Vertical

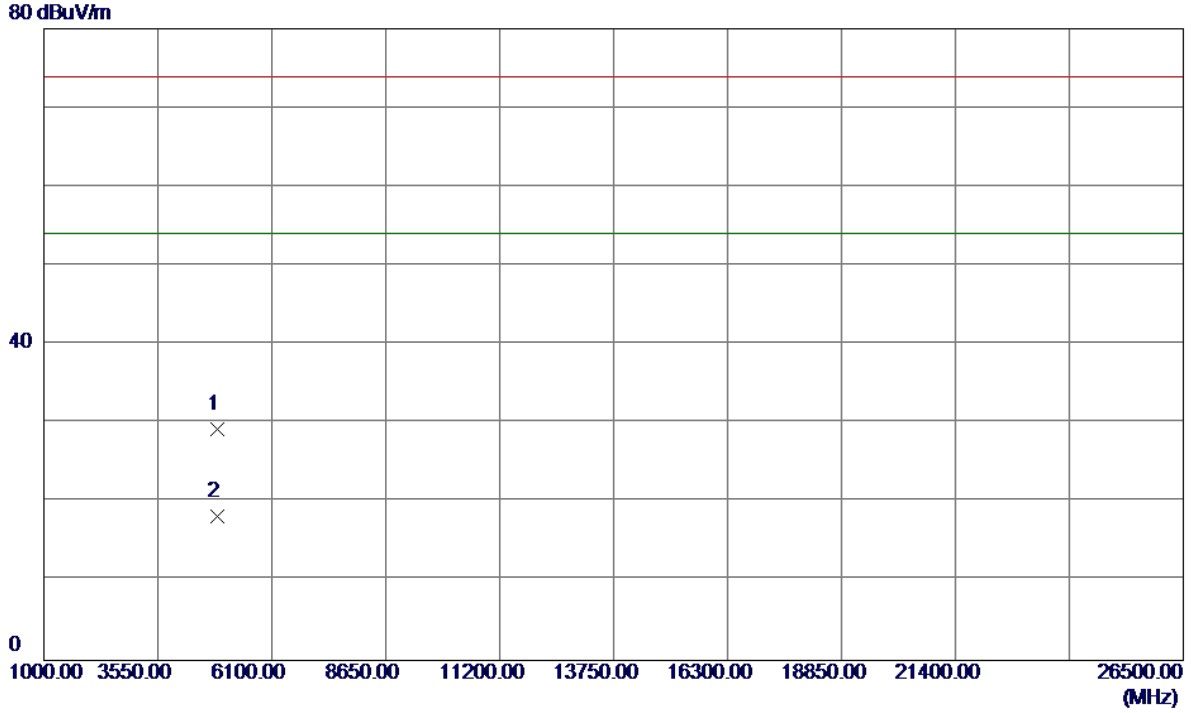

No.	Freq. MHz	Reading Level dBuV/m	Correct Factor dB	Measure ment dBuV/m	Limit dBuV/m	Margin dB	Detector	Comment
1	4874.8150	24.25	5.07	29.32	74.00	-44.68	Peak	
2 *	4875.5900	13.10	5.07	18.17	54.00	-35.83	AVG	

Orthogonal Axis :	X
Test Mode :	TX G MODE 2437MHz

Horizontal

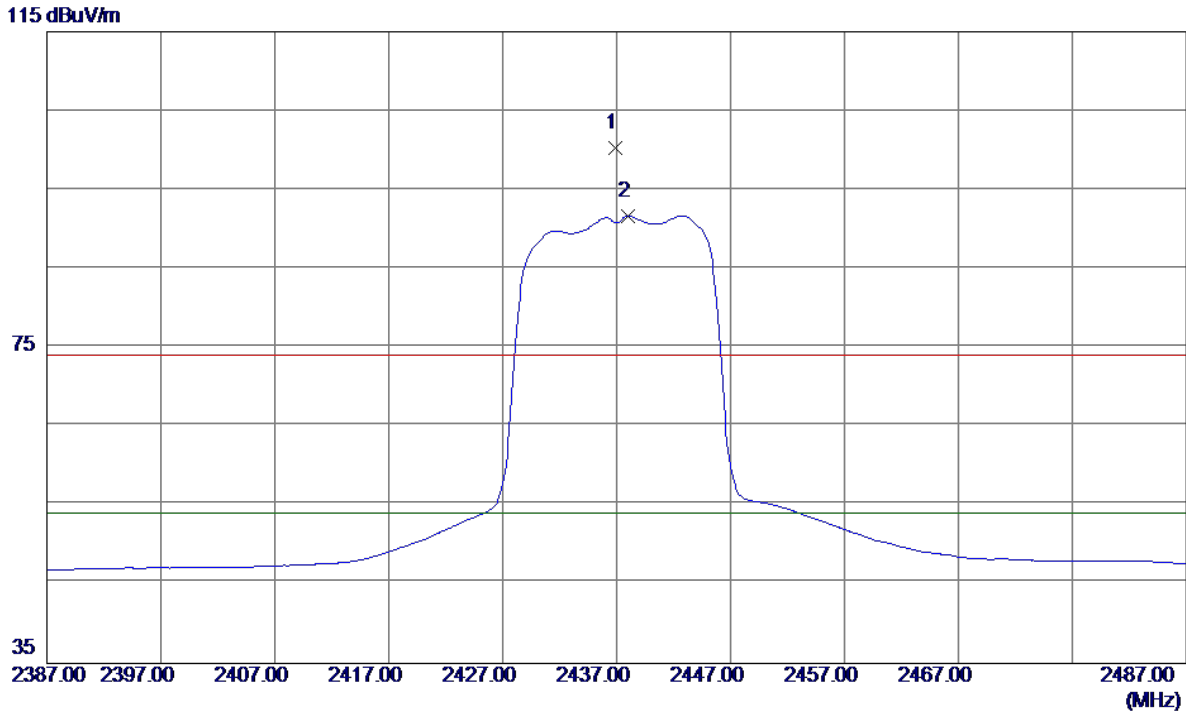

No.	Freq. MHz	Reading Level dBuV/m	Correct Factor dB	Measure ment dBuV/m	Limit dBuV/m	Margin dB	Detector	Comment
1	2436.9000	67.10	33.21	100.31	74.00	26.31	Peak	No Limit
2 *	2438.0000	58.47	33.21	91.68	54.00	37.68	AVG	No Limit

Orthogonal Axis :	X
Test Mode :	TX G MODE 2437MHz

Horizontal

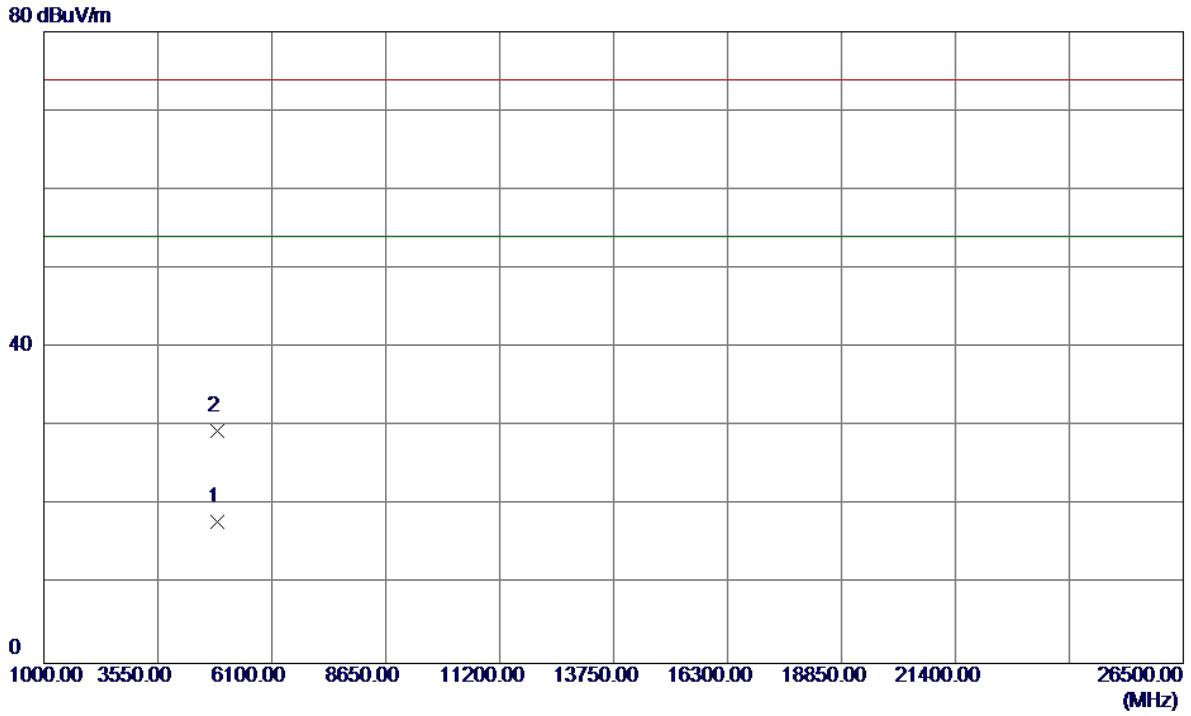

No.	Freq. MHz	Reading Level dBuV/m	Correct Factor dB	Measure ment dBuV/m	Limit dBuV/m	Margin dB	Detector	Comment
1 *	4873.5450	12.93	5.06	17.99	54.00	-36.01	AVG	
2	4873.7550	24.35	5.06	29.41	74.00	-44.59	Peak	

Orthogonal Axis :	X
Test Mode :	TX G MODE 2462MHz

Vertical

115 dBuV/m

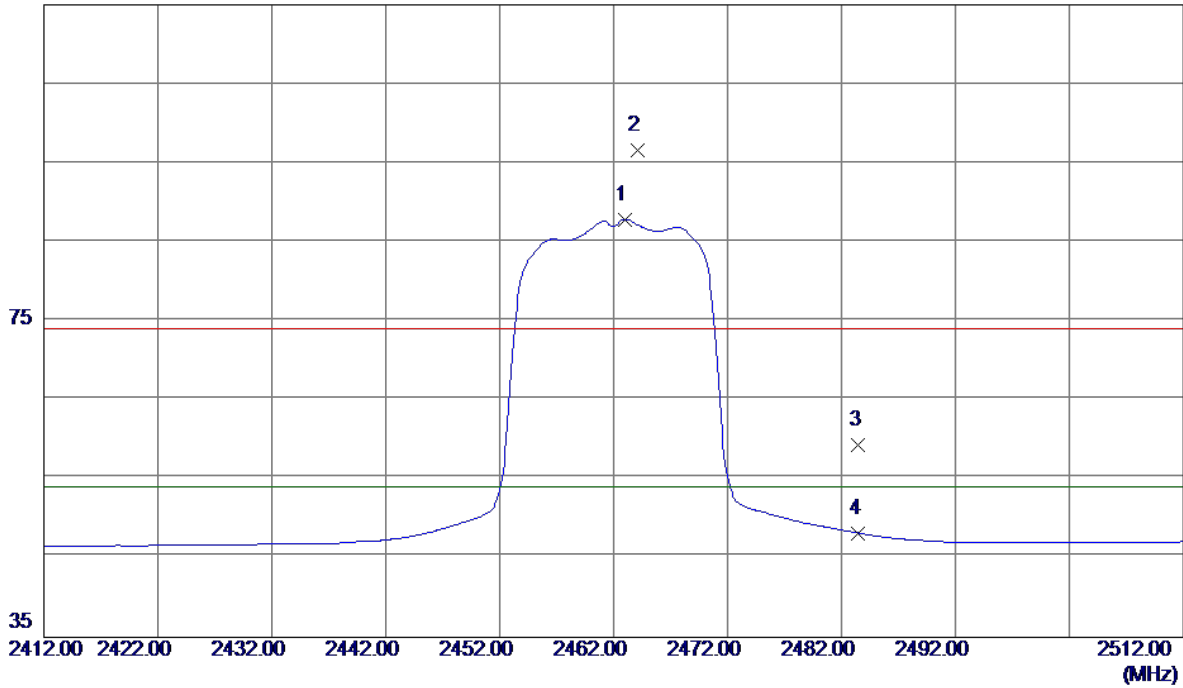

No.	Freq. MHz	Reading Level dBuV/m	Correct Factor dB	Measure ment dBuV/m	Limit dBuV/m	Margin dB	Detector	Comment
1 *	2463.0000	54.56	33.32	87.88	54.00	33.88	AVG	No Limit
2	2464.1000	63.32	33.32	96.64	74.00	22.64	Peak	No Limit
3	2483.5000	25.91	33.40	59.31	74.00	-14.69	Peak	
4	2483.5000	14.79	33.40	48.19	54.00	-5.81	AVG	

Orthogonal Axis :	X
Test Mode :	TX G MODE 2462MHz

Vertical

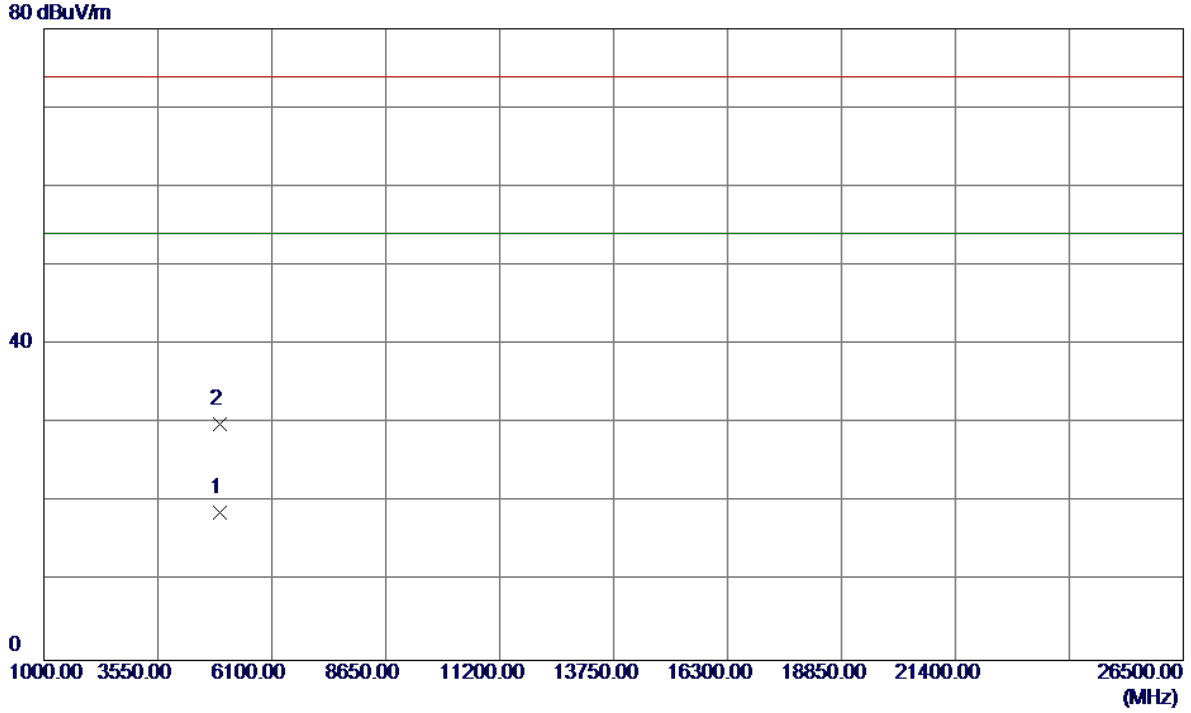

No.	Freq. MHz	Reading Level dBuV/m	Correct Factor dB	Measure ment dBuV/m	Limit dBuV/m	Margin dB	Detector	Comment
1 *	4924.8250	13.48	5.28	18.76	54.00	-35.24	AVG	
2	4925.6500	24.70	5.28	29.98	74.00	-44.02	Peak	

Orthogonal Axis :	X
Test Mode :	TX G MODE 2462MHz

Horizontal

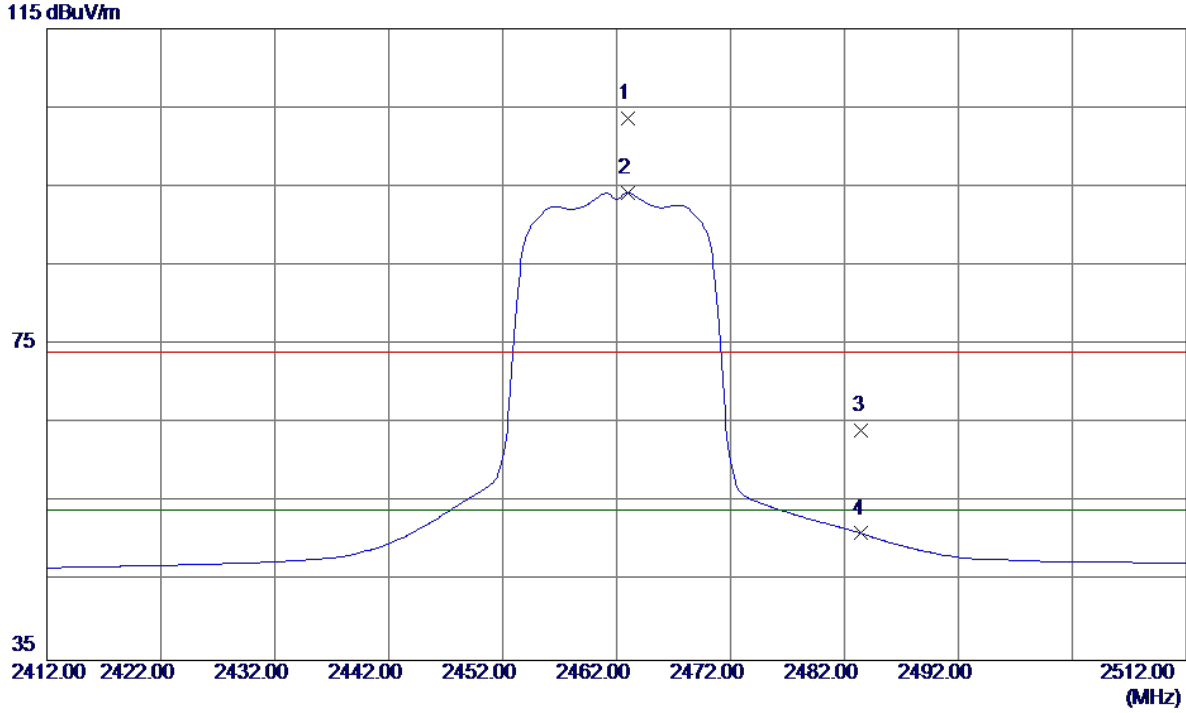

No.	Freq. MHz	Reading Level dBuV/m	Correct Factor dB	Measure ment dBuV/m	Limit dBuV/m	Margin dB	Detector	Comment
1	2463.0000	70.37	33.32	103.69	74.00	29.69	Peak	No Limit
2 *	2463.0000	60.88	33.32	94.20	54.00	40.20	AVG	No Limit
3	2483.5000	30.68	33.40	64.08	74.00	-9.92	Peak	
4	2483.5000	17.68	33.40	51.08	54.00	-2.92	AVG	

Orthogonal Axis :	X
Test Mode :	TX G MODE 2462MHz

Horizontal

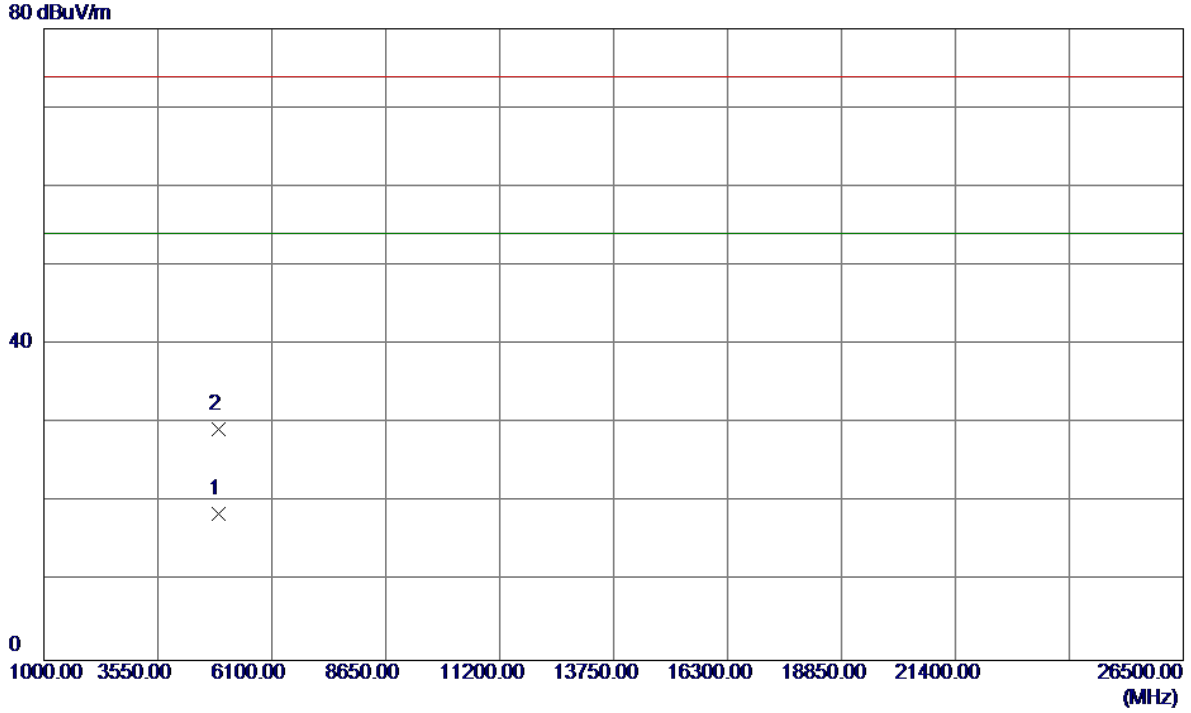

No.	Freq. MHz	Reading Level dBuV/m	Correct Factor dB	Measure ment dBuV/m	Limit dBuV/m	Margin dB	Detector	Comment
1 *	4923.1900	13.33	5.27	18.60	54.00	-35.40	AVG	
2	4923.6100	23.96	5.28	29.24	74.00	-44.76	Peak	

Orthogonal Axis :	X
Test Mode :	TX N-20M MODE 2412MHz

Vertical

115 dBuV/m

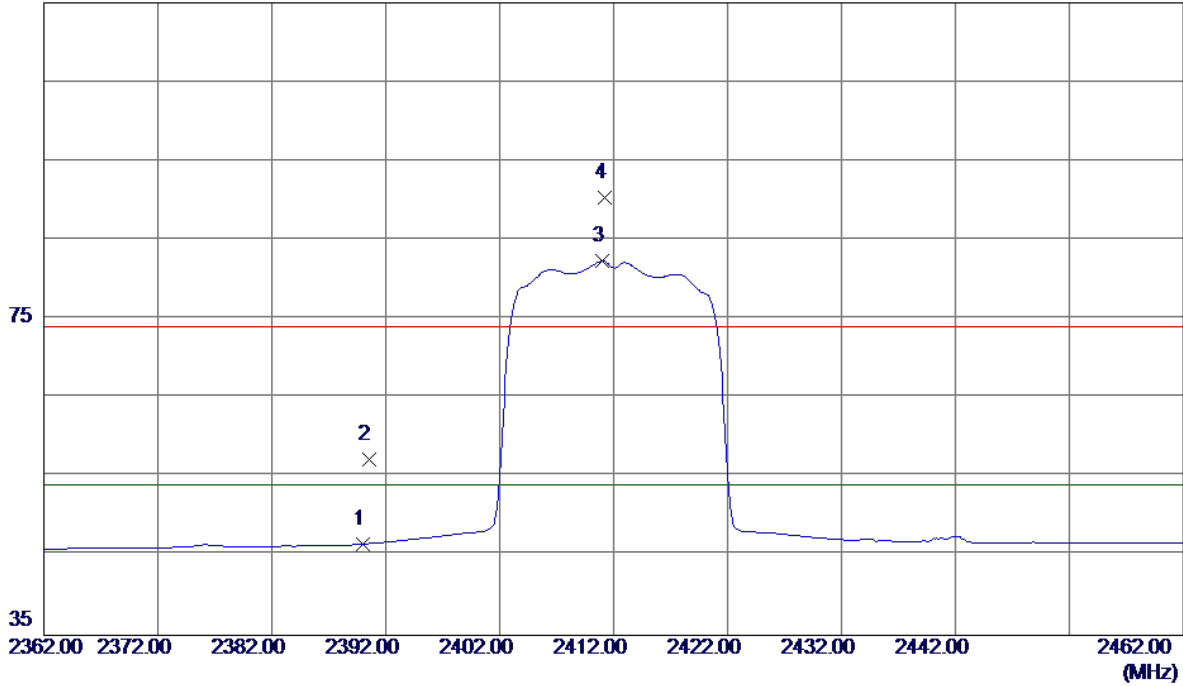

No.	Freq. MHz	Reading Level dBuV/m	Correct Factor dB	Measure ment dBuV/m	Limit dBuV/m	Margin dB	Detector	Comment
1	2390.0000	13.53	33.01	46.54	54.00	-7.46	AVG	
2	2390.5000	24.16	33.01	57.17	74.00	-16.83	Peak	
3 *	2411.0000	49.23	33.10	82.33	54.00	28.33	AVG	No Limit
4	2411.2000	57.29	33.10	90.39	74.00	16.39	Peak	No Limit

Orthogonal Axis :	X
Test Mode :	TX N-20M MODE 2412MHz

Vertical

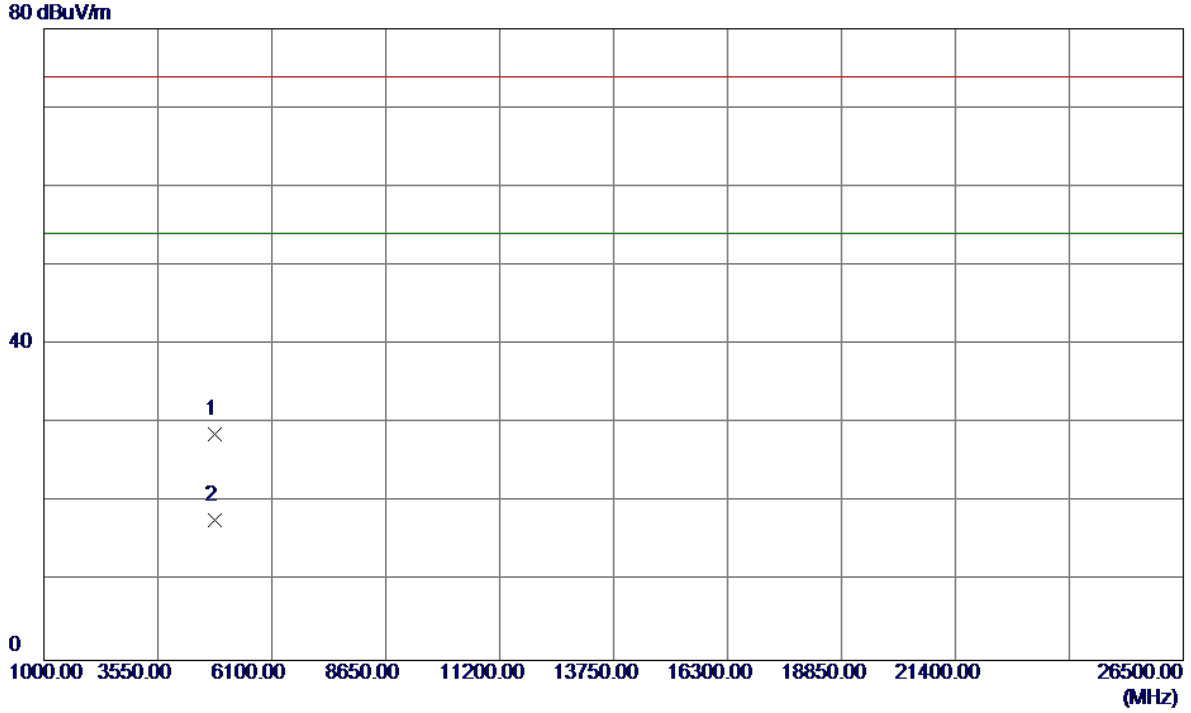

No.	Freq. MHz	Reading Level dBuV/m	Correct Factor dB	Measure ment dBuV/m	Limit dBuV/m	Margin dB	Detector	Comment
1	4825.5200	23.81	4.86	28.67	74.00	-45.33	Peak	
2 *	4825.7250	12.87	4.86	17.73	54.00	-36.27	AVG	

Orthogonal Axis :	X
Test Mode :	TX N-20M MODE 2412MHz

Horizontal

115 dBuV/m

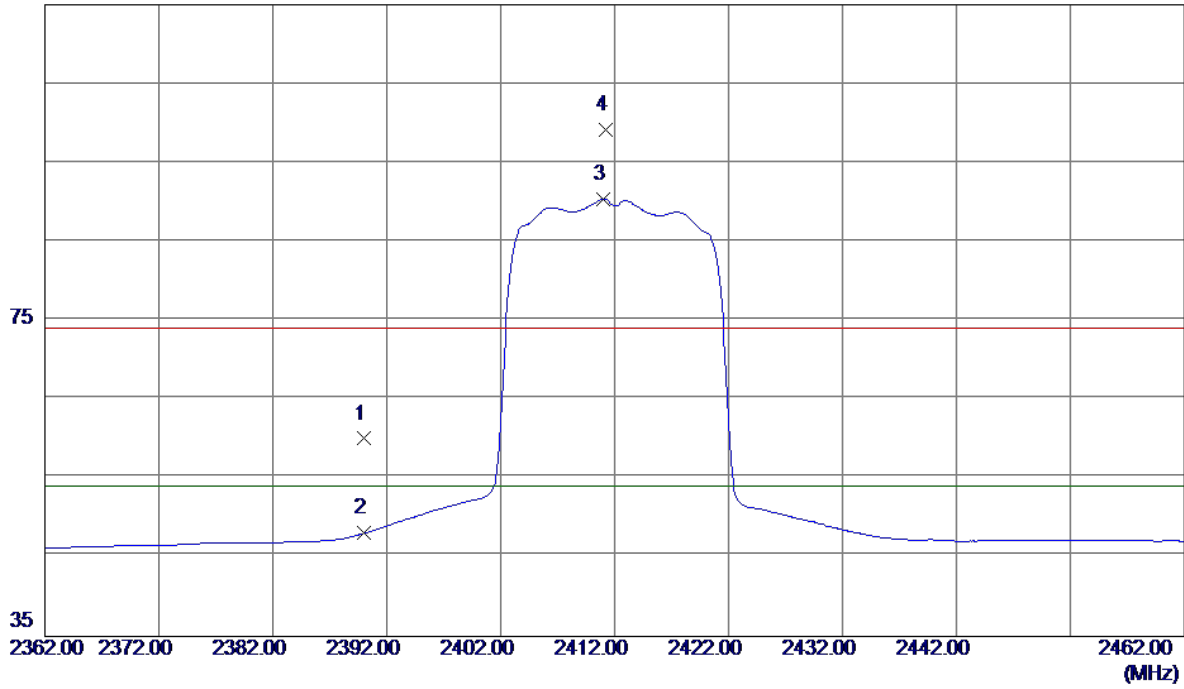

No.	Freq. MHz	Reading Level dBuV/m	Correct Factor dB	Measure ment dBuV/m	Limit dBuV/m	Margin dB	Detector	Comment
1	2390.0000	27.03	33.01	60.04	74.00	-13.96	Peak	
2	2390.0000	15.04	33.01	48.05	54.00	-5.95	AVG	
3 *	2411.0000	57.29	33.10	90.39	54.00	36.39	AVG	No Limit
4	2411.2000	66.08	33.10	99.18	74.00	25.18	Peak	No Limit

Orthogonal Axis :	X
Test Mode :	TX N-20M MODE 2412MHz

Horizontal

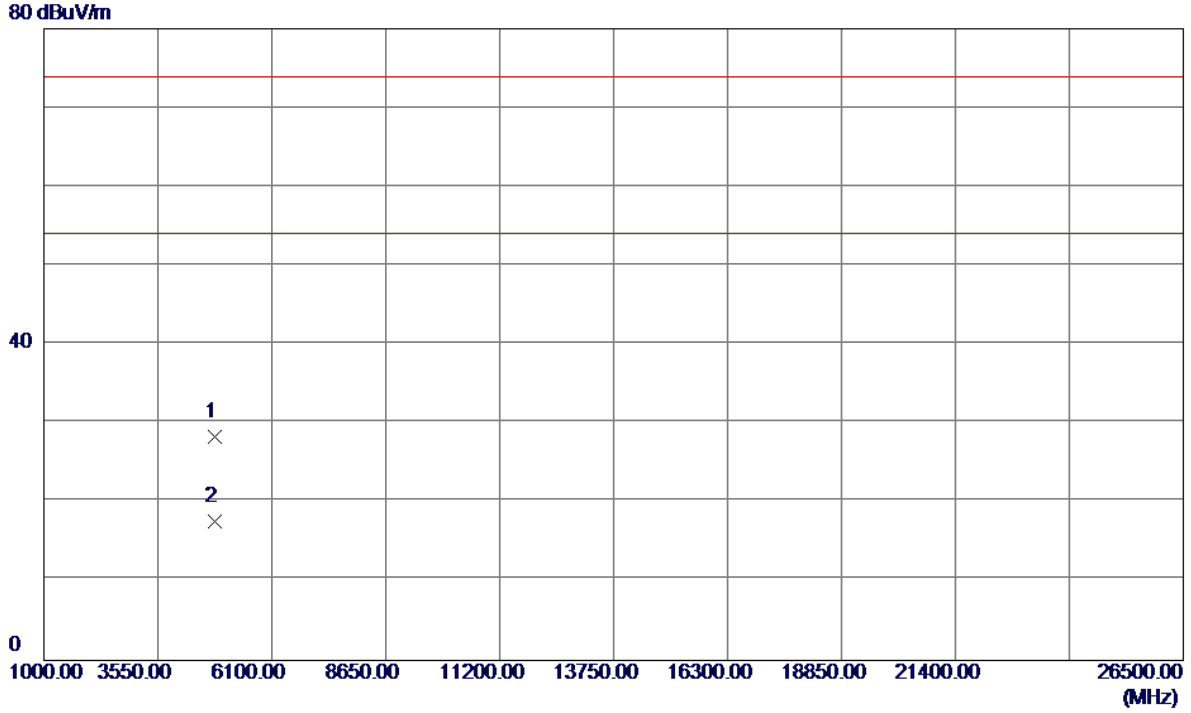

No.	Freq. MHz	Reading Level dBuV/m	Correct Factor dB	Measure ment dBuV/m	Limit dBuV/m	Margin dB	Detector	Comment
1	4823.2799	23.48	4.85	28.33	74.00	-45.67	Peak	
2 *	4826.3350	12.70	4.86	17.56	54.00	-36.44	AVG	

Orthogonal Axis :	X
Test Mode :	TX N-20M MODE 2437MHz

Vertical

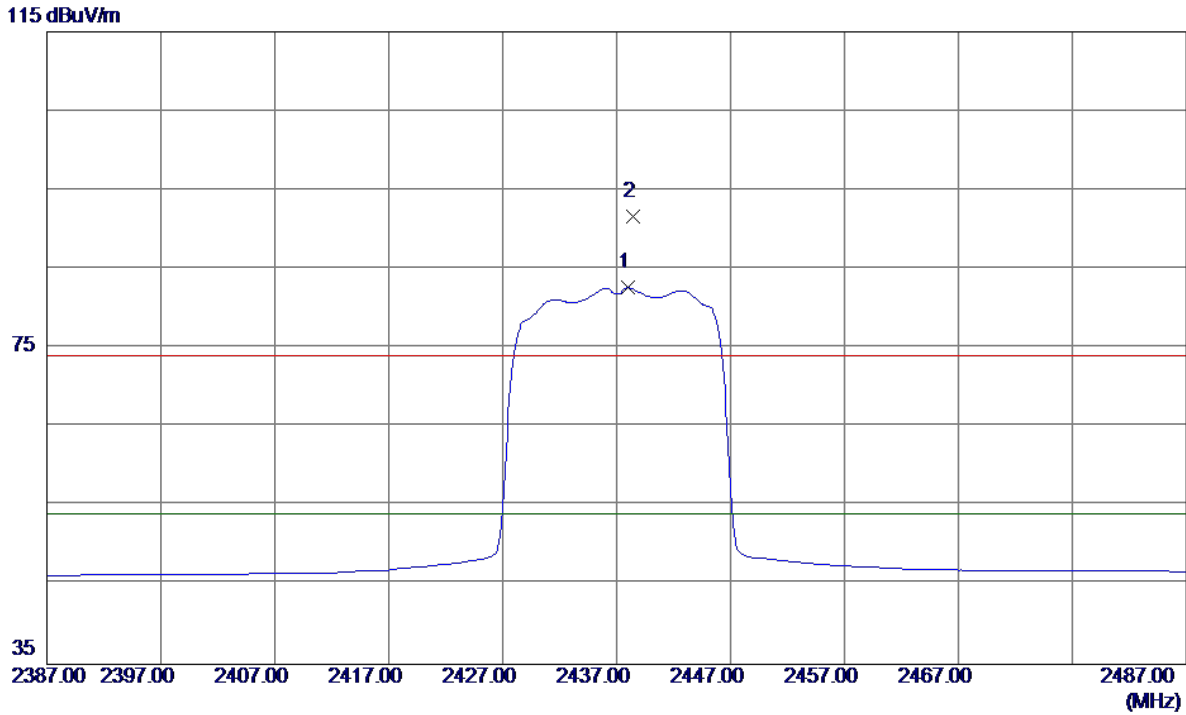

No.	Freq. MHz	Reading Level dBuV/m	Correct Factor dB	Measure ment dBuV/m	Limit dBuV/m	Margin dB	Detector	Comment
1 *	2438.0000	49.41	33.21	82.62	54.00	28.62	AVG	No Limit
2	2438.4000	58.46	33.21	91.67	74.00	17.67	Peak	No Limit

Orthogonal Axis :	X
Test Mode :	TX N-20M MODE 2437MHz

Vertical

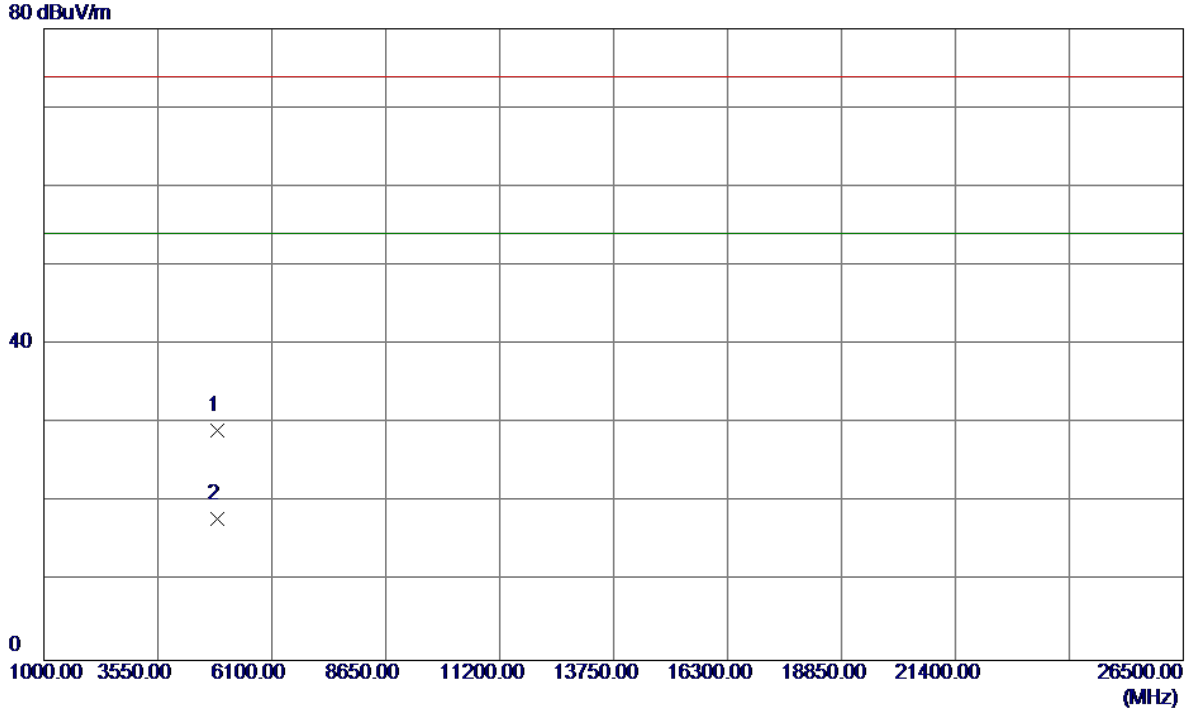

No.	Freq. MHz	Reading Level dBuV/m	Correct Factor dB	Measure ment dBuV/m	Limit dBuV/m	Margin dB	Detector	Comment
1	4875.9900	24.00	5.07	29.07	74.00	-44.93	Peak	
2 *	4876.0050	12.91	5.07	17.98	54.00	-36.02	AVG	

Orthogonal Axis :	X
Test Mode :	TX N-20M MODE 2437MHz

Horizontal

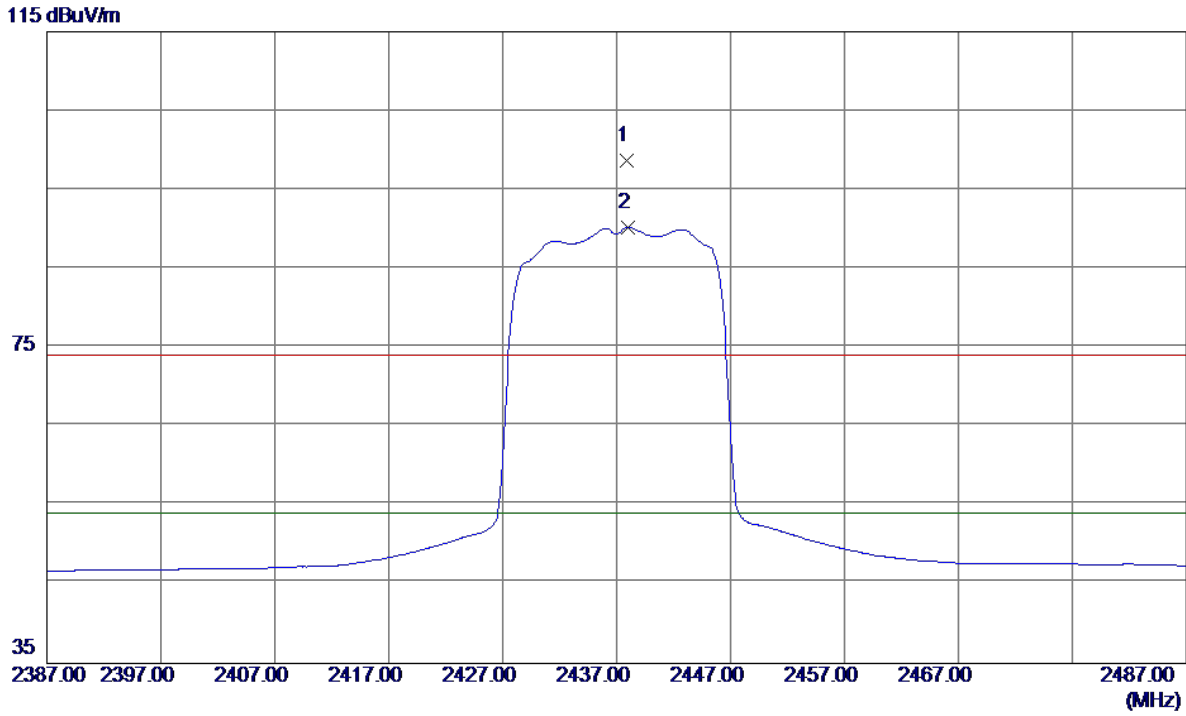

No.	Freq. MHz	Reading Level dBuV/m	Correct Factor dB	Measure ment dBuV/m	Limit dBuV/m	Margin dB	Detector	Comment
1	2437.9000	65.46	33.21	98.67	74.00	24.67	Peak	No Limit
2 *	2438.0000	57.04	33.21	90.25	54.00	36.25	AVG	No Limit

Orthogonal Axis :	X
Test Mode :	TX N-20M MODE 2437MHz

Horizontal

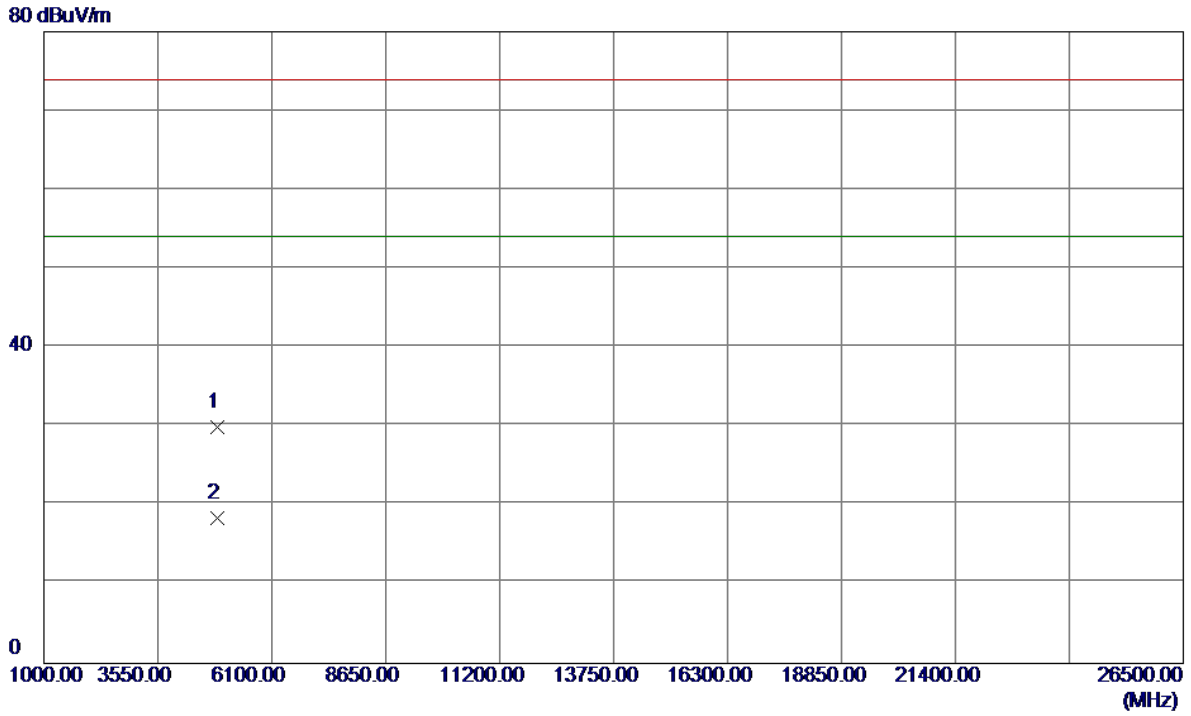

No.	Freq. MHz	Reading Level dBuV/m	Correct Factor dB	Measure ment dBuV/m	Limit dBuV/m	Margin dB	Detector	Comment
1	4874.3900	24.85	5.07	29.92	74.00	-44.08	Peak	
2 *	4874.6450	13.39	5.07	18.46	54.00	-35.54	AVG	

Orthogonal Axis :	X
Test Mode :	TX N-20M MODE 2462MHz

Vertical

115 dBuV/m

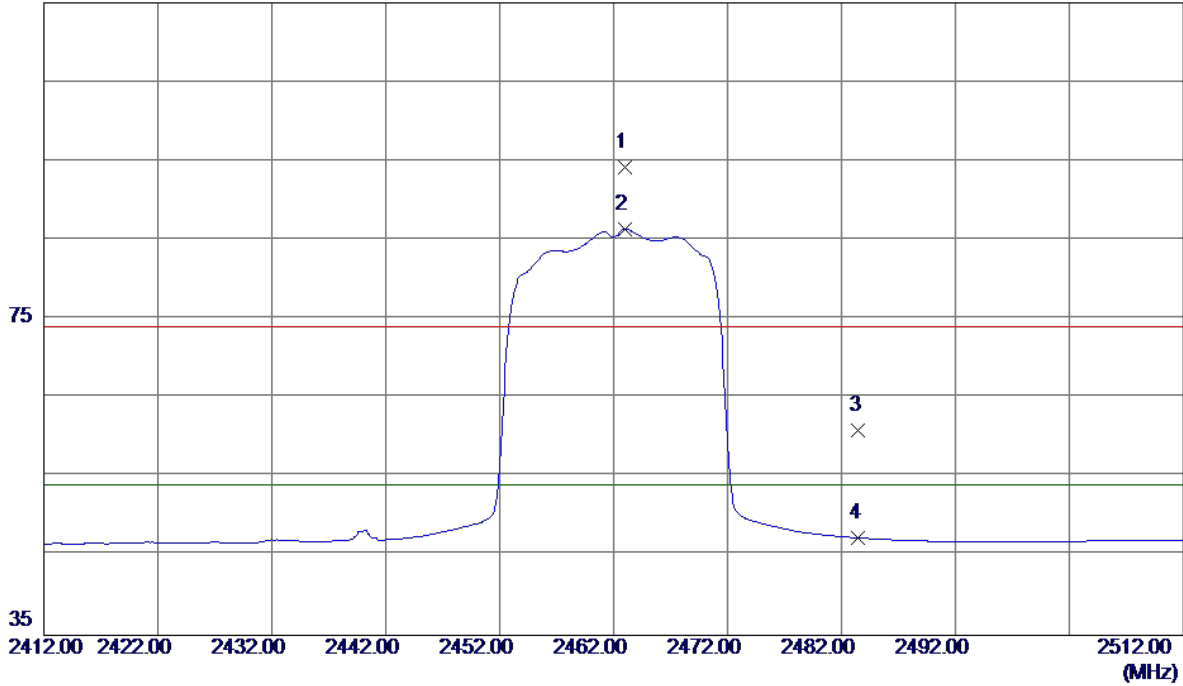

No.	Freq. MHz	Reading Level dBuV/m	Correct Factor dB	Measure ment dBuV/m	Limit dBuV/m	Margin dB	Detector	Comment
1	2463.0000	60.93	33.32	94.25	74.00	20.25	Peak	No Limit
2 *	2463.0000	53.04	33.32	86.36	54.00	32.36	AVG	No Limit
3	2483.5000	27.50	33.40	60.90	74.00	-13.10	Peak	
4	2483.5000	13.93	33.40	47.33	54.00	-6.67	AVG	

Orthogonal Axis :	X
Test Mode :	TX N-20M MODE 2462MHz

Vertical

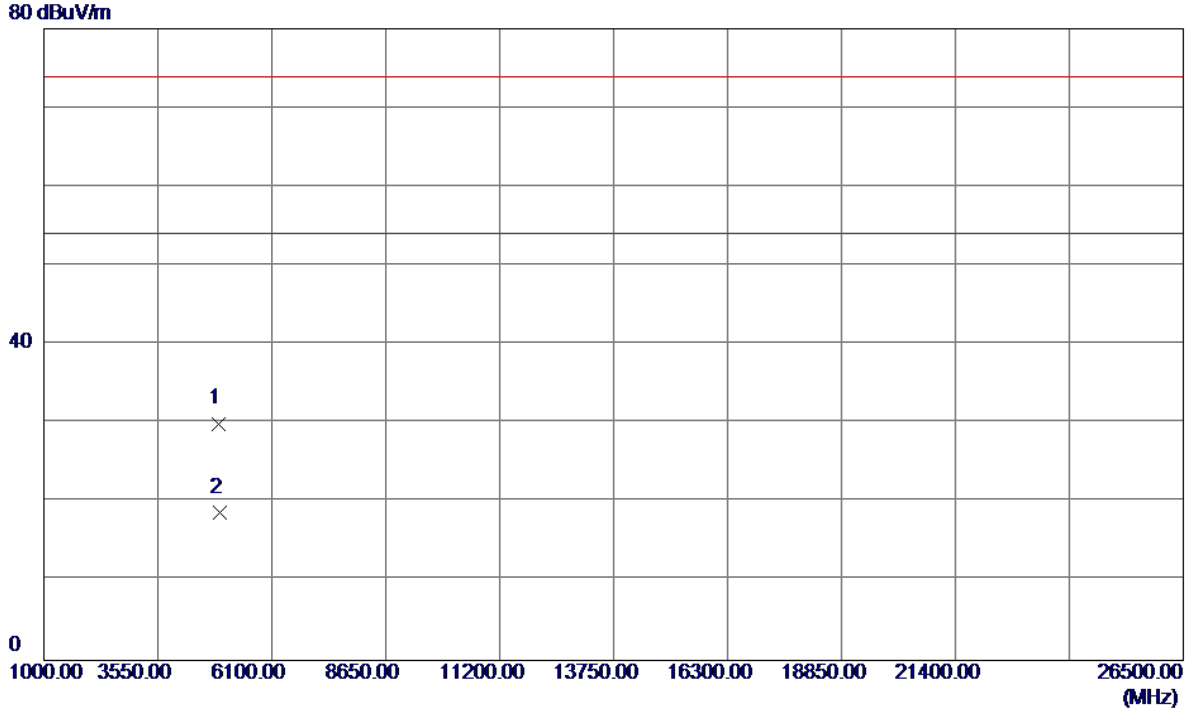

No.	Freq. MHz	Reading Level dBuV/m	Correct Factor dB	Measure ment dBuV/m	Limit dBuV/m	Margin dB	Detector	Comment
1	4923.0450	24.73	5.27	30.00	74.00	-44.00	Peak	
2 *	4924.2200	13.43	5.28	18.71	54.00	-35.29	AVG	

Orthogonal Axis :	X
Test Mode :	TX N-20M MODE 2462MHz

Horizontal

115 dBuV/m

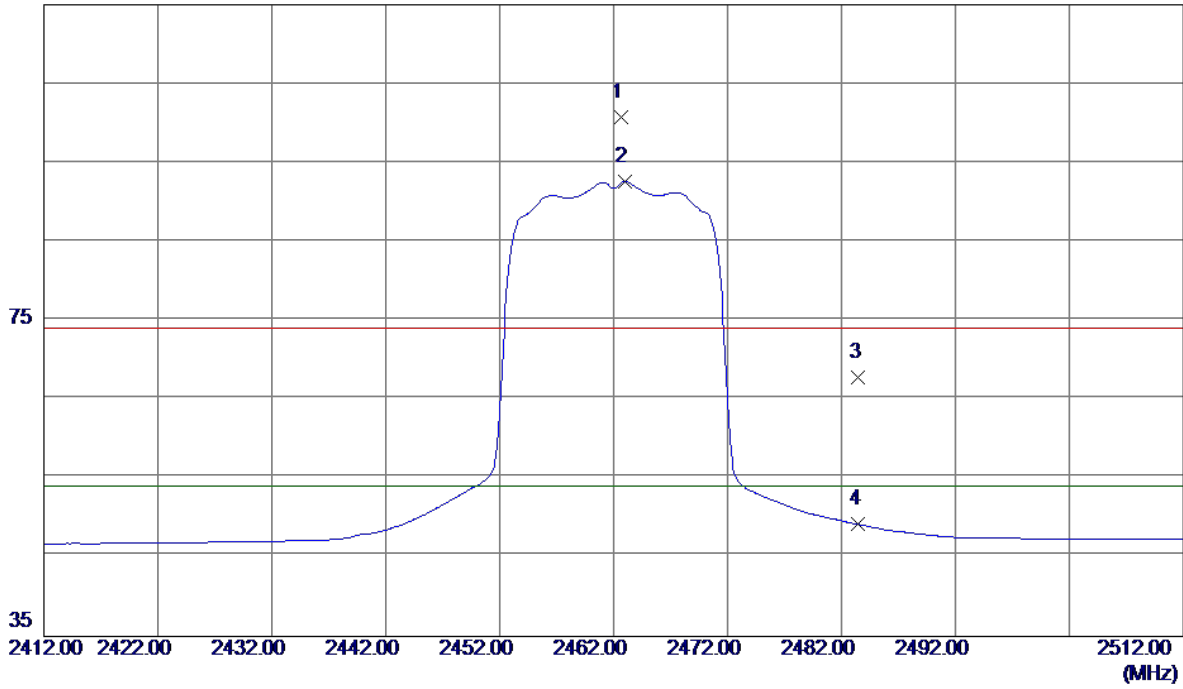

No.	Freq. MHz	Reading Level dBuV/m	Correct Factor dB	Measure ment dBuV/m	Limit dBuV/m	Margin dB	Detector	Comment
1	2462.7000	67.46	33.31	100.77	74.00	26.77	Peak	No Limit
2 *	2463.0000	59.26	33.32	92.58	54.00	38.58	AVG	No Limit
3	2483.5000	34.39	33.40	67.79	74.00	-6.21	Peak	
4	2483.5000	15.79	33.40	49.19	54.00	-4.81	AVG	

Orthogonal Axis :	X
Test Mode :	TX N-20M MODE 2462MHz

Horizontal

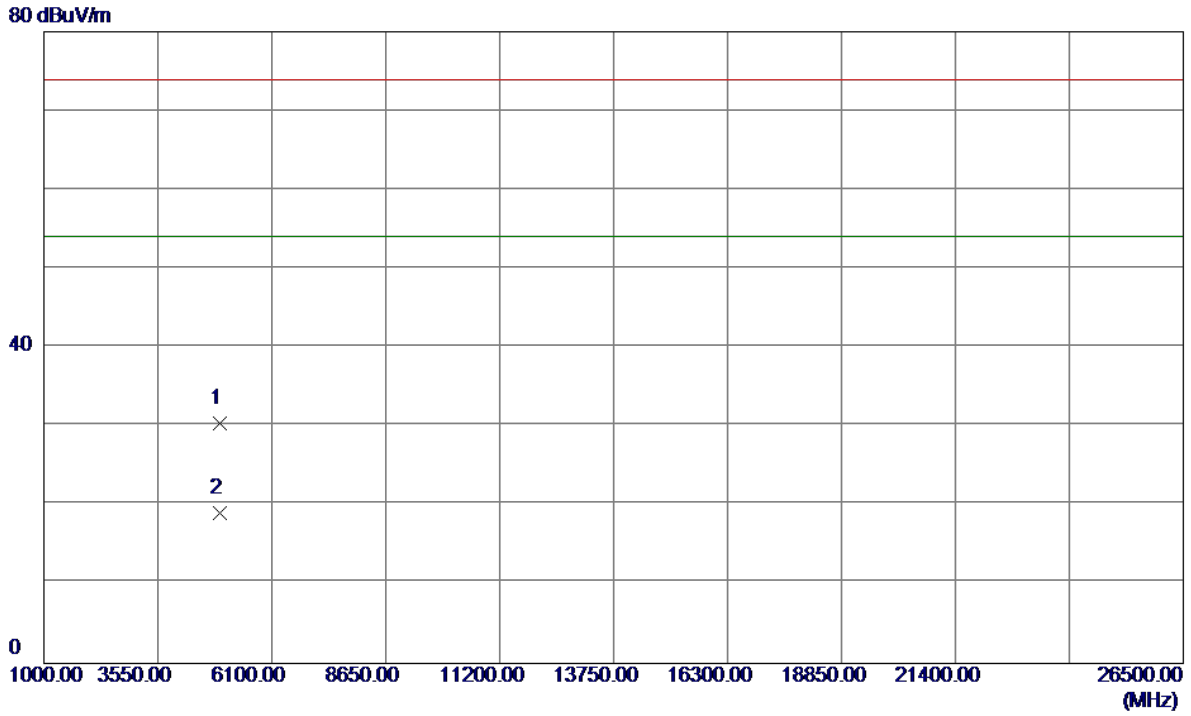

No.	Freq. MHz	Reading Level dBuV/m	Correct Factor dB	Measure ment dBuV/m	Limit dBuV/m	Margin dB	Detector	Comment
1	4924.8350	25.12	5.28	30.40	74.00	-43.60	Peak	
2 *	4926.0250	13.77	5.29	19.06	54.00	-34.94	AVG	

ATTACHMENT E - BANDWIDTH

Test Mode : TX B Mode_CH01/06/11

Frequency (MHz)	6dB Bandwidth (MHz)	99% Occupied BW (MHz)	Min. Limit (kHz)	Test Result
2412	8.10	12.20	500	Complies
2437	8.12	12.08	500	Complies
2462	8.58	12.12	500	Complies

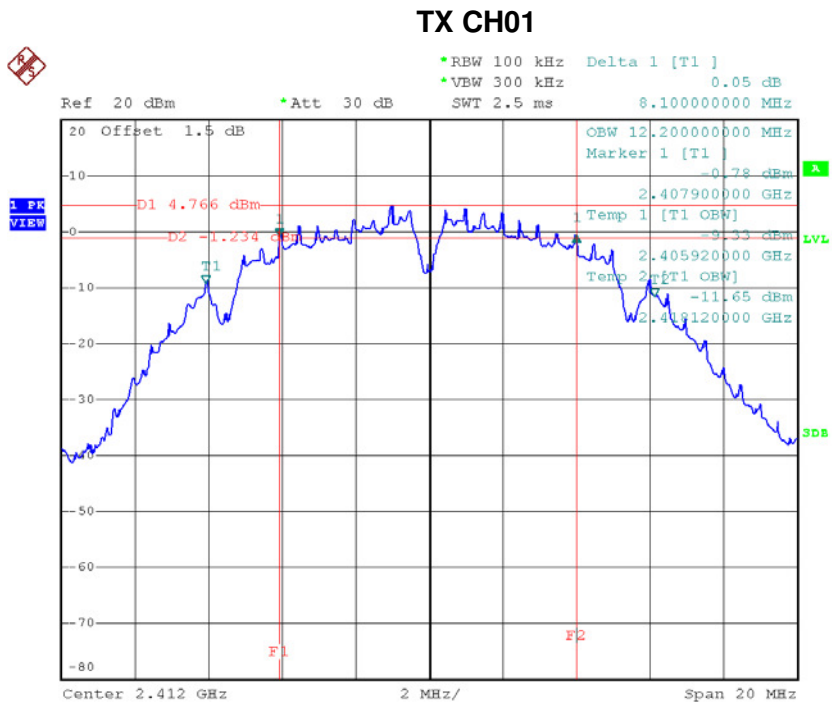

Date: 27.MAR.2017 18:21:37

TX CH06

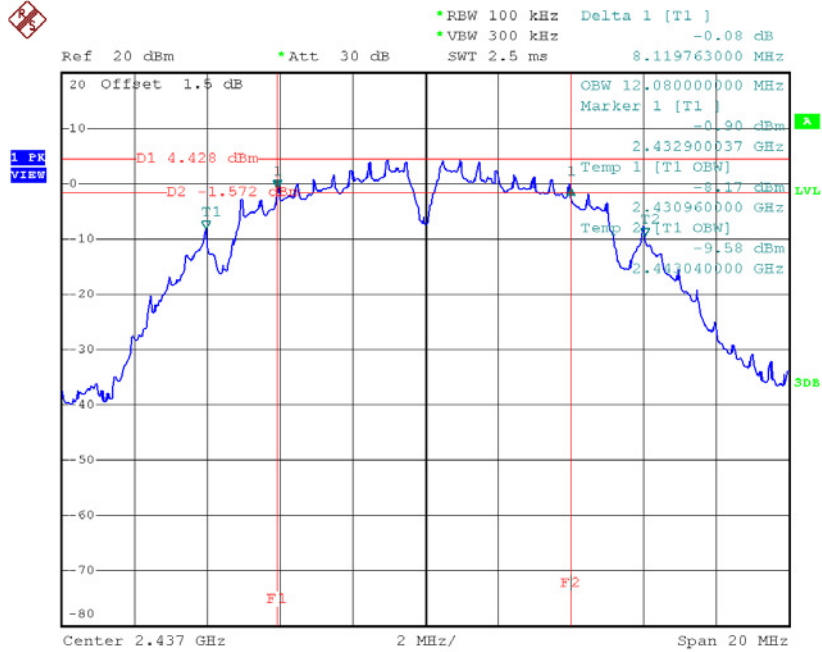

Date: 27.MAR.2017 18:23:08

TX CH11

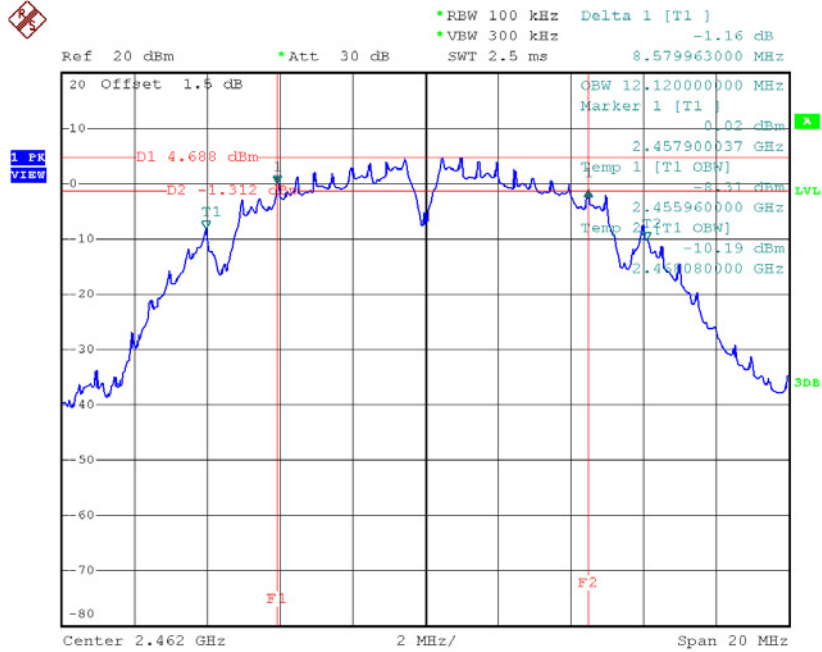

Date: 27.MAR.2017 18:24:28

Test Mode: TX G Mode_CH01/06/11

Frequency (MHz)	6dB Bandwidth (MHz)	99% Occupied BW (MHz)	Min. Limit (kHz)	Test Result
2412	14.24	16.36	500	Complies
2437	15.74	16.36	500	Complies
2462	14.24	16.36	500	Complies

TX CH01

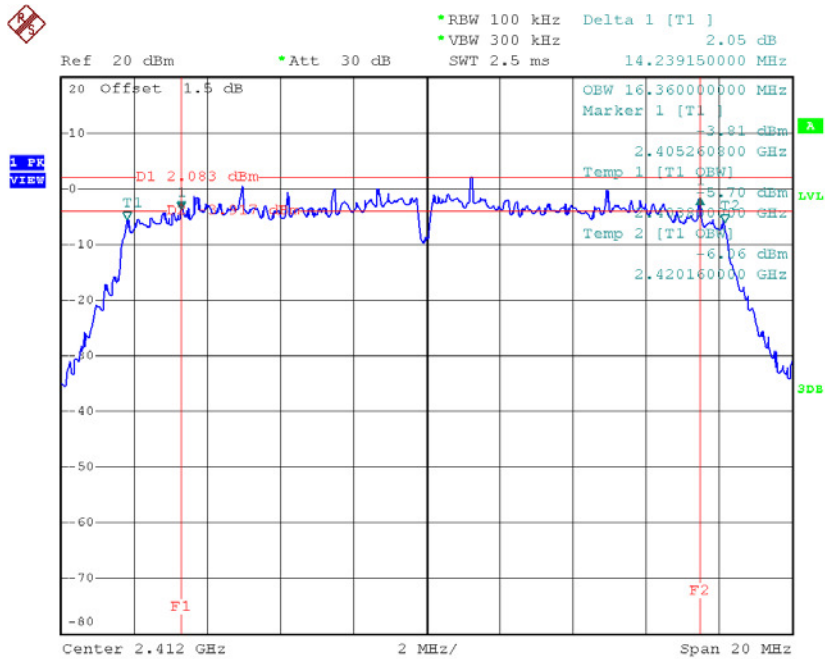

Date: 27.MAR.2017 18:25:51

TX CH06

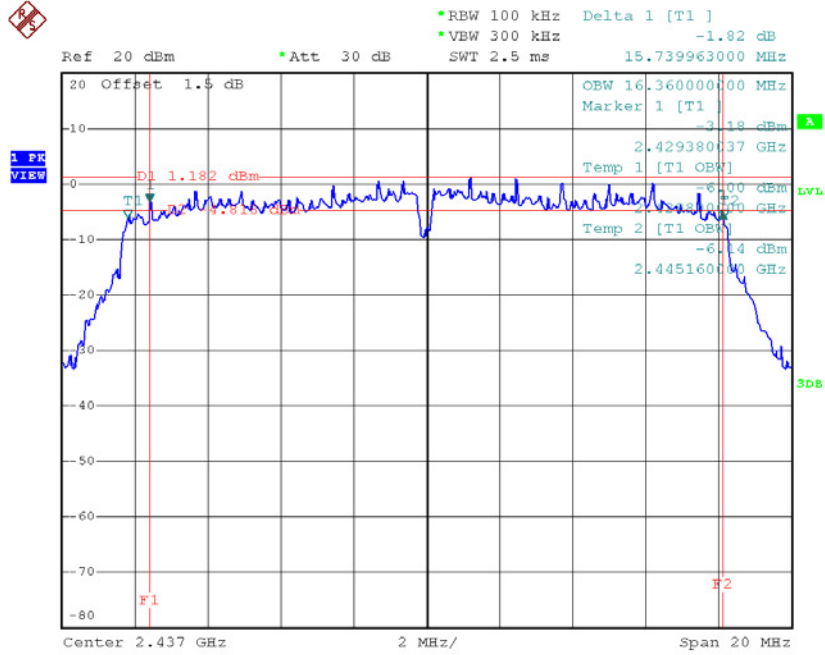

Date: 27.MAR.2017 18:27:10

TX CH11

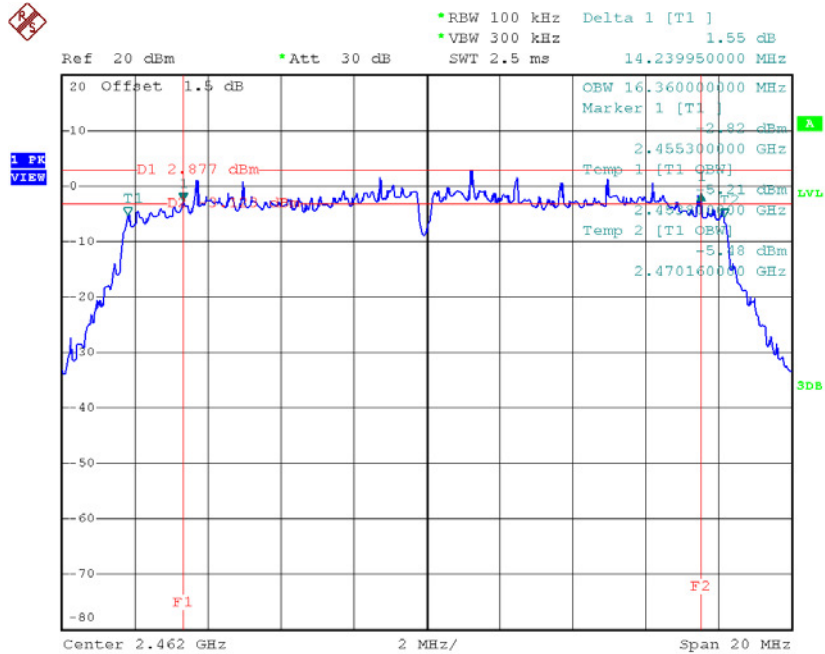

Date: 27.MAR.2017 18:28:19

Test Mode : TX N-20MHz Mode_CH01/06/11

Frequency (MHz)	6dB Bandwidth (MHz)	99% Occupied BW (MHz)	Min. Limit (kHz)	Test Result
2412	15.12	17.56	500	Complies
2437	17.03	17.56	500	Complies
2462	15.07	17.56	500	Complies

TX CH01



Date: 27.MAR.2017 18:29:39

TX CH06

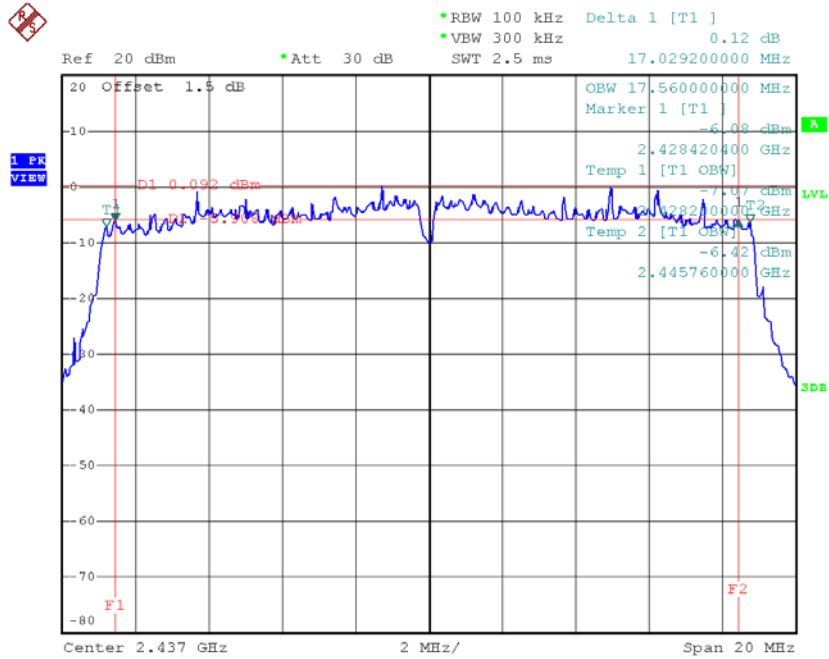

Date: 27.MAR.2017 18:30:52

TX CH11

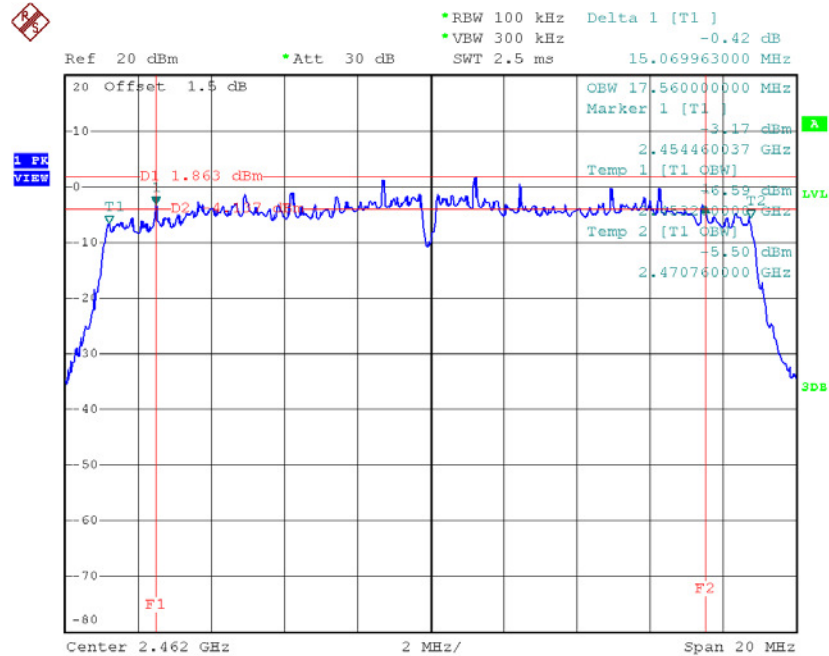

Date: 27.MAR.2017 18:32:04

ATTACHMENT F – MAXIMUM PEAK CONDUCTED OUTPUT POWER

Test Mode :TX B Mode_CH01/06/11					
Frequency (MHz)	Conducted Power (dBm)	Conducted Power (W)	Max. Limit (dBm)	Max. Limit (W)	Result
2412	15.84	0.04	30.00	1.00	Complies
2437	16.29	0.04	30.00	1.00	Complies
2462	16.80	0.05	30.00	1.00	Complies

Test Mode :TX G Mode_CH01/06/11					
Frequency (MHz)	Conducted Power (dBm)	Conducted Power (W)	Max. Limit (dBm)	Max. Limit (W)	Result
2412	21.37	0.14	30.00	1.00	Complies
2437	21.86	0.15	30.00	1.00	Complies
2462	22.42	0.17	30.00	1.00	Complies

Test Mode :TX N20 Mode_CH01/06/11					
Frequency (MHz)	Conducted Power (dBm)	Conducted Power (W)	Max. Limit (dBm)	Max. Limit (W)	Result
2412	21.07	0.13	30.00	1.00	Complies
2437	21.44	0.14	30.00	1.00	Complies
2462	22.02	0.16	30.00	1.00	Complies

**ATTACHMENT G - ANTENNA CONDUCTED SPURIOUS
EMISSION**

Test Mode : TX B Mode

TX B mode CH01

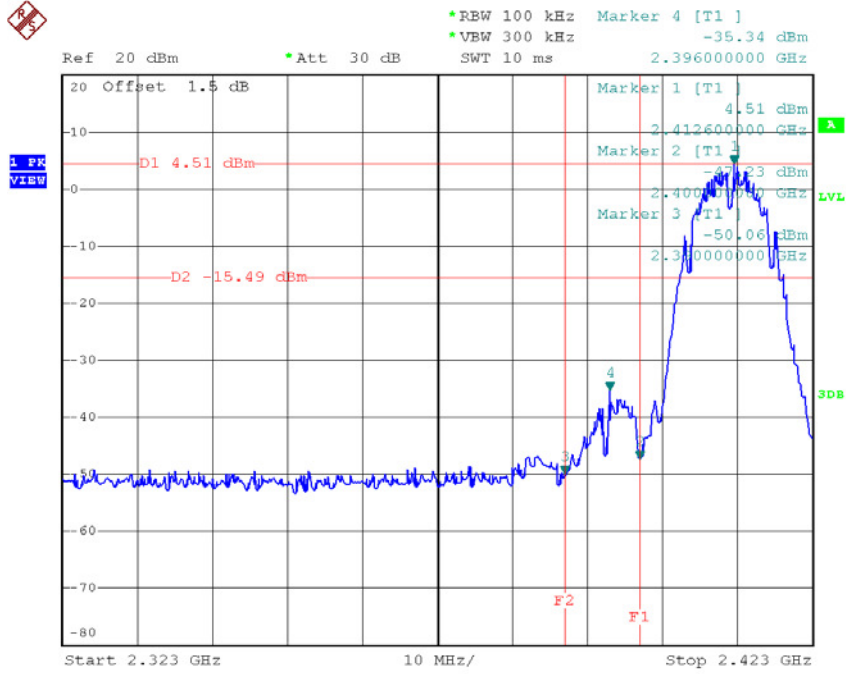

Date: 27.MAR.2017 18:22:16

TX B mode CH11

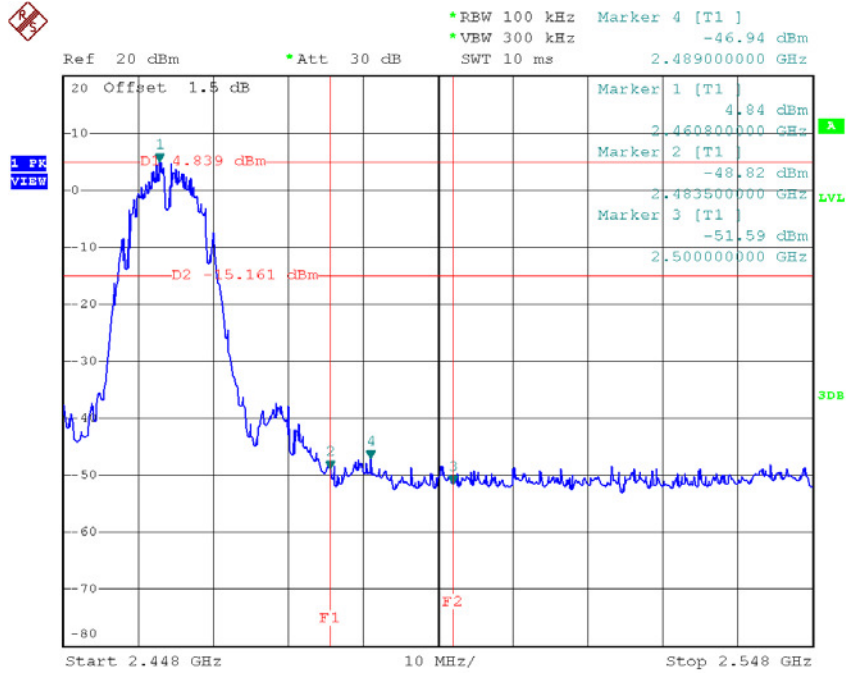

Date: 27.MAR.2017 18:25:08

TX B mode CH01 (10 Harmonic of the frequency)

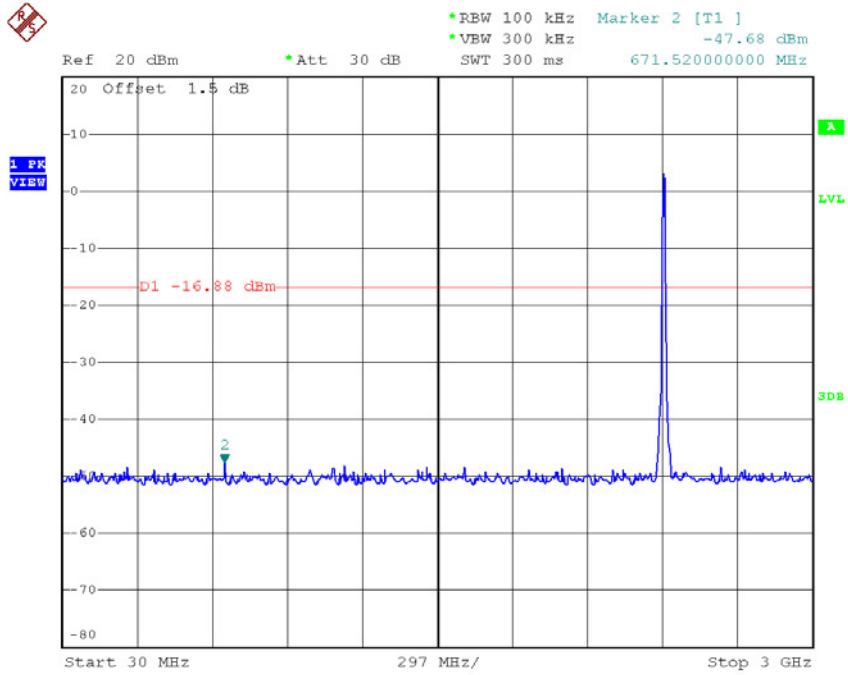

Date: 27.MAR.2017 18:21:52

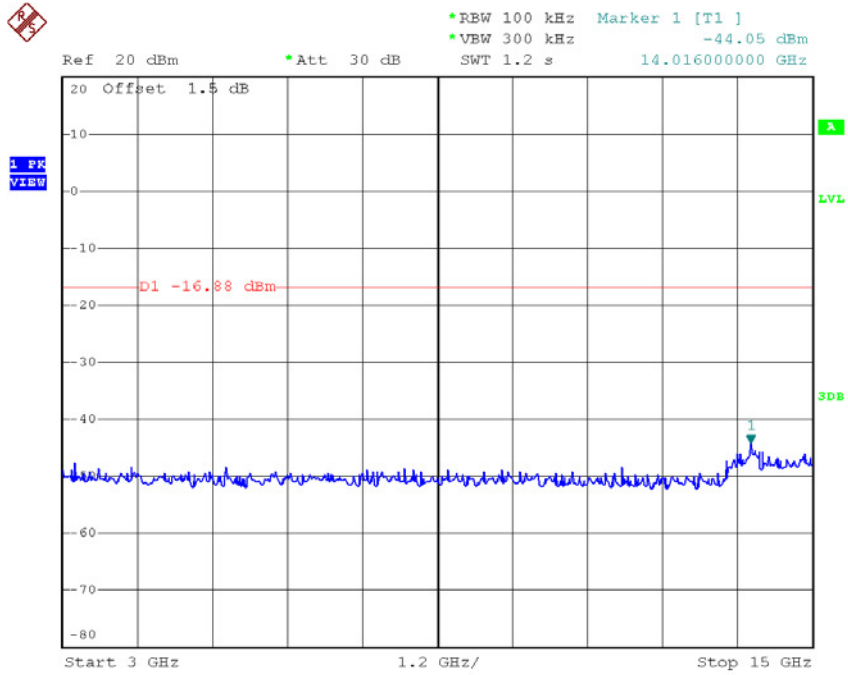

Date: 27.MAR.2017 18:22:00

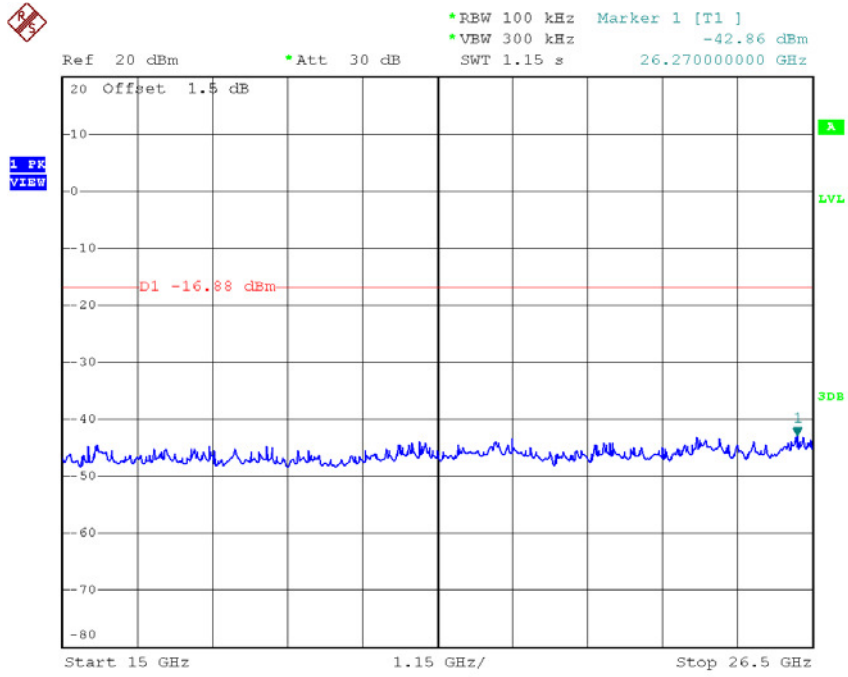

Date: 27.MAR.2017 18:22:09

TX B mode CH06 (10 Harmonic of the frequency)

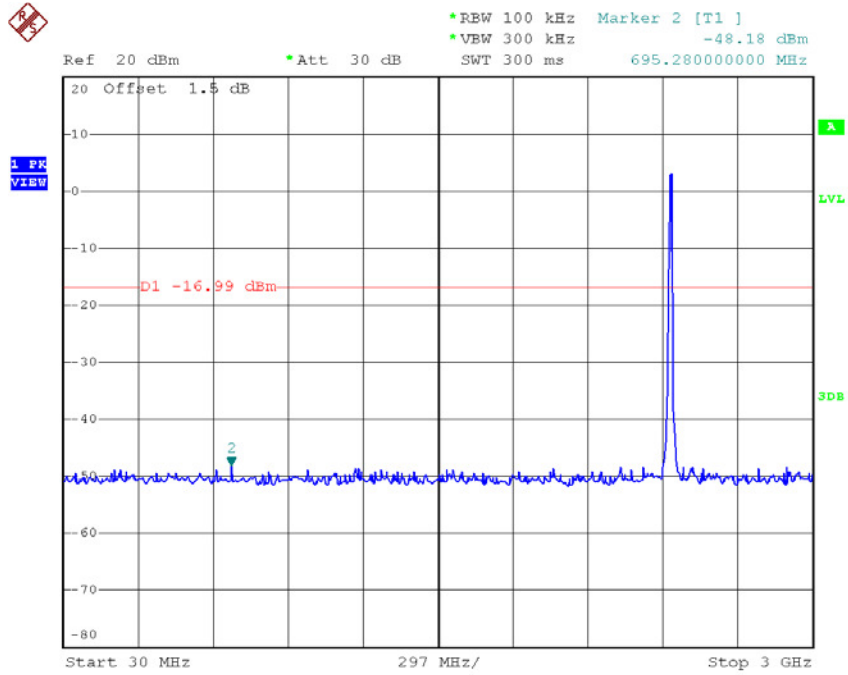

Date: 27.MAR.2017 18:23:21

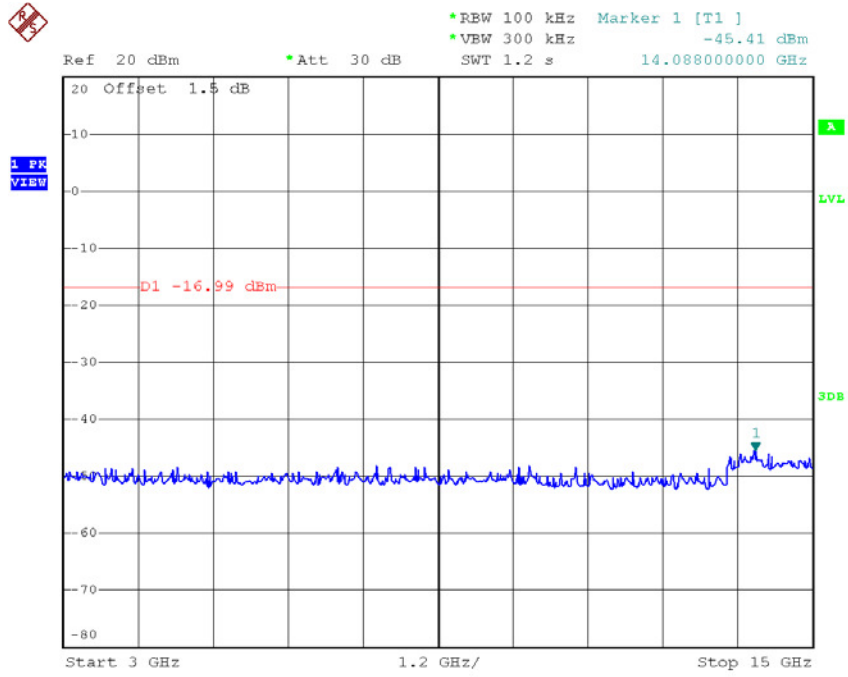

Date: 27.MAR.2017 18:23:30

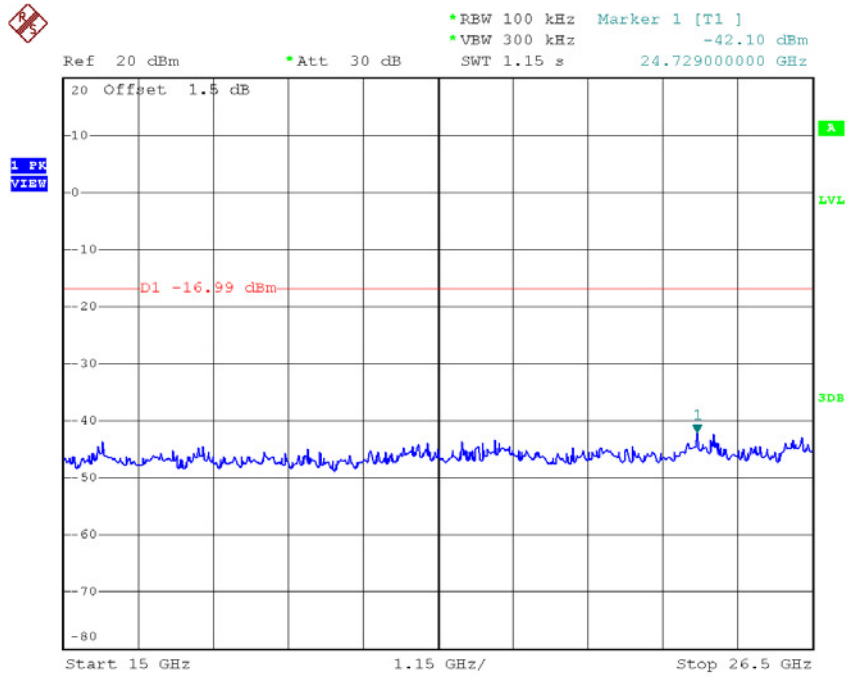

Date: 27.MAR.2017 18:23:38

TX B mode CH11 (10 Harmonic of the frequency)

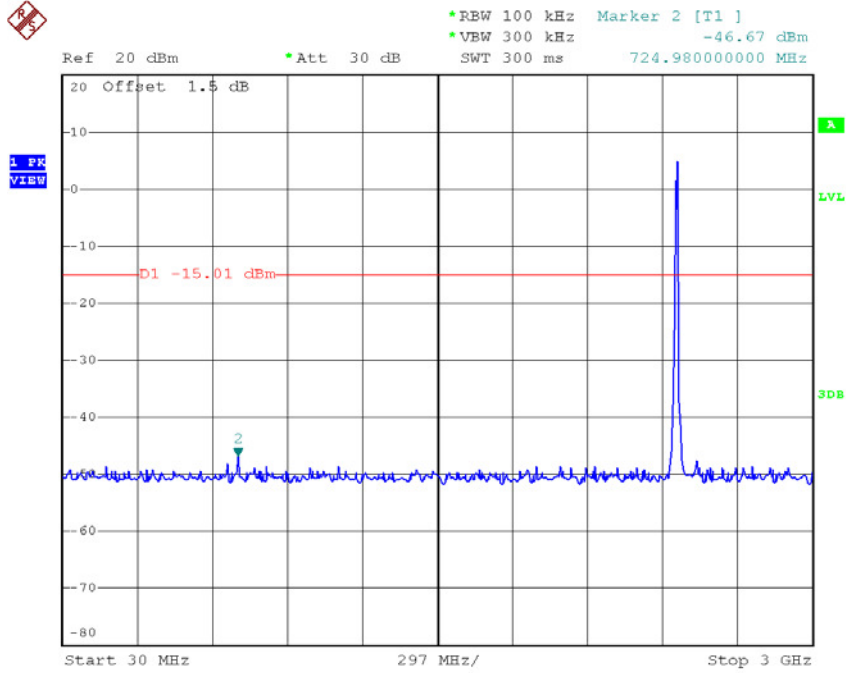

Date: 27.MAR.2017 18:24:42

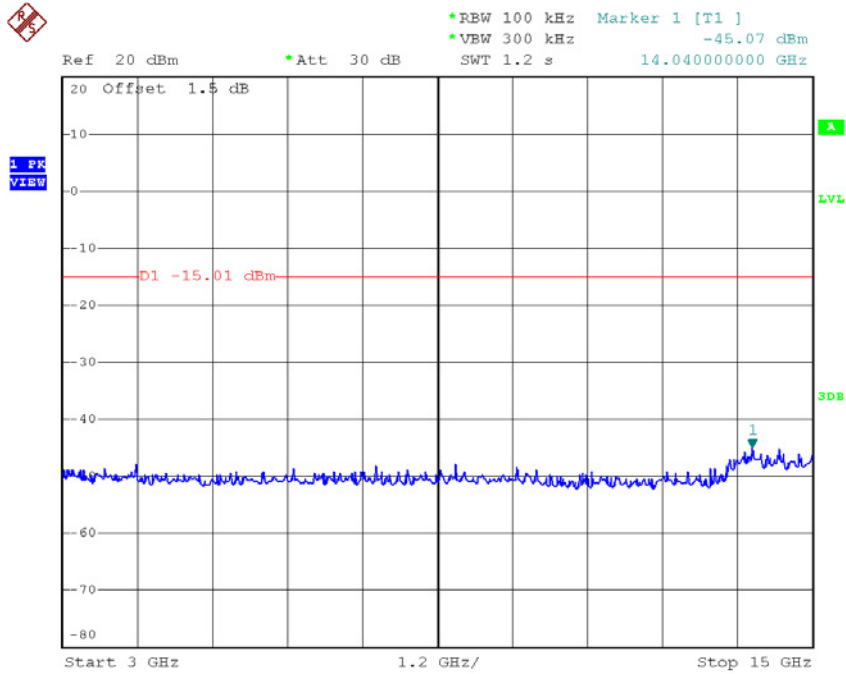

Date: 27.MAR.2017 18:24:51

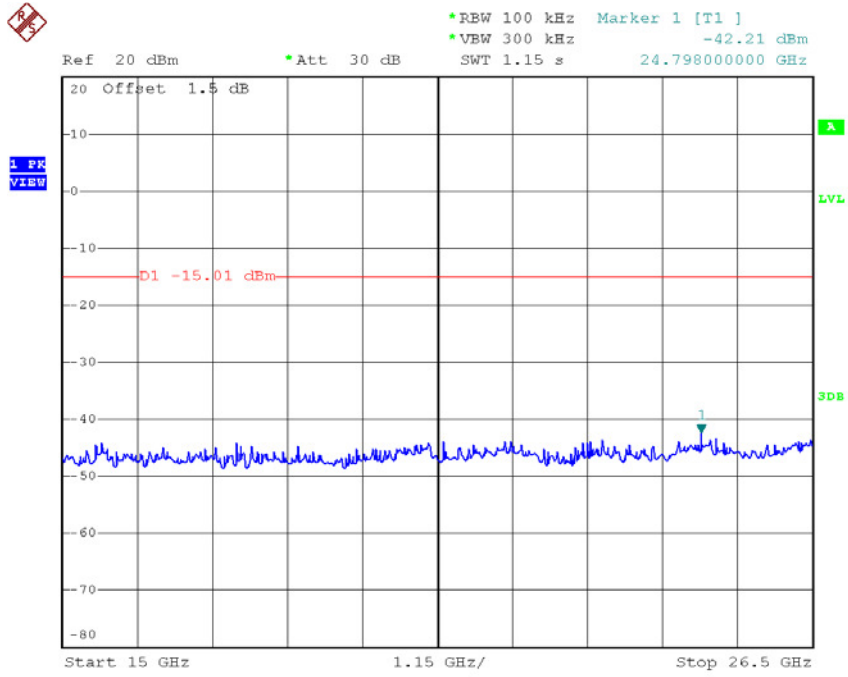

Date: 27.MAR.2017 18:25:00

Test Mode : TX G Mode

TX G mode CH01

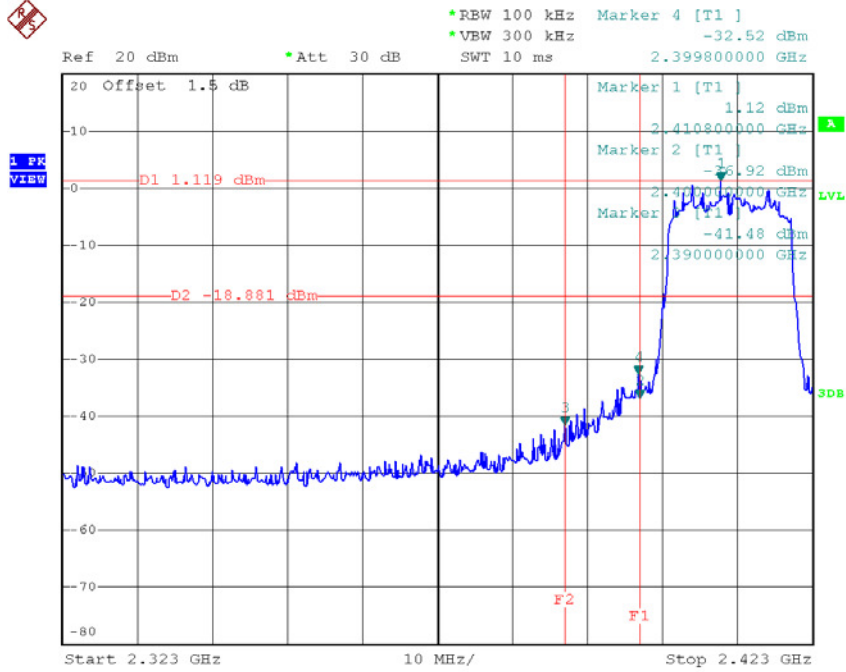

Date: 27.MAR.2017 18:26:30

TX G mode CH11

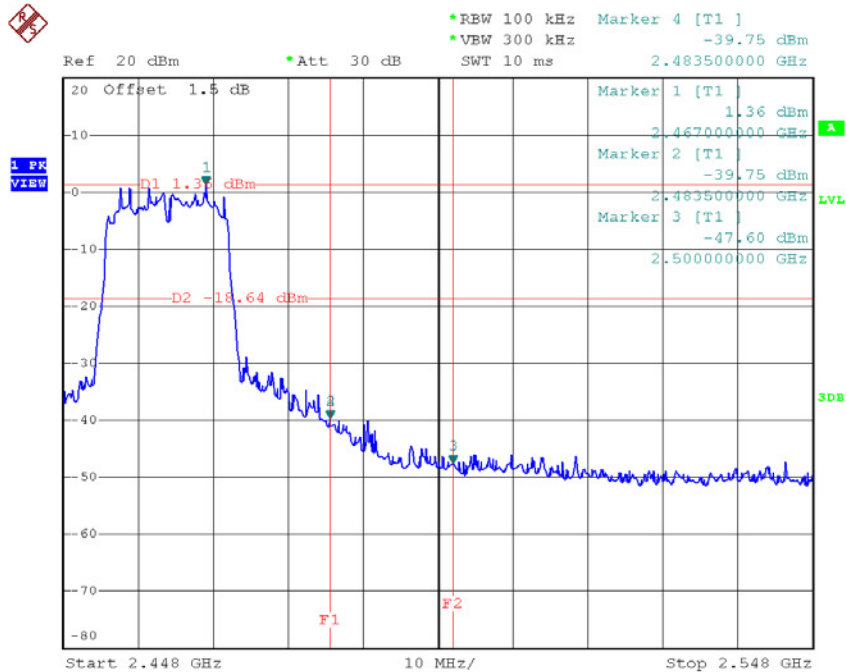

Date: 27.MAR.2017 18:28:58

TX G mode CH01 (10 Harmonic of the frequency)

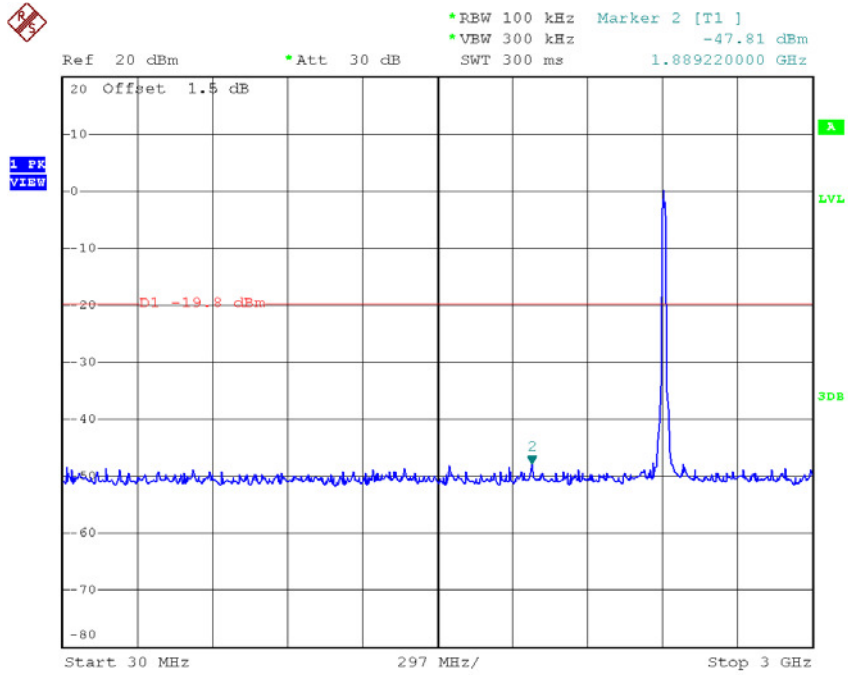

Date: 27.MAR.2017 18:26:05

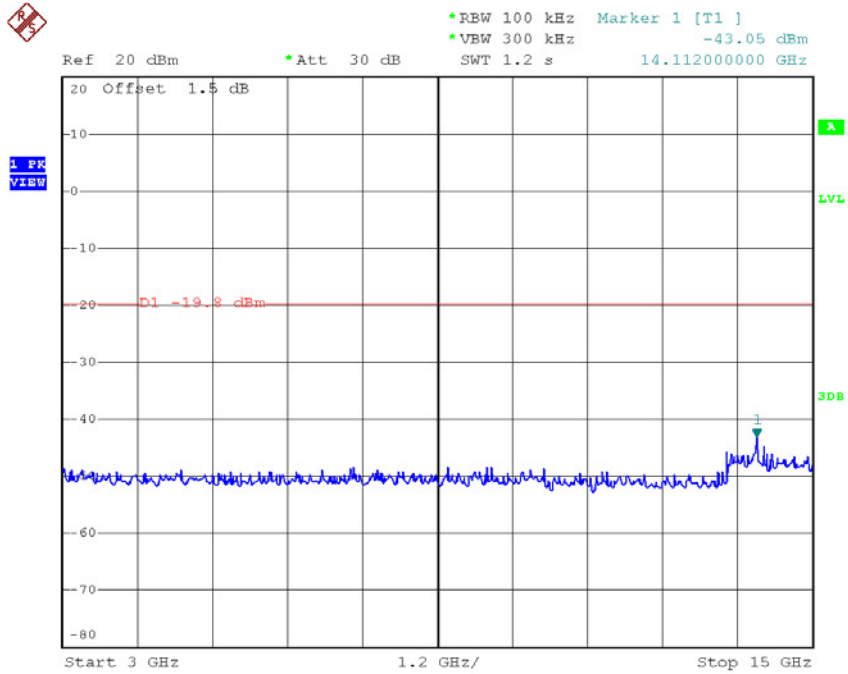

Date: 27.MAR.2017 18:26:13

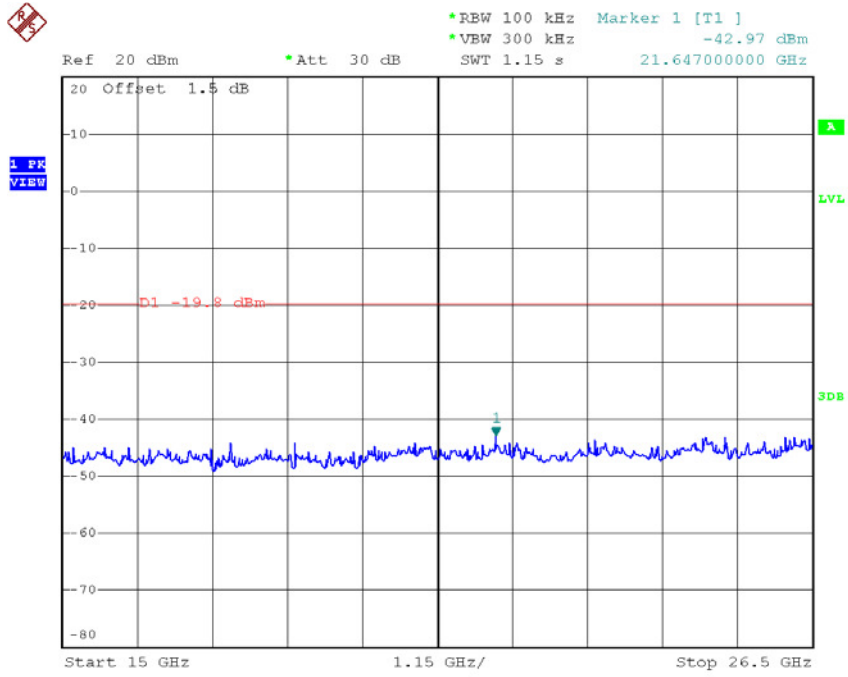

Date: 27.MAR.2017 18:26:22

TX G mode CH06 (10 Harmonic of the frequency)

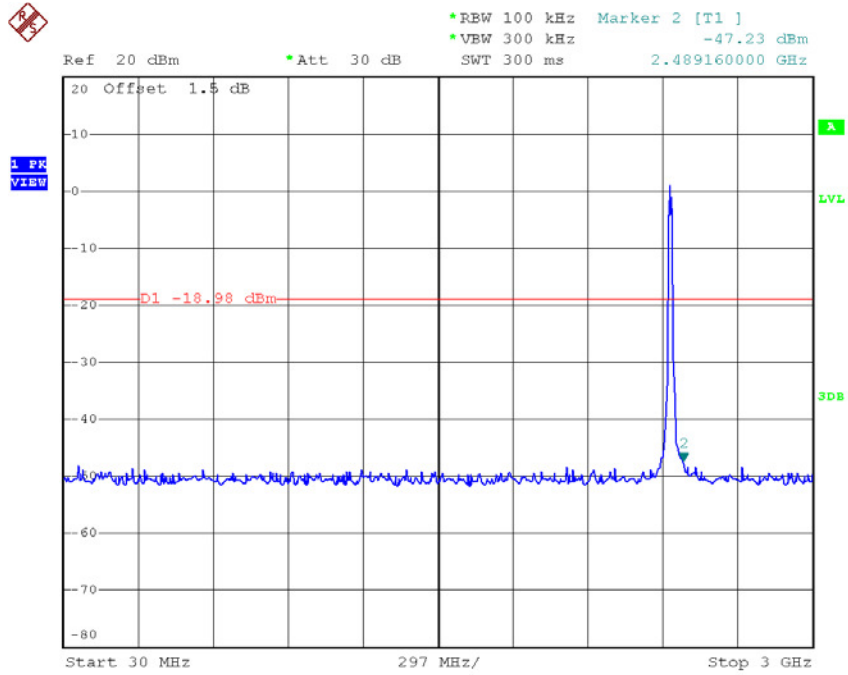

Date: 27.MAR.2017 18:27:24

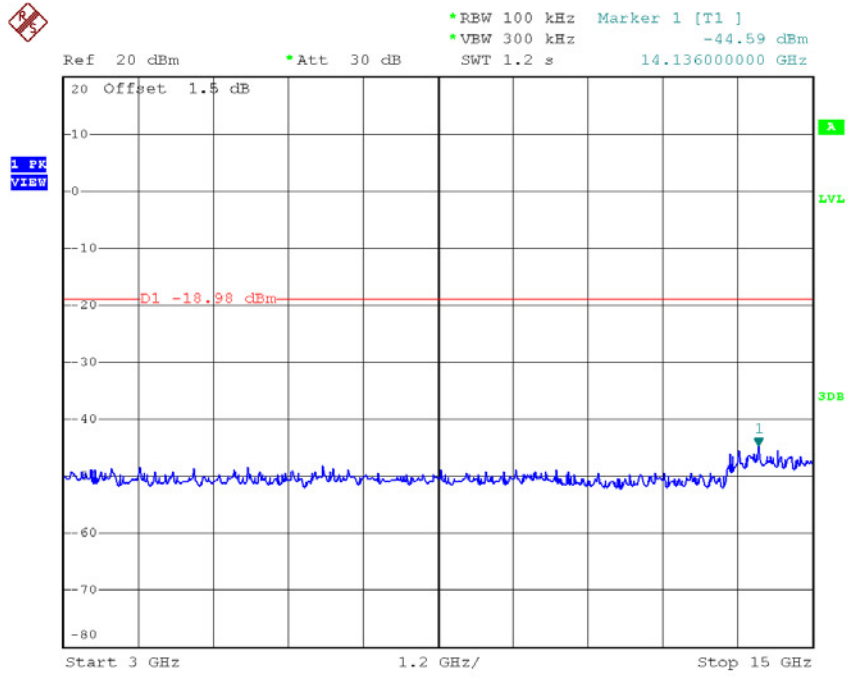

Date: 27.MAR.2017 18:27:32

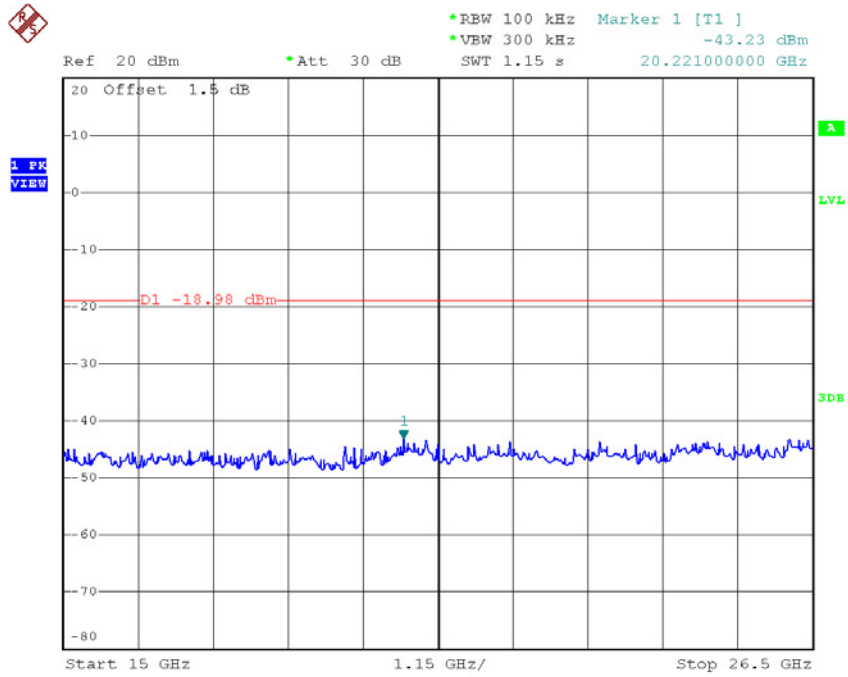

Date: 27.MAR.2017 18:27:41

TX G mode CH11 (10 Harmonic of the frequency)

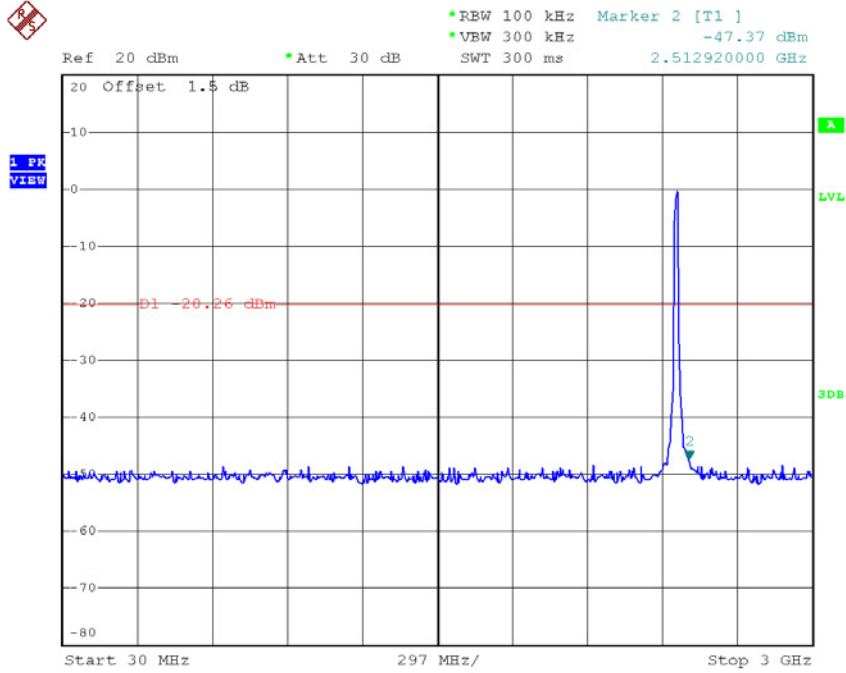

Date: 27.MAR.2017 18:28:33

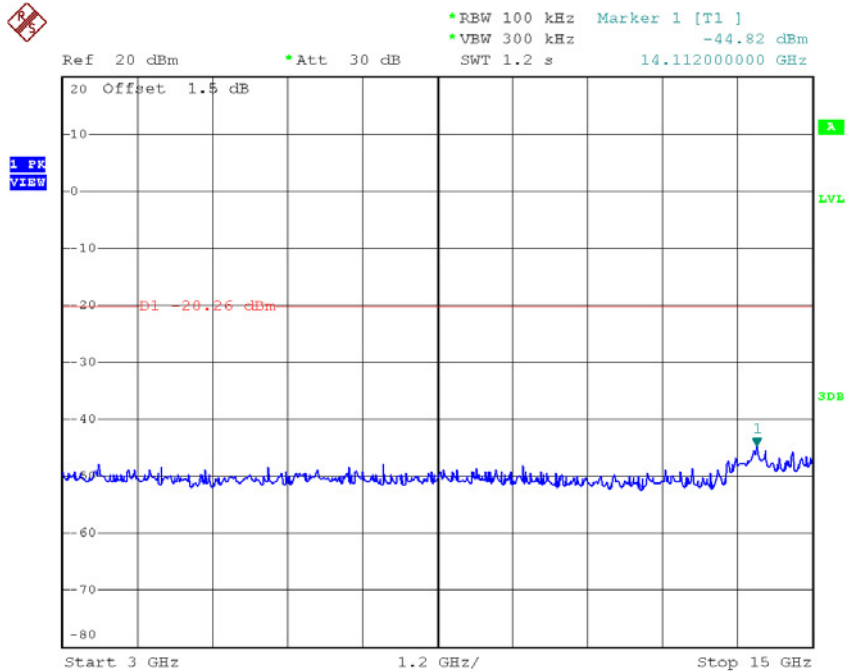

Date: 27.MAR.2017 18:28:41

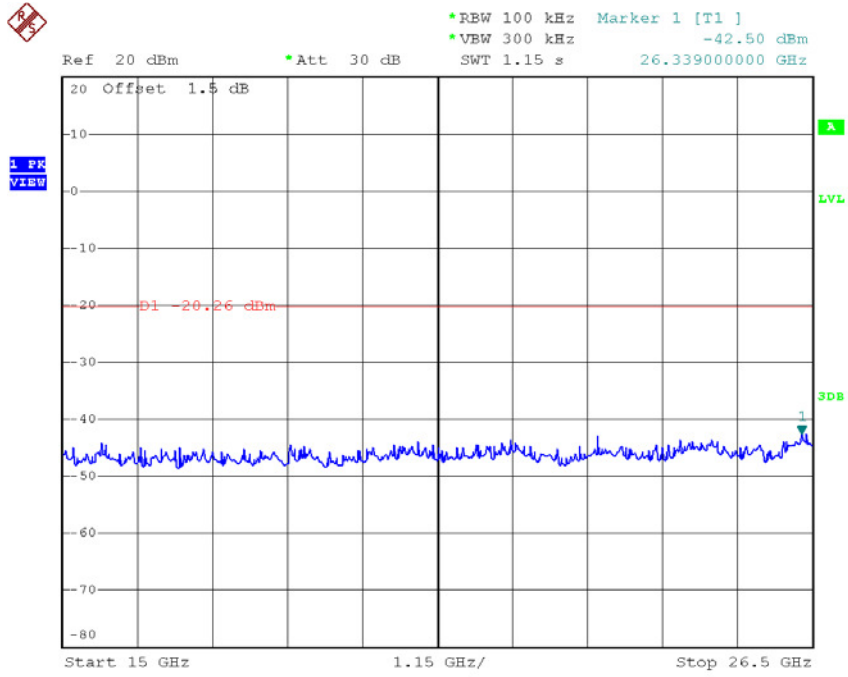

Date: 27.MAR.2017 18:28:50

Test Mode : TX N-20M Mode

TX HT20 mode CH01

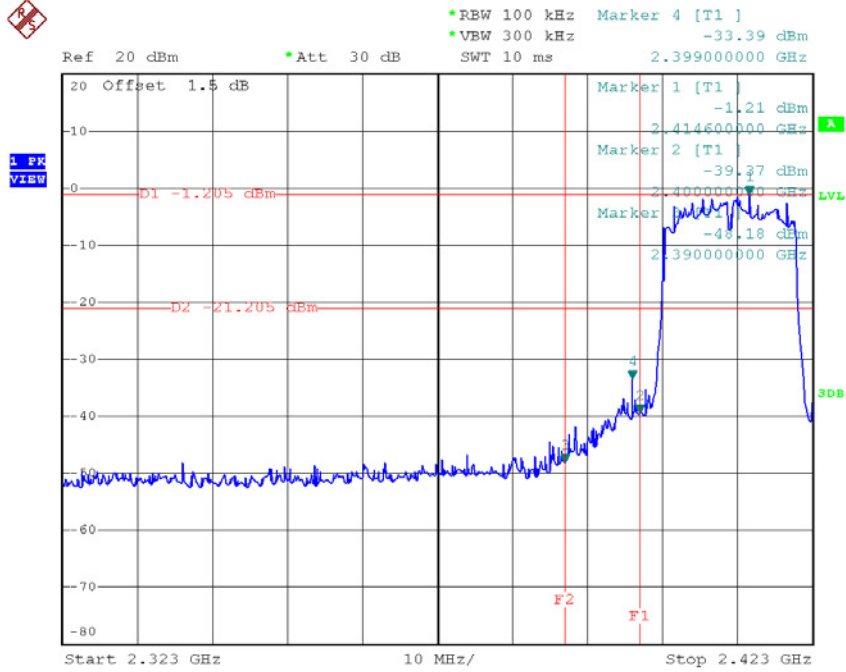

Date: 27.MAR.2017 18:30:18

TX HT20 mode CH11

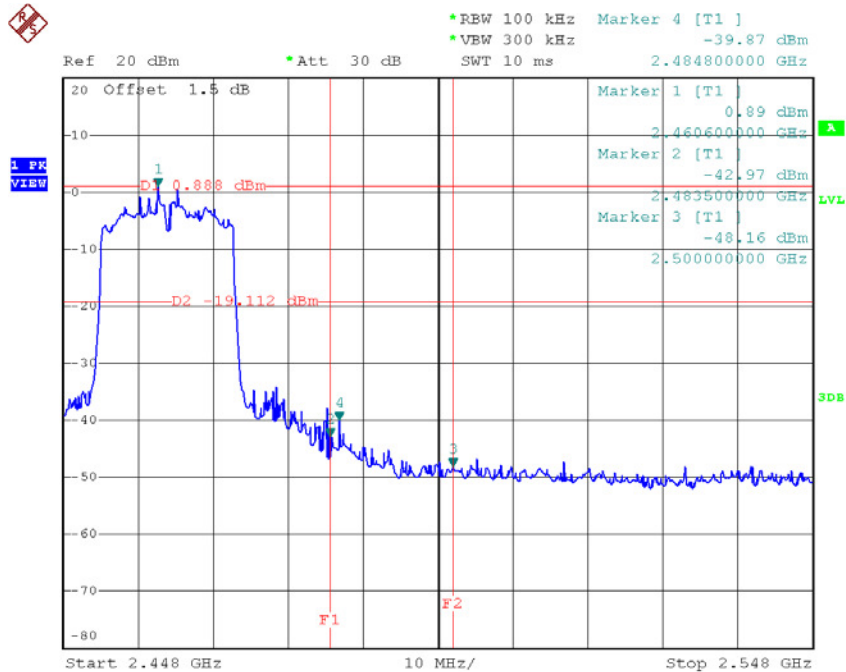

Date: 27.MAR.2017 18:32:43

TX HT20 mode CH01 (10 Harmonic of the frequency)

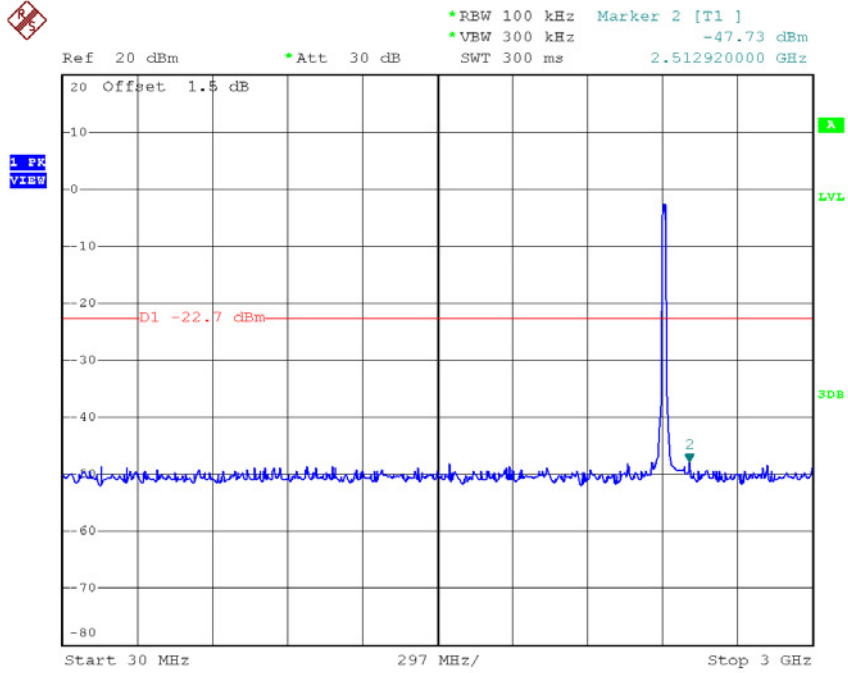

Date: 27.MAR.2017 18:29:53

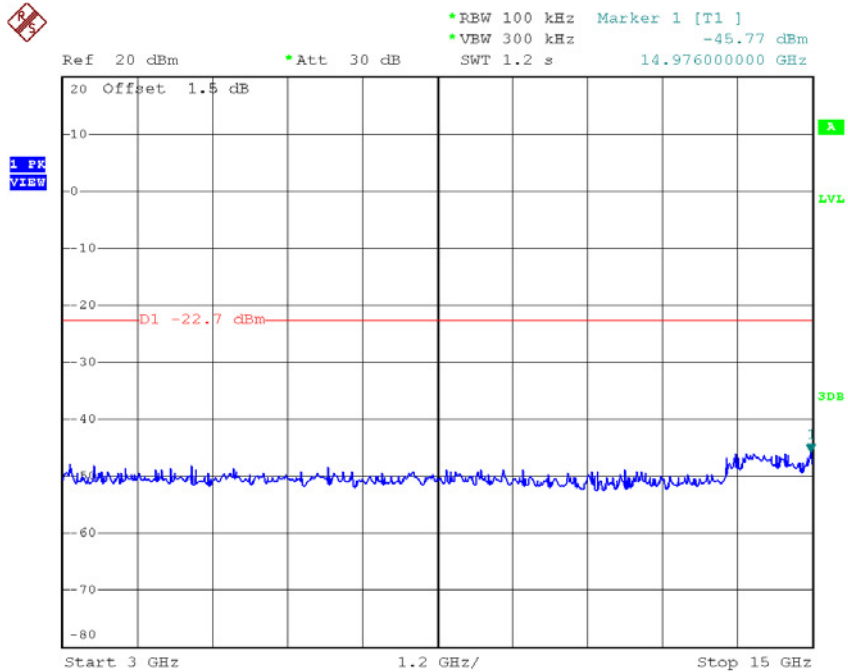

Date: 27.MAR.2017 18:30:02

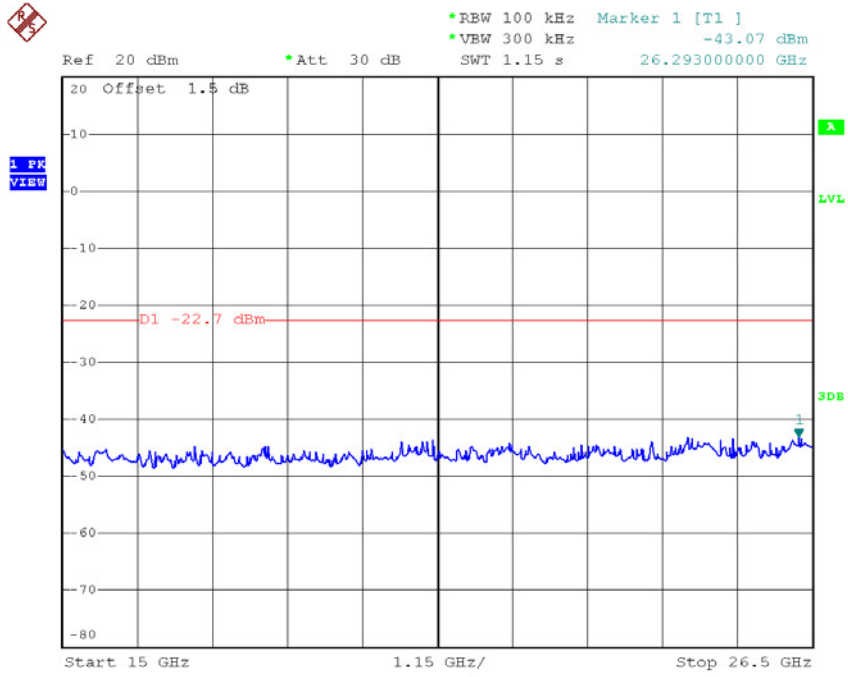

Date: 27.MAR.2017 18:30:10

TX HT20 mode CH06 (10 Harmonic of the frequency)

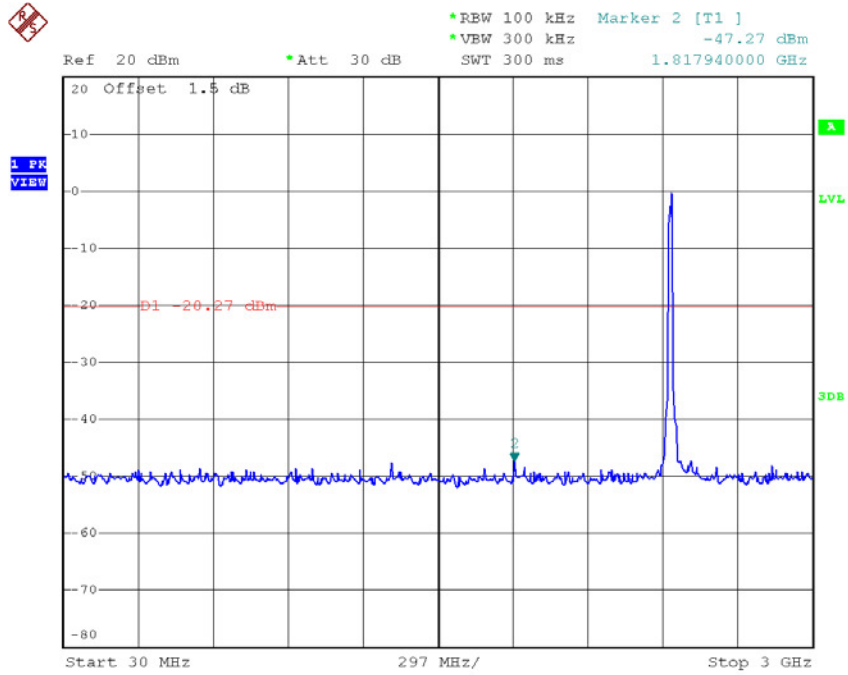

Date: 27.MAR.2017 18:31:06

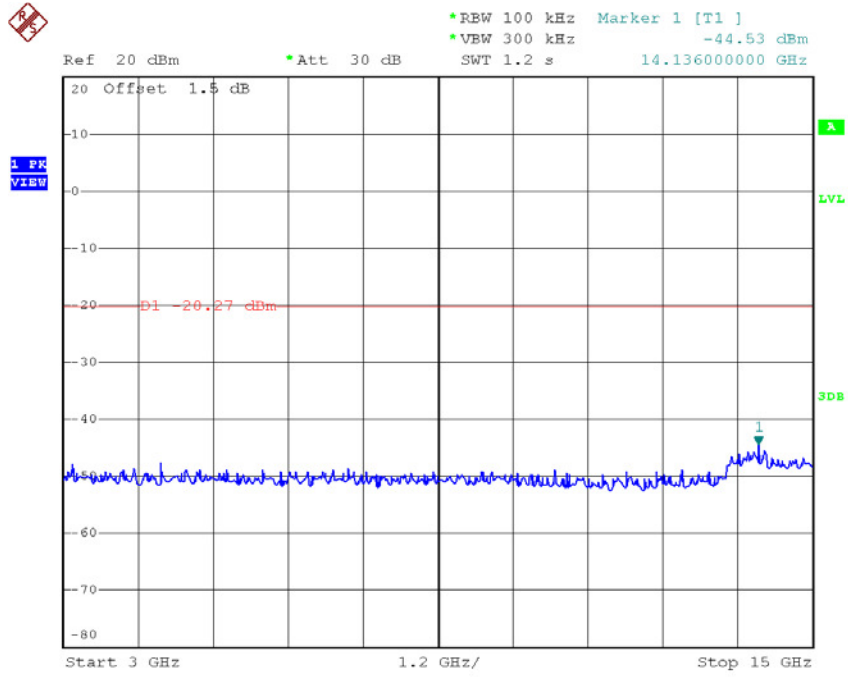

Date: 27.MAR.2017 18:31:14

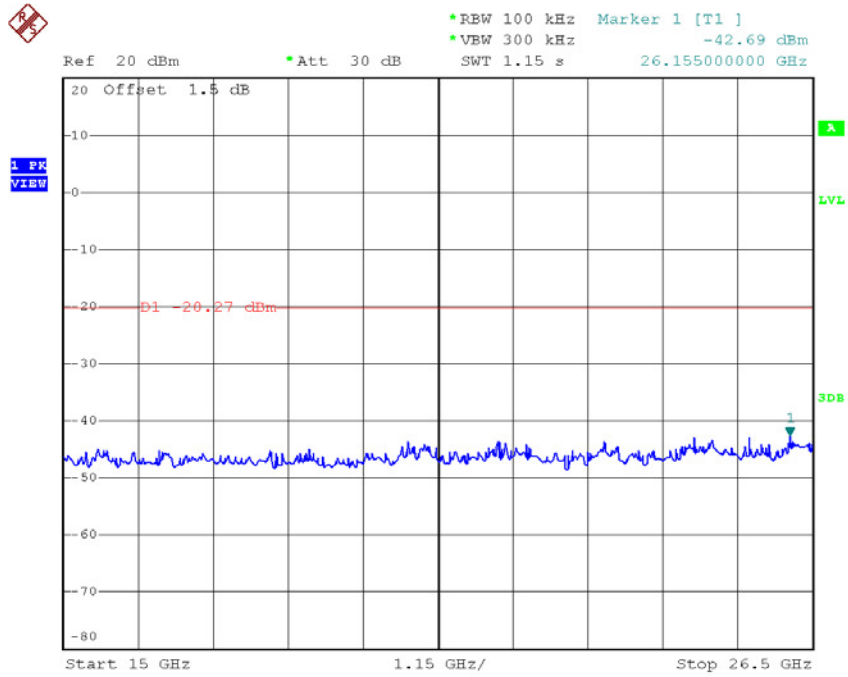

Date: 27.MAR.2017 18:31:23

TX HT20 mode CH11 (10 Harmonic of the frequency)

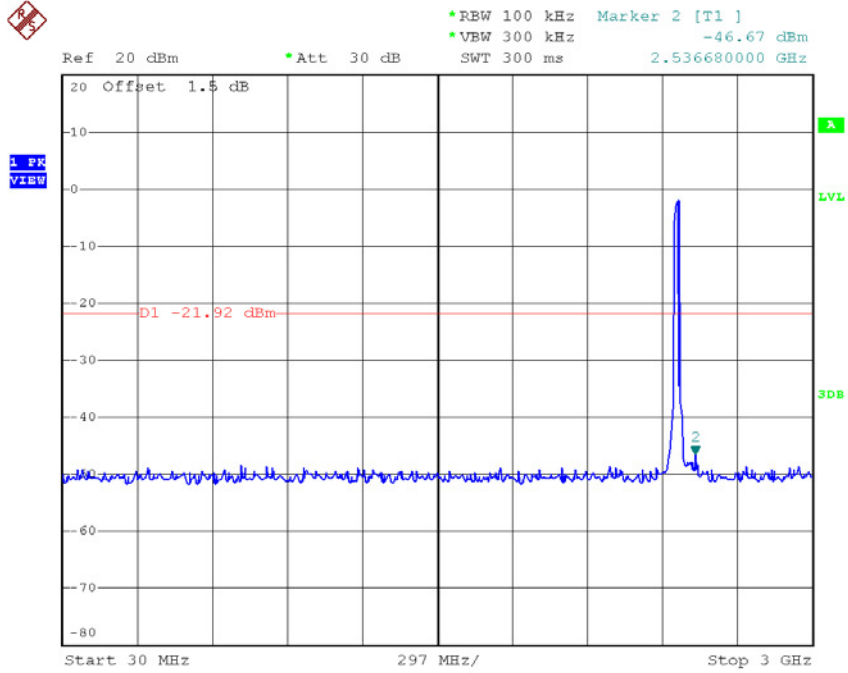

Date: 27.MAR.2017 18:32:18

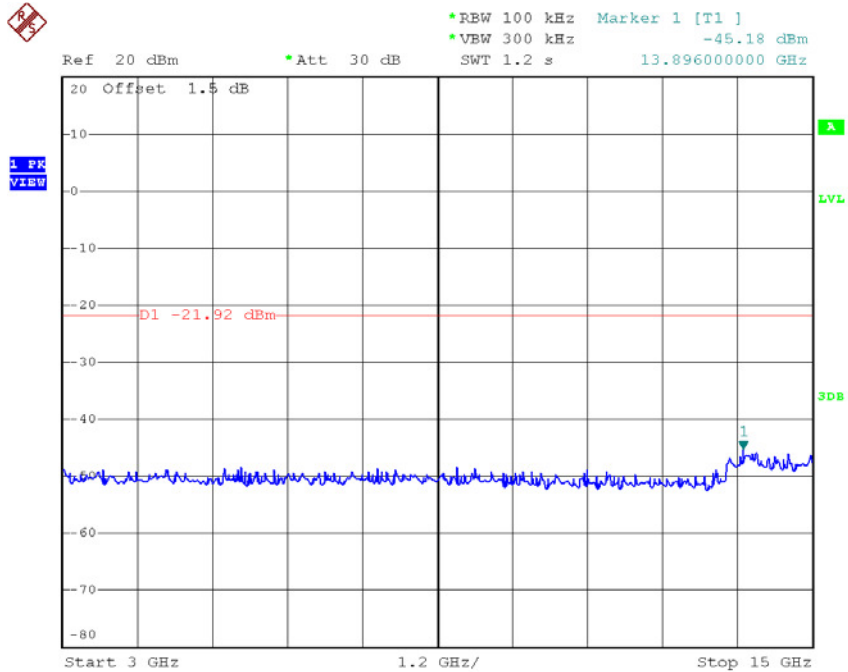

Date: 27.MAR.2017 18:32:27



*REW 100 kHz Marker 1 [T1]
*VBW 300 kHz -42.17 dBm
SWT 1.15 s 26.431000000 GHz

Ref 20 dBm *Att 30 dB

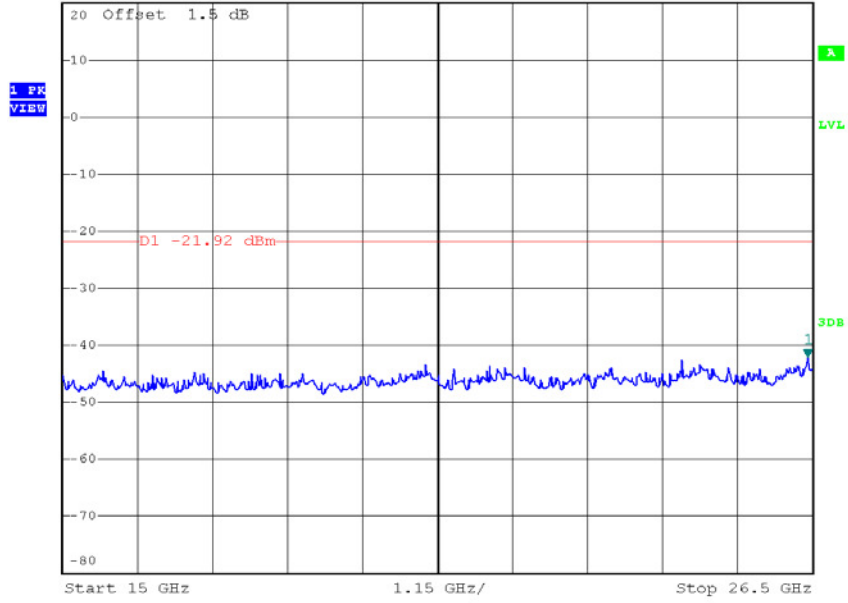

Date: 27.MAR.2017 18:32:35

ATTACHMENT H - POWER SPECTRAL DENSITY

Test Mode :TX B Mode_CH01/06/11

Frequency (MHz)	Power Density (dBm/3kHz)	Power Density (mW/3kHz)	Max. Limit (dBm/3kHz)	Result
2412	-10.87	0.0818	8.00	Complies
2437	-9.86	0.1033	8.00	Complies
2462	-9.16	0.1213	8.00	Complies

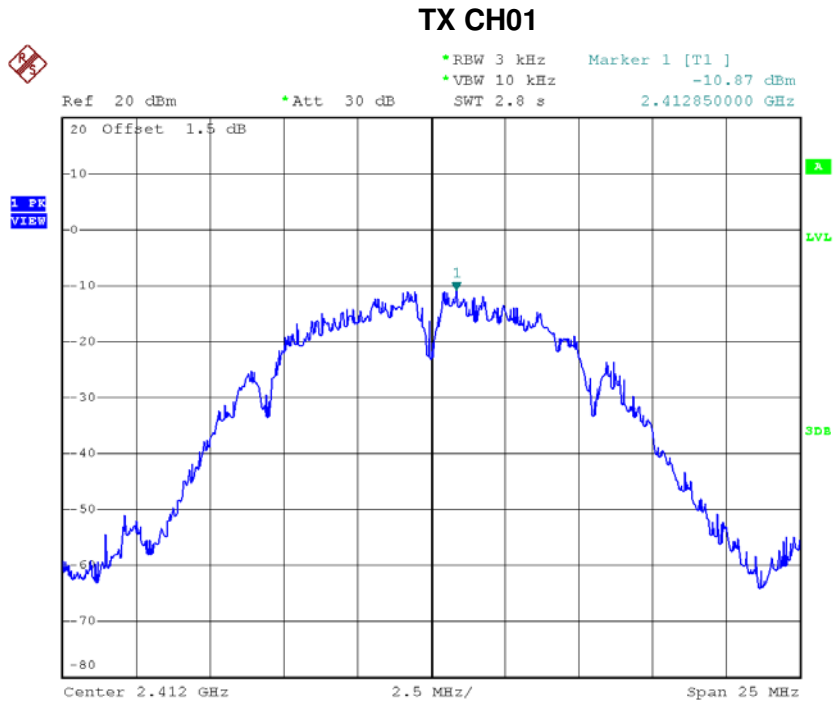

Date: 27.MAR.2017 18:22:26

TX CH06

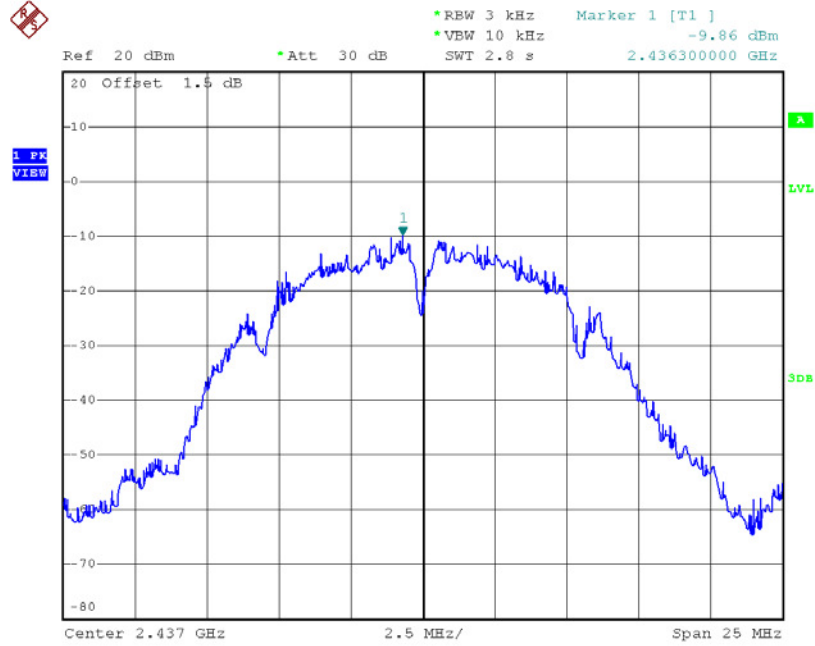

Date: 27.MAR.2017 18:23:47

TX CH11

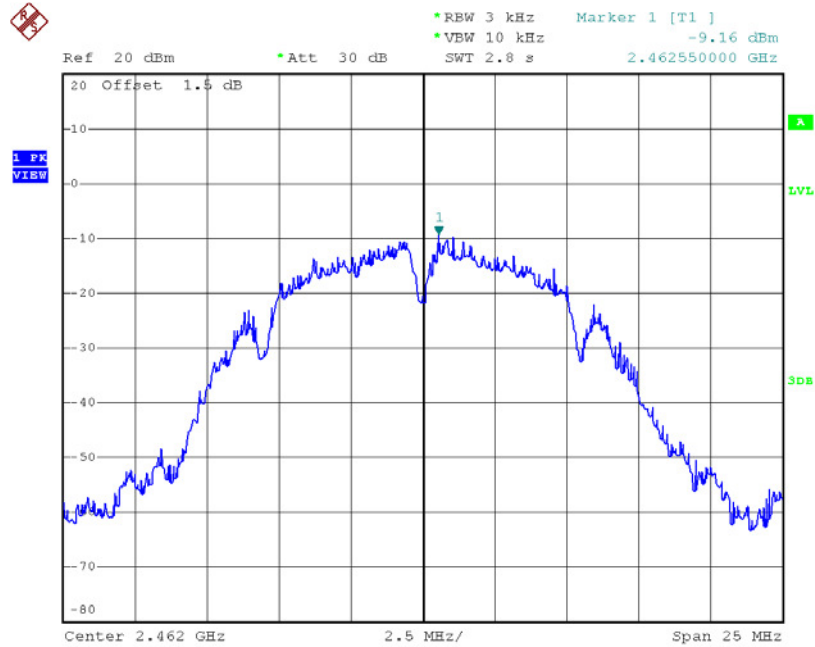

Date: 27.MAR.2017 18:25:17

Test Mode :TX G Mode_CH01/06/11

Frequency (MHz)	Power Density (dBm/3kHz)	Power Density (mW/3kHz)	Max. Limit (dBm/3kHz)	Result
2412	-12.52	0.0560	8.00	Complies
2437	-12.76	0.0530	8.00	Complies
2462	-12.23	0.0598	8.00	Complies

TX CH01

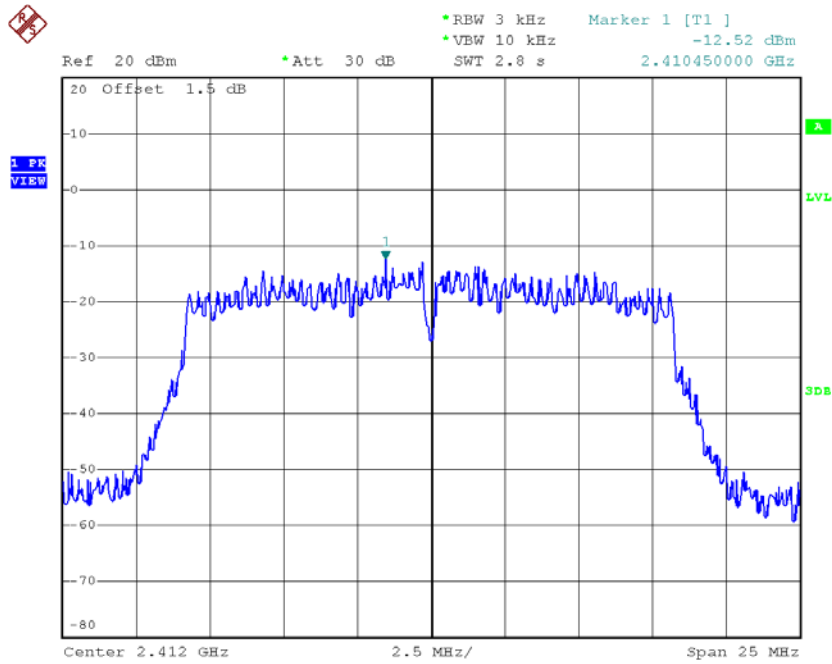

Date: 27.MAR.2017 18:26:39

TX CH06

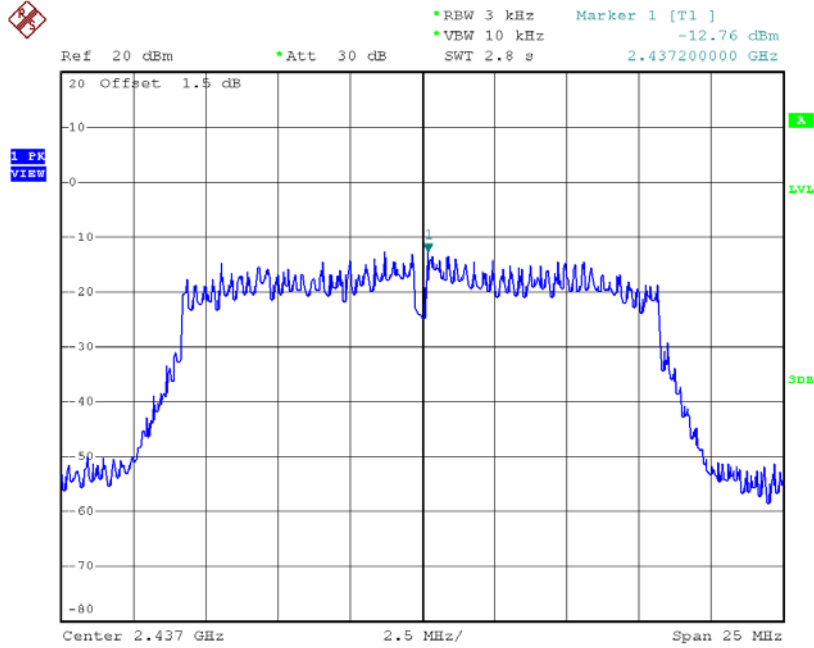

Date: 27.MAR.2017 18:27:50

TX CH11

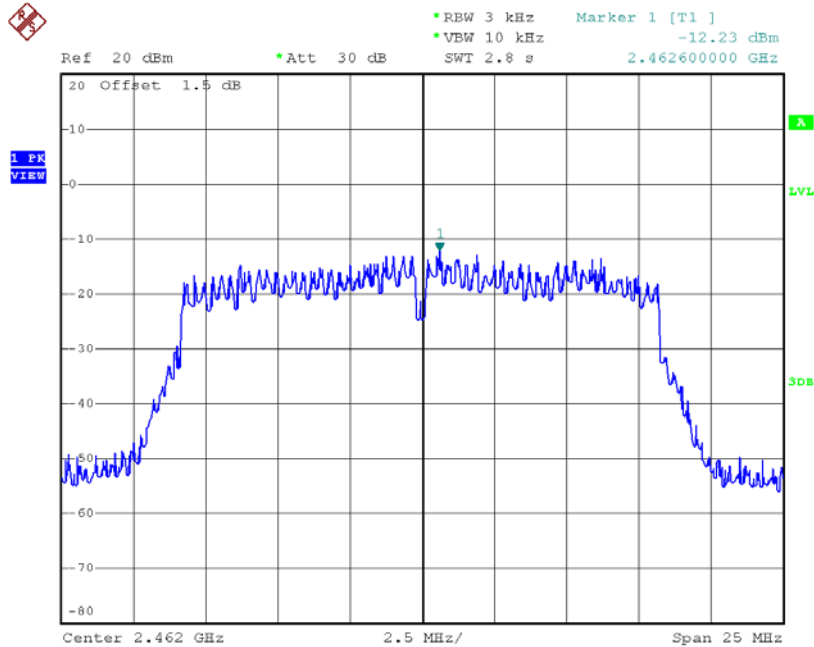

Date: 27.MAR.2017 18:29:07

Test Mode : TX N-20M Mode_CH01/06/11

Frequency (MHz)	Power Density (dBm/3kHz)	Power Density (mW/3kHz)	Max. Limit (dBm/3kHz)	Result
2412	-14.15	0.0385	8.00	Complies
2437	-13.42	0.0455	8.00	Complies
2462	-11.52	0.0705	8.00	Complies

TX CH01

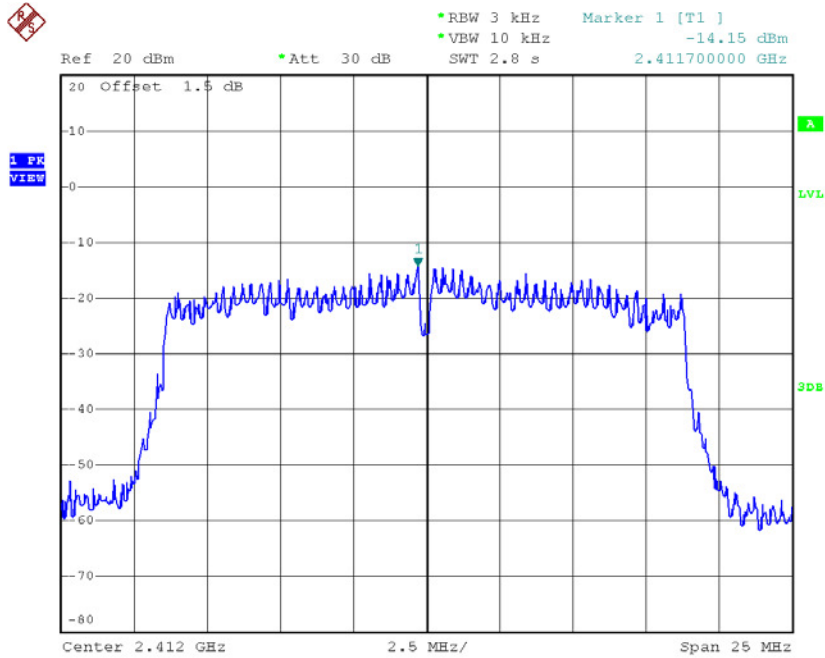

Date: 27.MAR.2017 18:30:27

TX CH06

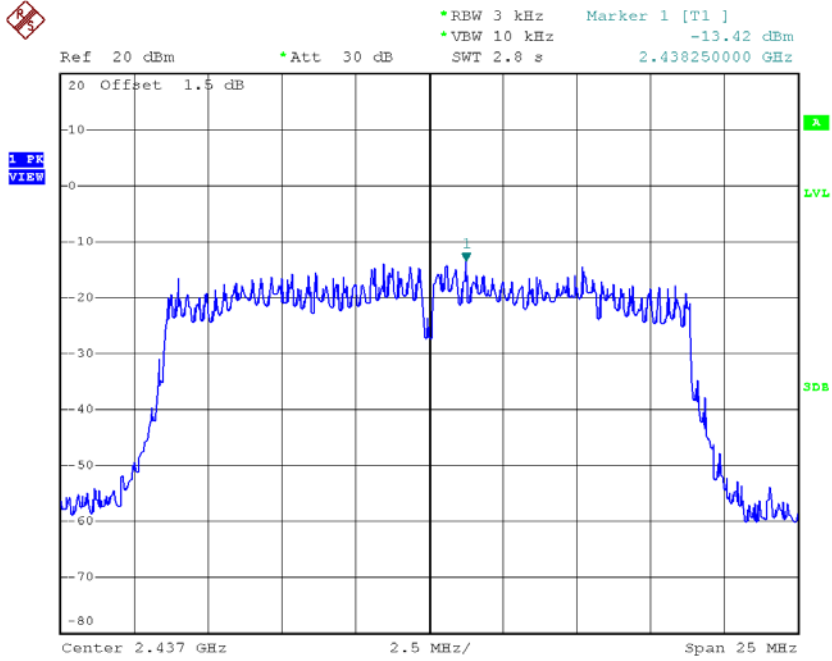

Date: 27.MAR.2017 18:31:32

TX CH11

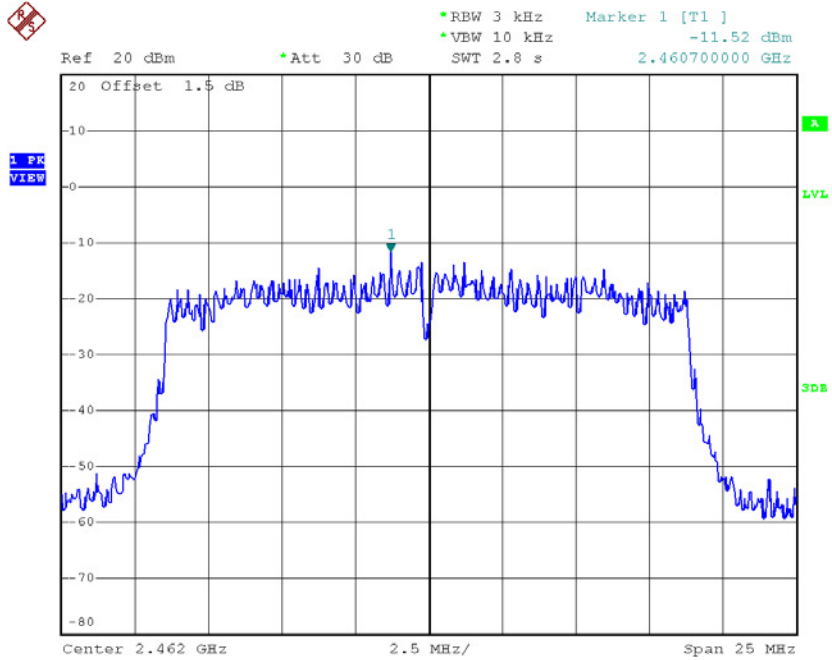

Date: 27.MAR.2017 18:32:52