

ENGINEERING TEST REPORT

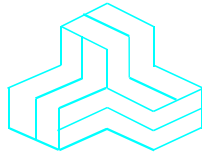

RedMAX
Model No.: SU-O
FCC ID: QC8-SUOA

Applicant: **Redline Communications Inc.**
302 Town Centre Blvd.
Markham, Ontario
Canada, L3R 0E8

Tested in Accordance With

Federal Communications Commission (FCC)
CFR 47, PARTS 2 and 90 (Subpart Z)
Wireless Broadband Services in the 3650-3675 MHz

UltraTech's File No.: RCI-176FCC90Z

This Test report is Issued under the Authority of
Tri M. Luu, Professional Engineer,
Vice President of Engineering
UltraTech Group of Labs



Date: August 27, 2007

Report Prepared by: Dharmajit Solanki, RF Engineer

Tested by: Wayne Wu, RFI Engineer

Issued Date: August 27, 2007

Test Dates: August 2-14, 2007

- *The results in this Test Report apply only to the sample(s) tested, and the sample tested is randomly selected.*
- *This report must not be used by the client to claim product endorsement by NVLAP or any agency of the US Government.*

UltraTech

3000 Bristol Circle, Oakville, Ontario, Canada, L6H 6G4
Tel.: (905) 829-1570 Fax.: (905) 829-8050
Website: www.ultratech-labs.com Email: vic@ultratech-labs.com, Email: tri.luu@sympatico.ca



0685



31040/SIT



C-1376



46390-2049



200093-0



SL2-IN-E-1119R

TABLE OF CONTENTS

EXHIBIT 1. INTRODUCTION	2
1.1. SCOPE.....	2
1.2. RELATED SUBMITAL(S)/GRANT(S).....	3
1.3. NORMATIVE REFERENCES	3
EXHIBIT 2. PERFORMANCE ASSESSMENT	4
2.1. CLIENT INFORMATION.....	4
2.2. EQUIPMENT UNDER TEST (EUT) INFORMATION.....	4
2.3. PRODUCT DESCRIPTION.....	5
2.4. EUT'S TECHNICAL SPECIFICATIONS.....	6
2.5. LIST OF EUT'S PORTS.....	6
EXHIBIT 3. EUT OPERATING CONDITIONS AND CONFIGURATIONS DURING TESTS	7
3.1. CLIMATE TEST CONDITIONS.....	7
3.2. OPERATIONAL TEST CONDITIONS & ARRANGEMENT FOR TEST SIGNALS.....	7
3.3. TEST SETUP BLOCK DIAGRAM.....	8
EXHIBIT 4. SUMMARY OF TEST RESULTS	9
4.1. LOCATION OF TESTS	9
4.2. APPLICABILITY & SUMMARY OF EMC EMISSION TEST RESULTS.....	9
4.3. MODIFICATIONS INCORPORATED IN THE EUT FOR COMPLIANCE PURPOSES.....	9
4.4. DEVIATION OF STANDARD TEST PROCEDURES	9
EXHIBIT 5. MEASUREMENTS, EXAMINATIONS & TEST DATA FOR EMC EMISSIONS.....	10
5.1. TEST PROCEDURES.....	10
5.2. MEASUREMENT UNCERTAINTIES	10
5.3. MEASUREMENT EQUIPMENT USED:	10
5.4. ESSENTIAL/PRIMARY FUNCTIONS AS DECLARED BY THE MANUFACTURER:.....	10
5.5. POWER AND ANTENNA LIMITS @ FCC 90.1321.....	11
5.6. RF EXPOSURE REQUIRMENTS @ SEC. 90.1217, 1.1310 & 2.1091	27
5.7. 99% OCCUPIED BANDWIDTH @ FCC 2.1049	30
5.8. FREQUENCY STABILITY @ FCC 2.1055	38
5.9. CONDUCTED EMISSION LIMITS @ FCC 90.1323	40
5.10. TRANSMITTER SPURIOUS/HARMONIC RADIATED EMISSIONS @ FCC 90.1323	53
EXHIBIT 6. MEASUREMENT UNCERTAINTY.....	55
6.1. RADIATED EMISSION MEASUREMENT UNCERTAINTY	55
EXHIBIT 7. MEASUREMENT METHODS	56
7.1. MEASURING THE EIRP OF SPURIOUS/HARMONIC EMISSIONS USING SUBSTITUTION METHOD:	56
7.2. FREQUENCY STABILITY.....	58

EXHIBIT 1. INTRODUCTION

1.1. SCOPE

Reference:	FCC Parts 2 and 90 Subpart Z
Title:	Telecommunication - Code of Federal Regulations, CFR 47, Parts 2 & 90 Subpart Z
Purpose of Test:	To gain FCC Certification Authorization for Radio operating in the frequency bands 3650-3675 MHz
Test Procedures:	Both conducted and radiated emissions measurements were conducted in accordance with American National Standards Institute ANSI C63.4 - American National Standard for Methods of Measurement of Radio-Noise Emissions from Low-Voltage Electrical and Electronic Equipment in the Range of 9 KHz to 40 GHz.

§ 90.1305 Permissible operations:- Use of the 3650–3700 MHz band must be consistent with the allocations for this band as set forth in Part 2 of the Commission’s Rules. All stations operating in this band must employ a contention- based protocol (as defined in § 90.7).

§ 90.1307 Licensing:- The 3650–3700 MHz band is licensed on the basis of non-exclusive nationwide licenses. Non-exclusive nationwide licenses will serve as a prerequisite for registering individual fixed and base stations. A licensee cannot operate a fixed or base station before registering it under its license and licensees must delete registrations for unused fixed and base stations.

§ 90.1309 Regulatory status:- Licensees are permitted to provide services on a non-common carrier and/or on a common carrier basis. A licensee may render any kind of communications service consistent with the regulatory status in its license and with the Commission’s rules applicable to that service.

§ 90.1311 License term:- The license term is ten years, beginning on the date of the initial authorization (non-exclusive nationwide license) grant. Registering fixed and base stations will not change the overall renewal period of the license.

§ 90.1312 Assignment and transfer:- Licensees may assign or transfer their non-exclusive nationwide licenses, and any fixed or base stations registered under those licenses will remain associated with those licenses.

§ 90.1319 Policies governing the use of the 3650–3700 MHz band:-

- (a) Channels in this band are available on a shared basis only and will not be assigned for the exclusive use of any licensee
- (b) Any base, fixed, or mobile station operating in the band must employ a contention-based protocol.
- (c) All applicants and licensees shall cooperate in the selection and use of frequencies in the 3650–3700 MHz band in order to minimize the potential for interference and make the most effective use of the authorized facilities. A database identifying the locations of registered stations will be available at <http://wireless.fcc.gov/uls>. Licensees should examine this database before seeking station authorization, and make every effort to ensure that their fixed and base stations operate at a location, and with technical parameters, that will minimize the potential to cause and receive interference. Licensees of stations suffering or causing harmful interference are expected to cooperate and resolve this problem by mutually satisfactory arrangements.

1.2. RELATED SUBMITAL(S)/GRANT(S)

None

1.3. NORMATIVE REFERENCES

Publication	Year	Title
FCC CFR Parts 2 and 90	2006	Code of Federal Regulations – Telecommunication
ANSI C63.4	2004	American National Standard for Methods of Measurement of Radio-Noise Emissions from Low-Voltage Electrical and Electronic Equipment in the Range of 9 KHz to 40 GHz
CISPR 16-1-1	2004	Specification for Radio Disturbance and Immunity measuring apparatus and methods
TIA/EIA 603, Edition C	2004	Land Mobile FM or PM Communications Equipment Measurement and Performance Standards

ULTRATECH GROUP OF LABS

3000 Bristol Circle, Oakville, Ontario, Canada L6H 6G4
Tel. #: 905-829-1570, Fax. #: 905-829-8050, Email: vic@ultratech-labs.com, Website: <http://www.ultratech-labs.com>

File #: RCI-176FCC90Z
August 27, 2007

- *All test results contained in this engineering test report are traceable to National Institute of Standards and Technology (NIST)*

EXHIBIT 2. PERFORMANCE ASSESSMENT

2.1. CLIENT INFORMATION

APPLICANT	
Name:	Redline Communications Inc.
Address:	302 Town Centre Blvd. Markham, Ontario Canada, L3R 0E8
Contact Person:	Mr. Medhat Fawzy Phone #: 905-479-8344 (ext. 2443) Fax #: 905-479-5331 Email Address: mfawzy@redlinecommunications.com

MANUFACTURER	
Name:	Redline Communications Inc.
Address:	302 Town Centre Blvd. Markham, Ontario Canada, L3R 0E8
Contact Person:	Mr. Sherwyn Welshman Phone #: 905-479-8344 (ext. 2362) Fax #: 905-479-5331 Email Address: swelshman@redlinecommunications.com

2.2. EQUIPMENT UNDER TEST (EUT) INFORMATION

The following information (with the exception of the Date of Receipt) has been supplied by the applicant.

Brand Name:	Redline Communications Inc.
Product Name:	RedMAX
Model Name or Number:	SU-O
Serial Number:	N/A
EUT Application:	RedMAX Outdoor Subscriber Unit (Customer Premises Equipment-CPE) for wireless broadband data transmission. There are two types: SU-OIA (use only an internal antenna) and SU-ORF (use only an external antenna)
Type of Equipment:	Non-broadcast Radio Communication Equipment
Power Supply:	AC 120V 60Hz
Transmitting/Receiving Antenna Type:	Non-integral for model SU-ORF & Integral for model SU-OIA

ULTRATECH GROUP OF LABS

3000 Bristol Circle, Oakville, Ontario, Canada L6H 6G4
 Tel. #: 905-829-1570, Fax. #: 905-829-8050, Email: vic@ultratech-labs.com, Website: <http://www.ultratech-labs.com>

File #: RCI-176FCC90Z
 August 27, 2007

- All test results contained in this engineering test report are traceable to National Institute of Standards and Technology (NIST)

2.3. PRODUCT DESCRIPTION

The SU-O is carrier class high-speed IEEE 802.16-2004 WiMAX compliant for point-to-point (PTP) and point-to-multipoint (PMP) deployment.

The SU-O uses Orthogonal Frequency Division Multiplexing (OFDM). OFDM is a multi-carrier transmission technique where the data stream is split and transmitted (at a reduced rate) in parallel streams on separate sub-carriers.

The SU-O system uses time division duplexing (TDD) to transmit and receive on the same RF channel. The SU-O can also transmit and receive using separate RF channels, referred to as half-duplex FDD (HD-FDD).

All uplink and downlink transmission scheduling is managed by the WiMAX base station. The base station sends data traffic to subscriber stations, polls for grant requests, and sends grant acknowledgements based on the total of all traffic to all subscriber stations.

Each burst of data transmitted over the air is padded with redundant information to make it resistant to errors introduced during transmission. The coding rate is the ratio of user data to the total data transmitted including the redundant error correction data. The SU-O supports coding rates of 1/2, 2/3, and 3/4.

The modulation technique specifies how the data is coded within the OFDM carriers. The SU-O supports BPSK, QPSK, 16 QAM, and 64 QAM modulation.

The SU-O is a frequency-specific system, with the frequency band defined by the internal transceiver unit.

The SU-O divides the available frequency band into channels. Allocation of channels during deployment is dependent on spectrum availability in the licensed FWA band and local licensing requirements and conditions.

Channel selection allows planners to obtain the maximum geographic coverage, while avoiding frequency contention in adjacent sectors.

There are two types of SU-O:

- a) The SU-OIA unit is housed in a weatherproof aluminum alloy case and features an integrated antenna.
- b) The SU-ORF unit is housed in a weatherproof aluminum alloy case and features an RF connector for connection to an external antenna.

The auto-sensing 10/100Base-T Ethernet port connects through the outdoor Ethernet cable to the indoor PoE Adapter. The SU-O receives DC power and exchanges data with the indoor network through this port (straight-through connection). The cable access entrance on the SU-O is equipped with a weatherproof seal.

ULTRATECH GROUP OF LABS

3000 Bristol Circle, Oakville, Ontario, Canada L6H 6G4
Tel. #: 905-829-1570, Fax. #: 905-829-8050, Email: vic@ultratech-labs.com, Website: <http://www.ultratech-labs.com>

File #: RCI-176FCC90Z
August 27, 2007

- *All test results contained in this engineering test report are traceable to National Institute of Standards and Technology (NIST)*

2.4. EUT'S TECHNICAL SPECIFICATIONS

TRANSMITTER	
Equipment Type:	Base station (fixed use)
Intended Operating Environment:	<input checked="" type="checkbox"/> Commercial <input checked="" type="checkbox"/> Light Industry & Heavy Industry
Power Supply Requirement:	AC 120V 60Hz
RF Output Power Rating:	35.4 dBm total peak EIRP (3.5 MHz BW) 38.5 dBm total peak EIRP (7.0 MHz BW)
Operating Frequency Range:	3650-3675 MHz
RF Output Impedance:	50 Ohms
Channel Spacing:	3.5 and 7 MHz
Occupied Bandwidth (99%):	3.14 MHz (3.5 MHz Ch) 6.29 MHz (7 MHz Ch)
Modulation:	Auto-select BPSK, QPSK, 16QAM, 64 QAM
Emission Designation*:	3M14DXW (for 3.5 MHz BW) 6M29DXW (for 7.0 MHz BW)
Antenna Connector Type:	N type
Antenna Description:	Refer to attached Antenna list.
Operating Temperature:	-40 °C to +65 °C

2.5. LIST OF EUT'S PORTS

Port Number	EUT's Port Description	Number of Identical Ports	Connector Type	Cable Type (Shielded/Non-shielded)
1	ANT –RF	1	N	Shielded
2	Data & Power Port (AC)	1	RJ 45	Non-Shielded

EXHIBIT 3. EUT OPERATING CONDITIONS AND CONFIGURATIONS DURING TESTS

3.1. CLIMATE TEST CONDITIONS

The climate conditions of the test environment are as follows:

Temperature:	23°C
Humidity:	55%
Pressure:	102 kPa
Power input source:	AC 120V 60Hz

3.2. OPERATIONAL TEST CONDITIONS & ARRANGEMENT FOR TEST SIGNALS

Operating Modes:	The transmitter was operated in a continuous transmission mode with the carrier modulated as specified in the Test Data.
Special Test Software:	A Redline Set-up Software used to setup frequency, power level and channel spacing.
Transmitter Test Antenna:	The EUT is tested with the transmitter antenna port terminated to a 50 Ohms RF Load.

Transmitter Test Signals	
Frequency Band(s): <ul style="list-style-type: none">3650 - 3675 MHz band (for both 3.5 & 7 MHz Channel Spacing)	Near lowest, near middle & near highest frequencies in each frequency bands that the transmitter covers: <ul style="list-style-type: none">3650, 3662.5 & 3675 MHz
Transmitter Wanted Output Test Signals: <ul style="list-style-type: none">RF Power Output (measured maximum output power):Normal Test ModulationModulating signal source:	<ul style="list-style-type: none">29.7 dBm(3.5MHz Channel)29.1 dBm(7.0MHz Channel)Auto-select BPSK, QPSK, 16QAM, 64 QAMInternal

3.3. TEST SETUP BLOCK DIAGRAM

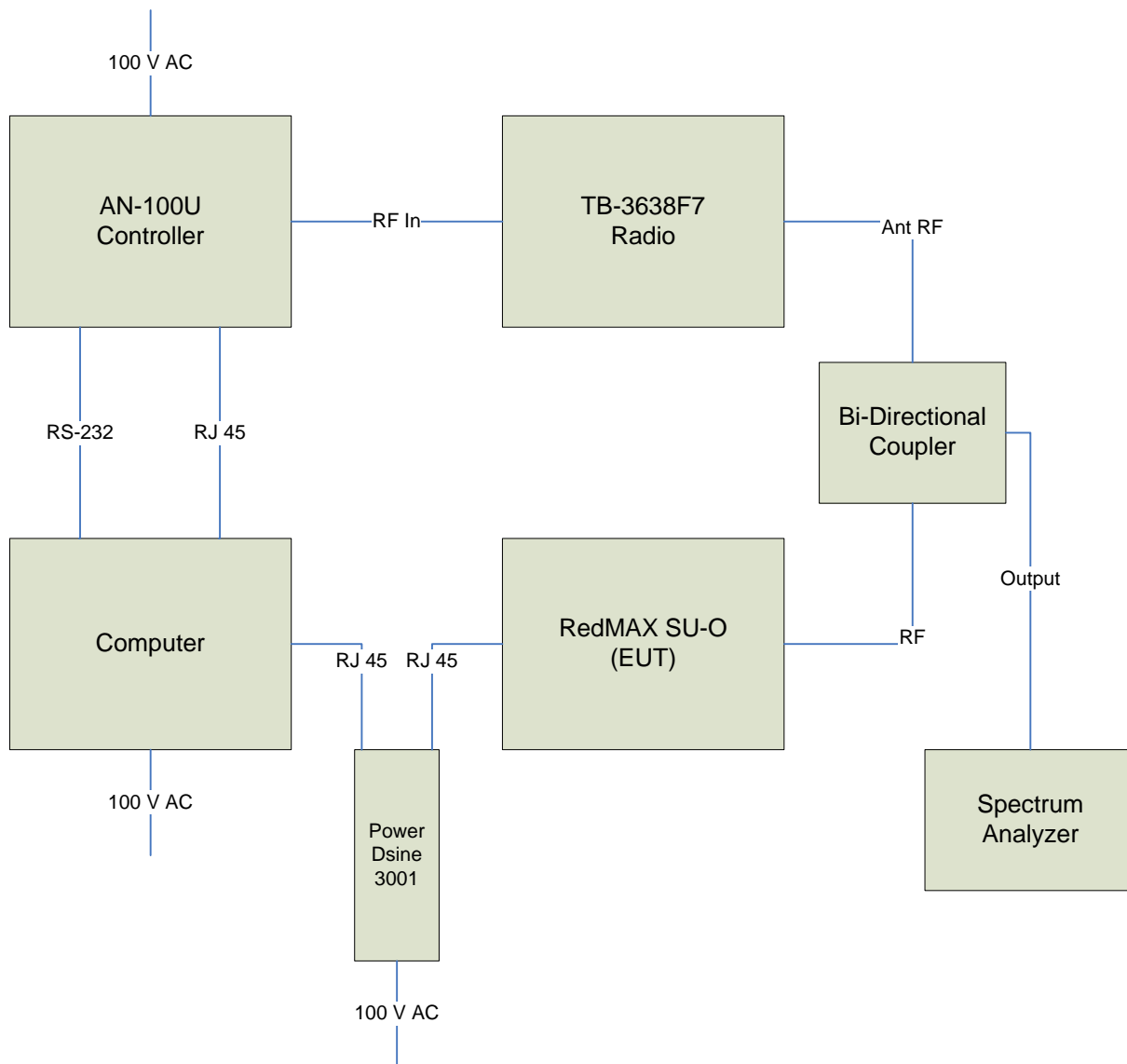

EXHIBIT 4. SUMMARY OF TEST RESULTS

4.1. LOCATION OF TESTS

All of the measurements described in this report were performed at Ultratech Group of Labs located in the city of Oakville, Province of Ontario, Canada.

- Radiated Emissions were performed at the Ultratech's 3-10 TDK Semi-Anechoic Chamber situated in the Town of Oakville, province of Ontario. This test site been calibrated in accordance with ANSI C63.4, and found to be in compliance with the requirements of Sec. 2.948 of the FCC Rules. The descriptions and site measurement data of the Oakville 3-10 TDK Semi-Anechoic Chamber has been filed with FCC office (FCC File No.: 31040/SIT 1300B3) and Industry Canada office (Industry Canada File No.: IC2049-1). Last Date of Site Calibration: May 17, 2007.

4.2. APPLICABILITY & SUMMARY OF EMC EMISSION TEST RESULTS

FCC PARAGRAPH	TEST REQUIREMENTS	APPLICABILITY (YES/NO)
90.1321	Power and Antenna Limits	Yes
1.1307, 1.1310, 2.1091 & 2.1093	RF Exposure Limit	Yes
2.1049	99% Occupied Bandwidth	Yes
2.1055	Frequency Stability	Yes
90.1323	Conducted Emission Limits and Band-edge emissions	Yes
90.1323	Emission Limits - Field Strength of Spurious Emissions	Yes
RedMAX, Model No.: SU-O, by Redline Communications Inc. has also been tested and found to comply with FCC Part 15, Subpart B - Radio Receivers and Class A Digital Devices. The engineering test report has been documented and kept in file and it is available anytime upon FCC request.		

4.3. MODIFICATIONS INCORPORATED IN THE EUT FOR COMPLIANCE PURPOSES

None

4.4. DEVIATION OF STANDARD TEST PROCEDURES

None

ULTRATECH GROUP OF LABS

3000 Bristol Circle, Oakville, Ontario, Canada L6H 6G4
Tel. #: 905-829-1570, Fax. #: 905-829-8050, Email: vic@ultratech-labs.com, Website: <http://www.ultratech-labs.com>

File #: RCI-176FCC90Z
August 27, 2007

- *All test results contained in this engineering test report are traceable to National Institute of Standards and Technology (NIST)*

EXHIBIT 5. MEASUREMENTS, EXAMINATIONS & TEST DATA FOR EMC EMISSIONS

5.1. TEST PROCEDURES

This section contains test results only. Details of test methods and procedures can be found in Exhibit 8 of this report

5.2. MEASUREMENT UNCERTAINTIES

The measurement uncertainties stated were calculated in accordance with requirements of UKAS Document NIS 81 with a confidence level of 95%. Please refer to Exhibit 7 for Measurement Uncertainties.

5.3. MEASUREMENT EQUIPMENT USED:

The measurement equipment used complied with the requirements of the Standards referenced in the Methods & Procedures ANSI C63.4 and CISPR 16-1-1

5.4. ESSENTIAL/PRIMARY FUNCTIONS AS DECLARED BY THE MANUFACTURER:

The essential function of the EUT is to correctly communicate data to and from radios over RF link.

5.5. POWER AND ANTENNA LIMITS @ FCC 90.1321

5.5.1. Limits

§ 90.1321 Power and antenna limits:

- (a) Base and fixed stations are limited to 25 watts/25 MHz equivalent isotropically radiated power (EIRP). In any event, the peak EIRP power density shall not exceed 1 Watt in any one megahertz slice of spectrum.
- (b) In addition to the provisions in paragraph (a) of this section, transmitters operating in the 3650–3700 MHz band that emit multiple directional beams, simultaneously or sequentially, for the purpose of directing signals to individual receivers or to groups of receivers provided the emissions comply with the following:
 - (1) Different information must be transmitted to each receiver.
 - (2) If the transmitter employs an antenna system that emits multiple directional beams but does not emit multiple directional beams simultaneously, the total output power conducted to the array or arrays that comprise the device, *i.e.*, the sum of the power supplied to all antennas, antenna elements, staves, etc. and summed across all carriers or frequency channels, shall not exceed the limit specified in paragraph (a) of this section, as applicable. The directional antenna gain shall be computed as follows:
 - (i) The directional gain, in dBi, shall be calculated as the sum of 10 log (number of array elements or staves) plus the directional gain, in dBi, of the individual element or stave having the highest gain.
 - (ii) A lower value for the directional gain than that calculated in paragraph (b)(2)(i) of this section will be accepted if sufficient evidence is presented, *e.g.*, due to shading of the array or coherence loss in the beam-forming.
 - (3) If a transmitter employs an antenna that operates simultaneously on multiple directional beams using the same or different frequency channels and if transmitted beams overlap, the power shall be reduced to ensure that the aggregate power from the overlapping beams does not exceed the limit specified in paragraph (b)(2) of this section. In addition, the aggregate power transmitted simultaneously on all beams shall not exceed the limit specified in paragraph (b)(2) of this section by more than 8 dB.
- (4) Transmitters that emit a single directional beam shall operate under the provisions of paragraph (b)(2) of this section.
- (c) Mobile and portable stations are limited to 1 watt/25 MHz EIRP. In any event, the peak EIRP density shall not exceed 40 milliwatts in any one-megahertz slice of spectrum.

5.5.2. Method of Measurements

The peak power in 1 MHz was measured using an EMI receiver (spectrum analyzer) with RBW = 1 MHz, VBW >= RBW.

5.5.3. Test Equipment List

Test Instruments	Manufacturer	Model No.	Serial No.	Frequency Range
Spectrum Analyzer/ EMI Receiver	Rohde & Schwarz	FSEK20/B4/B21	834157/005	9 kHz – 40 GHz with external mixer
RF Signal Generator	Hewlett Packard	HP 83752B	3610A00457	0.01 – 20 GHz
67297 RF Detector (Diode Detector)	Herotex	DZ122-553	63400	..
Storage Oscilloscope	Philips	PM3320A	ST9907959	--

5.5.4. Test Arrangement

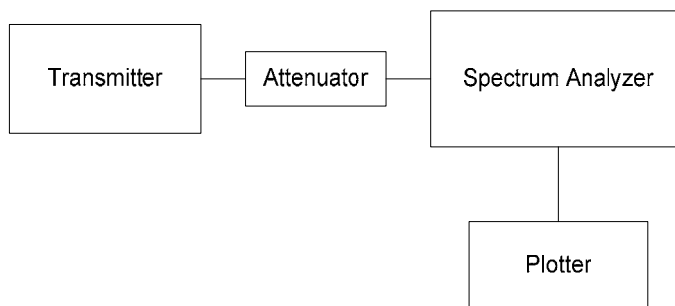

5.5.5. Test Data

Note: The following tables show the power levels with respect to antenna system assembly to achieve the maximum EIRP or EIRP density. For actual settings of power levels with respect to actual antennas used, please refer to the User's Manual.

Total EIRP Power

Fundamental Frequency (MHz)	Measured Peak Conducted Power in dBm (Low Power Setting)	Measured Peak Conducted Power in dBm (High Power Setting)	Antenna System Assembly Gain Range (Ant Gain- Cable loss) (Maximum Gain)	Antenna System Assembly Gain Range (Ant Gain- Cable loss) (Minimum Gain)	Calculated Maximum Total Peak EIRP (dBm/MHz)	FCC Peak Total EIRP Limits (dBm/MHz)
Channel Spacing 3.5 MHz						
3650.0	0.3	29.7	35.1	5.7	35.4	35.4
3662.5	-0.2	29.6	35.6	5.8	35.4	35.4
3675.0	-0.7	29.3	36.1	6.1	35.4	35.4
Channel Spacing 7.0 MHz						
3650.0	-1.2	29.1	39.6	9.3	38.4	38.4
3662.5	-1.9	28.7	40.3	9.7	38.4	38.4
3675.0	-2.3	28.3	40.7	10.1	38.4	38.4

(Total Peak EIRP Power allowed is 3.5W/3.5MHz for 3.5 MHz Channel Spacing & 7W/7MHz for 7.0 MHz Channel Spacing)

EIRP Power Density in 1 MHz BW

Fundamental Frequency (MHz)	Measured Peak EIRP Density in 1 MHz BW (dBm/MHz) (Low Power Setting)	Measured Peak EIRP Density in 1 MHz BW (dBm/MHz) (High Power Setting)	Antenna System Assembly Gain Range (Ant Gain- Cable loss) (Maximum Gain)	Antenna System Assembly Gain Range (Ant Gain- Cable loss) (Minimum Gain)	Calculated Maximum Peak EIRP Density in 1 MHz BW (dBm/MHz)	FCC Peak EIRP Density in 1 MHz BW Limits (dBm/MHz)
Channel Spacing 3.5 MHz						
3650.0	-3.7	25.9	33.7	4.1	30.0	30.0
3662.5	-4.4	25.4	34.4	4.6	30.0	30.0
3675.0	-5.0	25.3	35.0	4.7	30.0	30.0
Channel Spacing 7.0 MHz						
3650.0	-6.6	23.6	36.6	6.4	30.0	30.0
3662.5	-7.4	23.4	37.4	6.6	30.0	30.0
3675.0	-7.4	22.7	37.4	7.3	30.0	30.0

Plot # 1: Peak Conducted Power Density Measurement (Low Power Setting)
Frequency: 3650 MHz, Ch Spacing: 3.5 MHz

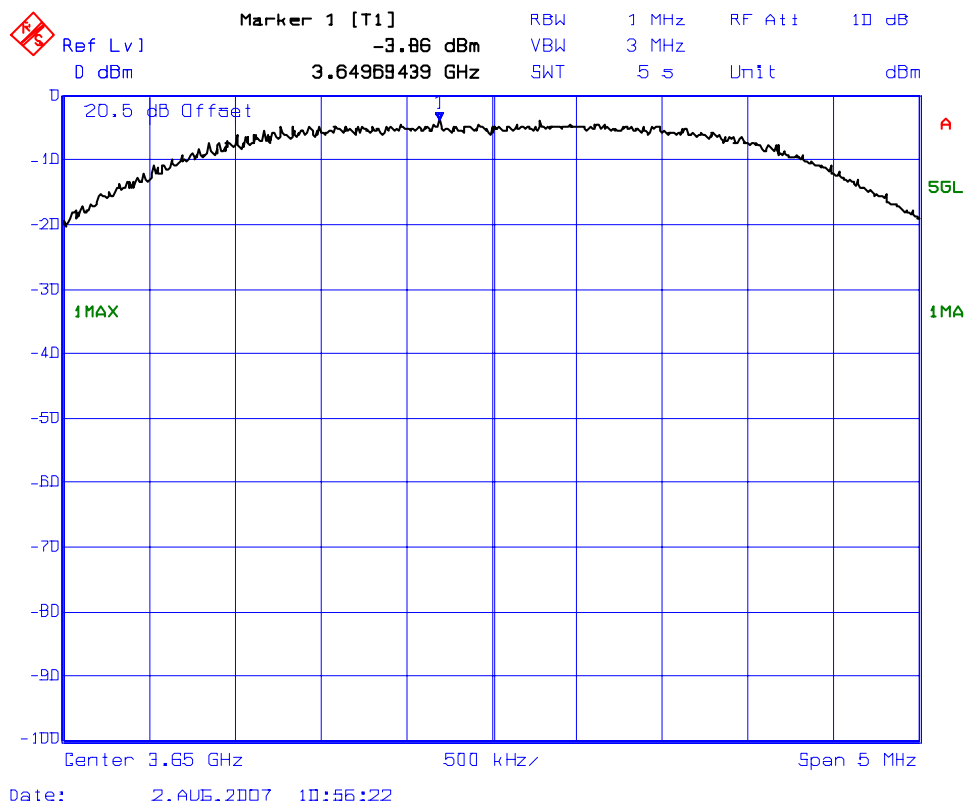

ULTRATECH GROUP OF LABS

3000 Bristol Circle, Oakville, Ontario, Canada L6H 6G4
Tel. #: 905-829-1570, Fax. #: 905-829-8050, Email: vic@ultratech-labs.com, Website: <http://www.ultratech-labs.com>

File #: RCI-176FCC90Z
August 27, 2007

- All test results contained in this engineering test report are traceable to National Institute of Standards and Technology (NIST)

Plot # 2: Peak Conducted Power Density Measurement (Low Power Setting)
Frequency: 3662.5 MHz, Ch Spacing: 3.5 MHz

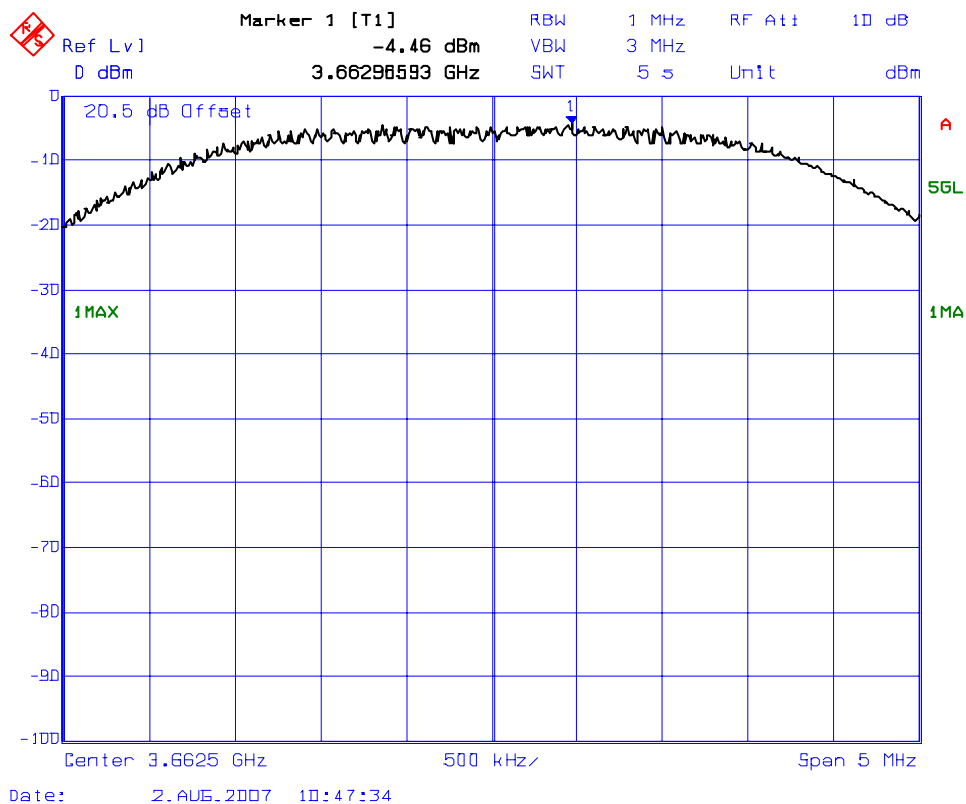

ULTRATECH GROUP OF LABS

3000 Bristol Circle, Oakville, Ontario, Canada L6H 6G4
Tel. #: 905-829-1570, Fax. #: 905-829-8050, Email: vic@ultratech-labs.com, Website: <http://www.ultratech-labs.com>

File #: RCI-176FCC90Z
August 27, 2007

- All test results contained in this engineering test report are traceable to National Institute of Standards and Technology (NIST)

Plot # 3: Peak Conducted Power Density Measurement (Low Power Setting)
Frequency: 3675 MHz, Ch Spacing: 3.5 MHz

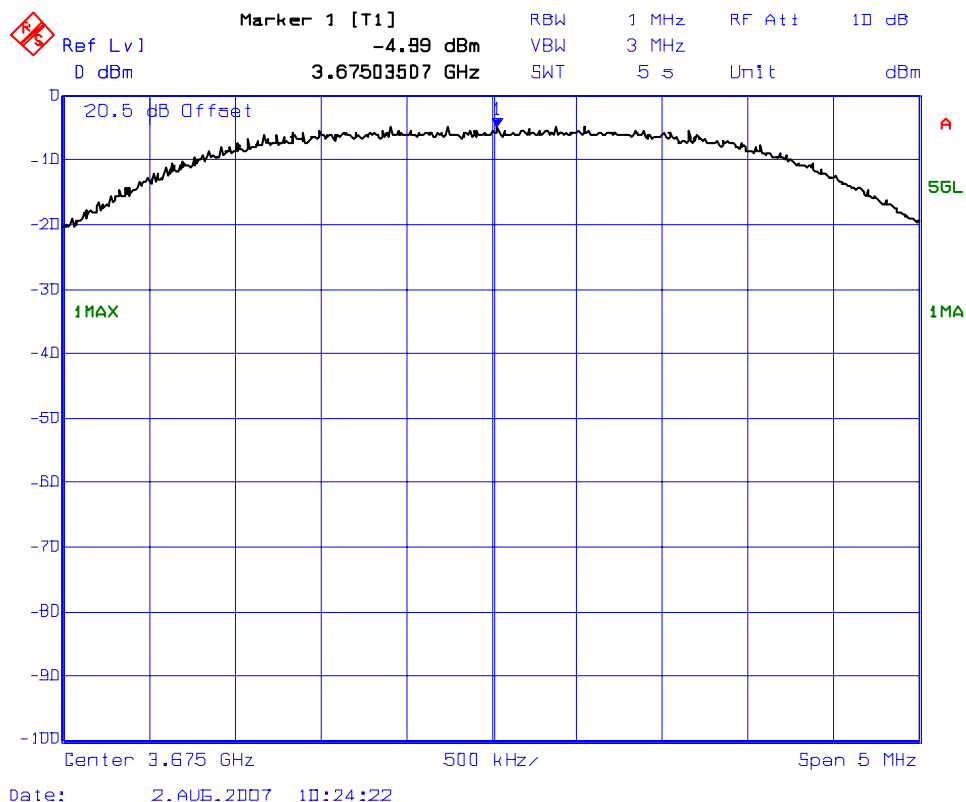

ULTRATECH GROUP OF LABS

3000 Bristol Circle, Oakville, Ontario, Canada L6H 6G4
Tel. #: 905-829-1570, Fax. #: 905-829-8050, Email: vic@ultratech-labs.com, Website: <http://www.ultratech-labs.com>

File #: RCI-176FCC90Z
August 27, 2007

- All test results contained in this engineering test report are traceable to National Institute of Standards and Technology (NIST)

Plot # 4: Peak Conducted Power Density Measurement (Low Power Setting)
Frequency: 3650 MHz, Ch Spacing: 7 MHz

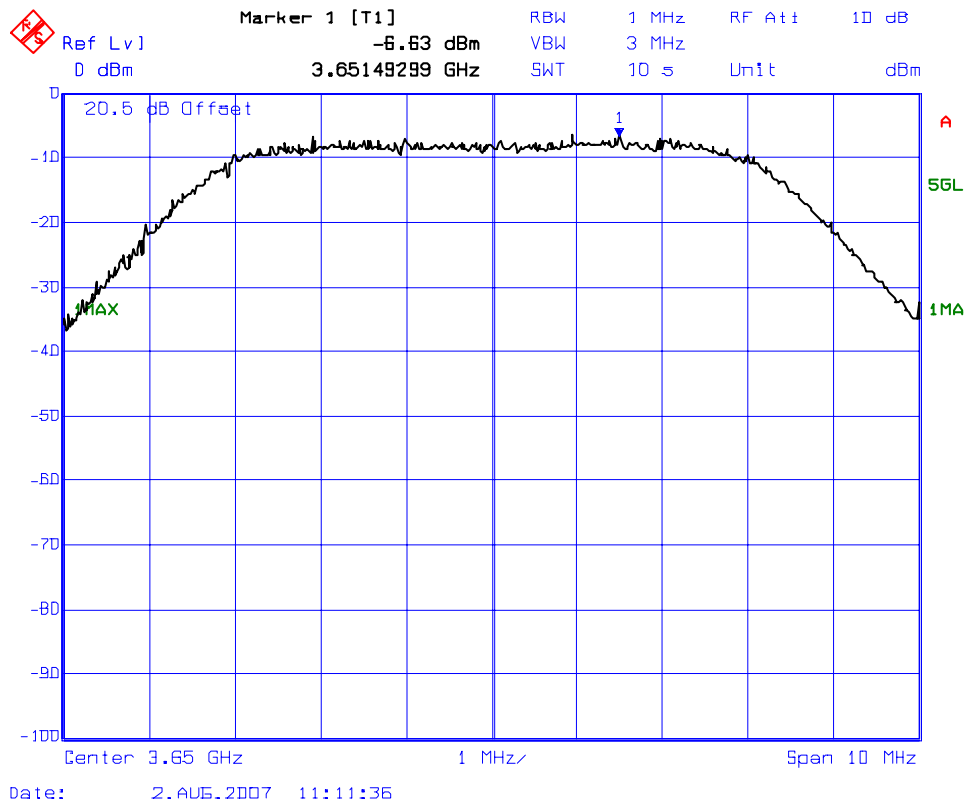

ULTRATECH GROUP OF LABS

3000 Bristol Circle, Oakville, Ontario, Canada L6H 6G4
Tel. #: 905-829-1570, Fax. #: 905-829-8050, Email: vic@ultratech-labs.com, Website: <http://www.ultratech-labs.com>

File #: RCI-176FCC90Z
August 27, 2007

- All test results contained in this engineering test report are traceable to National Institute of Standards and Technology (NIST)

Plot # 5: Peak Conducted Power Density Measurement (Low Power Setting)
Frequency: 3662.5 MHz, Ch Spacing: 7 MHz

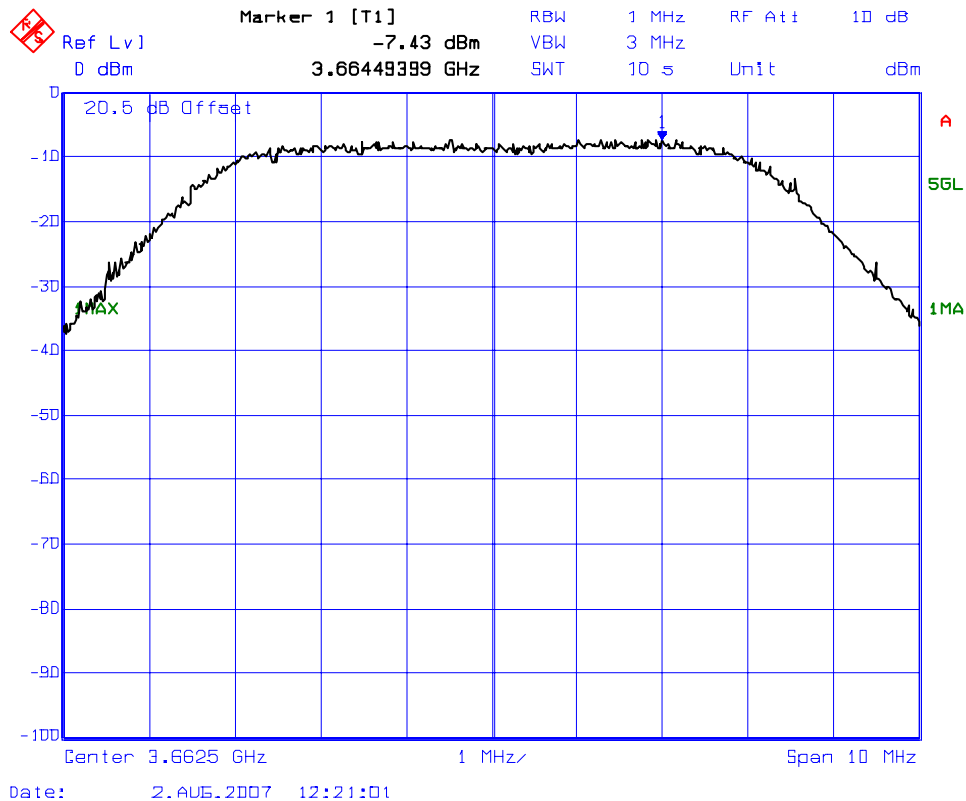

ULTRATECH GROUP OF LABS

3000 Bristol Circle, Oakville, Ontario, Canada L6H 6G4
Tel. #: 905-829-1570, Fax. #: 905-829-8050, Email: vic@ultratech-labs.com, Website: <http://www.ultratech-labs.com>

File #: RCI-176FCC90Z
August 27, 2007

- All test results contained in this engineering test report are traceable to National Institute of Standards and Technology (NIST)

Plot # 6: Peak Conducted Power Density Measurement (Low Power Setting)
Frequency: 3675 MHz, Ch Spacing: 7 MHz

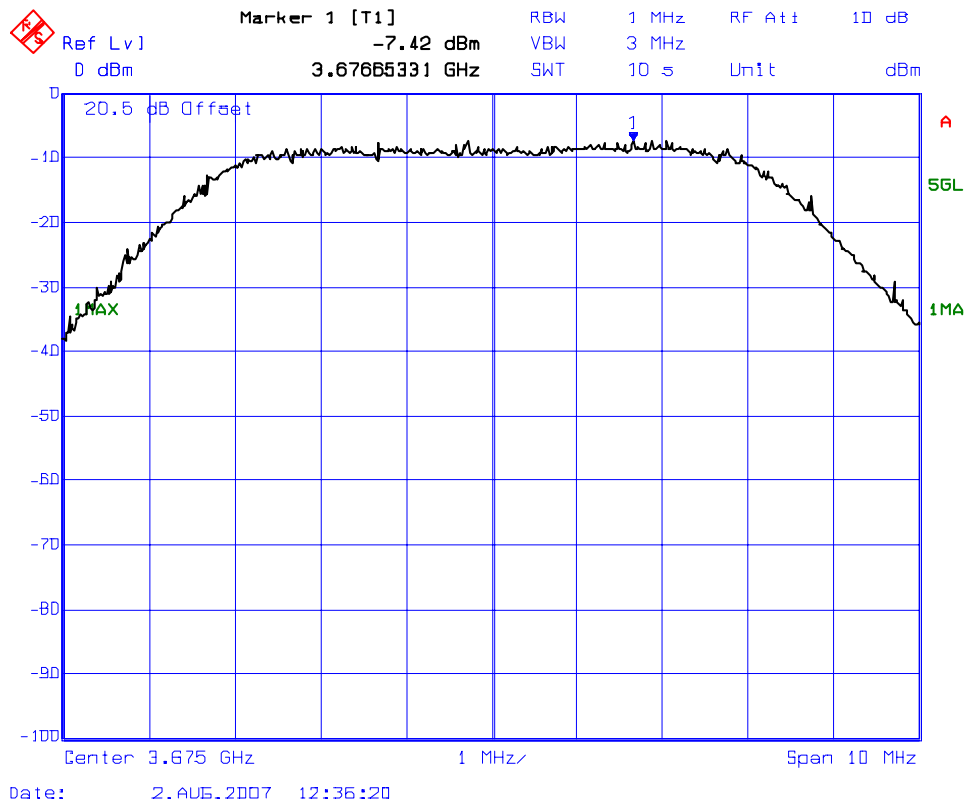

ULTRATECH GROUP OF LABS

3000 Bristol Circle, Oakville, Ontario, Canada L6H 6G4
Tel. #: 905-829-1570, Fax. #: 905-829-8050, Email: vic@ultratech-labs.com, Website: <http://www.ultratech-labs.com>

File #: RCI-176FCC90Z
August 27, 2007

- All test results contained in this engineering test report are traceable to National Institute of Standards and Technology (NIST)

Plot # 7: Peak Conducted Power Density Measurement (High Power Setting)
Frequency: 3650 MHz, Ch Spacing: 3.5 MHz

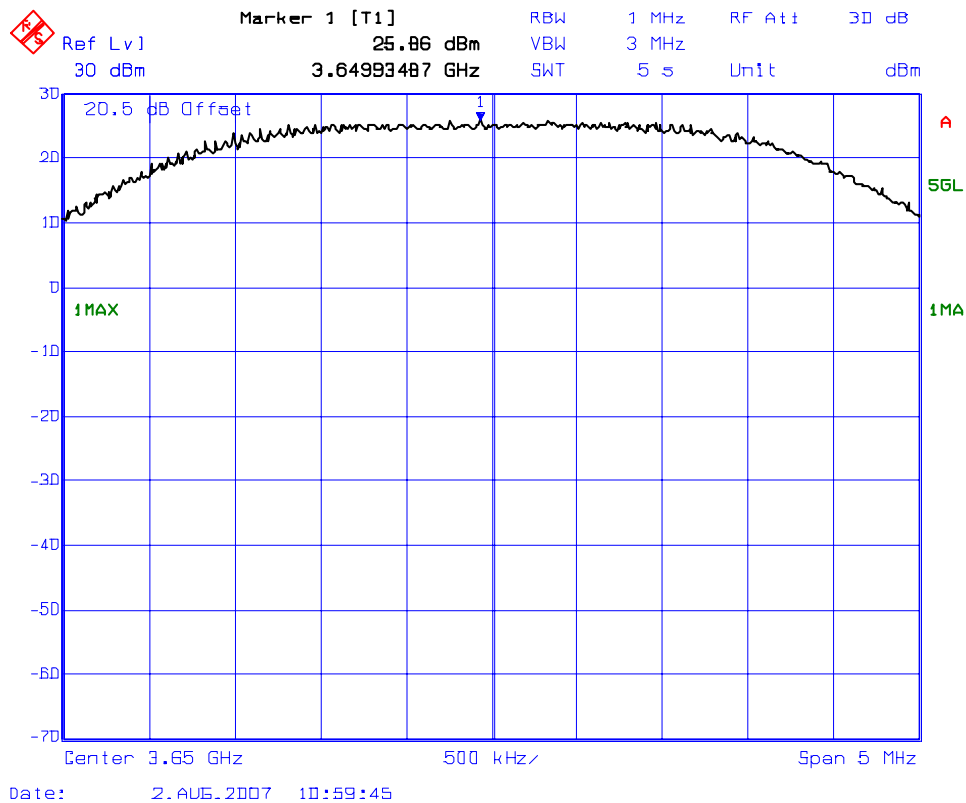

ULTRATECH GROUP OF LABS

3000 Bristol Circle, Oakville, Ontario, Canada L6H 6G4
Tel. #: 905-829-1570, Fax. #: 905-829-8050, Email: vic@ultratech-labs.com, Website: <http://www.ultratech-labs.com>

File #: RCI-176FCC90Z
August 27, 2007

- All test results contained in this engineering test report are traceable to National Institute of Standards and Technology (NIST)

Plot # 8: Peak Conducted Power Density Measurement (High Power Setting)
Frequency: 3662.5 MHz, Ch Spacing: 3.5 MHz

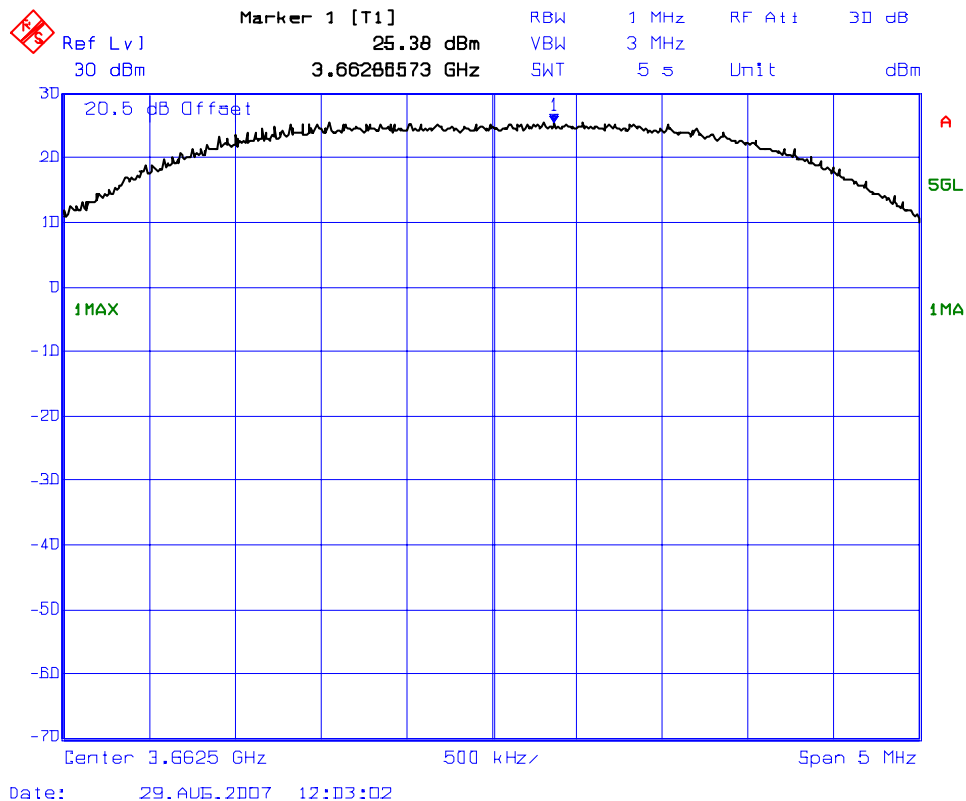

ULTRATECH GROUP OF LABS

3000 Bristol Circle, Oakville, Ontario, Canada L6H 6G4
Tel. #: 905-829-1570, Fax. #: 905-829-8050, Email: vic@ultratech-labs.com, Website: <http://www.ultratech-labs.com>

File #: RCI-176FCC90Z
August 27, 2007

- All test results contained in this engineering test report are traceable to National Institute of Standards and Technology (NIST)

Plot # 9: Peak Conducted Power Density Measurement (High Power Setting)
Frequency: 3675 MHz, Ch Spacing: 3.5 MHz

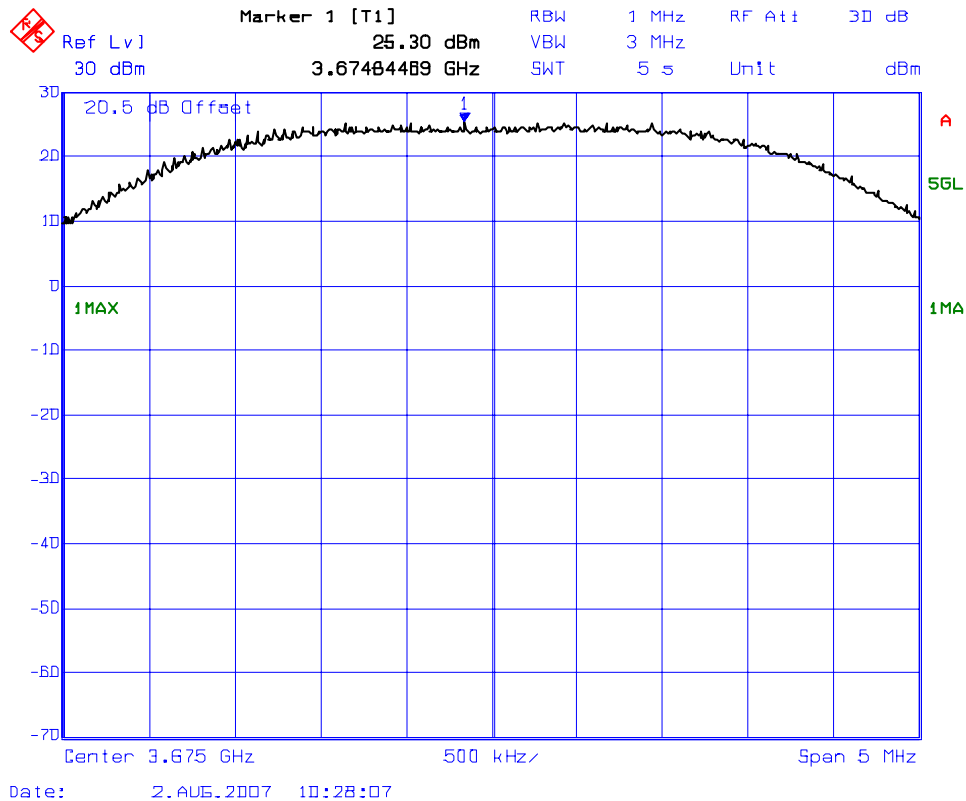

ULTRATECH GROUP OF LABS

3000 Bristol Circle, Oakville, Ontario, Canada L6H 6G4
Tel. #: 905-829-1570, Fax. #: 905-829-8050, Email: vic@ultratech-labs.com, Website: <http://www.ultratech-labs.com>

File #: RCI-176FCC90Z
August 27, 2007

- All test results contained in this engineering test report are traceable to National Institute of Standards and Technology (NIST)

Plot # 10: Peak Conducted Power Density Measurement (High Power Setting)
Frequency: 3650 MHz, Ch Spacing: 7 MHz

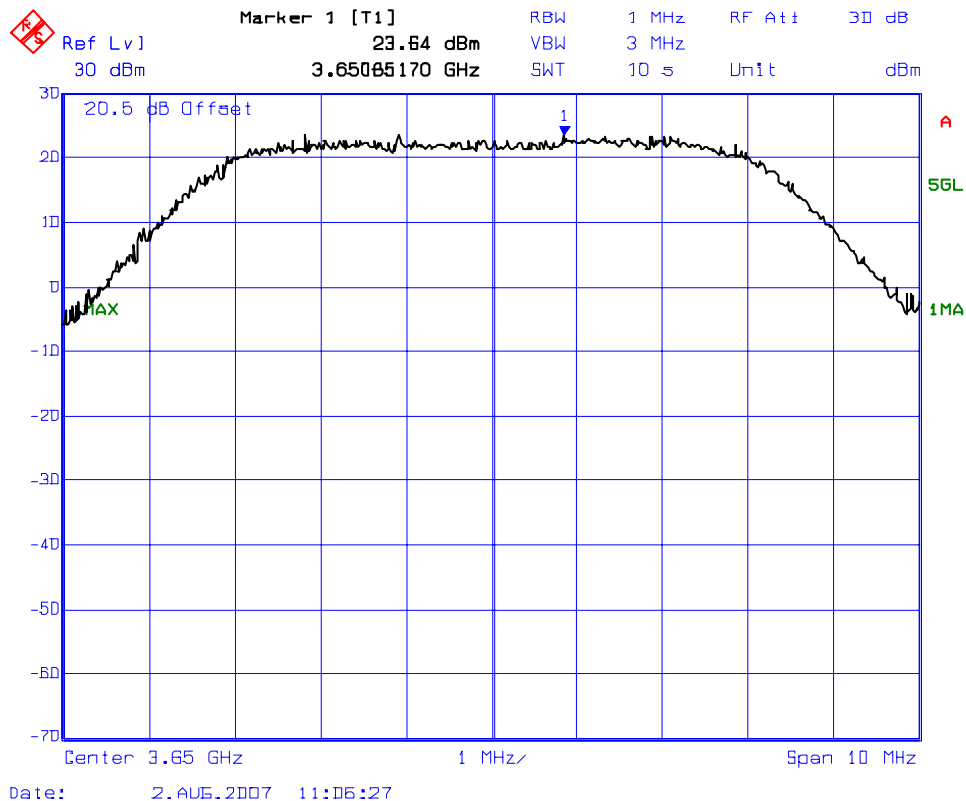

ULTRATECH GROUP OF LABS

3000 Bristol Circle, Oakville, Ontario, Canada L6H 6G4
Tel. #: 905-829-1570, Fax. #: 905-829-8050, Email: vic@ultratech-labs.com, Website: <http://www.ultratech-labs.com>

File #: RCI-176FCC90Z
August 27, 2007

- All test results contained in this engineering test report are traceable to National Institute of Standards and Technology (NIST)

Plot # 11: Peak Conducted Power Density Measurement (High Power Setting)
Frequency: 3662.5 MHz, Ch Spacing: 7 MHz

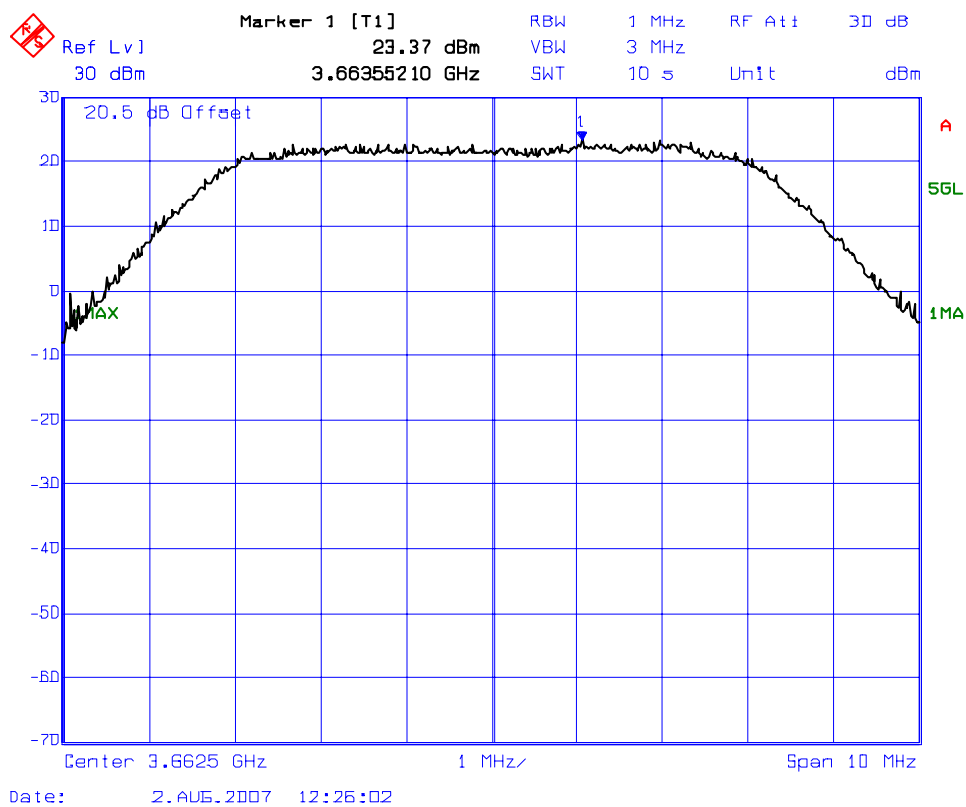

ULTRATECH GROUP OF LABS

3000 Bristol Circle, Oakville, Ontario, Canada L6H 6G4
Tel. #: 905-829-1570, Fax. #: 905-829-8050, Email: vic@ultratech-labs.com, Website: <http://www.ultratech-labs.com>

File #: RCI-176FCC90Z
August 27, 2007

- All test results contained in this engineering test report are traceable to National Institute of Standards and Technology (NIST)

Plot # 12: Peak Conducted Power Density Measurement (High Power Setting)
Frequency: 3675 MHz, Ch Spacing: 7 MHz

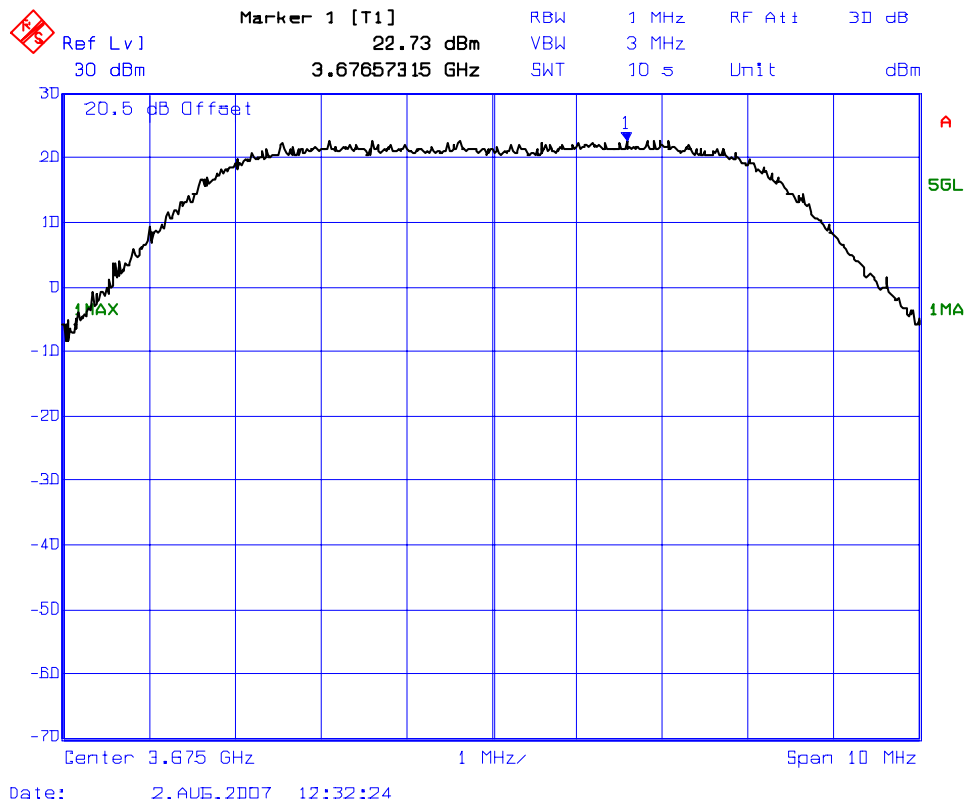

ULTRATECH GROUP OF LABS

3000 Bristol Circle, Oakville, Ontario, Canada L6H 6G4
Tel. #: 905-829-1570, Fax. #: 905-829-8050, Email: vic@ultratech-labs.com, Website: <http://www.ultratech-labs.com>

File #: RCI-176FCC90Z
August 27, 2007

- All test results contained in this engineering test report are traceable to National Institute of Standards and Technology (NIST)

5.6. RF EXPOSURE REQUIRMENTS @ SEC. 90.1217, 1.1310 & 2.1091

5.6.1. Limits

- **FCC 1.1310:-** The criteria listed in the following table shall be used to evaluate the environmental impact of human exposure to radio-frequency (RF) radiation as specified in 1.1307(b).

LIMITS FOR MAXIMUM PERMISSIBLE EXPOSURE (MPE)

Frequency Range (MHz)	Electric Field Strength (V/m)	Magnetic Field Strength (A/m)	Power Density (mW/cm ²)	Average Time (minutes)
(A) Limits for Occupational/Control Exposures				
1500-100,000	5	6
(B) Limits for General Population/Uncontrolled Exposure				
1500-100,000	1.0	30

F = Frequency in MHz

5.6.2. Method of Measurements

Refer to FCC @ 1.1310, 2.1091 and Public Notice DA 00-705 (March 30, 2000)

- Spread spectrum transmitters operating under section 15.247 are categorically from routine environmental evaluation to demonstrating RF exposure compliance with respect to MPE and/or SAR limits. These devices are not exempted from compliance (As indicated in Section 15.247(b)(4), these transmitters are required to operate in a manner that ensures that exposure to public users and nearby persons) does not exceed the Commission's RF exposure guidelines (see Section 1.1307 and 2.1093). Unless a device operates at substantially low power levels, with a low gain antenna(s), supporting information is generally needed to establish the various potential operating configurations and exposure conditions of a transmitter and its antenna(s) in order to determine compliance with the RF exposure guidelines.
- In order to demonstrate compliance with MPE requirements (see Section 2.1091), the following information is typically needed:
 - (1) Calculation that estimates the minimum separation distance (20 cm or more) between an antenna and persons required to satisfy power density limits defined for free space.
 - (2) Antenna installation and device operating instructions for installers (professional/unskilled users), and the parties responsible for ensuring compliance with the RF exposure requirement
 - (3) Any caution statements and/or warning labels that are necessary in order to comply with the exposure limits
 - (4) Any other RF exposure related issues that may affect MPE compliance

Calculation Method of RF Safety Distance:

$$S = PG/4\pi r^2 = EIRP/4\pi r^2$$

Where: P: power input to the antenna in mW
EIRP: Equivalent (effective) isotropic radiated power.
S: power density mW/cm²
G: numeric gain of antenna relative to isotropic radiator
r: distance to centre of radiation in cm

FCC radio frequency exposure limits may be exceeded at distances closer than r cm from the antenna of this device

$$r = \sqrt{PG/4\pi S}$$

FCC radio frequency exposure limits may not be exceeded at distances closer than r cm from the antenna of this device

- For portable transmitters (see Section 2.1093), or devices designed to operate next to a person's body, compliance is determined with respect to the SAR limit (define in the body tissues) for near-field exposure conditions. If the maximum average output power, operating condition configurations and exposure conditions are comparable to those of existing cellular and PCS phones., an SAR evaluation may be required in order to determine if such a device complies with SAR limit. When SAR evaluation data is not available, and the additional supporting information cannot assure compliance, the Commission may request that a SAR evaluation be performed, as provided for in Section 1.1307(d)

5.6.3. Test Data

Antennas Gain Range specified by Manufacturer: 11 to 20 dBi

Frequency (MHz)	Channel Spacing (MHz)	Maximum Total Peak EIRP Power (dBm)	Laboratory's Recommended Minimum RF Safety Distance r (cm)
3650.0	7.0	38.4	24
3650.0	3.5	35.4	20

Note 1: RF EXPOSURE DISTANCE LIMITS: $r = (PG/4\pi S)^{1/2} = (EIRP/4\pi S)^{1/2}$
 $S = 1.0 \text{ mW/cm}^2$

For 7 MHz channel spacing:

$$r = (PG/4\pi S)^{1/2} = (EIRP/4\pi S)^{1/2}$$

$$= (7000/4 \times 3.14 \times 1)^{1/2}$$

$$= 23.6 \text{ cm}$$

For 3.5 MHz channel spacing:

$$r = (PG/4\pi S)^{1/2} = (EIRP/4\pi S)^{1/2}$$

$$= (3500/4 \times 3.14 \times 1)^{1/2}$$

$$= 16.7 \text{ cm}$$

Evaluation of RF Exposure Compliance Requirements	
RF Exposure Requirements	Compliance with FCC Rules
Minimum calculated separation distance between antenna and persons required: 23.6 cm (7 MHz channel spacing) & 16.7 cm (3.5 MHz channel spacing)	Manufacturer' instruction for separation distance between antenna and persons required: 25 cm. Please refer to page # 9 of the User Manual.
Antenna installation and device operating instructions for installers (professional/unskilled users), and the parties responsible for ensuring compliance with the RF exposure requirement	Professional Installation only, Refer to Page # 9 of the User Manual for details.
Caution statements and/or warning labels that are necessary in order to comply with the exposure limits	Please refer to page # 9 of the User Manual.

5.7. 99% OCCUPIED BANDWIDTH @ FCC 2.1049

5.7.1. Limits

Not Specified.

5.7.2. Method of Measurements

The 99% occupied bandwidth is measured using EMI receiver (spectrum analyzer) with RBW = 1% of 99% OBW, VBW >= RBW.

5.7.3. Test Equipment List

Test Instruments	Manufacturer	Model No.	Serial No.	Frequency Range
Spectrum Analyzer/ EMI Receiver	Rohde & Schawrz	FSEK20/B4/B21	834157/005	9 kHz – 40 GHz with external mixer

5.7.4. Test Arrangement

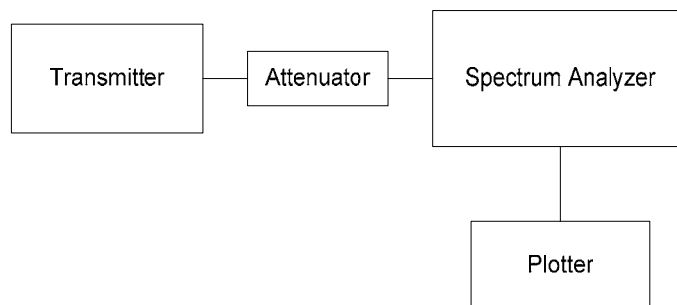

5.7.5. Test Data

Transmitter Channel	Fundamental Frequency (MHz)	Channel Spacing (MHz)	99% Occupied Bandwidth (MHz)
Lowest	3650.0	3.5	3.14
Middle	3662.5	3.5	3.13
Highest	3675.0	3.5	3.14
Lowest	3650.0	7.0	6.27
Middle	3662.5	7.0	6.29
Highest	3675.0	7.0	6.29

Please refer to Plots # 13 to 18 for details of measurements.

Plot # 13: 99% Occupied Bandwidth
Frequency: 3650 MHz, Ch Spacing: 3.5 MHz

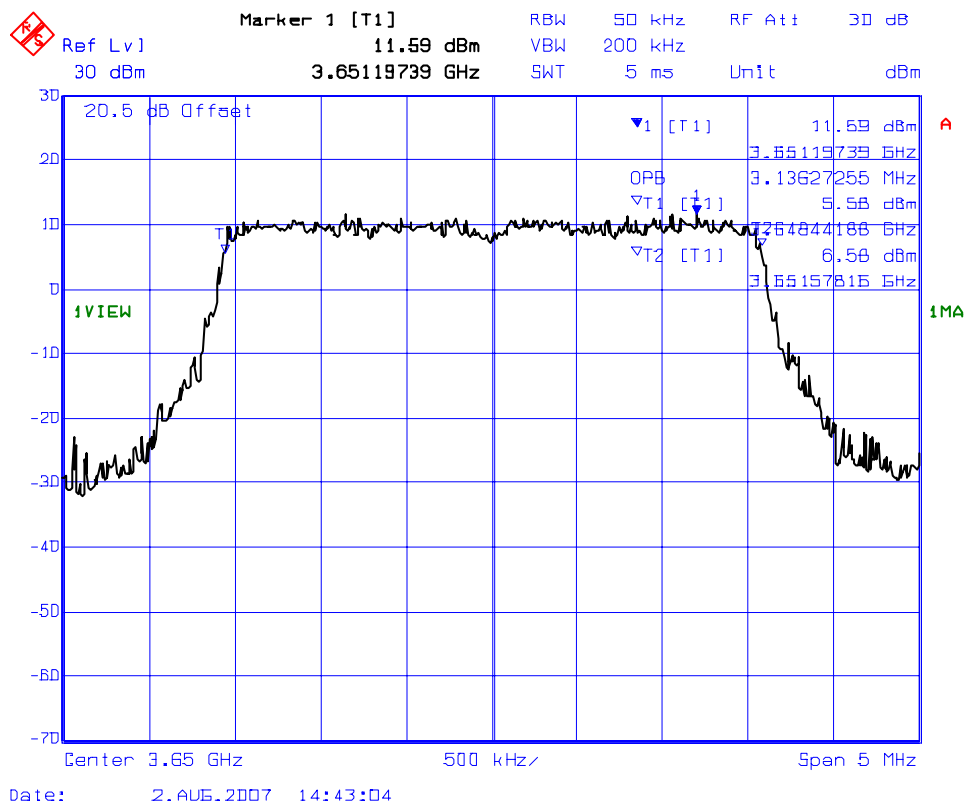

ULTRATECH GROUP OF LABS

3000 Bristol Circle, Oakville, Ontario, Canada L6H 6G4
Tel. #: 905-829-1570, Fax. #: 905-829-8050, Email: vic@ultratech-labs.com, Website: <http://www.ultratech-labs.com>

File #: RCI-176FCC90Z
August 27, 2007

- All test results contained in this engineering test report are traceable to National Institute of Standards and Technology (NIST)

Plot # 14: 99% Occupied Bandwidth
Frequency: 3662.5 MHz, Ch Spacing: 3.5 MHz

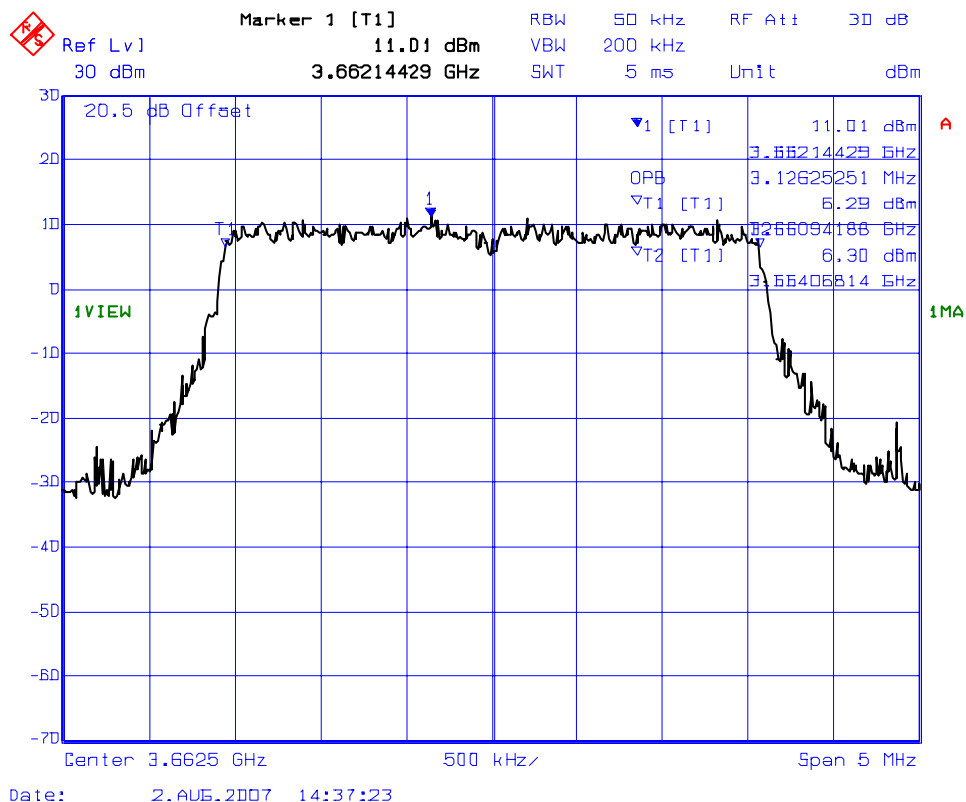

ULTRATECH GROUP OF LABS

3000 Bristol Circle, Oakville, Ontario, Canada L6H 6G4
 Tel. #: 905-829-1570, Fax. #: 905-829-8050, Email: vic@ultratech-labs.com, Website: <http://www.ultratech-labs.com>

File #: RCI-176FCC90Z
 August 27, 2007

- All test results contained in this engineering test report are traceable to National Institute of Standards and Technology (NIST)

Plot # 15: 99% Occupied Bandwidth
Frequency: 3675 MHz, Ch Spacing: 3.5 MHz

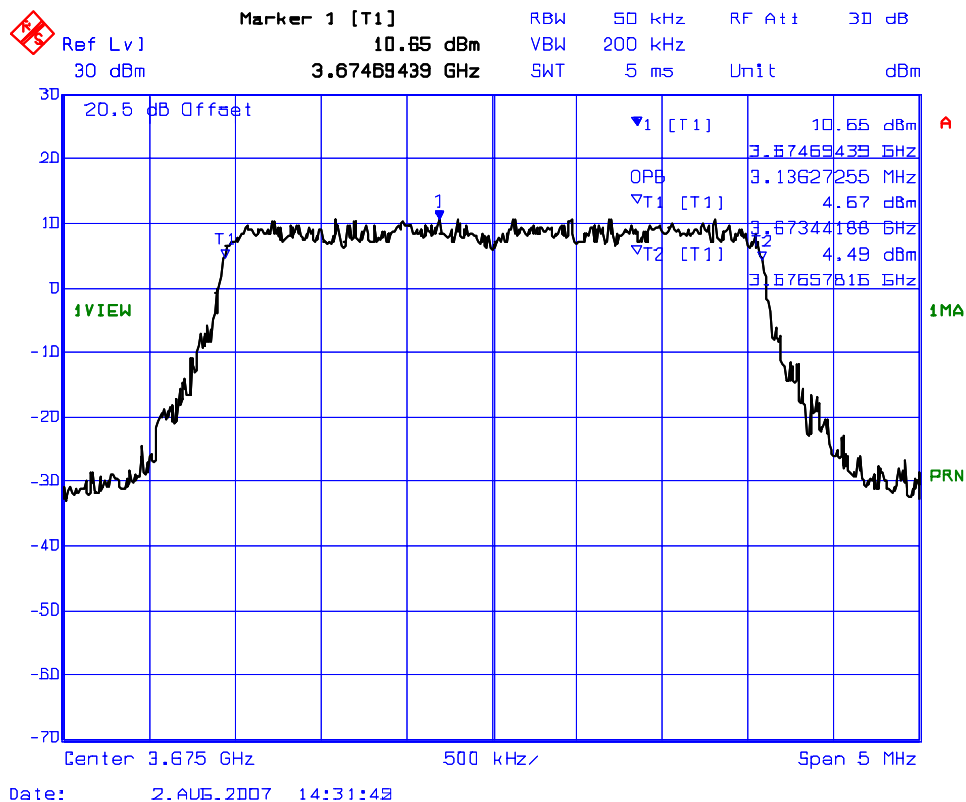

ULTRATECH GROUP OF LABS

3000 Bristol Circle, Oakville, Ontario, Canada L6H 6G4
 Tel. #: 905-829-1570, Fax. #: 905-829-8050, Email: vic@ultratech-labs.com, Website: <http://www.ultratech-labs.com>

File #: RCI-176FCC90Z
 August 27, 2007

- All test results contained in this engineering test report are traceable to National Institute of Standards and Technology (NIST)

Plot # 16: 99% Occupied Bandwidth
Frequency: 3650 MHz, Ch Spacing: 7 MHz

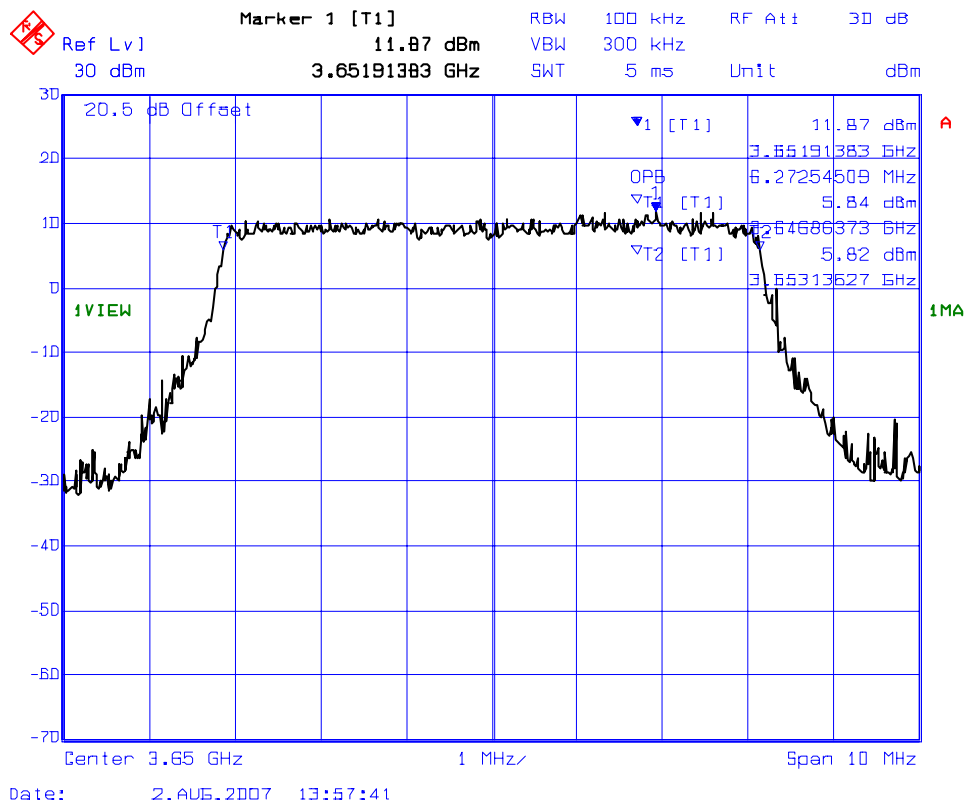

ULTRATECH GROUP OF LABS

3000 Bristol Circle, Oakville, Ontario, Canada L6H 6G4
 Tel. #: 905-829-1570, Fax. #: 905-829-8050, Email: vic@ultratech-labs.com, Website: <http://www.ultratech-labs.com>

File #: RCI-176FCC90Z
 August 27, 2007

- All test results contained in this engineering test report are traceable to National Institute of Standards and Technology (NIST)

Plot # 17: 99% Occupied Bandwidth
Frequency: 3662.5 MHz, Ch Spacing: 7 MHz

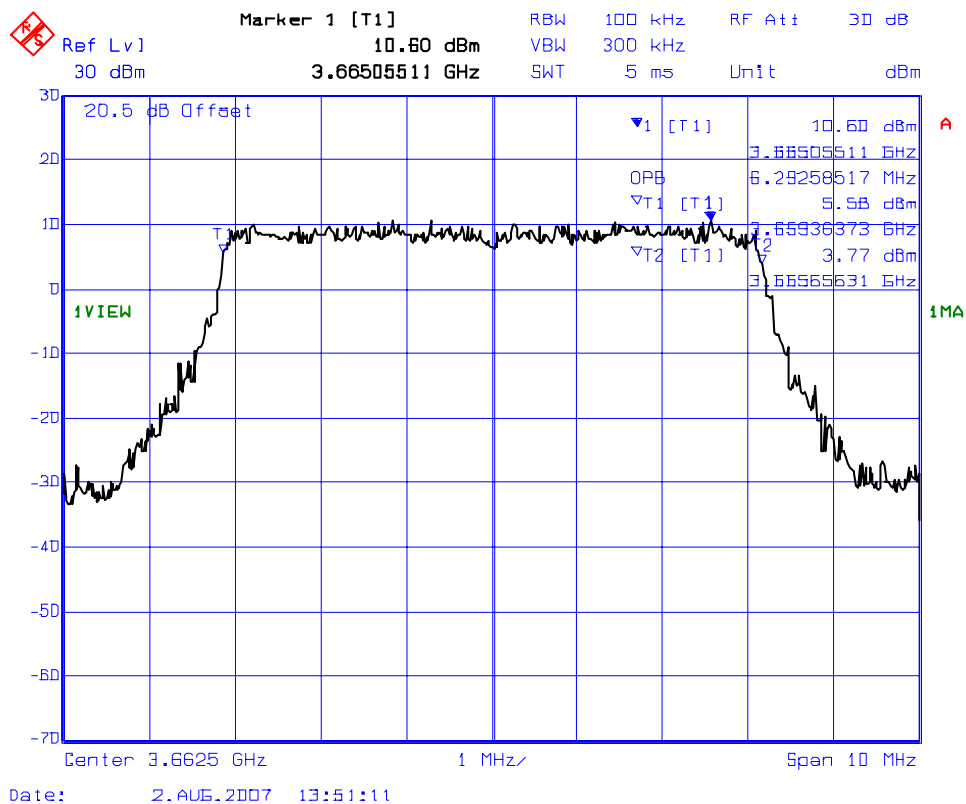

ULTRATECH GROUP OF LABS

3000 Bristol Circle, Oakville, Ontario, Canada L6H 6G4
Tel. #: 905-829-1570, Fax. #: 905-829-8050, Email: vic@ultratech-labs.com, Website: <http://www.ultratech-labs.com>

File #: RCI-176FCC90Z
August 27, 2007

- All test results contained in this engineering test report are traceable to National Institute of Standards and Technology (NIST)

Plot # 18: 99% Occupied Bandwidth
Frequency: 3675 MHz, Ch Spacing: 7 MHz

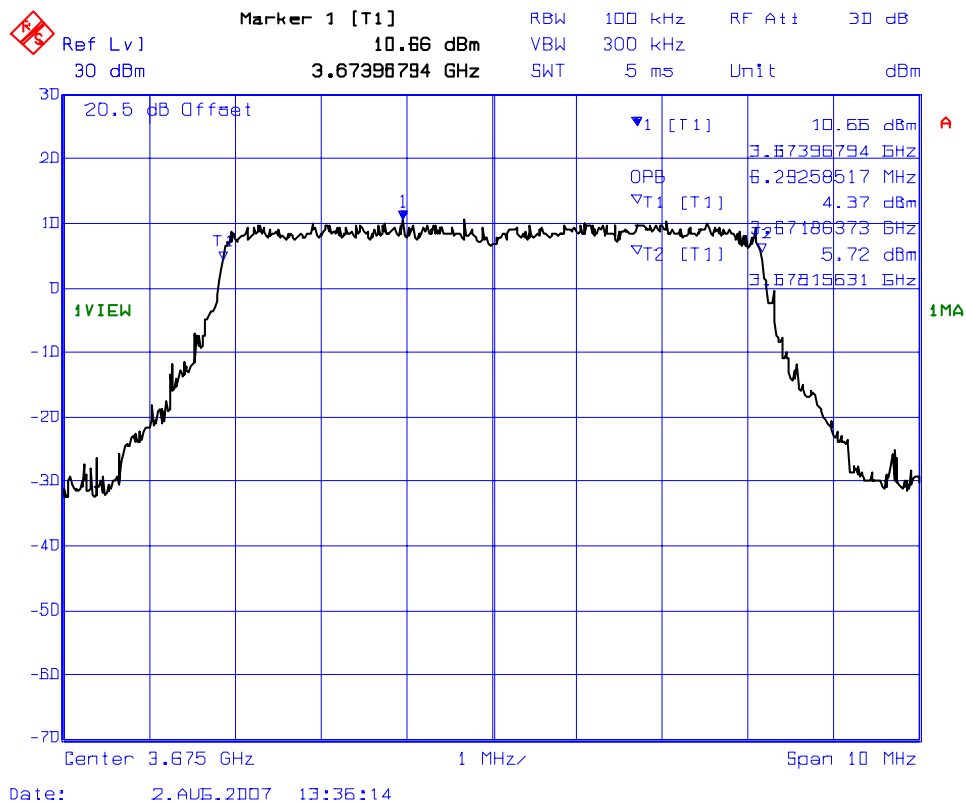

ULTRATECH GROUP OF LABS

3000 Bristol Circle, Oakville, Ontario, Canada L6H 6G4
 Tel. #: 905-829-1570, Fax. #: 905-829-8050, Email: vic@ultratech-labs.com, Website: <http://www.ultratech-labs.com>

File #: RCI-176FCC90Z
 August 27, 2007

- All test results contained in this engineering test report are traceable to National Institute of Standards and Technology (NIST)

5.8. FREQUENCY STABILITY @ FCC 2.1055

5.8.1. Limits

The frequency stability shall be sufficient to ensure that the fundamental emissions stay within the authorized bands of operation.

5.8.2. Method of Measurements

Refer to Exhibit 7, Section 7.2 for details of measurement methods.

The frequency stability will be specified in the station authorization. For the purpose of compliance, the carrier frequency stability will be checked for out-of-band emissions at room temperature (20°C) and extreme temperatures (-30°C and +50°C).

5.8.3. Test Equipment List

Test Instruments	Manufacturer	Model No.	Serial No.	Frequency Range
Spectrum Analyzer/ EMI Receiver	Rohde & Schawrz	FSEK20/B4/B2 1	834157/005	9 kHz – 40 GHz with external mixer
Attenuator(s)	Bird	DC – 22 GHz
Temperature & Humidity Chamber	Tenney	T5	9723B	-40° to +60° C range

5.8.4. Test Arrangement

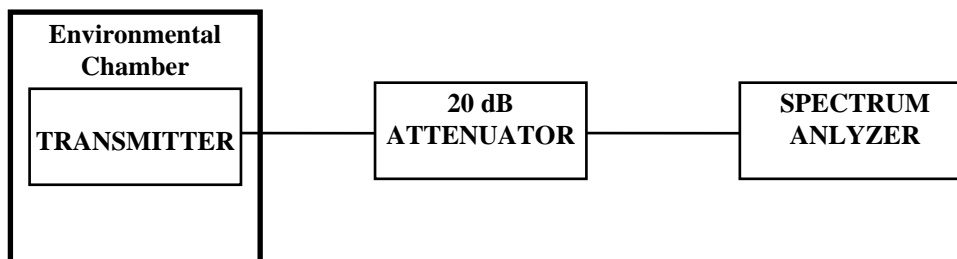

5.8.5. Test Data

Center Frequency:	3650 MHz
Full Power Level:	0.94 Watts or 29.71 dBm
Frequency Tolerance Limit:	Not Specified
Max. Frequency Tolerance Measured:	0
Input Voltage Rating:	120 V AC

CENTER FREQUENCY & RF POWER OUTPUT VARIATION			
Ambient Temperature	Supply Voltage (Nominal) Volts	Supply Voltage (85% of Nominal) Volts	Supply Voltage (115% of Nominal) Volts
(°C)	Hz	Hz	Hz
-40	0	N/A	N/A
-30	0	N/A	N/A
-20	0	N/A	N/A
-10	0	N/A	N/A
0	0	N/A	N/A
+10	0	N/A	N/A
+20	0	0	0
+30	0	N/A	N/A
+40	0	N/A	N/A
+50	0	N/A	N/A
+60	0	N/A	N/A
+65	0	N/A	N/A

5.9. CONDUCTED EMISSION LIMITS @ FCC 90.1323

5.9.1. Limits @ 90.1323

- (a) The power of any emission outside a licensee’s frequency band(s) of operation shall be attenuated below the transmitter power (P) within the licensed band(s) of operation, measured in watts, by at least $43 + 10 \log (P)$ dB. Compliance with this provision is based on the use of measurement instrumentation employing a resolution bandwidth of 1 MHz or less, but at least one percent of the emission bandwidth of the fundamental emission of the transmitter, provided the measured energy is integrated over a 1 MHz bandwidth.
- (b) When an emission outside of the authorized bandwidth causes harmful interference, the Commission may, at its discretion, require greater attenuation than specified in this section.

5.9.2. Method of Measurements

With transmitter modulation characteristics described in Out-of-Band Emissions measurements @ 2.1049 and the transmitter was operated in full rated power, the transmitter spurious and harmonic emissions were scanned. The spurious and harmonic emissions were measured with the EMI Receiver controls set as RBW = 1 MHz, VBW \geq RBW and SWEEP TIME = AUTO).

5.9.3. Test Equipment List

Test Instruments	Manufacturer	Model No.	Serial No.	Frequency Range
Spectrum Analyzer/ EMI Receiver	Rohde & Schwarz	FSEK20/B4/B21	834157/005	9 kHz – 40 GHz with external mixer
Attenuator(s)	Bird	DC – 22 GHz
Audio Oscillator	Hewlett Packard	HP 204C	0989A08798	DC to 1.2 MHz

5.9.4. Test Arrangement

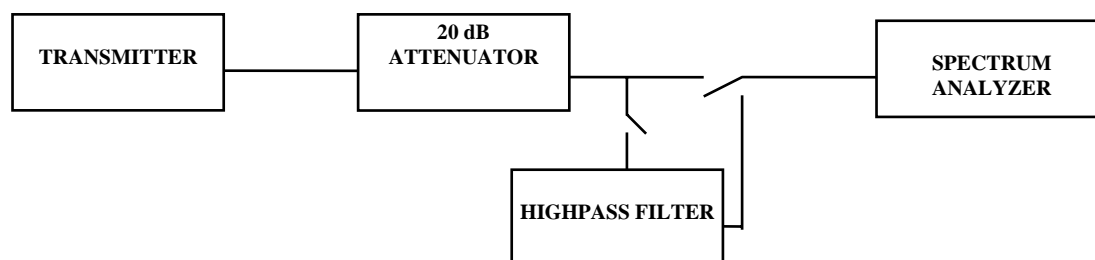

5.9.5. Plots

Please refer to plots # 19 through # 21 for details of measurements from 30 MHz to 38 GHz.

Plot # 19: Transmitter Conducted Emissions, Frequency: 3650 MHz

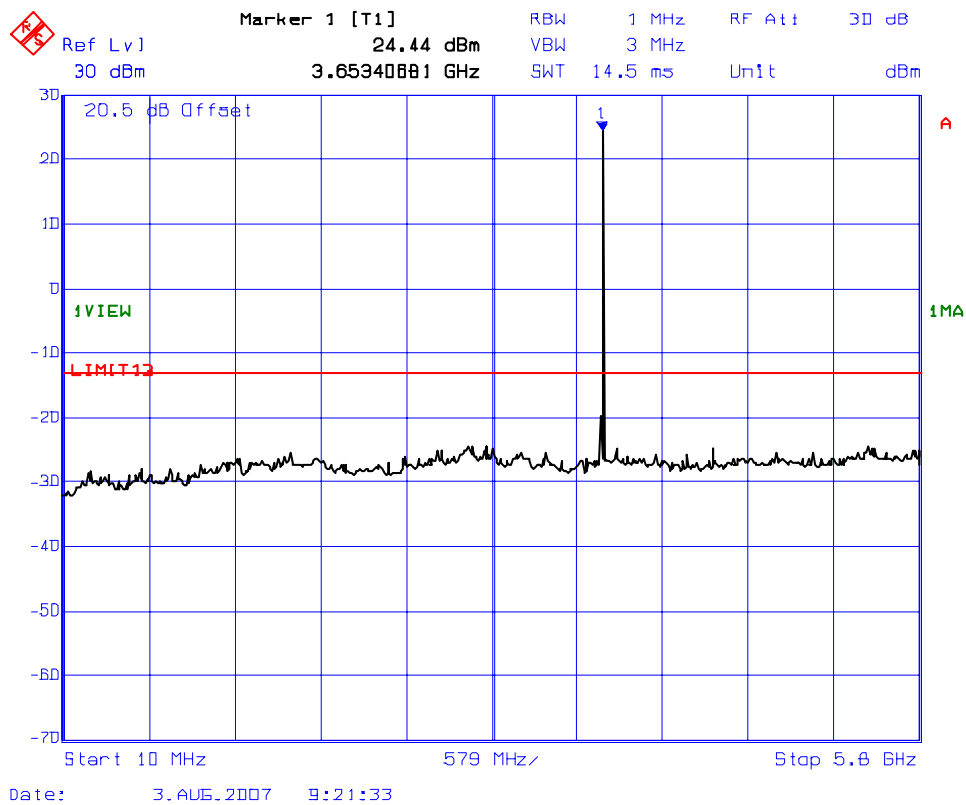

ULTRATECH GROUP OF LABS

3000 Bristol Circle, Oakville, Ontario, Canada L6H 6G4
Tel. #: 905-829-1570, Fax. #: 905-829-8050, Email: vic@ultratech-labs.com, Website: <http://www.ultratech-labs.com>

File #: RCI-176FCC90Z
August 27, 2007

- All test results contained in this engineering test report are traceable to National Institute of Standards and Technology (NIST)

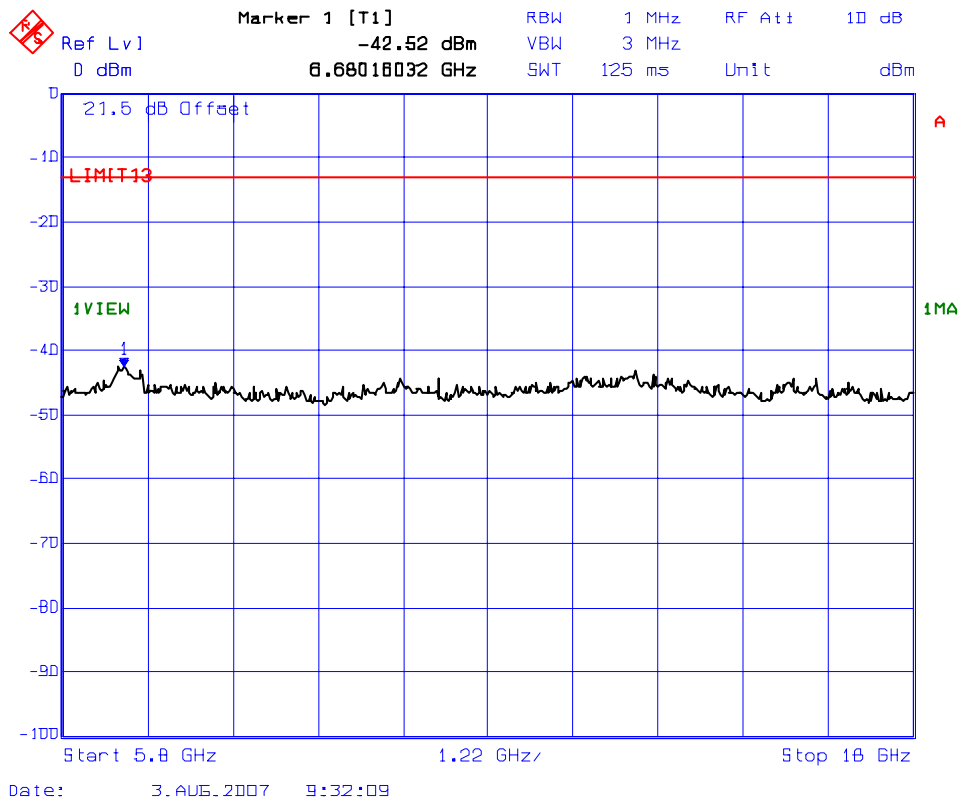

ULTRATECH GROUP OF LABS

3000 Bristol Circle, Oakville, Ontario, Canada L6H 6G4
Tel. #: 905-829-1570, Fax. #: 905-829-8050, Email: vic@ultratech-labs.com, Website: <http://www.ultratech-labs.com>

File #: RCI-176FCC90Z
August 27, 2007

- All test results contained in this engineering test report are traceable to National Institute of Standards and Technology (NIST)

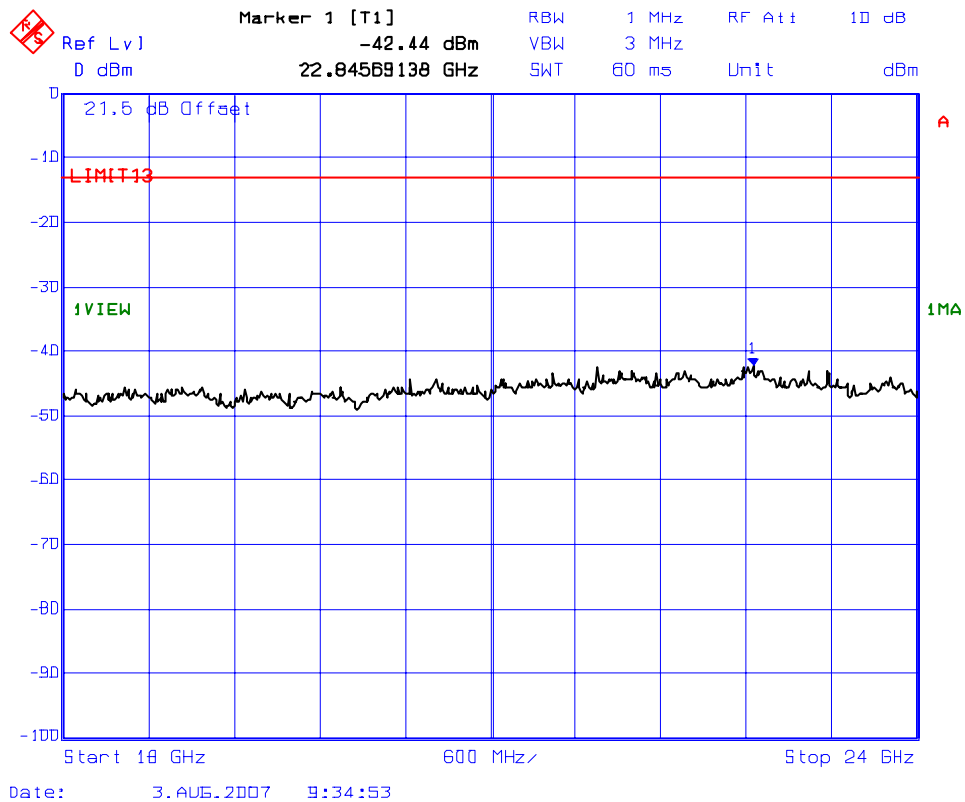

ULTRATECH GROUP OF LABS

3000 Bristol Circle, Oakville, Ontario, Canada L6H 6G4
Tel. #: 905-829-1570, Fax. #: 905-829-8050, Email: vic@ultratech-labs.com, Website: <http://www.ultratech-labs.com>

File #: RCI-176FCC90Z
August 27, 2007

- All test results contained in this engineering test report are traceable to National Institute of Standards and Technology (NIST)

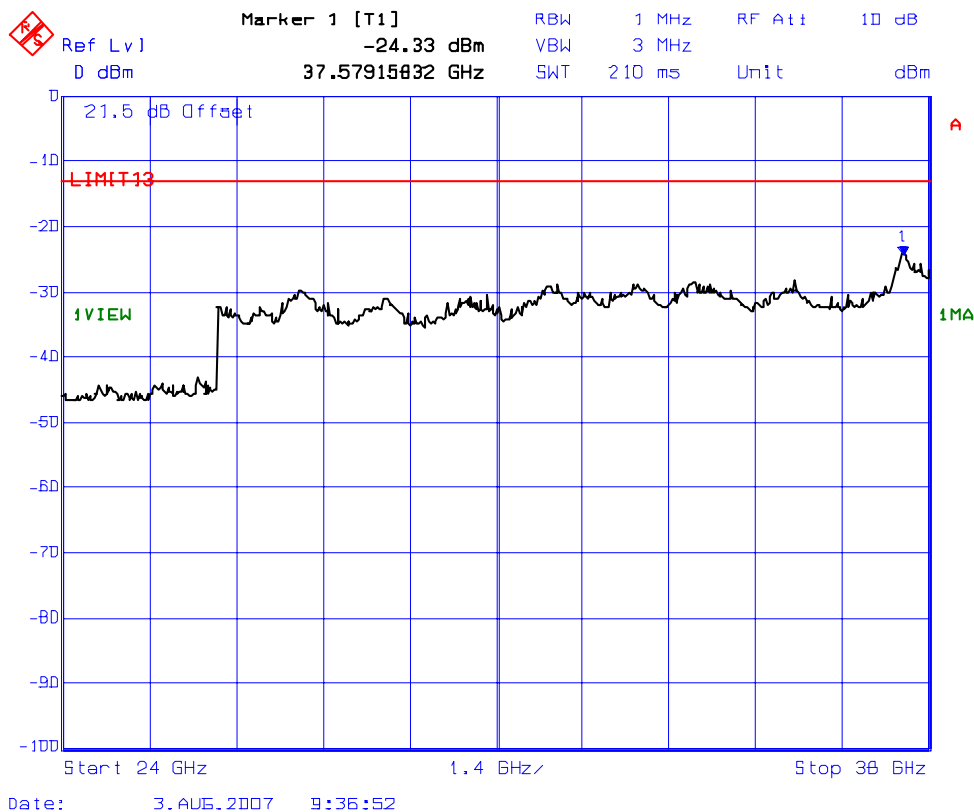

ULTRATECH GROUP OF LABS

3000 Bristol Circle, Oakville, Ontario, Canada L6H 6G4
Tel. #: 905-829-1570, Fax. #: 905-829-8050, Email: vic@ultratech-labs.com, Website: <http://www.ultratech-labs.com>

File #: RCI-176FCC90Z
August 27, 2007

- All test results contained in this engineering test report are traceable to National Institute of Standards and Technology (NIST)

Plot # 20: Transmitter Conducted Emissions, Frequency: 3662.5 MHz

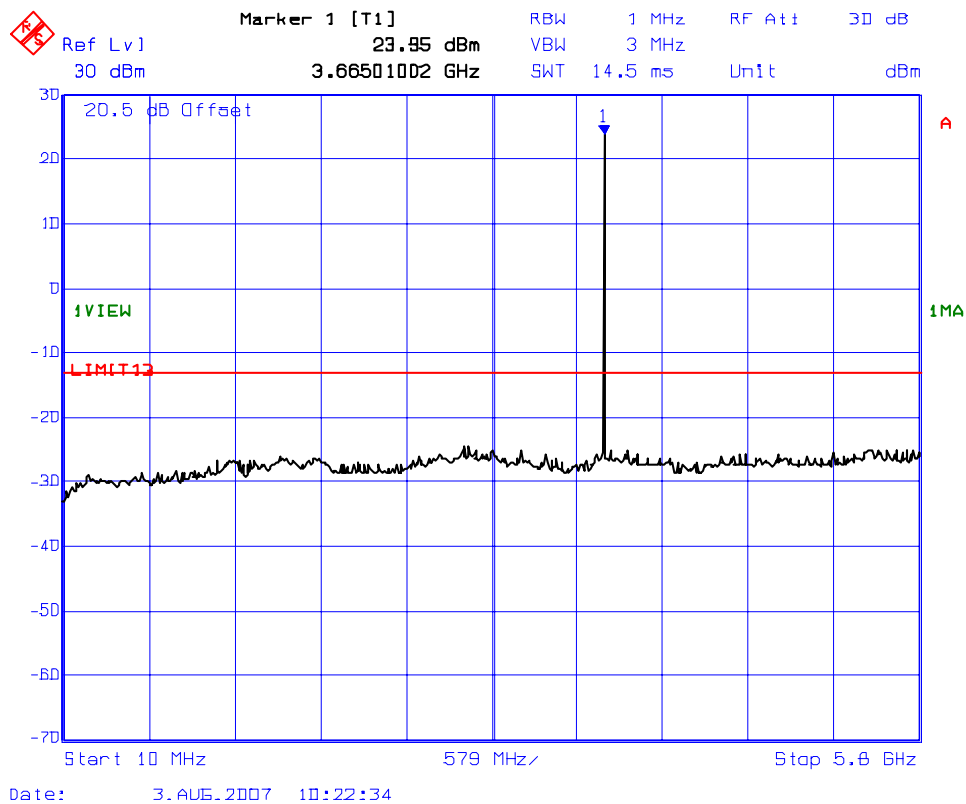

ULTRATECH GROUP OF LABS

3000 Bristol Circle, Oakville, Ontario, Canada L6H 6G4
Tel. #: 905-829-1570, Fax. #: 905-829-8050, Email: vic@ultratech-labs.com, Website: <http://www.ultratech-labs.com>

File #: RCI-176FCC90Z
August 27, 2007

- All test results contained in this engineering test report are traceable to National Institute of Standards and Technology (NIST)

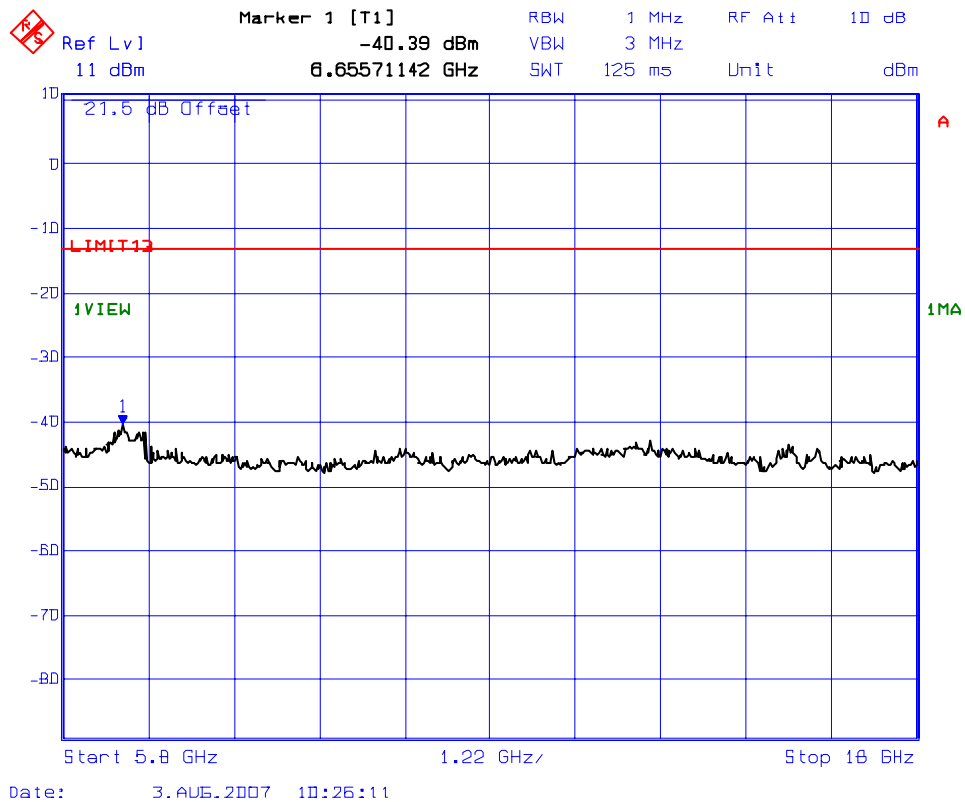

ULTRATECH GROUP OF LABS

3000 Bristol Circle, Oakville, Ontario, Canada L6H 6G4
Tel. #: 905-829-1570, Fax. #: 905-829-8050, Email: vic@ultratech-labs.com, Website: <http://www.ultratech-labs.com>

File #: RCI-176FCC90Z
August 27, 2007

- All test results contained in this engineering test report are traceable to National Institute of Standards and Technology (NIST)

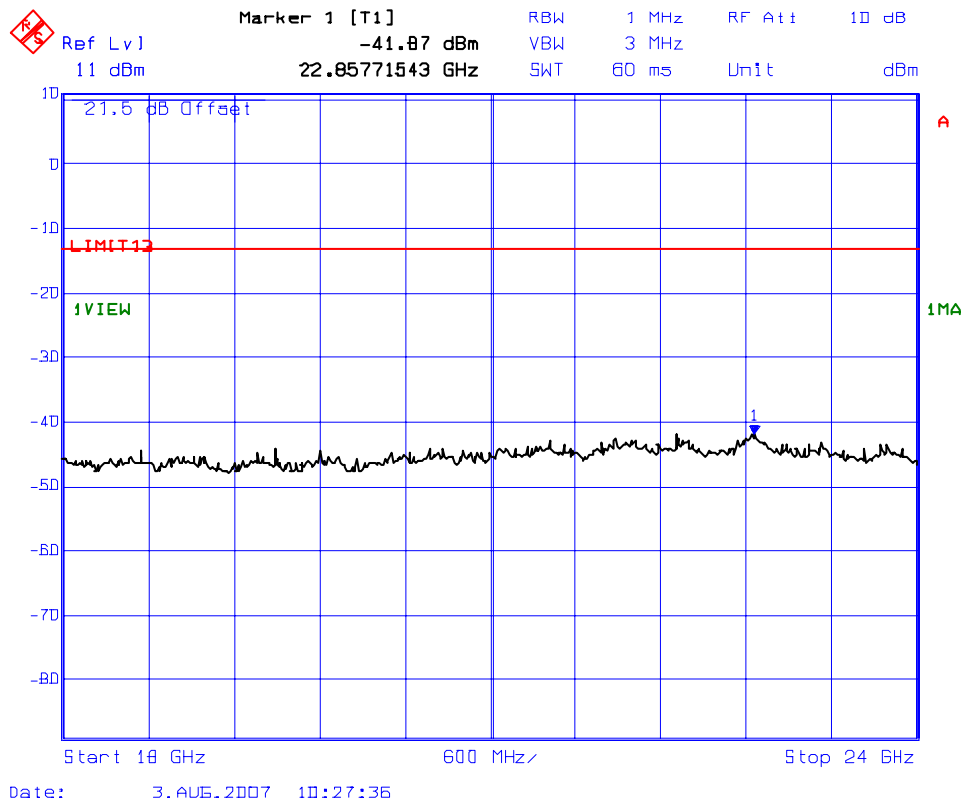

ULTRATECH GROUP OF LABS

3000 Bristol Circle, Oakville, Ontario, Canada L6H 6G4
Tel. #: 905-829-1570, Fax. #: 905-829-8050, Email: vic@ultratech-labs.com, Website: <http://www.ultratech-labs.com>

File #: RCI-176FCC90Z
August 27, 2007

- All test results contained in this engineering test report are traceable to National Institute of Standards and Technology (NIST)

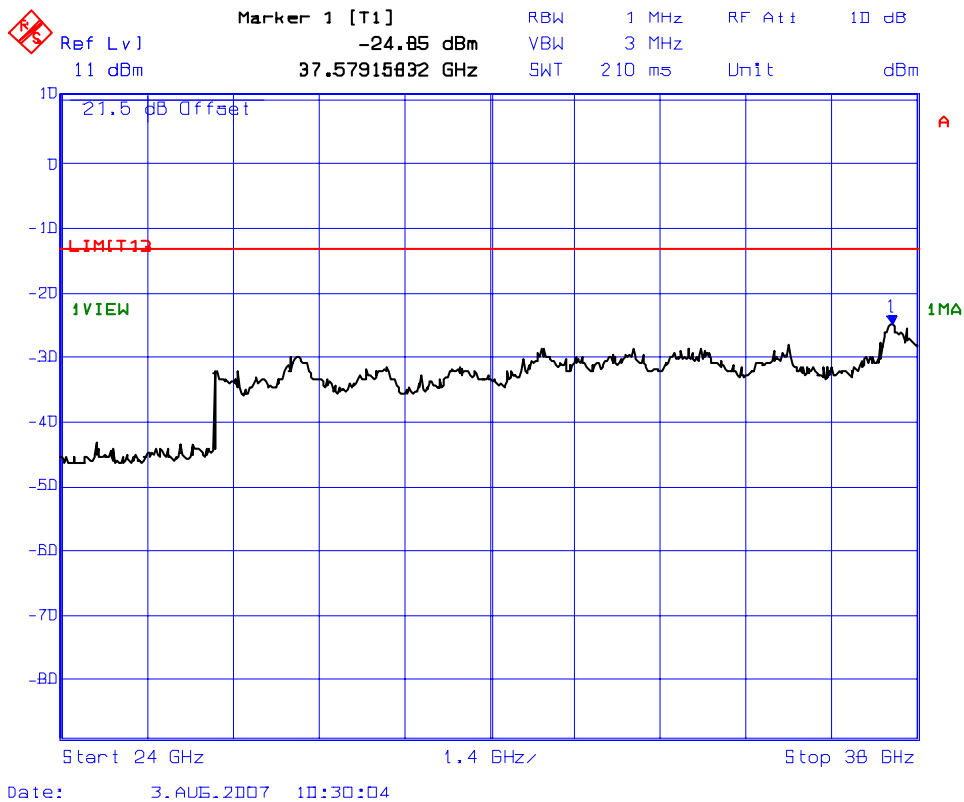

ULTRATECH GROUP OF LABS

3000 Bristol Circle, Oakville, Ontario, Canada L6H 6G4
Tel. #: 905-829-1570, Fax. #: 905-829-8050, Email: vic@ultratech-labs.com, Website: <http://www.ultratech-labs.com>

File #: RCI-176FCC90Z
August 27, 2007

- All test results contained in this engineering test report are traceable to National Institute of Standards and Technology (NIST)

Plot # 21: Transmitter Conducted Emissions, Frequency: 3675 MHz

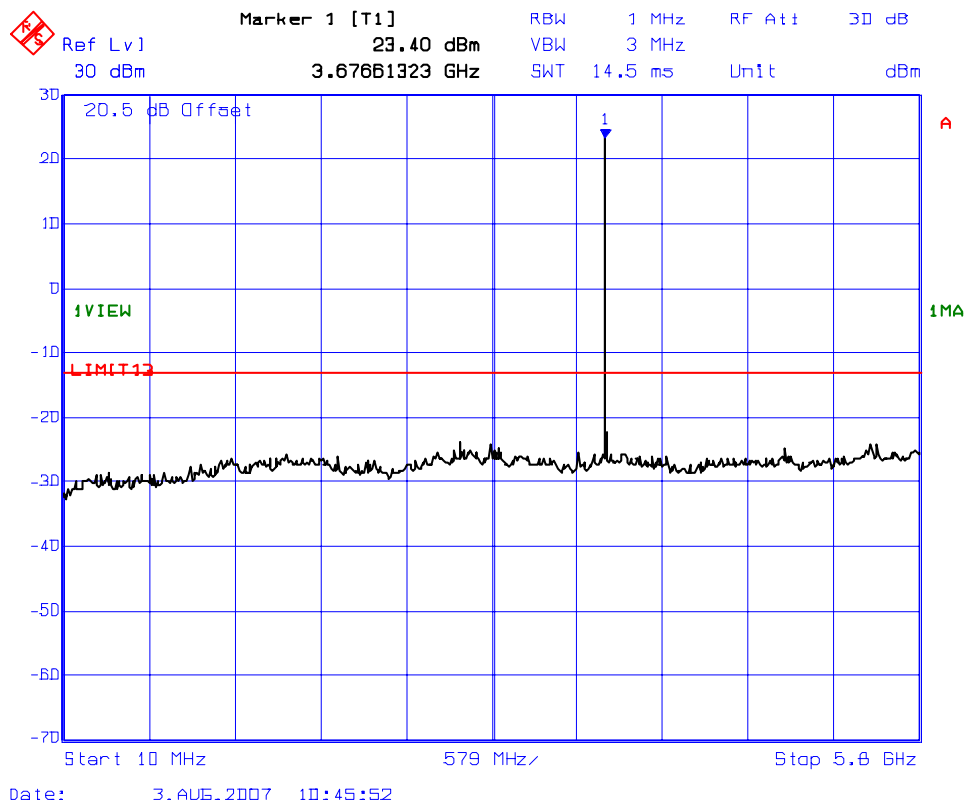

ULTRATECH GROUP OF LABS

3000 Bristol Circle, Oakville, Ontario, Canada L6H 6G4
Tel. #: 905-829-1570, Fax. #: 905-829-8050, Email: vic@ultratech-labs.com, Website: <http://www.ultratech-labs.com>

File #: RCI-176FCC90Z
August 27, 2007

- All test results contained in this engineering test report are traceable to National Institute of Standards and Technology (NIST)

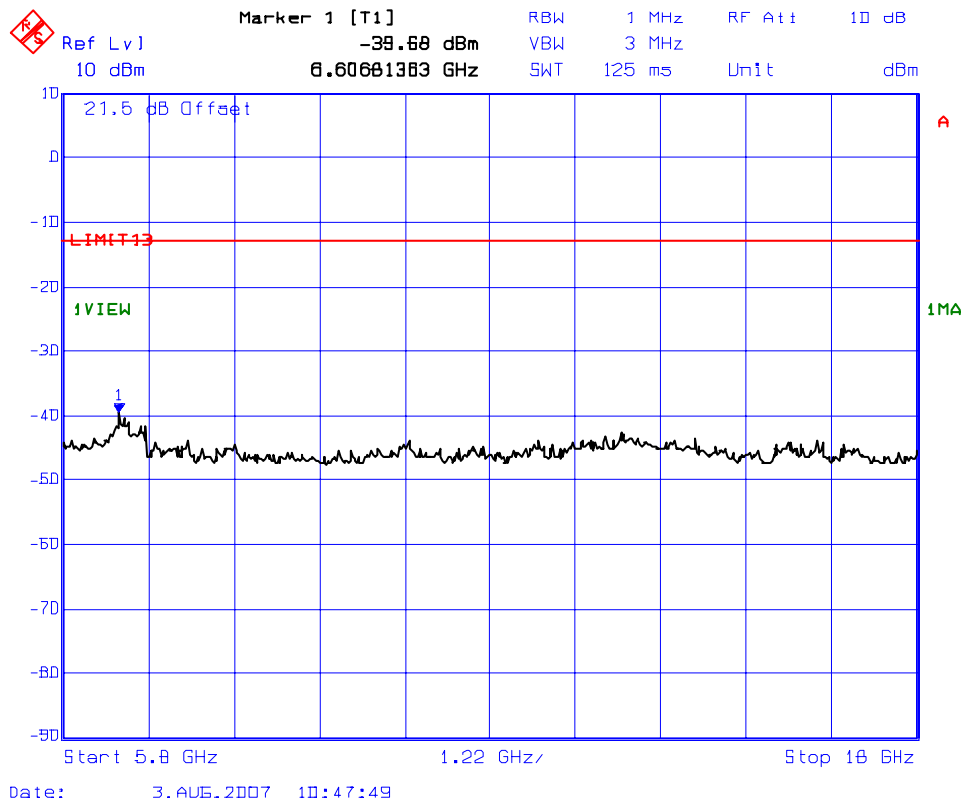

ULTRATECH GROUP OF LABS

3000 Bristol Circle, Oakville, Ontario, Canada L6H 6G4
Tel. #: 905-829-1570, Fax. #: 905-829-8050, Email: vic@ultratech-labs.com, Website: <http://www.ultratech-labs.com>

File #: RCI-176FCC90Z
August 27, 2007

- All test results contained in this engineering test report are traceable to National Institute of Standards and Technology (NIST)

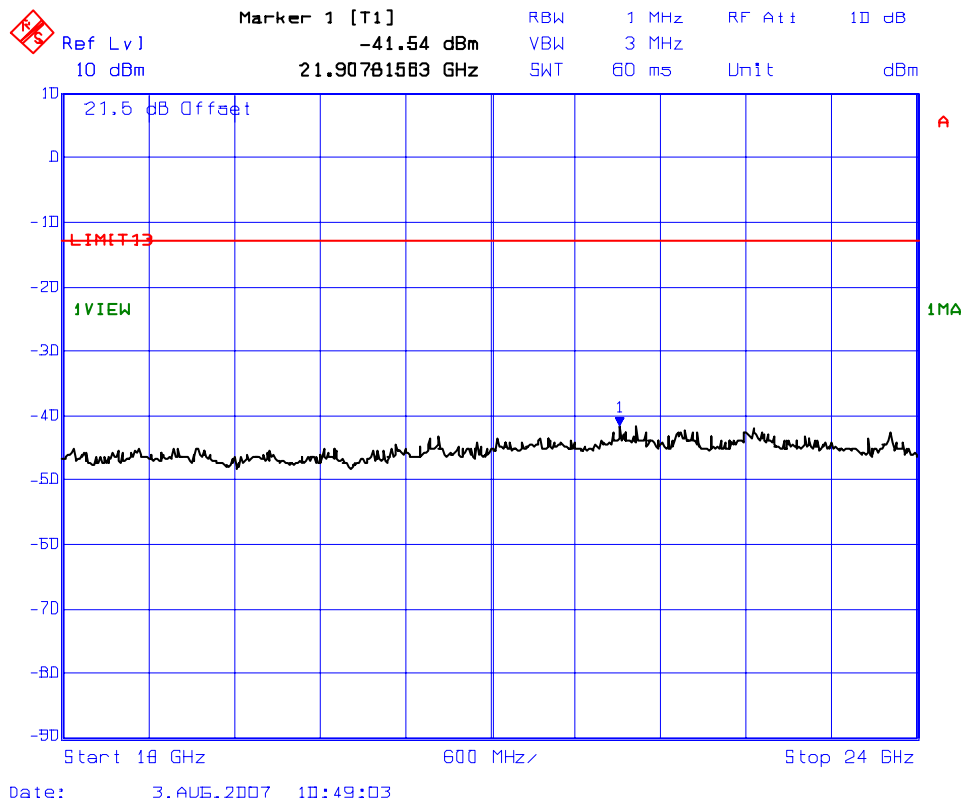

ULTRATECH GROUP OF LABS

3000 Bristol Circle, Oakville, Ontario, Canada L6H 6G4
Tel. #: 905-829-1570, Fax. #: 905-829-8050, Email: vic@ultratech-labs.com, Website: <http://www.ultratech-labs.com>

File #: RCI-176FCC90Z
August 27, 2007

- All test results contained in this engineering test report are traceable to National Institute of Standards and Technology (NIST)

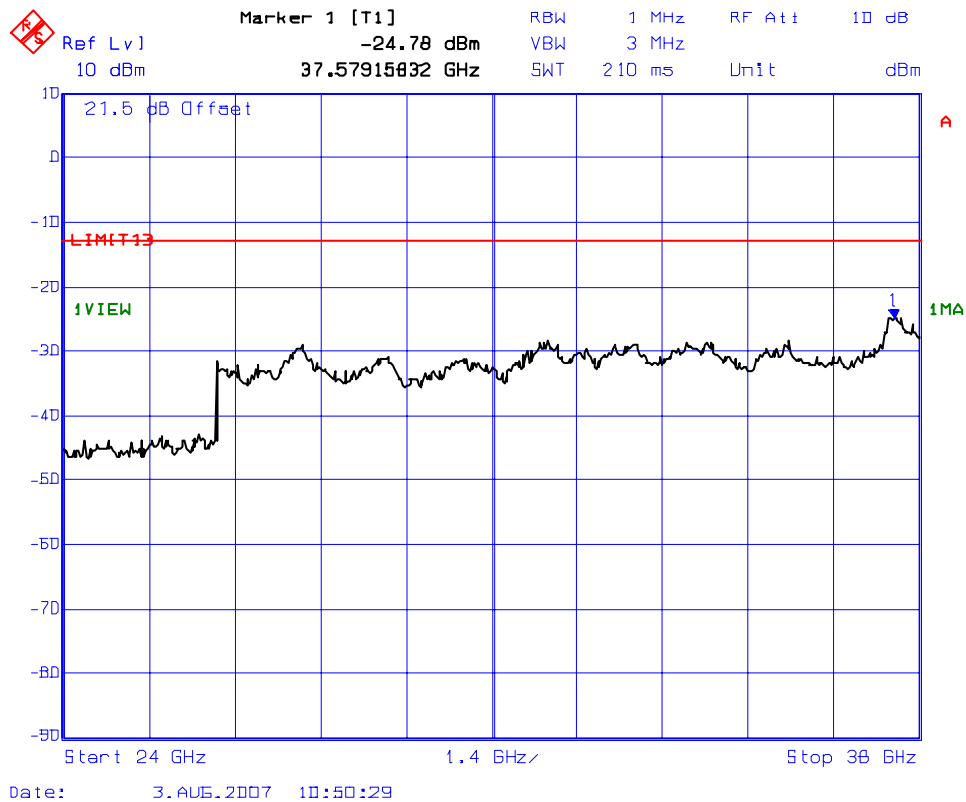

ULTRATECH GROUP OF LABS

3000 Bristol Circle, Oakville, Ontario, Canada L6H 6G4
Tel. #: 905-829-1570, Fax. #: 905-829-8050, Email: vic@ultratech-labs.com, Website: <http://www.ultratech-labs.com>

File #: RCI-176FCC90Z
August 27, 2007

- All test results contained in this engineering test report are traceable to National Institute of Standards and Technology (NIST)

5.10. TRANSMITTER SPURIOUS/HARMONIC RADIATED EMISSIONS @ FCC 90.1323

5.10.1. Limits @ 90.1323

- (a) The power of any emission outside a licensee's frequency band(s) of operation shall be attenuated below the transmitter power (P) within the licensed band(s) of operation, measured in watts, by at least $43 + 10 \log(P)$ dB. Compliance with this provision is based on the use of measurement instrumentation employing a resolution bandwidth of 1 MHz or less, but at least one percent of the emission bandwidth of the fundamental emission of the transmitter, provided the measured energy is integrated over a 1 MHz bandwidth.
- (b) When an emission outside of the authorized bandwidth causes harmful interference, the Commission may, at its discretion, require greater attenuation than specified in this section.

5.10.2. Method of Measurements

The spurious/harmonic ERP measurements are using substitution method specified in Exhibit 7, § 7.1 of this report and its value in dBc is calculated as follows:

1. If the transmitter's antenna is an integral part of the EUT, the ERP is measured using substitution method.
2. If the transmitter's antenna is non-integral and diverse, the lowest ERP of the carrier with 0 dBi antenna gain is used for calculation of the spurious/harmonic emissions in dBc:
3. Lowest ERP of the carrier = EIRP - 2.15 dB = $P_c + G - 2.15$ dB = xxx dBm (conducted) + 0 dBi - 2.15 dB
4. Spurious /harmonic emissions levels expressed in dBc (dB below carrier) are as follows:

$$\text{ERP of spurious/harmonic (dBc)} = \text{ERP of carrier (dBm)} - \text{ERP of spurious/harmonic emission (dBm)}$$

5.10.3. Test Equipment List

Test Instruments	Manufacturer	Model No.	Serial No.	Frequency Range
Spectrum Analyzer/ EMI Receiver	Rohde & Schwarz	FSEK20/B4/B21	834157/005	9 kHz – 40 GHz with external mixer
RF Amplifier	Com-Power	PA-102		1 MHz to 1 GHz, 30 dB gain nominal
Microwave Amplifier	Hewlett Packard	HP 8449B	300BA00769	1 GHz to 26.5 GHz, 30 dB nominal
Biconilog Antenna	EMCO	3142	10005	30 MHz to 2 GHz
Dipole Antenna	EMCO	3121C	8907-434	30 GHz – 1 GHz
Horn Antenna	EMCO	3155	9911-5955	1 GHz – 18 GHz
Horn Antenna	EMCO	3160-09	1007	18 GHz – 26.5 GHz
Horn Antenna		RA28-K-T-4B-C	920311-001	26.5 GHz – 40 GHz
RF Signal Generator	Hewlett Packard	HP 83752B	3610A00457	0.01 – 20 GHz

5.10.4. Test Data

5.10.4.1. Near Lowest Frequency (3650 MHz)

Fundamental Frequency:		3650 MHz					
RF Output Power:		29.7 dBm					
Test Frequency Range:		30 MHz – 36.5 GHz					
Frequency (MHz)	E-Field (dB μ V/m)	EMI Detector (Peak/QP)	Antenna Polarization (H/V)	ERP measured by Substitution Method (dBm) (dBc)		Limit (dBm)	Margin (dB)
7300	67.46	Peak	V	-30.4	60.1	-13.0	-17.4
7300	72.75	Peak	H	-25.1	54.8	-13.0	-12.1

All other emissions are more than 20 dB below the limit.

5.10.4.2. Near Middle Frequency (3662.5 MHz)

Fundamental Frequency:		3662.5 MHz					
RF Output Power:		29.6 dBm					
Test Frequency Range:		30 MHz – 36.65 GHz					
Frequency (MHz)	E-Field (dB μ V/m)	EMI Detector (Peak/QP)	Antenna Polarization (H/V)	ERP measured by Substitution Method (dBm) (dBc)		Limit (dBm)	Margin (dB)
7325	64.41	Peak	V	-33.4	63.0	-13.0	-20.4
7325	65.77	Peak	H	-32.0	61.6	-13.0	-19.0

All other emissions are more than 20 dB below the limit.

5.10.4.3. Near Highest Frequency (3675 MHz)

Fundamental Frequency:		3675 MHz					
RF Output Power:		29.3 dBm					
Test Frequency Range:		30 MHz – 37 GHz					
Frequency (MHz)	E-Field (dB μ V/m)	EMI Detector (Peak/QP)	Antenna Polarization (H/V)	ERP measured by Substitution Method (dBm) (dBc)		Limit (dBm)	Margin (dB)
7350	65.95	Peak	V	-32.7	62.0	-13.0	-19.7
7350	65.53	Peak	H	-33.1	62.4	-13.0	-20.1

All other emissions are more than 20 dB below the limit.

EXHIBIT 6. MEASUREMENT UNCERTAINTY

The measurement uncertainties stated were calculated in accordance with the requirements of NIST Technical Note 1297 and NIS 81 (1994)

6.1. RADIATED EMISSION MEASUREMENT UNCERTAINTY

CONTRIBUTION (Radiated Emissions)	PROBABILITY DISTRIBUTION	UNCERTAINTY (\pm dB)	
		3 m	10 m
Antenna Factor Calibration	Normal (k=2)	± 1.0	± 1.0
Cable Loss Calibration	Normal (k=2)	± 0.3	± 0.5
EMI Receiver specification	Rectangular	± 1.5	± 1.5
Antenna Directivity	Rectangular	+0.5	+0.5
Antenna factor variation with height	Rectangular	± 2.0	± 0.5
Antenna phase center variation	Rectangular	0.0	± 0.2
Antenna factor frequency interpolation	Rectangular	± 0.25	± 0.25
Measurement distance variation	Rectangular	± 0.6	± 0.4
Site imperfections	Rectangular	± 2.0	± 2.0
Mismatch: Receiver VRC $\Gamma_1 = 0.2$ Antenna VRC $\Gamma_R = 0.67(Bi) 0.3 (Lp)$ Uncertainty limits $20\text{Log}(1 \pm \Gamma_1 \Gamma_R)$	U-Shaped	+1.1 -1.25	± 0.5
System repeatability	Std. Deviation	± 0.5	± 0.5
Repeatability of EUT		-	-
Combined standard uncertainty	Normal	+2.19 / -2.21	+1.74 / -1.72
Expanded uncertainty U	Normal (k=2)	+4.38 / -4.42	+3.48 / -3.44

Calculation for maximum uncertainty when 3m biconical antenna including a factor of k=2 is used:

$$U = 2u_c(y) = 2x(+2.19) = +4.38 \text{ dB} \quad \text{And} \quad U = 2u_c(y) = 2x(-2.21) = -4.42 \text{ dB}$$

EXHIBIT 7. MEASUREMENT METHODS

7.1. MEASURING THE EIRP OF SPURIOUS/HARMONIC EMISSIONS USING SUBSTITUTION METHOD:

- (a) Set the EMI Receiver (for measuring E-Field) and Receiver #2 (for measuring EIRP) as follows:

Center Frequency: equal to the signal source
Resolution BW: 10 kHz
Video BW: same
Detector Mode: positive
Average: off
Span: 3 x the signal bandwidth

- (b) Load an appropriate correction factors file in EMI Receiver for correcting the field strength reading level

Total Correction Factor recorded in the EMI Receiver = Cable Loss + Antenna Factor
E (dBuV/m) = Reading (dBuV) + Total Correction Factor (dB/m)

- (c) Select the frequency and E-field levels obtained in the Section 7.2.1 for ERP/EIRP measurements.
(d) Substitute the EUT by a signal generator and one of the following transmitting antenna (substitution antenna):
♦ DIPOLE antenna for frequency from 30-1000 MHz or
♦ HORN antenna for frequency above 1 GHz }.
(e) Mount the transmitting antenna at 1.5 meter high from the ground plane.
(f) Use one of the following antenna as a receiving antenna:
♦ DIPOLE antenna for frequency from 30-1000 MHz or
♦ HORN antenna for frequency above 1 GHz }.
(g) If the DIPOLE antenna is used, tune it's elements to the frequency as specified in the calibration manual.
(h) Adjust both transmitting and receiving antenna in a VERTICAL polarization.
(i) Tune the EMI Receivers to the test frequency.
(j) Lower or raise the test antenna from 1 to 4 meters until the maximum signal level was detected.
(k) The transmitter was rotated through 360° about a vertical axis until a higher maximum signal was received.
(l) Lower or raise the test antenna from 1 to 4 meters until the maximum signal level was detected.
(m) Adjust input signal to the substitution antenna until an equal or a known related level to that detected from the transmitter was obtained in the test receiver.
(n) Record the power level read from the Average Power Meter and calculate the ERP/EIRP as follows:

$$P = P1 - L1 = (P2 + L2) - L1 = P3 + A + L2 - L1$$

$$EIRP = P + G1 = P3 + L2 - L1 + A + G1$$

$$ERP = EIRP - 2.15 \text{ dB}$$

$$\text{Total Correction factor in EMI Receiver \# 2} = L2 - L1 + G1$$

Where: P: Actual RF Power fed into the substitution antenna port after corrected.
P1: Power output from the signal generator
P2: Power measured at attenuator A input
P3: Power reading on the Average Power Meter
EIRP: EIRP after correction
ERP: ERP after correction

- (o) Adjust both transmitting and receiving antenna in a HORIZONTAL polarization, then repeat step (k) to (o)
(p) Repeat step (d) to (o) for different test frequency
(q) Repeat steps (c) to (j) with the substitution antenna oriented in horizontal polarization.
(r) Actual gain of the EUT's antenna is the difference of the measured EIRP and measured RF power at the RF port. Correct the antenna gain if necessary.:

Figure 1

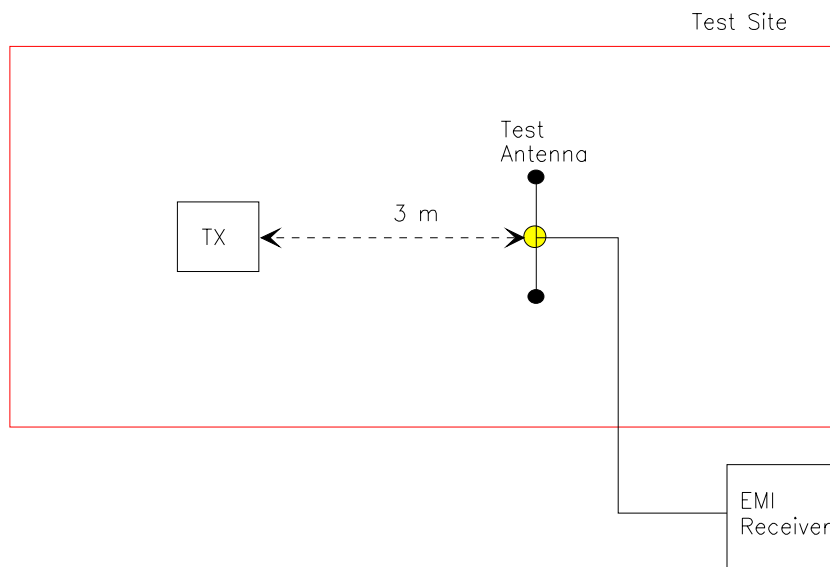
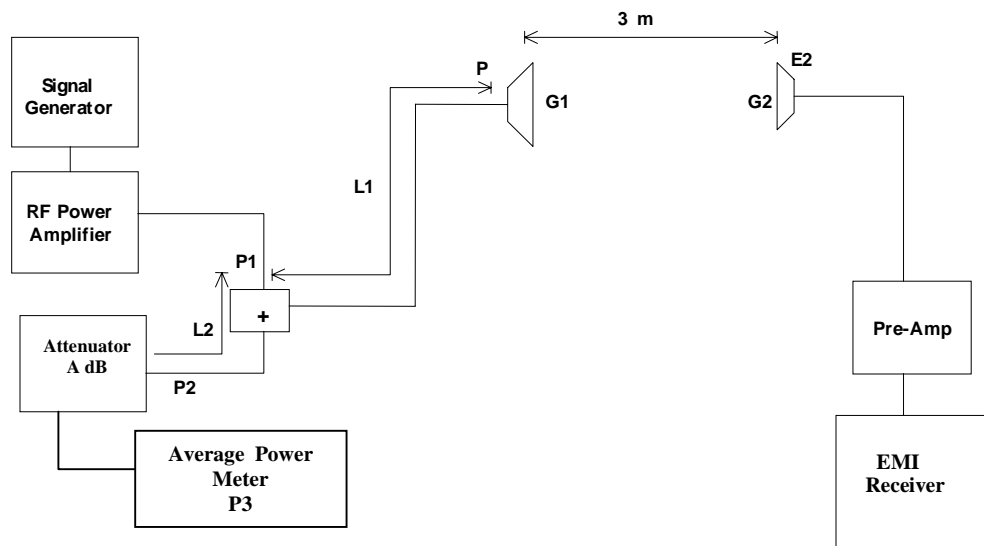

Figure 2



7.2. FREQUENCY STABILITY

Refer to FCC @ 2.1055.

- (a) The frequency stability shall be measured with variation of ambient temperature as follows: From -30 to +50 centigrade except that specified in subparagraph (2) & (3) of this paragraph.
- (b) Frequency measurements shall be made at extremes of the specified temperature range and at intervals of not more than 10 centigrade through the range. A period of time sufficient to stabilize all of the components of the oscillator circuit at each temperature level shall be allowed prior to frequency measurement. The short-term transient effects on the frequency of the transmitter due to keying (except for broadcast transmitters) and any heating element cycling normally occurring at each ambient temperature level also shall be shown. Only the portion or portions of the transmitter containing the frequency determining and stability circuitry need be subjected to the temperature variation test.
- (d) The frequency stability supply shall be measured with variation of primary supply voltage as follows:
 - (1) Vary primary supply voltage from 85 to 115 percent of the nominal value for other than hand carried battery equipment.
 - (2) For hand carried, battery powered equipment, reduce primary supply voltage to the battery operating end point which shall be specified by the manufacturer.
 - (3) The supply voltage shall be measured at the input to the cable normally provide with the equipment, or at the power supply terminals if cables are not normally provided. Effects on frequency of transmitter keying (except for broadcast transmitters) and any heating element cycling at the nominal supply voltage and at each extreme also shall be shown.
- (e) When deemed necessary, the Commission may require tests of frequency stability under conditions in addition to those specifically set out in paragraphs (a), (b), (c) and (d) of this section. (For example, measurements showing the effect of proximity to large metal objects, or of various types of antennas, may be required for portable equipment).