



RedMAX™



Indoor Wireless Access Subscriber Modem

User Manual

Copyright Information

All rights reserved May 12, 2008. The information in this document is proprietary to Redline Communications Inc. This document may not in whole or in part be copied, reproduced, or reduced to any medium without prior consent, in writing, from Redline Communications Incorporated.

Contact Information:

Redline Communications Inc.
302 Town Centre Blvd. Suite 100
Markham, ON
Canada L3R 0E8

Web site: <http://www.redlinecommunications.com>

Sales Inquiries:

North American nainfo@redlinecommunications.com
Toll-free sales 1-866-633-6669
International intlinfo@redlinecommunications.com

Support: www.redlinecommunications.com/support/support_portal.html

Document Control:

70-00078-01-00-RedMAX_Subscriber_Indoor_SU-I_UserManual-FCC-20080512a.doc

Disclaimer

The statements, configurations, technical data, and recommendations in this document are believed to be accurate and reliable, but are presented without express or implied warranty. Additionally, Redline makes no representations or warranties, either expressed or implied, regarding the contents of this product. Redline Communications shall not be liable for any misuse regarding this product. The information in this document is subject to change without notice.

TABLE OF CONTENTS

1	Important Safety Notices	6
1.1	Safety Warnings	6
1.2	Important Warning Symbols	6
1.3	FCC Notice	7
1.4	FCC Certified Antenna	7
1.5	Frequency Selection.....	8
1.5.1	General.....	8
1.5.2	R&TTE Directive 1999/5/EC Statements.....	8
1.6	CSA Information	10
1.7	Information for Use in Canada	10
1.8	Important Service Information	10
1.9	WEEE Product Return Process.....	11
2	Overview	12
2.1	Features	13
2.1.1	IEEE 802.16 WiMAX Compliance	13
2.1.2	PHY Specification.....	13
2.1.3	Time Division Duplexing (TDD)	13
2.1.4	Coding Rate.....	13
2.1.5	Modulation	13
2.1.6	Reed Solomon Error Correction	14
2.2	Deployment Models.....	14
2.2.1	PMP Deployment.....	14
2.2.2	Non Line-of-Sight.....	14
2.2.3	Channelization.....	15
2.3	Service Flows	15
2.3.1	Service Flow Classification.....	15
2.3.2	Dynamic Service Addition.....	16
2.3.3	Uplink Service Flow Scheduling	16
2.3.4	Downlink Service Flow Scheduling.....	17
3	Indoor Unit Features	18
3.1	Indoor Subscriber with Integrated Antenna	18
3.2	LED Indicators.....	19
3.2.1	WiMAX / WAN Signal	19
3.2.2	LAN System.....	19
3.3	Indoor Subscriber Connections and Controls.....	20
3.3.1	Ethernet Port	20
3.3.2	Reset Switch.....	20
3.3.3	RF Port	21
3.3.4	Accessories	21
3.4	Antenna Alignment	22
4	CLI Commands	23
4.1	Introduction.....	23
4.2	CLI Modes	23

4.2.1	Telnet Connection	23
4.2.2	Root Commands.....	24
4.3	Mode Commands	25
4.3.1	boardConfig - Board Setup Commands	26
4.3.2	bsIdTable - Base Station ID Table Commands	27
4.3.3	diagStatistics - Diagnostic Statistics	28
4.3.4	ethTag - Ethernet Tagging.....	29
4.3.5	installedVer - Installed Version	30
4.3.6	ipAddress - IP Address Commands	31
4.3.7	loadImage - Download and Activate Software Image.....	32
4.3.8	modThresh - Modulation Threshold.....	32
4.3.9	monitor - Monitor Mode	34
4.3.10	phyConfig - Physical Layer Configuration	35
4.3.11	privacySS - Privacy Commands	36
4.3.12	reset - Reset Command	36
4.3.13	rfConfig - RF Setup Commands	37
4.3.14	set - Set Commands.....	39
4.3.15	show - Show Commands.....	40
4.3.16	softwareUpdate - Software Update Commands	41
4.3.17	status - Status Information.....	42
5	Appendices	43
5.1	System Technical Specifications.....	43
5.2	Subscriber Log Messages	44
5.3	Upgrade Subscriber	48
5.3.1	Before Beginning the Upgrade	48
5.3.2	Update Software Procedure	49

LIST OF FIGURES

Figure 1:	Notices - WEEE Logo	11
Figure 2:	Intro - RedMAX Subscriber Indoor Modem.....	12
Figure 3:	System - Fresnel Zone.....	14
Figure 4:	System - Non-Line of Sight Deployment.....	15
Figure 5:	Subscriber System Features.....	18
Figure 6:	Subscriber LED Display	19
Figure 7:	Subscriber System Connections - Power Connector	20
Figure 8:	Subscriber Ethernet Connector (Under Base)	20
Figure 9:	Subscriber Reset Switch (Under Base).....	20
Figure 10:	Subscriber RF Connector (Under Base)	21
Figure 11:	Subscriber Accessory Mounting Components	21
Figure 12:	Subscriber System Connections Diagram	22
Figure 13:	Subscriber CLI Interface - Login Dialog	24

LIST OF TABLES

Table 1: FCC Approved Subscriber Antennas and Settings	7
Table 2: Notices - R&TTE: Countries of Use (3.4 GHz & 3.6 GHz)	8
Table 3: R&TTE - Community Language CE Declarations	9
Table 4: System - Indoor CPE WAN LEDs	19
Table 5: System - Indoor CPE WAN LEDs - Signal Strength.....	19
Table 6: System - LAN LEDs	19
Table 7: CLI - Command Groups	23
Table 8: CLI - Root Mode Commands	24
Table 9: CLI - Root Mode Commands	25
Table 10: CLI - boardConfig - Board Commands.....	26
Table 11: CLI - bsldTable - Base Station ID Commands	27
Table 12: CLI - diagStatistics - Diagnostic Statistics Commands.....	28
Table 13: CLI - ethTag - Ethernet Tagging Commands	29
Table 14: CLI - installedVer - Installed Version Commands.....	30
Table 15: CLI - ipAddress - IP Address Commands	31
Table 16: CLI - modThresh - Modulation Threshold Commands	32
Table 17: CLI - monitor - Monitor Mode	34
Table 18: CLI - phyConfig - Physical Layer Commands	35
Table 19: CLI - privacySS - Privacy Commands	36
Table 20: CLI - reset - Reset Commands	36
Table 21: CLI - rfConfig - Radio Frequency Commands.....	37
Table 22: CLI - set - Modify Subscriber Parameters	39
Table 23: CLI - show - Show Commands	40
Table 24: CLI - softwareUpdate - Software Update Commands	41
Table 25: CLI - status - Status Commands	42
Table 26: Specifications - Indoor Wireless Subscriber Modem.....	43
Table 27: Troubleshooting - Event Log Messages.....	44

1 Important Safety Notices

Models This manual covers the SU-IIR (SU-I) indoor wireless subscriber.

1.1 Safety Warnings

1. Do not exceed the described limits on product labels.
2. Position power cords to avoid damage.
3. Use only properly grounded power receptacles.
4. Do not overload wall outlets.
5. Do not place equipment on or near a direct heat source or operate near water or in a wet location.
6. Disconnect power before cleaning and use only a damp cloth for cleaning (no liquid / aerosol cleaners).
7. Disconnect power when product is not in use.
8. It is the user's responsibility to install this device in accordance with the local electrical and building codes.
9. Refer to the subscriber User Manual for a complete description of safety notices and regulatory information for this product.

Attention:

The SU-I front grill is used to dissipate heat and may feel quite warm during normal operation. Avoid direct contact with this feature when handling the SU-I.

1.2 Important Warning Symbols

The following symbols may be encountered during installation or troubleshooting. These warning symbols mean danger. Bodily injury may result if you are not aware of the safety hazards involved in working with electrical equipment and radio transmitters. Familiarize yourself with standard safety practices before continuing.



Electro-Magnetic Radiation



High Voltage

1.3 FCC Notice

1. The Model SUIR (SU-I) must be professionally installed.
2.  WARNING -- FCC RF Exposure Warnings
 To satisfy FCC RF exposure requirements for RF transmitting devices, a minimum distance of 20 cm should be maintained between this device and persons during device operation. To ensure compliance, operation at closer than this distance is not recommended. The antenna used for this device must not be collocated in conjunction with any other antenna or transmitter.
3. Operation is restricted to the 25 MHz band 3.650-3.675 GHz (restricted contention based protocol for WiMAX devices).
4. FCC Information to Users @ FCC 15.21 & 15.105:
 This equipment has been tested and found to comply with the limits for a Class A digital device, pursuant to Part 15 of the FCC Rules. These limits are designed to provide reasonable protection against harmful interference when the equipment is operated in a commercial environment. This equipment generates, uses, and can radiate radio frequency energy and, if not installed and used in accordance with the instruction manual, may cause harmful interference to radio communications.
5. Warning: Changes or modifications not expressly approved by Redline Communications could void the user's authority to operate the equipment.
6. Refer to section 1.4: FCC Certified Antenna on page 7 for a list of certified antennas.

1.4 FCC Certified Antenna

This device has been designed to operate only with the integrated antenna, having a maximum peak gain of 10.5 dBi. The configuration command 'rfConfig' (TxFixedPower field) listed below will limit the EIRP at any time to 1W/1MHz (30 dBm). The use of external antennas is strictly prohibited for use with this device. The required antenna impedance is 50 ohms.

Table 1: FCC Approved Subscriber Antennas and Settings				
Description	Beam Width (Deg.)	TxFixedPower Setting (dBm) for 3.5 MHz Channel	TxFixedPower Setting (dBm) for 7 MHz Channel	Frequency Range (GHz)
Integrated (10.5 dBi)	72	+3	+6	3.650-3.675

1.5 Frequency Selection

1.5.1 General

Operation in the FWA band is subject to license. The radio power and channel frequency selections must be set correctly before the installed system is allowed to transmit. The installed system must comply with all governing local, regional, and national regulations. Contact authorities in the country of installation for complete information regarding the licensing regime and operating restrictions for that regulatory domain.

1.5.2 R&TTE Directive 1999/5/EC Statements

Installation

The transceiver and antenna equipment must be installed by a qualified professional installer and must be installed in compliance with regional, national, and local regulations. It is the responsibility of the system installer and/or system operator to ensure the installed system does not exceed any operational constraints identified by local regulations. Refer to the sections in this product User Guide for detailed information about the correct installation steps to ensure power and frequency settings are set correctly before connecting the antenna. Operation in the 3.4-3.6 GHz band is subject to license. Authorities within the country of installation can provide information regarding the licensing regime and restrictions.

Community Language Declarations

Table 2: Notices - R&TTE: Countries of Use (3.4 GHz & 3.6 GHz)					
Country	3400-3600 MHz	Country	3400-3600 MHz	Country	3400-3600 MHz
Austria	✓	Hungary	✓	Poland	✓
Belgium	✓	Iceland	✓	Portugal	✓
Bulgaria	✓	Ireland	✓	Romania	✓
Cyprus		Italy		Slovakia	✓
Czech Republic	✓	Latvia	✓	Slovenia	✓
Denmark	✓	Liechtenstein	✓	Spain	✓
Estonia	✓	Lithuania	✓	Sweden	✓
Finland	✓	Luxembourg	✓	Switzerland	✓
France	✓	Malta	✓	United Kingdom	✓
Germany	✓	Netherlands	✓		
Greece	✓	Norway	✓		

R&TTE Directive 1999/5/EC - Declarations of conformity are available at the following web site address:

<http://www.redlinecommunications.com/conformance/>

The following table contains community language versions of informal statement in accordance with Article 6.3 of Directive 1999/5/EC.

Table 3: R&TTE - Community Language CE Declarations	
Community language versions of informal statement for inclusion in user information in accordance with Article 6.3 of Directive 1999/5/EC	
Danish	Undertegnede Redline Communications erklærer herved, at følgende udstyr subscriber overholder de væsentlige krav og øvrige relevante krav i direktiv 1999/5/EF
Dutch	Hierbij verklaart Redline Communications dat het toestel subscriber in overeenstemming is met de essentiële eisen en de andere relevante bepalingen van richtlijn 1999/5/EG
	Bij deze verklaart Redline Communications dat deze subscriber voldoet aan de essentiële eisen en aan de overige relevante bepalingen van Richtlijn 1999/5/EC.
English	Hereby, Redline Communications, declares that this subscriber is in compliance with the essential requirements and other relevant provisions of Directive 1999/5/EC.
Finnish	Redline Communications vakuuttaa täten että subscriber tyyppinen laite on direktiivin 1999/5/EY oleellisten vaatimusten ja sitä koskevien direktiivin muiden ehtojen mukainen.
French	Par la présente Redline Communications déclare que l'appareil subscriber est conforme aux exigences essentielles et aux autres dispositions pertinentes de la directive 1999/5/CE
	Par la présente, Redline Communications déclare que ce subscriber est conforme aux exigences essentielles et aux autres dispositions de la directive 1999/5/CE qui lui sont applicables
German	Hiermit erklärt Redline Communications, dass sich <i>dieser/diese/dieses</i> subscriber in Übereinstimmung mit den grundlegenden Anforderungen und den anderen relevanten Vorschriften der Richtlinie 1999/5/EG befindet". (BMWi)
	Hiermit erklärt Redline Communications die Übereinstimmung des Gerätes subscriber mit den grundlegenden Anforderungen und den anderen relevanten Festlegungen der Richtlinie 1999/5/EG. (Wien)
Greek	<i>ΜΕ ΤΗΝ ΠΑΡΟΥΣΑ Redline Communications ΔΗΛΩΝΕΙ ΟΤΙ subscriber ΣΥΜΜΟΡΦΩΝΕΤΑΙ ΠΡΟΣ ΤΙΣ ΟΥΣΙΩΔΕΙΣ ΑΠΑΙΤΗΣΕΙΣ ΚΑΙ ΤΙΣ ΛΟΙΠΕΣ ΣΧΕΤΙΚΕΣ ΔΙΑΤΑΞΕΙΣ ΤΗΣ ΟΔΗΓΙΑΣ 1999/5/ΕΚ</i>
Italian	Con la presente Redline Communications dichiara che questo subscriber è conforme ai requisiti essenziali ed alle altre disposizioni pertinenti stabilite dalla direttiva 1999/5/CE.
Portuguese	Redline Communications declara que este subscriber está conforme com os requisitos essenciais e outras provisões da Directiva 1999/5/CE.
Spanish	Por medio de la presente Redline Communications declara que el subscriber cumple con los requisitos esenciales y cualesquiera otras disposiciones aplicables o exigibles de la Directiva 1999/5/CE
Swedish	Härmed intygar Redline Communications att denna subscriber står i överensstämmelse med de väsentliga egenskapskrav och övriga relevanta bestämmelser som framgår av direktiv 1999/5/EG.

1.6 CSA Information

1. The equipment must be properly grounded according with NEC, ICEC, CEC, and others, and other local safety code and building code requirements.
2. To meet the over-voltage safety requirements on the telecommunications cables, a minimum 26 AWG telecommunication line cord must be used.
Pour être en conformité avec les exigences finies de sûreté de sur-tension sur les câbles de télécommunications un fil de télécommunication ayant un calibre minimum de 26 AWG doit être utilisé.

1.7 Information for Use in Canada

Operation is subject to the following two conditions:

1. This device may not cause interference, and
2. This device must accept any interference, including interference that may cause undesired operation of the device.

Usage of this subscriber modem is subject to license within Canada. Operation is restricted to the 200 MHz band from 3.450-3.650 GHz. More information regarding licensing requirements is available from Industry Canada (www.ic.gc.ca).

This device has been designed to operate only with an integrated antenna having a maximum gain of 10.5 dBi. Use of antennas having a higher gain is strictly prohibited per regulations of Industry Canada. The required antenna impedance is 50 ohms.

IMPORTANT NOTE: IC Radiation Exposure Statement

This equipment complies with IC radiation exposure limits set forth for an uncontrolled environment. End users must follow the specific operating instructions for satisfying RF exposure compliance. To maintain compliance with IC RF exposure compliance requirements, please avoid direct contact to the transmitting antenna during transmitting.

This transmitter must not be co-located or operating in conjunction with any other antenna or transmitter.

SU-IIR (SU-I with integrated antenna): A separation distance of 20 cm or more should be maintained between the antenna of this device and persons during device operation.

1.8 Important Service Information

1. Refer all repairs to qualified service personnel. Do not remove the covers or modify any part of this device, as this voids the warranty.
2. Disconnect the power to this product and return it for service if the following conditions apply:
 - a) The unit does not function after following the operating instructions outlined in this manual.
 - b) Liquid has been spilled or a foreign object is inside.
 - c) The product has been dropped or the housing is damaged.
3. Record the serial number on your registration card for future reference.

1.9 WEEE Product Return Process

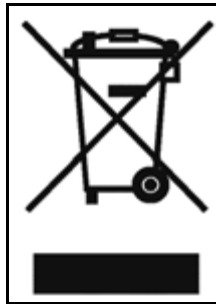

Figure 1: Notices - WEEE Logo

In accordance with the WEEE (Waste from Electrical and Electronic Equipment) directive, 2002/96/EC, Redline Communications equipment is marked with the logo shown above. The WEEE directive seeks to increase recycling and re-use of electrical and electronic equipment. This symbol indicates that this product should not be disposed of as part of the local municipal waste program. Contact your local sales representative for additional information.

2 Overview

Congratulations on your purchase of the Redline WiMAX subscriber wireless broadband product. Redline Communications is a world leader in design and production of WiMAX and proprietary Broadband Fixed Wireless (BFW) systems.

The indoor subscriber modem is carrier class high-speed IEEE 802.16-2004 WiMAX compliant for and point-to-multipoint (PMP) deployment.



Figure 2: Intro - RedMAX Subscriber Indoor Modem

2.1 Features

2.1.1 IEEE 802.16 WiMAX Compliance

The IEEE 802.16-2004 specifications describe a PMP broadband wireless access standard for systems operating in the frequency range of 2-11 GHz, and 10-66 GHz. This standard includes descriptions for both the Media Access Control (MAC) and the physical (PHY) layers. Note that the 802.16-2004 standards are subject to amendment, and the subscriber product design compliance applies to a specific revision of the standard. The outdoor subscriber product does not support mesh communication (direct subscriber-to-subscriber).

Redline is an active member of the WiMAX Forum™ and is participating in interoperability testing in the WiMAX Forum. Redline is also an active member of the IEEE 802.16-2004 standards committee and has been instrumental in creating the original 802.16-2004 standards, and is active in recommending, writing and following-up work on new amendments to the 802.16-2004 specifications.

2.1.2 PHY Specification

The subscriber system is designed for 2-11 GHz operation based on the WirelessMAN-OFDM PHY definition in the IEEE 802.16-2004 specifications. The subscriber uses Orthogonal Frequency Division Multiplexing (OFDM). OFDM is a multi-carrier transmission technique where the data stream is split and transmitted (at a reduced rate) in parallel streams on separate sub-carriers. OFDM uses the Fast Fourier Transform (FFT) algorithm to implement modulation and demodulation functions. Using adequate channel coding and bit-interleaving, OFDM performs very well in severe multipath environments, mitigates frequency-selective fading, and provides high spectral efficiency.

2.1.3 Time Division Duplexing (TDD)

The subscriber system uses time division duplexing (TDD) to transmit and receive on the same RF channel. The subscriber can also transmit and receive using separate RF channels, referred to as half-duplex FDD (HD-FDD). These are both non-contention based methods for providing an efficient and predictable two-way PTP or PMP cell deployment. All uplink and downlink transmission scheduling is managed by the WiMAX base station. The base station sends data traffic to subscribers, polls for grant requests, and sends grant acknowledgements based on the total of all traffic to all subscribers.

2.1.4 Coding Rate

Each burst of data transmitted over the air is padded with redundant information to make it resistant to errors introduced during transmission. The coding rate is the ratio of user data to the total data transmitted including the redundant error correction data. The subscriber supports coding rates of 1/2, 2/3, and 3/4.

2.1.5 Modulation

The modulation technique specifies how the data is coded within the OFDM carriers. The subscriber supports BPSK, QPSK, 16 QAM, and 64 QAM modulation.

2.1.6 Reed Solomon Error Correction

Outer Reed-Solomon and inward Convolution Coding (RS-CC) error correction is enabled for all traffic rates, with the exception of BPSK 1/2 where only inward Convolution Coding is used. These low-level processes can correct bursts of errors in received messages and reduce the number of retransmissions.

2.2 Deployment Models

The subscriber supports point to multipoint (PMP) deployment scenarios.

2.2.1 PMP Deployment

When deployed in a PMP configuration the base station establishes bi-directional links to more than one subscriber. The PMP deployments typically use a wide beam (sector) antenna at the base station and a narrow beam antenna at the subscriber. Service flows are used to police service level agreements for each subscriber.

2.2.2 Non Line-of-Sight

The subscriber system supports line-of-sight (LOS), optical line-of-sight (OLOS), and non line-of-sight (NLOS) operation. A clear LOS link has no obstacles within 60% of the first Fresnel zone of the direct path. An OLOS link has obstructions within 60% of the first Fresnel zone, but a visible path exists from the base station to the subscriber.

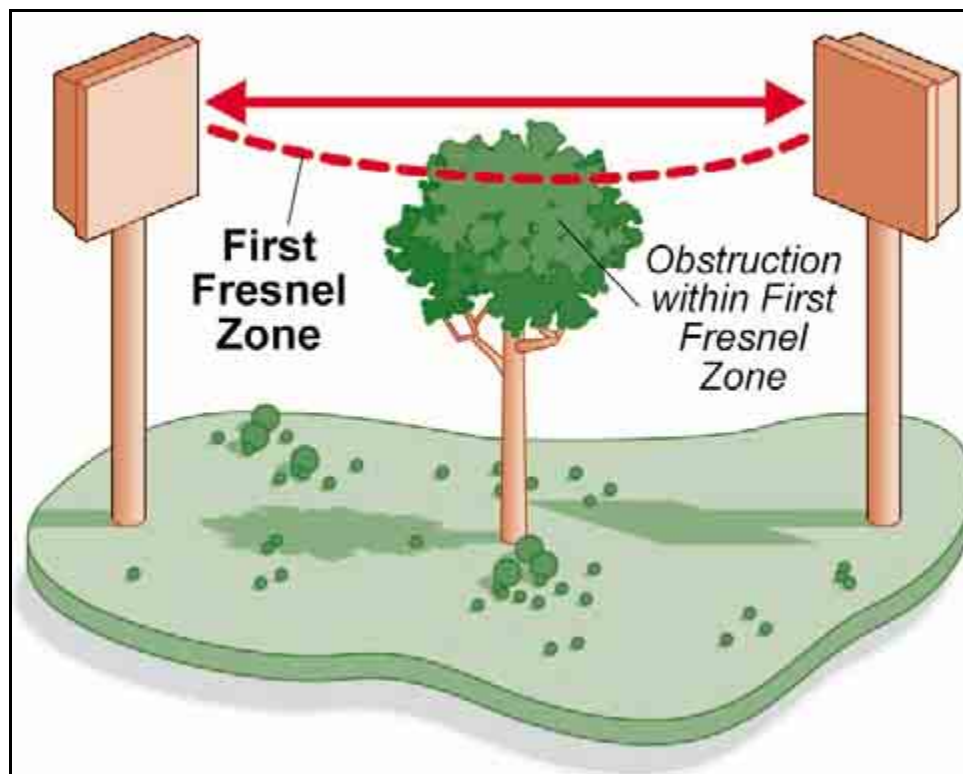

Figure 3: System - Fresnel Zone

A wireless link is considered non LOS if natural or man-made structures block the visible path between the base station and subscriber. In this case, a wireless link can be established only if a reflective path can be established between the base station and subscriber.

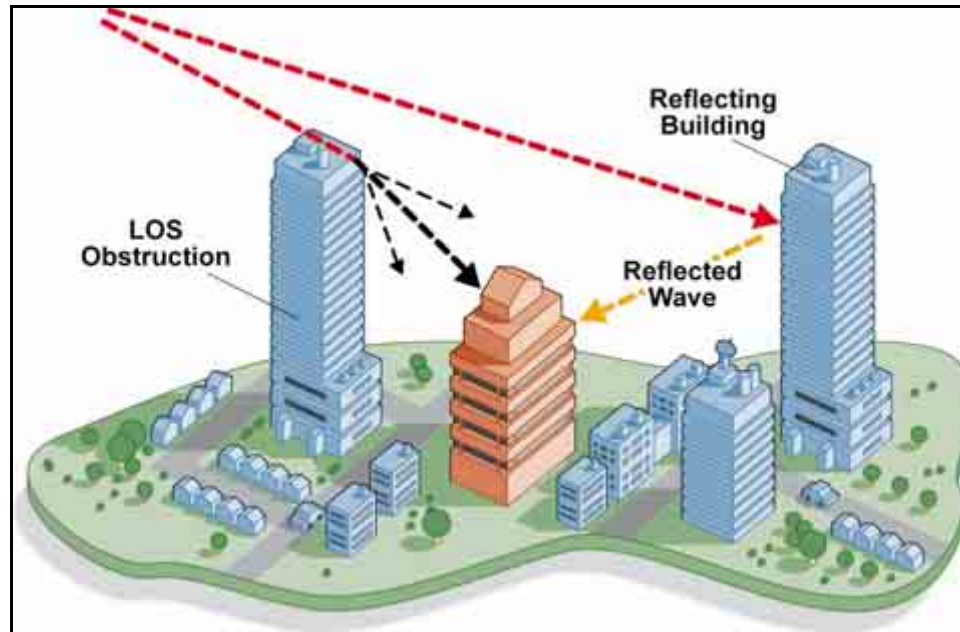

Figure 4: System - Non-Line of Sight Deployment

2.2.3 Channelization

The subscriber is a frequency-specific system, with the frequency band defined by the internal transceiver unit. The use of the operating band must be in accordance with European Conference of Postal and Telecommunications Administrations (CEPT) Recommendation 14-03.

The subscriber divides the available frequency band into channels. Allocation of channels during deployment is dependent on spectrum availability in the licensed FWA band (3400-3600 MHz) and local licensing requirements and conditions. Channel selection allows planners to obtain the maximum geographic coverage, while avoiding frequency contention in adjacent sectors.

2.3 Service Flows

Service flows are a key feature of the 802.16 standard. A Service Flow represents a unidirectional data flow having separate QoS settings for uplink and downlink. Service flows provide the ability to set up multiple connections to each subscriber in a sector.

Separate service flows can be established for uplink and downlink traffic, where each service flow is assigned a unique service level category and separate QoS settings. This feature allows segregation of high-speed/high-priority traffic from less time-critical flows.

2.3.1 Service Flow Classification

Data packets are forwarded by the subscriber based on classification rules. Classification rules require examining each packet for pattern matches such as destination address, source address, or VLAN tag. All classification is defined at the base station and the classification parameters are downloaded to the subscriber.

A service flow is partially characterized by the following attributes:

4. A 32-bit Service Flow ID (SFID) is assigned to all existing service flows. The SFID serves as the principal identifier for the Service Flow and has an associated direction.
5. A 16-bit Connection ID (CID) is associated with each active SFID (connection active).
6. A set of QoS parameters specifying the required resources. The principal resource is bandwidth, but the specification may also include latency requirements.
7. A set of QoS parameters defining the level of service being provided.

2.3.2 Dynamic Service Addition

Service flows are defined and stored in the base station. For each service flow to be established, the base station sends a setup message to the subscriber specifying the required set of QoS parameters. The subscriber responds to each request by accepting or rejecting the setup message.

A service flow may be pre-provisioned or can be dynamically created and deleted without service outage. This is useful for supporting multiple subscribers in a single sector. New subscribers can be added and existing subscribers can be removed or have service levels modified.

Setup messages are sent by the base station following any subscriber power-cycle, loss and recovery of the wireless link to a subscriber, or any service flow add/delete operation at the base station.

2.3.3 Uplink Service Flow Scheduling

The base station enforces QoS settings for each service flow by controlling all uplink and downlink traffic scheduling. This provides non-contention based traffic model with predictable transmission characteristics. By analyzing the aggregate requests of all subscribers, the base station ensures that uplink and downlink traffic conforms with the current service level agreements (SLAs). Centralized scheduling increases traffic predictability, eliminates contention, and provides maximum opportunity for reducing overhead.

Real-Time Polling Service (rt-PS)

The base station schedules a continuous regular series of transmit opportunities for the subscriber to send variable size data packets. The grant size is based on the current data transfer requirement. Typical applications include streaming MPEG video or VOIP with silence suppression. This is efficient for applications that have a real-time component and continuously changing bandwidth requirements.

Non-Real-Time Polling Service (nrt-PS)

The base station schedules regular transmit opportunities for the subscriber to send variable size data packets. Typical applications may include high bandwidth FTP. The polling period may typically be one second or less, even during periods of network congestion.

Best Effort (BE)

The base station schedules transmit opportunities for the subscriber to send traffic based on unused bandwidth after all higher level traffic scheduling requirements are serviced.

Typical applications may include Internet access and email. Best effort service flows can be assigned a priority of 0 to 7.

Unsolicited Grant Service (UGS)

The base station schedules a continuous series of transmit opportunities for the subscriber to send fixed size data packets. This schedule supports real-time applications including VoIP or TDM transport. The UGS pre-scheduled grants guarantee reserved bandwidth and reduce latency introduced by repetitive grant requests. The service flow will not transmit packets larger than nominal grant interval.

2.3.4 Downlink Service Flow Scheduling

The base station schedules downlink traffic on active service flows based on the minimum reserved data rate (CIR), traffic priority, and maximum latency.

3 Indoor Unit Features

Each operational RedMAX network is comprised of a (WiMAX compatible) base station and one or more subscriber units. The subscriber is connected to a remote Ethernet network and establishes a bi-directional data link with a designated base station.

3.1 Indoor Subscriber with Integrated Antenna

The subscriber is a fully integrated unit with a built-in antenna. The subscriber system includes:

- Subscriber with integrated antenna
- Indoor Power adapter with AC power cord (NA/UK/EU)
- Desktop Stand
- Universal mounting bracket



Figure 5: Subscriber System Features

3.2 LED Indicators

The subscriber features LED indicators to assist with installation and troubleshooting of the wireless interface and the Ethernet interface.

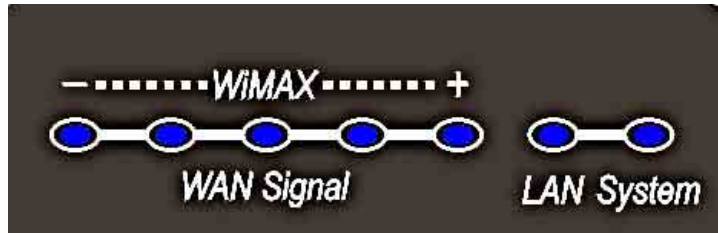

Figure 6: Subscriber LED Display

3.2.1 WiMAX / WAN Signal

The subscriber features five LEDs to indicate signal strength. If no signal or a weak signal is detected, only the left LED (-) will be lit. As signal strength increases, more LEDs will be lit. A strong signal is indicated by all LEDs being lit.

Table 4: System - Indoor CPE WAN LEDs		
Phase	Activity	Description
1	Power-on / Reset	Shortly after power-on or reset, all LEDs blink on for a short period and then turn off.
2	Frequency Scanning	All LEDs cycle on and off in a walking pattern.
3	Network Entry	While attempting to register with the wireless network, the number of LEDs blinking represent the received signal strength (see table below).
4	Subscriber is Registered	When registered with the wireless network, the number of LEDs blinking represent the received signal strength (see table below).

Table 5: System - Indoor CPE WAN LEDs - Signal Strength	
LED Indicators Lit	Signal Strength (RSSI) in dBm
5	< -45
4	-45 to -58.9
3	-58 to -75.3
2	-75 to -86.5

3.2.2 LAN System

The LAN LEDs indicate connectivity and activity on the Ethernet port. Refer to the following table for details.

Table 6: System - LAN LEDs	
Left LED	LED is on when the Ethernet port connection is active.
Right LED	LED blinks when there is Ethernet data traffic.

3.3 Indoor Subscriber Connections and Controls

All external connectors and controls are located on the bottom of the subscriber unit. Refer to the following sections for details.

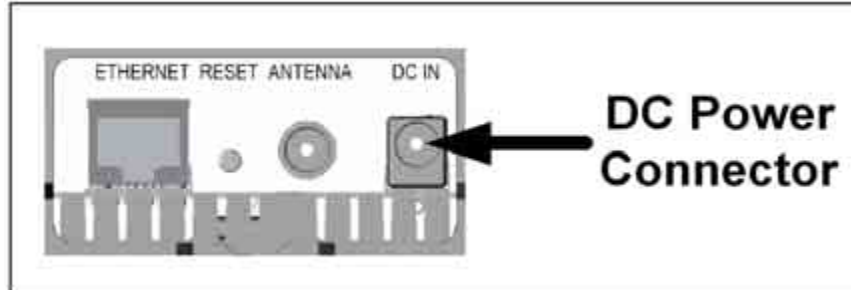

Figure 7: Subscriber System Connections - Power Connector

3.3.1 Ethernet Port

The auto-sensing 10/100Base-T Ethernet port connects through the Ethernet cable to the customer network equipment. The subscriber exchanges data with the network through this port (auto-sensing polarity). It is recommended to use a flexible Ethernet cable.

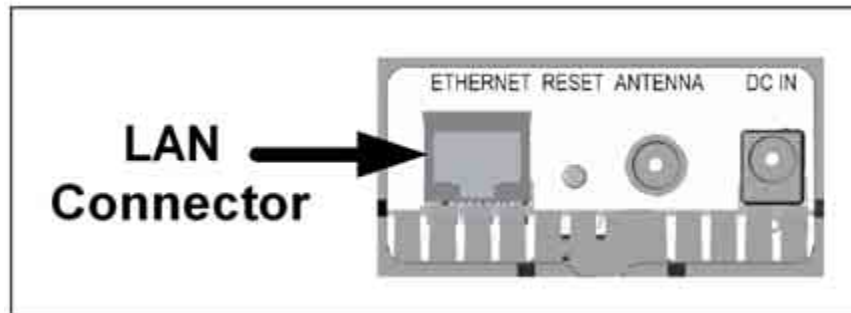

Figure 8: Subscriber Ethernet Connector (Under Base)

3.3.2 Reset Switch

The subscriber features a reset switch recessed in the bottom of the subscriber unit. You may require a narrow pointed item (ex. paper clip) to activate the reset switch.

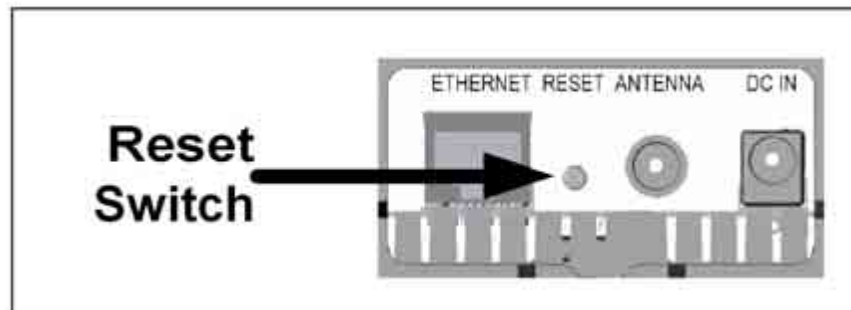

Figure 9: Subscriber Reset Switch (Under Base)

3.3.3 RF Port

An RF connector is provided for connection to the integrated antenna. The transceiver RF port is used for sending/receiving the RF signal to/from the integrated antenna. A short coaxial cable connects the transceiver to the integrated antenna.

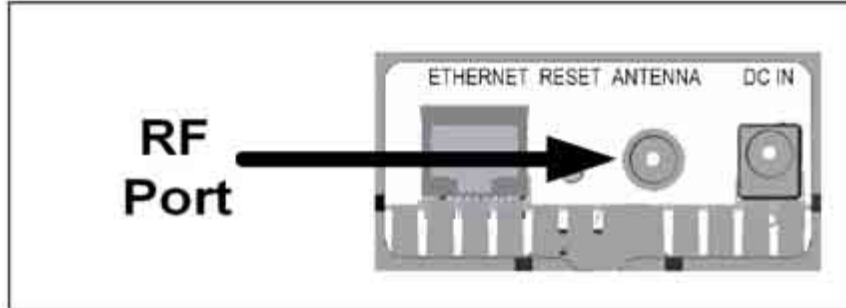

Figure 10: Subscriber RF Connector (Under Base)

3.3.4 Accessories

The subscriber is powered using the supplied auto-sensing 110-240 (nominal) VAC indoor power adapter. The power input connection is located on the bottom of the subscriber unit. The subscriber includes mounting options to accommodate desktop, windowsill, and wall mount.

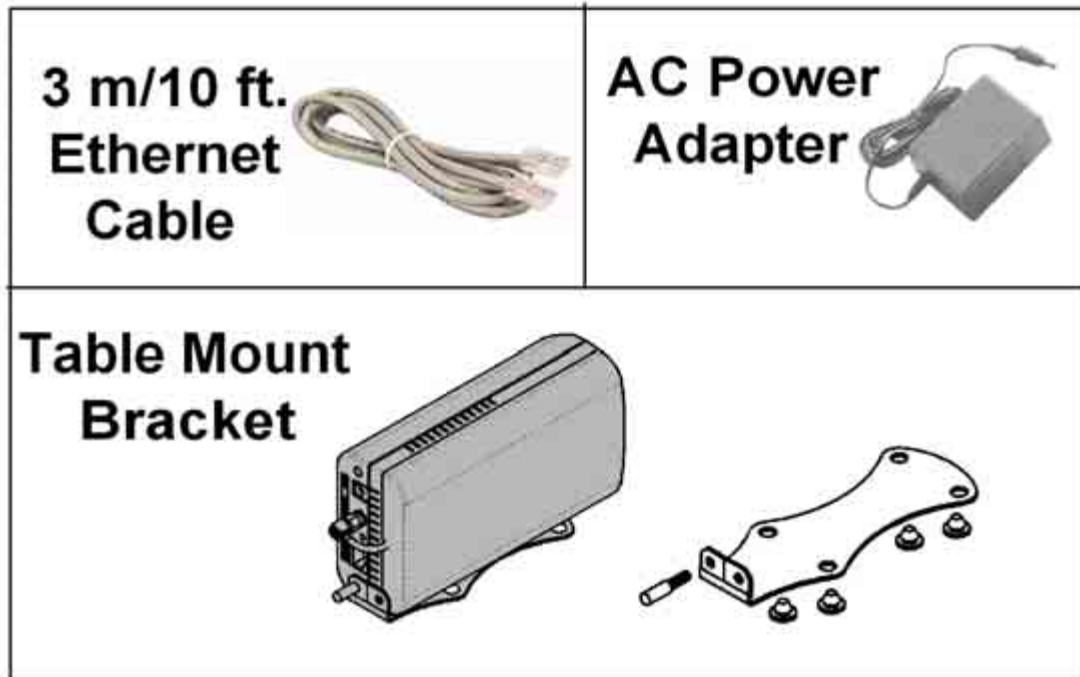

Figure 11: Subscriber Accessory Mounting Components

3.4 Antenna Alignment

Refer to the RedMAX Installation Guide (P/N: 70-00079) for detailed installation instructions.

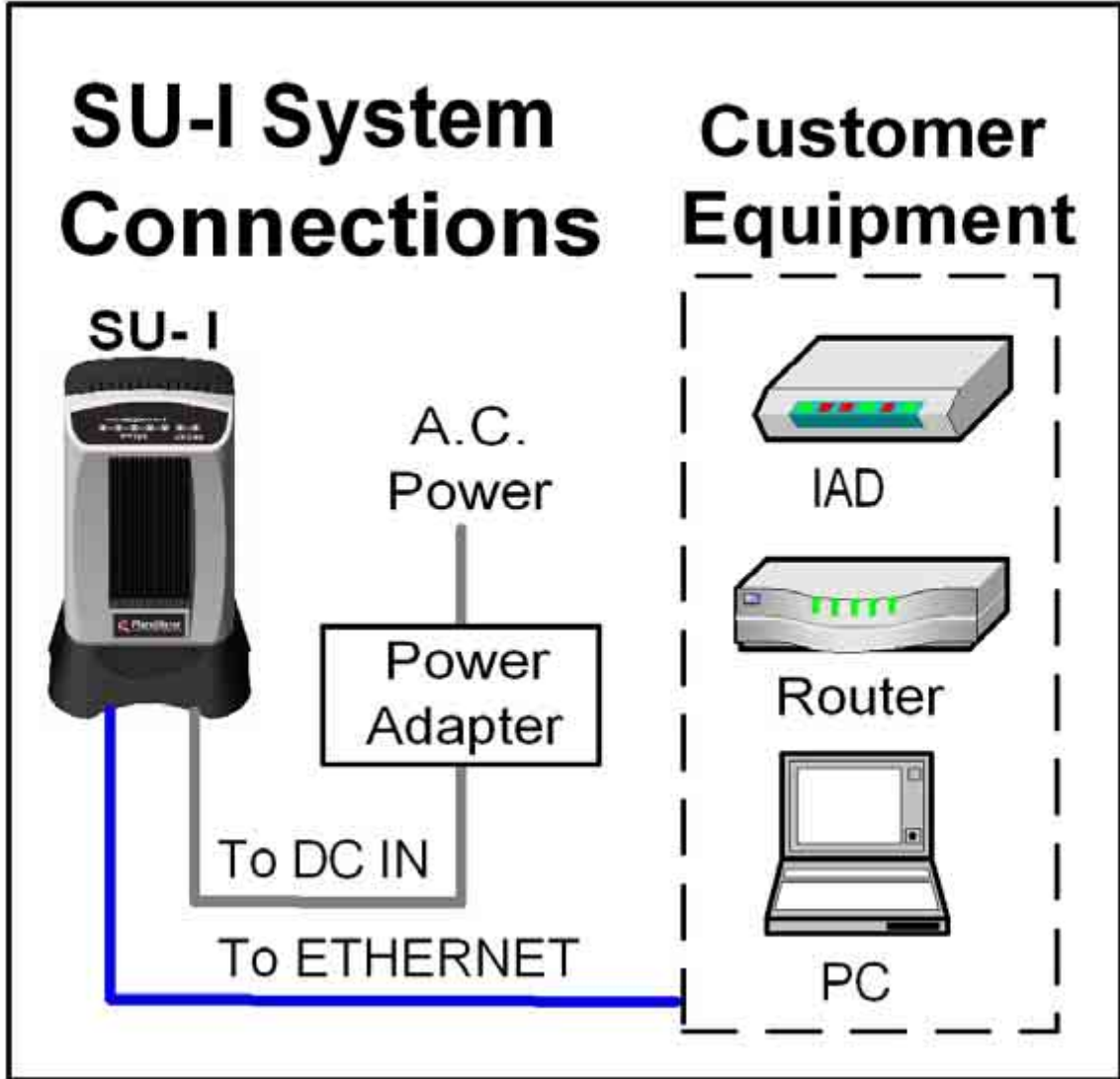

Figure 12: Subscriber System Connections Diagram

4 CLI Commands

This section describes the subscriber CLI commands.

Important: Access to these commands is password protected. Only authorized professional installation and service personnel are allowed access to these controls.

4.1 Introduction

The subscriber can be configured using a Telnet connection established through the subscriber Ethernet port or over the wireless interface from the base station. The CLI can not be used to setup service flows. All service flows will be setup by the base station.

4.2 CLI Modes

The subscriber CLI interface supports several modes of operation. From root mode you can display a list of all user modes, reboot the subscriber system, and logout from the Telnet session. Monitor mode provides a dynamic display of the current system statistics, updated each few seconds. Configuration modes allow you to view and adjust the subscriber network and wireless settings.

4.2.1 Telnet Connection

Telnet Login

Type 'telnet' followed by the IP address of the subscriber system, depress ENTER, and enter the account and password when prompted. The subscriber supports two separate user accounts:

Table 7: CLI - Command Groups		
Account	Password	Description
admin	admin	Full system control
user2	user2	Read-only with some functional restrictions (not allowed to use the 'set' command).
guest	guest	Same as user2.

Telnet Logout

To exit from the Telnet session, you must be in the root directory. Go to the root directory by typing:

Exit [ENTER] or CTRL-Z (hold down the CTRL key and depress Z)

Exit from a CLI session by typing:

logout [ENTER]

The system prompts for logout confirmation. Depress 'Y' to complete the logout process.

The system displays a welcome message when successfully logged in.

Figure 13: Subscriber CLI Interface - Login Dialog	
Login: admin	
Password: admin	
admin, welcome to the SS CLI. (Version 0.3)	
TIPS:	
- Press '?' immediately after current typing will auto complete the current parameter or command.	
- Press '?' one or more space afterwards will display available parameters or commands within the current context.	
- Enter 'help co' or 'help ed' to learn more about available system commands or editing hot-keys respectively !	
SUO#>	

4.2.2 Root Commands

The following CLI commands are common to all configuration modes.

Table 8: CLI - Root Mode Commands	
Command	Description
?	Use the '?' character as an alternative to typing 'help <ENTER>'. Example: Enter the following command string to list all parameters that can be changed using the 'set' command: set ?
Exit	Return to root mode.
help	Type 'help' alone to display the available commands. Type a command followed by 'help' to display a command set. <i>help <ENTER></i> <i>Help for all functions/fields.</i> <i>[field] help <ENTER></i> <i>Help for only the selected function/field.</i>
logout	Exit the current Telnet session.
collectRadio	Factory test only.
reboot	Reset the system. Confirmation is required.
shell	Factory test only.
CTRL-Z	Return to root mode.

4.3 Mode Commands

The system defaults to root mode when you login to the subscriber. The following table lists commands that have their own mode. From each mode, you can directly display and modify (if applicable) each of the modes parameters. Enter 'exit' or CTRL-Z to return to root mode. All commands are case-sensitive.

The following table lists mode commands available in the root directory.

Table 9: CLI - Root Mode Commands	
Command	Description
boardConfig	Display/modify the board parameter configuration.
bsIdTable	Access the Management Base Station ID table.
diagStatistics	Display/modify the Diagnostic Status.
ethTag	Display/modify the Ethernet Tagging.
installedVer	Display the installed software version(s).
ipAddress	Display/modify the IP address.
loadImage	Download and run a new software image.
modThresh	Display/modify thresholds for adaptive modulation.
monitor	Display dynamically updating values for all status table statistics.
phyConfig	Display/modify the PHY configuration.
privacySS	Display/modify privacy settings.
reset	Display/modify reset settings.
rfConfig	Display /modify the RF configuration.
set	Enter a new values for parameters.
show	Display current parameter settings.
softwareUpgrade	Upgrade software and select the active version.
status	Display the Management Status.

4.3.1 boardConfig - Board Setup Commands

The boardConfig mode allows you to view and modify the subscriber board level settings. The following table lists all commands available in this mode.

Table 10: CLI - boardConfig - Board Commands																													
Command	Description																												
reset	Set all parameters to factory default values. Confirmation required.																												
set	<p>Change parameter settings.</p> <p>RefOscFreq: Enter an unsigned integer as the new RefOscFreq value (Hz). Value can be only 32000000 or 40000000.</p> <p>TxIfFreq: Enter the TxIfFreq (Hz) value (around 44000000).</p> <p>RxIfFreq: Enter the RxIfFreq (Hz) value (around 44000000).</p> <p>RfType: Enter an unsigned char as the new RfType value. One of: 0 - None 1 - Radia 3.5 GHz 2 - Radia 5.8 GHz 3 - SMI 4 - Factory Test</p> <p>IfPresent: Enter an unsigned char as the new IfPresent value. 0 - Baseband only 1 - IF present</p> <p>TxSpectrumInv: Enter a boolean as the new TxSpectrumInv value.</p> <p>RxSpectrumInv: Enter a boolean as the new RxSpectrumInv value.</p> <p>Buzzer: Antenna positioning buzzer. 0 - Disabled 1 - Enabled.</p> <p>DebugLog: Factory debug messages. 0 - Disabled. 1- Enabled.</p>																												
show	<p>Display the current setting for all parameters. For example: <i>Structure --- <<SS Mmgt Board Configuration Parameter>></i></p> <table border="0"> <thead> <tr> <th><i>Transmit</i></th> <th><i>Receive</i></th> <th><i>Others</i></th> <th></th> </tr> <tr> <th>-----</th> <th>-----</th> <th>-----</th> <th></th> </tr> </thead> <tbody> <tr> <td><i>IfFreq:</i> 44000000Hz</td> <td><i>IfFreq:</i> 44000000Hz</td> <td><i>RefOscFreq:</i></td> <td>32000000Hz</td> </tr> <tr> <td><i>SpectrumInv:</i> disabled(0)</td> <td><i>SpectrumInv:</i> disabled(0)</td> <td><i>RfType:</i></td> <td>SMI(3)</td> </tr> <tr> <td></td> <td></td> <td><i>IfPresent:</i></td> <td>IF_Present(1)</td> </tr> <tr> <td></td> <td></td> <td><i>Buzzer:</i></td> <td>disabled(0)</td> </tr> <tr> <td></td> <td></td> <td><i>DebugLog:</i></td> <td>disabled(0)</td> </tr> </tbody> </table>	<i>Transmit</i>	<i>Receive</i>	<i>Others</i>		-----	-----	-----		<i>IfFreq:</i> 44000000Hz	<i>IfFreq:</i> 44000000Hz	<i>RefOscFreq:</i>	32000000Hz	<i>SpectrumInv:</i> disabled(0)	<i>SpectrumInv:</i> disabled(0)	<i>RfType:</i>	SMI(3)			<i>IfPresent:</i>	IF_Present(1)			<i>Buzzer:</i>	disabled(0)			<i>DebugLog:</i>	disabled(0)
<i>Transmit</i>	<i>Receive</i>	<i>Others</i>																											
-----	-----	-----																											
<i>IfFreq:</i> 44000000Hz	<i>IfFreq:</i> 44000000Hz	<i>RefOscFreq:</i>	32000000Hz																										
<i>SpectrumInv:</i> disabled(0)	<i>SpectrumInv:</i> disabled(0)	<i>RfType:</i>	SMI(3)																										
		<i>IfPresent:</i>	IF_Present(1)																										
		<i>Buzzer:</i>	disabled(0)																										
		<i>DebugLog:</i>	disabled(0)																										

4.3.2 bsIdTable - Base Station ID Table Commands

The bsIdTable includes the MAC addresses of up to sixteen base stations. The subscriber is authorized to register only with the base stations listed in this table. If this table is empty, the subscriber can register with any base station detected during the frequency scan (see rfConfig).

Table 11: CLI - bsIdTable - Base Station ID Commands	
Command	Description
add	<p>Add or modify a base station ID entry. The count value will be adjusted to reflect the current number of effective entries. If the table position value is not specified, the entry will be made following the last valid entry.</p> <p>BsId: The new entry of BsId value EntryNumber: The entry position in the table.</p> <p><i>Example:</i> Enter the following command string to register a base station ID in table position #7: <code>add 00:09:02:00:a3:5d [Enter]</code></p>
delete	<p>Delete a base station ID entry. The count value will be adjusted to reflect the current number of effective entries. If the table position value is not specified, the last valid entry in the table is deleted.</p> <p>EntryNumber: The entry position in the table.</p>
show	<p>Display the base station ID table entries. If the table position value is not specified, all entries in the table are displayed. If the keyword 'monitor' is used, the display is updated continually.</p> <p>EntryNumber: The entry position in the table. Monitor: Dynamically updated display of table values.</p>

Notes:

The following actions are taken when the bsIdTable is modified:

1. A 'Detected BS table reset' log message is generated.
2. An 'Add detected BS...' log message is generated if a new entry is added to the table.
3. A frequency scan is initiated (see rfConfig).

4.3.3 diagStatistics - Diagnostic Statistics

Use the Diagnostic Statistics commands to monitor specific operations for the subscriber. The following table lists all commands available in this mode.

Table 12: CLI - diagStatistics - Diagnostic Statistics Commands	
Command	Description
list	<p>Display the current values for all statistics.</p> <p>TxPowerMin: Minimum transmit power level used.</p> <p>TxPowerMax: Maximum transmit power level used.</p> <p>TxPowerAvg: Average transmit power level used.</p> <p>DIModCodeMin: Minimum downlink coding value used.</p> <p>DIModCodeMax: Maximum downlink coding value used.</p> <p>DIModCodeAvg: Average downlink coding value used.</p> <p>UIModCodeMin: Minimum uplink coding value used.</p> <p>UIModCodeMax: Maximum uplink coding value used.</p> <p>UIModCodeAvg: Average uplink coding value used.</p> <p>CinrMin: Minimum measured CINR value.</p> <p>CinrMax: Maximum measured CINR value.</p> <p>CinrAvg: Average measured CINR value.</p> <p>PhyRssiMin: Minimum measured RSSI value (physical layer).</p> <p>PhyRssiMax: Maximum measured RSSI value (physical layer).</p> <p>PhyRssiAvg: Average measured RSSI value (physical layer).</p> <p>RfRssiMin: Minimum measured RSSI value (radio).</p> <p>RfRssiMax: Maximum measured RSSI value (radio).</p> <p>RfRssiAvg: Average measured RSSI value (radio).</p> <p>CableCompMin: Minimum cable compensation value used.</p> <p>CableCompMax: Maximum cable compensation value used.</p> <p>CableCompAvg: Average cable compensation value used.</p> <p>FreqOffsetMin: Minimum frequency offset used.</p> <p>FreqOffsetMax: Maximum frequency offset used.</p> <p>FreqOffsetAvg: Average frequency offset used.</p> <p>MacResets: Number of times MAC layer has been reset.</p> <p>CRCErrors: Number for CRC errors detected.</p> <p>HeaderErrors: Number for packet header errors detected.</p> <p>DISdus: Number of downlink SDUs received.</p> <p>DIMpdus: Number of downlink PDUs received.</p> <p>UISdus: Number of uplink SDUs sent.</p> <p>UIMpdus: Number of uplink PDUs sent.</p> <p>tx: Show transmit group of statistics.</p> <p>dl: Show downlink group of statistics.</p> <p>ul: Show uplink group of statistics.</p> <p>cinr: Show CINR group of statistics.</p> <p>phy: Show PHY group of statistics.</p> <p>rf: Show RF group of statistics.</p> <p>cable: Show Cable Compensation group of statistics.</p> <p>freq: Show Frequency Offset group of statistics.</p> <p>other: Show Others group of statistics.</p>
reset	<p>Set all parameters to the last measured value. Can also be applied to groups of statistics (i.e., tx group).</p>

Table 12: CLI - diagStatistics - Diagnostic Statistics Commands	
show	<p>Display the current setting for all parameters. For example:</p> <pre>Structure --- <<SS Diagnostic Statistics>> Transmit Downlink General Uplink General CINR ----- PowerMin:....-4.1 dBm ModCodeMin:....6 ModCodeMin:....6 Min:.....30.5 dB PowerMax:....-4.1 dBm ModCodeMax:....6 ModCodeMax:....6 Max:....38.3 dB PowerAvg:....-4.1 dBm ModCodeAvg:....6 ModCodeAvg:....6 Avg:.....34.5 dB Sdus:.....116 Sdus:.....51 Mpdus:.....516 Mpdus:.....68 PHY RF Cable Compensation Frequency Offset RssiMin:....-16.8 dB RssiMin:....-49.6 dB CompMin:.....0 OffsetMin:....-1 RssiMax:....-15.8 dB RssiMax:....-48.6 dB CompMax:.....0 OffsetMax:..4 RssiAvg:....-16.2 dB RssiAvg:....-49.0 dB CompAvg:.....0 OffsetAvg:....0 RxCalStatus:..1 TxCalStatus:..1 Others MacResets:.....0 CRCErrors:.....0 HeaderErrors:..0</pre>

4.3.4 ethTag - Ethernet Tagging

Use these commands to identify data traffic through this subscriber by using 802.1Q VLAN tags. The following table lists all commands available in this mode.

Table 13: CLI - ethTag - Ethernet Tagging Commands	
Command	Description
reset	Set all ethTag parameters to factory default values.
set	<p>Change parameter settings.</p> <p>Active: 0: Disabled - All ethTag features are disabled. 1: Enabled - Each upstream packet received on the subscriber Ethernet port is tagged with the specified VID (value field). If the packet has an existing VLAN tag, a new outermost tag is added (Q in Q). The modified packet is then forwarded over the wireless interface to the base station.</p> <p>FilterOn: 0: Disabled - All packets are forwarded unmodified. 1: Enabled - All downlink packets are classified according to the outermost VLAN tag. Packets with a VLAN tag matching the Value field have the VLAN tag removed and are then forwarded to the subscriber Ethernet port. All non-matching packets are discarded.</p> <p>Priority: Enter the priority to be assigned to each VLAN tagged packet to be sent over the wireless interface (uplink) to the sector controller.</p> <p>PriorityCopy: 0: Disabled - The Priority field value is inserted into the VLAN tags. 1: Enabled - If the received packet has a VLAN tag, the tags priority value is copied to the new VLAN tag being added (Q in Q), otherwise, the Priority field value is used.</p> <p>Value: Enter the VLAN ID. This is the VLAN tag added to uplink packets (active=1), and used to filter downlink packets (FilterOn=1).</p>

Table 13: CLI - ethTag - Ethernet Tagging Commands	
show	Display the current setting for all parameters. For example: <i>Structure --- <<SS Ethernet Tagging Data>></i> <i>Active:.....inactive(0)</i> <i>Priority:.....0</i> <i>FilterOn:.....0</i> <i>PriorityCopy...0</i> <i>Value:.....0</i>

Note: The base station passes all ingress and egress traffic without modification.

4.3.5 installedVer - Installed Version

Use the installed version command to view information about the binary files saved in the subscriber non-volatile RAM, and to select the active version of software. See also installedVer, loadImage, and version commands. The following table lists all commands available in this mode.

Table 14: CLI - installedVer - Installed Version Commands	
Command	Description
set	Switch the active version of image. Active - Load the binary file from the selected partition: 0 - Load from partition #0. 1 - Load from partition #1.
show	Display the current setting for all parameters. Partition #0: MajorNumber: Major software release number. MinorNumber: Minor software release number. ReleaseNumber: Software release build number. Designation: Software release designation. Partition #1: MajorNumber: Major software release number. MinorNumber: Minor software release number. ReleaseNumber: Software release build number. Designation: Software release designation. Active: Indicate the active partition. 0: Partition 0 will be loaded at reboot. 1: Partition 0 will be loaded at reboot. For example: <pre> Partition #0 Partition #1 Others ----- MajorNumber:.....1 MajorNumber:.....1 Active:.....1 MinorNumber:.....0 MinorNumber:.....0 ReleaseNumber:...100 ReleaseNumber:...98 Designation:.....1 Designation:.....1 </pre>

4.3.6 ipAddress - IP Address Commands

Use the IP address commands to display network address settings and modify subscriber IP address settings. The following table lists all commands available in this mode.

Table 15: CLI - ipAddress - IP Address Commands	
Command	Description
set	Change IP address parameter settings. Address: IP address assigned to subscriber. Static address only. Mask: 255.255.255.0 <i>Example: Use the following command to set a static IP address and mask: set Address 192.168.20.33 Mask 255.255.255.0</i>
show	Display the current IP address settings. For example: <i>Structure --- <<SS IP Address Data>></i> <i>Address:.....192.168.25.100</i> <i>Mask:.....255.255.255.0</i>
reset	Reset the IP address to factory default. Requires confirmation.

Local Ethernet Port (Secondary Management) IP

All factory-shipped subscriber systems have the following IP addresses assigned to the local Ethernet port:

Fixed: 192.168.101.1 (well-known, can not be modified)

Default: 192.168.101.2 (can be modified using CLI)

Over-the Air (Secondary Management) IP

When a subscriber is enabled for remote management (managedSS=1) its over-the-air secondary management IP address can be assigned only through the base station acting as a DHCP relay agent. The DHCP server and a Time-of-Day (ToD) server (specified in the obtained lease) must be located on the network connected to the base station Ethernet port. The subscriber can not use any DHCP or ToD server on the network connected directly to the subscriber Ethernet port.

The DHCP exchange includes a request for the address of a ToD server, and the time offset (option 2) specifying the time zone where the subscriber is operating (seconds from GMT). After the subscriber acquires a DHCP lease time, it attempts to contact the ToD server. If successful, the subscriber updates the system clock with the received time. If a ToD server cannot be reached the subscriber initializes its system clock to the default time of midnight January 1, 1970 GMT.

DHCP Issues

The subscriber does not keep a record of the previously assigned IP, and the IP request field is empty during its initial request. If the lease has expired since the last time the subscriber requested an address the DHCP server may assign a new IP address. You can ensure that your subscriber will always receive the same IP by 1) making the lease timeout indefinite, or 2) creating a static address reservation for your subscriber (if your DHCP server supports these features).

4.3.7 loadImage - Download and Activate Software Image

The loadImage command can be used to update the subscriber using the SMC channel (via the base station Ethernet port) or using the local Ethernet connection.

The following provides an example update session. The subscriber will reboot using the new image automatically following a successful download.

Example Download Dialog with Subscriber
<pre> Login: admin Password: admin, welcome to the SS CLI. SUI#> loadImage Server IP Address: [enter ftp server IP address here] File Name: [enter binary file name here] Opening FTP connection.....Done Downloading image Done Programming update.....Done Erasing setup partition. Done. Writing setup partition. Done. Erasing boot block. Done Programming boot block. Done Flash programming complete. SUI#>reboot </pre>

4.3.8 modThresh - Modulation Threshold

Use the modulation threshold commands to view and adjust the settings for adaptive modulation. These settings are made at the factory and should only be adjusted by experienced personnel. The following table lists all commands available in this mode.

Table 16: CLI - modThresh - Modulation Threshold Commands	
Command	Description
reset	Set all parameters to factory default values. Requires confirmation.
set	Change parameter settings. Rate1Exit: RW Rate 1 exit threshold. Value > 0 Rate1Entry: RW Rate 1 entry threshold. Value > Rate1Exit Rate2Exit: RW Rate 2 exit threshold. Value > Rate1Entry Rate2Entry: RW Rate 2 entry threshold. Value > Rate2Exit Rate3Exit: RW Rate 3 exit threshold. Value > Rate2Entry Rate3Entry: RW Rate 3 entry threshold. Value > Rate3Exit Rate4Exit: RW Rate 4 exit threshold. Value > Rate3Entry Rate4Entry: RW Rate 4 entry threshold. Value > Rate4Exit Rate5Exit: RW Rate 5 exit threshold. Value > Rate4Entry Rate5Entry: RW Rate 5 entry threshold. Value > Rate5Exit Rate6Exit: RW Rate 6 exit threshold. Value > Rate5Entry Rate6Entry: RW Rate 6 entry threshold. Value > Rate5Exit

Table 16: CLI - modThresh - Modulation Threshold Commands

Command	Description
show	<p>Display the current setting for all parameters. For example:</p> <pre> Structure --- <<Modulation Rate Threshold Parameters>> Rate1Exit:.....9.50 dB Rate1Entry:.....10.50 dB Rate2Exit:.....12.00 dB Rate2Entry:.....13.00 dB Rate3Exit:.....16.50 dB Rate3Entry:.....17.50 dB Rate4Exit:.....19.50 dB Rate4Entry:.....20.50 dB Rate5Exit:.....23.00 dB Rate5Entry:.....24.00 dB Rate6Exit:.....26.00 dB Rate6Entry:.....27.00 dB </pre>

4.3.9 monitor - Monitor Mode

Use the monitor mode to view dynamically updating display for system statistics. Refer to the status command for descriptions of each statistic.

Table 17: CLI - monitor - Monitor Mode				
Command	Description			
<i>View system statistics.</i>				
<i>Rssi:</i> -16.5	<i>Snr:</i> 31.7	<i>FreqOffset:</i> -1	<i>TCnt:</i> 0	<i>ModemResets:</i> 5
<i>DlfpCount:</i> 311714	<i>DlfpErrCount:</i> 0	<i>DlfpCrcCount:</i> 1	<i>DIMapCount:</i> 12468	<i>DIMapErrCount:</i> 0
<i>DIMapCrcCount:</i> 0	<i>UIMapCount:</i> 311714	<i>UIMapErrCount:</i> 0	<i>UIMapCrcCount:</i> 0	<i>DcdRxCount:</i> 1396
<i>DcdErrCount:</i> 0	<i>DcdCrcCount:</i> 0	<i>UcdRxCount:</i> 1396	<i>UcdErrCount:</i> 0	<i>UcdCrcCount:</i> 0
<i>MgmtRxCount:</i> 87	<i>MgmtErrCount:</i> 0	<i>MgmtCrcCount:</i> 0	<i>LostFrames:</i> 1	<i>FrameDuration:</i> 10000
<i>DcdChangeCount:</i> 0	<i>RngTimeCorrection</i> -76	<i>DIByteCount:</i> 56642560	<i>DISduCount:</i> 60824	<i>DIMpduCount:</i> 304083
<i>DIHCrcErrCount:</i> 0	<i>DICrcErrCount:</i> 0	<i>UIByteCount:</i> 118122579	<i>UISduCount:</i> 117162	<i>UIMpduCount:</i> 56187
<i>TotalHCrcErrors</i> 0	<i>TotalCrcErrors</i> 0	<i>TotalTxBurstCnt:</i> 145145	<i>TotalRngReqcnt:</i> 6	<i>TotalBwReqCnt:</i> 34917
<i>TotalMgmSentCount:</i> 24	<i>TotalPaddingCount:</i> 135617	<i>RfRssi:</i> -49.3	<i>TxPower:</i> -4.3	<i>LinkStatus:</i> Registered(1)

4.3.10 phyConfig - Physical Layer Configuration

The phyConfig mode allows you to view and modify the subscriber physical layer (PHY) settings. The following table lists all commands available in this mode.

Table 18: CLI - phyConfig - Physical Layer Commands	
Command	Description
reset	Set all parameters to factory default values. Requires confirmation.
set	<p>Change physical layer parameter settings.</p> <p>Bandwidth: Channel size (KHz). Selections are: 1750, 3500, or 7000.</p> <p>FftSize: OFDM fft size. Valid settings are: 128, 256, 512, or 1024.</p> <p>PsDuration: Physical slot duration.</p> <p>PsPerOFDMSymbol: Physical slots per OFDM symbol value in PS.</p> <p>SmplFactorNum: Above the fraction line in the sampling factor (ns). Normally set to 8 nsec.</p> <p>SmplFactorDen: Under the fraction line in the sampling factor (ns). Normally set to 7 nsec.</p> <p>CyclicPrefix: Cyclic prefix (CP). The guard interval is used to factor out multipath effect. Valid settings are: 4, 8, 16, and 32. Default value for subscriber is 16 (1/16).</p> <p><i>Example: Enter the following command string to set the channel size to 3500 KHz: set Bandwidth 3500 [Enter]</i></p>
show	<p>Display the current setting for all parameters. For example:</p> <pre>Structure --- <<SS Mmgt PHY Configuration Parameter>> Bandwidth:.....3500 kHz FftSize:.....256 PsDuration:.....1000 PsPerOFDMSymbol:....68 SmplFactorNum:.....8 SmplFactorDen:.....7 nsec CyclicPrefix:.....16 PS</pre>

4.3.11 privacySS - Privacy Commands

The privacySS mode allows you to view and modify the privacy settings for the subscriber. The following table lists all commands available in this mode.

Table 19: CLI - privacySS - Privacy Commands	
Command	Description
set	<p>Change privacy related settings on subscriber. All times are in seconds.</p> <p>Enable: 0 -- Disable privacy. 1 -- Enable privacy.</p> <p>UseTestTimers: 0 -- Use programmed timers 1-- Use test defaults.</p> <p>AuthWaitTime: - Auth Req retransmission interval from Auth Wait state. ReauthWaitTime: - Auth Req retransmission interval from ReauthWait state.</p> <p>AuthGraceTime: - Time prior to Authorization expiration SS begins reauthorization.</p> <p>OperationalWaitTime: - Key Req retransmission interval from Op Wait state.</p> <p>RekeyWaitTime: - Key Req retransmission interval from Re-key Wait state.</p> <p>TekGraceTime: - Time prior to TEK expiration SS begins re-keying. AuthRejectWaitTime: - Delay before resending Auth Request after receiving Auth Reject.</p>
show	<p>Display privacy related settings on subscriber. For example:</p> <pre>Structure --- <<SS privacy Data>> Enabled:.....Disabled(0) UseTestTimers:.....Normal(0) AuthWaitTime:.....10 ReauthWaitTime:.....10 AuthGraceTime:.....600 OperationalWaitTime:1 RekeyWaitTime:.....1 TekGraceTime:.....3600 AuthRejectWaitTime:.60</pre>

4.3.12 reset - Reset Command

The reset command is allows you to set parameters to factory default values. The following table lists all commands available in this mode.

Table 20: CLI - reset - Reset Commands	
Command	Description
detectedBS	Clear all entries and associated settings from the detectedBS table.

4.3.13 rfConfig - RF Setup Commands

The rfConfig mode allows you to view and modify the subscriber RF settings. The following table lists all commands available in this mode.

Important: The subscriber must be rebooted before changes to the rfConfig frequency settings become effective

Table 21: CLI - rfConfig - Radio Frequency Commands	
Command	Description
reset	Reset all RF parameters to factory default values. Requires confirmation.
set	Modify RF parameters. TxFixedPower: Tx Gain. Value between: -10.00 and +20.00 RxGain: Rx Gain. Value between: -19.00 and +80.00 TxFixedGain: Tx power scan during network entry. 0 - Enable / 1 - Disable RxAgc: Receive automatic gain control AGC). 0 - Disable / 1 - Enable LoRfFreq1: Lower limit of the 1st Frequency Scan Interval. HiRfFreq1: Upper limit of the 1st Frequency Scan Interval. LoRfFreq2: Lower limit of the 2nd Frequency Scan Interval. HiRfFreq2: Upper limit of the 2nd Frequency Scan Interval. LoRfFreq3: Lower limit of the 3rd Frequency Scan Interval. HiRfFreq3: Upper limit of the 3rd Frequency Scan Interval. LoRfFreq4: Lower limit of the 4th Frequency Scan Interval. HiRfFreq4: Upper limit of the 4th Frequency Scan Interval. LoRfFreq5: Lower limit of the 5th Frequency Scan Interval. HiRfFreq5: Upper limit of the 5th Frequency Scan Interval. LoRfFreq6: Lower limit of the 6th Frequency Scan Interval. HiRfFreq6: Upper limit of the 6th Frequency Scan Interval.
show	Show the current setting for all parameters.

Notes:

1. Refer to Section 1 of this document for restrictions on power or frequency settings.
2. Scanning ranges must not intersect or overlap. When changing settings, the order of data entry must ensure the 'Hi' setting is always greater than the 'Lo' setting. For example, when changing from the default setting 'Hi=0, Lo=0' you must enter the Hi setting first.
3. When specifying a single channel, enter the RF frequency in the 'Hi' setting, and then enter the identical value in the 'Lo' setting.

Frequency scanning

Frequency scanning is performed in 250 KHZ steps, monitoring each step for approximately four seconds. The subscriber will always complete the entire scan for all non-zero ranges. If all ranges are zero, the subscriber will scan the entire 200 MHz range of the radio (approx. 55 minutes). During the scan, the subscriber compiles a table of detected base stations (filtered by the bsIdTable entries) and orders the results based on signal level (CINR). Once the scan is completed, the table is saved in non-volatile RAM (preserved through subscriber reboot/power-cycle).

A frequency scan is triggered by any of the following events:

- i) The RF parameters are modified.
- ii) The bsIdTable (allowed base station list) is modified.
- iii) There are no base stations in the scanning results table.

Following any of the events listed above, the subscriber attempts to register with the first base station in the scanning results table. Once registered, the subscriber remains connected to that base station. If the connection to the base station is lost while the subscriber is online (e.g., base station rebooted), that base station is removed from the scanning results table. As required, the subscriber attempts to register with the next base station in the scanning results table, removing the entry if it can not register with that base station.

4.3.14 set - Set Commands

The set mode can be used to directly modify all available subscriber parameters. The parameters listed in this table do not have a separate mode, and can openly be modified by the set command.

Enter a new value for one or more fields in mode.

set [Enter] Display all fields.

Modify selected field(s).

set [mode] [field] [value] [value] [field] [...] <ENTER>

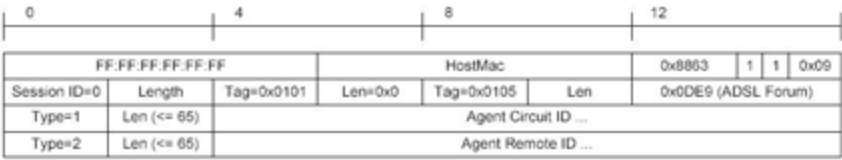
Table 22: CLI - set - Modify Subscriber Parameters	
Command	Description
dhcpRelayAgent	Use this setting to enable or disable the DHCP relay setting. 0 -- Disable DHCP relay agent. 1 -- Enable DHCP relay agent. This feature <u>must</u> be enabled to use DHCP Option 82.
dILearnFilter	Use this setting to enable or disable the DHCP relay setting. 0 -- Disable filter - Do not filter DL packets. 1 -- Enable filter - Only forward DL packets based on learned hosts.
ethernet	Use this setting to modify the Ethernet port auto negotiation, link speed, and duplex settings. AutoNegEnabled <value> 0 -- Disabled 1 -- Enabled. LinkSpeed <value> 0 -- 10M 1 -- 100M. LinkDuplex <value> 0 -- Half 1 -- Full.
managedSS	The managedSS command allows you to configure the subscriber for independent operation, or enable management using the RedMAX EMS system. The managedSS parameter is controlled from root mode. The following table lists all commands available for managedSS. 0 - Disable remote management 1 - Enable remote management
pppoe	Enable/Disable DSL Forum VSA in PPPoE Vendor-Specific Tag (RFC4679). 0 - Disable pppoe 1 - Enable pppoe 
sysContact	Enter device administration contact information (255 chars max.).
sysLocation	Enter the device location (255 characters max.).
sysName	Enter the device name (255 characters max.).

4.3.15 show - Show Commands

The fields in this section are available only by using the show command. The following table lists all functions available in this mode.

Table 23: CLI - show - Show Commands																			
Command	Description																		
dhcpRelayAgent	Show the SS DHCP Relay Agent setting. 0 - Disabled 1 - Enabled																		
detectedBS	Show details for detected base stations. Including frequency and CINR. For example: <i><< Detected BSID Table >></i> 0) 00:09:02:00:a3:5d Freq 3424000 kHz Cinr 305 dBm																		
ethernet	Display the Ethernet port settings: AutoNegEnabled - Auto Negotiation (Disabled/Enabled) LinkSpeed - Link Speed (10/100) LinkDuplex - Link Duplex (half/full)																		
eventLog	Display the event log messages.																		
interfaces	Display information about the subscriber wireless and Ethernet interfaces. For example: <table border="1"> <thead> <tr> <th><i>ifIndex</i></th> <th><i>Desc</i></th> <th><i>MAC Address</i></th> <th><i>ifAdminStatus</i></th> <th><i>ifType</i></th> <th><i>ifMtu</i></th> </tr> </thead> <tbody> <tr> <td>1</td> <td>802.16</td> <td>00:09:02:00:8c:7f</td> <td>1</td> <td>184</td> <td>2048</td> </tr> <tr> <td>2</td> <td>802.3</td> <td>00:09:02:00:8c:7f</td> <td>1</td> <td>6</td> <td>1500</td> </tr> </tbody> </table>	<i>ifIndex</i>	<i>Desc</i>	<i>MAC Address</i>	<i>ifAdminStatus</i>	<i>ifType</i>	<i>ifMtu</i>	1	802.16	00:09:02:00:8c:7f	1	184	2048	2	802.3	00:09:02:00:8c:7f	1	6	1500
<i>ifIndex</i>	<i>Desc</i>	<i>MAC Address</i>	<i>ifAdminStatus</i>	<i>ifType</i>	<i>ifMtu</i>														
1	802.16	00:09:02:00:8c:7f	1	184	2048														
2	802.3	00:09:02:00:8c:7f	1	6	1500														
sysContact	Display the system contact information.																		
sysDescription	Display the system contact information.																		
sysLocation	Display system location string. For example: sysLocation: 123 Mains St. Unit #12																		
sysname	Display the system name.																		
sysUpTime	Display system up time. For example: sysUpTime: 10 days 20:28:19																		
version	Display the currently running software version.																		

4.3.16 softwareUpdate - Software Update Commands

Use the softwareUpdate commands to display the software versions stored in the subscriber non-volatile memory, download software updates from an FTP server, and switch the active versions.

Table 24: CLI - softwareUpdate - Software Update Commands	
loadImage	Download software binary file and save in non-volatile memory (inactive partition). Following download, you must enter the reboot command to run the new software. On the next reboot following a successful download, the subscriber will automatically switch active partitions and run the downloaded file.
show	Display software version information for downloaded binary files. Indicates the active version.
switch	Switch to the currently inactive software version. Confirmation is required. The subscriber will be rebooted. This is done automatically following a successful file download.
sync	<p>Synchronize the binary files saved in the active and inactive partitions. This command copies the 'active' binary file into the inactive partition. Following execution of this command, both partitions (#0 and #1) will contain identical software versions.</p> <p><i>For example:</i></p> <pre> SUO#> loadImage Server IP Address: 192.168.101.102 File Name: SUO-U1-001-01-00-078.bin Opening FTP connection..... DoneDownloading image DoneProgramming update..... DoneErasing setup partition. Done.Writing setup partition. Done.Erasing boot block. DoneProgramming boot block. DoneFlash programming complete. SUO#>reboot </pre>

4.3.17 status - Status Information

The status mode allows you to view general subscriber statistics. The following table lists all commands available in this mode.

Table 25: CLI - status - Status Commands	
Command	Description
reset	Set all parameters to factory default values.
show	<p>Display the current setting for all parameters.</p> <p>DlfpCount: Downlink FPs (frames) received.</p> <p>DlfpErrCount: Downlink FP semantic errors.</p> <p>DlfpCrcCount: Downlink FP messages with CRC errors.</p> <p>DIMapCount: Downlink MAP messages.</p> <p>DIMapErrCount: Downlink MAP semantic errors.</p> <p>DIMapCrcCount: Downlink MAP messages with CRC errors.</p> <p>DIByteCount: Downlink Bytes received.</p> <p>DISduCount: Downlink SDUs received.</p> <p>DIMpduCount: Downlink MPDUs received.</p> <p>DIHCrcErrCount: Downlink data HCRC errors.</p> <p>UIMapCount: Uplink MAP messages.</p> <p>UIMapErrCount: Uplink Invalid MAP messages.</p> <p>UIMapCrcCount: Uplink MAP messages with CRC errors.</p> <p>UIByteCount: Uplink Bytes received.</p> <p>UISduCount: Uplink SDUs received from CL</p> <p>UIMpduCount: Uplink MPDUs sent.</p> <p>MgmtRxCount: Total management messages.</p> <p>MgmtErrCount: Invalid management messages.</p> <p>MgmtCrcCount: Management messages with CRC errors.</p> <p>UcdRxCount: Uplink Channel Descriptor messages.</p> <p>UcdErrCount: Uplink Channel Descriptor messages that are Invalid.</p> <p>UcdCrcCount: Uplink Channel Descriptor messages with CRC errors.</p> <p>Rssi: Received Signal Strength Indicator.</p> <p>Snr: Signal-to-Noise Ratio.</p> <p>FreqOffset: Frequency Offset.</p> <p>TCnt: Time count of the last burst received.</p> <p>ModemResets: Number of times the modem was reset due to errors.</p> <p>LostFrames: Number of logical frames lost.</p> <p>FrameDuration: Duration in microseconds: 2500 to 20000.</p> <p>RngTimeCorrection: Time correction from ranging response.</p> <p>TotalHCrcErrors: Header CRC errors.</p> <p>TotalCrcErrors: Payload CRC errors.</p> <p>TotalTxBurstCount: Transmit burst.</p> <p>TotalRngReqCount: Ranging requests.</p> <p>TotalBwReqCount: Bandwidth requests.</p> <p>TotalMgmSentCount: Management traffic sent.</p> <p>TotalPaddingCount: Padding bytes sent.</p> <p>RfRssi: Current RSSI value.</p> <p>TxPower: Current Tx output power.</p> <p>LinkStatus: Registered(1).</p>

5 Appendices

5.1 System Technical Specifications

Table 26: Specifications - Indoor Wireless Subscriber Modem

System Models:	SU-IIR (SU-I)
System Capability:	LOS, Optical LOS, non LOS Cell-based point-to-multipoint deployment
RF Band ¹ :	3.300 - 3.500 GHz (FWA Band) 3.400 - 3.600 GHz (FWA Band) 3.600 - 3.800 GHz (FWA Band)
Channel Size:	3.5, 7 MHz
RF Dynamic Range:	> 45 dB
Spectral Efficiency:	Up to 5 bps/Hz (over the air) Up to 3 bps/Hz (net to Ethernet)
Over The Air Rate:	Up to 35 Mbps Uncoded Rate @ 7 MHz channel ²
Ethernet Data Rate:	Up to 23 Mbps @ 7 MHz channel ²
Maximum Tx Power:	+24 dBm (region specific)
Rx Sensitivity:	-98 dBm @ BPSK 1/2 (based on BER 1x10E-6)
Cable:	Coaxial cable for connection to integrated antenna
Network Attributes:	Transparent bridge, 802.1Q VLAN, 802.1p, TOS/DSCP VLAN port tagging, L2/L3 address traffic classification
Modulation/Coding Rates:	Auto-select modulation: BPSK, QPSK, 16 QAM, 64 QAM Auto-select coding: 1/2, 2/3, 3/4
Over-the-Air Encryption:	DES
MAC:	Cell-based PMP deployment 802.16-2004 compliant PMP 802.16-2004 packet convergence sub-layer mode Scheduled Services (rtPS, nrtPS, UPS, BE) TDMA Access
Duplex Technique:	TDD (Time Division Duplex) HD-FDD (Half-Duplex Frequency Division Multiplexing)
Wireless Transmission:	256 FFT Orthogonal Frequency Division Multiplexing (OFDM)
Network Connections:	RJ-45 (10/100 Ethernet) 802.30
System Configuration:	Telnet CLI, FTP (software updates)

Table 26: Specifications - Indoor Wireless Subscriber Modem

Power Requirements:	Auto-sensing 110/220/240 VAC 50/60 Hz, 10.5 W
Compliance:	EMC: EN 301 489-1, EN 301 489-4, EN 55022/CISPR 22 RF: EN 301 021, EN 301 753, IC RSS-192, FCC Part 90/15 Safety: IEC 60950-1, EN 60950-1, UL 60950-1
Operating Temperature:	-5 C to 40 C
Antenna:	Integrated flat panel (10.44 dBi)
Dimensions (L x W x H):	8.9 x 7.0 x 20.6 cm (3.5 x 2.74 x 8.12 in) ³
Weight:	0.45 Kg (1.0 lb) ³
<p>¹ Frequency range dependant on installed radio option, license, and regulatory domain. ² Actual Ethernet data throughput is dependent on channel size, protocols, packet size, burst rate, transmission latency, and link distance. ³ Based on a subscriber unit with integrated vertical antenna and stand attached</p>	

5.2

Subscriber Log Messages

Table 27: Troubleshooting - Event Log Messages

Log Message	Description
Add classifier [CID: XXXX, Idx: nn]	A classifier with the following CID has been added.
Broadcast Opportunity Corrupted	Opportunities have been received for initial ranging, but the opportunity is not appropriate (i.e. too short) for this subscriber.
Broadcast Ranging Opportunity Received	This message indicates that the base station has provided an opportunity for subscriber registration.
Broadcast Ranging Opportunity Timeout	This message indicates that the base station has not provided an opportunity for new subscriber registration within the last 10 seconds.
Classifier deleted [Idx: nn]	The specified classifier has been deleted.
Classifiers deleted for SF with CID XXXX	All classifiers have been cleared for the specified service flow.
DCD Receiving Timeout	The subscriber has not received downlink channel descriptors for five consecutive opportunities. The subscriber will now restart the ranging process in an attempt to re-establish wireless synchronization.
Deregistration DREG-CMD, action code: nn	The subscriber has de-registered.
Deregistration DREG-CMD, action code: nn	base station has requested that subscriber should deregister.
DHCP Error	There has been an error in obtaining a DHCP lease
Downlink Burst Profile Adjusted [BP: nn]	Downlink modulation rate has been adjusted by the base station.
Downlink Burst Profile Change Attempt [BP: nn]	A request to change the downlink modulation rate has been made based on locally configured CINR thresholds.

Table 27: Troubleshooting - Event Log Messages

Log Message	Description
Downlink Channel Inoperable	This message is displayed when the subscriber detects the presence of a base station, but is unable to properly synchronize with it.
Downlink SF nn changed	Changes have been successfully applied to the specified downlink service flow.
Downlink SF nn created [CID: XXXX, No.CIs: nn]	A downlink service flow has been successfully created.
Downlink SF nn not created (no space) [CID: XXXX]	The subscriber cannot create the specified DL service flow, as there is not enough remaining memory.
DSA Err - DSA-ACK send retries exhausted [SF Id: XXXX]	subscriber has attempted to acknowledge a DSA transaction unsuccessfully more than the maximum number of times.
DSA Rejected - Service Flow exists [SF Id: XXXX]	The service flow ID assigned base station already exists locally in subscriber
DSC abort by DSC-ACK [SF Id: XXXX]	A DSC transaction has been aborted due to an acknowledgement message not being received by the subscriber.
DSC Err - DSC-ACK send retries exhausts [SF Id: XXXX]	subscriber has attempted to acknowledge a DSC transaction unsuccessfully more than the maximum number of times.
DSC Err - DSC-RSP send retries exhausts [SF Id: XXXX]	subscriber has attempted to acknowledge a DSC-RSP transaction message unsuccessfully more than the maximum number of times.
DSC Err - SF or CLS rejected [SF Id: XXXX]	DSC transaction has been rejected by base station.
DSC Success [SF Id: XXXX]	DSC transaction has been successful.
DSC-DSD Reject - SF ID not found	base station has requested the deletion of a SFID which does not exist.
DSD Success [SF Id: XXXX]	DSD transaction has successfully completed.
DSx Action [error]	There has been an error in the creation of a service flow. The particular failure is detailed in the message text.
DSx Add Reject [reason]	This message signifies that the addition of a service flow has been rejected by the subscriber. The reason for the failure is included in the message text.
Failed to acquire the time-of-day	Communication with a ToD (RFC-868) server has not been successful. The correct time of day has not been acquired. According to standard, the subscriber must now perform a MAC reboot and begin network entry again.
Initial Ranging at Maximum Power [Adj.: +nn]	subscriber has begun initial ranging with a base station, and has reached its maximum Tx power while attempting to establish communication.
Initial Ranging at Minimum Power [Adj.: +nn]	subscriber has begun initial ranging with a base station, and has reached its minimum Tx power while attempting to establish communication.

Table 27: Troubleshooting - Event Log Messages	
Log Message	Description
Initial Ranging Backoff	A contention was encountered with another subscriber while attempting to perform initial ranging. The subscriber will wait and try again after the backoff interval.
Initial Ranging Parameters Adjusted [TLV Map: XXXXXXXX]	This message displays the parameter adjustments as requested by the base station.
Initial Ranging Success [TLV Map: XXXXXXXX]	Initial ranging has been completed successfully.
Invalid MAC address	This message is displayed when the MAC of the subscriber does not belong the Redline. The system will not function in this state.
Large Time Adjustment Received	An excessively large timing correction has been sent by the base station. This correction has not been applied, though it has been acknowledged.
Lost DL-MAP	The time since the last valid DL MAP was received by the subscriber has exceeded the timeout. The subscriber will now begin the ranging process in an attempt to re-establish wireless synchronization.
Lost UL-MAP	The time since the last valid UL MAP was received by the subscriber has exceeded the timeout. The subscriber will now begin the ranging process in an attempt to re-establish wireless synchronization.
MAC Initialized	The MAC processor has completed initialization.
MAC Reset: Configuration Change	The MAC has required a reset to apply a configuration change that was made by the user.
MAC Reset: SC Request (RES-CMD)	The base station has requested that the subscriber reset its MAC.
MAC Reset: SC Request (RES-CMD)	base station has requested that subscriber should reset its MAC.
MAC Started	The MAC processor has been started.
New Cls for SF with CID XXXX	A new classifier has been added to the specified service flow.
No Maintenance Data Grant Slot T4	IF subscriber has nothing to send, the base station should grant unsolicited bandwidth. subscriber should respond with padding. This message indicates that the base station has not granted this data for 35 seconds.
REG Failure - Retries Exhausted	The timer above (T6) has been hit 3 times in a row. The subscriber will now reboot and begin scanning for a base station again.
REG Success [TLV Map: XXXXXXXX]	The subscriber has successfully registered.
REG Wait Timeout T6 [nn retries]	The subscriber has not received a response to its registration request within 3 seconds.
REG_REQ authentication failure - HMAC [CC: nn]	With privacy enabled, authentication failed.

Table 27: Troubleshooting - Event Log Messages

Log Message	Description
REG-REQ not sent - no bw granted	The subscriber has not been able to send a registration request message to the base station, since the base station has not granted it bandwidth to do so. It cannot request bandwidth, because it is not yet registered.
Reset [reason]	The subscriber has reset itself. The reason for the reset is included in the message text.
Rf Rx Calibration Error	Rx Calibration data located in the subscriber's EEPROM has failed CRC
Rf Tx Calibration Error	Tx calibration data located in the subscriber's EEPROM has failed CRC
Rng Maintenance Correction Anomaly [TLV Map: XXXXXXXX]	An adjustment requested by the base station has failed. Not a fatal error.
Rng Maintenance Correction Success [TLV Map: XXXXXXXX]	An adjustment requested by the base station has been successfully applied.
SBC Failure - Retries Exhausted	T18 expired beyond the maximum number of allowed retries.
SBC Success [TLV Map: XXXXXXXX]	The subscriber has successfully negotiated its basic capabilities with the base station.
SBC Wait Timeout T18 [nn retries]	A SBC request response is not received within 50ms.
SBC-REQ not sent - no BW granted	base station has not allocated bandwidth to allow subscriber to do SBC and registration
Synchronization Completed	The subscriber has completed scanning for a downlink channel, and established synchronization with a base station. It will now begin its initial ranging process.
System startup [status]	The subscriber has begun the bootup sequence. The startup status will be included in the text of this message. Modes specify a possible reason for reboot.
TFTP - no response T26 [nn retries]	SMC setup has not completed within the allowed time.
TFTP Completed Successfully	This message confirms that SMC registration has completed. Communication with DHCP and ToD servers was successful.
TFTP Success	SMC IP, ToD, have been successfully obtained via DHCP.
TFTPC failed send	SMC has failed, and the subscriber will reset the MAC and begin registration process again.
Time-of-day acquired	Communication with a ToD (RFC-868) server has been successful. The correct time of day has been acquired.
UCD Receiving Timeout	5 uplink channel descriptors in a row have been expected and not received. The subscriber will now restart the ranging process in an attempt to re-establish wireless synchronization.
Unicast Initial Ranging No Response T3 [nn retries]	The base station has not responded to an initial ranging request sent by the subscriber within 200 ms.
Unicast Initial Ranging Retries Exhausted [nn retries]	The subscriber has attempted to perform initial ranging 16 times and has failed each time.

Table 27: Troubleshooting - Event Log Messages	
Log Message	Description
Unicast Initial Ranging Start [CID: XXXX]	The subscriber has received a unicast ranging opportunity
Unicast Ranging Abort	Indicates that the base station has sent the subscriber a ranging abort, telling it to halt the ranging process.
Uplink Channel Parameters Acquired	The subscriber has successfully obtained the uplink channel descriptor
Uplink SF nn changed	Changes have been successfully applied to the specified uplink service flow.
Uplink SF nn created [CID: XXXX, No.Cls: nn]	An uplink service flow has been successfully created.
Uplink SF nn not created (no space) [CID: XXXX]	The subscriber cannot create the specified UL service flow, as there is not enough remaining memory.

5.3 Upgrade Subscriber

5.3.1 Before Beginning the Upgrade

Use the following procedures to upgrade the subscriber.

The following items must be addressed before beginning the upgrade:

1. You must obtain the latest subscriber binary files.
2. The subscriber performs all software upgrades using an FTP server:
 - a) The FTP server must be located on the network connected to an active Ethernet port (Data or Mgmt) on the base station, or on the Ethernet port of the subscriber (i.e., laptop).
 - b) You must copy the binary files into the default file location for the FTP server. You can not specify a 'path' in the upgrade dialog.
 - c) The FTP server must have a user defined as follows:

username:	target
password:	secret

5.3.2 Update Software Procedure

1. Start a telnet session to the subscriber using the following settings:
 - Login:** admin
 - Password:** admin
2. Enter the 'loadImage' command. The subscriber will prompt you to enter the following information:
 - Server IP address:** [enter address of FTP server]
 - File Name:** [enter base station binary file name]

The subscriber performs FTP server authentication with user name 'target' and password 'secret' (these settings cannot be altered). The image will be uploaded to the subscriber and saved in the non-volatile memory (flash).
3. The subscriber must be reset to load the new software. Enter the 'reboot' command to reset the unit. The telnet session will be terminated.

Example Download Dialog with Subscriber
<pre> Login: admin Password: admin, welcome to the SS CLI. SUI#> loadImage Server IP Address: [enter ftp server IP address here] File Name: [enter binary file name here] Opening FTP connection.....Done Downloading image Done Programming update.....Done Erasing setup partition. Done. Writing setup partition. Done. Erasing boot block. Done Programming boot block. Done Flash programming complete. SUI#>reboot </pre>



www.redlinecommunications.com

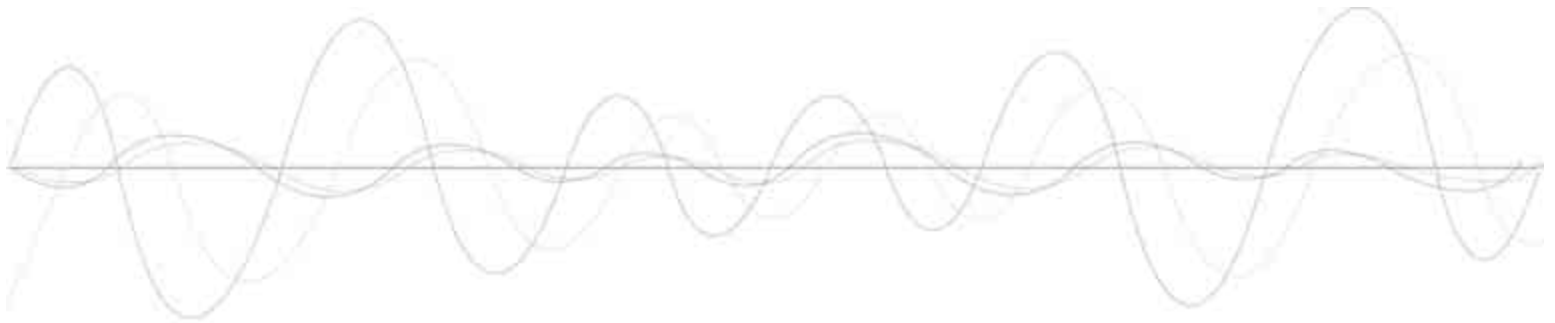

302 Town Centre • Suite 100 • Markham, Ontario • Canada • L3R 0E8

www.redlinecommunications.com