

Nemko Test Report: 147118-1TRFWL

Applicant: Redline Communications
302 Town Center Blvd.
Markham, Ontario
Canada, L3R 0E8

Apparatus: AN-100UX 3638F7

FCC ID: QC8-AN100UXA

In Accordance With: FCC Part 90 Subpart Z
Wireless Broadband Services in the
3650–3700 MHz Band

Authorized By: Andrey Adelberg, Senior Wireless/EMC Specialist

Date: April 28, 2010

Total Number of Pages: 37

TABLE OF CONTENTS

Section 1 : Report Summary	3
Section 2 : Equipment Under Test.....	4
2.1 Identification of Equipment Under Test (EUT).....	4
2.2 Accessories	4
2.3 EUT Description.....	4
2.4 Technical Specifications of the EUT	5
2.5 EUT Setup diagram	5
2.6 Operation of the EUT during testing	6
2.7 Modifications incorporated in the EUT	6
Section 3 : Test Conditions.....	7
3.1 Specifications	7
3.2 Deviations From Laboratory Test Procedures	7
3.3 Test Environment	7
3.4 Measurement Uncertainty.....	7
3.5 Test Equipment.....	8
Section 4 : Results Summary	9
4.1 FCC Part 90 : Test Results	9
4.2 FCC Part 90 Subpart Z : Test Results.....	9
Appendix A : Test Results.....	10
Clause 90.205/90.1321 Power and antenna limits	10
Clause 90.209 Occupied Bandwidth.....	22
Clause 90.210(n)/90.1323 Emission Limits Spurious emissions at the antenna terminal.....	29
Clause 90.210/90.1323 Field Strength of spurious radiation.....	34
Clause 90.213 Frequency Stability	35
Appendix B : Setup Photographs	36
Appendix C : Block Diagram of Test Setups.....	37

Section 1 : Report Summary

These tests were conducted on a sample of the equipment for the purpose of demonstrating compliance with Part 90. Conducted measurements were performed in accordance with ANSI TIA-603-B-2002. Radiated tests were conducted in accordance with ANSI C63.4-2003.

The assessment summary is as follows:

Apparatus Assessed:	AN-100UX 3638F7
Specification:	FCC Part 90 Subpart Z
Compliance Status:	Complies
Exclusions:	None
Non-compliances:	None
Report Release History:	Original Release
Test Location:	Nemko Canada Inc. 303 River Road Ottawa, Ontario K1V 1H2
Registration Number:	176392 (3 m Semi-Anechoic Chamber)
Tests Performed By:	Kevin Ma, Wireless/EMC Specialist
Test Dates:	March, 2010

Note that the results contained in this report relate only to the items tested and were obtained in the period between the date of initial receipt of samples and the date of issue of the report.

This test report has been completed in accordance with the requirements of ISO/IEC 17025. All results contained in this report are within Nemko Canada's ISO/IEC 17025 accreditation.

Nemko Canada Inc. authorizes the applicant to reproduce this report provided it is reproduced in its entirety and for use by the company's employees only.

Any use which a third party makes of this report, or any reliance on or decisions to be made based on it, are the responsibility of such third parties. Nemko Canada Inc. accepts no responsibility for damages, if any, suffered by any third party as a result of decisions made or actions based on this report.

Section 2 : Equipment Under Test

2.1 Identification of Equipment Under Test (EUT)

The following information identifies the EUT under test:

Type of Equipment:	Point-to-Multipoint base station
Brand Name:	Redline Communications
Model Name or Number:	AN-100UX3638F7
Serial Number:	N/A
Nemko Sample Number:	1
FCC ID:	QC8-AN100UXA
Date of Receipt:	March 30, 2010

2.2 Accessories

The following information identifies accessories used to exercise the EUT during testing:

Description:	17 dBi Panel Antenna
Brand Name:	Redline
Model Name or Number:	PA1760EAS
Serial Number:	403784-09-06-0520
Nemko Sample Number:	3
Connection Port:	RF antenna port
Cable Length and Type:	RF cable

2.3 EUT Description

The EUT is a Point-to-Multipoint base station using WiMAX protocols. The EUT consists of an Indoor unit (IDU), the AN-100UX terminal which supplies 48 VDC and a 70 MHz IF to the outdoor unit (ODU), HTB3638F7 Transceiver, which houses all of the Radio circuitry.

2.4 Technical Specifications of the EUT

Operating Frequency Band:	3650–3700 MHz
Operating Frequency:	3.5 MHz Channel: 3651.75–3698.25 MHz 7 MHz Channel: 3653.5–3696.5 MHz
Occupied Bandwidth	3.20 MHz (3.5 MHz), 6.34 MHz (7 MHz)
Emission Designator:	W7D
Modulation:	OFDM using 64-QAM, 16-QAM, QPSK and BPSK modulation for sub-carriers
Antenna Data:	17 dBi, 60° sector antenna (Redline P/N: PA1760EAS) 16 dBi, 60° sector antenna (Redline P/N: PA1660EASH) 16 dBi, 90° sector antenna (Redline P/N: PA1690EAS) 15 dBi, 90° sector antenna (Redline P/N: PA1590EASH) 14.5 dBi, 90° sector antenna (Redline P/N: A1490MTS) 14 dBi, 120° sector antenna (Redline P/N: PA14120EAS) 14 dBi, 120° sector antenna (Redline P/N: PA14120EASH) 11 dBi, 360° sector antenna (Redline P/N: A11360EAO)
Power Source:	120 VAC, 60 Hz or –48 VDC

2.5 EUT Setup diagram

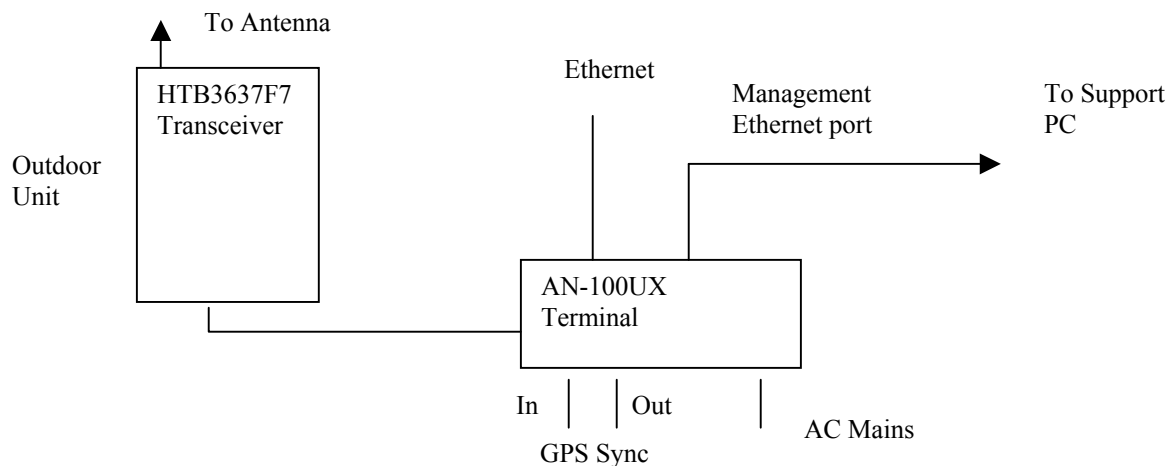

2.6 Operation of the EUT during testing

The EUT was controlled to transmit constantly at desired frequency

2.7 Modifications incorporated in the EUT

There were no modifications performed to the EUT during this assessment.

Section 3 : Test Conditions

3.1 Specifications

The apparatus was assessed against the following specifications:

FCC Part 2 Subpart J, Equipment Authorization Procedures
FCC Part 90 Private Land Mobile Radio Services

3.2 Deviations From Laboratory Test Procedures

No deviations were made from laboratory test procedures.

3.3 Test Environment

All tests were performed under the following environmental conditions:

Temperature range	:	15–30 °C
Humidity range	:	20–75 %
Pressure range	:	86–106 kPa
Power supply range	:	±5 % of rated voltages

3.4 Measurement Uncertainty

Nemko Canada measurement uncertainty has been calculated using guidance of UKAS LAB 34:2003 and TIA-603-B Nov 7, 2002. All calculations have been performed to provide a confidence level of 95 % and can be found in Nemko Canada document MU-003.

3.5 Test Equipment

Equipment	Manufacturer	Model No.	Asset/Serial No.	Cal. Date	Next Cal.
3 m EMI Test Chamber	TDK	SAC-3	FA002047	May 06/09	May 06/10
Flush Mount Turntable	Sunol	FM2022	FA002082	NCR	NCR
Bilog	Sunol	JB3	FA002108	Jan. 18/10	Jan. 18/11
Controller	Sunol	SC104V	FA002060	NCR	NCR
Mast	Sunol	TLT2	FA002061	NCR	NCR
Receiver/Spectrum Analyzer	Rohde & Schwarz	ESU 26	FA002043	Dec. 16/09	Dec. 16/10
International Power Supply	California Inst.	3001i	FA001021	Jan. 13/10	Jan. 13/11
Horn Antenna #2	EMCO	3115	FA000825	Jan. 21/10	Jan. 21/11
1 – 18 GHz Amplifier	JCA	JCA118-503	FA002091	Oct 07/09	Oct 07/10
1.0 – 2.0 GHz Amplifier	JCA	12-400	FA001498	Sept. 4/09	Sept. 4/10
2.0 – 4.0 GHz Amplifier	JCA	24-600	FA001496	Sept. 4/09	Sept. 4/10
4.0 – 8.0 GHz Amplifier	JCA	48-600	FA001497	Sept. 4/09	Sept. 4/10
5.0 – 18.0 GHz Amplifier	NARDA	DWT-186N23U40	FA001409	COU	COU
18.0 – 40.0GHz Horn Antenna	EMCO	3116	FA001847	May 9/09	May 9/10
18.0 – 26.0 GHz Amplifier	NARDA	BBS-1826N612	FA001550	COU	COU
26 – 40.0 GHz Amplifier	NARDA	DBL-2640N610	FA001556	COU	COU
Frequency Counter	HP	5352B	FA001915	Jan 08/10	Jan 08/11
Temperature Chamber	Thermotron	SM-16C	FA001030	NCR	NCR
Multimeter	Fluke	16	FA001831	Jan 13/10	Jan 13/11
Air probe	Fluke	None	FA001248	NCR	NCR

COU – Calibrate on Use

NCR – No Calibration Required

Section 4 : Results Summary

This section contains the following:

FCC Part 90 : Test Results
FCC Part 90 Subpart Z : Test Results

The column headed 'Required' indicates whether the associated clauses were invoked for the apparatus under test. The following abbreviations are used:

N No : not applicable / not relevant.

Y Yes : Mandatory i.e. the apparatus shall conform to these tests.

N/T Not Tested, mandatory but not assessed. (See Report Summary)

4.1 FCC Part 90 : Test Results

Clause	Test Method	Test Description	Required	Result
90.205	2.1046	Output power and antenna limits	Y	PASS
90.207	2.1047	Modulation Characteristics	N	
90.209	2.1049	Occupied bandwidth	Y	PASS
90.210	2.1051	Emission Limits	Y	PASS
90.210	2.1053	Field strength of surious radiation	Y	PASS
90.213	2.1055	Frequency stability	Y	PASS
90.214	—	Transient Behavior	N	
90.219	—	Use of boosters	N	

4.2 FCC Part 90 Subpart Z : Test Results

Clause	Test Description	Required	Result
90.1319	Policies governing the use of the 3650-3700MHz Band	Y	PASS
90.1321	Power and antenna limits	Y	PASS
90.1323	Emission Limits	Y	PASS
90.1333	Restrictions on the operation of mobile and portable stations	N	
90.1335	RF Safety	Y	PASS

Appendix A : Test Results

Clause 90.205/90.1321 Power and antenna limits

- (a) Base and fixed stations are limited to 25 Watts/25 MHz equivalent isotropically radiated power (EIRP). In any event, the peak EIRP power density shall not exceed 1 Watt in any one-megahertz slice of spectrum.
- (b) In addition to the provisions in paragraph (a) of this section, transmitters operating in the 3650–3700 MHz band that emit multiple directional beams, simultaneously or sequentially, for the purpose of directing signals to individual receivers or to groups of receivers provided the emissions comply with the following:
- (1) Different information must be transmitted to each receiver.
 - (2) If the transmitter employs an antenna system that emits multiple directional beams but does not emit multiple directional beams simultaneously, the total output power conducted to the array or arrays that comprise the device, *i.e.*, the sum of the power supplied to all antennas, antenna elements, staves, etc. and summed across all carriers or frequency channels, shall not exceed the limit specified in paragraph (a) of this section, as applicable. The directional antenna gain shall be computed as follows:
 - (i) The directional gain, in dBi, shall be calculated as the sum of 10 log (number of array elements or staves) plus the directional gain, in dBi, of the individual element or staff having the highest gain.
 - (ii) A lower value for the directional gain than that calculated in paragraph (b)(2)(i) of this section will be accepted if sufficient evidence is presented, *e.g.*, due to shading of the array or coherence loss in the beam-forming.
 - (3) If a transmitter employs an antenna that operates simultaneously on multiple directional beams using the same or different frequency channels and if transmitted beams overlap, the power shall be reduced to ensure that the aggregate power from the overlapping beams does not exceed the limit specified in paragraph (b)(2) of this section. In addition, the aggregate power transmitted simultaneously on all beams shall not exceed the limit specified in paragraph (b)(2) of this section by more than 8 dB.
 - (4) Transmitters that emit a single directional beam shall operate under the provisions of paragraph (b)(2) of this section.
- (c) Mobile and portable stations are limited to 1 Watt/25 MHz EIRP. In any event, the peak EIRP density shall not exceed 40 milliWatts in any one-megahertz slice of spectrum.

Test Results: Pass

Additional Observations: The EUT operates with a maximum antenna gain of 17 dBi.

The EUT is professionally installed and requires cables and a splitter from the Antenna output of the HTB unit and the antenna. This loss is required to be 10 dB during installation.

Output power measurements were performed using a 100 kHz RBW/300 kHz VBW and a channel power function of the Spectrum analyzer. PSD measurements were performed using a 1 MHz RBW/3 MHz VBW.

EIRP:

3.5 MHz channel bandwidth

Frequency (MHz)	Modulation	Power setting (dBm)	Measured power (dBm)	Cable/ Splitter loss (dB)	Antenna gain (dBi)	EIRP (dBm)	EIRP limit (dBm)	Margin (dB)
3651.75	64-QAM	27	26.23	10.0	17.0	33.23	35.4	2.17
	16-QAM	27	26.13	10.0	17.0	33.13	35.4	2.27
	QPSK	27	26.15	10.0	17.0	33.15	35.4	2.25
	BPSK	27	26.11	10.0	17.0	33.11	35.4	2.29
3675.00	64-QAM	27	26.22	10.0	17.0	33.22	35.4	2.18
	16-QAM	27	26.42	10.0	17.0	33.42	35.4	1.98
	QPSK	27	26.17	10.0	17.0	33.17	35.4	2.23
	BPSK	27	26.08	10.0	17.0	33.08	35.4	2.32
3698.25	64-QAM	27	26.08	10.0	17.0	33.08	35.4	2.32
	16-QAM	27	26.04	10.0	17.0	33.04	35.4	2.36
	QPSK	27	25.96	10.0	17.0	32.96	35.4	2.44
	BPSK	27	25.83	10.0	17.0	32.83	35.4	2.57

EIRP limit calculation: 25 W/25 MHz equals to 44 dBm/25 MHz. Since channel bandwidth is 3.5 MHz, the limit is as follows: $44 \text{ dBm} - 10 \times \text{Log} (25 / 3.5) = 44 \text{ dBm} - 8.5 \text{ dB} = 35.4 \text{ dBm}/3.5 \text{ MHz}$.

7 MHz channel bandwidth

Frequency (MHz)	Modulation	Power setting (dBm)	Measured power (dBm)	Cable/ Splitter loss (dB)	Antenna gain (dBi)	EIRP (dBm)	EIRP limit (dBm)	Margin (dB)
3653.50	64-QAM	30	29.96	10.0	17.0	36.96	38.5	1.54
	16-QAM	30	29.93	10.0	17.0	36.93	38.5	1.57
	QPSK	30	29.88	10.0	17.0	36.88	38.5	1.62
	BPSK	30	29.95	10.0	17.0	36.95	38.5	1.55
3675.00	64-QAM	30	29.67	10.0	17.0	36.67	38.5	1.83
	16-QAM	30	29.56	10.0	17.0	36.56	38.5	1.94
	QPSK	30	29.54	10.0	17.0	36.54	38.5	1.96
	BPSK	30	29.50	10.0	17.0	36.50	38.5	2.00
3696.50	64-QAM	30	29.83	10.0	17.0	36.83	38.5	1.67
	16-QAM	30	29.67	10.0	17.0	36.67	38.5	1.83
	QPSK	30	29.63	10.0	17.0	36.63	38.5	1.87
	BPSK	30	29.65	10.0	17.0	36.65	38.5	1.85

EIRP limit calculation: 25 W/25 MHz equals to 44 dBm/25 MHz. Since channel bandwidth is 7 MHz, the limit is as follows: $44 \text{ dBm} - 10 \times \text{Log} (25 / 7) = 44 \text{ dBm} - 5.5 \text{ dB} = 38.5 \text{ dBm}/7 \text{ MHz}$.

**Peak EIRP power density
 3.5 MHz channel bandwidth**

Frequency (MHz)	Modulation	Power setting (dBm)	Measured PSD (dBm)	Cable/ Splitter loss (dB)	Antenna gain (dBi)	EIRP PSD (dBm)	Limit (dBm)	Margin (dB)
3651.75	64-QAM	27	21.31	10.0	17.0	28.31	30.0	1.69
	16-QAM	27	21.29	10.0	17.0	28.29	30.0	1.71
	QPSK	27	21.29	10.0	17.0	28.29	30.0	1.71
	BPSK	27	21.28	10.0	17.0	28.28	30.0	1.72
3675.00	64-QAM	27	21.63	10.0	17.0	28.63	30.0	1.37
	16-QAM	27	21.62	10.0	17.0	28.62	30.0	1.38
	QPSK	27	21.63	10.0	17.0	28.63	30.0	1.37
	BPSK	27	21.65	10.0	17.0	28.65	30.0	1.35
3698.25	64-QAM	27	21.26	10.0	17.0	28.26	30.0	1.74
	16-QAM	27	21.24	10.0	17.0	28.24	30.0	1.76
	QPSK	27	21.29	10.0	17.0	28.29	30.0	1.71
	BPSK	27	21.31	10.0	17.0	28.31	30.0	1.69

7 MHz channel bandwidth

Frequency (MHz)	Modulation	Power setting (dBm)	Measured PSD (dBm)	Cable/ Splitter loss (dB)	Antenna gain (dBi)	EIRP PSD (dBm)	Limit (dBm)	Margin (dB)
3653.50	64-QAM	30	22.96	10.0	17.0	29.96	30.0	0.04
	16-QAM	30	22.97	10.0	17.0	29.97	30.0	0.03
	QPSK	30	22.97	10.0	17.0	29.97	30.0	0.03
	BPSK	30	22.94	10.0	17.0	29.94	30.0	0.06
3675.00	64-QAM	30	22.53	10.0	17.0	29.53	30.0	0.47
	16-QAM	30	22.55	10.0	17.0	29.55	30.0	0.45
	QPSK	30	22.56	10.0	17.0	29.56	30.0	0.44
	BPSK	30	22.58	10.0	17.0	29.58	30.0	0.42
3696.50	64-QAM	30	22.45	10.0	17.0	29.45	30.0	0.55
	16-QAM	30	22.44	10.0	17.0	29.44	30.0	0.56
	QPSK	30	22.42	10.0	17.0	29.42	30.0	0.58
	BPSK	30	22.37	10.0	17.0	29.37	30.0	0.63

Output Power 3.5 MHz channel bandwidth 64-QAM – low channel



64-QAM – mid channel

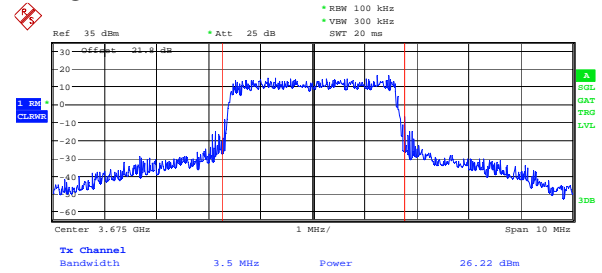

64-QAM – high channel

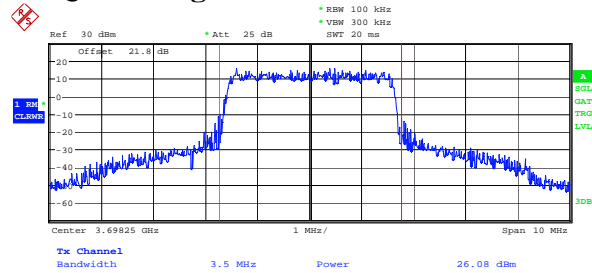

16-QAM – low channel

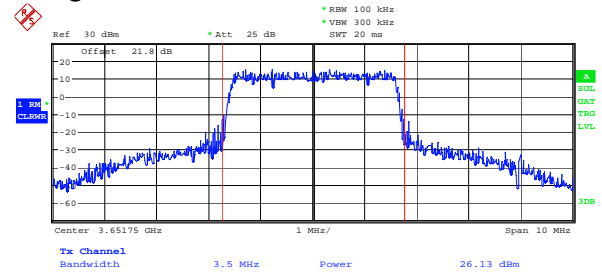

16-QAM – mid channel

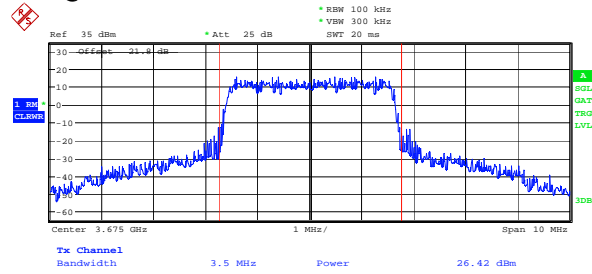

16-QAM – high channel

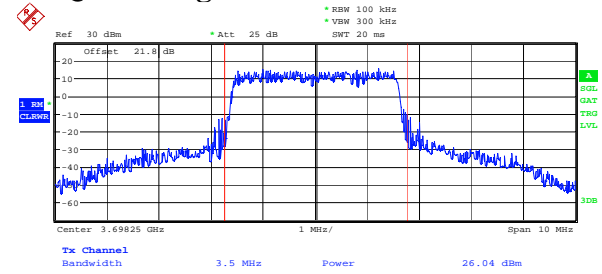

QPSK – low channel



QPSK – mid channel

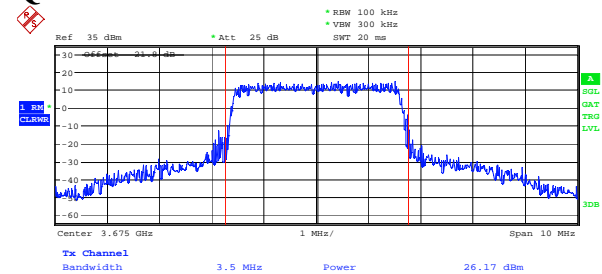

QPSK – high channel

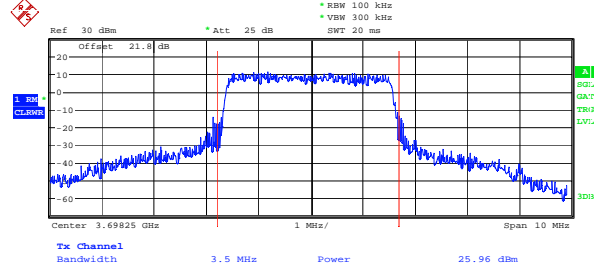

BPSK – low channel

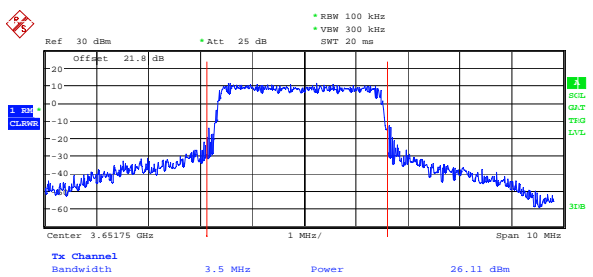

BPSK – mid channel

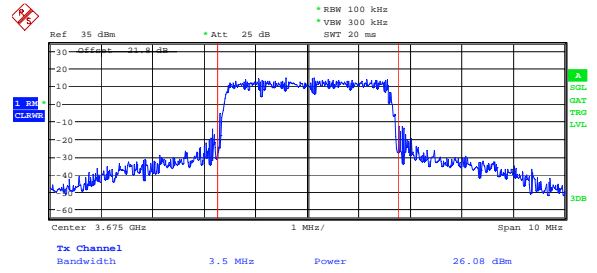

BPSK – high channel

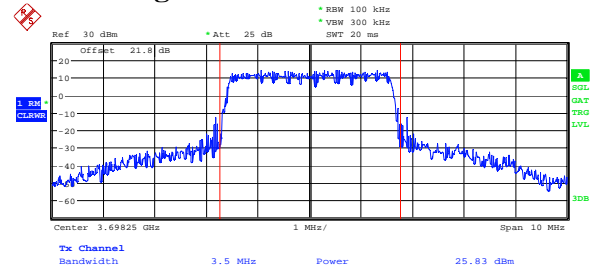

**7 MHz channel bandwidth
 64-QAM – low channel**

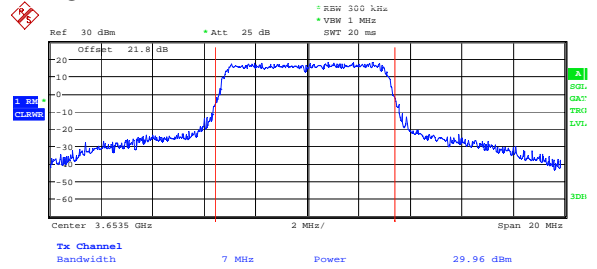

64-QAM – mid channel

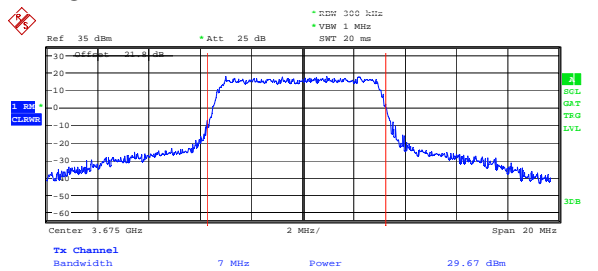

64-QAM – high channel

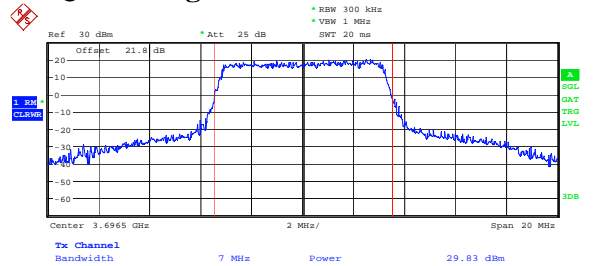

16-QAM – low channel

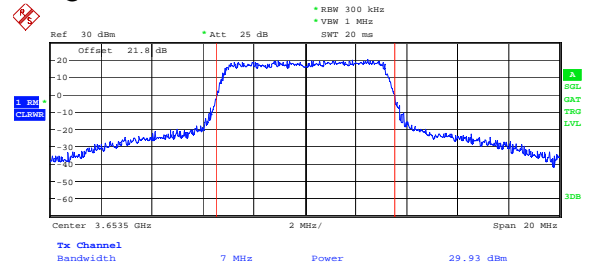

16-QAM – mid channel

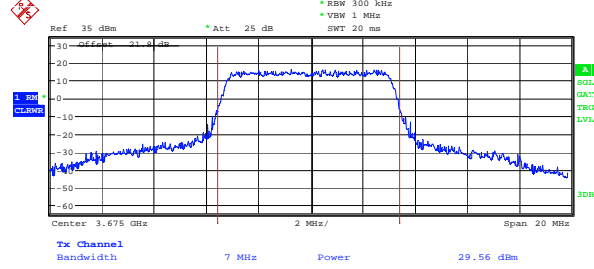

16-QAM – high channel

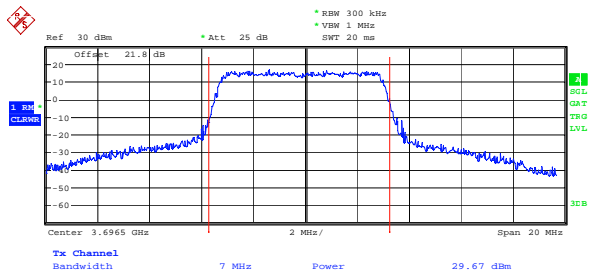

QPSK – low channel

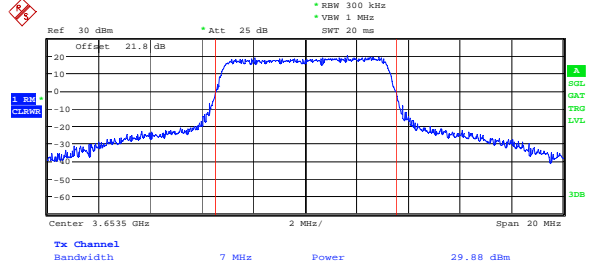

QPSK – mid channel

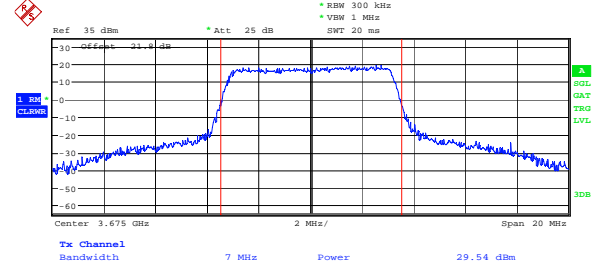

QPSK – high channel

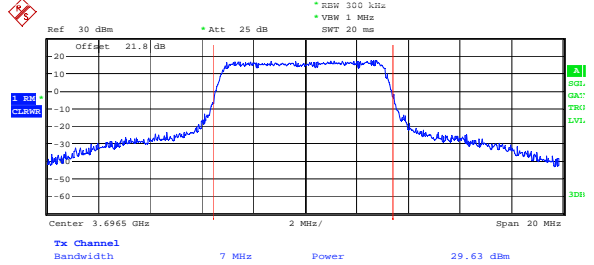

BPSK – low channel

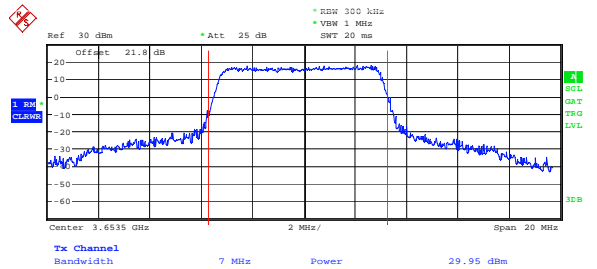

BPSK – mid channel

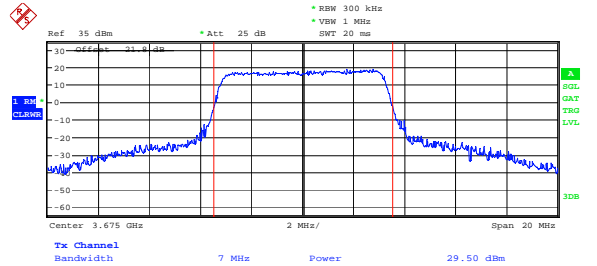

BPSK – high channel

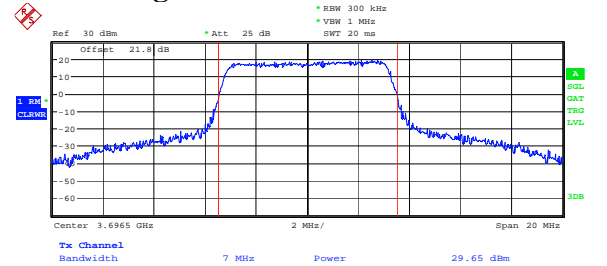



Nemko Canada Inc.

Report Number: 147118-1TRFWL
Specification: FCC Part 90 Subpart Z

PSD 3.5 MHz channel bandwidth 64-QAM – low channel

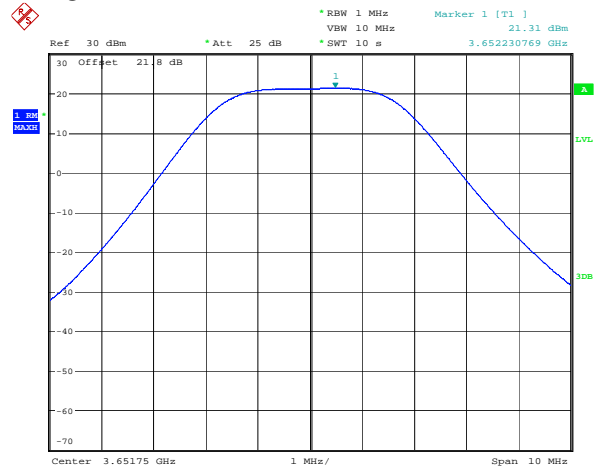

Date: 30.MAR.2010 13:32:05

64-QAM – mid channel

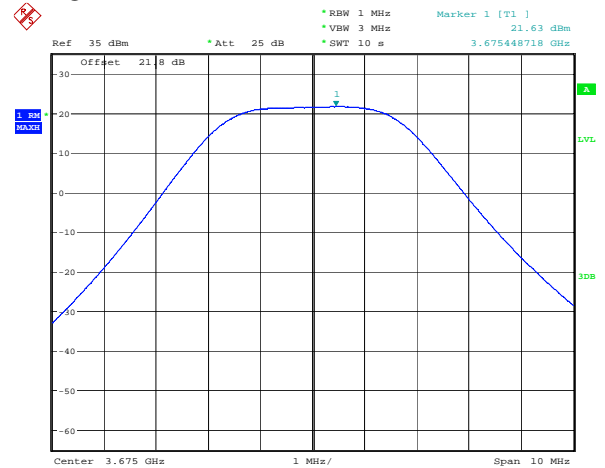

Date: 31.MAR.2010 09:51:47

64-QAM – high channel

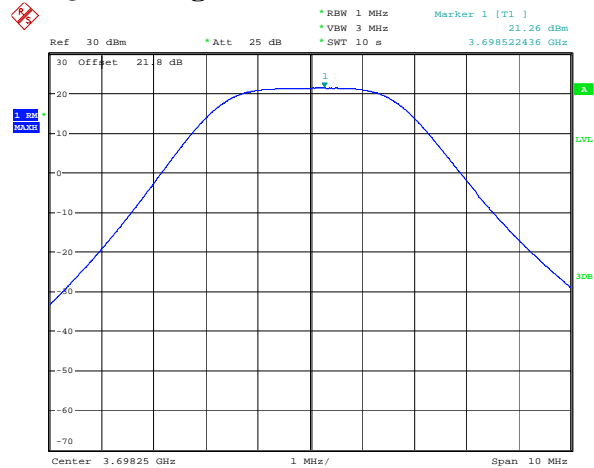

Date: 31.MAR.2010 09:24:30

16-QAM – low channel

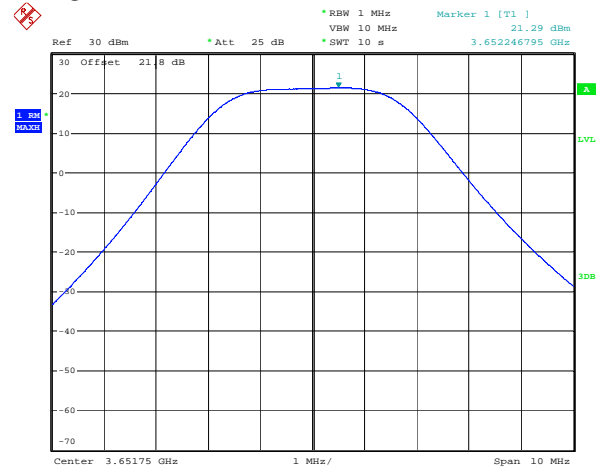

Date: 30.MAR.2010 13:32:50



Nemko Canada Inc.

Report Number: 147118-1TRFWL

Specification: FCC Part 90 Subpart Z

16-QAM – mid channel

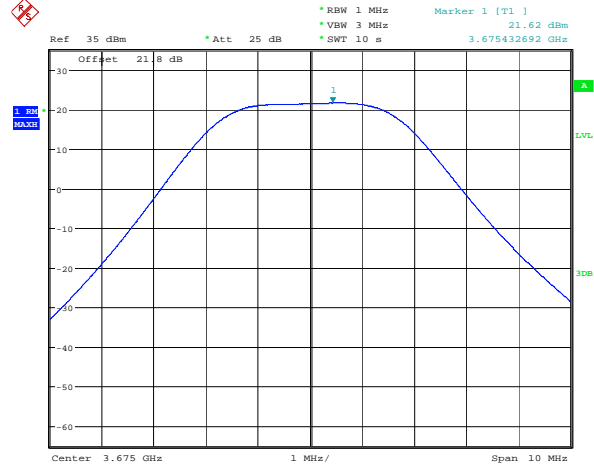

Date: 31.MAR.2010 09:51:08

16-QAM – high channel

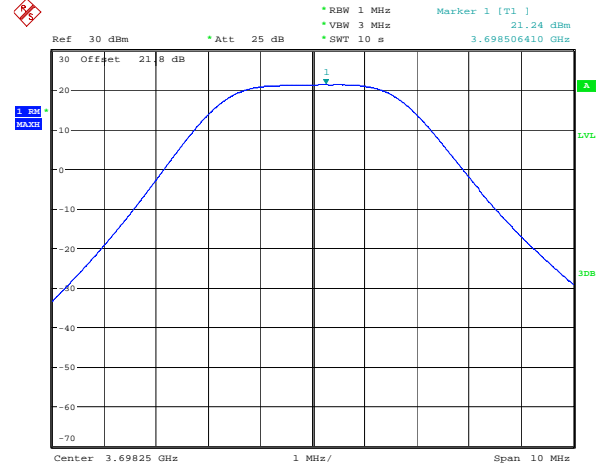

Date: 31.MAR.2010 09:23:42

QPSK – low channel

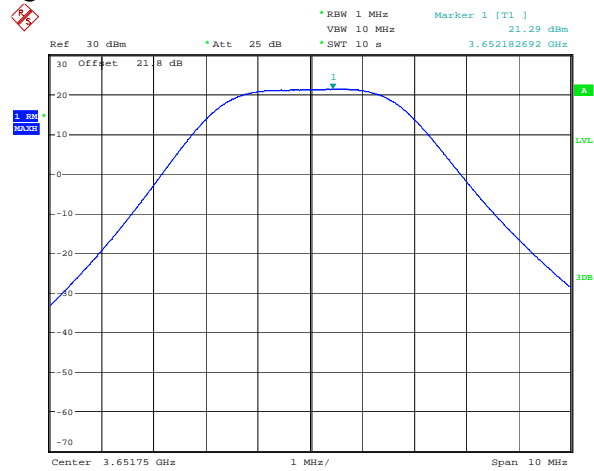

Date: 30.MAR.2010 13:33:29

QPSK – mid channel

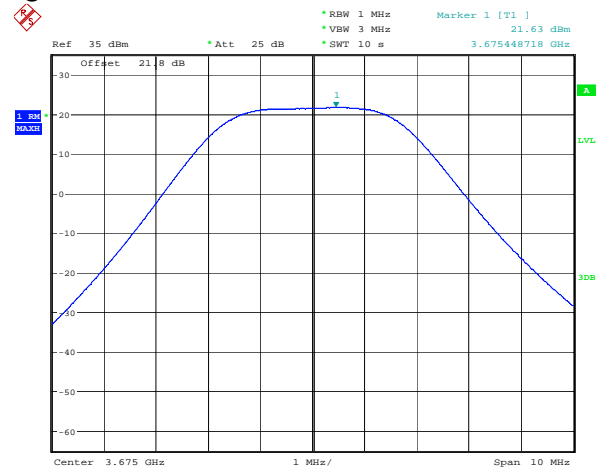

Date: 31.MAR.2010 09:50:35



Nemko Canada Inc.

Report Number: 147118-1TRFWL
Specification: FCC Part 90 Subpart Z

QPSK – high channel

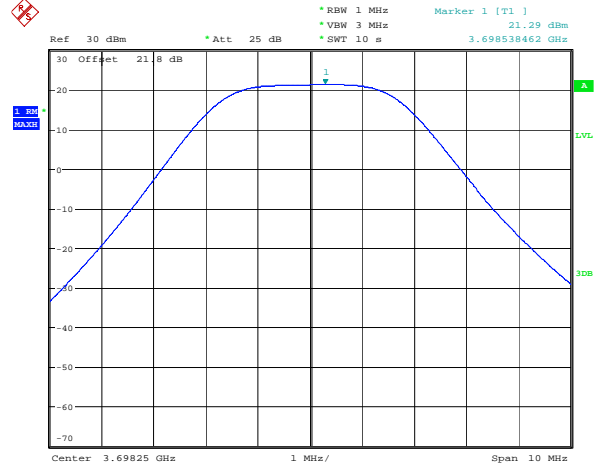

Date: 31.MAR.2010 09:23:05

BPSK – low channel

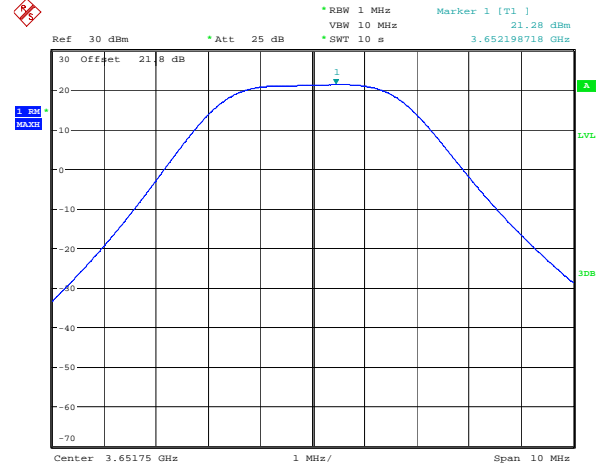

Date: 30.MAR.2010 13:34:27

BPSK – mid channel

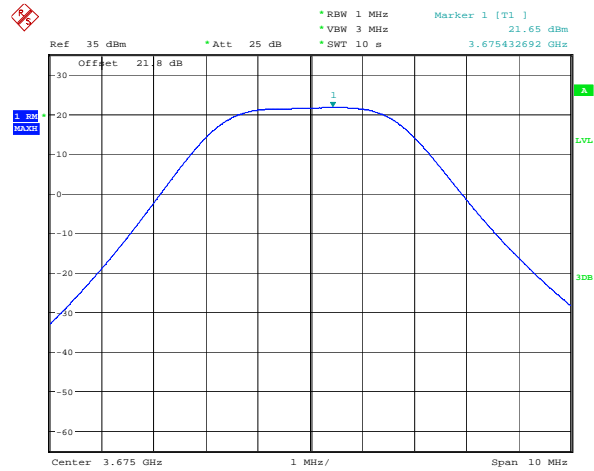

Date: 31.MAR.2010 09:50:01

BPSK – high channel

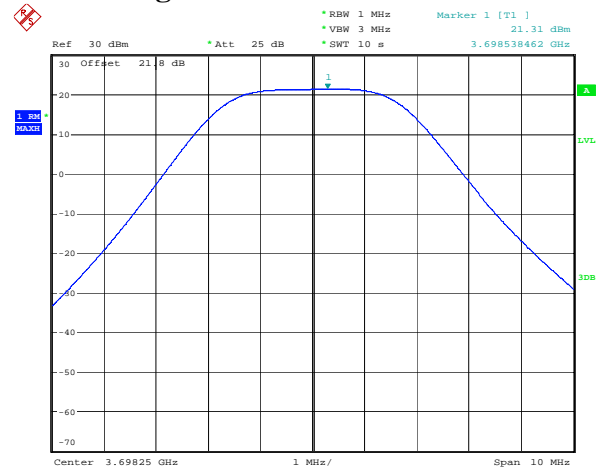

Date: 31.MAR.2010 09:22:33

7 MHz channel bandwidth
64-QAM – low channel

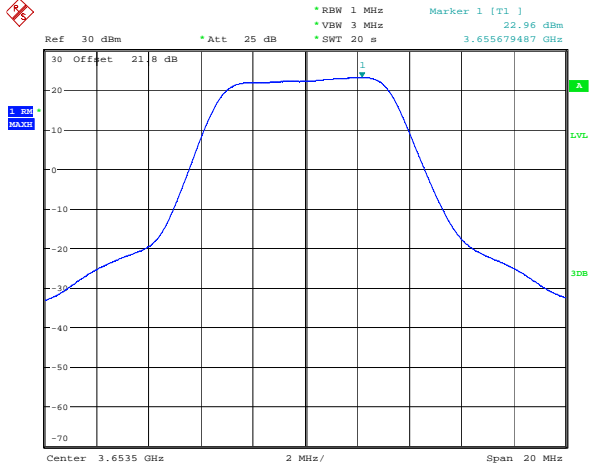

Date: 31.MAR.2010 11:37:57

64-QAM – mid channel

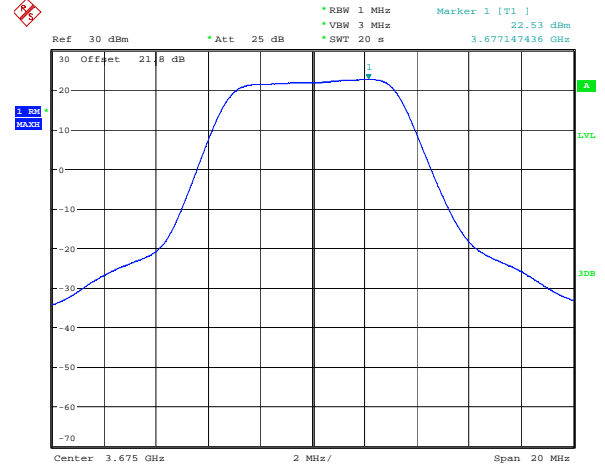

Date: 31.MAR.2010 11:13:45

64-QAM – high channel

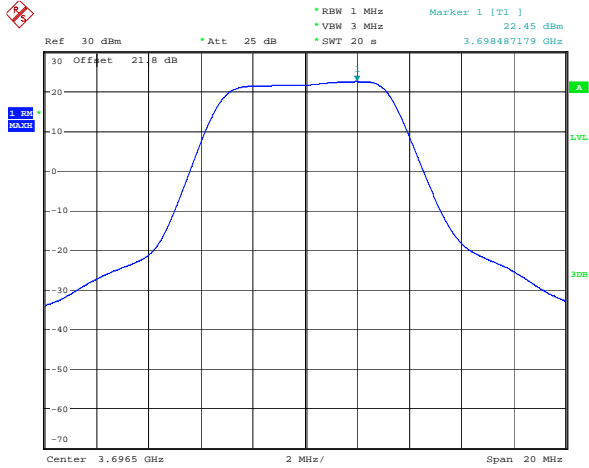

Date: 31.MAR.2010 13:55:11

16-QAM – low channel

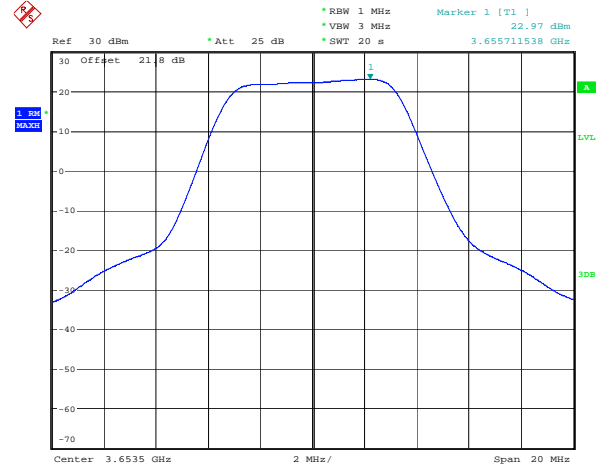

Date: 31.MAR.2010 11:38:15



Nemko Canada Inc.

Report Number: 147118-1TRFWL
Specification: FCC Part 90 Subpart Z

16-QAM – mid channel

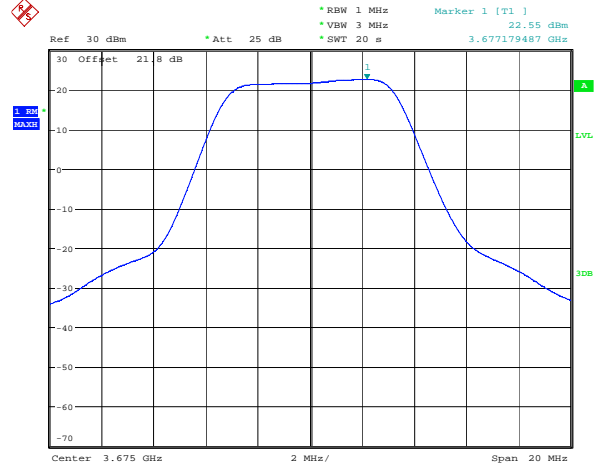

Date: 31.MAR.2010 11:13:04

16-QAM – high channel

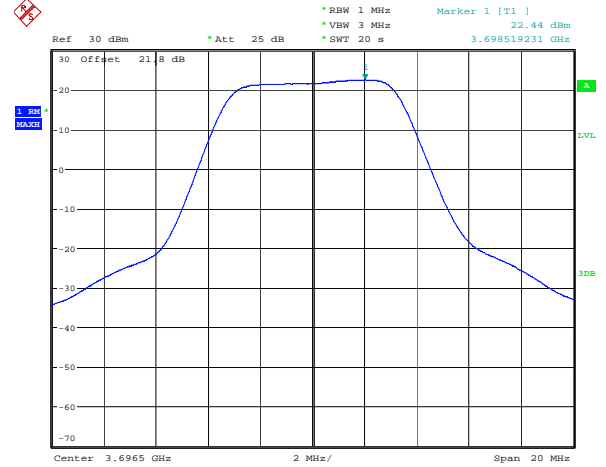

Date: 31.MAR.2010 13:55:51

QPSK – low channel

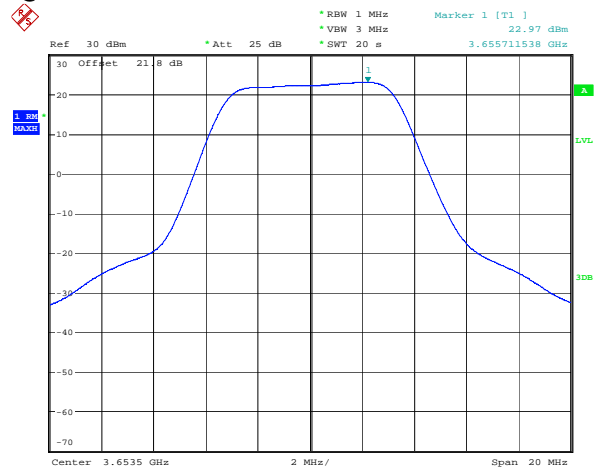

Date: 31.MAR.2010 11:38:57

QPSK – mid channel

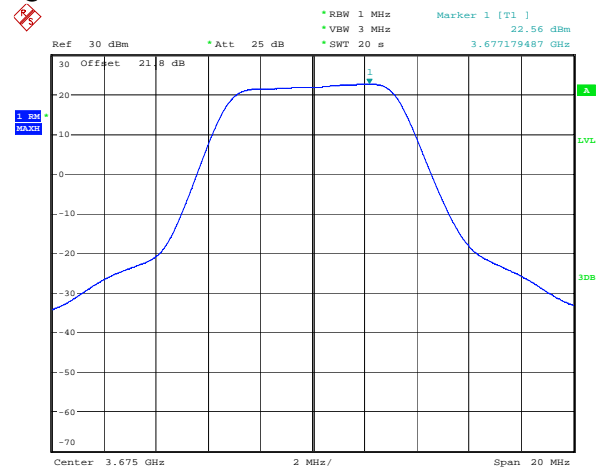

Date: 31.MAR.2010 11:12:11



Nemko Canada Inc.

Report Number: 147118-1TRFWL
Specification: FCC Part 90 Subpart Z

QPSK – high channel

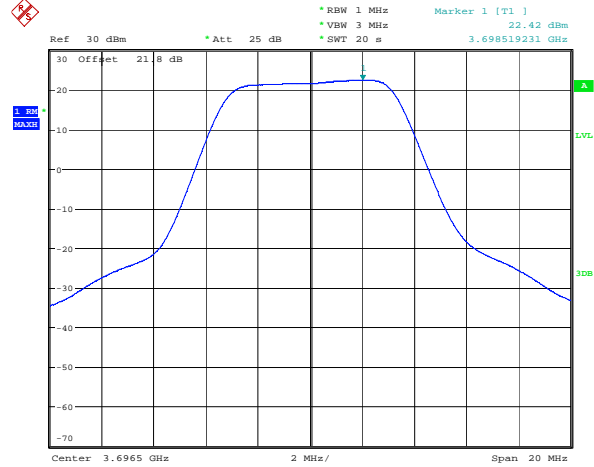

Date: 31.MAR.2010 13:56:32

BPSK – low channel

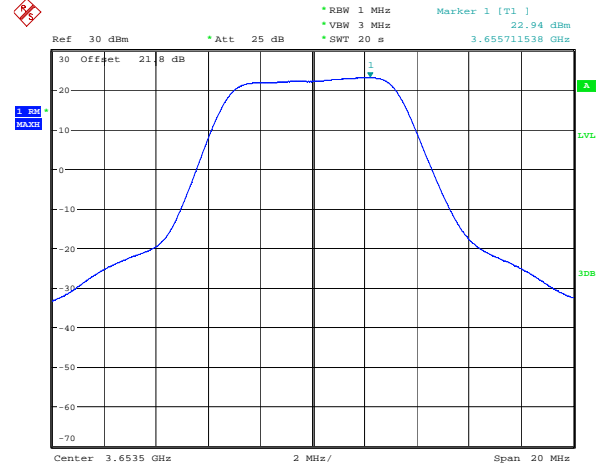

Date: 31.MAR.2010 11:39:29

BPSK – mid channel

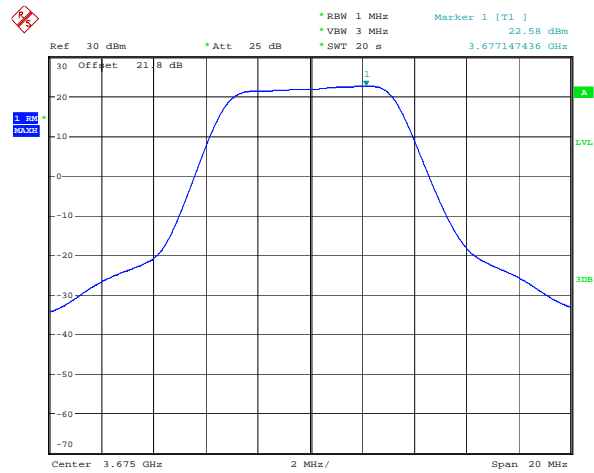

Date: 31.MAR.2010 11:11:33

BPSK – high channel

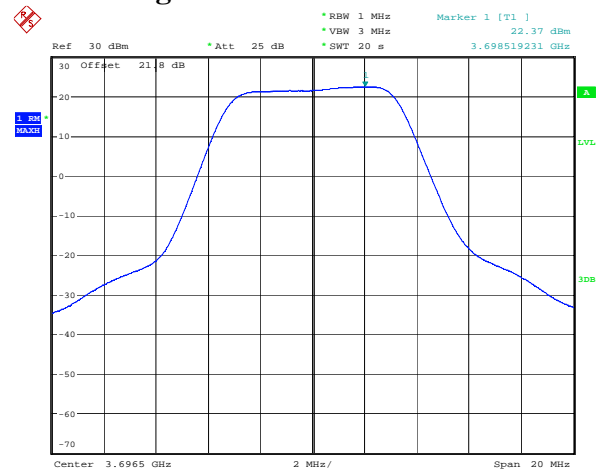

Date: 31.MAR.2010 13:57:11

Clause 90.209 Occupied Bandwidth

(5) Unless specified elsewhere, channel spacings and bandwidths that will be authorized in the following frequency bands are given in the following Table.

Standard Channel Spacing/Bandwidth		
Frequency Band (MHz)	Channel Spacing (kHz)	Authorized Bandwidth (kHz)
Below 25	–	–
25–50	20	20
72–76	20	20
150–174	7.5	20/11.25/6
216–220	6.25	20/11.25/6
220–222	5	4
406–512	6.25	20/11.25/6
806–809/851–854	12.5	20
809–824/854–869	25	20
896–901/935–940	12.5	13.6
902–928	–	–
929–930	25	20
1427–1432	12.5	12.5
2450–2483.5	–	–
Above 2500	–	–

Test Results: Pass

Additional Observations: Measurement values are 99 % Occupied bandwidth.

3.5 MHz channel bandwidth:	7 MHz channel bandwidth:
Low channel: 3651.75 MHz	Low channel: 3653.5 MHz
Mid channel: 3675.00 MHz	Mid channel: 3675.00 MHz
High channel: 3698.25 MHz	High channel: 3696.5 MHz

3.5 MHz channel bandwidth

Modulation	Low channel	Mid channel	High channel
64-QAM	3.17 MHz	3.18 MHz	3.18 MHz
16-QAM	3.18 MHz	3.17 MHz	3.17 MHz
QPSK	3.17 MHz	3.17 MHz	3.20 MHz
BPSK	3.20 MHz	3.17 MHz	3.18 MHz

7 MHz channel bandwidth

Modulation	Low channel	Mid channel	High channel
64-QAM	6.31 MHz	6.31 MHz	6.28 MHz
16-QAM	6.31 MHz	6.31 MHz	6.28 MHz
QPSK	6.31 MHz	6.31 MHz	6.31 MHz
BPSK	6.31 MHz	6.34 MHz	6.31 MHz

**3.5 MHz channel bandwidth
 64-QAM – low channel**

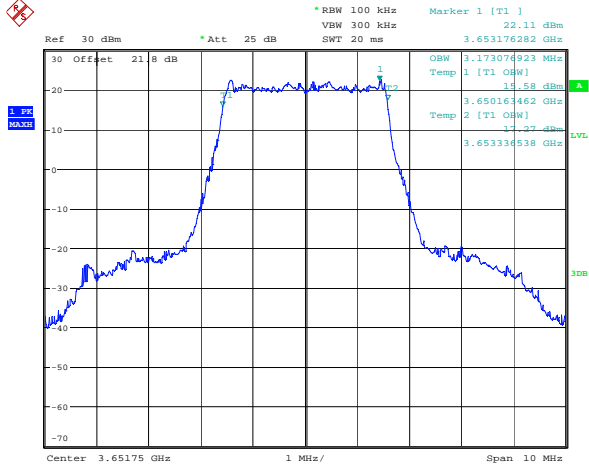

Date: 30.MAR.2010 13:37:45

64-QAM – mid channel

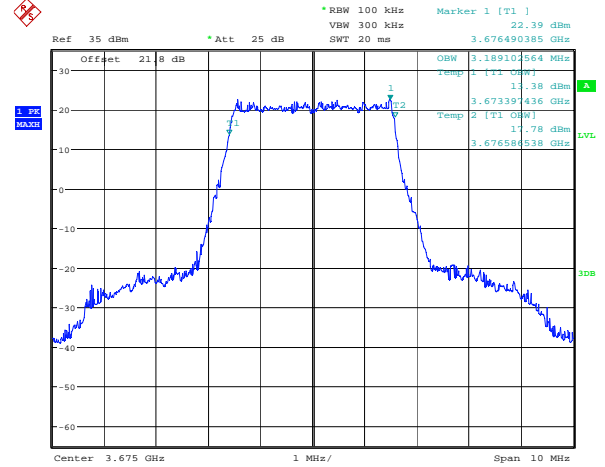

Date: 31.MAR.2010 09:52:59

64-QAM – high channel

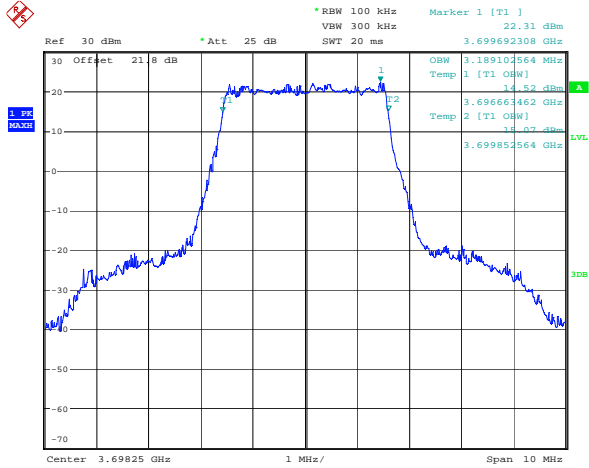

Date: 31.MAR.2010 09:25:46

16-QAM – low channel

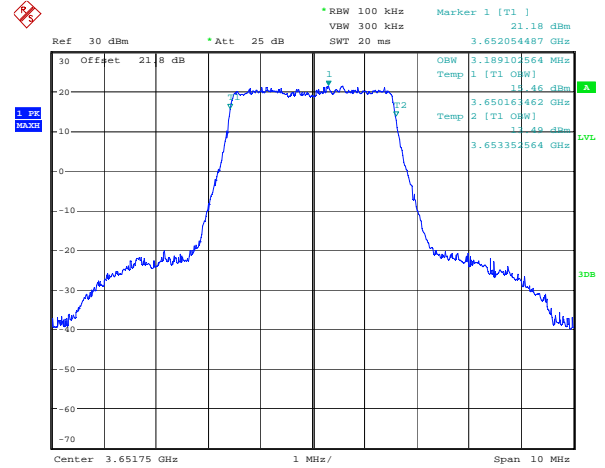

Date: 30.MAR.2010 13:38:13

16-QAM – mid channel

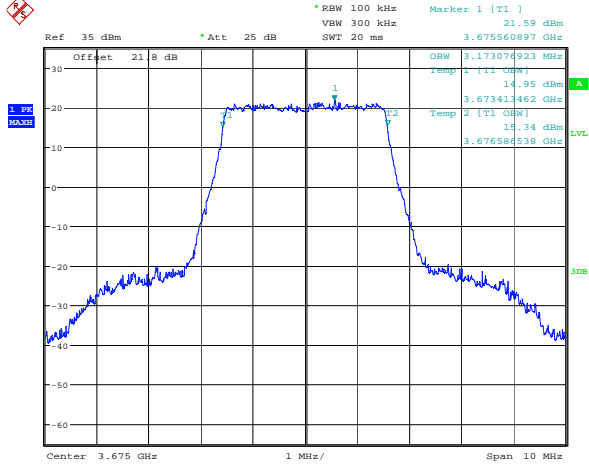

Date: 31.MAR.2010 09:53:24

16-QAM – high channel

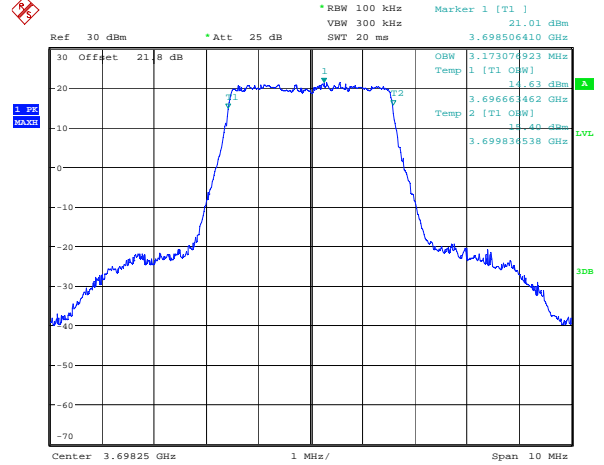

Date: 31.MAR.2010 09:26:20

QPSK – low channel

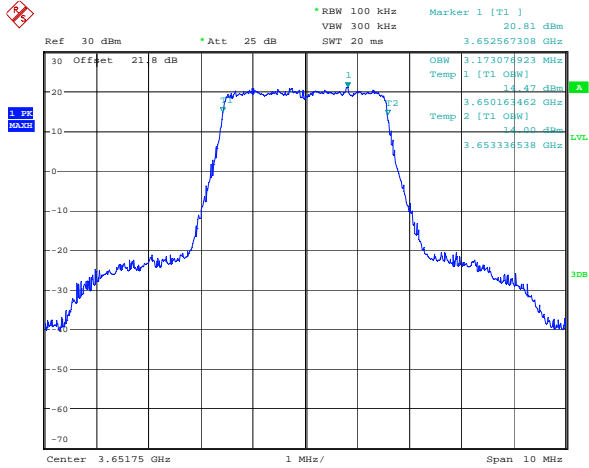

Date: 30.MAR.2010 13:38:38

QPSK – mid channel

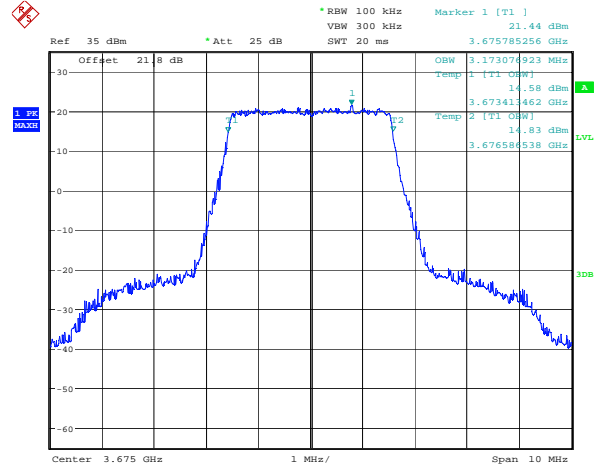

Date: 31.MAR.2010 09:53:47



Nemko Canada Inc.

Report Number: 147118-1TRFWL

Specification: FCC Part 90 Subpart Z

QPSK – high channel

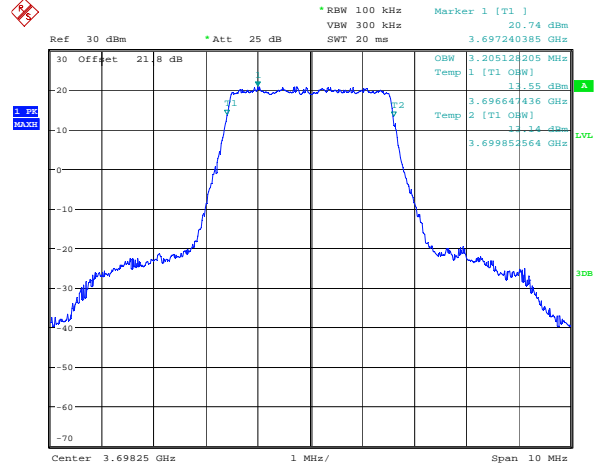

BPSK – low channel

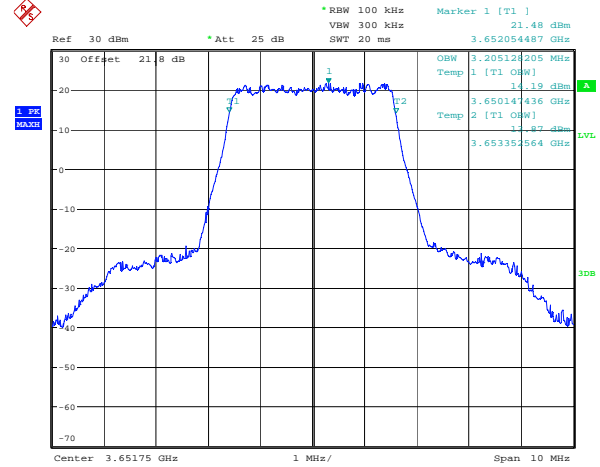

Date: 31.MAR.2010 09:27:04

Date: 30.MAR.2010 13:36:59

BPSK – mid channel

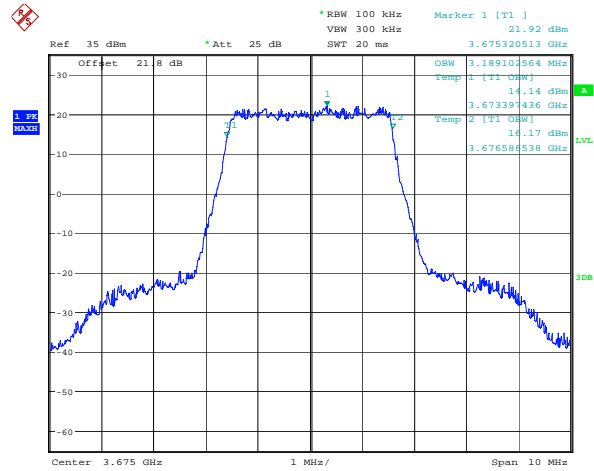

BPSK – high channel

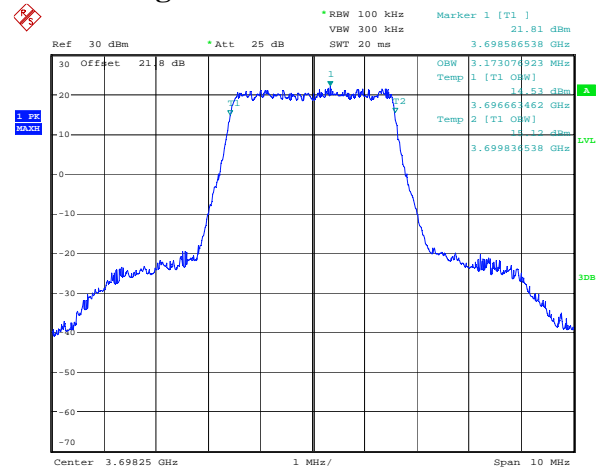

Date: 31.MAR.2010 09:54:14

Date: 31.MAR.2010 09:27:35

7 MHz channel bandwidth 64-QAM – low channel

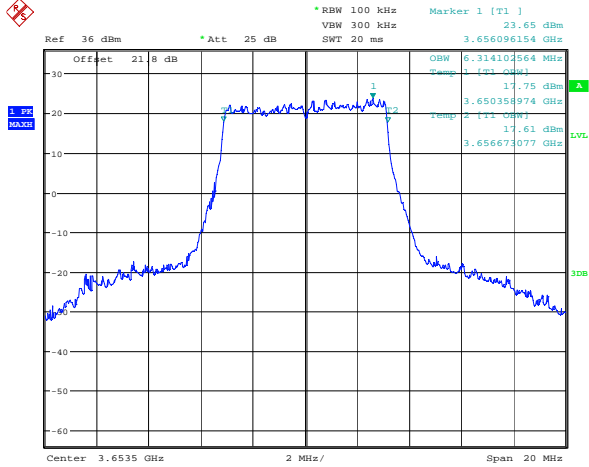

Date: 31.MAR.2010 11:29:01

64-QAM – mid channel

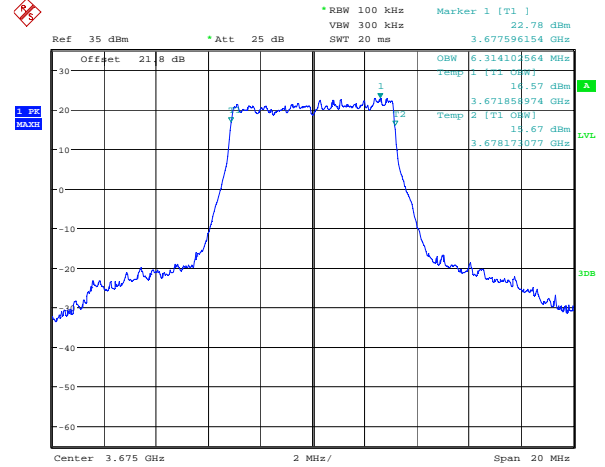

Date: 31.MAR.2010 10:50:54

64-QAM – high channel

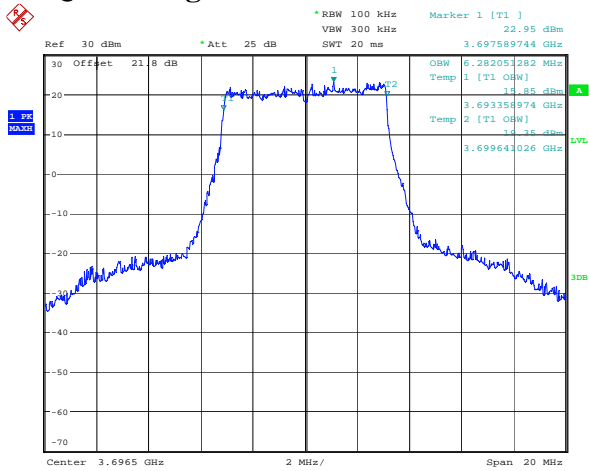

Date: 31.MAR.2010 13:49:40

16-QAM – low channel

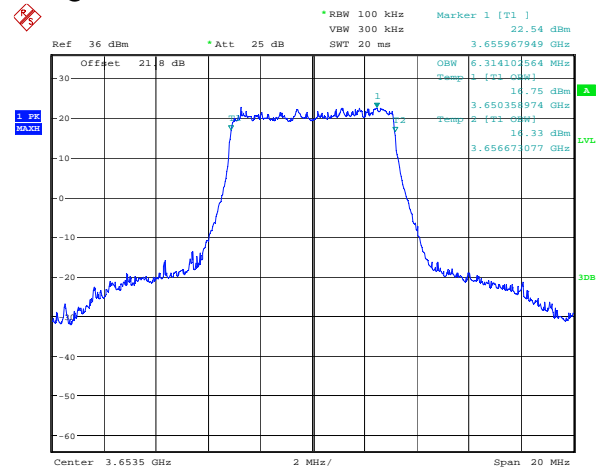

Date: 31.MAR.2010 11:29:47

16-QAM – mid channel

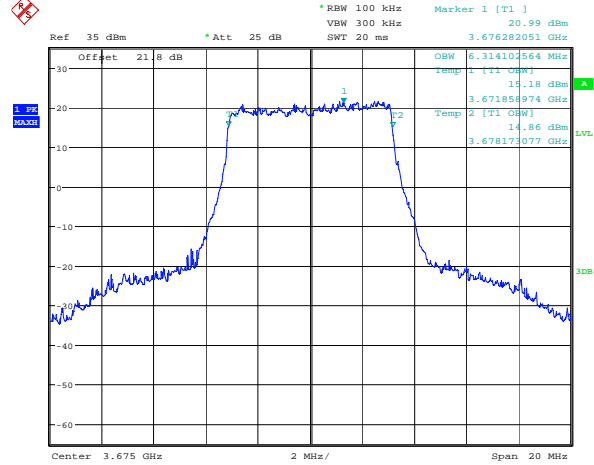

16-QAM – high channel

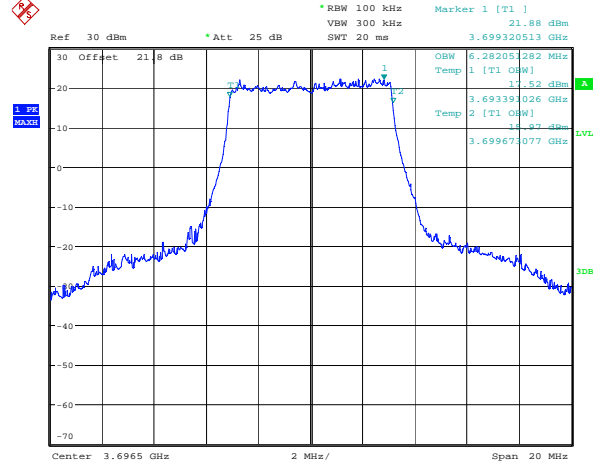

Date: 31.MAR.2010 10:51:32

Date: 31.MAR.2010 13:49:14

QPSK – low channel

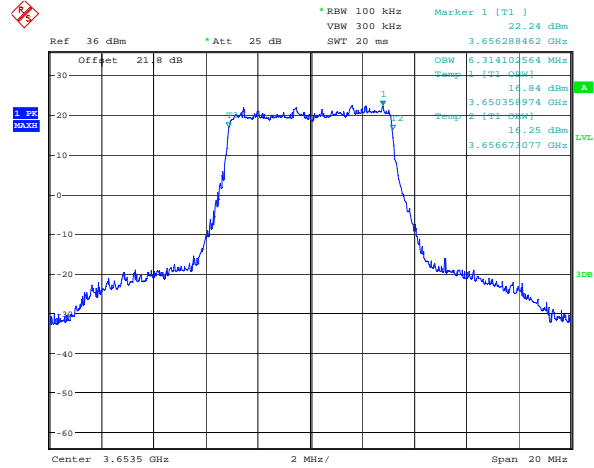

QPSK – mid channel

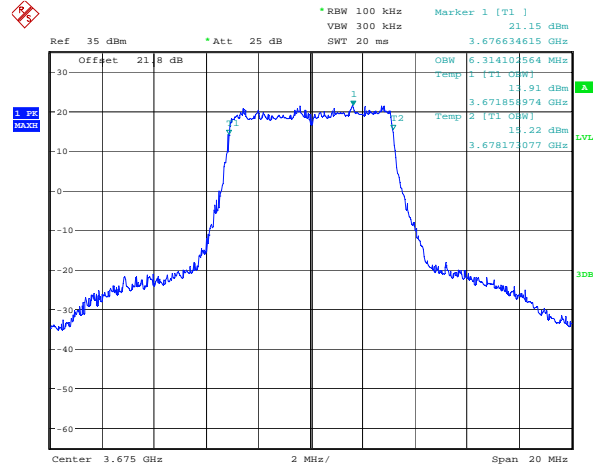

Date: 31.MAR.2010 11:30:45

Date: 31.MAR.2010 10:52:10

QPSK – high channel

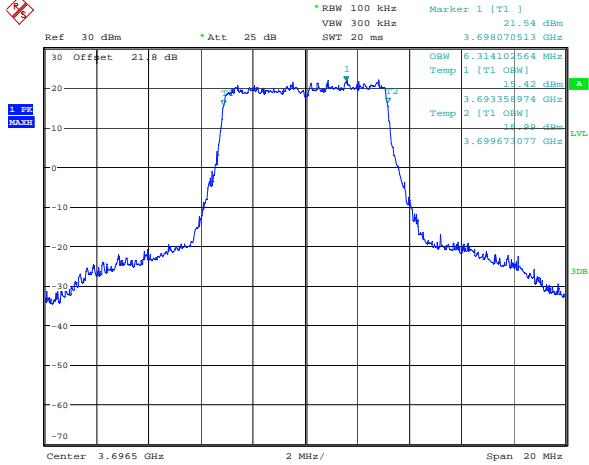

BPSK – low channel

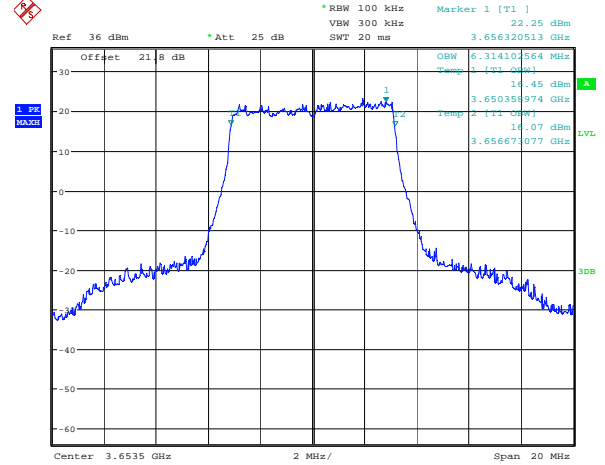

Date: 31.MAR.2010 13:48:43

Date: 31.MAR.2010 11:30:22

BPSK – mid channel

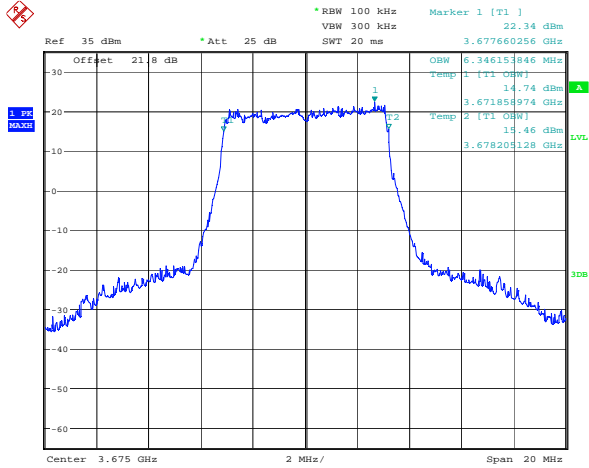

BPSK – high channel

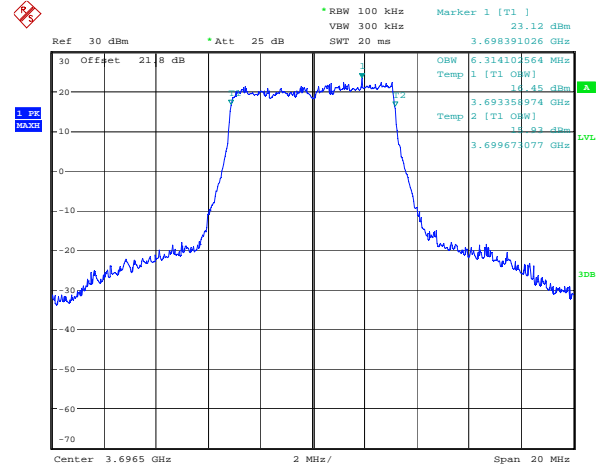

Date: 31.MAR.2010 10:52:42

Date: 31.MAR.2010 13:48:21

Clause 90.210(n)/90.1323 Emission Limits Spurious emissions at the antenna terminal

90.210 (n) Other frequency bands. Transmitters designed for operation under this part on frequencies other than listed in this section must meet the emission mask requirements of Emission Mask B. Equipment operating under this part on frequencies allocated to but shared with the Federal Government, must meet the applicable Federal Government technical standards.

Emission Mask B. For transmitters that are equipped with an audio low-pass filter, the power of any emission must be attenuated below the unmodulated carrier power (P) as follows:

- (1) On any frequency removed from the assigned frequency by more than 50 percent, but not more than 100 percent of the authorized bandwidth: At least 25 dB.
- (2) On any frequency removed from the assigned frequency by more than 100 percent, but not more than 250 percent of the authorized bandwidth: At least 35 dB.
- (3) On any frequency removed from the assigned frequency by more than 250 percent of the authorized bandwidth: At least $43 + 10 \log (P)$ dB.

90.1323 (a) The power of any emission outside a licensee's frequency band(s) of operation shall be attenuated below the transmitter power (P) within the licensed band(s) of operation measured in watts, by at least $43 + 10 \log (P)$ dB. Compliance with this provision is based on the use of measurement instrumentation employing a resolution bandwidth of 1 MHz or less, but at least one percent of the emission bandwidth of the fundamental emission of the transmitter, provided the measured energy is integrated over a 1 MHz bandwidth.

Test Results: Pass

Additional Observations: Unmodulated signal was used to determine a reference level for the emission mask, then modulation was turned on and mask measurement was performed.
Only the worst case amongst the modulations was captured.



Nemko Canada Inc.

Emission Mask – 90.210(b) 3.5 MHz channel bandwidth Low Channel

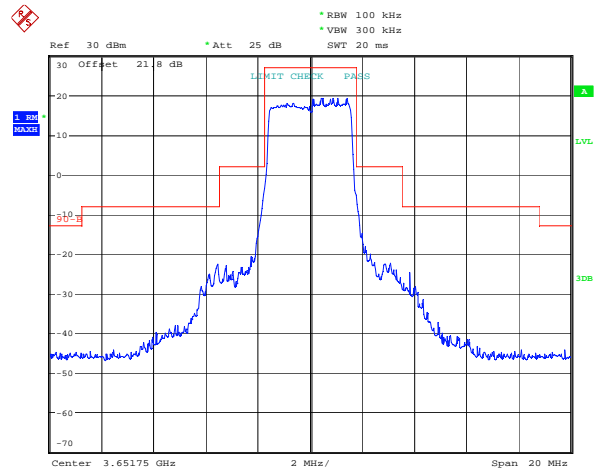

Date: 31.MAR.2010 09:01:46

Mid Channel

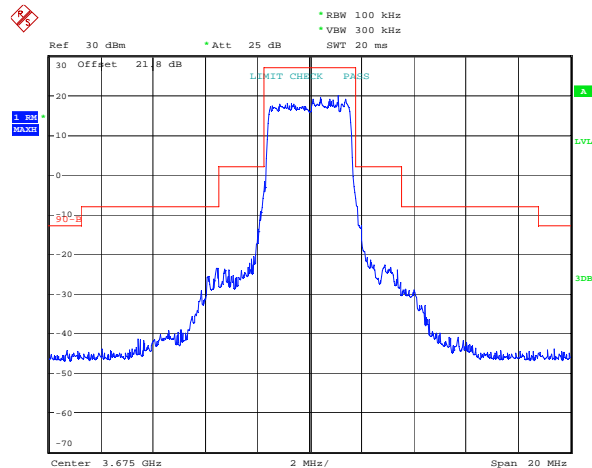

Date: 31.MAR.2010 09:04:28

High Channel

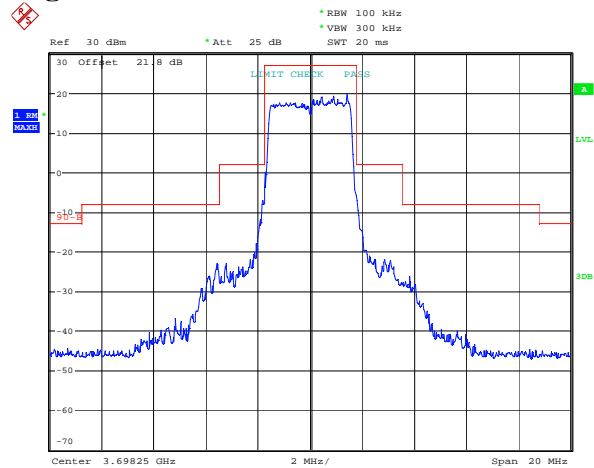

Date: 31.MAR.2010 09:08:45



Nemko Canada Inc.

7 MHz channel bandwidth

Low Channel

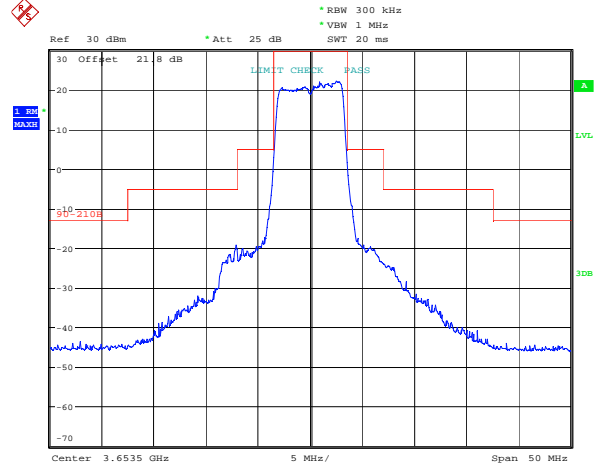

Date: 31.MAR.2010 11:25:10

Mid Channel

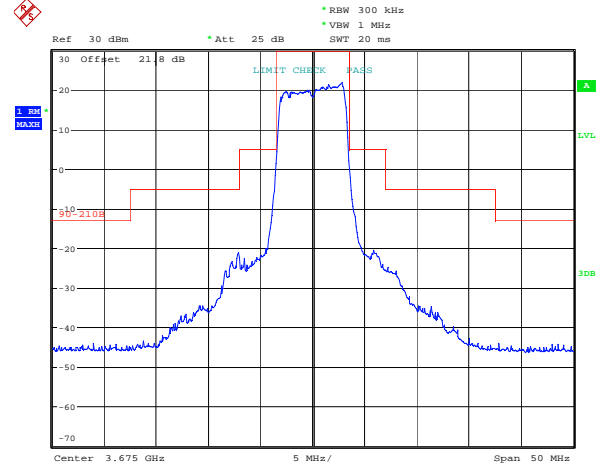

Date: 31.MAR.2010 11:21:06

High Channel

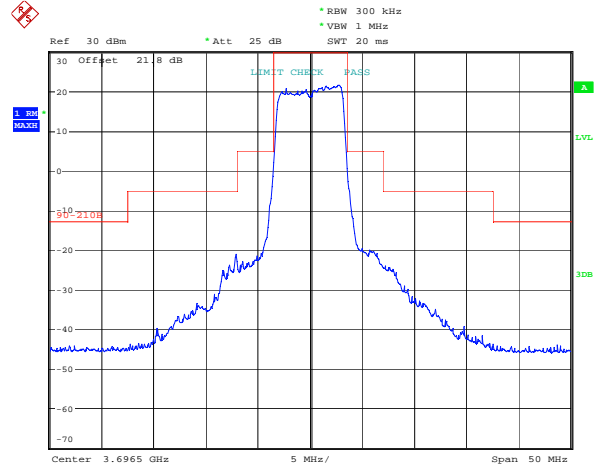

Date: 31.MAR.2010 13:51:29



Nemko Canada Inc.

Bandedge

3.5 MHz channel bandwidth

Lower band edge

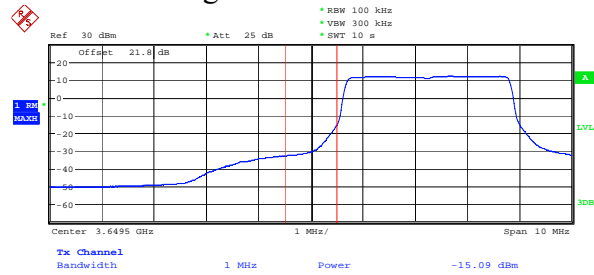

Upper band edge

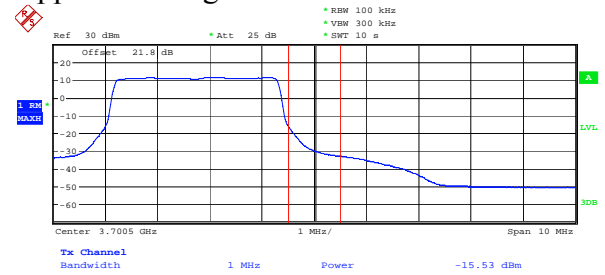

7 MHz channel bandwidth

Lower band edge

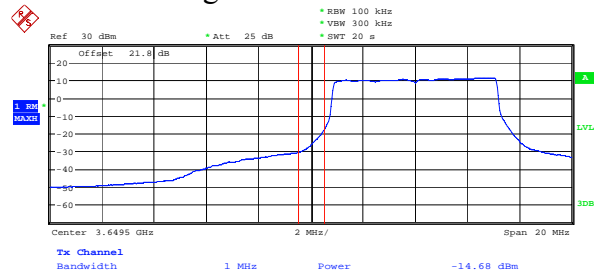

Upper band edge

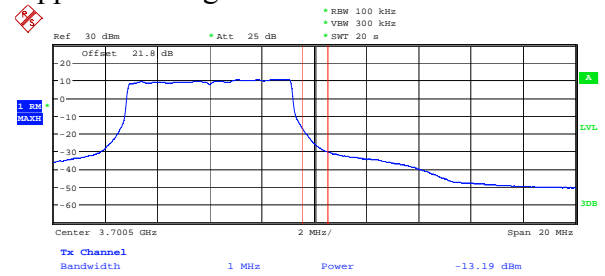



Nemko Canada Inc.

Report Number: 147118-1TRFWL

Specification: FCC Part 90 Subpart Z

Conducted spurious emissions

Conducted emissions were performed on low, mid and high channels using Max power setting of 36 dBm. Only worst-case results are included.

3.5 MHz channel bandwidth

30 MHz–1 GHz

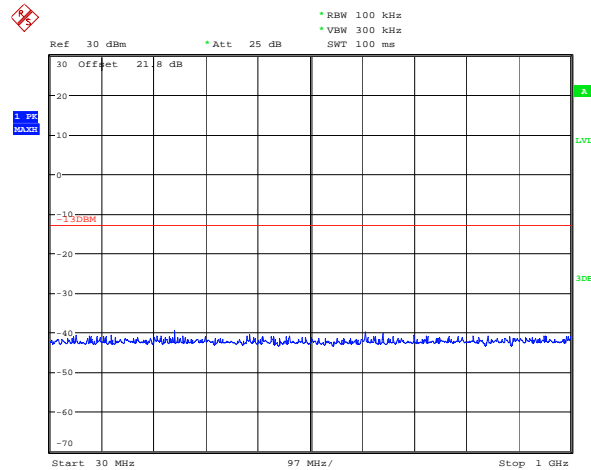

Date: 30.MAR.2010 13:47:09

1 GHz–40 GHz

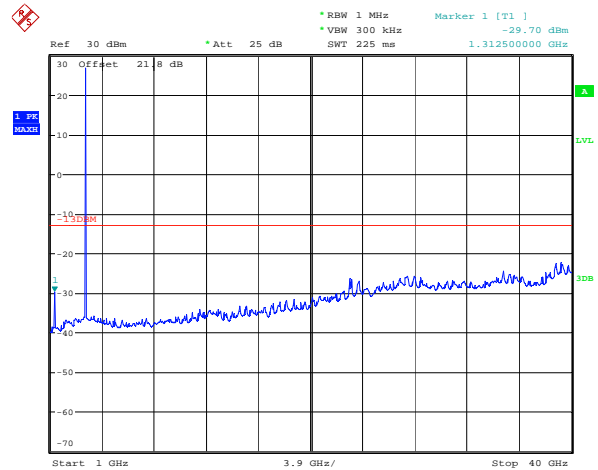

Date: 30.MAR.2010 13:48:20

7 MHz channel bandwidth

30 MHz–1 GHz

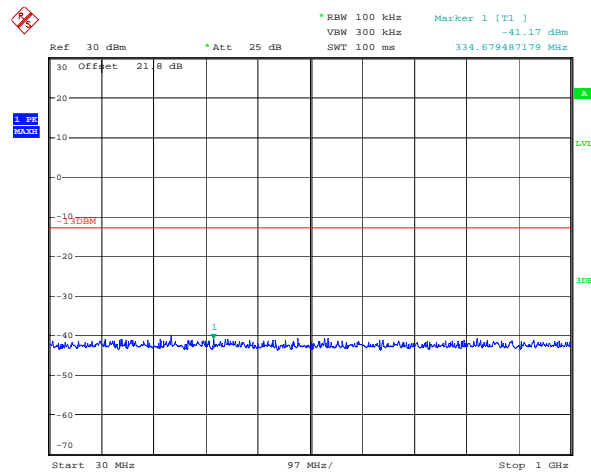

Date: 31.MAR.2010 13:52:49

1 GHz–40 GHz

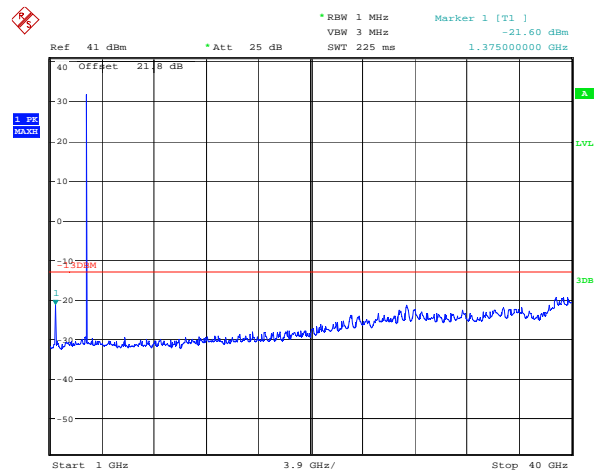

Date: 31.MAR.2010 13:53:21

Clause 90.210/90.1323 Field Strength of spurious radiation

90.1323 (a) The power of any emission outside a licensee's frequency band(s) of operation shall be attenuated below the transmitter power (P) within the licensed band(s) of operation measured in watts, by at least $43 + 10 \log (P)$ dB. Compliance with this provision is based on the use of measurement instrumentation employing a resolution bandwidth of 1 MHz or less, but at least one percent of the emission bandwidth of the fundamental emission of the transmitter, provided the measured energy is integrated over a 1 MHz bandwidth.

Test Results: Pass

Additional Observations: The Spectrum was searched from 30 MHz to 38 GHz.

All measurements were performed using a Peak Detector with 100 kHz RBW below 1 GHz and a 1 MHz RBW above 1 GHz at a distance of 3 m. Measurements above 10 GHz were performed at 1 m.

The EUT was tested with output power set to maximum 36 dBm, set to low, mid and high channels.

Radiated spurious emissions were measured by using substitution method.

Channel	Frequency (MHz)	Pol. V/H	RCVD Signal (dBμV)	Substitution equivalent		ERP (dBm)	Limit (dBm)	Margin (dB)
				SG out, (dBm)	Ant. Gain (dBd)			
Low	7303.91	V	33.21	-27.85	7.87	-19.96	-13.00	6.96
	7304.55	H	28.66	-31.35	7.87	-23.46	-13.00	10.46
Mid	7350.65	V	34.18	-26.84	7.87	-18.97	-13.00	5.87
	7350.93	H	30.81	-29.14	7.87	-21.27	-13.00	8.27
High	7395.51	V	35.81	-25.25	7.93	-17.32	-13.00	4.32
	7395.75	H	31.58	-28.40	7.93	-20.47	-13.00	7.47

ERP calculation = Signal generator level + Antenna gain

Clause 90.213 Frequency Stability

a) Unless noted elsewhere, transmitters used in the services governed by this part must have a minimum frequency stability as specified in the following Table.

Frequency range (MHz)	Minimum Frequency Stability parts per million (ppm)		
	Fixed and base stations	Mobile stations	
		Over 2 watts output power	2 watts or less output power
Below 25	100	100	200
25-50	20	20	50
72-76	5	-	50
150-174	50	5	50
216-220	1.0	-	1.0
220-222	0.1	1.5	1.5
421-512	2.5	5	5
806-809	1.0	1.5	1.5
809-824	1.5	2.5	2.5
851-854	1.0	1.5	1.5
854-869	1.5	2.5	2.5
896-901	0.1	1.5	1.5
902-928	2.5	2.5	2.5
929-930	1.5	-	-
935-940	0.1	1.5	1.5
1427-1435	300	300	300
Above 2450	-	-	-

Test Results: Pass

Condition	Offset (Hz)	Offset (ppm)
+50°C, Nominal Voltage	-1000	-0.27
+40°C, Nominal Voltage	0	0.00
+30°C, Nominal Voltage	-1000	-0.27
+20°C, +15% Nominal Voltage	250	0.07
+20°C, Nominal Voltage	—	—
+20°C, -15% Nominal Voltage	-2250	-0.62
+10°C, Nominal Voltage	-2250	-0.62
0°C, Nominal Voltage	-2250	-0.62
-10°C, Nominal Voltage	-1500	-0.41
-20°C, Nominal Voltage	500	0.14
-30°C, Nominal Voltage	4750	1.30

Appendix B : Setup Photographs

Radiated Spurious Emissions Setup:



Appendix C : Block Diagram of Test Setups

Test Site For Radiated Emissions

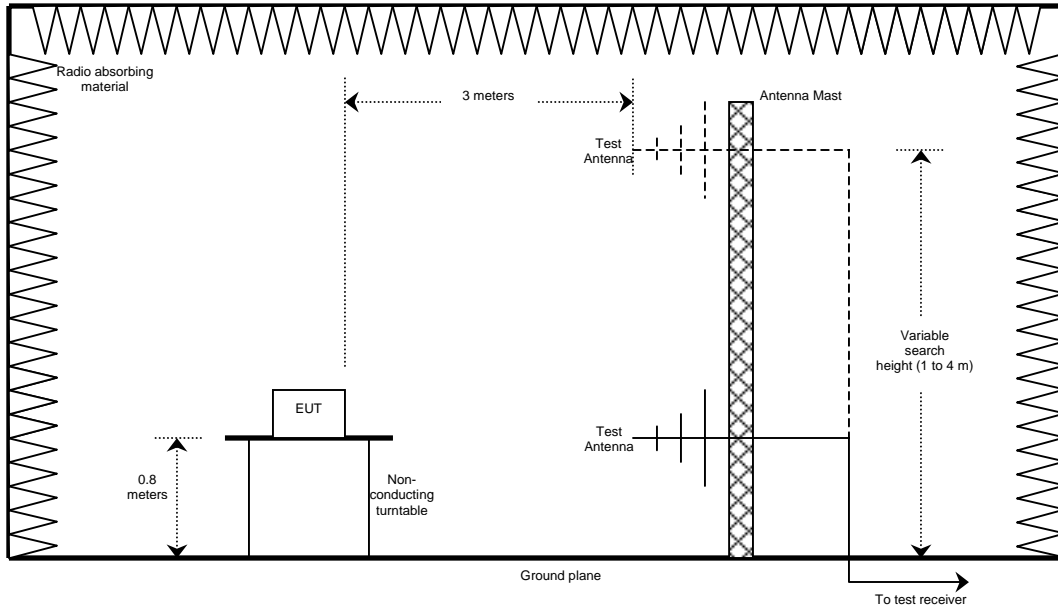

Conducted Emissions, Output power, Occupied Bandwidth

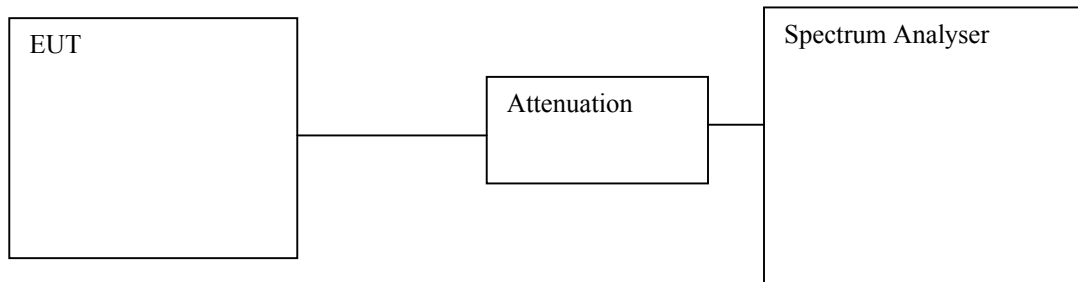

Frequency Stability

