

ENGINEERING TEST REPORT

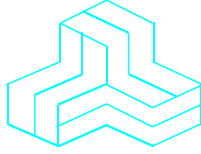

**4G V-Station Extreme
Model No.: ESTVHW**

FCC ID: QC4-ESTVHW

Applicant:

Bioscrypt Inc.
505 Cochrane Drive
Markham, ON
Canada L3R 8E3

In Accordance With

**Federal Communications Commission (FCC)
Part 15, Subpart C, Section 15.247
Digital Modulation Systems (DTS) Operating in 2412-2462 MHz Band**

UltraTech's File No.: MYT-155F15C247

This Test report is Issued under the Authority of
Tri M. Luu, Professional Engineer,
Vice President of Engineering
UltraTech Group of Labs

Date: October 23, 2009



Report Prepared by: Dan Huynh

Tested by: Hung Trinh & Wayne Wu

Issued Date: October 23, 2009

Test Dates: March 24-30, 2009
October 19, 2009

*The results in this Test Report apply only to the sample(s) tested, and the sample tested is randomly selected.
This report must not be used by the client to claim product endorsement by NVLAP or any agency of the US Government.*

UltraTech

3000 Bristol Circle, Oakville, Ontario, Canada, L6H 6G4
Tel.: (905) 829-1570 Fax.: (905) 829-8050
Website: www.ultratech-labs.com, Email: vic@ultratech-labs.com, Email: tri@ultratech-labs.com



0685



91038



1309



46390-2049



NvLap Lab
Code 200093-0



SL2-IN-E-1119R



Korea KCC-RRL

CA2049

TABLE OF CONTENTS

EXHIBIT 1.	INTRODUCTION.....	1
1.1.	SCOPE	1
1.2.	RELATED SUBMITTAL(S)/GRANT(S).....	1
1.3.	NORMATIVE REFERENCES	1
EXHIBIT 2.	PERFORMANCE ASSESSMENT	2
2.1.	CLIENT INFORMATION	2
2.2.	EQUIPMENT UNDER TEST (EUT) INFORMATION.....	2
2.3.	EUT’S TECHNICAL SPECIFICATIONS	3
2.4.	LIST OF EUT’S PORTS	3
2.5.	ANCILLARY EQUIPMENT	4
2.6.	GENERAL TEST SETUP BLOCK DIAGRAM	4
EXHIBIT 3.	EUT OPERATING CONDITIONS AND CONFIGURATIONS DURING TESTS.....	5
3.1.	CLIMATE TEST CONDITIONS	5
3.2.	OPERATIONAL TEST CONDITIONS & ARRANGEMENT FOR TESTS	5
EXHIBIT 4.	SUMMARY OF TEST RESULTS.....	6
4.1.	LOCATION OF TESTS	6
4.2.	APPLICABILITY & SUMMARY OF EMC EMISSION TEST RESULTS	6
4.3.	MODIFICATIONS INCORPORATED IN THE EUT FOR COMPLIANCE PURPOSES	7
EXHIBIT 5.	MEASUREMENTS, EXAMINATIONS & TEST DATA FOR EMC EMISSIONS	8
5.1.	TEST PROCEDURES.....	8
5.2.	MEASUREMENT UNCERTAINTIES.....	8
5.3.	MEASUREMENT EQUIPMENT USED	8
5.4.	ESSENTIAL/PRIMARY FUNCTIONS AS DECLARED BY THE MANUFACTURER	8
5.5.	OCCUPIED BANDWIDTH [§ 15.247(A)(2)]	9
5.6.	PEAK CONDUCTED OUTPUT POWER - DTS [§ 15.247(B)(3)].....	32
5.7.	TRANSMITTER BAND-EDGE & SPURIOUS CONDUCTED EMISSIONS [§ 15.247(D)].....	33
5.8.	TRANSMITTER SPURIOUS RADIATED EMISSIONS AT 3 METERS [§§ 15.247(D), 15.209 & 15.205].....	50
5.9.	POWER SPECTRAL DENSITY [§ 15.247(E)]	61
5.10.	RF EXPOSURE REQUIRMENTS [§§ 15.247(I), 1.1307(B)(1) & 2.1093].....	68
EXHIBIT 6.	TEST EQUIPMENT LIST	71
EXHIBIT 7.	MEASUREMENT UNCERTAINTY.....	72
7.1.	LINE CONDUCTED EMISSION MEASUREMENT UNCERTAINTY	72
7.2.	RADIATED EMISSION MEASUREMENT UNCERTAINTY	73

EXHIBIT 1. INTRODUCTION

1.1. SCOPE

Reference:	FCC Part 15, Subpart C, Section 15.247
Title:	Code of Federal Regulations (CFR), Title 47 – Telecommunication, Part 15
Purpose of Test:	Equipment Certification for Digital Modulation Systems (DTS) Transmitter Operating in the Frequency Band 2400-2483.5 MHz
Test Procedures:	Both conducted and radiated emissions measurements were conducted in accordance with American National Standards Institute ANSI C63.4 - American National Standard for Methods of Measurement of Radio-Noise Emissions from Low-Voltage Electrical and Electronic Equipment in the Range of 9 kHz to 40 GHz.
Environmental Classification:	[x] Commercial, industrial or business environment [] Residential environment

1.2. RELATED SUBMITTAL(S)/GRANT(S)

None.

1.3. NORMATIVE REFERENCES

Publication	Year	Title
47 CFR Parts 0-19	2008	Code of Federal Regulations – Telecommunication
ANSI C63.4	2003	American National Standard for Methods of Measurement of Radio-Noise Emissions from Low-Voltage Electrical and Electronic Equipment in the Range of 9 kHz to 40 GHz
CISPR 22 & EN 55022	2006 2006	Information Technology Equipment - Radio Disturbance Characteristics – Limits and Methods of Measurement
CISPR 16-1-1 +A1 +A2	2006 2006 2007	Specification for radio disturbance and immunity measuring apparatus and methods. Part 1-1: Measuring Apparatus
CISPR 16-1-2 +A1 +A2	2003 2004 2006	Specification for radio disturbance and immunity measuring apparatus and methods. Part 1-2: Conducted disturbances
KDB Publication No. 558074	2005	Guidance on Measurements for Digital Transmission Systems (47 CFR 15.247)
KDB Publication No. 447498	2008	Mobile and Portable Device RF Exposure Procedure and Equipment Authorization Policies

ULTRATECH GROUP OF LABS

3000 Bristol Circle, Oakville, Ontario, Canada L6H 6G4
 Tel. #: 905-829-1570, Fax. #: 905-829-8050, Email: vic@ultratech-labs.com, Website: <http://www.ultratech-labs.com>

File #: MYT-155F15C247
 October 23, 2009

All test results contained in this engineering test report are traceable to National Institute of Standards and Technology (NIST)

EXHIBIT 2. PERFORMANCE ASSESSMENT

2.1. CLIENT INFORMATION

APPLICANT	
Name:	Bioscrypt, Inc.
Address:	505 Cochrane Drive Markham, Ontario Canada L3R 8E3
Contact Person:	Shiraz Kapadia Phone #: 905-940-7750 Fax #: 905-940-7642 Email Address: shiraz.kapadia@bioscrypt.com

MANUFACTURER	
Name:	Knight Wah Technology Ltd.
Address:	Unit 16 - 19, 3/F Tower B, Regent Centre, 63-73 Wo Yi Hop Road, Kwai Chung, N. T. Hong Kong
Contact Person:	Y.H. Chan Phone #: (852) 2619 0162 Fax #: (852) 2619 0132 Email Address: yhchan@knightwah.com

2.2. EQUIPMENT UNDER TEST (EUT) INFORMATION

The following information (with the exception of the Date of Receipt) has been supplied by the applicant.

Brand Name:	Bioscrypt, Inc.
Product Name:	4G V-Station Extreme
Model Name or Number:	ESTVHW
Serial Number:	Test sample
Type of Equipment:	Low Power Communication Device Transmitter
Input Power Supply Type:	12-24 VDC
Primary User Functions of EUT:	Enroll, verification, communication output

2.3. EUT'S TECHNICAL SPECIFICATIONS

TRANSMITTER	
Equipment Type:	Mobile
Intended Operating Environment:	Commercial, industrial or business
Power Supply Requirement:	3.3 VDC
RF Output Power Rating:	802.11b: 13.54 dBm peak conducted 802.11g: 14.72 dBm peak conducted
Operating Frequency Range:	2412-2462 MHz
Channel Spacing:	14 MHz for 802.11b 17 MHz for 802.11g
Duty Cycle:	100%
6 dB bandwidth:	802.11b : 11.00 MHz 802.11g : 16.55 MHz
Modulation Type:	DBPSK, DQPSK, CCK, BPSK, QPSK, 16QAM & 64QAM
Antenna Description:	Manufacturer: Laird Technologies Type: PCB Antenna Wi-Fi Model No.: Nanoblade-IP04 Freq. Range: 2.4 – 2.5 GHz Gain: 3.8 dBi

2.4. LIST OF EUT'S PORTS

Port Number	EUT's Port Description	Number of Identical Ports	Connector Type	Cable Type (Shielded/Non-shielded)
1	Ethernet 100-Base TX	1	RJ45	Non shielded
2	Host RS-485	1	Header	Non shielded
3	Host RS-232	1	Header	Non shielded
4	Power	2	Bullet and Header	Non shielded
5	Wiegand I/O (8 Lines)	1	Header	Non shielded
6	General Purpose I/O (3 Inputs & 6 Outputs)	1	Header	Non shielded
7	Relay Control (NC, NO & COM)	1	Header	Non shielded
8	USB OTG (Auxiliary Port)*	1	USB-Micro-AB	Shielded

* Note: Secured and used by service personnel only

2.5. ANCILLARY EQUIPMENT

The EUT was tested while connected to the following representative configuration of ancillary equipment necessary to exercise the ports during tests:

Ancillary Equipment # 1	
Description:	Laptop
Brand name:	Dell
Model Name or Number:	PPL
Serial Number:	12800-8A23775
Connected to:	Wireless Router

Ancillary Equipment # 2	
Description:	Wireless Router
Brand name:	D-Link
Model Name or Number:	DIR-655
Serial Number:	F37XH8B004673
Connected to:	To Dell Laptop

2.6. GENERAL TEST SETUP BLOCK DIAGRAM

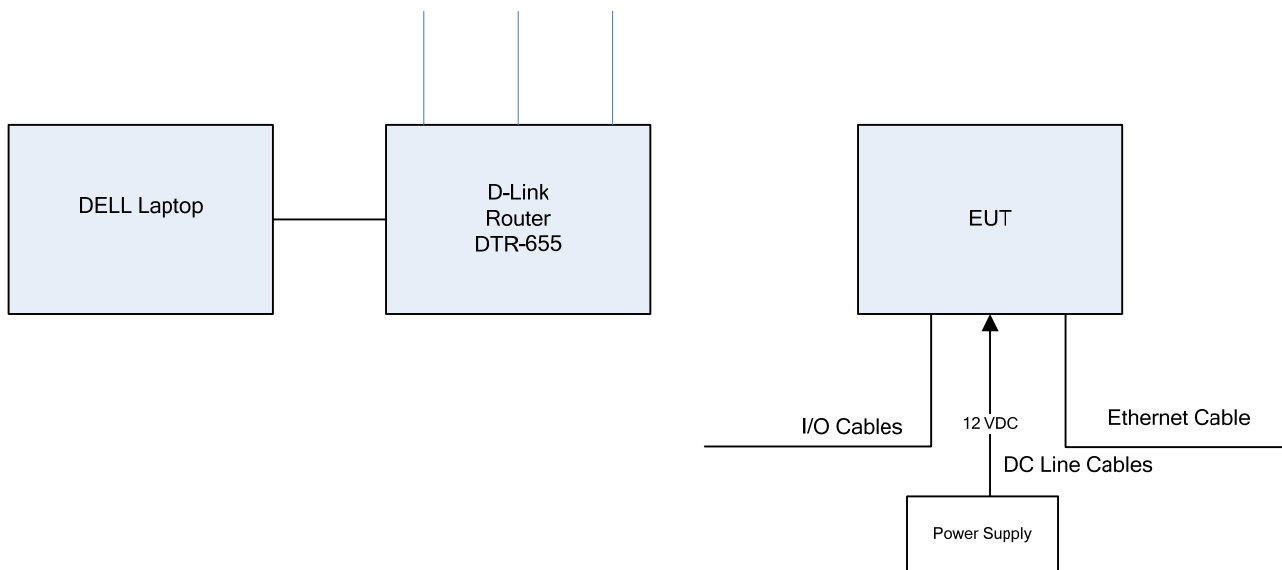

EXHIBIT 3. EUT OPERATING CONDITIONS AND CONFIGURATIONS DURING TESTS

3.1. CLIMATE TEST CONDITIONS

The climate conditions of the test environment are as follows:

Temperature:	21°C
Humidity:	51%
Pressure:	102 kPa
Power input source:	12 VDC

3.2. OPERATIONAL TEST CONDITIONS & ARRANGEMENT FOR TESTS

Operating Modes:	Each of lowest, middle and highest channel frequencies transmits continuously for emissions measurements.
Special Test Software:	Special software and hardware by the Applicant to operate the EUT at each channel frequency continuously. For example, the transmitter will be operated at each of the lowest, middle and highest frequencies individually continuously during testing.
Special Hardware Used:	None
Transmitter Test Antenna:	The EUT is tested with the antenna fitted in a manner typical of normal intended use.

Transmitter Test Signals	
Frequency Band(s):	2412-2462 MHz
RF Power Output:	802.11b: 13.54 dBm peak conducted 802.11g: 14.72 dBm peak conducted
Normal Test Modulation:	DBPSK, DQPSK, CCK, BPSK, QPSK, 16QAM & 64QAM
Modulating Signal Source:	Internal

EXHIBIT 4. SUMMARY OF TEST RESULTS

4.1. LOCATION OF TESTS

All of the measurements described in this report were performed at Ultratech Group of Labs located in the city of Oakville, Province of Ontario, Canada.

- AC Powerline Conducted Emissions were performed in UltraTech's shielded room, 16'(L) by 12'(W) by 12'(H).
- Radiated Emissions were performed at the Ultratech's 3-10 TDK Semi-Anechoic Chamber situated in the Town of Oakville, province of Ontario. This test site been calibrated in accordance with ANSI C63.4, and found to be in compliance with the requirements of Sec. 2.948 of the FCC Rules. The descriptions and site measurement data of the Oakville 3-10 TDK Semi-Anechoic Chamber has been filed with FCC office (FCC File No.: 91038) and Industry Canada office (Industry Canada File No.: 2049A-3). Expiry Date: 2011-05-01.

4.2. APPLICABILITY & SUMMARY OF EMC EMISSION TEST RESULTS

FCC Section(s)	Test Requirements	Compliance (Yes/No)
15.203	Antenna requirements	Yes*
15.207(a)	Power Line Conducted Emissions	Yes**
15.247(a)(2)	6 dB Bandwidth	Yes
15.247(b)(3)	Peak Conducted Output Power - DTS	Yes
15.247(d)	Band-Edge and RF Conducted Spurious Emissions at the Transmitter Antenna Terminal	Yes
15.247(d), 15.209 & 15.205	Transmitter Spurious Radiated Emissions	Yes
15.247(e)	Power Spectral Density	Yes
15.247(i) 1.1307, 1.1310, 2.1091 & 2.1093	RF Exposure	Yes

4G V-Station Extreme, Model No.: ESTVHW, by Bioscrypt Inc. has also been tested and found to comply with **FCC Part 15, Subpart B - Class B Digital Devices**. The engineering test report has been documented and kept on file and it is available upon request.

* This device has integral antenna inside EUT enclosure.

** The power line conducted emission test results are incorporated in the 15.225 report of this filing.

4.3. MODIFICATIONS INCORPORATED IN THE EUT FOR COMPLIANCE PURPOSES

The following modifications were made for compliance:

Ferrite material added outside device on cables:

4G (PIV-TWIC Station or V-Station) Extreme required the addition of a Steward Ferrite P/N: 28A4155-0A2, requiring 1 turn on the IO and Unit Power lines close to the unit.

4G (PIV-TWIC Station or V-Station) Extreme required the addition of a Steward Ferrite P/N: 28A2432-0A2, requiring 1 turn on the Ethernet lines close to the unit RJ45 port.

4G (PIV-TWIC Station or V-Station) Extreme also required the addition of a Steward Ferrite, 28A4155-0A2, requiring 1 turn on the Cooler DC Power lines close to the Cooler board power port.

Ferrite material added inside device:

4G (PIV-TWIC Station or V-Station) Extreme required the addition of two Steward Ferrites, P/N: 28B0562-000, and each ferrite required 2 turns on the internal LVDs cable. One ferrite closes to one end of the LVDs cable and another ferrite closes to another end of the LVDs cable.

4G (PIV-TWIC Station or V-Station) Extreme required the addition of two Steward Ferrites, P/N: 28B0562-000, and each ferrite required 2 turns on the internal Venus Sensor cable. One ferrite closes to one end of the Venus Sensor cable and another ferrite closes to another end of the Venus Sensor cable.

4G (PIV-TWIC Station or V-Station) Extreme required the addition of a Steward Ferrite, P/N: 28A2432-0A2, requiring 1 turn on the Magnetic Stripe Card Reader Cable closes to the connector side of LCD/Keypad PCB.

4G (PIV-TWIC Station or V-Station) Extreme also required Nickel Paint – MG Chemicals, Super Shield Nickel Conductive Coating, UL E202609, CAT/PN: 841-3406, applied to Lumidigm Venus Sensor on all sides.

EXHIBIT 5. MEASUREMENTS, EXAMINATIONS & TEST DATA FOR EMC EMISSIONS

5.1. TEST PROCEDURES

This section contains test results only. Details of test methods and procedures can be found in ANSI C63.4; FCC KDB Publication No. 558074: Guidance on Measurements for Digital Transmission Systems.

5.2. MEASUREMENT UNCERTAINTIES

The measurement uncertainties stated were calculated in accordance with requirements of UKAS Document NIS 81 with a confidence level of 95%. Please refer to Exhibit 7 for Measurement Uncertainties.

5.3. MEASUREMENT EQUIPMENT USED

The measurement equipment used complied with the requirements of the Standards referenced in the Methods & Procedures ANSI C63.4 and CISPR 16-1-1.

5.4. ESSENTIAL/PRIMARY FUNCTIONS AS DECLARED BY THE MANUFACTURER

To provide data communication link using Wi-Fi 802.11 b/g.

5.5. OCCUPIED BANDWIDTH [§ 15.247(a)(2)]

5.5.1. Limit(s)

For a Digital Modulation System, the minimum 6 dB bandwidth shall be at least 500 kHz.

5.5.2. Method of Measurements

KDB Publication No. 558074: Guidance on Measurements for Digital Transmission Systems (47 CFR 15.247)

5.5.3. Test Arrangement

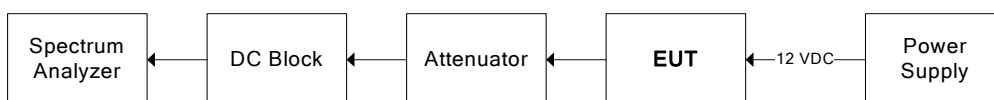

5.5.4. Test Data

802.11b Mode:

Frequency (MHz)	Modulation	Data Rate (Mbps)	6dB Bandwidth (MHz)
2412	DBPSK	1	10.58
2437	DBPSK	1	10.46
2462	DBPSK	1	10.58
2412	DQPSK	2	9.74
2437	DQPSK	2	10.28
2462	DQPSK	2	9.92
2412	CCK	11	10.46
2437	CCK	11	10.76
2462	CCK	11	11.00

802.11g Mode:

Frequency (MHz)	Modulation	Data Rate (Mbps)	6dB Bandwidth (MHz)
2412	BPSK	9	16.48
2437	BPSK	9	16.55
2462	BPSK	9	16.48
2412	QPSK	18	16.55
2437	QPSK	18	16.55
2462	QPSK	18	16.48
2412	16QAM	36	16.34
2437	16QAM	36	16.34
2462	16QAM	36	16.41
2412	64QAM	54	16.48
2437	64QAM	54	16.48
2462	64QAM	54	16.48

See the following plots for detailed measurements.

Plot 5.5.4.1. 6 dB Bandwidth
Frequency: 2412 MHz; Modulation: DBPSK at 1 Mbps

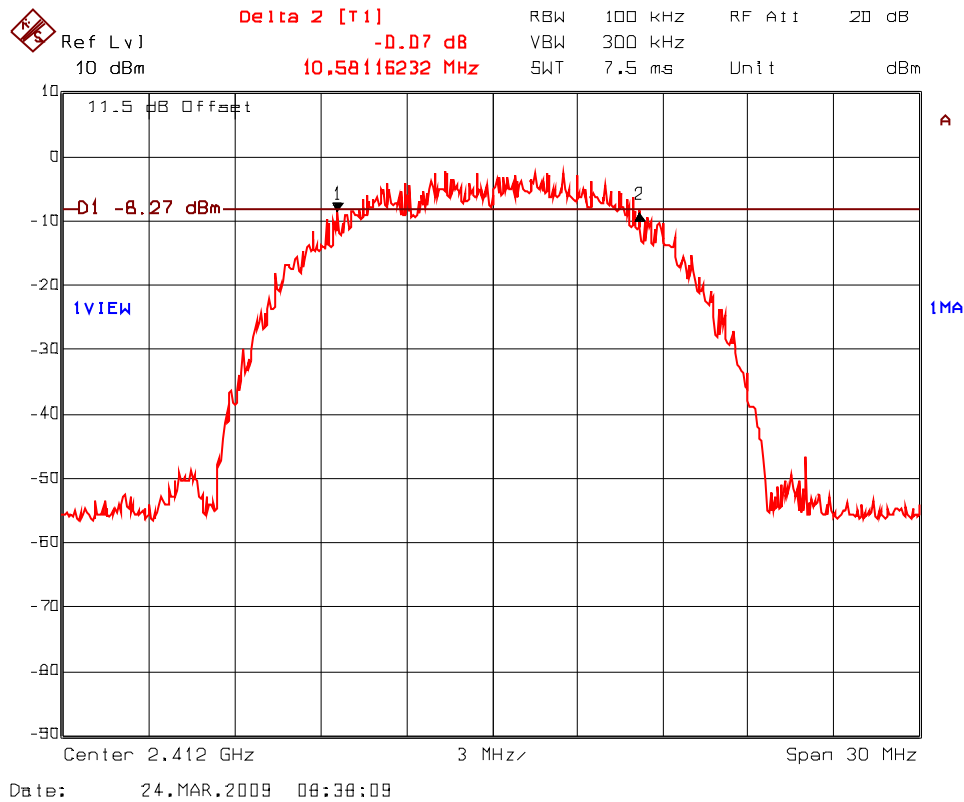

Plot 5.5.4.2. 6 dB Bandwidth
Frequency: 2437 MHz; Modulation: DBPSK at 1 Mbps

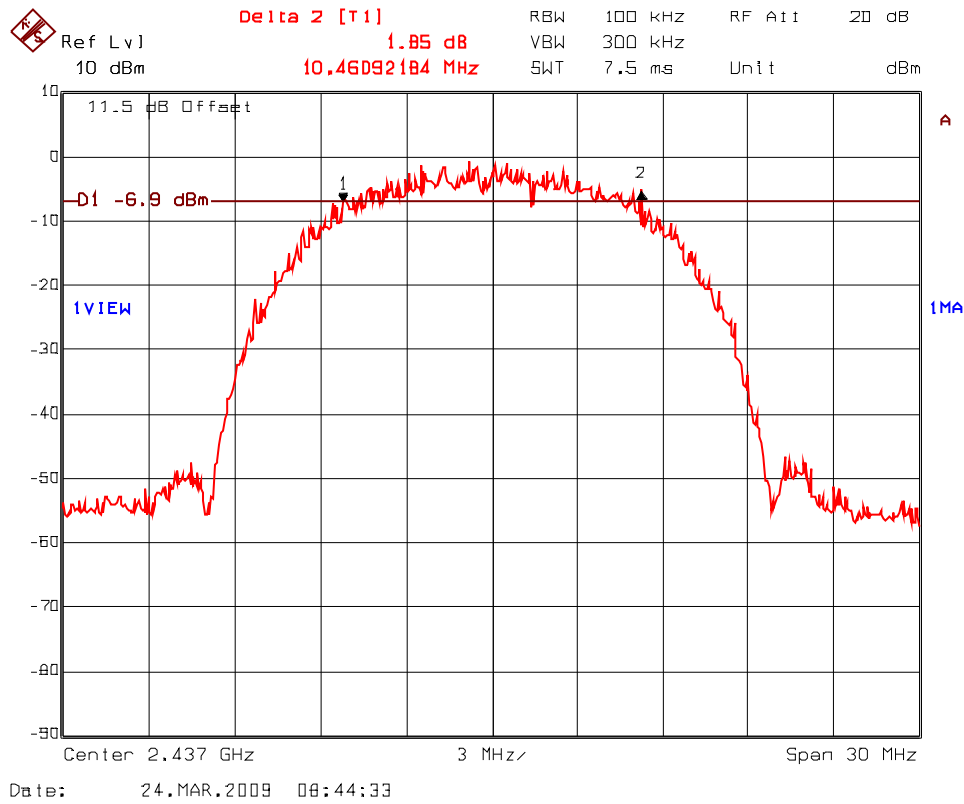

Plot 5.5.4.3. 6 dB Bandwidth
Frequency: 2462 MHz; Modulation: DBPSK at 1 Mbps

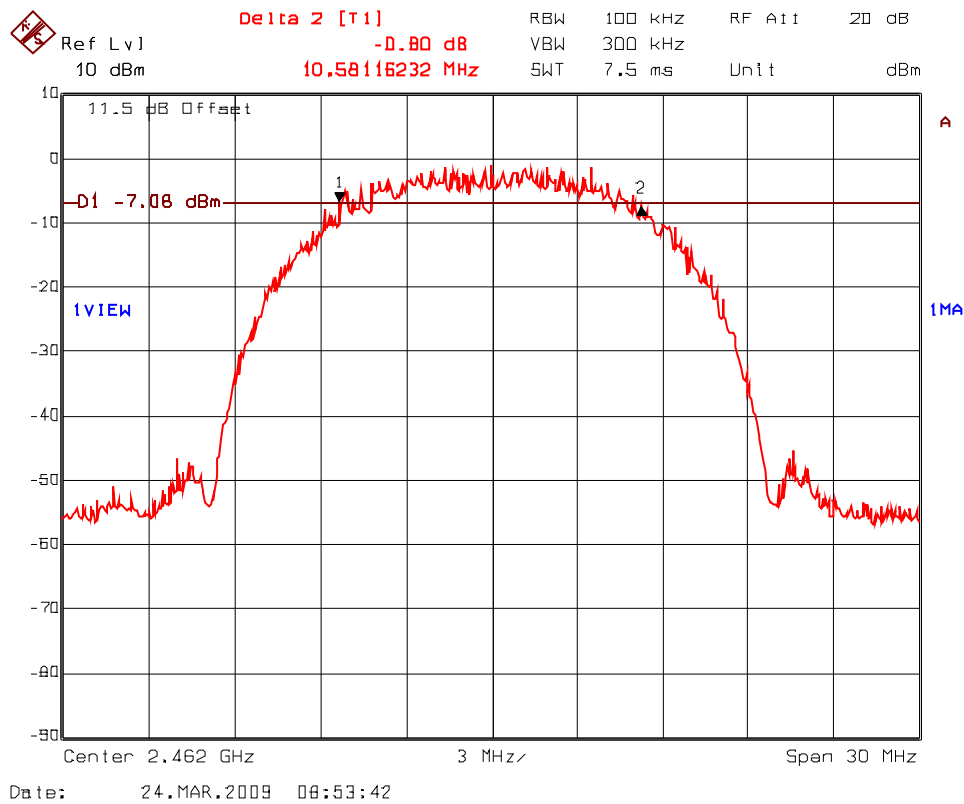

Plot 5.5.4.4. 6 dB Bandwidth
Frequency: 2412 MHz; Modulation: DQPSK at 2 Mbps

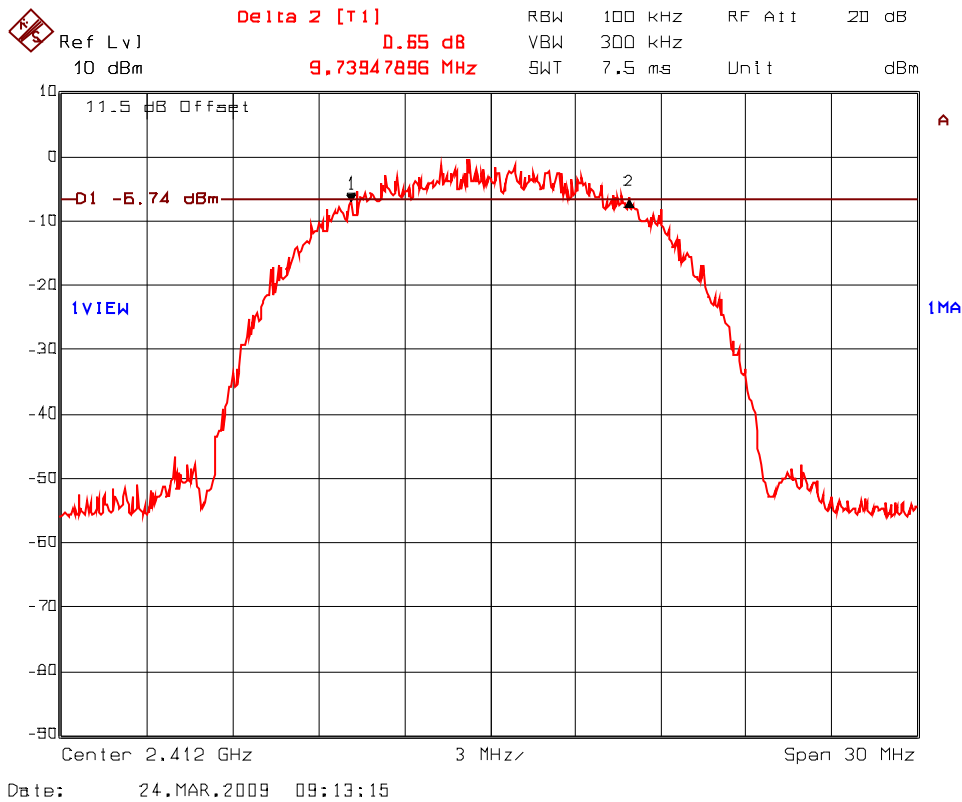

Plot 5.5.4.5. 6 dB Bandwidth
Frequency: 2437 MHz; Modulation: DQPSK at 2 Mbps

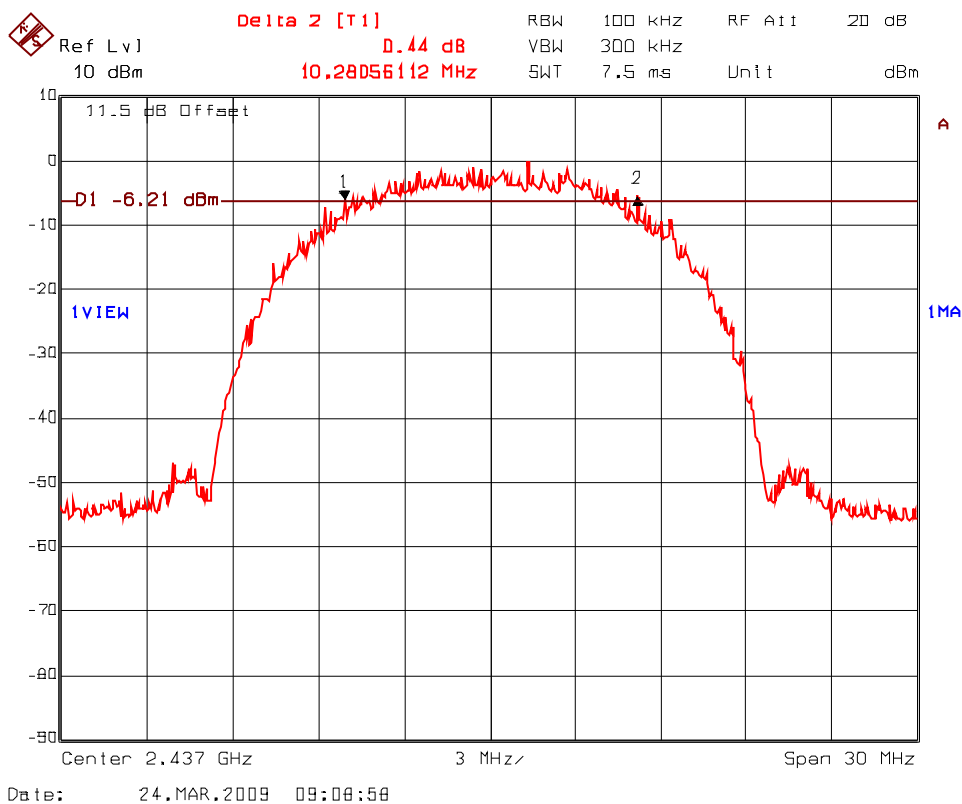

Plot 5.5.4.6. 6 dB Bandwidth
Frequency: 2462 MHz; Modulation: DQPSK at 2 Mbps

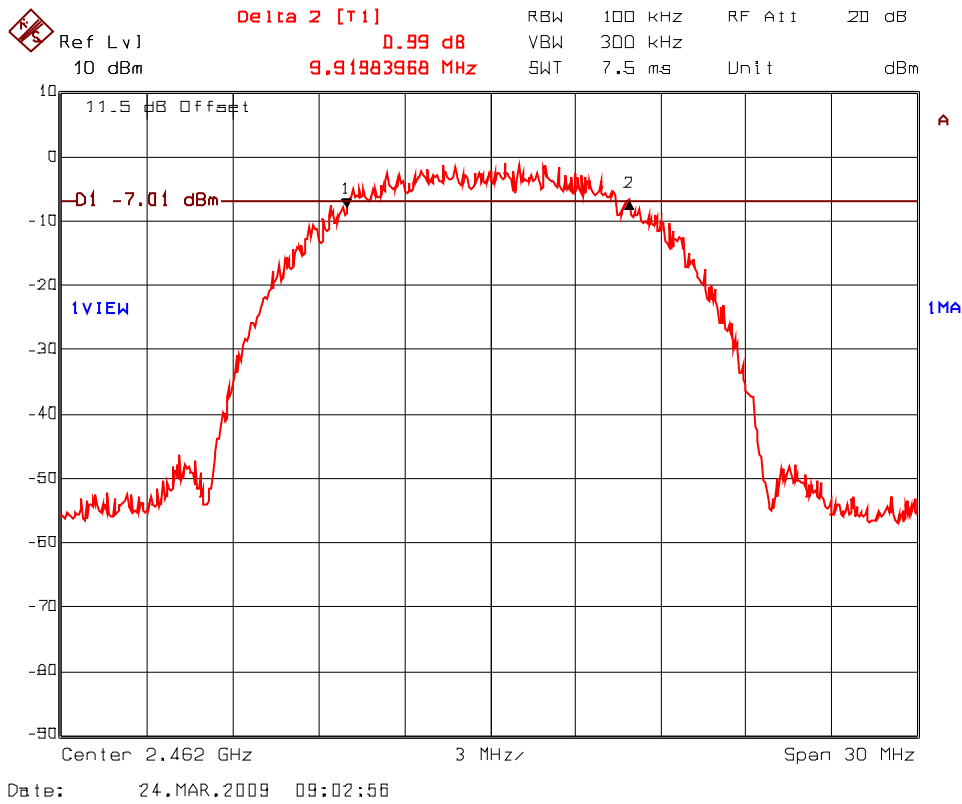

Plot 5.5.4.7. 6 dB Bandwidth
 Frequency: 2412 MHz; Modulation: CCK at 11 Mbps

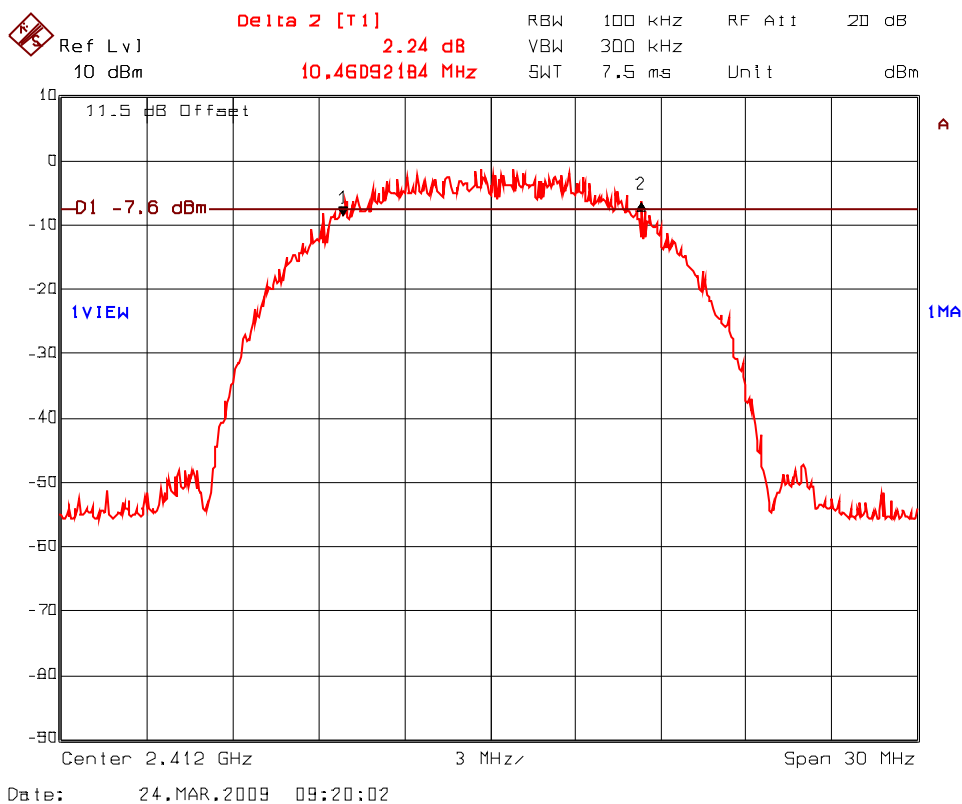

Plot 5.5.4.8. 6 dB Bandwidth
Frequency: 2437 MHz; Modulation: CCK at 11 Mbps

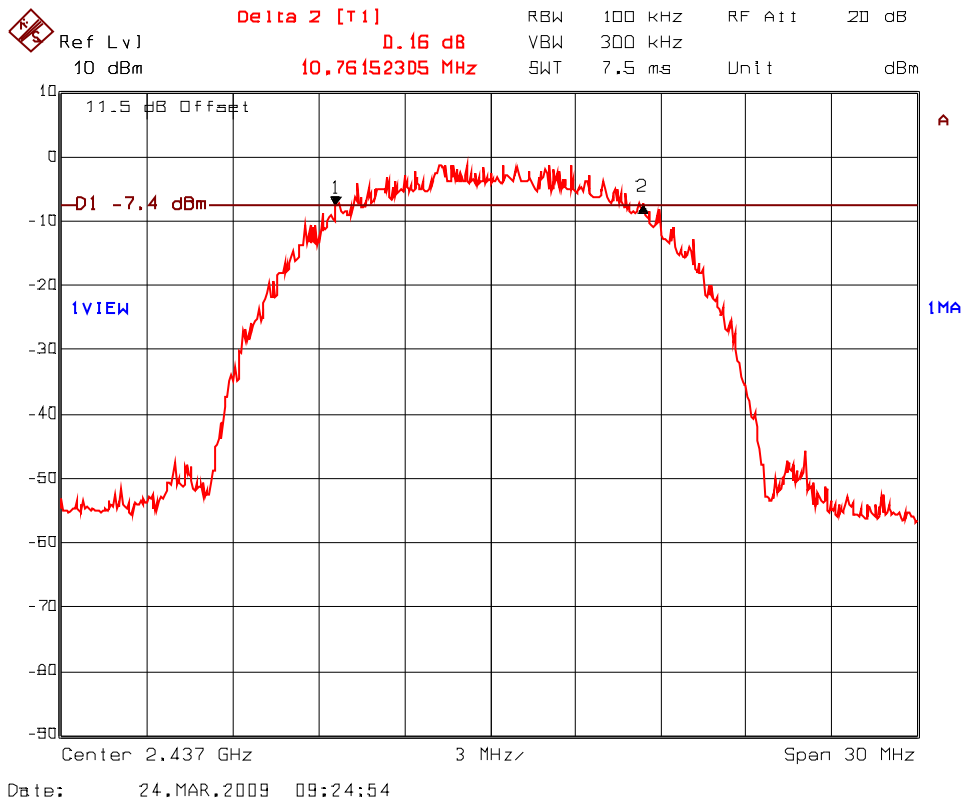

Plot 5.5.4.9. 6 dB Bandwidth
Frequency: 2462 MHz; Modulation: CCK at 11 Mbps

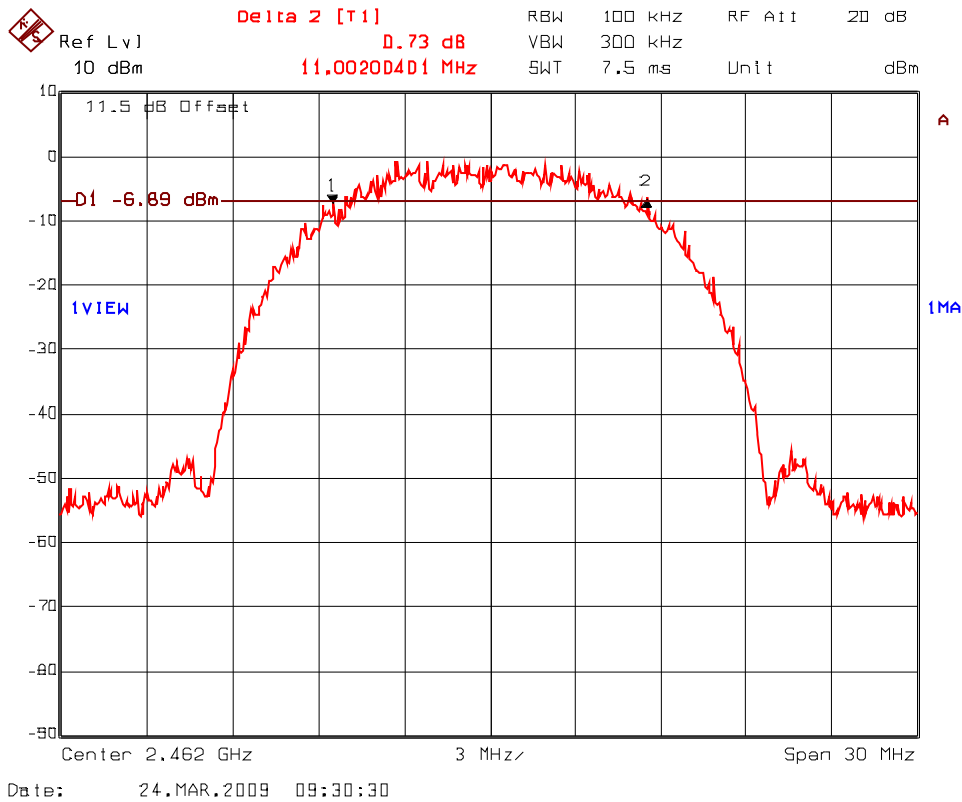

Plot 5.5.4.10. 6 dB Bandwidth
Frequency: 2412 MHz; Modulation: BPSK at 9 Mbps

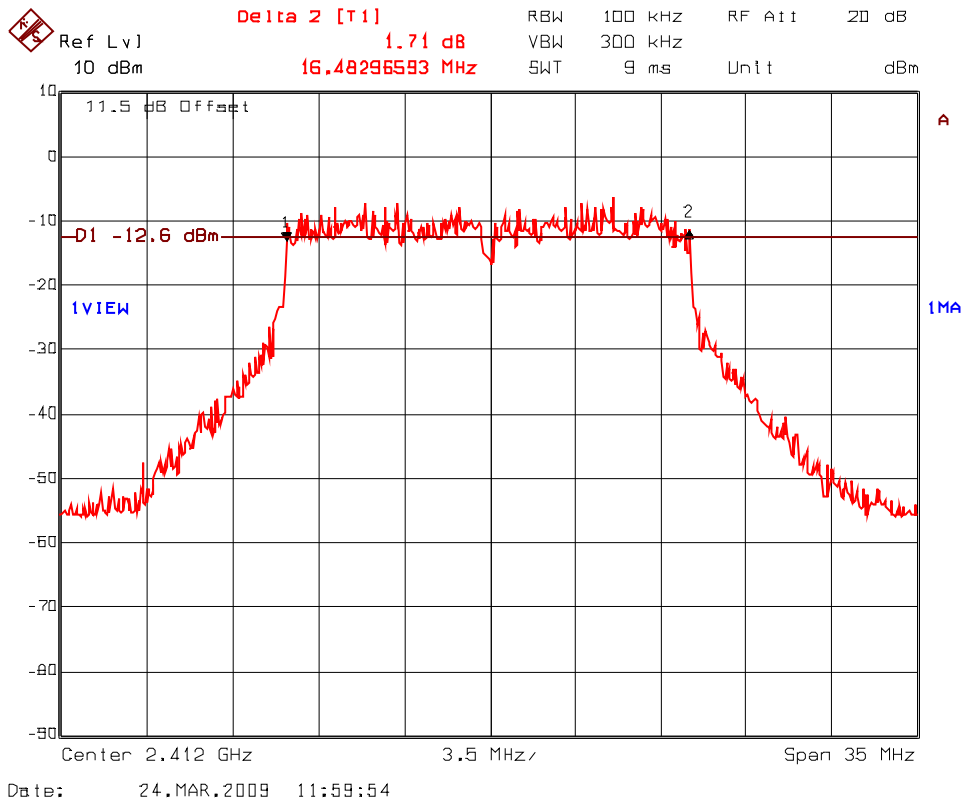

Plot 5.5.4.11. 6 dB Bandwidth
Frequency: 2437 MHz; Modulation: BPSK at 9 Mbps

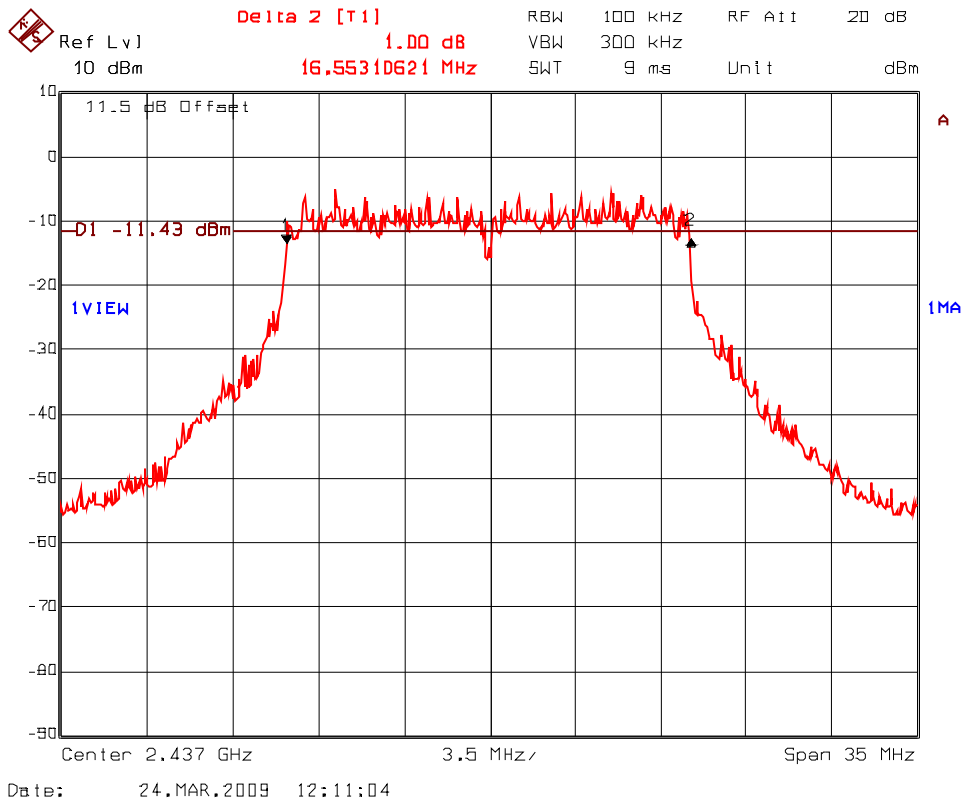

Plot 5.5.4.12. 6 dB Bandwidth
Frequency: 2462 MHz; Modulation: BPSK at 9 Mbps

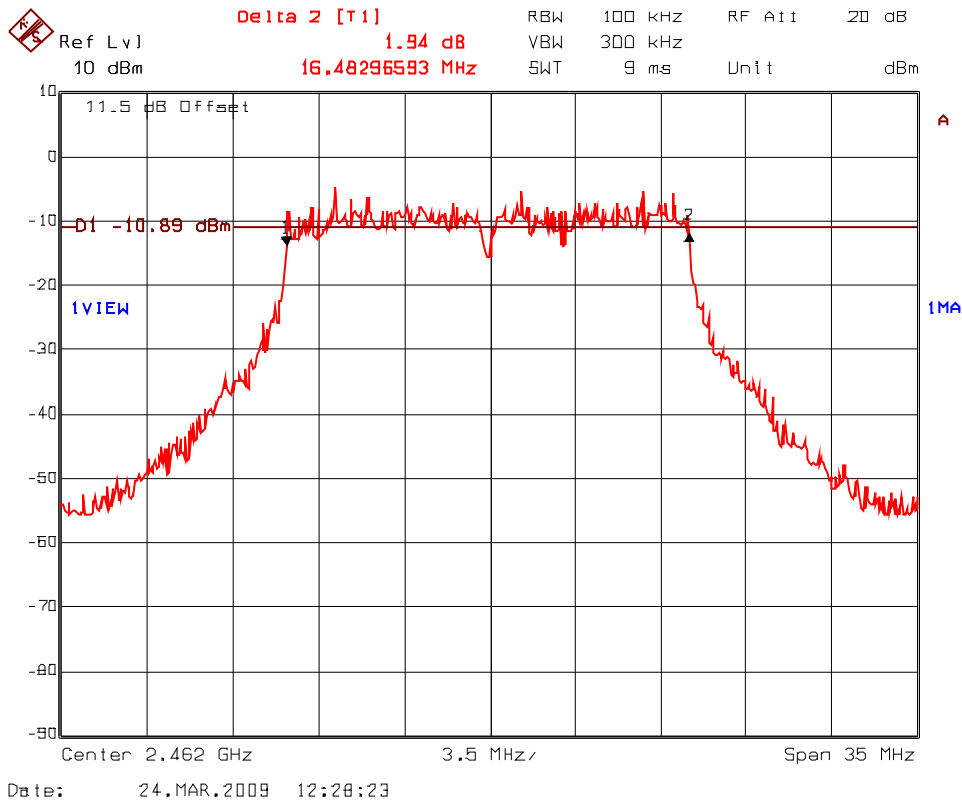

Plot 5.5.4.13. 6 dB Bandwidth
Frequency: 2412 MHz; Modulation: QPSK at 18 Mbps

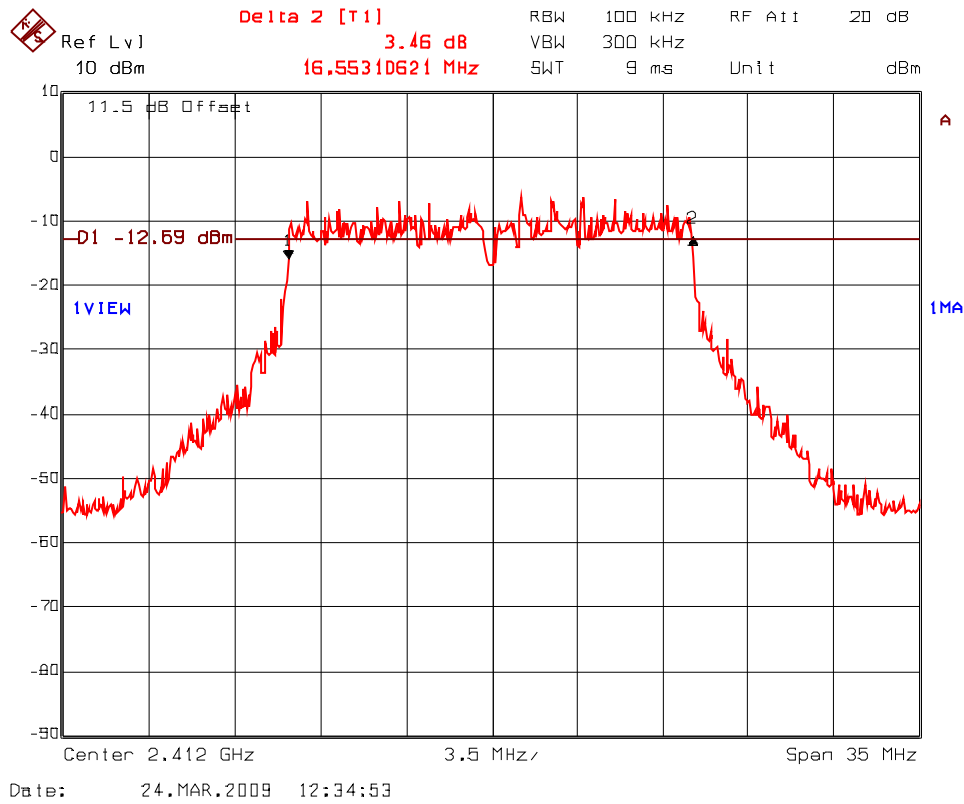

Plot 5.5.4.14. 6 dB Bandwidth
Frequency: 2437 MHz; Modulation: QPSK at 18 Mbps

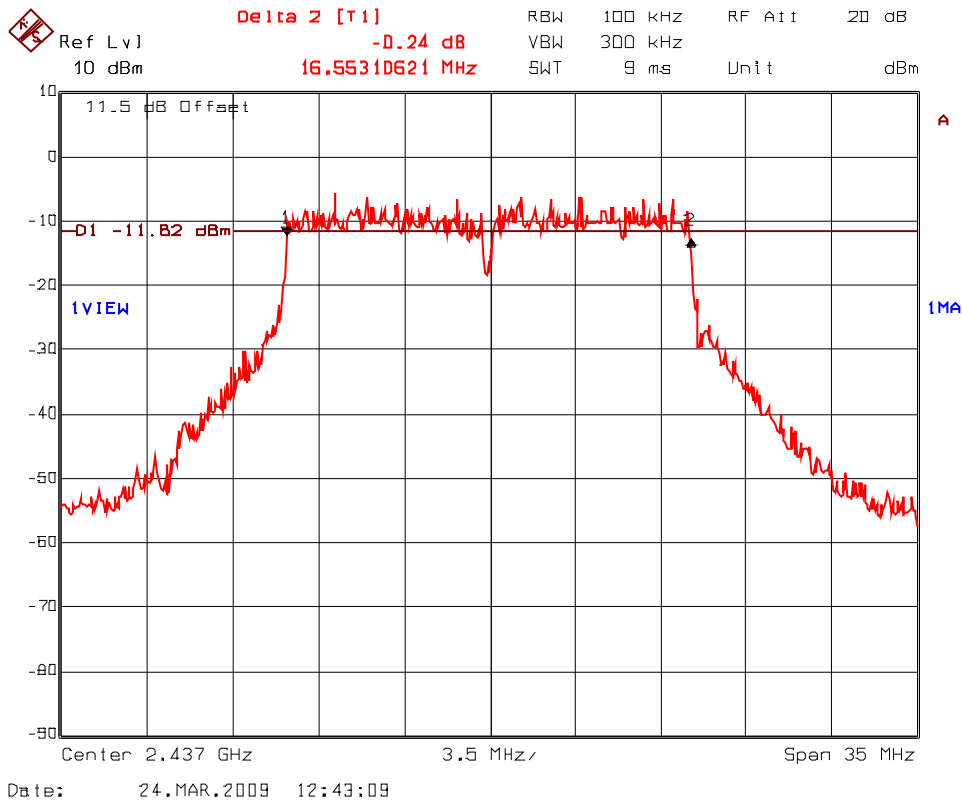

Plot 5.5.4.15. 6 dB Bandwidth
Frequency: 2462 MHz; Modulation: QPSK at 18 Mbps

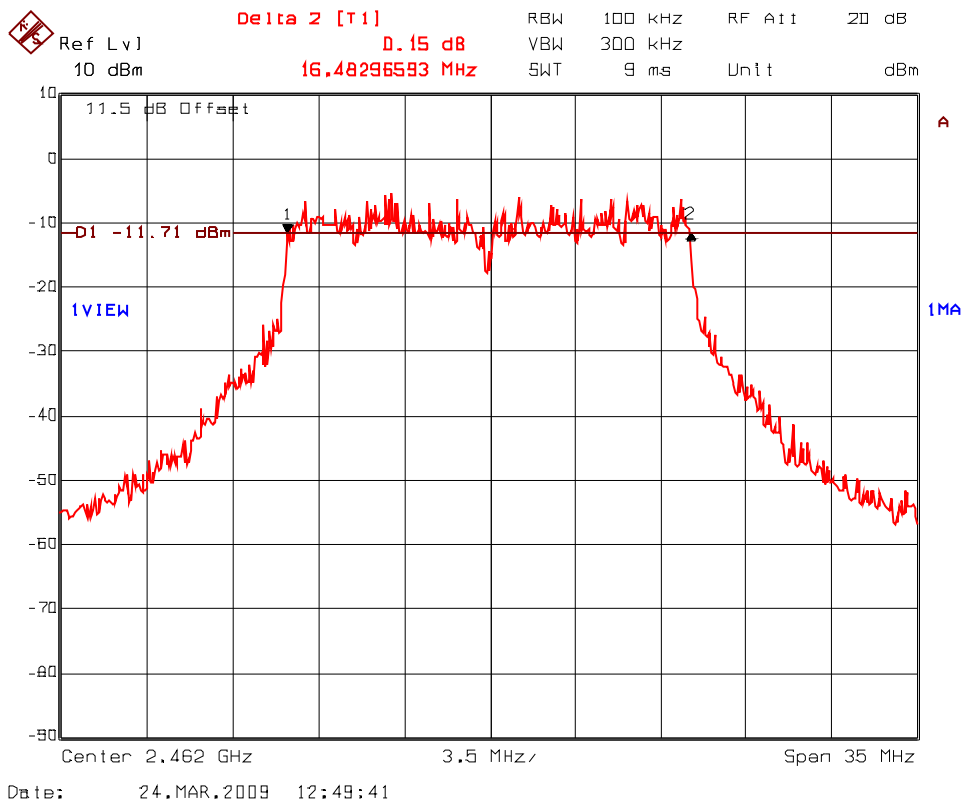

Plot 5.5.4.16. 6 dB Bandwidth
Frequency: 2412 MHz; Modulation: 16QAM at 36 Mbps

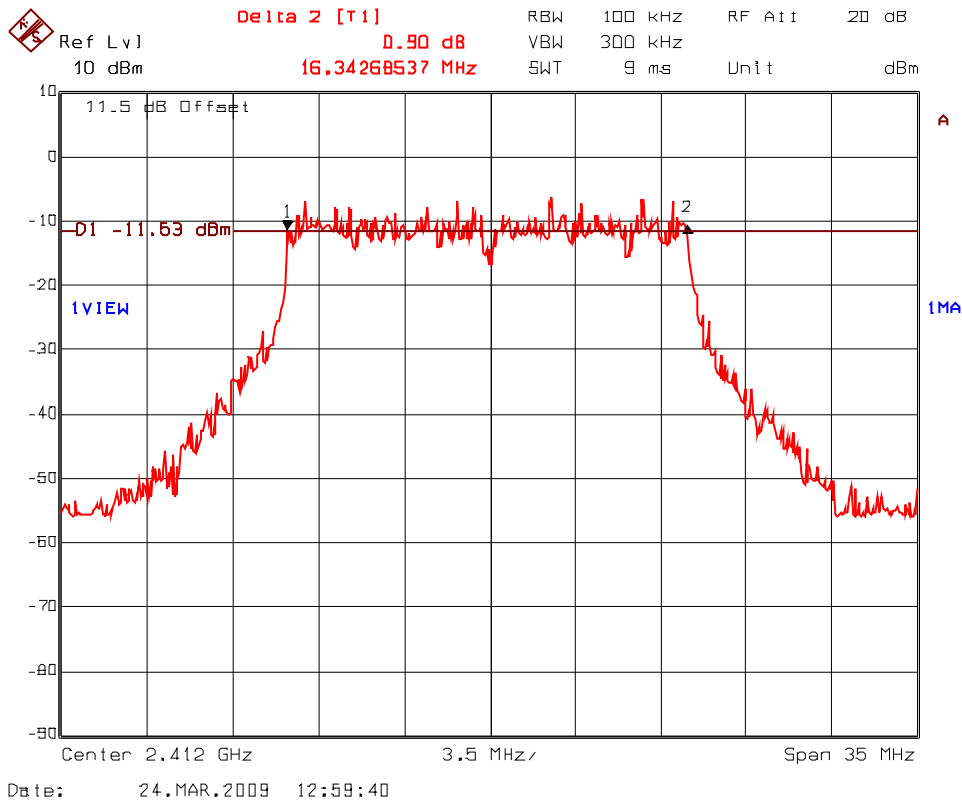

Plot 5.5.4.17. 6 dB Bandwidth
Frequency: 2437 MHz; Modulation: 16QAM at 36 Mbps

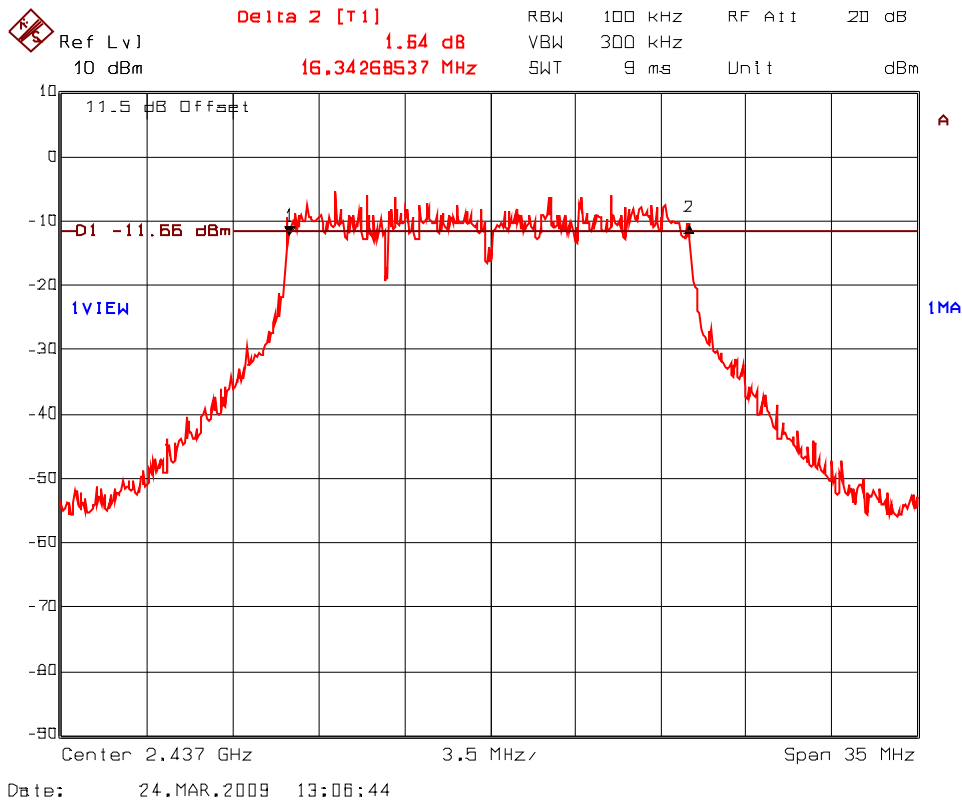

Plot 5.5.4.18. 6 dB Bandwidth
Frequency: 2462 MHz; Modulation: 16QAM at 36 Mbps

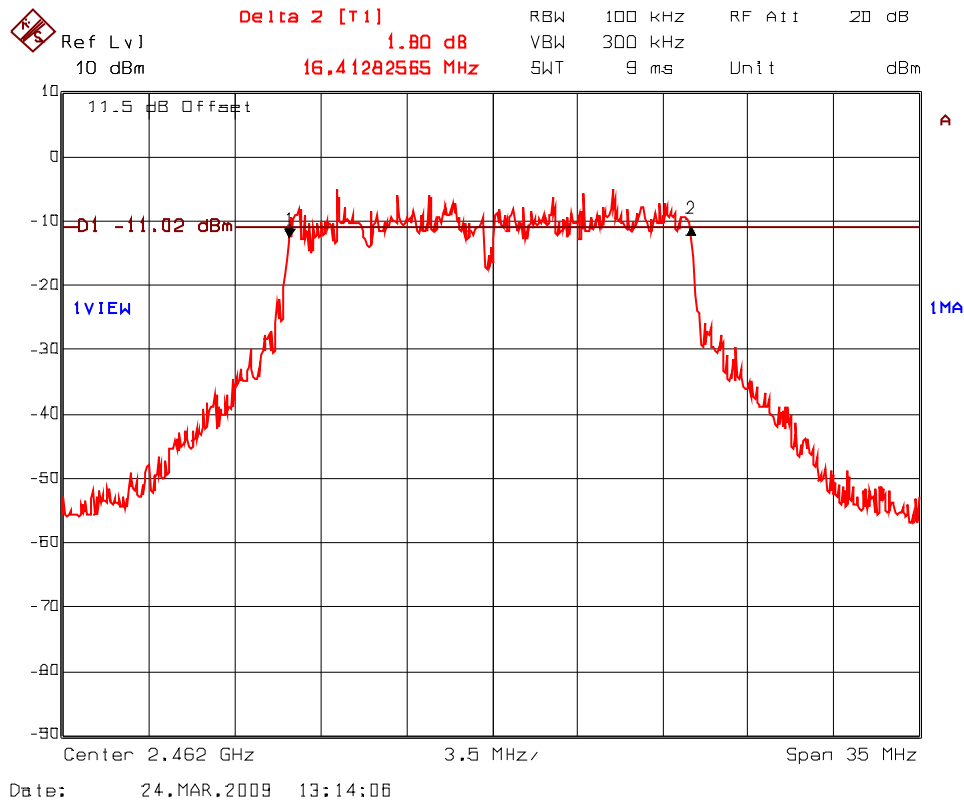

Plot 5.5.4.19. 6 dB Bandwidth
 Frequency: 2412 MHz; Modulation: 64QAM at 54 Mbps

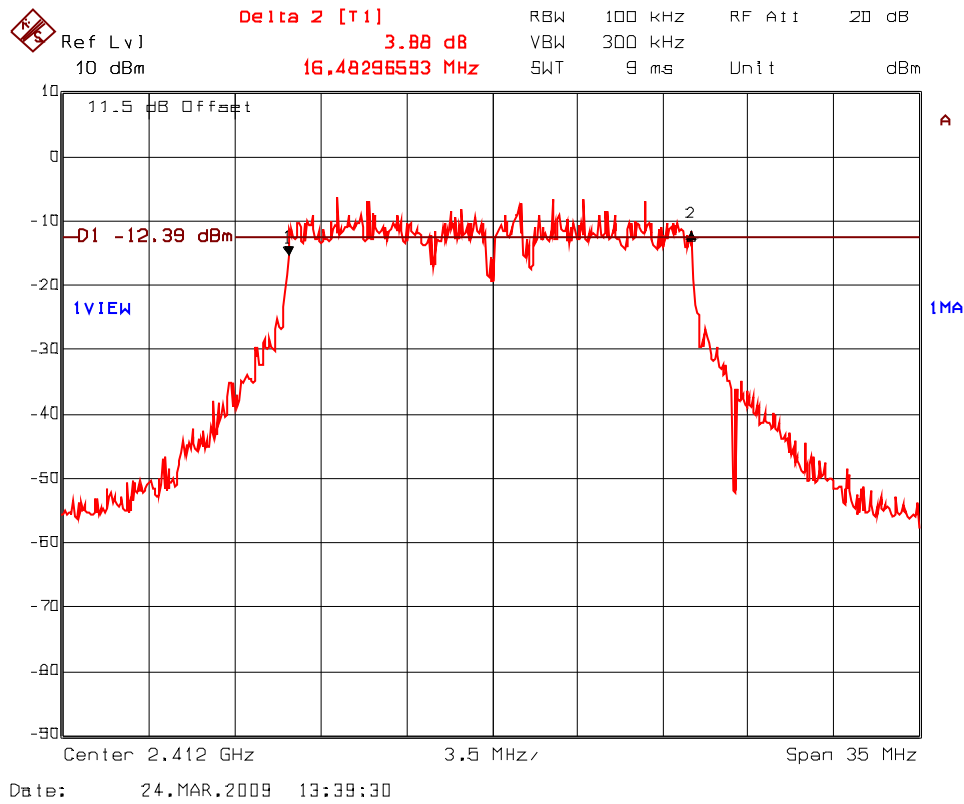

Plot 5.5.4.20. 6 dB Bandwidth
Frequency: 2437 MHz; Modulation: 64QAM at 54 Mbps

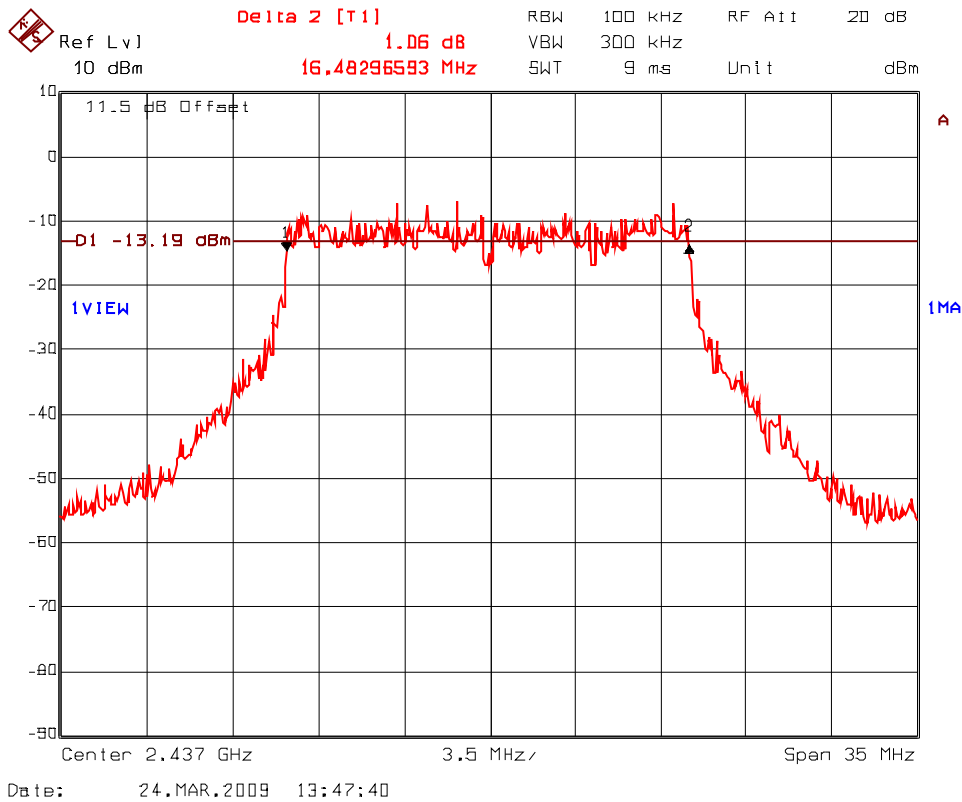

Plot 5.5.4.21. 6 dB Bandwidth
Frequency: 2462 MHz; Modulation: 64QAM at 54 Mbps

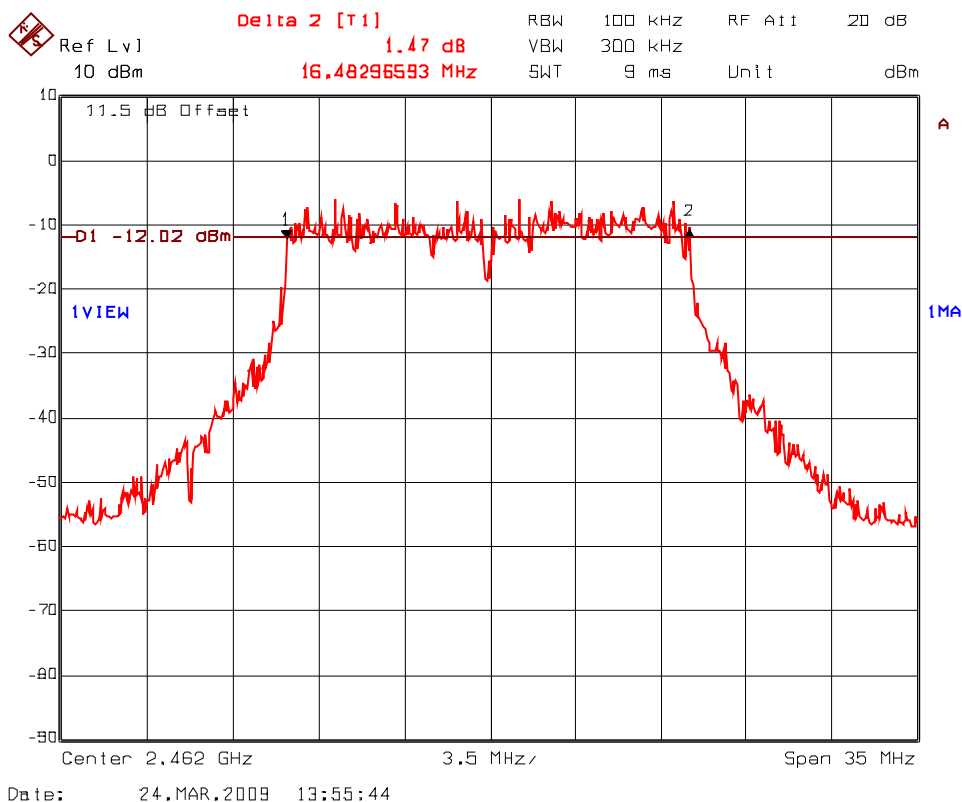

5.6. PEAK CONDUCTED OUTPUT POWER - DTS [§ 15.247(b)(3)]

5.6.1. Limit(s)

§ 15.247(b)(3):

For systems using digital modulation in the 902-928 MHz, 2400-2483.5 MHz, and 5725-5850 MHz bands: 1 Watt. As an alternative to a peak power measurement, compliance with the one Watt limit can be based on a measurement of the maximum conducted output power. Maximum Conducted Output Power is defined as the total transmit power delivered to all antennas and antenna elements averaged across all symbols in the signaling alphabet when the transmitter is operating at its maximum power control level. Power must be summed across all antennas and antenna elements. The average must not include any time intervals during which the transmitter is off or is transmitting at a reduced power level. If multiple modes of operation are possible (e.g., alternative modulation methods), the *maximum conducted output power* is the highest total transmit power occurring in any mode.

5.6.2. Method of Measurements & Test Arrangement

Refer to FCC KDB Publication No. 558074, Power Option method 1 and ANSI C63.4 for measurement methods.

5.6.3. Test Arrangement

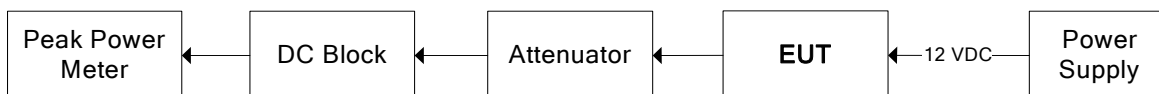

5.6.4. Test Data

Remarks: Test method: Power Output Option 1, peak measurement

5.6.4.1. 802.11b mode

Data Rate (Mbps)	Max Conducted O/P Power (dBm)		
	2412 MHz (CH1)	2437 MHz (CH6)	2462 MHz (CH11)
1 (DBPSK)	12.29	12.96	13.26
2 (DQPSK)	12.29	12.64	13.54
11 (CCK)	12.29	12.64	13.54

5.6.4.2. 802.11g mode

Data Rate (Mbps)	Max Conducted O/P Power (dBm)		
	2412 MHz (CH1)	2437 MHz (CH6)	2462 MHz (CH11)
9 (BPSK)	12.64	13.54	14.51
18 (QPSK)	12.96	13.54	14.72
36 (16-QAM)	12.96	13.54	14.51
54 (64-QAM)	12.64	13.81	14.72

5.7. TRANSMITTER BAND-EDGE & SPURIOUS CONDUCTED EMISSIONS [§ 15.247(d)]

5.7.1. Limit(s)

§ 15.247 (d): In any 100 kHz bandwidth outside the frequency band in which the spread spectrum or digitally modulated intentional radiator is operating, the radio frequency power that is produced by the intentional radiator shall be at least 20 dB below that in the 100 kHz bandwidth within the band that contains the highest level of the desired power, based on either an RF conducted or a radiated measurement, provided the transmitter demonstrates compliance with the peak conducted power limits. If the transmitter complies with the conducted power limits based on the use of RMS averaging over a time interval, as permitted under paragraph (b)(3) of this section, the attenuation required under this paragraph shall be 30 dB instead of 20 dB.

5.7.2. Method of Measurements

KDB Publication No. 558074: Guidance on Measurements for Digital Transmission Systems (47 CFR 15.247)

5.7.3. Test Arrangement

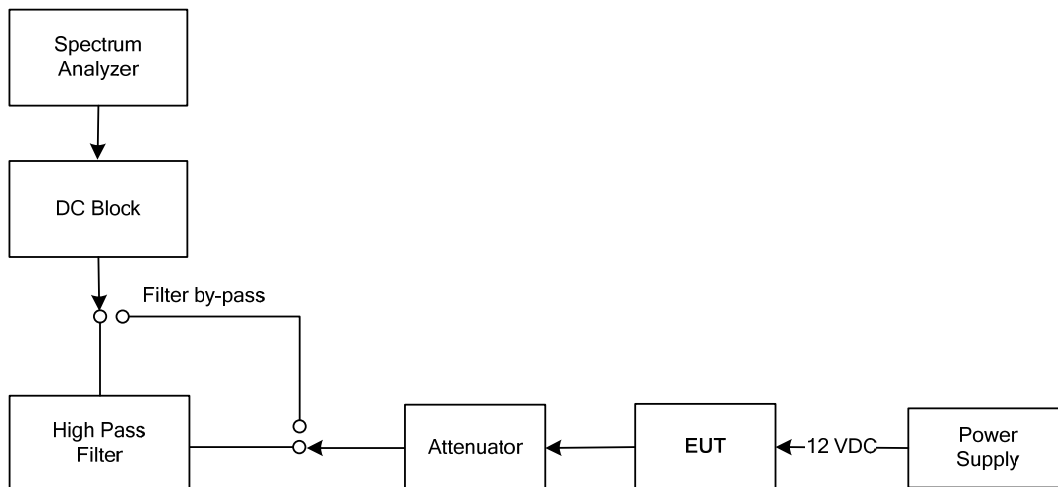

5.7.4. Test Data

5.7.4.1. Band-Edge RF Conducted Emissions

**Plot 5.7.4.1.1. Band-Edge RF Conducted Emissions, 802.11b Mode
Low End of Frequency Band 2412 -2462 MHz**

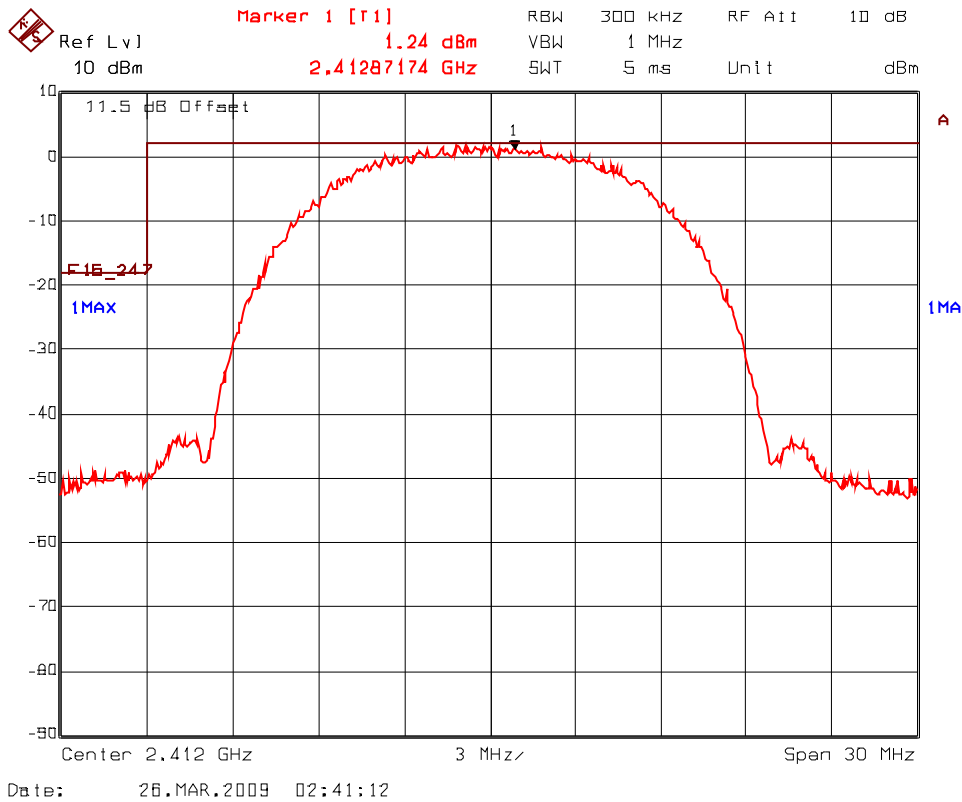

**Plot 5.7.4.1.2. Band-Edge RF Conducted Emissions, 802.11b Mode
High End of Frequency Band 2412 -2462 MHz**

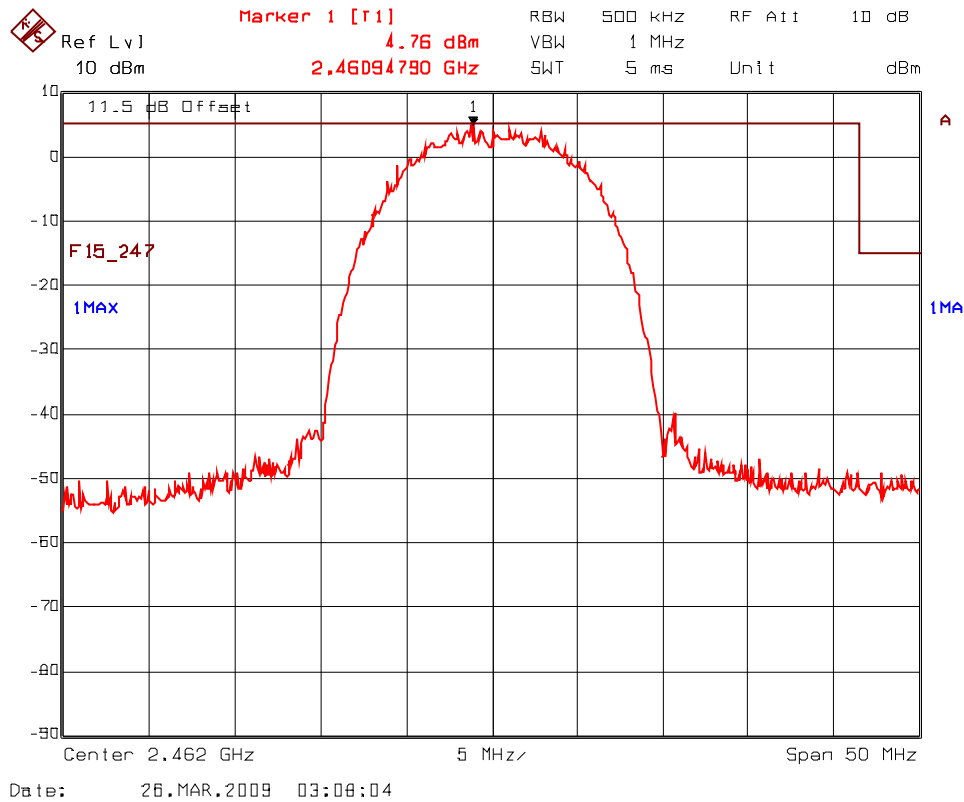

**Plot 5.7.4.1.3. Band-Edge RF Conducted Emissions, 802.11g Mode
Low End of Frequency Band 2412 -2462 MHz**

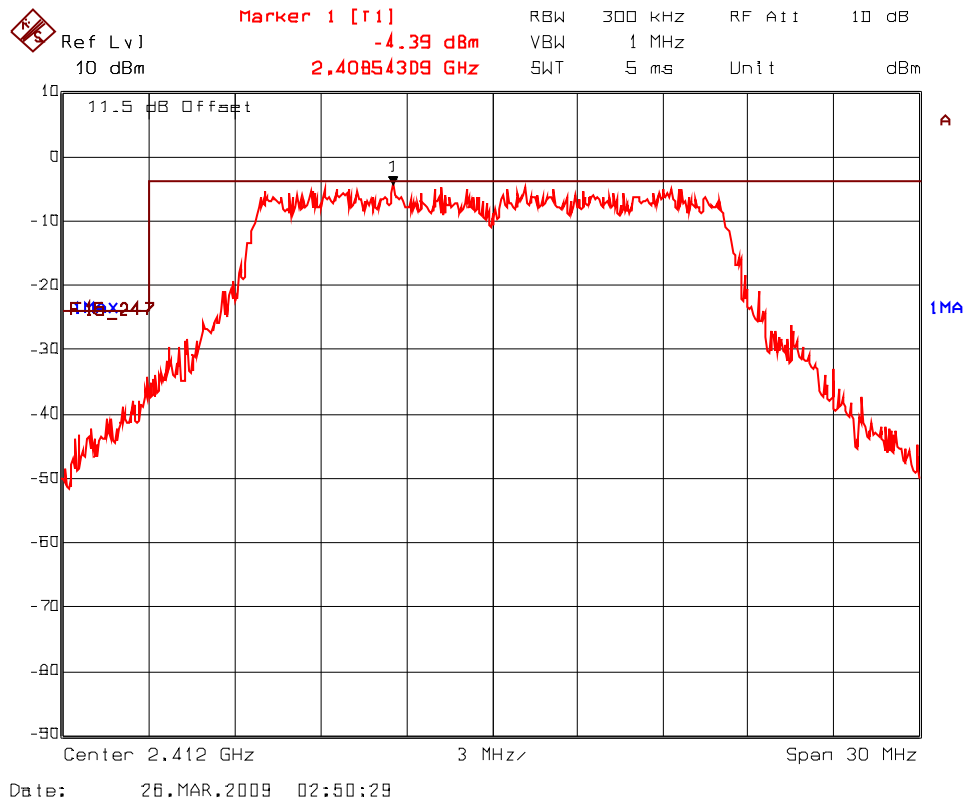

**Plot 5.7.4.1.4. Band-Edge RF Conducted Emissions, 802.11g Mode
High End of Frequency Band 2412 -2462 MHz**

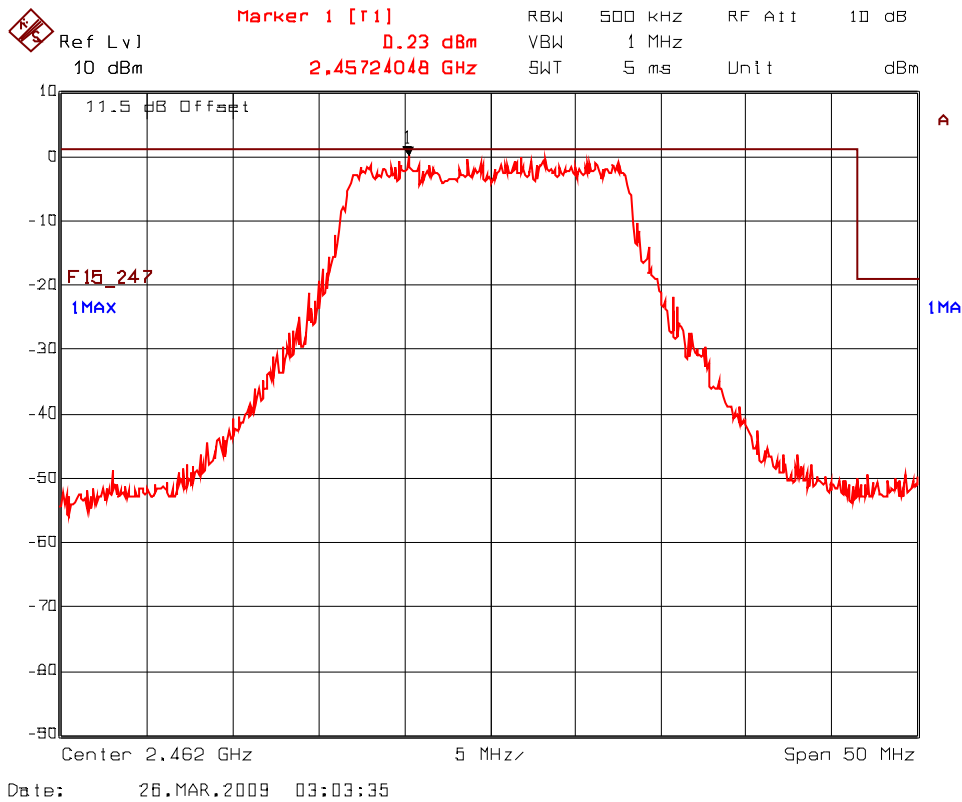

5.7.4.2. Spurious RF Conducted Emissions

Plot 5.7.4.2.1(i) Spurious RF Conducted Emissions, 802.11b Mode
Transmitter Frequency: 2412 MHz

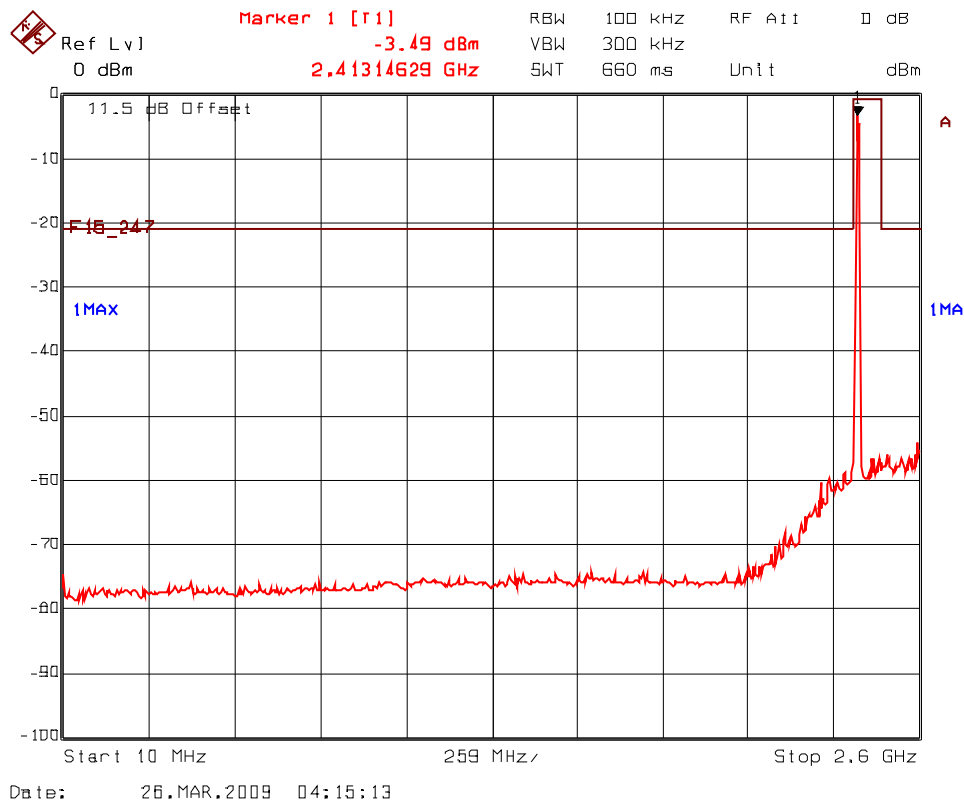

Plot 5.7.4.2.1(ii) Spurious RF Conducted Emissions, 802.11b Mode
Transmitter Frequency: 2412 MHz

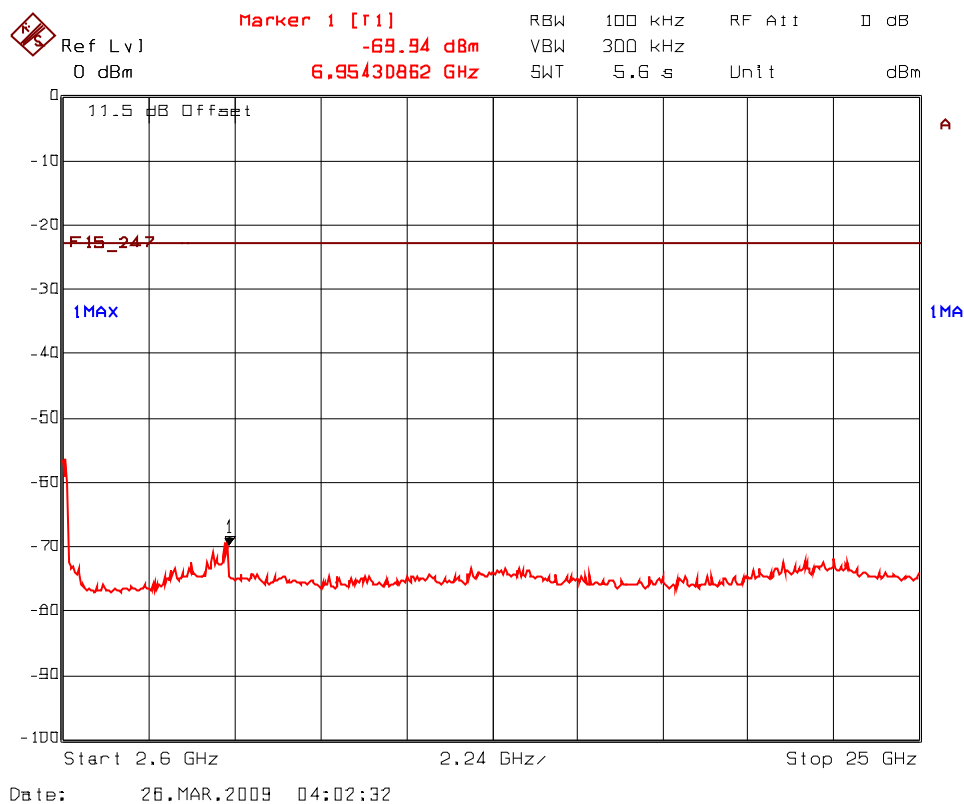

Plot 5.7.4.2.2(i) Spurious RF Conducted Emissions, 802.11b Mode
Transmitter Frequency: 2437 MHz

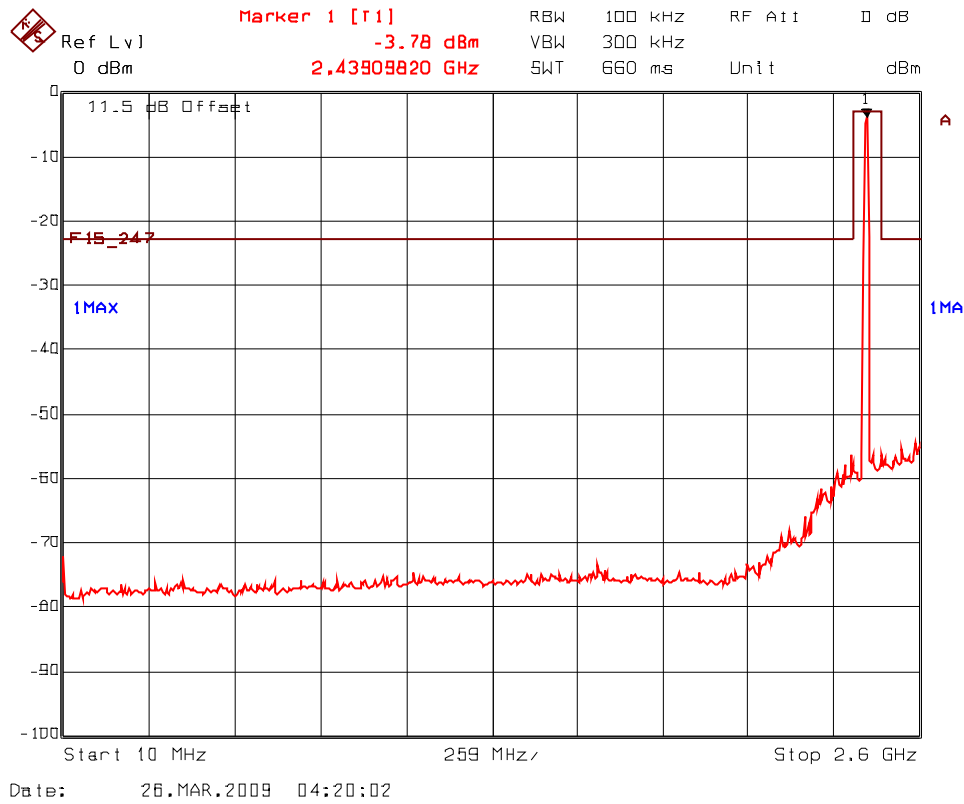

Plot 5.7.4.2.2(ii) Spurious RF Conducted Emissions, 802.11b Mode
Transmitter Frequency: 2437 MHz

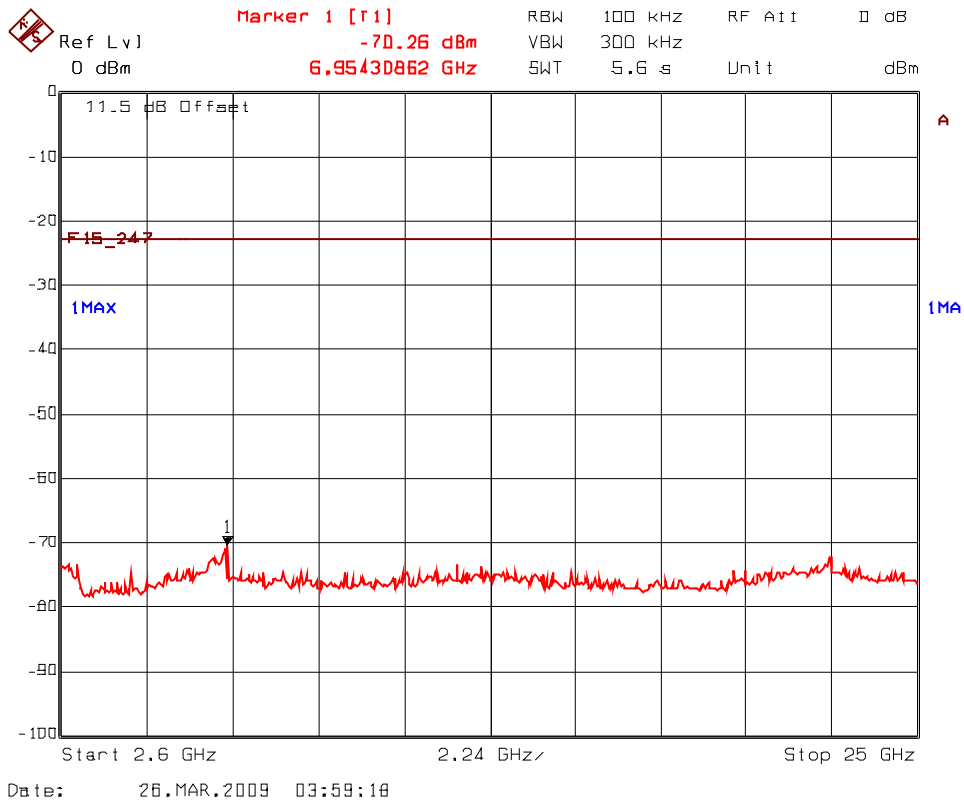

Plot 5.7.4.2.3(i) Spurious RF Conducted Emissions, 802.11b Mode
Transmitter Frequency: 2462 MHz

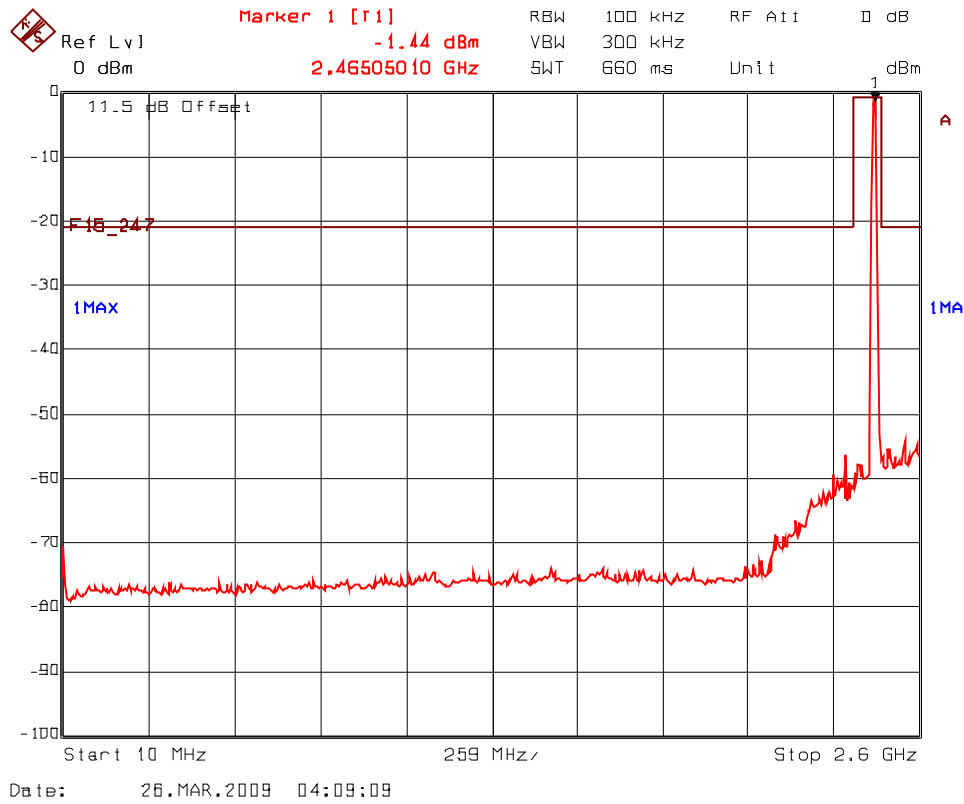

Plot 5.7.4.2.3(ii) Spurious RF Conducted Emissions, 802.11b Mode
Transmitter Frequency: 2462 MHz

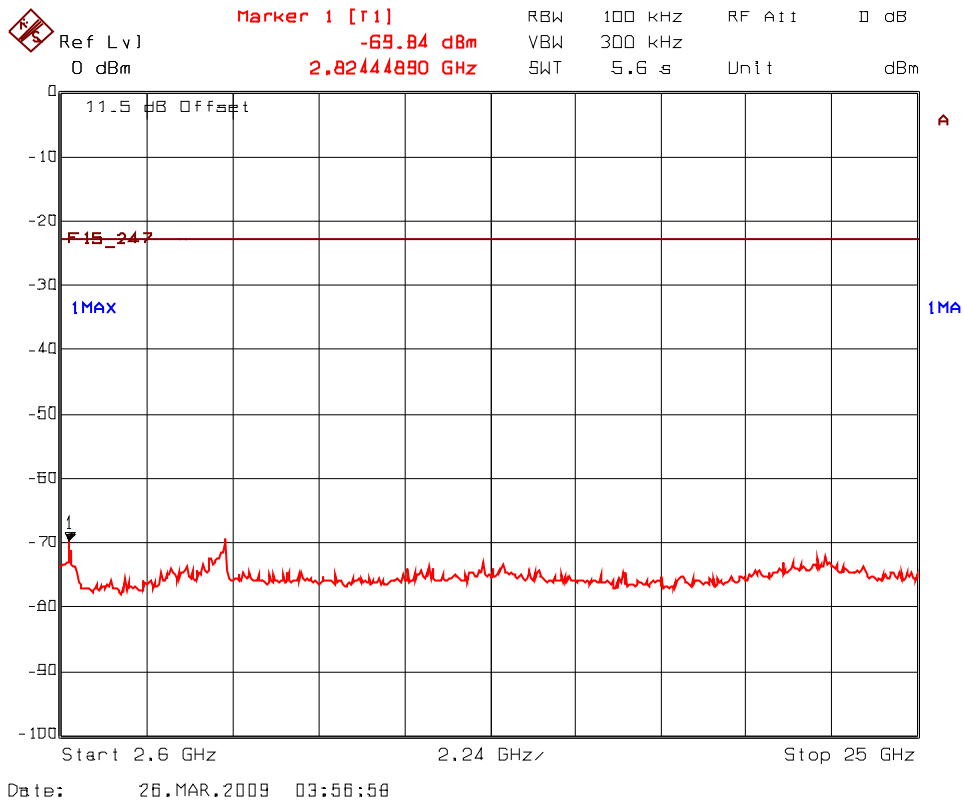

Plot 5.7.4.2.4(i) Spurious RF Conducted Emissions, 802.11g Mode
Transmitter Frequency: 2412 MHz

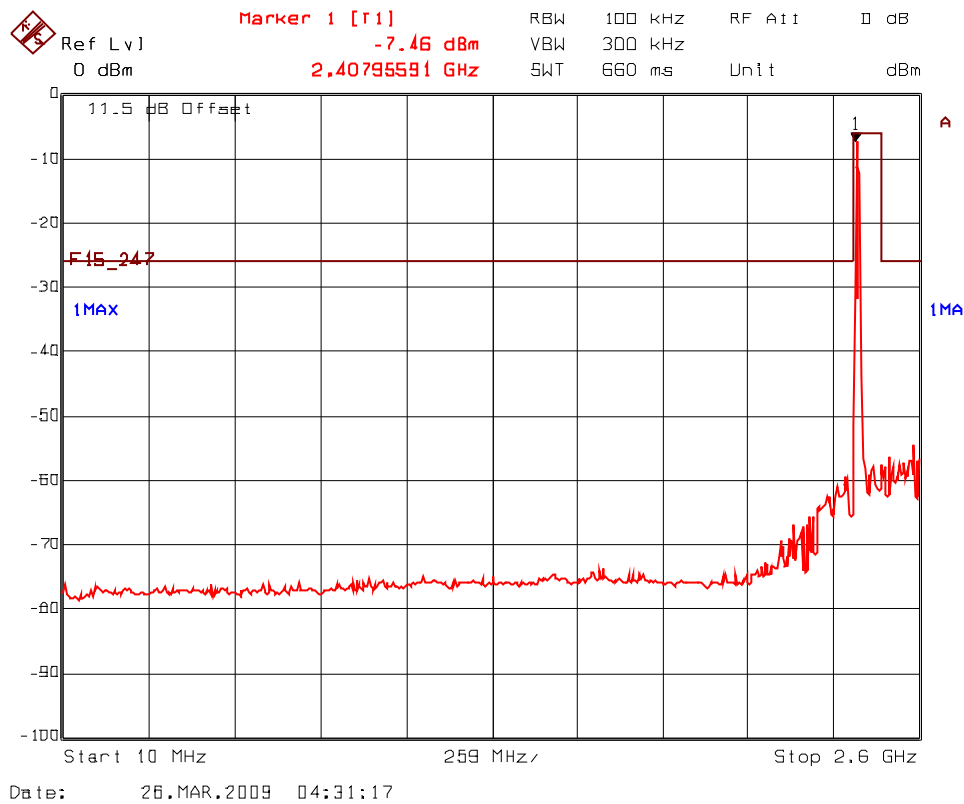

Plot 5.7.4.2.4(ii) Spurious RF Conducted Emissions, 802.11g Mode
Transmitter Frequency: 2412 MHz

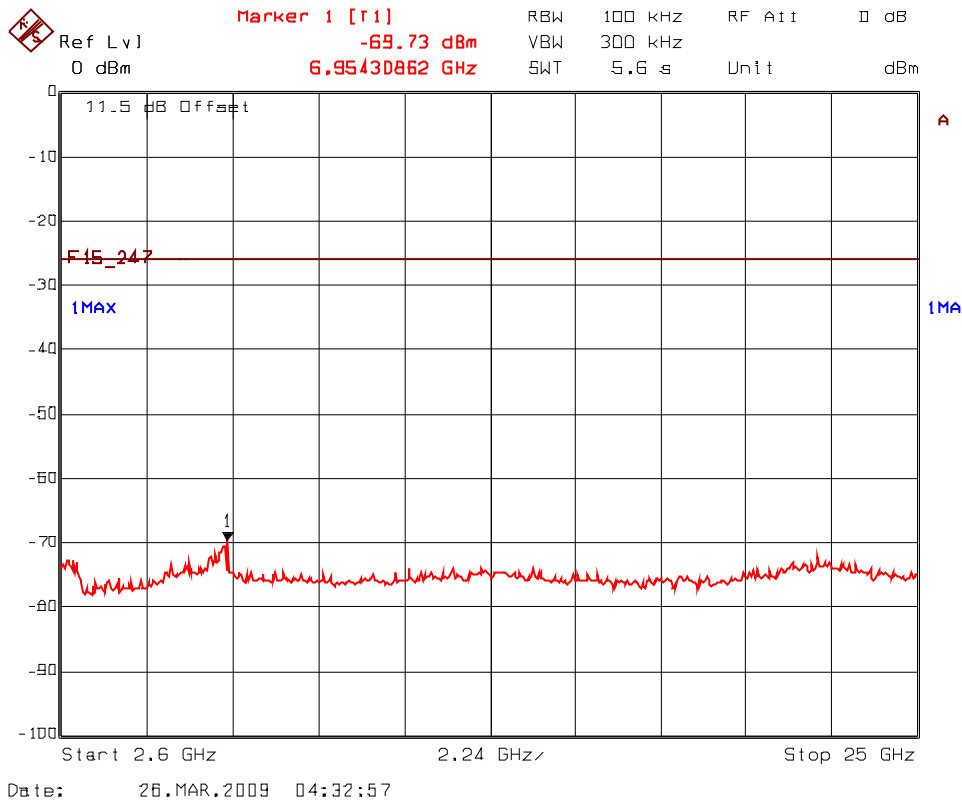

Plot 5.7.4.2.5(i) Spurious RF Conducted Emissions, 802.11g Mode
Transmitter Frequency: 2437 MHz

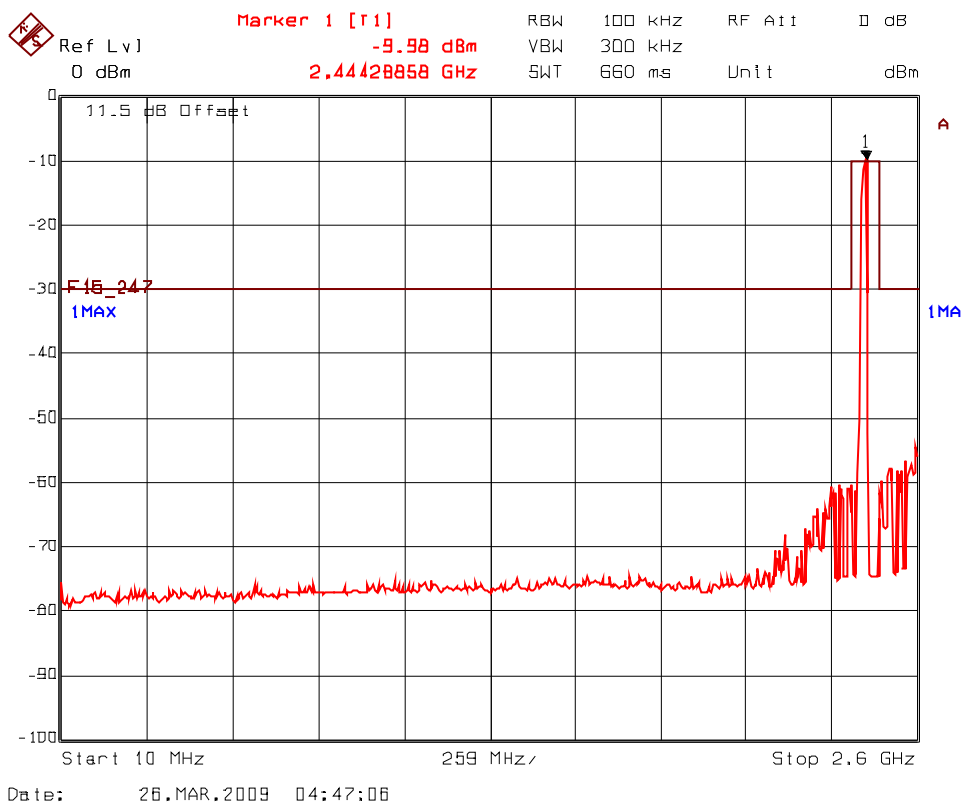

Plot 5.7.4.2.5(ii) Spurious RF Conducted Emissions, 802.11g Mode
Transmitter Frequency: 2437 MHz

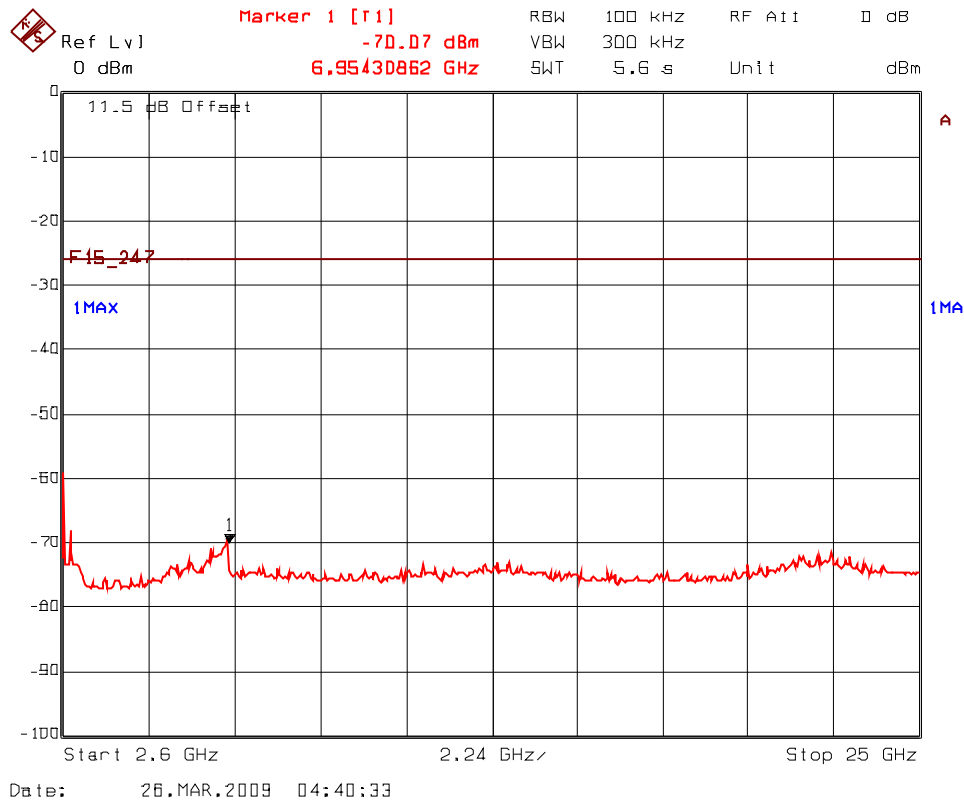

Plot 5.7.4.2.6(i) Spurious RF Conducted Emissions, 802.11g Mode
Transmitter Frequency: 2462 MHz

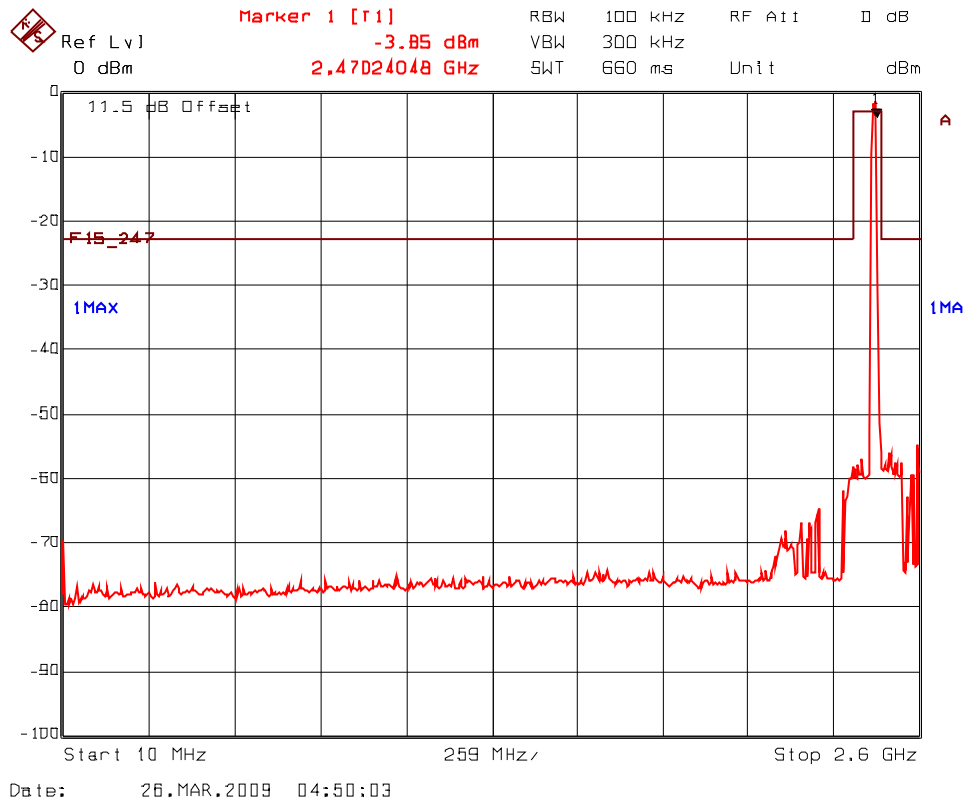

Plot 5.7.4.2.6(ii) Spurious RF Conducted Emissions, 802.11g Mode
Transmitter Frequency: 2462 MHz

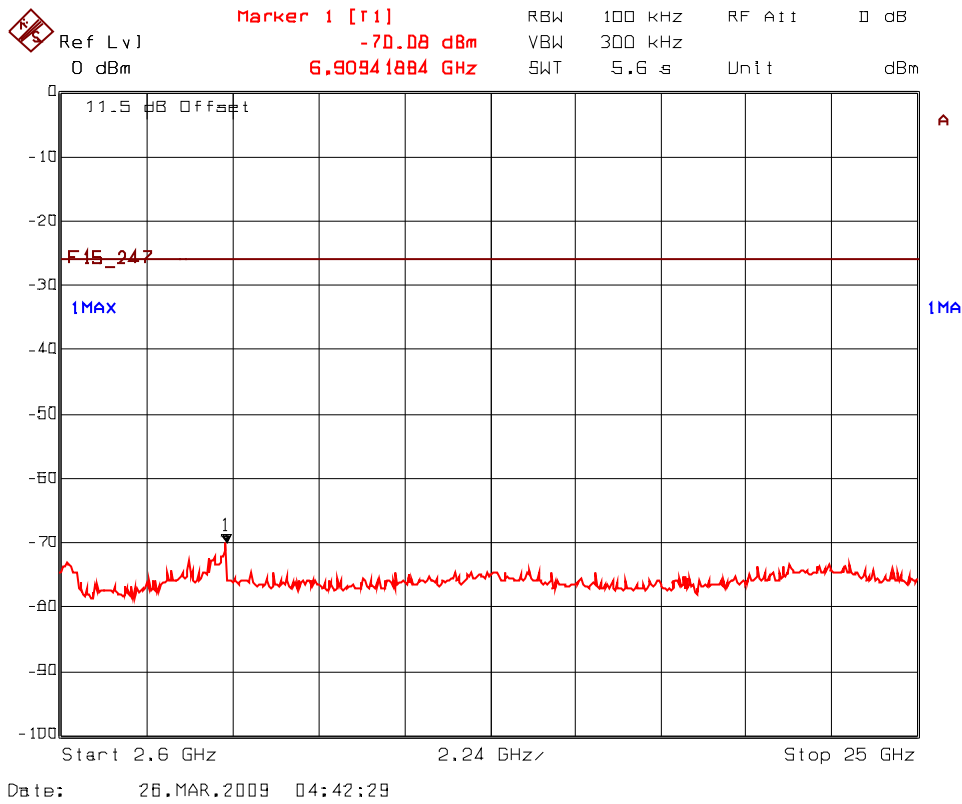

5.8. TRANSMITTER SPURIOUS RADIATED EMISSIONS AT 3 METERS [§§ 15.247(d), 15.209 & 15.205]

5.8.1. Limit(s)

§ 15.247 (d): In any 100 kHz bandwidth outside the frequency band in which the spread spectrum or digitally modulated intentional radiator is operating, the radio frequency power that is produced by the intentional radiator shall be at least 20 dB below that in the 100 kHz bandwidth within the band that contains the highest level of the desired power, based on either an RF conducted or a radiated measurement, provided the transmitter demonstrates compliance with the peak conducted power limits. If the transmitter complies with the conducted power limits based on the use of RMS averaging over a time interval, as permitted under paragraph (b)(3) of this section, the attenuation required under this paragraph shall be 30 dB instead of 20 dB. Attenuation below the general limits specified in Section 15.209(a) is not required. In addition, radiated emissions which fall in the restricted bands, as defined in Section 15.205(a), must also comply with the radiated emission limits specified in Section 15.209(a) (see Section 15.205(c)).

Section 15.205(a) - Restricted Bands of Operation

MHz	MHz	MHz	GHz
0.090–0.110	16.42–16.423	399.9–410	4.5–5.15
¹ 0.495–0.505	16.69475–16.69525	608–614	5.35–5.46
2.1735–2.1905	16.80425–16.80475	960–1240	7.25–7.75
4.125–4.128	25.5–25.67	1300–1427	8.025–8.5
4.17725–4.17775	37.5–38.25	1435–1626.5	9.0–9.2
4.20725–4.20775	73–74.6	1645.5–1646.5	9.3–9.5
6.215–6.218	74.8–75.2	1660–1710	10.6–12.7
6.26775–6.26825	108–121.94	1718.8–1722.2	13.25–13.4
6.31175–6.31225	123–138	2200–2300	14.47–14.5
8.291–8.294	149.9–150.05	2310–2390	15.35–16.2
8.362–8.366	156.52475–156.52525	2483.5–2500	17.7–21.4
8.37625–8.38675	156.7–156.9	2655–2900	22.01–23.12
8.41425–8.41475	162.0125–167.17	3260–3267	23.6–24.0
12.29–12.293	167.72–173.2	3332–3339	31.2–31.8
12.51975–12.52025	240–285	3345.8–3358	36.43–36.5
12.57675–12.57725	322–335.4	3600–4400	(²)
13.36–13.41.			

¹ Until February 1, 1999, this restricted band shall be 0.490–0.510 MHz.

² Above 38.6

**Section 15.209(a)
 -- Field Strength Limits within Restricted Frequency Bands --**

Frequency (MHz)	Field Strength (microvolts/meter)	Measurement Distance (meters)
0.009 - 0.490	2,400 / F (kHz)	300
0.490 - 1.705	24,000 / F (kHz)	30
1.705 - 30.0	30	30
30 – 88	100	3
88 – 216	150	3
216 – 960	200	3
Above 960	500	3

5.8.2. Method of Measurements

KDB Publication No. 558074: Guidance on Measurements for Digital Transmission Systems (47 CFR 15.247)

5.8.3. Test Arrangement

Refer to general test setup diagram in sec 2.6.

5.8.4. Test Data

Remark:

All spurious emissions that are in excess of 20 dB below the specified limit are recorded below in the table.

Fundamental Frequency: 2412 MHz, 802.11b Mode, CCK							
Test Frequency Range: 30 MHz – 25 GHz							
Frequency (MHz)	RF Peak Level (dBµV/m)	RF Avg Level (dBµV/m)	Antenna Plane (H/V)	Limit 15.209 (dBµV/m)	Limit 15.247 (dBµV/m)	Margin (dB)	Pass/Fail
2412	97.16	--	V	--	--	--	--
2412	93.66	--	H	--	--	--	--
No significant spurious emission found							

Fundamental Frequency: 2437 MHz, 802.11b Mode, CCK							
Test Frequency Range: 30 MHz – 25 GHz							
Frequency (MHz)	RF Peak Level (dBµV/m)	RF Avg Level (dBµV/m)	Antenna Plane (H/V)	Limit 15.209 (dBµV/m)	Limit 15.247 (dBµV/m)	Margin (dB)	Pass/Fail
2437	97.69	--	V	--	--	--	--
2437	93.76	--	H	--	--	--	--
No significant spurious emission found							

Fundamental Frequency: 2462 MHz, 802.11b Mode, CCK							
Test Frequency Range: 30 MHz – 25 GHz							
Frequency (MHz)	RF Peak Level (dBµV/m)	RF Avg Level (dBµV/m)	Antenna Plane (H/V)	Limit 15.209 (dBµV/m)	Limit 15.247 (dBµV/m)	Margin (dB)	Pass/Fail
2462	98.75	--	V	--	--	--	--
2462	92.37	--	H	--	--	--	--
No significant spurious emission found							

ULTRATECH GROUP OF LABS

3000 Bristol Circle, Oakville, Ontario, Canada L6H 6G4
 Tel. #: 905-829-1570, Fax. #: 905-829-8050, Email: vic@ultratech-labs.com, Website: http://www.ultratech-labs.com

File #: MYT-155F15C247
 October 23, 2009

All test results contained in this engineering test report are traceable to National Institute of Standards and Technology (NIST)

Fundamental Frequency: 2412 MHz, 802.11g Mode, 64QAM							
Test Frequency Range: 30 MHz – 25 GHz							
Frequency (MHz)	RF Peak Level (dBµV/m)	RF Avg Level (dBµV/m)	Antenna Plane (H/V)	Limit 15.209 (dBµV/m)	Limit 15.247 (dBµV/m)	Margin (dB)	Pass/Fail
2412	96.09	--	V	--	--	--	--
2412	92.92	--	H	--	--	--	--
No significant spurious emission found							

Fundamental Frequency: 2437 MHz, 802.11g Mode, 64QAM							
Test Frequency Range: 30 MHz – 25 GHz							
Frequency (MHz)	RF Peak Level (dBµV/m)	RF Avg Level (dBµV/m)	Antenna Plane (H/V)	Limit 15.209 (dBµV/m)	Limit 15.247 (dBµV/m)	Margin (dB)	Pass/Fail
2437	95.97	--	V	--	--	--	--
2437	92.94	--	H	--	--	--	--
No significant spurious emission found							

Fundamental Frequency: 2462 MHz, 802.11g Mode, 64QAM							
Test Frequency Range: 30 MHz – 25 GHz							
Frequency (MHz)	RF Peak Level (dBµV/m)	RF Avg Level (dBµV/m)	Antenna Plane (H/V)	Limit 15.209 (dBµV/m)	Limit 15.247 (dBµV/m)	Margin (dB)	Pass/Fail
2462	96.35	--	V	--	--	--	--
2462	93.17	--	H	--	--	--	--
No significant spurious emission found							

See the following test data plots for band-edge emissions.

ULTRATECH GROUP OF LABS

3000 Bristol Circle, Oakville, Ontario, Canada L6H 6G4
 Tel. #: 905-829-1570, Fax. #: 905-829-8050, Email: vic@ultratech-labs.com, Website: <http://www.ultratech-labs.com>

File #: MYT-155F15C247
 October 23, 2009

All test results contained in this engineering test report are traceable to National Institute of Standards and Technology (NIST)

802.11b mode, 11 Mbps data rate, CCK:

Plot 5.8.4.1. Band-Edge RF Radiated Emissions @ 3 m
Low End of Frequency Band; Test Frequency: 2412 MHz
Rx Antenna Orientation: Horizontal

Trace 1: RBW = 1 MHz, VBW = 3 MHz; Trace 2: RBW = 1 MHz, VBW = 10 Hz

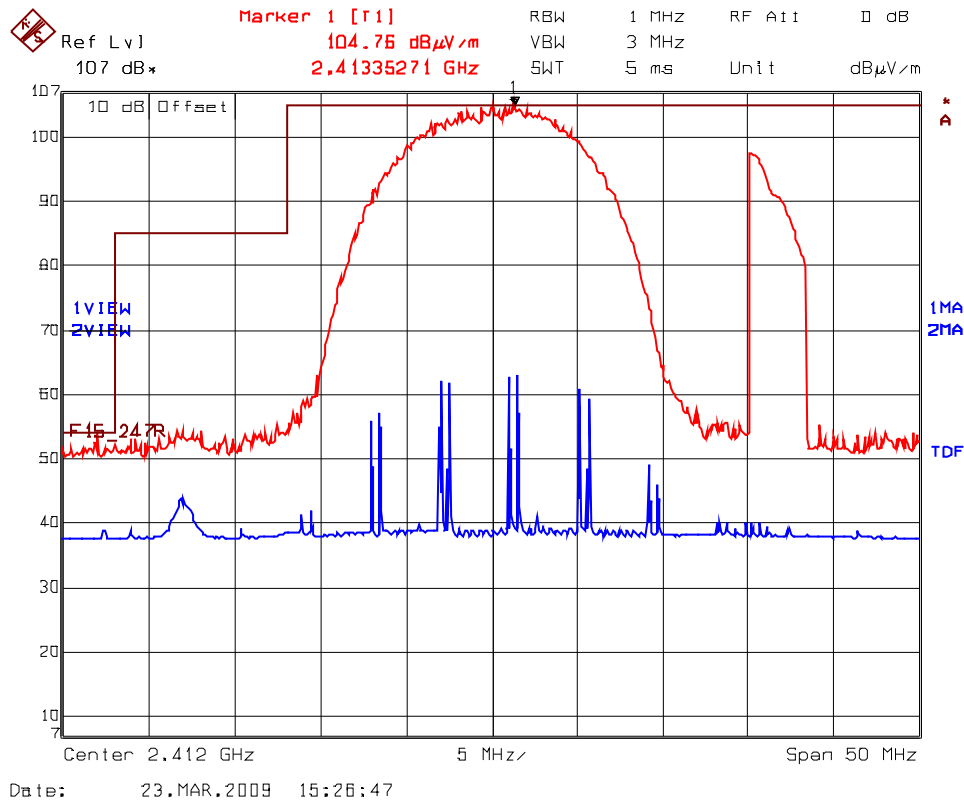

Plot 5.8.4.2. Band-Edge RF Radiated Emissions @ 3 m
 Low End of Frequency Band; Test Frequency: 2412 MHz
 Rx Antenna Orientation: Vertical

Trace 1: RBW = 1 MHz, VBW = 3 MHz; Trace 2: RBW = 1 MHz, VBW = 10 Hz

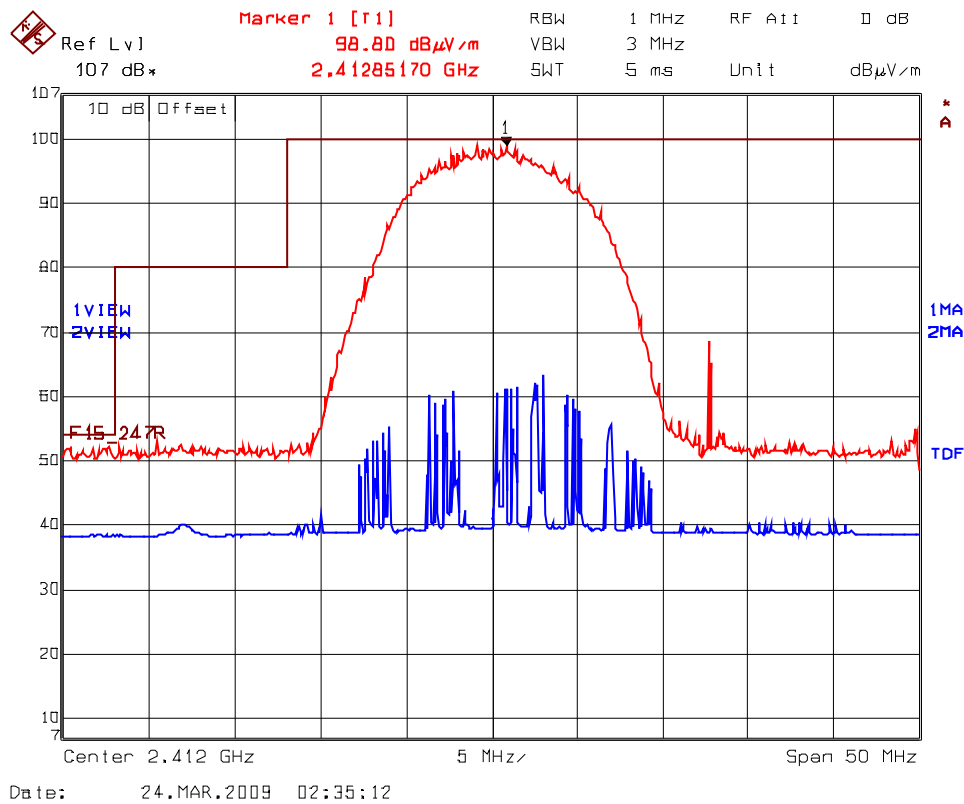

Plot 5.8.4.3. Band-Edge RF Radiated Emissions @ 3 m
 High End of Frequency Band; Test Frequency: 2462 MHz
 Rx Antenna Orientation: Horizontal

Trace 1: RBW = 1 MHz, VBW = 3 MHz; Trace 2: RBW = 1 MHz, VBW = 10 Hz

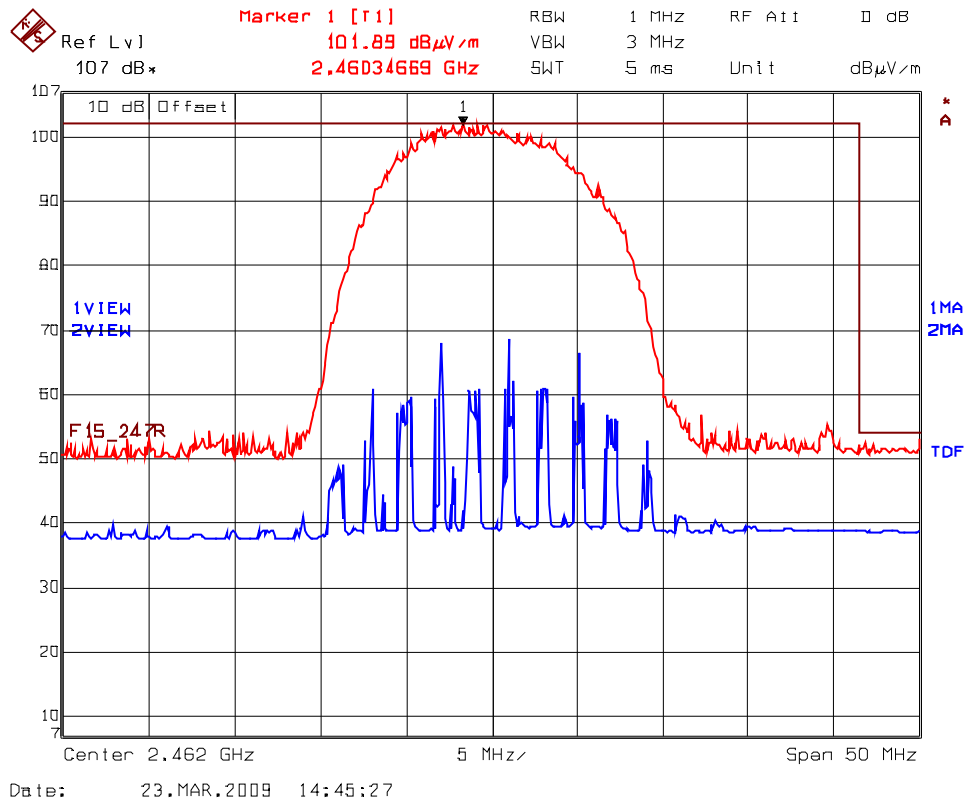

Plot 5.8.4.4. Band-Edge RF Radiated Emissions @ 3 m
High End of Frequency Band; Test Frequency: 2462 MHz
Rx Antenna Orientation: Vertical

Trace 1: RBW = 1 MHz, VBW = 3 MHz; Trace 2: RBW = 1 MHz, VBW = 10 Hz

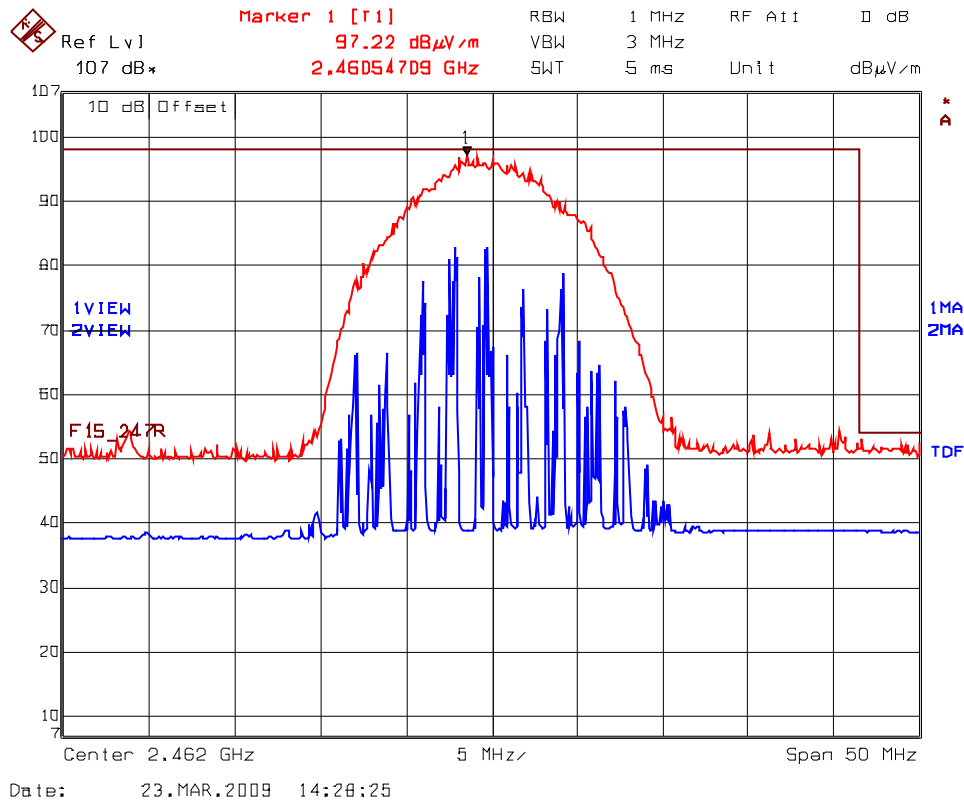

802.11g mode, 54 Mbps data rate, 64QAM:

Plot 5.8.4.5. Band-Edge RF Radiated Emissions @ 3 m
Low End of Frequency Band; Test Frequency: 2412 MHz
Rx Antenna Orientation: Horizontal

Trace 1: RBW = 1 MHz, VBW = 3 MHz; Trace 2: RBW = 1 MHz, VBW = 10 Hz

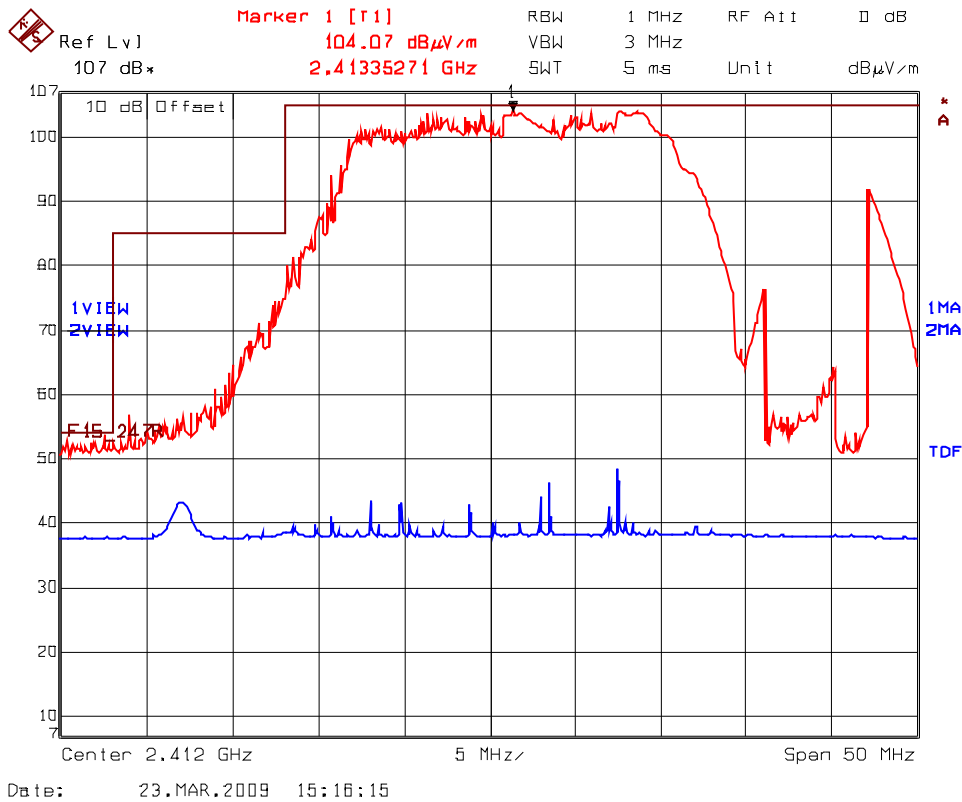

Plot 5.8.4.6. Band-Edge RF Radiated Emissions @ 3 m
 Low End of Frequency Band; Test Frequency: 2412 MHz
 Rx Antenna Orientation: Vertical

Trace 1: RBW = 1 MHz, VBW = 3 MHz; Trace 2: RBW = 1 MHz, VBW = 10 Hz

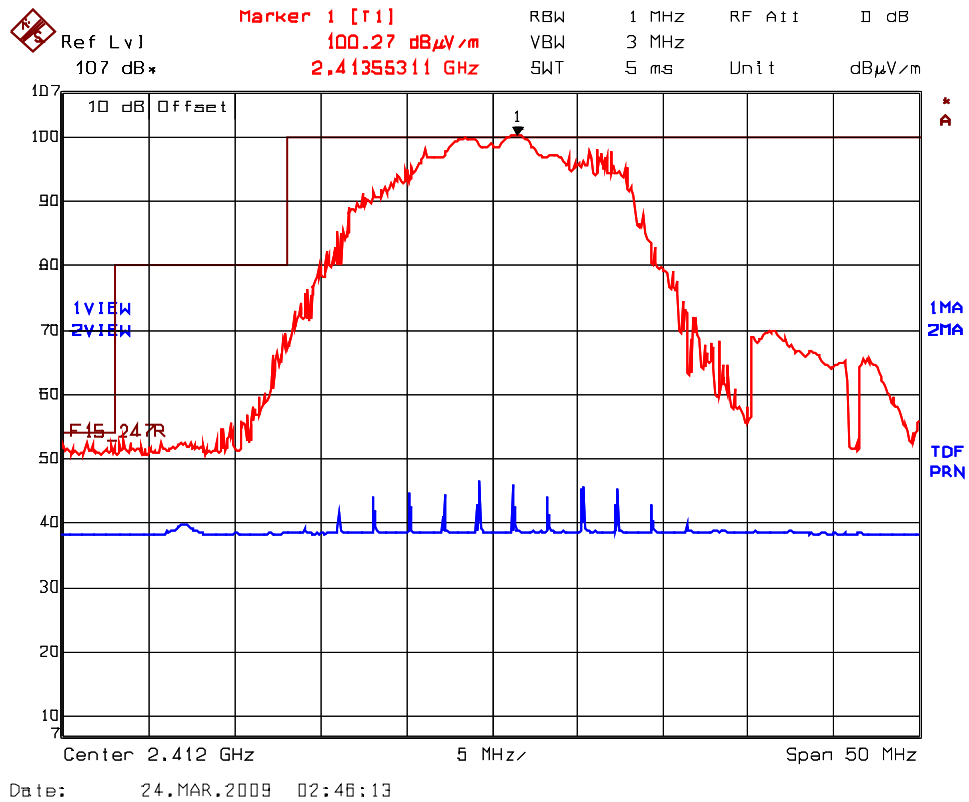

Plot 5.8.4.7. Band-Edge RF Radiated Emissions @ 3 m
 High End of Frequency Band; Test Frequency: 2462 MHz
 Rx Antenna Orientation: Horizontal

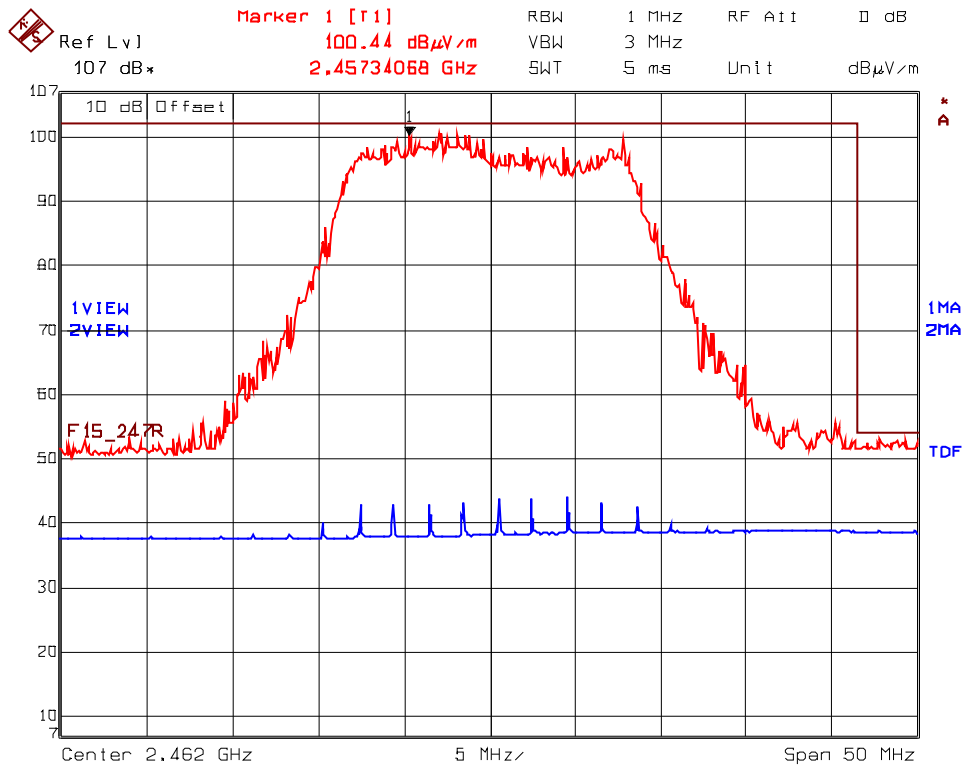

Date: 23.MAR.2009 14:56:01

Trace 1: RBW = 1 MHz, VBW = 3 MHz; Trace 2: RBW = 1 MHz, VBW = 10 Hz

Plot 5.8.4.8. Band-Edge RF Radiated Emissions @ 3 m
 High End of Frequency Band; Test Frequency: 2462 MHz
 Rx Antenna Orientation: Vertical

Trace 1: RBW = 1 MHz, VBW = 3 MHz; Trace 2: RBW = 1 MHz, VBW = 10 Hz

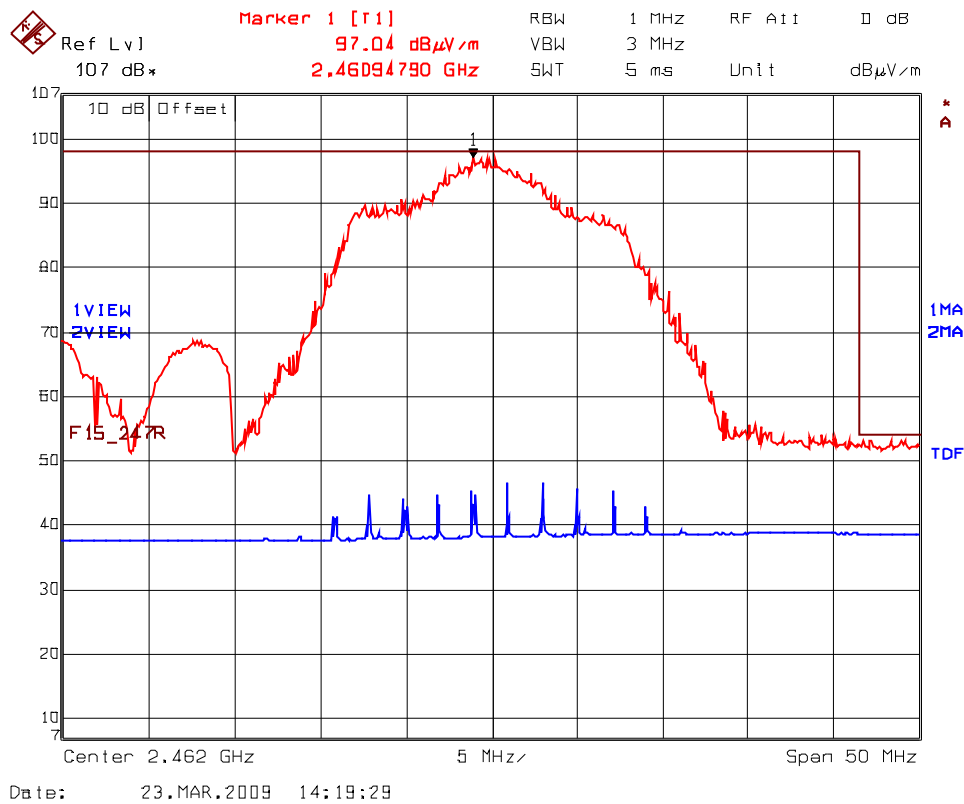

5.9. POWER SPECTRAL DENSITY [§ 15.247(e)]

5.9.1. Limit(s)

For digitally modulated systems, the power spectral density conducted from the intentional radiator to the antenna shall not be greater than 8 dBm in any 3 kHz band during any time interval of continuous transmission.

5.9.2. Method of Measurements

KDB Publication No. 558074: Guidance on Measurements for Digital Transmission Systems (47 CFR 15.247), PSD Option 1 method.

5.9.3. Test Arrangement

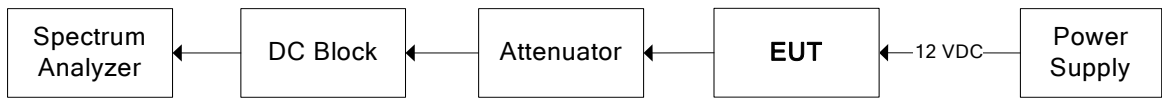

5.9.4. Test Data

Measurement method: Power spectral density (PSD) Option 1.

Frequency (MHz)	*PSD in 3 kHz BW dBm	Limit (dBm)	Margin (dB)	Comments (Pass/Fail)
802.11b mode, 11 Mbps data rate, CCK				
2412	-16.68	8	-24.68	Pass
2437	-12.82	8	-20.82	Pass
2462	-13.39	8	-21.39	Pass
802.11g mode, 54 Mbps data rate, 64QAM				
2412	-20.39	8	-28.39	Pass
2437	-18.52	8	-26.52	Pass
2462	-20.99	8	-28.99	Pass

*See the following plots for measurement details.

802.11b mode, 11 Mbps data rate, CCK:

Plot 5.9.4.1. Power Spectral Density
Frequency: 2412 MHz

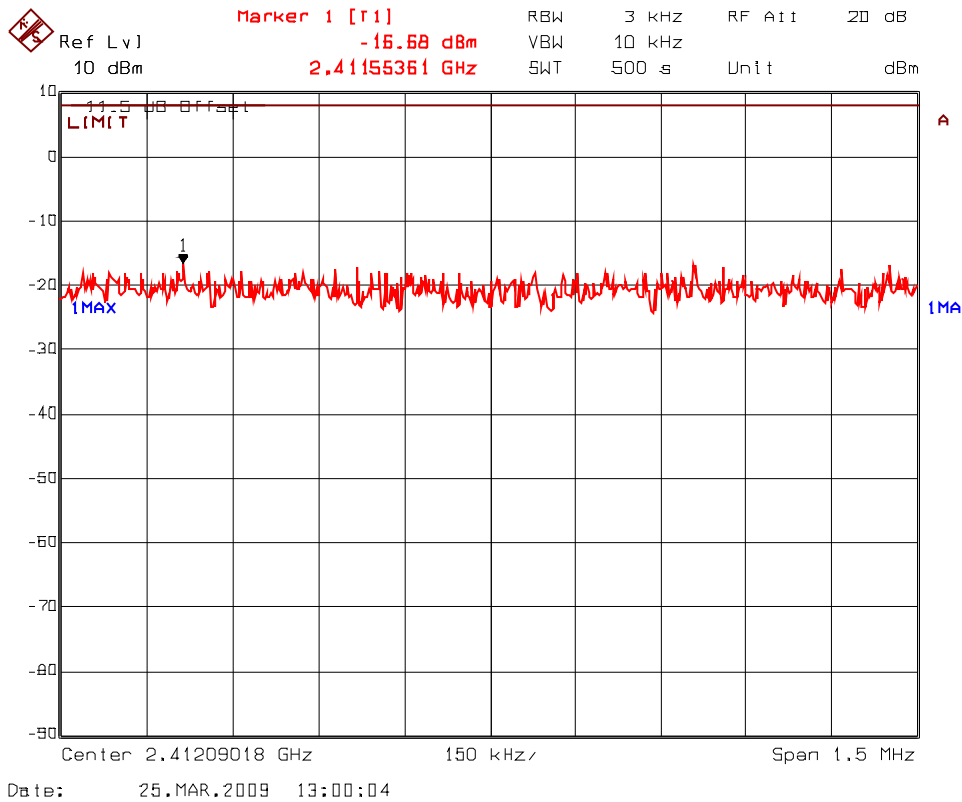

Plot 5.9.4.2. Power Spectral Density
Frequency: 2437 MHz

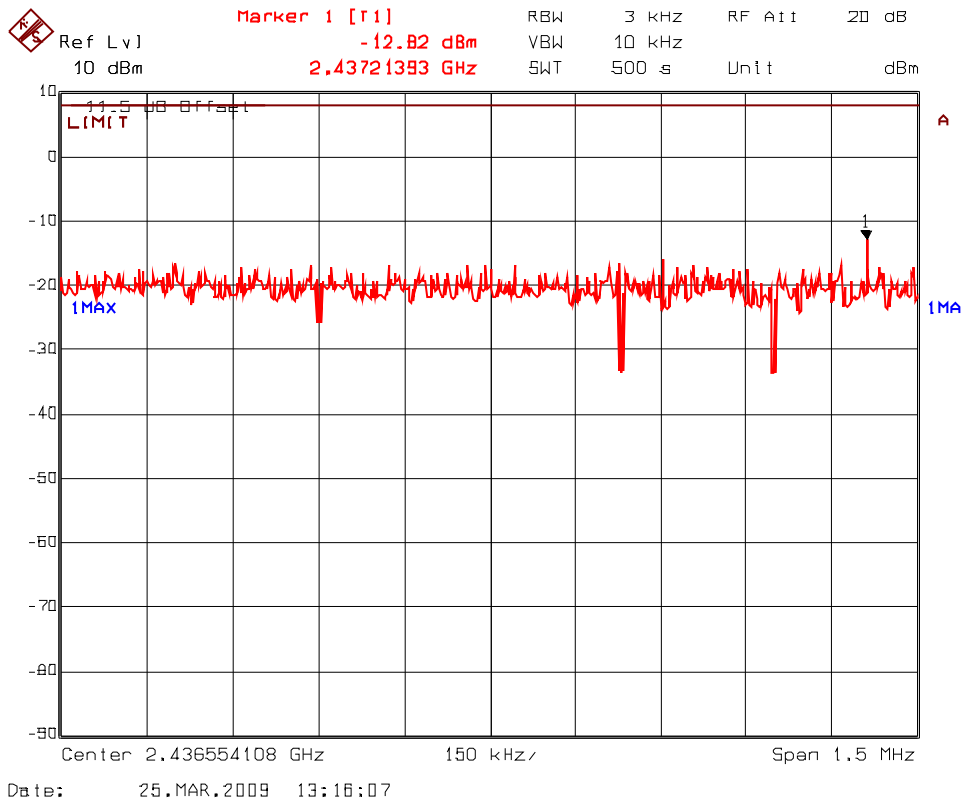

Plot 5.9.4.3. Power Spectral Density
Frequency: 2462 MHz

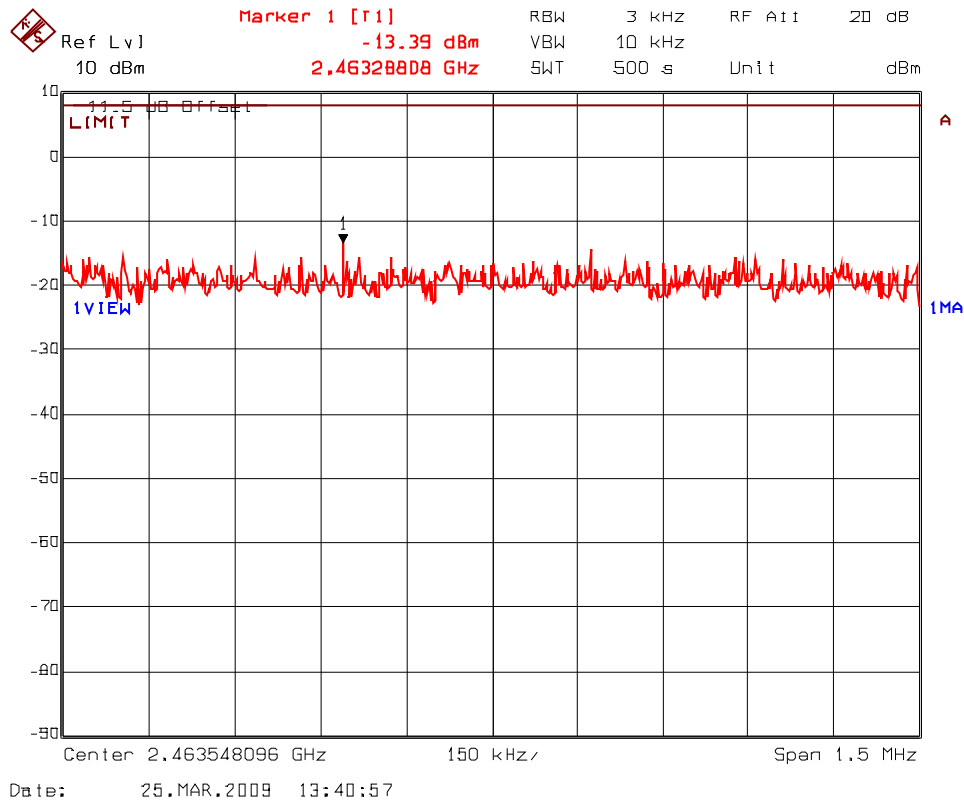

802.11g mode, 54 Mbps data rate, 64QAM:

Plot 5.9.4.4. Power Spectral Density
Frequency: 2412 MHz

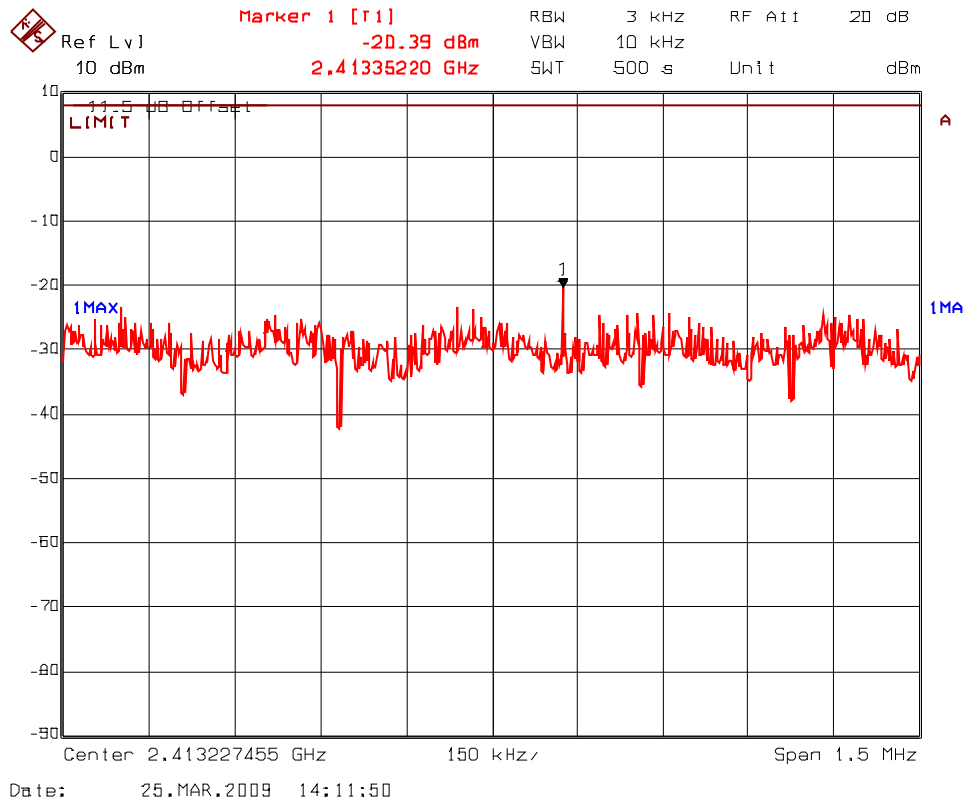

Plot 5.9.4.5. Power Spectral Density
Frequency: 2437 MHz

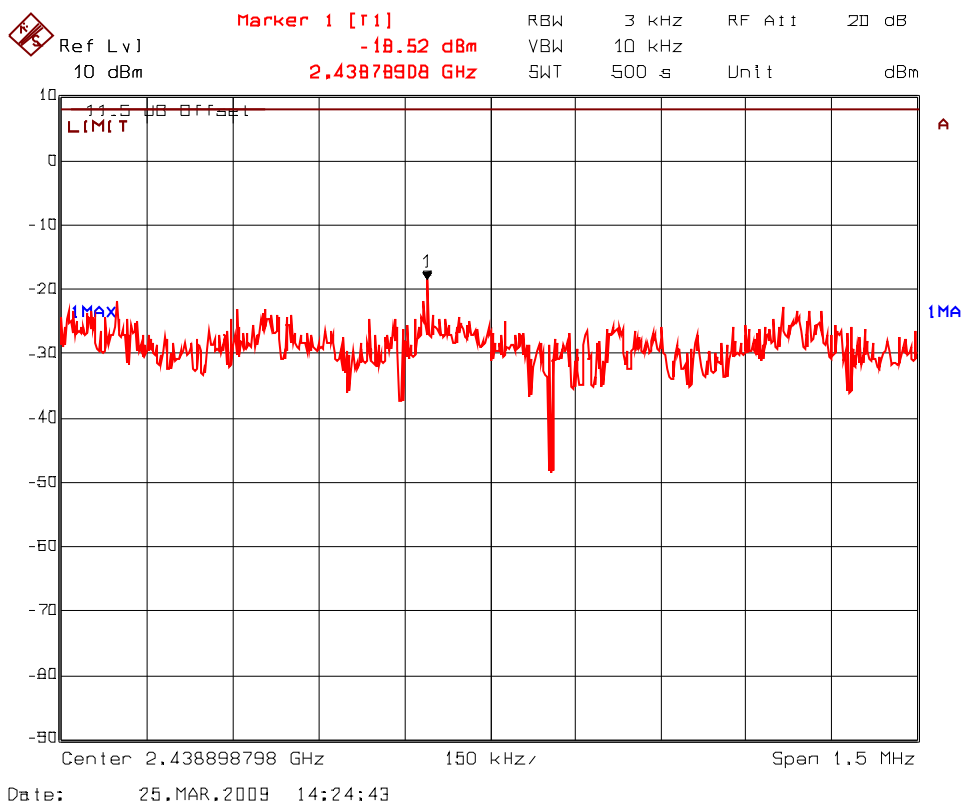

Plot 5.9.4.6. Power Spectral Density
Frequency: 2462 MHz

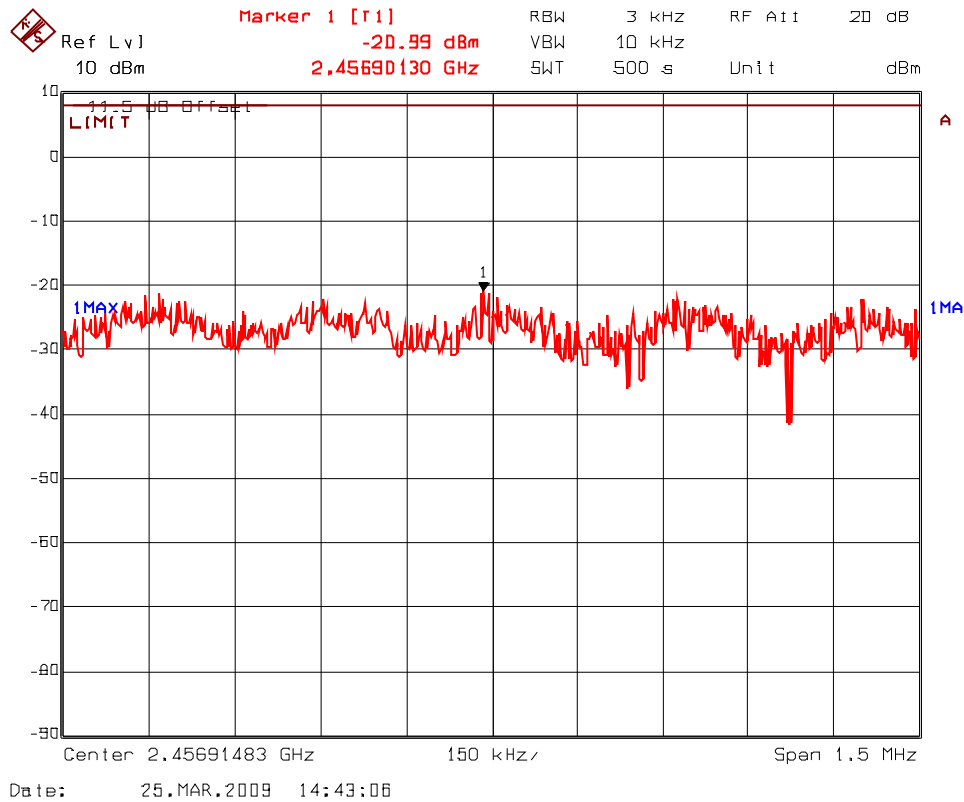

5.10. RF EXPOSURE REQUIRMENTS [§§ 15.247(i), 1.1307(b)(1) & 2.1093]

The criteria listed in the following table shall be used to evaluate the environmental impact of human exposure to radio-frequency (RF) radiation.

FCC 47 CFR § 1.1310:

TABLE 1—LIMITS FOR MAXIMUM PERMISSIBLE EXPOSURE (MPE)

Frequency range (MHz)	Electric field strength (V/m)	Magnetic field strength (A/m)	Power density (mW/cm ²)	Averaging time (minutes)
(A) Limits for Occupational/Controlled Exposures				
0.3–3.0	614	1.63	*(100)	6
3.0–30	1842/f	4.89/f	*(900/f ²)	6
30–300	61.4	0.163	1.0	6
300–1500	f/300	6
1500–100,000	5	6
(B) Limits for General Population/Uncontrolled Exposure				
0.3–1.34	614	1.63	*(100)	30
1.34–30	824/f	2.19/f	*(180/f ²)	30
30–300	27.5	0.073	0.2	30
300–1500	f/1500	30
1500–100,000	1.0	30

f = frequency in MHz

* = Plane-wave equivalent power density

NOTE 1 TO TABLE 1: Occupational/controlled limits apply in situations in which persons are exposed as a consequence of their employment provided those persons are fully aware of the potential for exposure and can exercise control over their exposure. Limits for occupational/controlled exposure also apply in situations when an individual is transient through a location where occupational/controlled limits apply provided he or she is made aware of the potential for exposure.

NOTE 2 TO TABLE 1: General population/uncontrolled exposures apply in situations in which the general public may be exposed, or in which persons that are exposed as a consequence of their employment may not be fully aware of the potential for exposure or can not exercise control over their exposure.

5.10.1. Method of Measurements

Refer to Sections 1.1310, 2.1091.

Spread spectrum transmitters operating under section 15.247 are categorically excluded from routine environmental evaluation to demonstrating RF exposure compliance with respect to MPE and/or SAR limits. These devices are not exempted from compliance (As indicated in Section 15.247(b)(4), these transmitters are required to operate in a manner that ensures that exposure to public users and nearby persons) does not exceed the Commission’s RF exposure guidelines (see Section 1.1307 and 2.1093). Unless a device operates at substantially low power levels, with a low gain antenna(s), supporting information is generally needed to establish the various potential operating configurations and exposure conditions of a transmitter and its antenna(s) in order to determine compliance with the RF exposure guidelines.

Refer to FCC @ 1.1310 and 2.1091

- In order to demonstrate compliance with MPE requirements (see Section 2.1091), the following information is typically needed:
 - (1) Calculation that estimates the minimum separation distance (20 cm or more) between an antenna and persons required to satisfy power density limits defined for free space.
 - (2) Antenna installation and device operating instructions for installers (professional/unskilled users), and the parties responsible for ensuring compliance with the RF exposure requirement
 - (3) Any caution statements and/or warning labels that are necessary in order to comply with the exposure limits
 - (4) Any other RF exposure related issues that may affect MPE compliance

Calculation Method of RF Safety Distance:

$$S = \frac{PG}{4\pi \cdot r^2} = \frac{EIRP}{4\pi \cdot r^2}$$

Where: P: power input to the antenna in mW
EIRP: Equivalent (effective) isotropic radiated power.
S: power density mW/cm²
G: numeric gain of antenna relative to isotropic radiator
r: distance to centre of radiation in cm

FCC radio frequency exposure limits may be exceeded at distances closer than r cm from the antenna of this device

$$r = \sqrt{\frac{PG}{4\pi \cdot S}} = \sqrt{\frac{EIRP}{4\pi \cdot S}}$$

5.10.2. Test Data

Antenna Gain Limit specified by Manufacturer: 3.8 dBi

(1) Lowest Frequency (MHz)	Measured Peak RF Conducted Power (dBm)	Calculated EIRP (dBm)	Exposure Condition	Calculated Minimum RF Safety Distance r (cm)*
2462 (802.11g)	14.72	18.52	General Population	2.4

RF EXPOSURE DISTANCE LIMITS

$$r = \sqrt{\frac{P \cdot G}{4 \cdot \pi \cdot S}} = \sqrt{\frac{EIRP}{4 \cdot \pi \cdot S}}$$

$$(S_{Limit}) = 1.0 \text{ mW/cm}^2$$

$$(\text{Maximum EIRP Measured}) = 18.52 \text{ dBm} \approx 10^{18.52/10} = 71.12 \text{ mW}$$

$$(\text{Minimum Safe Distance, } r) = \sqrt{\frac{EIRP}{4 \cdot \pi \cdot S}} = \sqrt{\frac{71.12}{4 \cdot \pi \cdot 1.0}} \approx 2.4 \text{ cm}$$

Evaluation of RF Exposure Compliance Requirements	
RF Exposure Requirements	Compliance with FCC Rules
Minimum calculated separation distance between antenna and persons required: *2.4 cm	Manufacturer’ instruction for separation distance between antenna and persons required: 20 cm.
Antenna installation and device operating instructions for installers (professional/unskilled users), and the parties responsible for ensuring compliance with the RF exposure requirement	N/A
Caution statements and/or warning labels that are necessary in order to comply with the exposure limits	Refer to User’s Manual for RF Exposure Information.
Any other RF exposure related issues that may affect MPE compliance	User manual confirms that “The two radios co-located within the device doesn’t transmit simultaneously”

EXHIBIT 6. TEST EQUIPMENT LIST

Test Instruments	Manufacturer	Model No.	Serial No.	Frequency Range
Spectrum Analyzer	Rhode & Schwarz	FSEK 30	100077	20 Hz - 40 GHz
Spectrum Analyzer	Rohde & Schwarz	FSEK	834157/005	9 kHz- 40 GHz
Spectrum Analyzer	Hewlett Packard	HP 8593EM	3412A00103	9 kHz – 26.5 GHz
Attenuator	Narda	4768-10	--	DC - 40 GHz
Peak Power Meter	Hewlett Packard	8900D	2131A01044	0.1 - 18 GHz
Power Sensor	Hewlett Packard	84811A	2551A01484	0.1 - 18 GHz
High Pass Filter	K & L	11SH10-4000/T12000	4	Cut off 3.4 GHz
RF Amplifier	Hewlett Packard	8447F	2944A04098	0.1 - 1300 MHz
RF Amplifier	Hewlett Packard	8449B	3008A00769	1 – 26.5 GHz
Biconilog Antenna	EMCO	3142	1005	26 MHz - 2 GHz
Horn Antenna	EMCO	3155	9701-5061	1 GHz – 18 GHz
Horn Antenna	EMCO	3155	6570	1 – 18 GHz
Horn Antenna	EMCO	3160-09	1007	18 – 26.5 GHz
Horn Antenna	EMCO	3160-10	1001	26.5 – 40 GHz
DC Block	HP	11742A	12460	0.45 - 26.5 GHz
Dell Latitude Laptop	Dell	PPL	9321C	--
RF Signal Generator	Hewlett Packard	HP 83752B	3610A00457	0.01 – 20 GHz
Combiner	Mini-circuit	15542	...	DC to 22 GHz (7 dB insertion loss)
Microwave Amplifier	Hewlett Packard	HP 8449B	3008A00769	1 GHz - 26.5 GHz
RF Amplifier	Hewlett Packard	8447F	2944A04098	0.1 - 1300 MHz

ULTRATECH GROUP OF LABS

3000 Bristol Circle, Oakville, Ontario, Canada L6H 6G4
 Tel. #: 905-829-1570, Fax. #: 905-829-8050, Email: vic@ultratech-labs.com, Website: <http://www.ultratech-labs.com>

File #: MYT-155F15C247
 October 23, 2009

All test results contained in this engineering test report are traceable to National Institute of Standards and Technology (NIST)

EXHIBIT 7. MEASUREMENT UNCERTAINTY

The measurement uncertainties stated were calculated in accordance with the requirements of NIST Technical Note 1297 and NIS 81 (1994)

7.1. LINE CONDUCTED EMISSION MEASUREMENT UNCERTAINTY

CONTRIBUTION (Line Conducted)	PROBABILITY DISTRIBUTION	UNCERTAINTY (dB)	
		9-150 kHz	0.15-30 MHz
EMI Receiver specification	Rectangular	± 1.5	± 1.5
LISN coupling specification	Rectangular	± 1.5	± 1.5
Cable and Input Transient Limiter calibration	Normal (k=2)	± 0.3	± 0.5
Mismatch: Receiver VRC $\Gamma_1 = 0.03$ LISN VRC $\Gamma_R = 0.8(9 \text{ kHz}) 0.2 (30 \text{ MHz})$ Uncertainty limits $20\text{Log}(1 \pm \Gamma_1 \Gamma_R)$	U-Shaped	± 0.2	± 0.3
System repeatability	Std. deviation	± 0.2	± 0.05
Repeatability of EUT	--	--	--
Combined standard uncertainty	Normal	± 1.25	± 1.30
Expanded uncertainty U	Normal (k=2)	± 2.50	± 2.60

Sample Calculation for Measurement Accuracy in 450 kHz to 30 MHz Band:

$$u_c(y) = \sqrt{\sum_{i=1}^m u_i^2(y)} = \pm \sqrt{(1.5^2 + 1.5^2)/3 + (0.5/2)^2 + (0.05/2)^2 + 0.35^2} = \pm 1.30 \text{ dB}$$

$$U = 2u_c(y) = \pm 2.6 \text{ dB}$$

7.2. RADIATED EMISSION MEASUREMENT UNCERTAINTY

CONTRIBUTION (Radiated Emissions)	PROBABILITY DISTRIBUTION	UNCERTAINTY (\pm dB)	
		3 m	10 m
Antenna Factor Calibration	Normal (k=2)	± 1.0	± 1.0
Cable Loss Calibration	Normal (k=2)	± 0.3	± 0.5
EMI Receiver specification	Rectangular	± 1.5	± 1.5
Antenna Directivity	Rectangular	± 0.5	± 0.5
Antenna factor variation with height	Rectangular	± 2.0	± 0.5
Antenna phase center variation	Rectangular	0.0	± 0.2
Antenna factor frequency interpolation	Rectangular	± 0.25	± 0.25
Measurement distance variation	Rectangular	± 0.6	± 0.4
Site imperfections	Rectangular	± 2.0	± 2.0
Mismatch: Receiver VRC $\Gamma_1 = 0.2$ Antenna VRC $\Gamma_R = 0.67$ (Bi) 0.3 (Lp) Uncertainty limits $20\text{Log}(1 \pm \Gamma_1 \Gamma_R)$	U-Shaped	+1.1 -1.25	± 0.5
System repeatability	Std. Deviation	± 0.5	± 0.5
Repeatability of EUT		-	-
Combined standard uncertainty	Normal	+2.19 / -2.21	+1.74 / -1.72
Expanded uncertainty U	Normal (k=2)	+4.38 / -4.42	+3.48 / -3.44

Calculation for maximum uncertainty when 3m biconical antenna including a factor of k = 2 is used:

$$U = 2u_c(y) = 2x(+2.19) = +4.38 \text{ dB} \quad \text{And} \quad U = 2u_c(y) = 2x(-2.21) = -4.42 \text{ dB}$$