

Thank you for your interest in our products. This manual will help you to master the operation and use of the AWR-D6000. This manual should be read and studied to ensure that the user understands the operation of the AWR-D6000. Please read the Safety Information Manual before use.

This manual applies to the model,
AWR-D6000 series digital handheld.

TO THE USER

Thank you for purchasing this digital / analog two-way radio designed and manufactured by the Fujian New Century Communications Co., Ltd. This product is designed and developed according to EU standards and advanced international technologies. The radio has an ergonomic design and a comprehensive set of functions to deliver an advanced communication solution. It will bring you a whole new operation and digital communication experience, improve your work efficiency, and provide reliable communications.

Our products are tested to strict and rigorous test procedures using advanced test instruments and equipment to internationally recognized standards.

This manual should be read and studied to ensure that the user understands the operation of the AWR-D6000. Please read the Safety Information Manual before use.

USER NOTICES

SAFETY:

The user should be aware of and understand the general hazards in operating a two-way radio transceiver. We cannot guarantee the safety and operation of our transceiver with aftermarket accessories unless they have been tested and sold by us.

Our transceiver should be maintained and serviced by a qualified two-way radio dealer and their technical staff. Failure to do so may violate our warranty.

WARNING:

No two-way radio transceiver including ours shall be operated including powered on in hazardous areas such as explosive atmospheres including Inflammable gas, dust particles, metallic powders, grain dust, etc. This shall include confined spaces where these hazards exist, in areas where blasting or blasting products are in use or stored, and while fueling at refueling centers. In any of these conditions or where hazards exist, the transceiver shall be powered off.

PRECAUTIONS

Observe the following precautions to prevent fire, personal injury and transceiver damage.

- Do not modify or attempt to adjust this transceiver for any reason.
- Do not expose the transceiver to direct sunlight for long periods , nor place it close to a heat source.
- Do not place the transceiver in a dusty, humid or wet area, nor place on unstable surface.
- If an abnormal odor or smoke is detected coming from the transceiver, switch OFF immediately and remove the battery pack from the transceiver. Contact your dealer.

How to use this user manual

This manual introduces the basic operation of Kydera compatible DMR / Analog handheld transceiver.

Your dealer or system administrator may have already preset the features of this radio based on your operational requirements. Please consult with your dealer or system administrator about the details.

The icons below are used for distinguishing between analog and digital features.



This icon indicates the function is only available in Analog mode



This icon indicates the function is only available in Digital mode

[Contents]

Packing list	4
Radio controls	5
Parts description.....	5
Status icons.....	6
LED indicator.....	6
Preparation for operating the terminal	6
Install the battery pack.....	6
Install the audio accessories.....	6
Charge the battery pack.....	7
Programmable keys.....	7
Programmable functions.....	7
Keys usage and operation.....	8

[Contents]

Recognition of transmitting and receiving ICONS.....	9
Basic operations	9
PTT call	9
Digital channel call.....	9
Analog mode initiating and receiving calls (no signaling)...	10
Access menus and operations	10
Menu items list	11
Main functions description	12
General guide for fault handling	14
Maintenance and clean	16
Standard accessories	17

Packing list

The following items are contained in the gift box. If any item is missing or damaged, please contact your dealer.

Item Name	Quantity (pc)	Item Name	Quantity (pc)
Radio unit	1	Hand strap	1
Battery pack	1	User manual	1
Power supply	1	Charger(Optional)	1
Belt clip	1		

 **Note:**

After purchase, please check the items and quantity in the box to ensure everything is correct.

Radio Controls

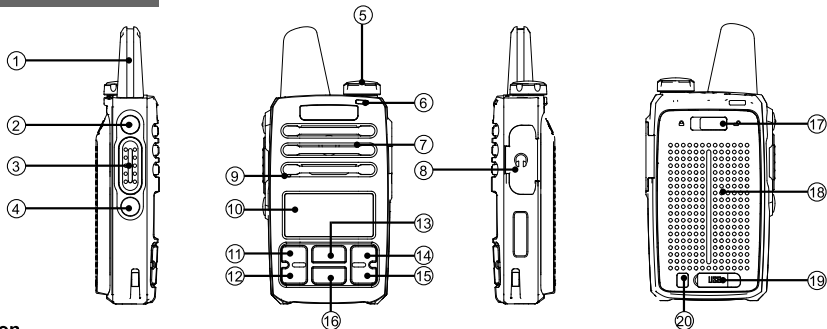

Parts description

No.	Part Name	No.	Part Name	No.	Part Name	No.	Part Name
①	Antenna	⑥	LED Indicator	⑪	OK / Menu key	⑯	Down key
②	Side Key (PF1)	⑦	Speaker	⑫	Programmable key PF3	⑰	Battery push button
③	PTT key	⑧	SP / MIC connector	⑬	Up key	⑱	Battery pack
④	Side Key (PF2)	⑨	MIC	⑭	Back / Zone key	⑲	USB charging port
⑤	PWR.Switch/Volume	⑩	LCD display	⑮	Home key	⑳	LED charging indicator

 **Note:** For convenient use, there are programmable [PF] keys

Status Icons

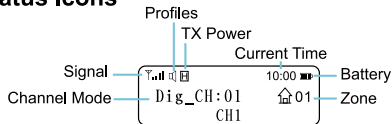

The current channel name

- | | |
|---|---|
| Indicates High Power | Indicates GPS is on |
| Indicates Low Power | Indicates Scan is on |
| Indicates no signal | Indicates the terminal is in Emergency Mode |
| The more bars indicate stronger signal | Indicates the Encryption is on |
| The more bars indicates higher battery capacity | Indicates CTCSS is on |
| Indicates the terminal is monitoring the selected channel | Indicates DCS is on |
| Indicates VOX is on | Standard Mode |
| | Silent Mode |
| | Contacts Type |
| | Keypad Lock On |

LED Indicators

LED indicator	Radio Status
Green	Receiving
Red	Transmitting
Fast Flashing Green	Scanning
Slow Flashing Red	Low battery

Preparation for operating the terminal

Install the battery pack

Align the two tabs on the bottom of the battery with the corresponding two grooves on radio, press the battery and the back of the radio together, and then manually push the battery latch left to lock.

Note: To remove the battery, turn off the radio , then slide the battery latch right to unlock and then take out it.

Install the audio accessories

1. Open the dust cover of the accessory interface.
2. Insert the audio accessory plug into the accessory connector.

Charge the battery pack



Note:

- Please charge the battery pack with the designated charger.
 - Please refer to the charging safety information before charging to obtain the necessary battery safety information.
-

When the radio is used for the first time without charging, there may be a low battery alert. Please turn it off and charge before use.

Charge the battery with following steps below:

1. Plug the Type C connector of the power cable into the USB charging jack on the back of the battery.
2. Plug the power supply into a power outlet
3. The LED charging indicator at the bottom of the battery indicates the charging status.







Charger LED Indicators	Current Status
 Red	Charging
 Green	Standby (No load) or Fully charged

Programmable Keys

- Short Press: press and release quickly (programmable range is from 50ms-750ms).
- Long Press: press and hold for programmed time length (programmable range is from 500ms-5000ms).

Programmable Functions

If desired, the following terminal features can be preset for programmable keys:

Type	Features	Description
	Radio Revive	Revive a target radio that has been remotely disabled
	Radio Detection	Determine if targeted radio is active
	Radio Kill	Disable targeted radio remotely
	Remote Monitor	Covert activation of targeted radios transmitter without local indicators.
	Encryption On/Off	Turn on/off encryption
	Emergency On/Off	Initiate an emergency alarm mode or call based on programmed preset.
	Contacts List	Direct access to the programmed contact list
	Monitor	Always monitor the selected channel until disabled.
	Zone Switch	Changes from selected Zone to new Zone
	Scan On/Off	Turn scanning on/off
	VOX On/Off	Switch between VOX On and Off.
	Backlight On/Off	Turn backlight On/Off
	Keypad Lock	Switch between keypad lock and unlock.
	High /Low Power	Switch transmit power between high and low power
	Man Down On/Off	Switch between Man Down alarm On and Off (Optional)
	Scan Mode	Switch between SE/TO/CO mode
	Repeater /Talk Around	Switch between Repeater and Talk Around Mode
	SMS	Quick access to SMS

Keys usage and operation













The following buttons can be set for the noted functions.

Keys	Status	Operations	Description
[MENU]	Standby	Short press	Access to Menu
		Long press (3S)	[Lock] or [Unlock]
[BACK]	In Menu Mode	Short press	[Confirm] or [Selections]
	Standby(Channel Mode)	Short press	Access to Zone list
	In Menu Mode	Short press	Return to previous menu
PF3(Green key)	Standby	Short press	※ Edit "VFO" parameters
		Long press (3S)	Function works based on programmed preset
Home (Red key)	In any status	Short press	Function works based on programmed preset
	Standby (VFO Mode)	Short press	Cancel or Exit current operation mode
	Standby	Long press (3S)	※Set the VFO mode, channel space and frequency according to the  icon on the LCD display.
Up key	Standby	Short press	※ Switch between Channel display and VFO mode
		Long press (3S)	Upward select channel / frequency and set other parameters
	In Menu Mode	Short press	Turn on Scan: Upward increase scanning channel / frequency
Down key	Standby	Short press	Select menu and other set parameters
		Long press (3S)	Downward select channel / frequency and set other parameters
	In Menu Mode	Short press	Turn on Scan: Downward decrease scanning channel / frequency
Side key [PF1]	Standby	Short press	Select menu and other set parameters
		Long press (3S)	Function works based on programmed preset
Side key [PF2]	Standby	Short press	Function works based on programmed preset
		Long press (3S)	Function works based on programmed preset





 **Note:** The items with the "※" symbol is model dependent.

Transmit / Receiving ICONS

The following icon appears on the radio screen to indicate the radio status.

Mode	Type	ICON	Terminal product status
	Private call		Sending a private call
			Receiving a private call
	Group Call		Sending a group call
			Receiving an group call
	All Call		Sending an All Call
			Receiving an All Call
	—		Sending an analog transmission
			Receiving an analog transmission

Basic operations







Icon	Operation instruction
	Turn on: turn the [Power/Volume] knob clockwise until you hear "click"
	Turn off: turn the [Power/Volume] knob counterclockwise until you hear a click
	After power on, rotate the [Power/Volume] knob to increase or decrease the volume
	After power on, press [▲] or [▼] to select your desired channel or frequency.

PTT call



To ensure an optimal transmission, hold the radio in a vertical position at one to two inches (2.5 to 5.0 centimeters) away from the mouth.

Digital channel call

Digital calls are made as a group call, private call or All Call based on the programming of the radio. An individual channel may be preset to one of these calling functions.

Call type	Operation method	
	Making call	Receiving call
Private call	In standby mode, press [PTT] key to initiate the call. When a call is initiated, the screen displays:  ;	When a private call received, the screen displays:  ;
Group call	When initiated a group call, the screen displays:  ;	When a group call received, the screen displays:  ;
All call	When Initiated an all call, the screen displays:  ;	When an all call received, the screen displays:  ;

Analog mode initiating and receiving calls (no signaling)

You can initiate calls to all users on the current analog channel by holding down the [PTT] key. When the call is initiated, the TFT display displays shows  ; The display shows  when you receive calls from other users on the current analog channel.

Access menus and operations

You can access the main menu and sub-menu options of the radio through the following steps, as well as functions such as setting or browsing the parameters and configuration, and viewing and sending short messages.

Note:

Access to sub-menu:

☉ Icon " " or " " refers to ON/OFF.

Procedures:

When the radio is in standby:

1. Press [MENU] key to access to menu.
2. Press [▲] or [▼] key to select a desired setting "main menu", then press [Menu] key to select.
3. Press [▲] or [▼] key to a desired "Sub-menu" setting, then press [Menu] to select.
 - ◆ If necessary, you can set each parameter or turn on/off by pressing the [▲] or [▼] keys, and then press the [Menu] key to confirm.

OR

Press [Back] key to back to previous menu.