

ABH-400

Bluetooth Headset

Manual

ADVANCED WIRELESS COMMUNICATION

SAFETY INFORMATION

WARNING!

Permanent hearing loss may result from long-term exposure to sound at high volumes. Use as low a volume as possible.

Headsets are capable of delivering sounds at loud volumes and high pitched tones. Under certain circumstances, exposure to such sounds can result in permanent hearing loss damage. The volume level may vary based on conditions such as the phone you are using, its reception and volume settings, and the environment. Avoid prolonged use of the headset at excessive sound pressure levels. Please read the Safety Guidelines below prior to using this headset.

Reduce the Risk of Hearing Damage by Following These Safety Guidelines

- Keep the volume at the lowest level possible and avoid using the headset in noisy environments where you may be inclined to turn up the volume;
- If increased volume is necessary, adjust the volume control slowly;
- Ringing in the ears may indicate that the sound levels are too high;
- If you experience discomfort or ringing in your ears, immediately discontinue using the headset and consult a physician; and stop using the headset if it causes great discomfort.

SAFETY INFORMATION!

- If you have a pacemaker or other electrical medical devices, you should consult your physician before using this product.
- This package contains small parts that may be hazardous to children and should be kept out of reach from children. This product is not a toy – never allow children to play with this product. Always store the product out of reach from children. The bags themselves or the many small parts they contain may cause choking if ingested.
- Never try to dismantle the product yourself, or push objects of any kind into the products, as this may cause short circuits which could result in a fire or electric shock.
- None of the components can be replaced or repaired by users. Only authorized dealers or service centers may open the product. If any parts of your product require replacement for any reason, including normal wear and tear or breakage, contact your dealer.
- Avoid exposing your product to rain, moisture or other liquids to protect against damage to the product or injury to you.
- Keep all products, cords, and cables away from operating machinery.
- Observe all signs and instructions that require an electrical device or RF radio product to be switched off in designated areas such as hospitals, blasting areas, potentially explosive atmospheres, or aircrafts.
- If the product overheats, if the product has been dropped or damaged, if the product has a damaged cord or plug, or if the product has been dropped in a liquid, please discontinue use.
- Never mount or store the product over any airbag deployment area, as serious injury may result when an airbag deploys.
- Dispose of the product according to local standards and regulations.

Built-in battery care:

- Your product is powered by a rechargeable battery.
- The full performance of a new battery is achieved only after two or three complete charge and discharge cycles.
- The battery can be charged and discharged hundreds of times, but will eventually wear out.
- Do not leave a fully charged battery connected to a charger, since overcharging may shorten its lifetime.
- If left unused, a fully charged battery will lose its charge over time.
- Leaving the product in hot or cold places, such as in a closed car in the summer and winter conditions, will reduce the capacity and lifetime of the battery.
- Always try to keep the battery between 0°C and 40°C (32°F and 104°F). A product with a hot or cold battery may not work temporarily, even when the battery is fully charged. Battery performance is particularly limited in temperatures well below freezing.

Battery warning!

- Do not attempt to open the product or replace the battery. It is built-in and not changeable. Use of other batteries may present a risk of fire or explosion and the warranty will be terminated.
- Only recharge your battery with the provided approved chargers designated for this product.
- Dispose of batteries according to local regulations. Please recycle when possible. Do not dispose as household waste or in a fire as they may explode.

Charger care:

- Do not attempt to charge your headset with anything other than the AC adapter provided. The use of any other types may damage or destroy the headset and could be dangerous. Use of other chargers may invalidate any approval or warranty. For availability of approved enhancements, please check with your dealer.
- Charge the product according to the instructions supplied with the product.

The Bluetooth® word mark and logos are owned by the Bluetooth SIG, Inc. Other trademarks and trade names are those of their respective owners.

FCC:

This device complies with part 15 of the FCC rules. Operation is subject to the following two conditions: (1) This device may not cause harmful interference, and (2) This device must accept any interference.

Any changes or modifications not expressly approved by the party responsible for compliance will void the user's authority to operate the equipment.

Note: This equipment has been tested and found to comply with the limits for a Class B digital device, pursuant to part 15 of the FCC Rules. These limits are designed to provide reasonable protection against harmful interference in a residential installation. This equipment generates uses and can radiate radio frequency energy and, if not installed and used in accordance with the instructions, may cause harmful interference to radio communications. However, there is no guarantee that interference will not occur in a particular installation. If this equipment does cause harmful interference to radio or television reception, which can be determined by turning the equipment off and on, the user is encouraged to try to correct the interference by one or more of the following measures:

- Reorient or relocate the receiving antenna.
- Increase the separation between the equipment and receiver.
- Connect the equipment into an outlet on a circuit different from that to which the receiver is connected.
- Consult the dealer or an experienced radio/TV technician for help.

FCC Radiation Exposure Statement:

This equipment complies with FCC radiation exposure limits set forth for an uncontrolled environment. This transmitter must not be co-located or operating in conjunction with any other antenna or transmitter.

Storage and Maintenance

- Store the headphones in cool and dry place. The working temperatures should be 0–45 °C (32–113°F). Working in cold/hot environment or highly humid area may reduce the life of battery.
- After storage for a long period, please charge the headphones before using again.
- The headphones are water resistant, but are NOT waterproof, please DO NOT submerge the headphones in water.
- Clean the headphones with a soft dry cloth.

COMMON PACKAGE ITEMS

	Part Number	Item	Qty.
1	221126	Bluetooth Headset (ABH-400)	1
2		User Manual	1



Headset



User Manual

Headset View :

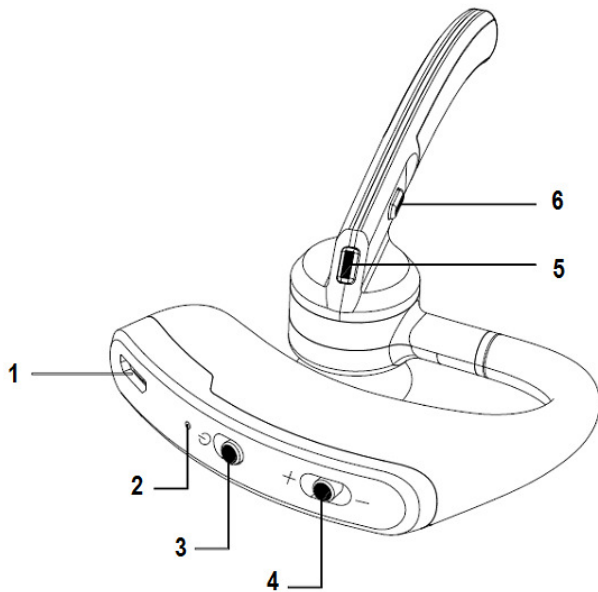

1. Battery charging port
2. LED Indicator
3. Key1: Power switch
4. Key2: Volume adjustment /Music selection
5. Key3: Talk button/ Answer, Reject, Hang up
6. Key4: Language switching/Music Play, Pause

Wearing the Headset :

If you need to wear the headset to your other ear, you can rotation the earplug to the opposite side, and then adjust the microphone pole to a suitable position. See the following figure.

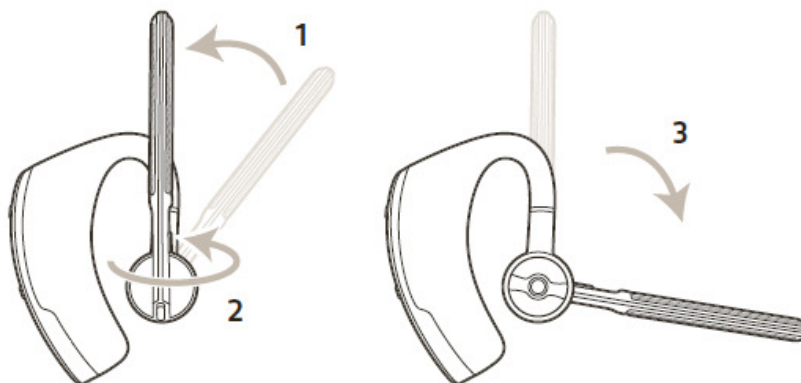

Charging the Bluetooth Headset

The battery must be fully charged before your first use! Charging temperature is 0~40°C.

1. 5V DC /100mA Power supply would be the best choice.
2. Plug the USB cable into the 6 gang charger power port.
3. When charging the headset, the LED indicator shows red. When charging finished, the red turns to blue.
4. To charge the headset at least once a month even you do not use it usually.

ON/OFF

1. Turn on: Push the power switch to  position, the blue light flashes 3times, There will be voice prompt to enter the power-on state.
2. Turn off: Push the power switch to opposite position, the red light flashes once with voice prompt to complete the power off.

Language Switching

Under the standby mode, press key 4 for about 1 second, the voice prompt will be switched from English to Chinese, or Chinese to English.

The Usage of the Bluetooth Headset to the AWR Advantage Two-way Radio



Pairing to the AWR advantage (AWR-4002)

For using the Bluetooth function, you must make your radio to pair your Bluetooth headset firstly. This process only needs to be completed on time with each new device.

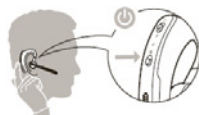
1. To push the power switch to  position, Switch on the blue headset, there will be light flashing with red and blue to entry into pairing mode.





2. Your AWR Advantage radio enters the pairing state.
 - a. Switch on the radio with press and hold "side Key",
 - b. When the LCD display "**LINK ...**", release the side key, then the blue indicator quickly flashes, the radio enter the pairing state.

NOTE: Refer to the Two-way radio user manual for detail.
3. When the pairing is success, the two-way radio LCD will display "**BLUE OK**" for 2 seconds , the  and  will appear on the LCD, then the blue LED will flash once every 3 seconds. In the meantime the Bluetooth headset will issue paired successful prompt voice.
4. Now you can enjoy your radio with your Bluetooth headset.

Connect to the AWR Advantage (AWR-4002)

Once your radio had paired your blue headset, you do not need to pair again when you want to use the Bluetooth operation next time. But you still need to connect your radio with Bluetooth headset.

1. Turn on your Bluetooth headset firstly.
2. Enter the radio menu, select **BLUETOOTH**, then select **LINK**, the LCD will display "**LINK ...**", the radio start to connect the Bluetooth headset
3. When the connecting is success, the two-way radio LCD will display "**BLUE OK**" for 2 seconds, the  and  will appear on the LCD , then the blue LED will flash once every 3 seconds. In the meantime the Bluetooth headset will issue paired successful prompt voice.

4. Now you can enjoy your radio with your Bluetooth headset.

Receive a Call

When the radio receives a call, you will hear the voice in you Bluetooth headset directly.

Adjust the headset volume

1. Slide Key2 to – direction and hold to decrease the volume
2. Slide Key2 to + direction and hold to increase the volume

Make a Call

In standby mode, click the key3 twice to make a call, the radio will enter transmit state. Click Key3 again to end the call. The radio will enter receive mode.

The Usage of the Bluetooth Headset to the mobile

Pairing to 1 device:

1. In the power off state, push the power switch to  position, there will be light flashing with red and blue to entry into pairing mode.

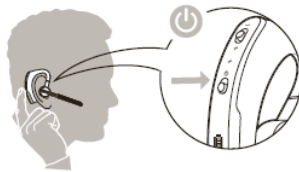

2. Activate the Bluetooth search feature on your phone. Refer to your phone's manual for further instructions
3. The headset will have voice prompt when paired successful, now you can enjoy your Bluetooth headset.

Pairing to 2 devices:

This headset contains a dual-link function for connection with 2 mobile phones simultaneously.

1. Pair the first phone following the steps above.
2. Temporarily disable the first connected phone's Bluetooth function.
3. Pair the second phone using the steps above.
4. Turn off the headset, in the mean time enable the first phone Bluetooth function.
5. Turn on the headset again, it will connect to both devices automatically.

Receive the call

When there is an incoming call, the headset automatically read caller phone number (Required phone support), click key3 to answer the call.

Language Answering

When there is an incoming call, and the headset finished to read the caller phone number, you can say "YES" to answer the call or say "NO" to reject it.

Note: Voice answer or reject a call in a noisy environment may not be realized.

Adjust the headset volume

1. Slide Key2 to – direction and hold to decrease the volume.
2. Slide Key2 to + direction and hold to increase the volume.

Hung up the phone

Click key3 to hung up.

Reject the call

When there is an incoming call, press key3 for 1 second to reject the call.

The last call redialing

In standby mode, to click the key3 twice to redial the last number dialed.

Voice function assist

In standby mode, to click the key3 once to enter into the voice function assist, you can speak to make the phone call, send message. (The function should be supported by your mobile.)

Music control

1. To click the Key4 to play the music
2. During the music playing, click the key4 to stop the music.
3. Quick slide the key 2 to – direction to switch to the previous song.
4. Quick slide the key 2 to + direction to switch to the next song.

#



#

20809 Kensington Blvd., Lakeville, MN 55044-8353

(800) 475-5852 www.advancedwireless.com

©2016 Advanced Wireless Communications. All rights reserved.