

# TIMCO ENGINEERING INC.

849 NW State Road 45  
Newberry, Florida 32669  
<http://www.timcoengr.com>  
888.472.2424 F 352.472.2030 email: [sid@timcoengr.com](mailto:sid@timcoengr.com)

## FCC Test Report

Product Name: RADIO TRANSCEIVER

FCC ID: Q9S02042108V

Applicant:

**ADVANCED WIRELESS COMMUNICATIONS  
20809 KENSINGTON BLVD.  
LAKEVILLE MINNESOTA 55044**

**Date Receipt: APRIL 12, 2004**

**Date Tested: MAY 10, 2004**

**APPLICANT:** ADVANCED WIRELESS COMMUNICATIONS

**FCC ID:** Q9S02042108V

**REPORT #:** A\ADVANCED WIRELESS\_Q9S\505AUT4\505AUT4TestReport.doc

**COVER SHEET**

# TIMCO ENGINEERING INC.

849 NW State Road 45  
Newberry, Florida 32669  
<http://www.timcoengr.com>  
888.472.2424 F 352.472.2030 email: [sid@timcoengr.com](mailto:sid@timcoengr.com)

## TABLE OF CONTENTS LIST

**APPLICANT:** ADVANCED WIRELESS COMMUNICATIONS

**FCC ID:** Q9S02042108V

### TEST REPORT:

PAGE 1.....	GENERAL INFORMATION & TECHNICAL DESCRIPTION
PAGE 2.....	TECHNICAL DESCRIPTION CONTINUED RF POWER OUTPUT
PAGE 3.....	MODULATION CHARACTERISTICS AUDIO FREQUENCY RESPONSE
PAGE 4.....	MODULATION LIMITING PLOT
PAGE 5.....	AUDIO LOW PASS FILTER
PAGE 6-8.....	OCCUPIED BANDWIDTH
PAGE 9.....	SPURIOUS EMISSIONS AT ANTENNA TERMINALS
PAGE 10-11.....	FIELD STRENGTH OF SPURIOUS EMISSIONS
PAGE 12.....	METHOD OF MEASURING RADIATED SPURIOUS EMISSIONS
PAGE 13.....	FREQUENCY STABILITY
PAGE 14-17.....	TRANSIENT FREQUENCY STABILITY
PAGE 18-21.....	EQUIPMENT LIST

### EXHIBITS CONTAINING:

CONFIDENTIALITY LETTER  
BLOCK DIAGRAM  
SCHEMATIC  
PARTS LIST  
USERS MANUAL  
LABEL SAMPLE  
LABEL LOCATION  
EXTERNAL PHOTOGRAPHS  
INTERNAL PHOTOGRAPHS  
TUNING PROCEDURE  
OPERATIONAL DESCRIPTION  
TEST SET UP PHOTOGRAPH

**APPLICANT:** ADVANCED WIRELESS COMMUNICATIONS

**FCC ID:** Q9S02042108V

**REPORT #:** A\ADVANCED WIRELESS\_Q9S\505AUT4\505AUT4TestReport.doc

**TABLE OF CONTENTS**

# TIMCO ENGINEERING INC.

849 NW State Road 45  
Newberry, Florida 32669  
<http://www.timcoengr.com>  
888.472.2424 F 352.472.2030 email: [sid@timcoengr.com](mailto:sid@timcoengr.com)

## GENERAL INFORMATION REQUIRED FOR TYPE ACCEPTANCE

2.1033(c)(1)(2) ADVANCED WIRELESS COMMUNICATIONS will manufacture the FCCID: Q9S02042108V VHF TRANSCEIVER in quantity, for use under FCC RULES PART 90.

ADVANCED WIRELESS COMMUNICATIONS  
20809 KENSINGTON BLVD.  
LAKEVILLE, MINNESOTA 55044

## 2.1033(c) TECHNICAL DESCRIPTION

2.1033(c)(3) Instruction book. A draft copy of the instruction manual is included in the exhibits.

2.1033(c)(4) Type of Emission: 10K2F3E 12.5 kHz  
90.209

Bn = 2M + 2DK  
M = 3000  
D = 2100  
Bn = 2(2100) + 2(3000) = 10.2k

2.1033(c)(4) Type of Emission: 13K8F3E 25 kHz  
90.209

Bn = 2M + 2DK  
M = 3000  
D = 3900  
Bn = 2(3900) + 2(3000) = 13.8k

2.1033(c)(5) Frequency Range: 150 - 174 MHz  
90.209

2.1033(c)(6)(7) Power Output shall not exceed 59 Watts into a 50 ohm  
90.205 resistive load. There are no user power controls.

2.1033(c)(8) DC Voltages and Current into Final Amplifier:  
POWER INPUT:

## FINAL AMPLIFIER ONLY

Vce = 7.2 Volts  
Ice = 1.41 A.

Pin = 10.15 Watts

2.1033(c)(9) Tune-up procedure. The tune-up procedure is included in the exhibits.

**APPLICANT:** ADVANCED WIRELESS COMMUNICATIONS

**FCC ID:** Q9S02042108V

**REPORT #:** A\ADVANCED WIRELESS\_Q9S\505AUT4\505AUT4TestReport.doc

# TIMCO ENGINEERING INC.

849 NW State Road 45  
Newberry, Florida 32669  
<http://www.timcoengr.com>  
888.472.2424 F 352.472.2030 email: [sid@timcoengr.com](mailto:sid@timcoengr.com)

- 2.1033(c)(10) Complete Circuit Diagrams: The circuit diagram and block diagram are included in the exhibits.
- (11) Function of each electron tube or semiconductor device or other active circuit device see the exhibits.
- (12) Description of all circuitry and devices provided for determining and stabilizing frequency is included in the circuit description in the instruction manual.
- 2.1033(c)(13) A photograph or drawing of the equipment identification label is shown in the exhibits.
- 2.1033(c)(14) Photographs of the equipment of sufficient clarity to reveal equipment construction and layout and label location are shown in the exhibits.
- 2.1033(c)(15) Digital Modulation is not allowed.
- 2.1033(c)(16) The data required for 2.1046 through 2.1057 is submitted below.
- 2.1046(a) **RF POWER OUTPUT**  
RF power is measured by connecting a 50-ohm, resistive wattmeter to the RF output connector. The RF output measures:  
  
OUTPUT POWER: 5 Watts CONDUCTED

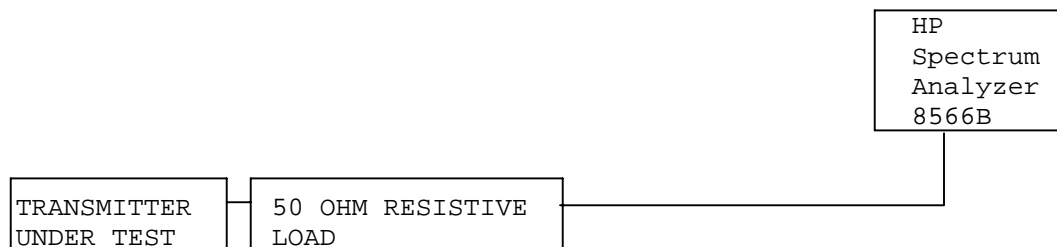

# TIMCO ENGINEERING INC.

849 NW State Road 45  
Newberry, Florida 32669  
<http://www.timcoengr.com>  
888.472.2424 F 352.472.2030 email: [sid@timcoengr.com](mailto:sid@timcoengr.com)

2.1047(a)(b) **Modulation characteristics:**

## **AUDIO FREQUENCY RESPONSE**

The audio frequency response was measured in accordance with TIA/EIA Specification 603. The audio frequency response curve is shown below. The audio signal was fed into a dummy microphone circuit and into the microphone connector. The input required to produce 30 percent modulation level was measured.

## Audio Frequency Response

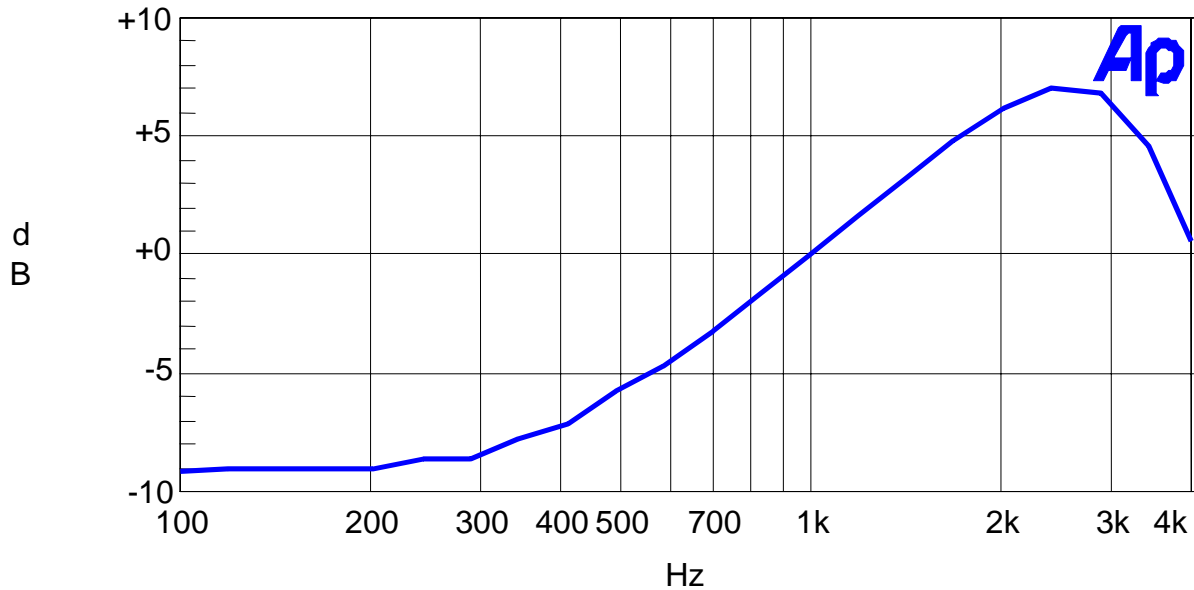

**APPLICANT:** ADVANCED WIRELESS COMMUNICATIONS

**FCC ID:** Q9S02042108V

**REPORT #:** A\ADVANCED WIRELESS\_Q9S\505AUT4\505AUT4TestReport.doc

# TIMCO ENGINEERING INC.

849 NW State Road 45  
Newberry, Florida 32669  
<http://www.timcoengr.com>  
888.472.2424 F 352.472.2030 email: [sid@timcoengr.com](mailto:sid@timcoengr.com)

2.1047(b)

## Audio input versus modulation

The audio input level needed for a particular percentage of modulation was measured in accordance with TIA/EIA Specification 603. The audio input curves versus modulation are shown below. Curves are provided for audio input frequencies of 300, 1000, and 2500 Hz.

### Modulation Limiting Plots:

Green (2.5KHz), Blue (1.0KHz), and Yellow (300Hz)

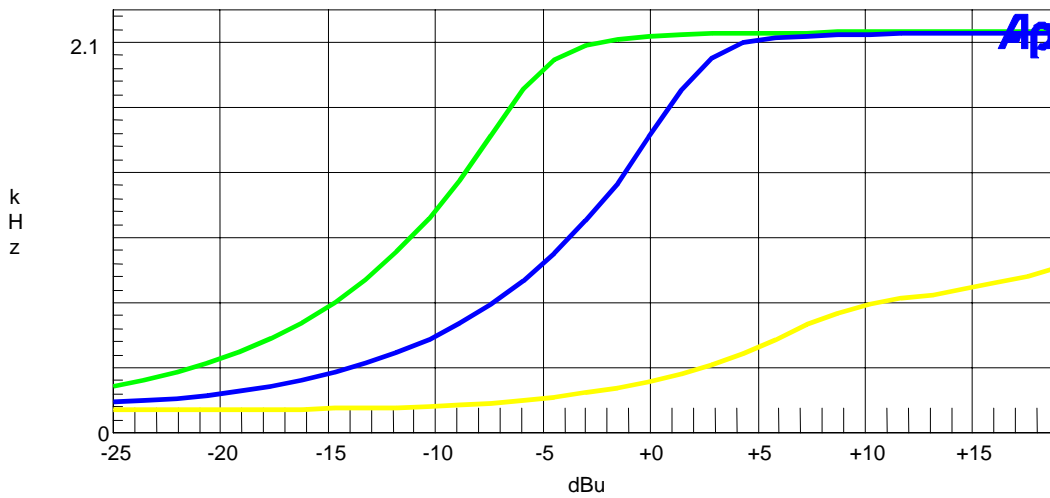

### Modulation Limiting Plots:

2.5 KHz (Green), 1.0 KHz (Blue), and 300 Hz (Yellow)

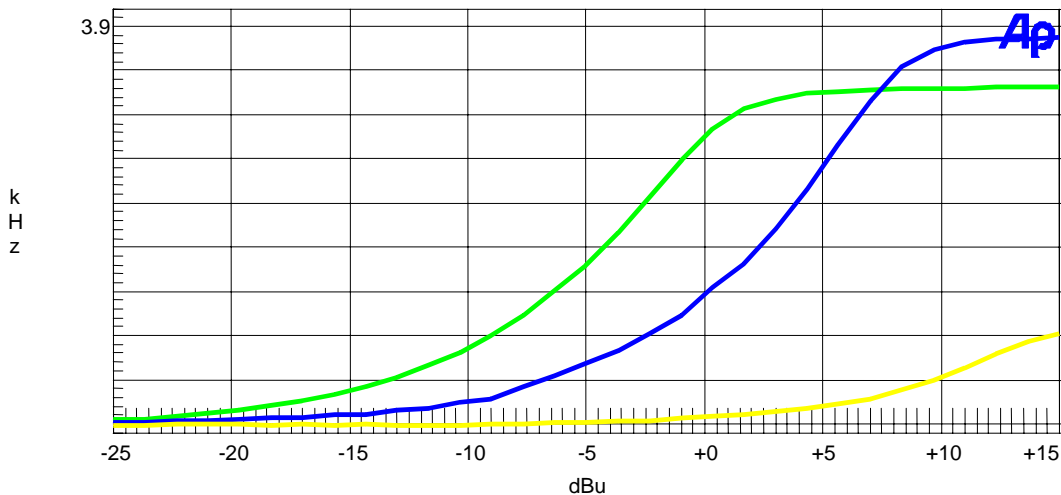

APPLICANT: ADVANCED WIRELESS COMMUNICATIONS

FCC ID: Q9S02042108V

REPORT #: A\ADVANCED WIRELESS\_Q9S\505AUT4\505AUT4TestReport.doc

# TIMCO ENGINEERING INC.

849 NW State Road 45  
Newberry, Florida 32669  
<http://www.timcoengr.com>  
888.472.2424 F 352.472.2030 email: [sid@timcoengr.com](mailto:sid@timcoengr.com)

## Post Limiter Filter

The filter must be between the modulation limiter and the modulated stage. At any frequency between 3 & 20 kHz the filter must have an attenuation of  $60\log(f/3)$  greater than the attenuation at 1kHz. See the plot below.

## Audio Low Pass Filter

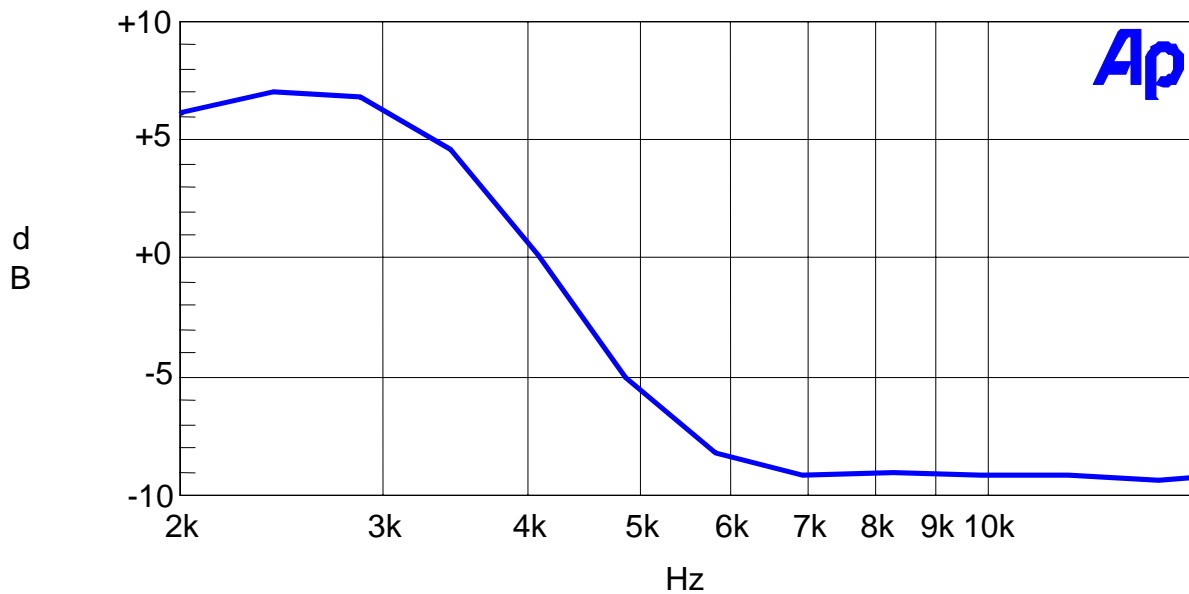

**APPLICANT:** ADVANCED WIRELESS COMMUNICATIONS

**FCC ID:** Q9S02042108V

**REPORT #:** A\ADVANCED WIRELESS\_Q9S\505AUT4\505AUT4TestReport.doc

# TIMCO ENGINEERING INC.

849 NW State Road 45  
Newberry, Florida 32669  
<http://www.timcoengr.com>  
888.472.2424 F 352.472.2030 email: [sid@timcoengr.com](mailto:sid@timcoengr.com)

2.1049(c)  
90.210 (d)

## EMISSION BANDWIDTH:

Emission Mask D - 12.5 kHz channel bandwidth equipment.  
For transmitters designed to operate with a 12.5 kHz channel bandwidth, any emission must be attenuated below the power (P) of the highest emission contained within the authorized bandwidth as follows:

- (1) On any frequency from the center of the authorized bandwidth  $f_0$  to 5.625 kHz removed from  $f_0$ : Zero dB.
- (2) On any frequency from the center of the authorized bandwidth by a displacement frequency ( $f_d$  in kHz) of more than 5.625 kHz but no more than 12.5 kHz: At least  $7.27 (f_d - 2.88 \text{ kHz})$  dB.
- (3) On any frequency removed from the center of the authorized bandwidth by a displacement frequency ( $f_d$  in kHz) of more than 12.5 kHz: At least  $50 + 10\log(P)$  dB or 70 dB, whichever is the lesser attenuation.

90.210(b)

Data in the plots shows that the sidebands from greater than 50% to 100% of the authorized bandwidth must be attenuated by at least 25 dB and from 100 to 250% the sidebands must be attenuated by at least 35 dB. Beyond 250% the sidebands must be attenuated by at least  $43 + \log_{10}(TP)$ . The transmitter was modulated with 2500 Hz, adjusted for 50% modulation plus 16 dB. The spectrum analyzer was set with the un-modulated carrier at the top of the screen. The test procedure diagram follows. See the occupied bandwidth plot on the next page.

### Radiotelephone Transmitter with Modulation Limiter

Test procedure: TIA/EIA-603 para 2.2.11, with the exception that various tones were used.

Test procedure diagram

#### OCCUPIED BANDWIDTH MEASUREMENT

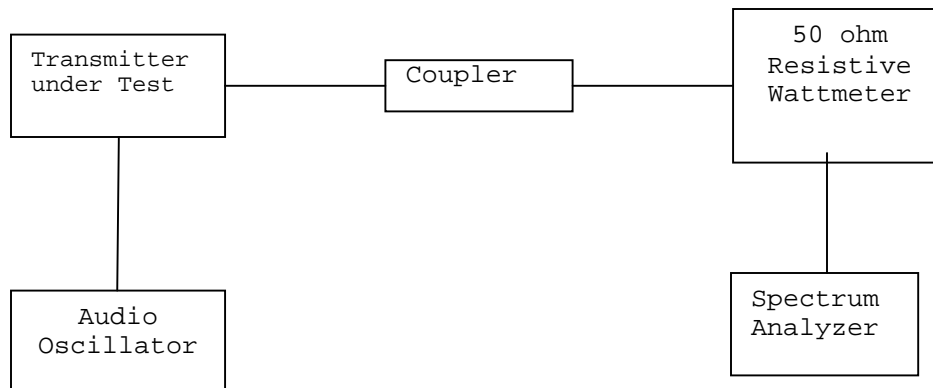

**APPLICANT:** ADVANCED WIRELESS COMMUNICATIONS

**FCC ID:** Q9S02042108V

**REPORT #:** A\ADVANCED WIRELESS\_Q9S\505AUT4\505AUT4TestReport.doc



# TIMCO ENGINEERING INC.

849 NW State Road 45  
Newberry, Florida 32669  
<http://www.timcoengr.com>  
888.472.2424 F 352.472.2030 email: [sid@timcoengr.com](mailto:sid@timcoengr.com)

## OCCUPIED BANDWIDTH PLOT

### NOTES:

ADVANCED WIRELESS COMMUNICATIONS - FCC ID: Q9SAWR2108V  
OCCUPIED BANDWIDTH PLOT

### FCC 90.210 Mask D

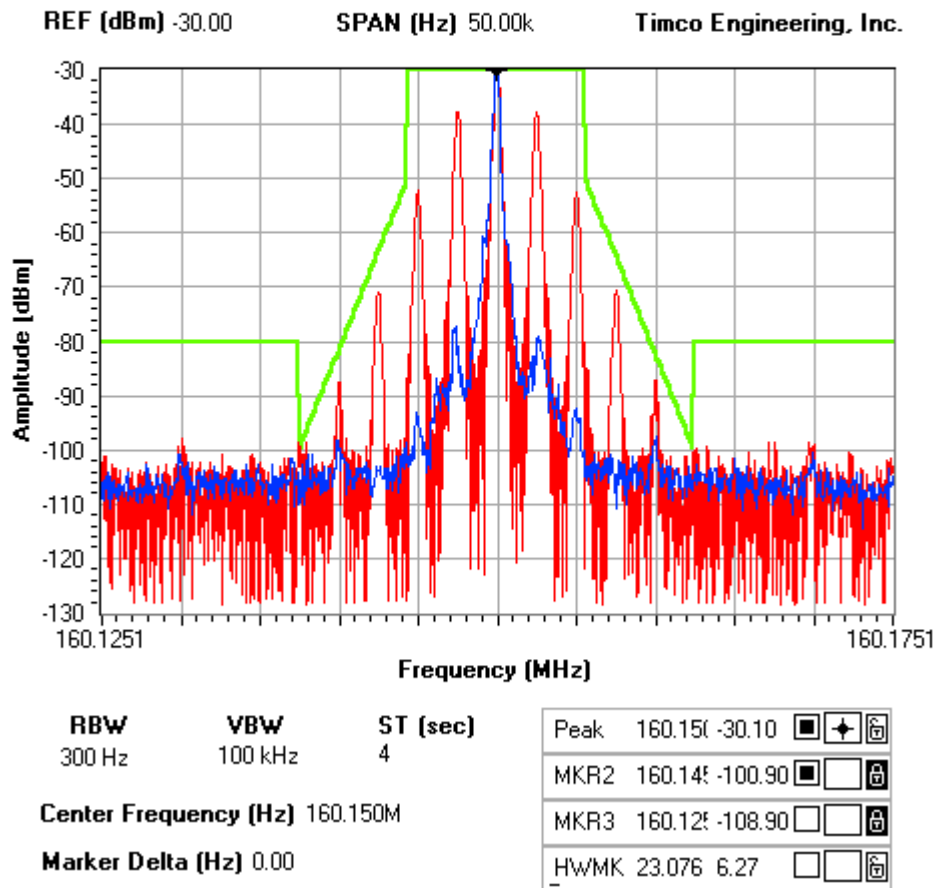

**APPLICANT:** ADVANCED WIRELESS COMMUNICATIONS

**FCC ID:** Q9S02042108V

**REPORT #:** A\ADVANCED WIRELESS\_Q9S\505AUT4\505AUT4TestReport.doc

# TIMCO ENGINEERING INC.

849 NW State Road 45  
 Newberry, Florida 32669  
<http://www.timcoengr.com>  
 888.472.2424 F 352.472.2030 email: [sid@timcoengr.com](mailto:sid@timcoengr.com)

## OCCUPIED BANDWIDTH PLOT

### NOTES:

ADVANCED WIRELESS COMMUNICATIONS - FCC ID: Q9SAWR2108V  
 OCCUPIED BANDWIDTH PLOT. (WIDE BAND)

### FCC 90.210 Mask B

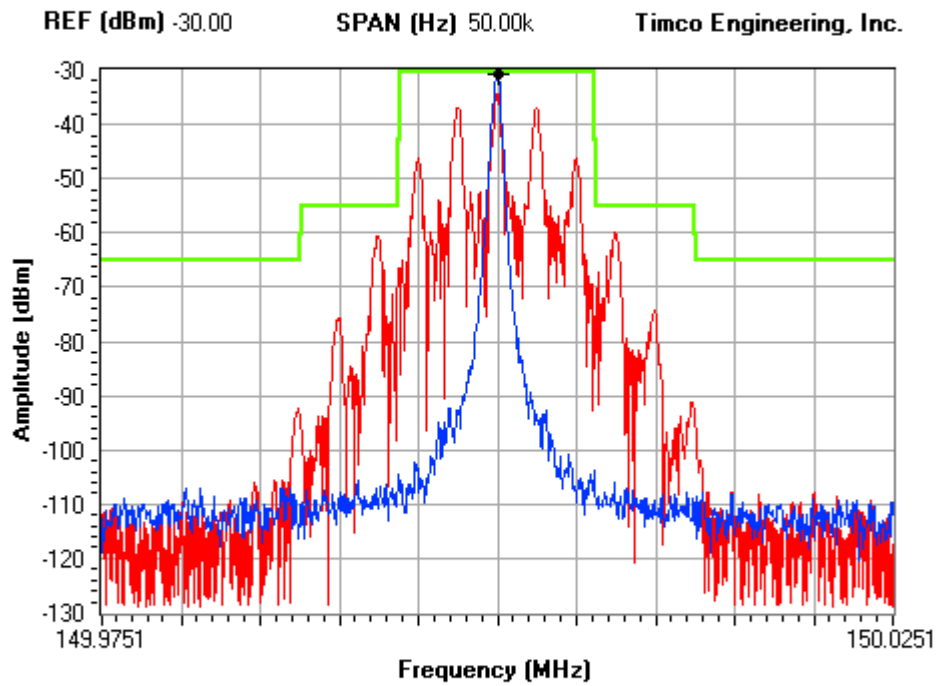

<b>RBW</b>	<b>VBW</b>	<b>ST (sec)</b>	Peak	150.00	-30.70	<input checked="" type="checkbox"/>	<input checked="" type="checkbox"/>	<input checked="" type="checkbox"/>
300 Hz	100 kHz	1	MKR2	149.99	-106.90	<input checked="" type="checkbox"/>	<input type="checkbox"/>	<input type="checkbox"/>
<b>Center Frequency (Hz)</b>	150.000M		MKR3	149.97	-112.60	<input type="checkbox"/>	<input type="checkbox"/>	<input type="checkbox"/>
<b>Marker Delta (Hz)</b>	0.00		HWMK	23.076	6.27	<input type="checkbox"/>	<input type="checkbox"/>	<input type="checkbox"/>

# TIMCO ENGINEERING INC.

849 NW State Road 45  
Newberry, Florida 32669  
<http://www.timcoengr.com>  
888.472.2424 F 352.472.2030 email: [sid@timcoengr.com](mailto:sid@timcoengr.com)

2.1051

## Spurious emissions at antenna terminals (conducted):

Data below shows the level of conducted spurious responses. The carrier was modulated 100% using a 2500 Hz tone. The spectrum was scanned from 0.4 to at least the 10th harmonic of the fundamental. The measurements were made in accordance with standard TIA/EIA-603.

### REQUIREMENTS:

Emissions must be  $50 + 10\log(P_o)$  dB below the mean power output of the transmitter.

$$50 + 10\log(5) = 57.00 \text{ dB}$$

TF	EF	dB below carrier	TF	EF	dB below carrier
160.13	160.2	0.0	173.93	174	0.0
	320.4	64.6		348	61.7
	480.6	59.4		522	76.0
	640.8	67.6		696	89.4
	801.0	68.2		870	77.7
	961.2	79.6		1044	84.5
	1121.4	82.1		1218	91.6
	1281.6	85.3		1392	98.2
	1441.8	81.0		1566	87.0
	1602.0	85.0		1740	89.8

### Method of Measuring Conducted Spurious Emissions

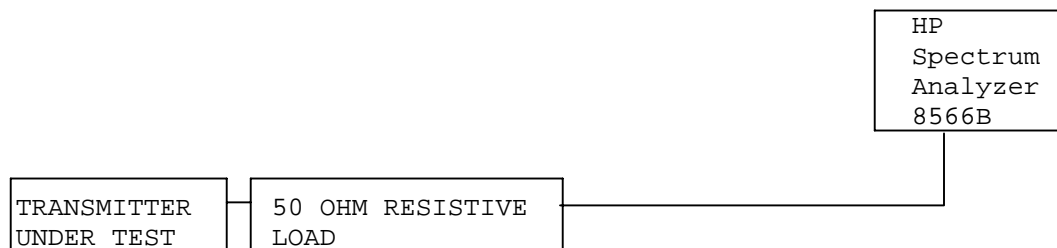

**METHOD OF MEASUREMENT:** The procedure used was TIA/EIA-603 STANDARD without any exceptions. An audio generator was connected to the UUT through a dummy microphone circuit and the output of the transmitter connected to a standard load and from the standard load through a pre-selector filter of the spectrum analyzer. The spectrum was scanned from 400 kHz to at least the tenth harmonic of the fundamental using a HP model 8566B spectrum analyzer. The measurements were made using the shielded room located at TIMCO ENGINEERING INC. 849 N.W. State Road 45, Newberry, Florida 32669.

**APPLICANT:** ADVANCED WIRELESS COMMUNICATIONS

**FCC ID:** Q9S02042108V

**REPORT #:** A\ADVANCED WIRELESS\_Q9S\505AUT4\505AUT4TestReport.doc

# TIMCO ENGINEERING INC.

849 NW State Road 45  
Newberry, Florida 32669  
<http://www.timcoengr.com>  
888.472.2424 F 352.472.2030 email: [sid@timcoengr.com](mailto:sid@timcoengr.com)

**2.1053**                      **Field strength of spurious emissions:**

**NAME OF TEST:**            RADIATED SPURIOUS EMISSIONS (CHANNEL 1)

**REQUIREMENTS:**        Emissions must be  $50 + 10\log(P_o)$  dB below the mean power output of the transmitter.

$$50 + 10\log(5) = 57.00 \text{ dB}$$

**TEST DATA:**

Emission Frequency MHz	Ant. Polarity	Corrected EUT Signal Reading	Coax Loss (dB)	Substitution Antenna (dBd)	dB Below Carrier (dBc)
160.20	H	36.40	0	0	0
320.40	H	-31.90	0	-1.25	69.55
480.60	H	-38.90	0	-0.57	75.87
640.80	H	-45.90	0	-0.19	82.49
801.00	V	-41.70	0	-1.35	79.45
961.20	H	-39.80	0	-1.27	77.47
1121.40	V	-44.40	1.02	3.43	78.39
1281.60	V	-37.10	1.06	4.07	70.49
1441.80	H	-26.50	1.09	4.71	59.28
1602.00	V	-30.70	1.22	5.01	63.31

**APPLICANT:** ADVANCED WIRELESS COMMUNICATIONS

**FCC ID:** Q9S02042108V

**REPORT #:** A\ADVANCED WIRELESS\_Q9S\505AUT4\505AUT4TestReport.doc

# TIMCO ENGINEERING INC.

849 NW State Road 45  
Newberry, Florida 32669  
<http://www.timcoengr.com>  
888.472.2424 F 352.472.2030 email: [sid@timcoengr.com](mailto:sid@timcoengr.com)

**2.1053**                      **Field strength of spurious emissions:**

**NAME OF TEST:**              RADIATED SPURIOUS EMISSIONS (CHANNEL 3)

**REQUIREMENTS:**          Emissions must be  $50 + 10\log(P_o)$  dB below the mean power output of the transmitter.

$$50 + 10\log(5) = 57.00 \text{ dB}$$

**TEST DATA:**

Emission Frequency MHz	Ant. Polarity	Corrected EUT Signal Reading	Coax Loss (dB)	Substitution Antenna (dBd)	dB Below Carrier (dBc)
174.00	V	36.40	0	0	0
348.00	V	-36.90	0	-1.15	74.45
522.00	H	-31.40	0	-0.56	68.36
696.00	V	-48.10	0	0.13	84.37
870.00	V	-45.10	0	-0.79	82.29
1044.00	H	-54.10	1.01	3.13	88.38
1218.00	V	-42.10	1.04	3.82	75.72
1392.00	H	-34.10	1.08	4.52	67.06
1566.00	H	-38.90	1.11	4.99	71.42
1740.00	V	-37.30	1.15	5.09	69.76

**APPLICANT:** ADVANCED WIRELESS COMMUNICATIONS

**FCC ID:** Q9S02042108V

**REPORT #:** A\ADVANCED WIRELESS\_Q9S\505AUT4\505AUT4TestReport.doc

# TIMCO ENGINEERING INC.

849 NW State Road 45  
Newberry, Florida 32669  
<http://www.timcoengr.com>  
888.472.2424 F 352.472.2030 email: [sid@timcoengr.com](mailto:sid@timcoengr.com)

## Method of Measuring Radiated Spurious Emissions

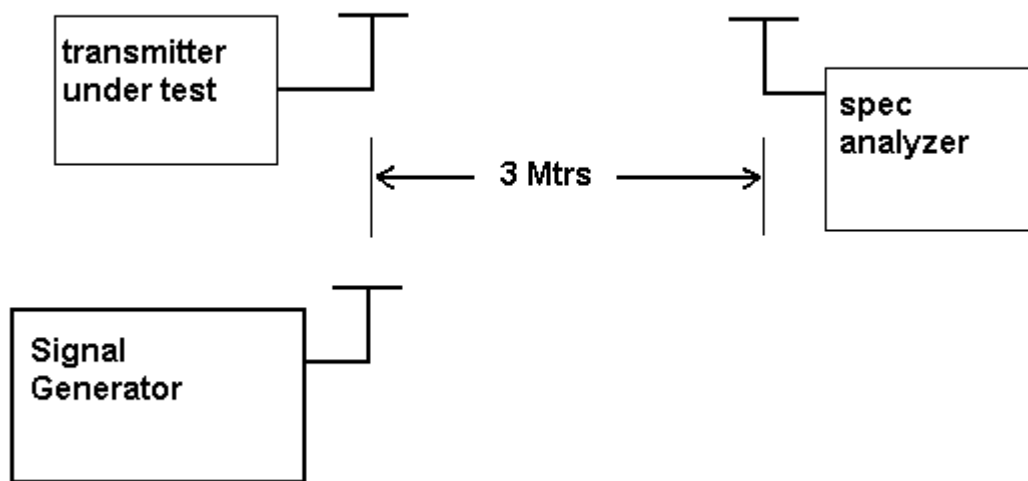

**METHOD OF MEASUREMENTS:** The tabulated data shows the results of the radiated field strength emissions test. The spectrum was scanned from 30 MHz to at least the tenth harmonic of the fundamental. This test was conducted per TIA/EIA STANDARD 603 using the substitution method. Measurements were made at the open field test site of TIMCO ENGINEERING, INC. located at 849 NW State Road 45, Newberry, FL 32669.

**APPLICANT:** ADVANCED WIRELESS COMMUNICATIONS

**FCC ID:** Q9S02042108V

**REPORT #:** A\ADVANCED WIRELESS\_Q9S\505AUT4\505AUT4TestReport.doc

**Page 12 of 21**

# TIMCO ENGINEERING INC.

849 NW State Road 45  
Newberry, Florida 32669  
<http://www.timcoengr.com>  
888.472.2424 F 352.472.2030 email: [sid@timcoengr.com](mailto:sid@timcoengr.com)

2.1055 **Frequency stability:**  
90.213(a)(1)

Temperature and voltage tests were performed to verify that the frequency remains within the .0005%, 5-ppm specification limit. The EUT was placed in the temperature chamber at 25° C and allowed to stabilize for one hour. The transmitter was keyed ON for one minute during which four frequency readings were recorded at 15-second intervals. The worse case number was taken for temperature plotting. The assigned channel frequency was considered to be the reference frequency. The temperature was then reduced to -30° C after which the transmitter was again allowed to stabilize for one hour. The transmitter was keyed ON for one minute, and again frequency readings were noted at 15-second intervals. The worst-case number was recorded for temperature plotting. This procedure was repeated in 10 degree increments up to + 50° C.

Readings were also taken at minus 15% of the battery voltage of 7.2 VDC, which we estimate to be the battery endpoint.

## MEASUREMENT DATA:

Assigned Frequency (Ref. Frequency): 160.150 107 MHz

<u>TEMPERATURE °C</u>	<u>FREQUENCY MHz</u>	<u>PPM</u>
REFERENCE_____	160.150 107	0.00
-30_____	160.150 361	+ 1.59
-20_____	160.150 337	+ 1.44
-10_____	160.150 257	+ 0.94
0_____	160.150 195	+ 0.55
+10_____	160.150 159	+ 0.32
+20_____	160.150 130	+ 0.14
+30_____	160.150 105	- 0.01
+40_____	160.150 076	- 0.19
+50_____	160.150 061	- 0.29

<u>BATT</u>	<u>%BATT. DATA</u>	<u>VOLTS</u>	<u>BATT. PPM</u>
-15%	160.150 128	6.12	0.13

**RESULTS OF MEASUREMENTS:** The test results indicates that the EUT meets the requirements.

# TIMCO ENGINEERING INC.

849 NW State Road 45  
 Newberry, Florida 32669  
<http://www.timcoengr.com>  
 888.472.2424 F 352.472.2030 email: [sid@timcoengr.com](mailto:sid@timcoengr.com)

2.1055(a)(1) Frequency stability:  
 90.214 Transient Frequency Behavior

**REQUIREMENTS:** Transmitters designed to operate in the 150-174 MHz and 421-512 MHz frequency bands must maintain transient frequencies within the maximum transient frequencies within the maximum frequency difference limits during the time intervals indicated:

Time Intervals	Maximum frequency difference	All Equipment	
		150-174 MHz	421-512 MHz

Transient Frequency Behavior for Equipment Designed to Operate on 25 kHz Channels

$t_1^4$	±25.0 kHz	5.0 mS	10.0 mS
$t_2$	±12.5 kHz	20.0 mS	25.0 mS
$t_3^4$	±25.0 kHz	5.0 mS	10.0 mS

Transient Frequency Behavior for Equipment Designed to Operate on 12.5 kHz Channels

$t_1^4$	±12.5 kHz	5.0 mS	10.0 mS
$t_2$	±6.25 kHz	20.0 mS	25.0 mS
$t_3^4$	±12.5 kHz	5.0 mS	10.0 mS

Transient Frequency Behavior for Equipment Designed to Operate on 6.25 kHz Channels

$t_1^4$	±6.25 kHz	5.0 mS	10.0 mS
$t_2$	±3.125 kHz	20.0 mS	25.0 mS
$t_3^4$	±6.25 kHz	5.0 mS	10.0 mS

**APPLICANT:** ADVANCED WIRELESS COMMUNICATIONS

**FCC ID:** Q9S02042108V

**REPORT #:** A\ADVANCED WIRELESS\_Q9S\505AUT4\505AUT4TestReport.doc



# TIMCO ENGINEERING INC.

849 NW State Road 45

Newberry, Florida 32669

<http://www.timcoengr.com>

888.472.2424 F 352.472.2030 email: [sid@timcoengr.com](mailto:sid@timcoengr.com)

**TEST PROCEEDURE:** TIA/EIA TS603 PARA 2.2.19, the levels were set as follows;

1. Using the variable attenuator the transmitter level was set to 40 dB below the test receivers maximum input level, then the transmitter was turned off.
2. With the transmitter off the signal generator was set 20dB below the level of the transmitter in the above step, this level will be maintained with the signal generator through-out the test.
3. Reduce the attenuation between the transmitter and the RF detector by 30 dB.
4. With the levels set as above the transient frequency behavior was observed & recorded.

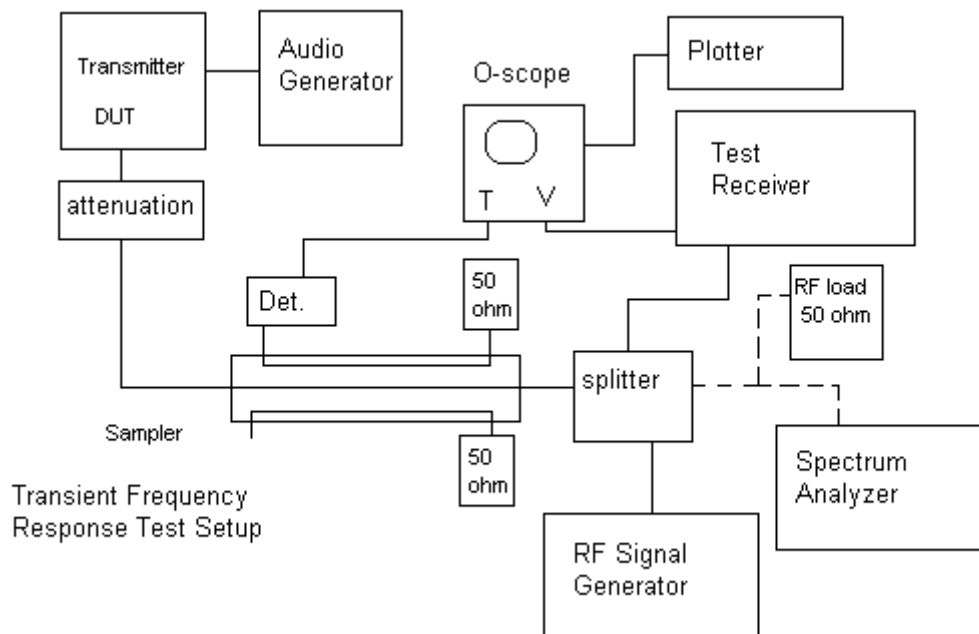

**APPLICANT:** ADVANCED WIRELESS COMMUNICATIONS

**FCC ID:** Q9S02042108V

**REPORT #:** A\ADVANCED WIRELESS\_Q9S\505AUT4\505AUT4TestReport.doc

**Page 15 of 21**

# TIMCO ENGINEERING INC.

849 NW State Road 45

Newberry, Florida 32669

<http://www.timcoengr.com>

888.472.2424 F 352.472.2030 email: [sid@timcoengr.com](mailto:sid@timcoengr.com)

## TRANSIENT FREQUENCY RESPONSE 12.5 kHz

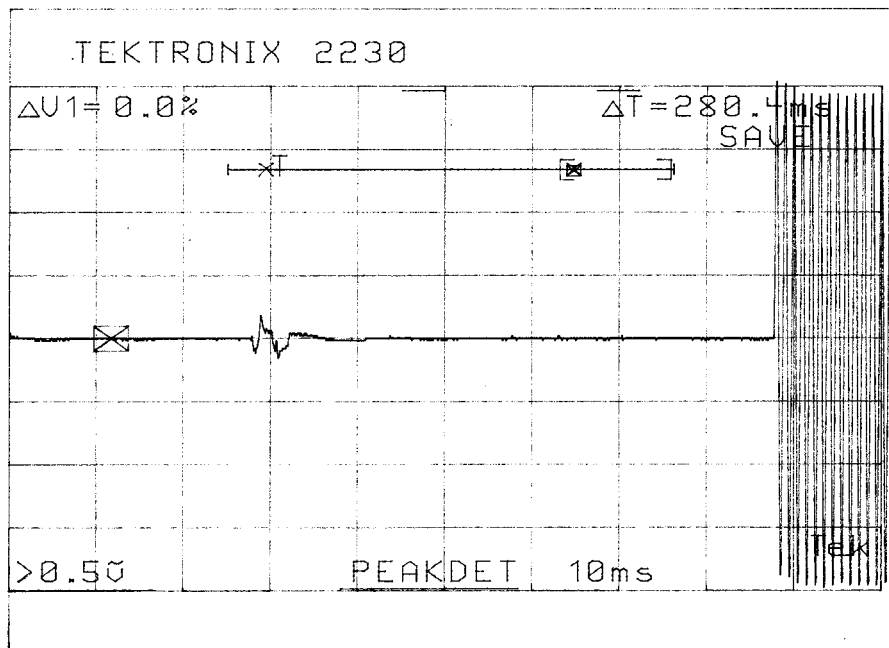
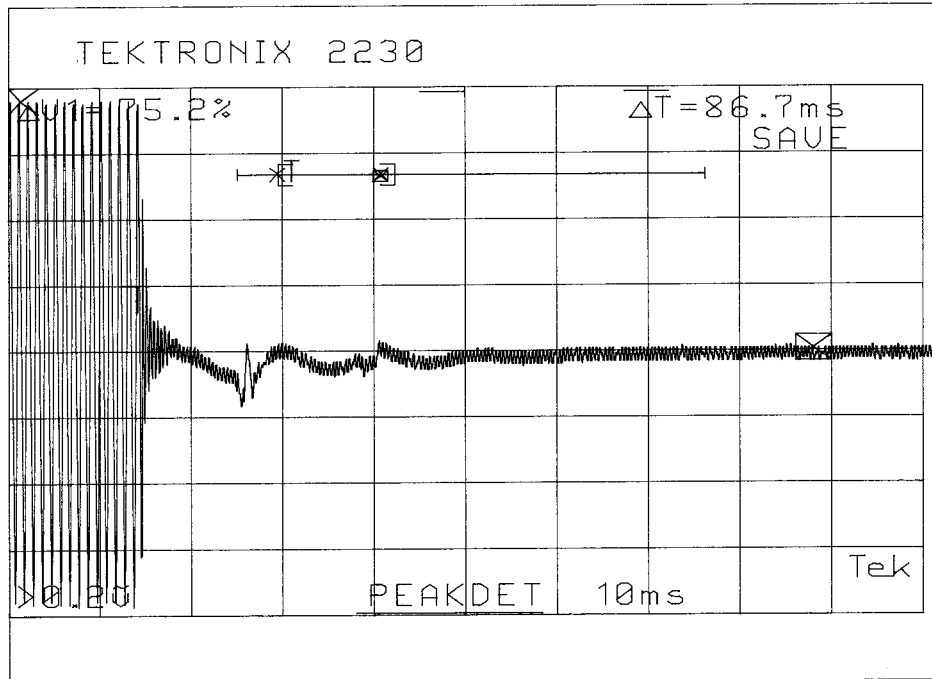

APPLICANT: ADVANCED WIRELESS COMMUNICATIONS

FCC ID: Q9S02042108V

REPORT #: A\ADVANCED WIRELESS\_Q9S\505AUT4\505AUT4TestReport.doc

Page 16 of 21

# TIMCO ENGINEERING INC.

849 NW State Road 45

Newberry, Florida 32669

<http://www.timcoengr.com>

888.472.2424 F 352.472.2030 email: [sid@timcoengr.com](mailto:sid@timcoengr.com)

## TRANSIENT FREQUENCY RESPONSE 25 kHz

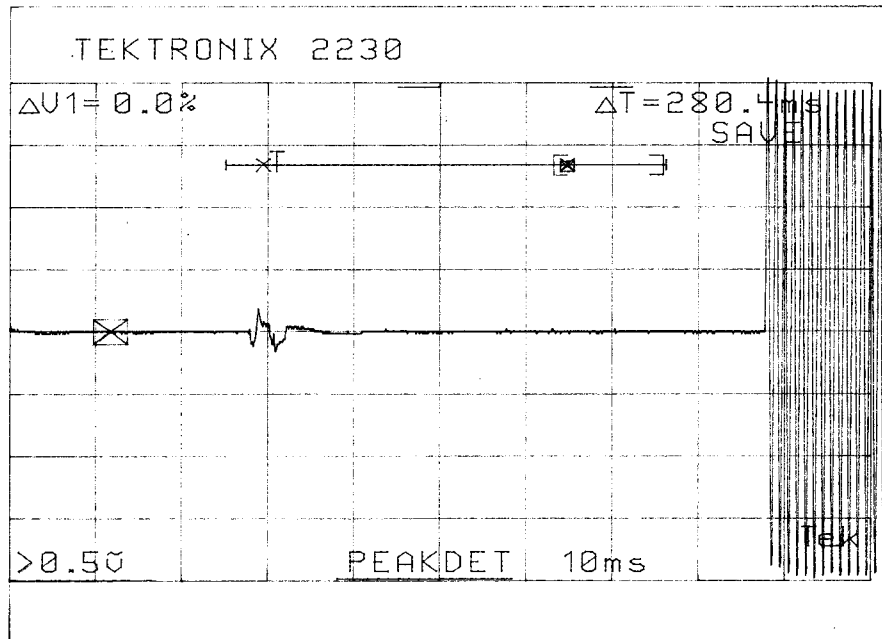
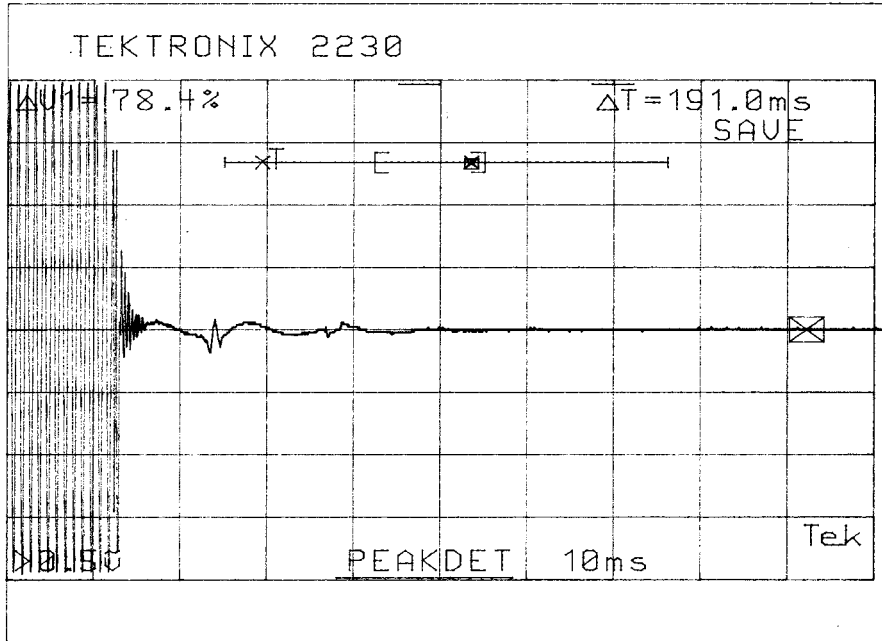

APPLICANT: ADVANCED WIRELESS COMMUNICATIONS

FCC ID: Q9S02042108V

REPORT #: A\ADVANCED WIRELESS\_Q9S\505AUT4\505AUT4TestReport.doc

# TIMCO ENGINEERING INC.

849 NW State Road 45  
 Newberry, Florida 32669  
<http://www.timcoengr.com>  
 888.472.2424 F 352.472.2030 email: [sid@timcoengr.com](mailto:sid@timcoengr.com)

## EMC Equipment List

	DEVICE	MFGR	MODEL	SERNO	CAL/CHAR DATE	DUE DATE or STATUS
X	3-Meter OATS	TEI	N/A	N/A	Listed 1/13/03	1/13/06
	3/10-Meter OATS	TEI	N/A	N/A	Listed 3/26/01	3/26/04
	Receiver, Beige Tower Spectrum Analyzer	HP	8566B Opt 462	3138A07786 3144A20661	CAL 8/31/01	8/31/03
	RF Preselector	HP	85685A	3221A01400	CAL 8/31/01	8/31/03
	Quasi-Peak Adapter	HP	85650A	3303A01690	CAL 8/31/01	8/31/03
X	Receiver, Blue Tower Spectrum Analyzer	HP	8568B	2928A04729 2848A18049	CAL 4/15/03	4/15/05
X	RF Preselector	HP	85685A	2926A00983	CAL 4/15/03	4/15/05
X	Quasi-Peak Adapter	HP	85650A	2811A01279	CAL 4/15/03	4/15/05
	Receiver, Silver/Grey Tower Spectrum Analyzer	HP	8566B Opt 462	3552A22064 3638A08608	CAL 10/14/02	10/14/04
	RF Preselector	HP	85685A	2620A00294	CAL 10/14/02	10/14/04
	Quasi-Peak Adapter	HP	85650A	3303A01844	CAL 10/14/02	10/14/04
	Preamplifier	HP	8449B	3008A01075	CHAR 1/28/02	1/28/04
X	Biconnical Antenna	Electro-Metrics	BIA-25	1171	CAL 4/26/01	4/26/03
	Biconnical Antenna	Eaton	94455-1	1096	CAL 10/1/01	10/1/03
	Biconnical Antenna	Eaton	94455-1	1057	CAL 3/18/03	3/18/05
	BiconiLog Antenna	EMCO	3143	9409-1043		
X	Log-Periodic Antenna	Electro-Metrics	LPA-25	1122	CAL 10/2/01	10/2/03
	Log-Periodic Antenna	Electro-Metrics	EM-6950	632	CHAR 10/15/01	10/15/03
	Log-Periodic Antenna	Electro-Metrics	LPA-30	409	CAL 3/4/03	3/4/05

**APPLICANT:** ADVANCED WIRELESS COMMUNICATIONS

**FCC ID:** Q9S02042108V

**REPORT #:** A\ADVANCED WIRELESS\_Q9S\505AUT4\505AUT4TestReport.doc

# TIMCO ENGINEERING INC.

849 NW State Road 45

Newberry, Florida 32669

<http://www.timcoengr.com>

888.472.2424 F 352.472.2030 email: [sid@timcoengr.com](mailto:sid@timcoengr.com)

DEVICE	MFGR	MODEL	SERNO	CAL/CHAR DATE	DUE DATE or STATUS
Dipole Antenna Kit	Electro-Metrics	TDA-30/1-4	152	CAL 3/21/01	3/21/04
Dipole Antenna Kit	Electro-Metrics	TDA-30/1-4	153	CAL 9/26/02	9/26/05
Double-Ridged Horn Antenna	Electro-Metrics	RGA-180	2319	CAL 2/17/03	2/17/05
Horn Antenna	Electro-Metrics	EM-6961	6246	CAL 3/31/03	3/31/05
Horn Antenna	ATM	19-443-6R	None	No Cal Required	
Passive Loop Antenna	EMC Test Systems	EMCO 6512	9706-1211	CHAR 7/10/01	7/10/03
Line Impedance Stabilization . . .	Electro-Metrics	ANS-25/2	2604	CAL 10/9/01	10/9/03
Line Impedance Stabilization . . .	Electro-Metrics	EM-7820	2682	CAL 3/12/03	3/12/05
Termaline Wattmeter	Bird Electronic Corporation	611	16405	CAL 5/25/99	5/25/01
Termaline Wattmeter	Bird Electronic Corporation	6104	1926	CHAR 12/12/01	12/12/03
Oscilloscope	Tektronix	2230	300572	CHAR 2/1/01	2/1/03
System One	Audio Precision	System One	SYS1-45868	CHAR 4/25/02	4/25/04
Temperature Chamber	Tenney Engineering	TTRC	11717-7	CHAR 1/22/02	1/22/04
AC Voltmeter	HP	400FL	2213A14499	CAL 10/9/01	10/9/03
AC Voltmeter	HP	400FL	2213A14261	CHAR 10/15/01	10/15/03
AC Voltmeter	HP	400FL	2213A14728	CHAR 10/15/01	10/15/03
X Digital Multimeter	Fluke	77	35053830	CHAR 1/8/02	1/8/04
Digital Multimeter	Fluke	77	43850817	CHAR 1/8/02	1/8/04
Digital Multimeter	HP	E2377A	2927J05849	CHAR 1/8/02	1/8/04
Multimeter	Fluke	FLUKE-77-3	79510405	CHAR 9/26/01	9/26/03
Peak Power Meter	HP	8900C	2131A00545	CHAR 1/26/01	1/26/03
Power Meter	HP	432A	1141A07655	CAL 4/15/03	4/15/05

**APPLICANT:** ADVANCED WIRELESS COMMUNICATIONS

**FCC ID:** Q9S02042108V

**REPORT #:** A\ADVANCED WIRELESS\_Q9S\505AUT4\505AUT4TestReport.doc

# TIMCO ENGINEERING INC.

849 NW State Road 45  
 Newberry, Florida 32669  
<http://www.timcoengr.com>  
 888.472.2424 F 352.472.2030 email: [sid@timcoengr.com](mailto:sid@timcoengr.com)

	DEVICE	MFGR	MODEL	SERNO	CAL/CHAR DATE	DUE DATE or STATUS
	Power Meter And Sensor	Bird	4421-107 4022	0166 0218	CAL 4/16/03	4/16/05
	Power Sensor	HP	478A	72129	CAL 4/15/03	4/15/05
	Digital Thermometer	Fluke	2166A	42032	CAL 1/16/02	1/16/04
	Thermometer	Traulsen	SK-128		CHAR 1/22/02	1/22/04
	Thermometer	Extech	4028	14871-2	CAL 3/7/03	3/7/05
X	Hygro-Thermometer	Extech	445703	0602	CAL 10/4/02	10/4/04
	Frequency Counter	HP	5352B	2632A00165	CAL 11/28/01	11/28/03
	Frequency Counter	HP	5385A	2730A03025	CAL 3/7/03	3/7/05
	Power Sensor	Agilent Technologies	84811A	2551A02705	CHAR 1/26/01	1/26/03
	Service Monitor	IFR	FM/AM 500A	5182	CAL 11/22/00	11/22/02
	Comm. Serv. Monitor	IFR	FM/AM 1200S	6593	CAL 5/12/02	5/12/04
	Signal Generator	HP	8640B	2308A21464	CAL 2/15/02	2/15/04
	Sweep Generator	Wiltron	6648	101009	CAL 4/15/03	4/15/05
	Sweep Generator	Wiltron	6669M	007005	CAL 3/3/03	3/3/05
	Modulation Analyzer	HP	8901A	3435A06868	CAL 9/5/01	9/5/03
	Modulation Meter	Boonton	8220	10901AB	CAL 4/15/03	4/15/05
	Near Field Probe	HP	HP11940A	2650A02748	CHAR 2/1/01	2/1/03
	BandReject Filter	Lorch Microwave	5BR4-2400/ 60-N	Z1	CHAR 3/2/01	3/2/03
	BandReject Filter	Lorch Microwave	6BR6-2442/ 300-N	Z1	CHAR 3/2/01	3/2/03
	BandReject Filter	Lorch Microwave	5BR4-10525/ 900-S	Z1	CHAR 3/2/01	3/2/03
	High Pass Filter	Microlab	HA-10N		CHAR 10/4/01	10/4/03
	High Pass Filter	Microlab	HA-20N		CHAR 2/7/03	2/7/05

**APPLICANT:** ADVANCED WIRELESS COMMUNICATIONS

**FCC ID:** Q9S02042108V

**REPORT #:** A\ADVANCED WIRELESS\_Q9S\505AUT4\505AUT4TestReport.doc

# TIMCO ENGINEERING INC.

849 NW State Road 45

Newberry, Florida 32669

<http://www.timcoengr.com>

888.472.2424 F 352.472.2030 email: [sid@timcoengr.com](mailto:sid@timcoengr.com)

DEVICE	MFGR	MODEL	SERNO	CAL/CHAR DATE	DUE DATE or STATUS
Audio Oscillator	HP	653A	832-00260	CHAR 3/1/01	3/1/03
Frequency Counter	HP	5382A	1620A03535	CHAR 3/2/01	3/2/03
Frequency Counter	HP	5385A	3242A07460	CAL 3/7/03	3/7/05
Preamplifier	HP	8449B-H02	3008A00372	CHAR 3/4/01	3/4/03
Amplifier	HP	11975A	2738A01969	CHAR 3/1/01	3/1/03
Egg Timer	Unk			CHAR 8/31/01	8/31/03
Measuring Tape, 20M	Kraftixx	0631-20		CHAR 2/1/02	2/1/04
Measuring Tape, 7.5M	Kraftixx	7.5M PROF1		2/1/02	2/1/04
Coaxial Cable #51	Insulated Wire Inc.	NPS 2251-2880	Timco #51	CHAR 1/23/02	1/23/04
Coaxial Cable #64	Semflex Inc.	60637	Timco #64	CHAR 1/24/02	1/24/04
Coaxial Cable #65	General Cable Co.	E9917 RG233/U	Timco #65	CHAR 1/23/02	1/23/04
Coaxial Cable #106	Unknown	Unknown	Timco #106	CHAR 1/23/02	1/23/04

**APPLICANT:** ADVANCED WIRELESS COMMUNICATIONS

**FCC ID:** Q9S02042108V

**REPORT #:** A\ADVANCED WIRELESS\_Q9S\505AUT4\505AUT4TestReport.doc