

THANK YOU!

We are grateful for your purchase of Advanced Wireless Communications product. We believe this easy-to-use radio will provide you with dependable and reliable communications. This Advanced Wireless Communications portable two-way radio is a precision device. Treat it with care, and you will enjoy years of reliable operation.

■ MODELS COVERED IN THIS MANUAL

AWR2108V: VHF 150-174MHz

Product Safety and RF Exposure for Portable Two-Way Radios Compliance with RF Energy Exposure Standards

NOTICE: This radio is intended for use in occupational/controlled applications where users have been made aware of the potential for exposure and can exercise control over their exposure. This radio device is **NOT** authorized for general population, consumer or similar use.

BEFORE USING THIS RADIO, READ THE TRAINING MATERIAL BELOW WHICH CONTAINS IMPORTANT OPERATING INSTRUCTIONS FOR SAFE USAGE AND RF ENERGY AWARENESS AND CONTROL INFORMATION FOR COMPLIANCE WITH RF ENERGY EXPOSURE LIMITS IN APPLICABLE NATIONAL AND INTERNATIONAL STANDARDS.

Federal Communication Commission (FCC) Regulations

The FCC has established limits for safe exposure to radio frequency (RF) emissions from portable two-way radios. The FCC requires manufacturers to demonstrate compliance with RF exposure limits before portable two-way radios can be marketed in the U.S. When two-way radios are approved for occupational/controlled environment exposure limits, the FCC requires users to be fully aware of, and exercise control over, their exposure. Awareness and control of RF exposure can be accomplished by the use of labels, or by education and training through appropriate means, such as information and instructions in user manuals or safety booklets. Your Advanced Wireless two-way radio has an RF exposure information label in the battery compartment. The training material below includes useful information about RF exposure and helpful instructions on how to control your RF exposure.

Your Advanced Wireless two-way radio is designed and tested to comply with a number of national and international standards and guidelines (listed below) regarding human exposure to RF electromagnetic energy. In terms of measuring RF energy for compliance with FCC exposure guidelines, your radio radiates measurable RF energy only while it is transmitting (during talking), not when it is receiving (listening) or in standby mode.

Compliance and Control Guidelines and Operating Instructions for Portable Two-Way Radios

To control your exposure and ensure compliance with the occupational/controlled environment exposure limits, always adhere to the following procedures:

- * Transmit no more than 50% of the time. To transmit (talk), push the Push-To-Talk (PTT) button. To receive calls, release the PTT button. Transmitting 50% of the time or less is important since the radio generates measurable RF energy exposure only when transmitting (in terms of measuring standards compliance).

- * Hold the radio in a vertical position in front of the face with the microphone positioned at least one inch (2.5 cm) away from the lips. Keeping the radio at the proper distance is important since RF exposure decreases with increasing distance from the antenna.

- * For body-worn operation, always use the radio with the AWC Belt-Clip Part No.: 420855203393. AWC-approved accessories, antennas, and device combinations have been tested and comply with the occupational/controlled environment RF exposure limits. The use of non-AWC approved accessories may result in exposure levels that may exceed the FCC's occupational/controlled environment RF exposure limits.

FCC license Information

Your Advanced Wireless Communications radio operates on communications frequencies that are subject to FCC (Federal Communications Commission) Rules & Regulations. FCC Rules require that all operators using Private Land Mobile radio frequencies obtain a radio license before operating their equipment. Application for license must be made on FCC form 601, and schedules D, E, and G.

FAX: Forms can be obtained by fax from the FCC Fax-On-Demand system. Call 1-202-418-0177 from your fax machine and request document number 000600 for the form, schedules, and instructions.

MAIL: Forms can be ordered by telephone, and will be sent to you by first class mail. Call the FCC Forms Hotline at 1-800-418-FORM (1-800-418-3676).

INTERNET: Form 601 and instructions can be downloaded from the FCC Forms website at:

<http://www.fcc.gov/Forms/Form601/601.html>

Before filling out your Form 601 application Technical Data section, you must decide which frequency (or frequencies) you will operate on. Refer to the frequency chart on page 26.

Questions? Call the FCC for license application questions at 1-888-CALL-FCC (1-888-225-5322).

If you have any questions, call Advanced Wireless Communications:
1-800-475-5852

Notices to The User

This device complies with Part 15 of the FCC Rules. Operation is subject to the following two conditions:

- (1) this device may not cause harmful interference, and
- (2) this device must accept any interference received, including interference that may cause undesired operation.

One or more of the following statements may be applicable:

FCC WARNING

This equipment generates or uses radio frequency energy. Changes or modifications to this equipment may cause harmful interference unless the modifications are expressly approved in the instruction manual. The user could lose the authority to operate this equipment if an unauthorized change or modification is made.

INFORMATION TO THE DIGITAL DEVICE USER REQUIRED BY THE FCC

This equipment has been tested and found to comply with the limits for a Class B digital device, pursuant to Part 15 of the FCC Rules. These limits are designed to provide reasonable protection against harmful interference in a residential installation. This equipment generates, uses and can generate radio frequency energy and, if not installed and used in accordance with the instructions, may cause harmful interference to radio communications. However, there is no guarantee that the interference will not occur in a particular installation. If this equipment does cause harmful interference to radio or television reception, which can be determined by turning the equipment off and on, the user is encouraged to try to correct the interference by one or more of the following measures:

- Reorient or relocate the receiving antenna.
- Increase the separation between the equipment and receiver.
- Connect the equipment to an outlet on a circuit different from that to which the receiver is connected.
- Consult the dealer for technical assistance.

SAFETY INFORMATION:

Your wireless portable two-way radio has been designed using a low power transmitter.

When the **PTT** switch is pressed, the radio generates radio frequency (RF) electromagnetic energy (EME). This radio is designed to comply with the FCC Report and Order FCC 96-326 (August, 1996).

User Safety Information

PLEASE READ THIS IMPORTANT INFORMATION BEFORE USING YOUR Advanced Wireless Communications PORTABLE TWO-WAY RADIO.

- Only qualified technicians are allowed to maintain this product.
- To avoid electromagnetic interference, turn off your radio in places where posted notices instruct you to do so. Hospitals or health care facilities may be using equipment that is sensitive to external RF energy. When travelling on aircraft, turn off your radio when the airline crew instructs you to do so.
- When in vehicles equipped with an air bag, do not place a portable radio in the airbag deployment area.
- Turn off your radio prior to entering any area with a potentially explosive atmosphere. Do not remove, install, or charge batteries in such areas.
- To avoid possible interference with blasting operations, turn off your radio when you are near electrical blasting caps.
- Do not use any portable radio that has a damaged antenna. If a damaged antenna comes into contact with your skin, a minor burn may result.
- Do not expose the radio to direct sunlight for long periods of time. Do not place the radio in direct contact with any heating source.

CONTENTS

- Product Inspection
- Battery Charging Information
- Accessory Information
 - Battery
 - Antenna
 - Belt Clip
- Getting Started
 - LCD Display
- Basic Operations
- Features
 - Monitor
 - Channel Scan
 - Priority Channel Scan
 - Scan Revert Channel
 - Selectable CTCSS/CDCSS
 - Selectable Squelch Level
 - High/Low power
 - Key lock
 - Time Out Timer (TOT)
 - Battery Save
 - Low Battery Alert
 - Busy Channel Lockout
 - Backlight
- Troubleshooting Guide
- Optional Accessories
- Care and Cleaning
- Notice to The User
- CTCSS/CDCSS table

Product Inspection

Thank you for your purchase of Advanced Wireless Communications portable two-way radio model: AWR2108V. Before use, please inspect the product as follows.

First check the shipping carton for any signs of damage. If any damage has occurred, please contact your dealer immediately. Confirm the supplied product against the packing slip to assure accuracy.

■ Available Accessories

| Part number | Item | Qty.(pcs) |
|-------------|----------------|-----------|
| | Antenna* | 1 |
| | Adapter | 1 |
| | Li-ion Battery | 1 |
| | Belt Clip | 1 |
| | Owner's Manual | 1 |
| | Charger cup | 1 |

Battery Charging Information

Standard Charger



1. Insert the radio and battery or battery alone into the charging cup. Charging begins and the red LED will light continuously. When the charging cycle is complete, the red LED will change to green. Charging time is less than 2.5 hours.
2. After the battery is fully charged, the charger will shut off automatically.
3. A flashing red LED indicates an abnormal charging condition, which can be caused by an old battery or a defective battery. Contact your dealer for instructions.

Notes:

- ◆ Batteries should be charged in a dry environment at room temperature.
- ◆ If the battery cannot reach normal capacity after charging, you need to replace the battery.
- ◆ Do not short out the battery terminals or dispose of the battery by fire.

Accessory Information

■ Battery

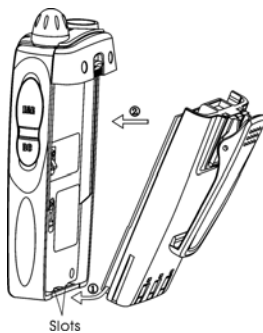

Attaching the Battery (See figure①)

- 1, Insert the tabs, at the bottom of the battery, into the slots at the bottom of the radio chassis..
- 2, Press the top of the battery towards the radio until a click is heard.

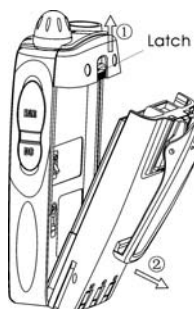

Removing the Battery (See figure②)

- 1, Turn off the radio.

- 2, Push the battery latch on the back panel, towards the top of the radio.
- 3, Pull the top of the battery away from the radio chassis, and lift the battery from the radio.

Antenna

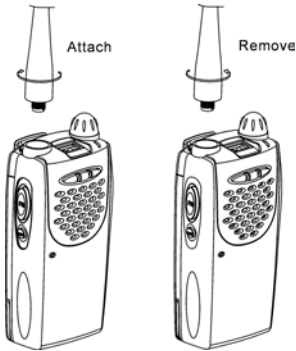

Attaching the Antenna (See figure 3)

- 1, Align the threaded end of the antenna with the radio's antenna connector.
- 2, Turn the antenna clockwise to tighten.

Removing the Antenna (See figure 4)

1. Turn the antenna counter-clockwise until you can remove it.

Belt Clip

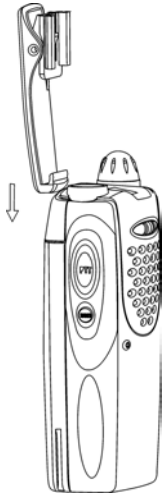

Attaching the Belt Clip (See figure 5)

- 1, Align the grooves of the belt clip with those of the battery.
- 2, Press the belt clip down until a click is heard.

Removing the Belt Clip (See figure 6)

- 1, Pry the belt clip tab away from the battery.
- 2, Slide the belt clip upwards to remove it.

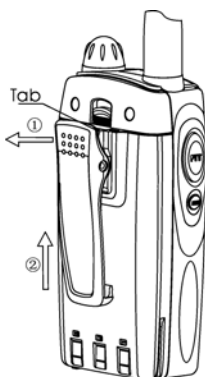

Getting Started

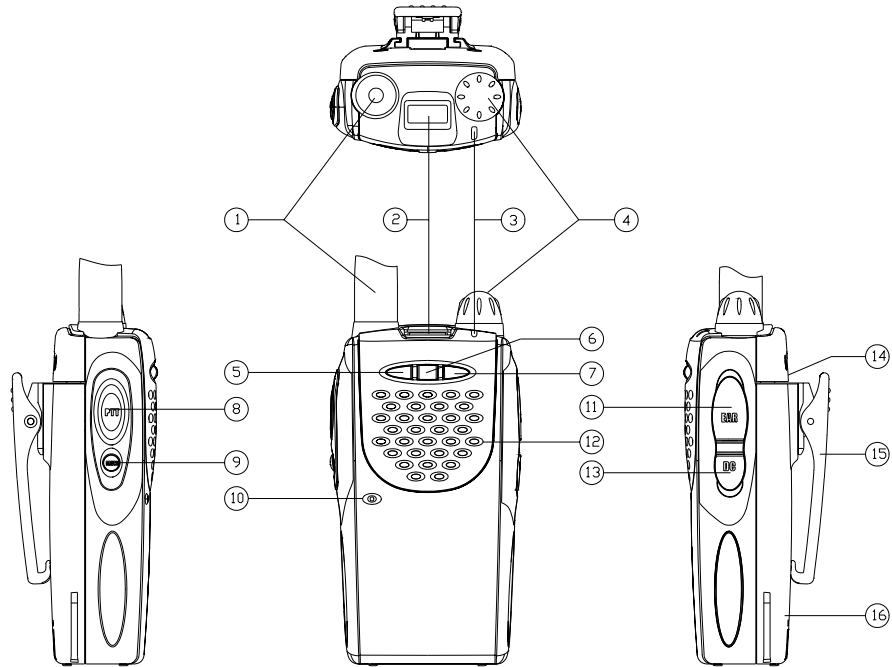

1. Antenna

Used to receive or transmit signals.

2. LCD

Displays operation status of the radio.

3. LED indicator

In transmit mode, the red LED will turn on. In receive mode, the green LED will turn on. A flashing red LED indicates that the battery is low.

4. POWER/VOL Knob

Rotate the volume control clockwise to turn the unit on, fully counter clockwise to turn the unit off. Increase or decrease volume by adjusting the volume control accordingly.

5. Down key

Adjust the channel downwards.

6. SCAN key

Press the scan key to activate the scan mode. When the radio detects properly coded activity on a

channel, it will stop scanning and listen to that channel.

7. Up key

Adjust the channel upwards.

8. PTT button

To transmit, press and hold PTT button. To receive, release PTT button.

9. MONI button

In receive mode, press the MONI key to monitor other activity on your selected channel .

10. Microphone

When transmitting, speak into the microphone holding the radio 2-4 inches from your mouth.

11. jack

Used to connect external earphone/microphone accessories.

12. Speaker

Listen to received audio.

13. DC Jack

Used for factory adjustment only.

14. Battery latch

Used to fasten and remove the battery.

15. Belt clip

Used to clip radio on your belt.

16. Battery pack

LCD Display

1. Appears when the transmit power of the current channel is set for low power.
2. Appears when the dealer disables the radio's speaker. (Must use audio accessory to operate.)
3. Appears when the keys are locked.
4. Display the current channel number.

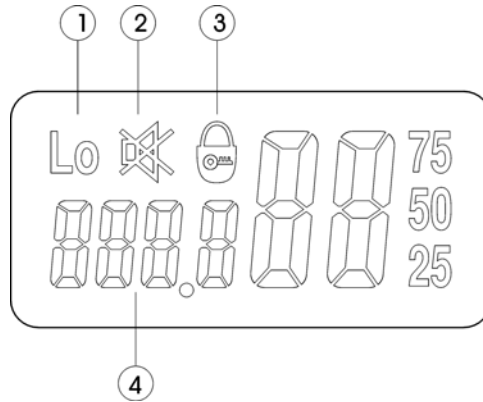

Basic Operations

■ To Turn On the Radio

Turn the POWER/VOL knob clockwise until a click is heard.

■ To Receive

1. Press UP or DOWN key to select the desired channel.
2. Turn POWER/VOL knob to adjust the volume. Pressing the MONI key will provide noise so that the volume can be adjusted accordingly.

Now if the radio receives a signal with CTCSS/CDCSS matching with that set in the radio, the speaker will output audio.

■ To Transmit

1. Press the UP or DOWN key to select the desired channel.
2. To avoid interfering with other users, press the MONI key to monitor activities on your channel and make sure the channel is idle before transmitting.
3. To transmit, press and hold the PTT button, speak clearly into the microphone with the radio 2 to 4 inches away from your mouth. To receive, release the PTT button. When the PTT button is pressed, the red LED will Light until the PTT button is released or until the transmit time out timer expires.

Features

■ Monitor

Press the MONI button to monitor any activity on the channel. Wait for this activity to clear before transmitting.

■ Channel Scan

Channel scan is set to monitor desired activities on all channels in scan list. When channel scan is enabled, the radio will automatically scan all channels in scan list until activity is detected on a channel. The scanning will then stop and the receive audio will be heard. When scanning stops on an active channel, it will restart in the preset restart mode that is set by the dealer. Scan restart mode can be either Time operated scan or Carrier operated scan.

Time Operated Scan

If scanning stops on an active channel, and continues to listen for a preset period (the time is preset by the dealer), it will begin scanning other channels even if there is still activity on the channel.

Carrier Operated Scan

Scan will lock in on the busy channel until there is no activity.

Channel Scan Operations

1. Press SCAN key
Scan starts from the current channel and then scrolls all selected channels in sequence.
2. Press UP or DOWN key to change channel scan sequence. Press the UP key; radio skips the current channel and scans other selected channels in ascending order; press the DOWN key; radio skips the current channel and scans other selected channels in descending order.
3. Press SCAN key again, scan stops.
4. Adding or deleting a channel in/from the scan list. The dealer can add or delete a channel in/from the scan list. Only channels in the scan list can be scanned.

■ Priority Channel Scan

If your dealer has set a priority channel, when radio scans non-priority channels, it will periodically sample the priority channel. If desired activity is detected on the priority channel, it will switch to the priority channel for communications.

■ Scan Revert Channel

The scan revert channel feature allows you to transmit on the proper channel while initiating a call during channel scan. Press [PTT] button, radio stops scanning and transmits on the revert channel. This feature is set by the dealer.

■ Selectable CTCSS/CDCSS

CTCSS/CDCSS feature is used to avoid receiving unwanted signals on the same channel. When CTCSS/CDCSS is enabled, the radio only allows audio with the same CTCSS/CDCSS code to activate the speaker. If CTCSS/CDCSS is disabled, the radio will hear all calls on the same channel. When the dealer allows CTCSS/CDCSS to be selectable by the end user, the operations are as follows:

Press the [UP] key while holding down the [MONI] key to enter CTCSS/CDCSS set mode.

In this mode, press [UP] or [DOWN] to select CTCSS/CDCSS.

Press [SCAN], LCD display toggles between OFF/CTCSS/CDCSS/-CDCSS:

CTCSS/CDCSS OFF: 00

CTCSS: 01— 38

CDCSS: 01— 83

-CDCSS: -01— -83



OFF



CTCSS



CDCSS



-CDCSS

Please refer to CTCSS/CDCSS table.

Press [UP] while holding down [MONI] to exit CTCSS/CDCSS mode.

Note: Though CTCSS/CDCSS feature can prevent you from receiving unwanted signals; it doesn't mean your calls are absolutely private.

■ Selectable squelch level

If this feature is enabled by the dealer, then

Press the [DOWN] key while holding down the [MONI] key to enter squelch level set mode. In this mode, press [UP]/[DOWN] to select the level, 0—9.

Press [PTT] or [MONI] or [SCAN] to exit the mode.

■ High/Low power

If this feature is enabled by the dealer, then

While holding down [PTT], press [MONI] to toggle the power of the current channel between high and low.

When the power is low, "Lo" will be displayed on LCD.

■ Key lock

The key lock feature is designed to avoid accidental pressing of keys. If this feature is enabled by the dealer,

The operation procedures are as follows:

1, Press [SCAN] while holding down [MONI] to lock keys. When keys are locked, [UP],[DOWN] and [SCAN] keys are inoperable, but [PTT] and [MONI] keys will still function.

2, Press [SCAN] while holding down [MONI] to unlock keys.

3, lock symbol appears on LCD:



■ Time Out Timer (TOT)

Time Out Timer is to prevent user from transmitting on the same channel for extended periods of time. This also protects the radio from damage caused by accidental transmissions.

If transmission exceeds the preset time, (the TOT time can be preset by the dealer), the radio will stop transmitting and return to the receive mode. Alert beeps will sound to indicate the halt in transmission. Releasing the PTT button will cause the beeps stop.

■ Battery Save

While no activity is on channel and no operation is performed for 5 seconds, the Battery Save feature will automatically be switched on to reduce power consumption. When a signal is received or an operation is performed, the Battery Save feature is automatically switched off.

■ Low Battery Alert

When the battery voltage is lower than preset value, red LED will flash.

When the battery voltage becomes too low, red LED will flash and beeps sound. When you try to transmit at this time, it is forbidden and beeps sound continuously. You need to replace or charge the battery.

■ Busy Channel Lock Out

If the selected channel is set for busy channel lock out by your dealer, you cannot transmit when there is activity on that channel. If you press the PTT button, the radio will sound beeps and will stay in the receive mode.

■ Backlight

This feature can be enabled by the dealer.

When this feature is enabled, pressing any key except the PTT will illuminate the display. The display will stay lit for 5 seconds.

Troubleshooting Guide

Please check the following items before requesting service.

1. Review operation procedures.
2. Replace or recharge the battery.
3. If reception is poor, check the antenna to make sure it is undamaged and operating in a vertical position.
4. Try another location with fewer obstructions.
5. If you cannot communicate with your group members, make sure you are using the same frequency and CTCSS/CDCSS.
6. If you hear other conversations on your channel, change your CTCSS/CDCSS. Remember to change CTCSS/CDCSS of your other group members.

Optional Accessories

Battery: Li-ion 7.2V 1250mAh type AWB2108

AC Adapter and Charger P/N: 420855203577

Speaker microphone P/N: 420855202945

Ear-bud microphone P/N: 420855203041

Ear-loop microphone P/N: 420855203065

Care and Cleaning

- Do not carry your radio by the antenna or remote microphone.
- Wipe the battery contacts with a lint-free cloth to remove dirt, grease, or other material that may prevent good electrical connection.
- When not in use, keep the accessory jacks covered with the protective cap.
- If cleaning the radio housing becomes necessary, use a cloth or paper towel dampened with a non-abrasive cleaner. Glass cleaner works well. Avoid using strong chemicals. DO NOT submerge in water.

CTCSS/CDCSS Table

| CTCSS | | | | | |
|--------------|----------|----|----------|----|----------|
| NO | Freq(Hz) | NO | Freq(Hz) | NO | Freq(Hz) |
| 00 | NO TONE | 13 | 103.5 | 26 | 162.2 |
| 01 | 67.0 | 14 | 107.2 | 27 | 167.9 |
| 02 | 71.9 | 15 | 110.9 | 28 | 173.8 |
| 03 | 74.4 | 16 | 114.8 | 29 | 179.9 |
| 04 | 77.0 | 17 | 118.8 | 30 | 186.2 |
| 05 | 79.7 | 18 | 123.0 | 31 | 192.8 |
| 06 | 82.5 | 19 | 127.3 | 32 | 203.5 |
| 07 | 85.4 | 20 | 131.8 | 33 | 210.7 |
| 08 | 88.5 | 21 | 136.5 | 34 | 218.1 |
| 09 | 91.5 | 22 | 141.3 | 35 | 225.7 |
| 10 | 94.8 | 23 | 146.2 | 36 | 233.6 |
| 11 | 97.4 | 24 | 151.4 | 37 | 241.8 |
| 12 | 100.0 | 25 | 156.7 | 38 | 250.3 |
| CDCSS | | | | | |
| NO | CODE | NO | CODE | NO | CODE |
| 01 | 023 | 29 | 174 | 57 | 445 |
| 02 | 025 | 30 | 205 | 58 | 464 |
| 03 | 026 | 31 | 223 | 59 | 465 |
| 04 | 031 | 32 | 226 | 60 | 466 |
| 05 | 032 | 33 | 243 | 61 | 503 |
| 06 | 043 | 34 | 244 | 62 | 506 |
| 07 | 047 | 35 | 245 | 63 | 516 |
| 08 | 051 | 36 | 251 | 64 | 532 |

| | | | | | |
|----|-----|----|-----|----|-----|
| 09 | 054 | 37 | 261 | 65 | 546 |
| 10 | 065 | 38 | 263 | 66 | 565 |
| 11 | 071 | 39 | 265 | 67 | 606 |
| 12 | 072 | 40 | 271 | 68 | 612 |
| 13 | 073 | 41 | 306 | 69 | 624 |
| 14 | 074 | 42 | 311 | 70 | 627 |
| 15 | 114 | 43 | 315 | 71 | 631 |
| 16 | 115 | 44 | 331 | 72 | 632 |
| 17 | 116 | 45 | 343 | 73 | 654 |
| 18 | 125 | 46 | 346 | 74 | 662 |
| 19 | 131 | 47 | 351 | 75 | 664 |
| 20 | 132 | 48 | 364 | 76 | 703 |
| 21 | 134 | 49 | 365 | 77 | 712 |
| 22 | 143 | 50 | 371 | 78 | 723 |
| 23 | 152 | 51 | 411 | 79 | 731 |
| 24 | 155 | 52 | 412 | 80 | 732 |
| 25 | 156 | 53 | 413 | 81 | 734 |
| 26 | 162 | 54 | 423 | 82 | 743 |
| 27 | 165 | 55 | 431 | 83 | 754 |
| 28 | 172 | 56 | 432 | | |

AWC endeavor to achieve the accuracy and completeness of this manual, but cannot guarantee its accuracy at all times. All the above specifications and design are subject to change by AWC without notice.

All the reproduction and translation of this manual without authorization of AWC is not allowed.