



849 NW STATE ROAD 45
NEWBERRY, FL 32669 USA
PH: 888.472.2424 OR 352.472.5500
FAX: 352.472.2030
EMAIL: INFO@TIMCOENGR.COM
[HTTP://WWW.TIMCOENGR.COM](http://WWW.TIMCOENGR.COM)

FCC PART 90 VHF TWO-WAY RADIO COMPLIANCE TEST REPORT

APPLICANT	Holzberg Communications Inc
ADDRESS	Po Box 322 Totowa NJ 07511 USA
PROPOSED FCC ID	Q9FPX-328V
MODEL NUMBER	PX-328V
PRODUCT DESCRIPTION	VHF Portable Transceiver
DATE SAMPLE RECEIVED	9/5/2007
DATE TESTED	9/21/2007
TESTED BY	Richard Block
APPROVED BY	Mario de Aranzeta
TIMCO REPORT NO.	2528AUT7TestReport.pdf
TEST RESULTS	<input checked="" type="checkbox"/> Pass <input type="checkbox"/> Fail

**THE ATTACHED REPORT SHALL NOT BE REPRODUCED EXCEPT IN FULL
WITHOUT THE WRITTEN APPROVAL OF TIMCO ENGINEERING, INC.**



Certificate # 0955-01

TABLE OF CONTENTS

ATTESTATION	3
REPORT SUMMARY.....	4
TEST ENVIRONMENT AND TEST SETUP	4
DUT SPECIFICATION.....	5
TEST EQUIPMENT LIST.....	6
TEST PROCEDURE	7
RF POWER OUTPUT	10
MODULATION CHARACTERISTICS.....	11
Audio Frequency Response	11
Audio Input Versus Modulation	13
OCCUPIED BANDWIDTH	14
OTHER MODULATION CHARACTERISTICS	17
SPURIOUS EMISSIONS AT ANTENNA TERMINALS (CONDUCTED).....	18
FIELD STRENGTH OF SPURIOUS EMISSIONS.....	19
FREQUENCY STABILITY.....	20
TRANSIENT FREQUENCY BEHAVIOR.....	21

ATTESTATION

This equipment has been tested in accordance with the standards identified in the referenced test report. To the best of my knowledge and belief, these tests were performed using the measurement procedures described in this report.

All instrumentation and accessories used to test products for compliance to the indicated standards are calibrated regularly in accordance with ISO 17025 requirements.

I attest that the necessary measurements were made by me or under my supervision, at Timco Engineering, Inc. located at 849 N.W. State Road 45, Newberry, Florida 32669 USA.



Certificate # 0955-01

Authorized by: Mario de Aranzeta
Signature: On file
Function: Engineer / Test Lab Supervisor
Date: September 27, 2007

REPORT SUMMARY

Disclaimer	The test results relate only to the items tested.
Purpose of Test	To show the DUT in compliance with FCC CFR 47, Part 90 requirements for land mobile radios.
Test Standards	ANSI/TIA 603-C: 2004, FCC CFR 47 Part 90, ANSI C63.4: 2003
Related Approval(s)/Report(s)	Receiver and digital interface portion were verified. (2528BUT7Testreport.pdf)

TEST ENVIRONMENT AND TEST SETUP

Test Facility	All tests were conducted by Timco Engineering Inc which is located at 849 NW State Road 45, Newberry, FL 32669 USA.
Laboratory Test Condition	Temperature: 26°C Relative humidity: 50%
Deviation from the standards	No deviation
Modification to the DUT	No modification.
Test Exercise (software etc.)	The DUT was placed in continuous transmitting mode of operation.
System Setup	Stand alone device.

DUT SPECIFICATION

DUT Description	VHF Portable Transceiver
Proposed FCC ID	Q9FPX-328V
Model Number	PX-328V
Serial Number	070829C0002
Operating Frequency	136-174 MHz Note: in USA it is only capable of 150 – 174 MHz
Type of Emission	11K2F3E, 16K0F3E
Modulation	FM
DUT Power Source	<input type="checkbox"/> 110-120Vac/50- 60Hz
	<input checked="" type="checkbox"/> DC Power
	<input type="checkbox"/> Battery Operated Exclusively
Test Item	<input type="checkbox"/> Prototype
	<input checked="" type="checkbox"/> Pre-Production
	<input type="checkbox"/> Production
Type of Equipment	<input type="checkbox"/> Fixed
	<input type="checkbox"/> Mobile
	<input checked="" type="checkbox"/> Portable
Antenna Type / Connector	SMA

TEST EQUIPMENT LIST

Device	Manufacturer	Model	Serial Number	Cal/Char Date	Due Date
Analyzer Tan Tower Spectrum Analyzer	HP	8566B Opt 462	3138A07786 3144A20661	CAL 12/7/05	12/7/07
Analyzer Tan Tower RF Preselector	HP	85685A	3221A01400	CAL 12/7/05	12/7/07
Analyzer Tan Tower Quasi-Peak Adapter	HP	85650A	3303A01690	CAL 12/8/05	12/8/07
Analyzer Tan Tower Preamplifier	HP	8449B-H02	3008A00372	CAL 12/8/05	12/8/07
Antenna: Biconnical	Electro-Metrics	BIA-25	1171	CAL 4/29/07	4/29/09
LISN	Electro-Metrics	ANS-25/2	2604	CAL 10/5/06	10/5/08
Log-Periodic Antenna	Eaton	96005	1243	CAL 12/14/05	12/14/07
Double-Rigged Horn Antenna	ETS-Lindgren	3117	00035923	9/27/06	9/27/08
Std gain Horn Antenna	Polarad	18 - 26 GHz	Not Serialized	Not required	Not Required

TEST PROCEDURE

Power Line Conducted Interference

The procedure used was ANSI 63.4-2003 using a 50uH LISN. Both lines were observed with the DUT transmitting. The bandwidth of the spectrum analyzer was 10 kHz with an appropriate sweep speed.

RF Power Output

The RF power output was measured at the antenna feed point using a peak power meter. A 50-ohm, resistive wattmeter was connected to the RF output connector. With a nominal battery voltage, and the transmitter properly adjusted the RF output measures:

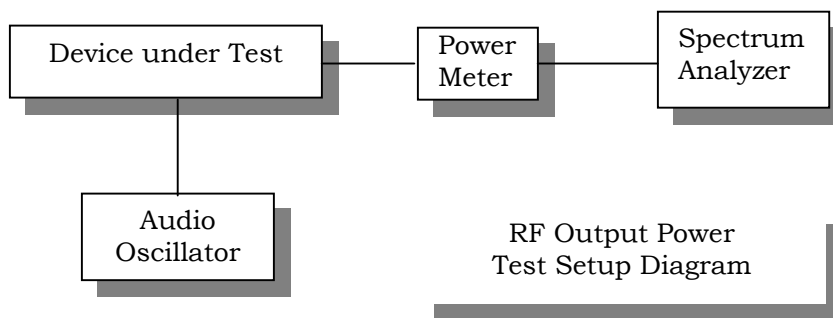

Spurious Emissions At Antenna Terminals (Conducted)

The carrier was modulated 100%. The spectrum was scanned from 0.4 to at least the 10th harmonic of the fundamental. Above 1 GHz the resolution bandwidth was 1 MHz and the VBW = 3 MHz and the span to 50 MHz. The measurements were made in accordance with standard ANSI/TIA-603-C: 2004.

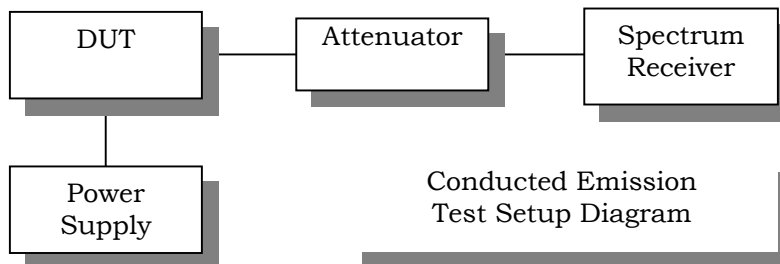

Radiation Interference

The test procedure used was ANSI/TIA-603-C: 2004 and ANSI C63.4-2003 using an Agilent spectrum receiver with pre-selector. The bandwidth (RBW) of the spectrum receiver was 100 kHz up to 1 GHz and 1 MHz above 1 GHz with an appropriate sweep speed. The VBW above 1 GHz was 3 MHz. The analyzer was calibrated in dB above a microvolt at the output of the antenna.

Occupied Bandwidth

The test procedure used was ANSI/TIA 603-C: 2004 paragraph 2.2.11.

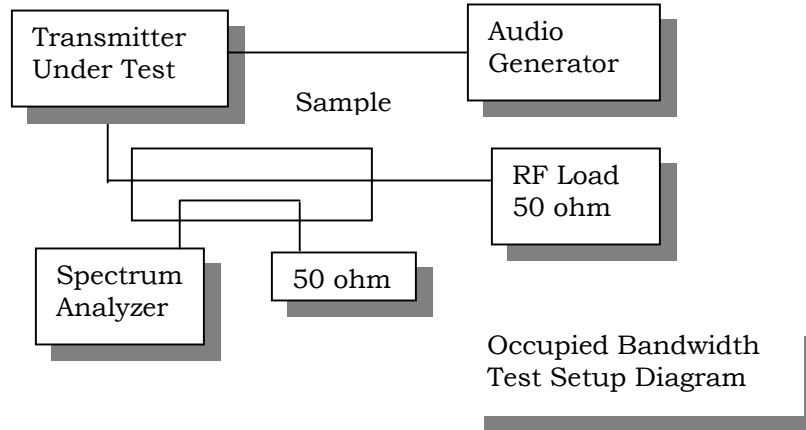

Modulation Characteristic

Audio frequency response

The audio frequency response was measured in accordance with ANSI/TIA 603-C: 2004.

Audio Low Pass Filter

The audio low pass filter for voice-modulated equipment was measured in accordance with ANSI/TIA 603-C: 2004.

Audio Input versus modulation

The audio input level needed for a particular percentage of modulation was measured in accordance with ANSI/TIA 603-C: 2004.

Frequency Stability

The frequency stability was measured per ANSI/TIA 603-C: 2004.

Field Strength of Spurious Emissions

The spectrum was scanned from 30 MHz to at least the tenth harmonic of the fundamental. This test was conducted per ANSI/TIA 603-C: 2004 using the substitution method.

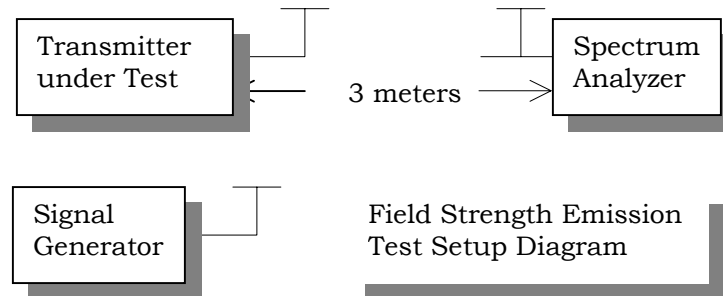

Transient Frequency Behavior

The test procedure was ANSI/TIA 603-C: 2004 Para 2.2.19.

- Using the variable attenuator. The transmitter level was set to 40 dB below the test receivers maximum input level,
- Then the transmitter was turned off.
- With the transmitter off the signal generator was set 20dB below the level of the transmitter in the above step, this level will be maintained with the signal generator through-out the test.
- Reduce the attenuation between the transmitter and the RF detector by 30 dB.
- With the levels set as above the transient frequency behavior was observed & recorded.

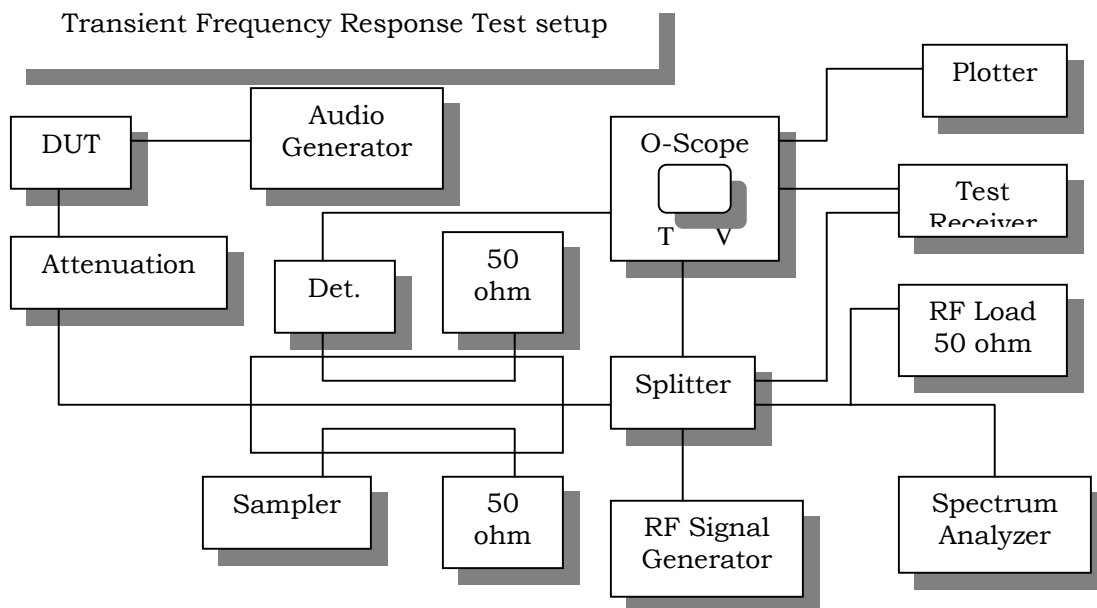

RF POWER OUTPUT

Rule Part No.: Pt 2.1046(a), Pt 90.205

Requirements: Pt 2.1046(a)

Test Data:

Output Power

High: 5 Watts

Low: 1 Watt

Part 2.1033 (C)(8) DC Input into the final amplifier

High Power

DC Voltage: 7.4 Vdc DC Current: 1.5 A

DC Power: 11.1 Watts

Low Power

DC Voltage: 7.4 Vdc DC Current: 0.7 A

DC Power: 5.2 Watts

MODULATION CHARACTERISTICS

Audio Frequency Response

Rule Part No.: Part 2.1047(a)(b)

Requirements: Part 2.1047(a)(b)

Test Data: A curve or equivalent data showing the frequency response of the audio modulating circuit over a range of 100 – 5000Hz is submitted. The audio frequency response curve is shown below.

AUDIO FREQUENCY RESPONSE PLOT -- 12.5 kHz

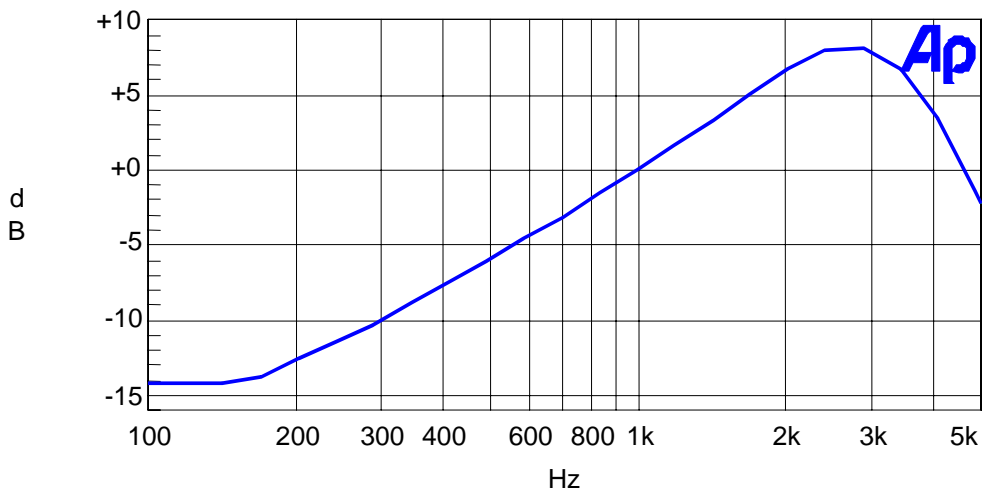

AUDIO FREQUENCY RESPONSE PLOT -- 25 kHz

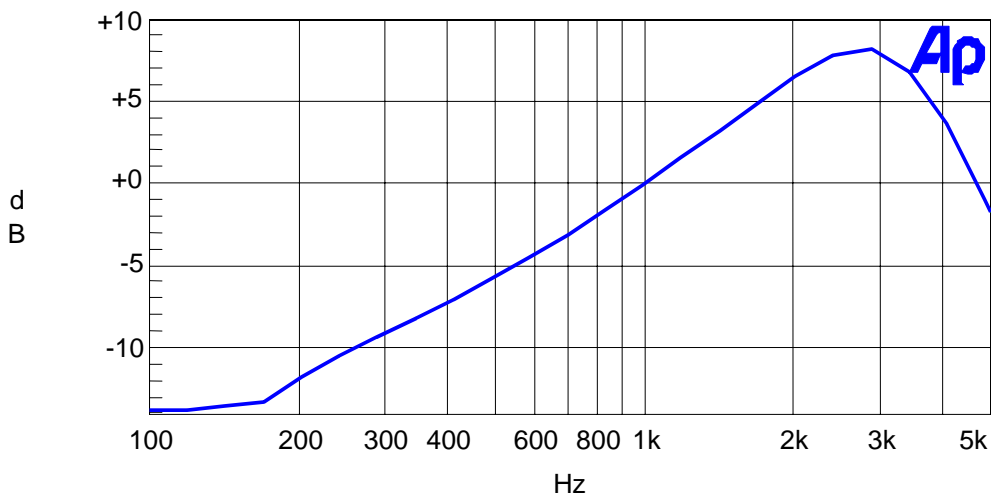

Voice Modulated Communication Equipment

Rule Part No.: Part 2.1047(a)

Requirements: Part 2.1047(a)

Test Data: A curve showing the frequency response of the filter, or of all the circuitry installed between the modulation limiter and the modulated stage is submitted. The audio low pass filter plot is shown below.

AUDIO LOW PASS FILTER PLOT -- 12.5 kHz

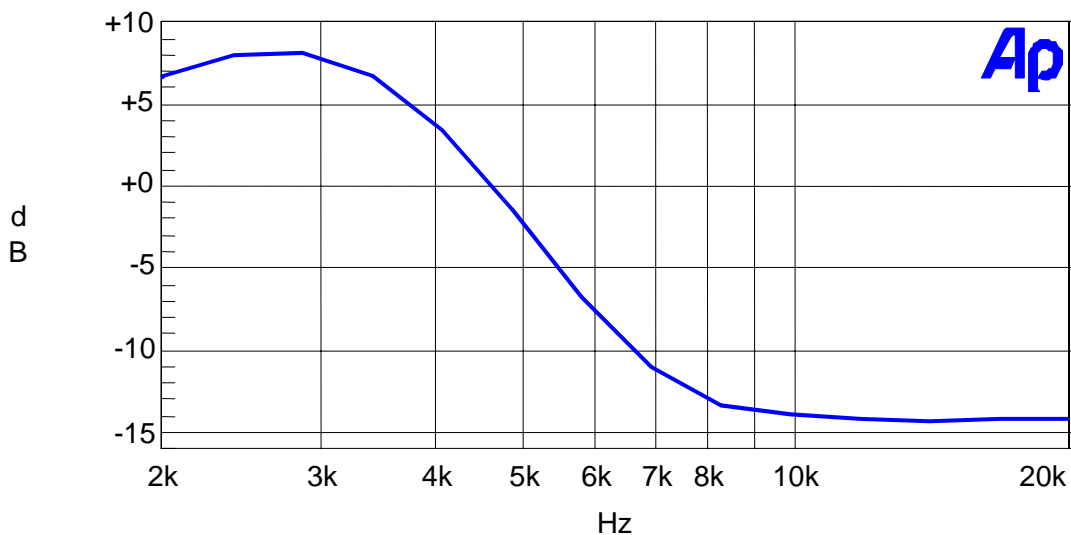

AUDIO LOW PASS FILTER PLOT -- 25 kHz

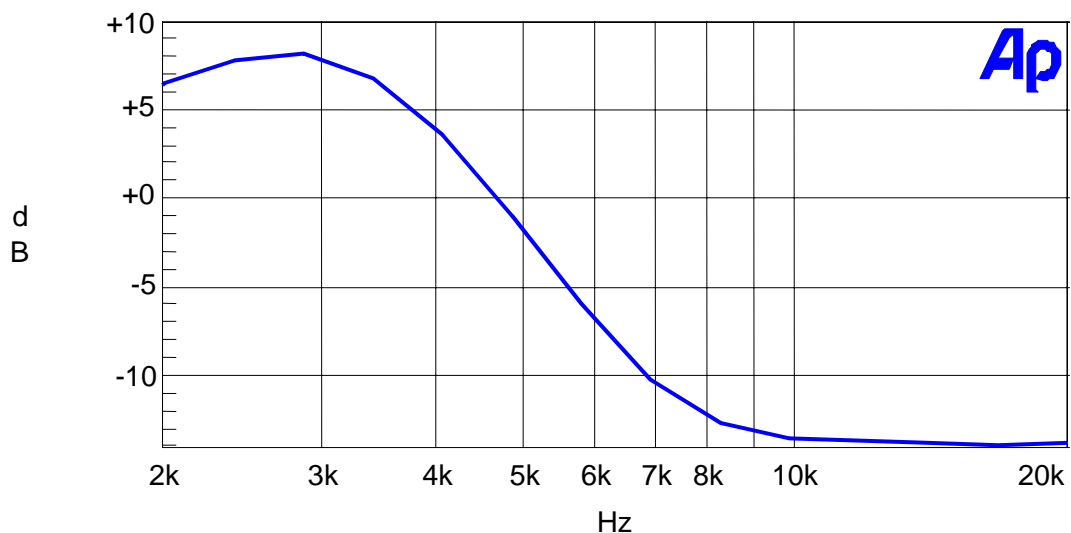

Audio Input Versus Modulation

Rule Part No.: Part 2.1047(b), Pt 90

Requirements: Part 2.1047(b), Pt 90

Test Data: The audio input curves versus modulation are shown below. Curves are provided for audio input frequencies of 300, 1000, and 2500 Hz.

MODULATION LIMITING PLOTS -- 12.5 kHz
2.5kHz GREEN -- 1.0kHz BLUE -- 300Hz YELLOW

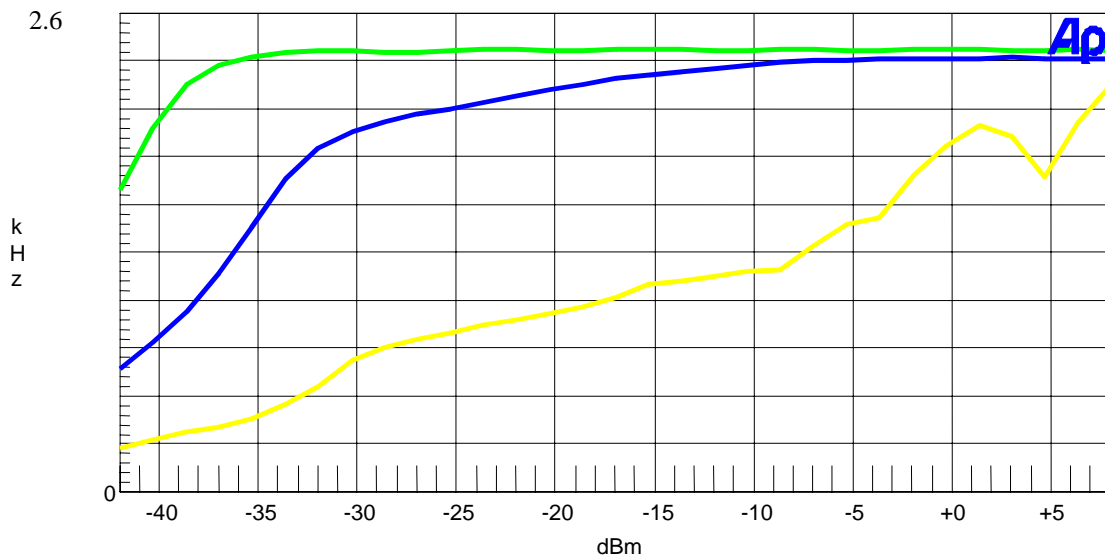

MODULATION LIMITING PLOTS -- 25.0 kHz
2.5 kHz GREEN -- 1.0 kHz BLUE -- 300 Hz YELLOW

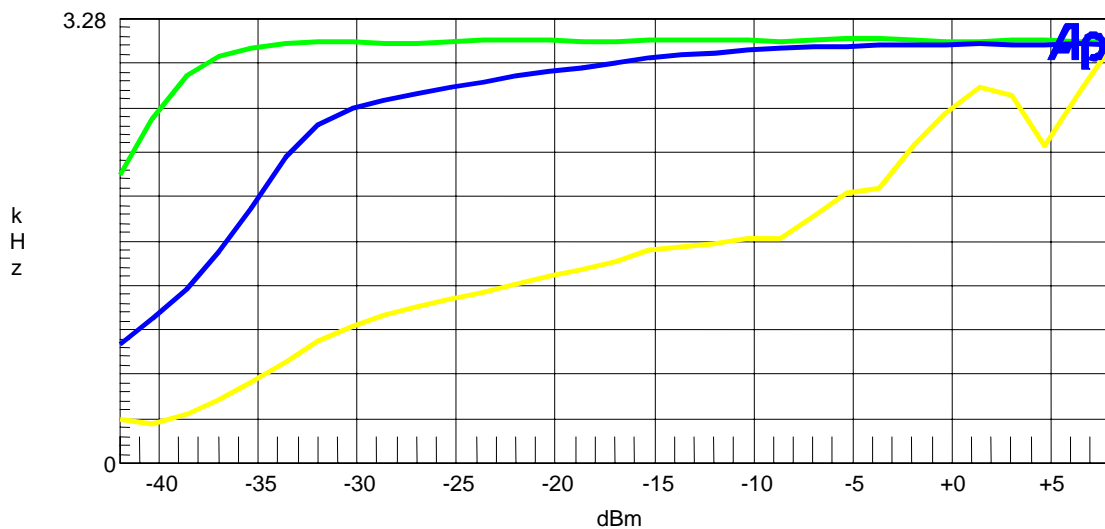

OCCUPIED BANDWIDTH

Rule Part No.: Pt 2.1049 (c), Pt 90.210(b), Pt 90.210(c), Pt 902.210(d)

Requirements:

Part 90.210(b) 25 kHz Channel Spacing

Data in the plots show that on any frequency removed from the assigned frequency by more than 50%, but not more than 100%: At least 25dB. On any frequency removed from the assigned frequency by more than 100%, but not more than 250%: At least 35 dB. On any frequency removed from the assigned frequency by more than 250%, of the authorized bandwidth: At least $43 + 10\log(P)$ dB.

Part 90.210(c) 12.5 kHz Channel Spacing Not Equipped with a Low Pass Filter

For transmitters that are not equipped with an audio low pass filter pursuant to S90.211 (b), the power of any emission must be attenuated below the un-modulated carrier output power as follows; (1) On any frequency removed from the center of the authorized bandwidth by a displacement frequency (f_d in kHz) of more than 5 kHz but not more than 10 kHz: At least $83 \log(f_d/5)$ dB; (2) ON any frequency removed from the center of the authorized bandwidth by a displacement frequency (f_d in kHz) of more than 10 kHz, but not more than 250% of the authorized bandwidth: At least $29 \log(f_d/11)$ dB or 50 dB, whichever is the lesser attenuation; (3) On any frequency removed from the center of the authorized bandwidth by more than 250% of the authorized bandwidth: At least $43 + 10 \log(P_o)$ dB.

Part 90.210(d) Emission Mask D - 12.5 kHz channel BW equipment.

For transmitters designed to operate with a 12.5 kHz channel bandwidth, any emission must be attenuated below the power (P) of the highest emission contained within the authorized bandwidth as follows:

- (1) On any frequency from the center of the authorized bandwidth f_0 to 5.625 kHz removed from f_0 : Zero dB.
- (2) On any frequency from the center of the authorized bandwidth by a displacement frequency (f_d in kHz) of more than 5.625 kHz but no more than 12.5 kHz: At least $7.27 (f_d - 2.88 \text{ kHz})$ dB.
- (3) On any frequency removed from the center of the authorized bandwidth by a displacement frequency (f_d in kHz) of more than 12.5 kHz: At least $50 + 10\log(P)$ dB or 70 dB, whichever is the lesser attenuation.

Test Data: See the plots below.

NOTES:

OCCUPIED BANDWIDTH -- 12.5 kHz
 HOLTZBERG COMMUNICATIONS INC -- FCC ID: Q9F PX-328V

FCC 90.210 Mask D

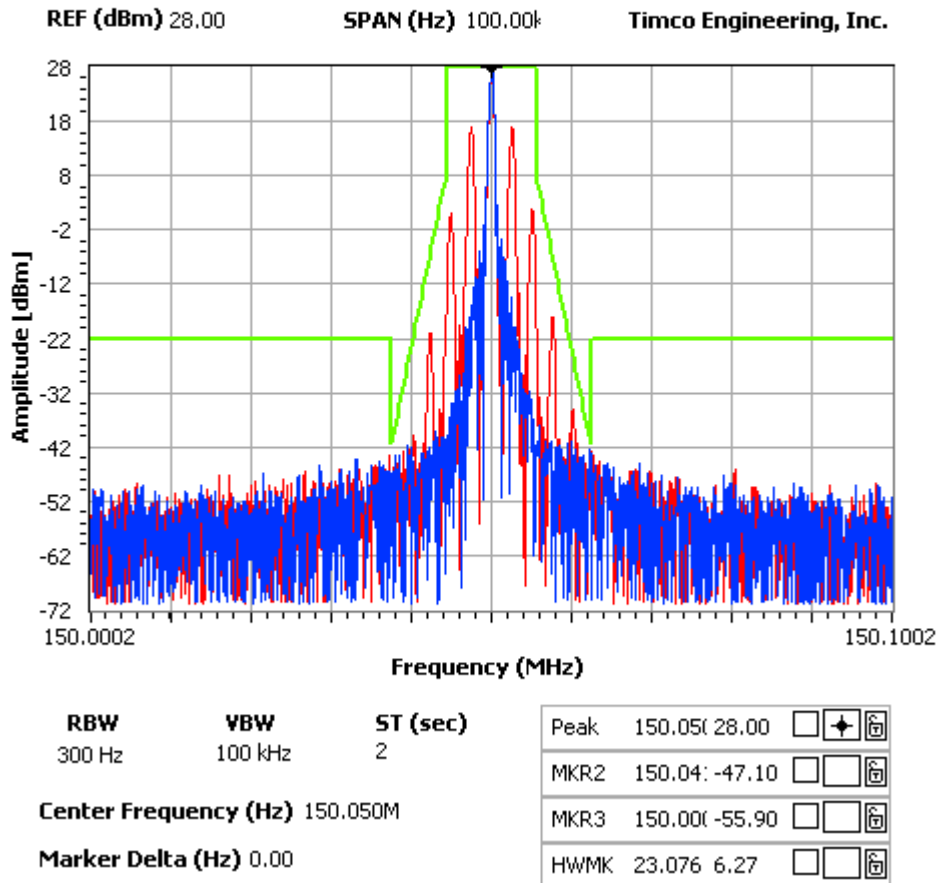

NOTES:

OCCUPIED BANDWIDTH -- 25kHz
 HOLTZBERG COMMUNICATIONS INC -- FCC ID: Q9F PX-328V

FCC 90.210 Mask B

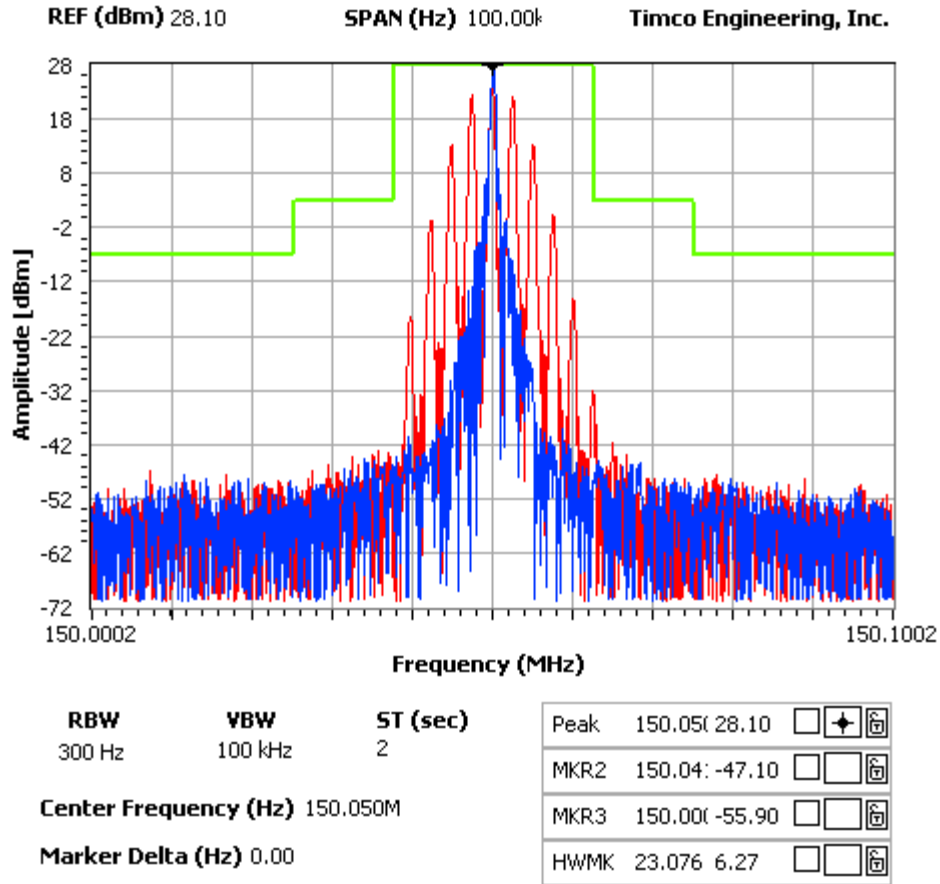

OTHER MODULATION CHARACTERISTICS

Rule Part No.: Pt 2.1033(c), Pt 90.209, Pt 90.207

Requirements: Pt 2.1033(c), Pt 90.209, Pt 90.207

Test Data:

Pt 2.1033(c) (4)
Pt 90.209 & Pt 90.207

Type of Emission: 11K2F3E
Bn = 2M + 2DK
M = 3000
D = 2600
K = 1
Bn = 2(3000)+2(2600) = 11.2k

Pt 2.1033(c) (4)
Pt 90.209 & Pt 90.207

Type of Emission: 16K0F3E
Bn = 2M + 2DK
M = 3000
D = 3300
K = 1
Bn = 2(3000)+2(3300) = 12.6 k

SPURIOUS EMISSIONS AT ANTENNA TERMINALS (CONDUCTED)

Rule Part No.: Part 2.1051(a)

Requirements: High power 12.5 kHz Spacing = $50+10\log(5) = 57$ dB
 Low power 12.5 kHz Spacing = $50+10\log(1) = 50$ dB

Test Data:

High Power

EF	dB below carrier	EF	dB below carrier	EF	dB below carrier
136.050	0.0	150.050	0.0	174.050	0.0
272.100	67.1	300.100	89.0	348.100	61.6
408.150	80.6	450.150	83.8	522.150	87.9
544.200	83.5	600.200	77.9	696.200	83.6
680.250	70.5	750.250	71.5	870.250	79.8
816.300	87.2	900.300	86.5	1044.300	84.2
952.350	89.1	1050.350	85.4	1218.350	90.8
1088.400	74.4	1200.400	91.5	1392.400	93.8
1224.450	90.7	1350.450	90.9	1566.450	90.7
1360.500	94.3	1500.500	90.8	1740.500	91.3

Low Power

EF	dB below carrier	EF	dB below carrier	EF	dB below carrier
136.050	0.0	150.050	0.0	174.050	0.0
272.100	58.7	300.100	69.8	348.100	59.9
408.150	77.9	450.150	82.2	522.150	84.6
544.200	82.4	600.200	76.6	696.200	70.9
680.250	72.2	750.250	74.2	870.250	79.4
816.300	87.5	900.300	83.3	1044.300	81.3
952.350	85.9	1050.350	83.4	1218.350	88.0
1088.400	78.9	1200.400	85.6	1392.400	84.8
1224.450	78.2	1350.450	86.7	1566.450	85.3
1360.500	88.2	1500.500	84.8	1740.500	84.3



FIELD STRENGTH OF SPURIOUS EMISSIONS

Rule Parts. No.: Part 2.1053

Requirements: High power 12.5 kHz Spacing = $50+10\log(5) = 57$ dB
 Low power 12.5 kHz Spacing = $50+10\log(1) = 50$ dB

Test Data:

High Power

Emission Frequency MHz	Ant. Polarity V/H	dB Below Carrier (dBc)	Emission Frequency MHz	Ant. Polarity V/H	dB Below Carrier (dBc)	Emission Frequency MHz	Ant. Polarity V/H	dB Below Carrier (dBc)
136.050	0	0.0	150.050	0	0.0	174.050	0	0.0
272.100	H	94.7	300.100	H	107.5	348.100	V	65.8
408.150	V	96.0	450.150	H	92.4	522.150	H	91.6
544.200	H	99.6	600.200	H	96.7	696.200	H	96.9
680.250	V	91.0	750.250	V	82.4	870.250	V	80.6
816.300	V	86.6	900.300	V	84.4	1044.300	V	81.9
952.350	V	89.7	1050.350	V	86.2	1218.350	V	77.6
1088.400	V	89.3	1200.400	V	85.9	1392.400	V	94.2
1224.450	V	88.6	1350.450	V	67.5	1566.450	H	89.8
1360.500	H	89.3	1500.500	H	80.0	1740.500	H	88.6

Low Power

Emission Frequency MHz	Ant. Polarity V/H	dB Below Carrier (dBc)	Emission Frequency MHz	Ant. Polarity V/H	dB Below Carrier (dBc)	Emission Frequency MHz	Ant. Polarity V/H	dB Below Carrier (dBc)
136.050	0	0.0	150.050	0	0.0	174.050	0	0.0
272.100	V	87.0	300.100	H	88.6	348.100	V	65.6
408.150	V	93.0	450.150	H	91.4	522.150	H	89.7
544.200	H	96.8	600.200	H	94.1	696.200	V	95.1
680.250	V	92.3	750.250	V	84.8	870.250	V	85.7
816.300	V	90.1	900.300	H	86.5	1044.300	V	79.6
952.350	V	88.2	1050.350	V	81.7	1218.350	H	84.5
1088.400	V	86.1	1200.400	H	90.1	1392.400	H	81.5
1224.450	V	83.3	1350.450	V	64.8	1566.450	H	83.1
1360.500	V	82.6	1500.500	H	76.1	1740.500	H	83.1

FREQUENCY STABILITY

Rule Parts. No.: Part 2.1055, Part 90.213

Requirements: Temperature range requirements: -30 to +50° C.
Voltage Variation +, -15%
±5 PPM

Test Data: The DUT appears to meet this specific requirement

Assigned Frequency (Ref. Frequency) (MHz)		150.050080
Temperature (°C)	Frequency (MHz)	Frequency Stability (PPM)
-30	150.050386	2.04
-20	150.050288	1.39
-10	150.050285	1.37
0	150.050224	0.96
+10	150.050198	0.79
+20	150.050115	0.23
+30	150.050134	0.36
+40	150.050078	-0.01
+50	150.050071	-0.06

Assigned Frequency (Ref. Frequency) (MHz)		150.050080
% Battery	Frequency (MHz)	Frequency Stability (PPM)
-15%	150.050073	-0.05

TRANSIENT FREQUENCY BEHAVIOR

Rule Part No.: Pt 90.214

Requirements: Transmitters designed to operate in the 150-174 MHz and 421-512 MHz frequency bands must maintain transient frequencies within the maximum transient frequencies difference limits in the time intervals indicated:

Time Intervals	Maximum frequency difference	All Equipment	
		150-174 MHz	421-512 MHz

Transient Frequency Behavior for Equipment Designed to Operate on 25 kHz Channels

t_1^4	± 25.0 kHz	5.0 ms	10.0 ms
t_2	± 12.5 kHz	20.0 ms	25.0 ms
t_3^4	± 25.0 kHz	5.0 ms	10.0 ms

Transient Frequency Behavior for Equipment Designed to Operate on 12.5 kHz Channels

t_1^4	± 12.5 kHz	5.0 ms	10.0 ms
t_2	± 6.25 kHz	20.0 ms	25.0 ms
t_3^4	± 12.5 kHz	5.0 ms	10.0 ms

Transient Frequency Behavior for Equipment Designed to Operate on 6.25 kHz Channels

t_1^4	± 6.25 kHz	5.0 ms	10.0 ms
t_2	± 3.125 kHz	20.0 ms	25.0 ms
t_3^4	± 6.25 kHz	5.0 ms	10.0 ms

Test Data: The plots are presented below.

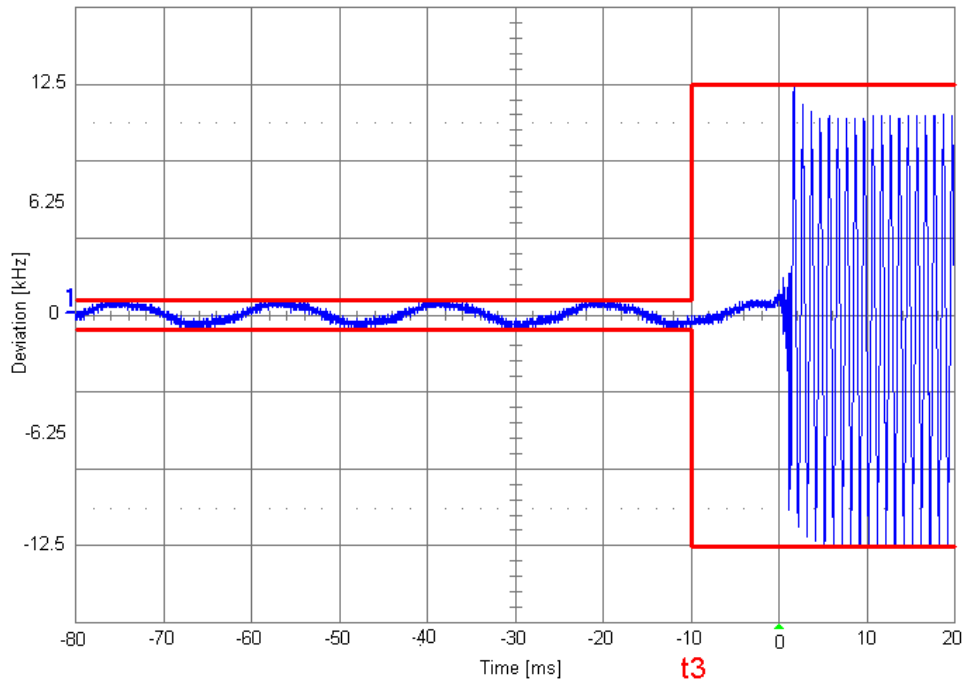

10 ms 445mV

12.5 kHz OFF

NORMAL

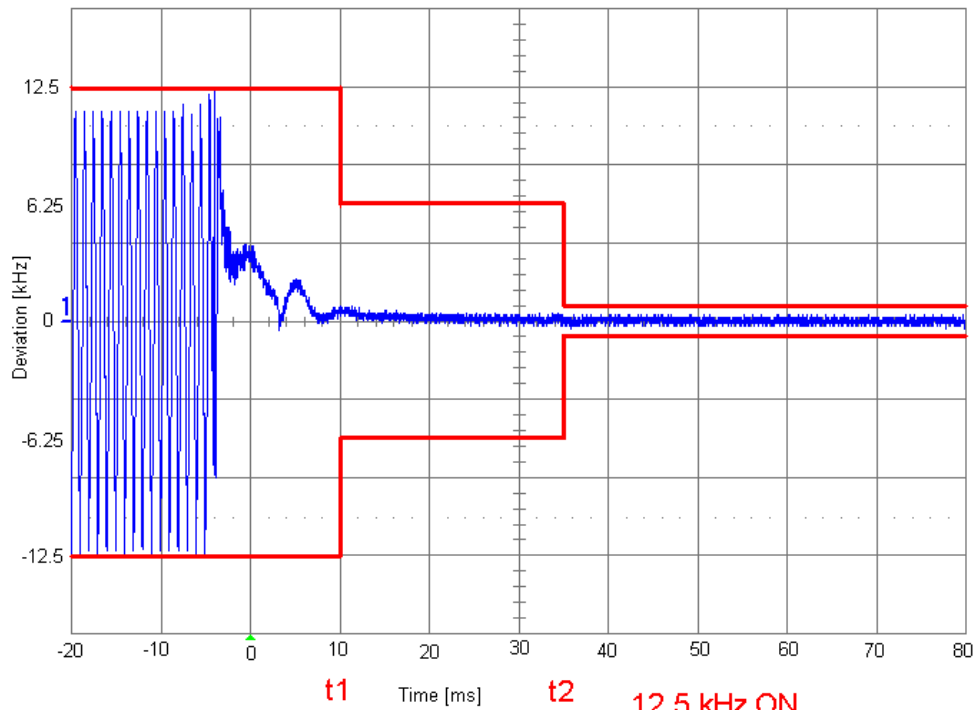

10 ms 440mV

NORMAL

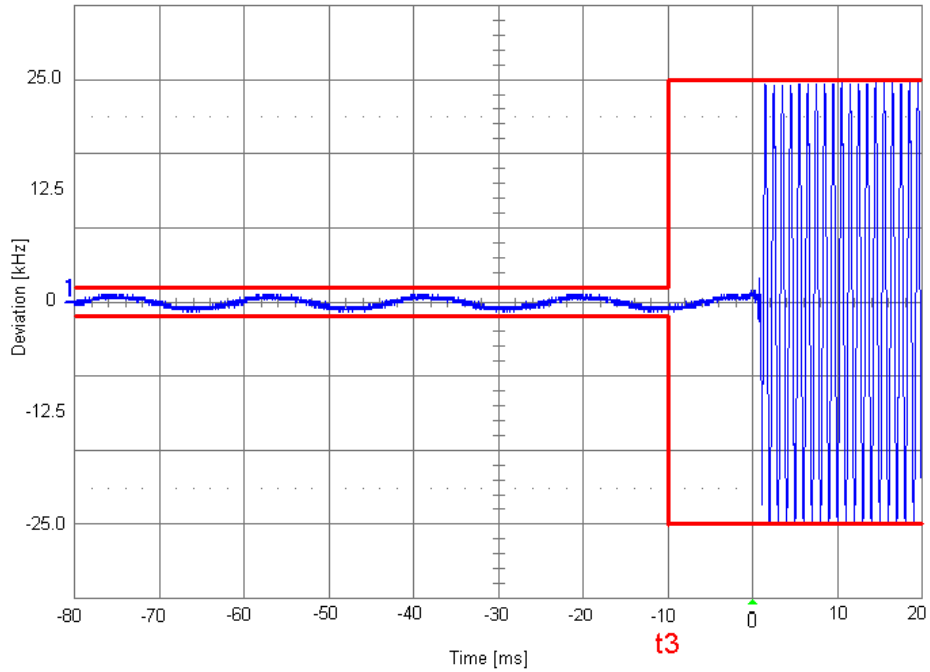

25.0 kHz OFF

10 ms 0.74 V

NORMAL

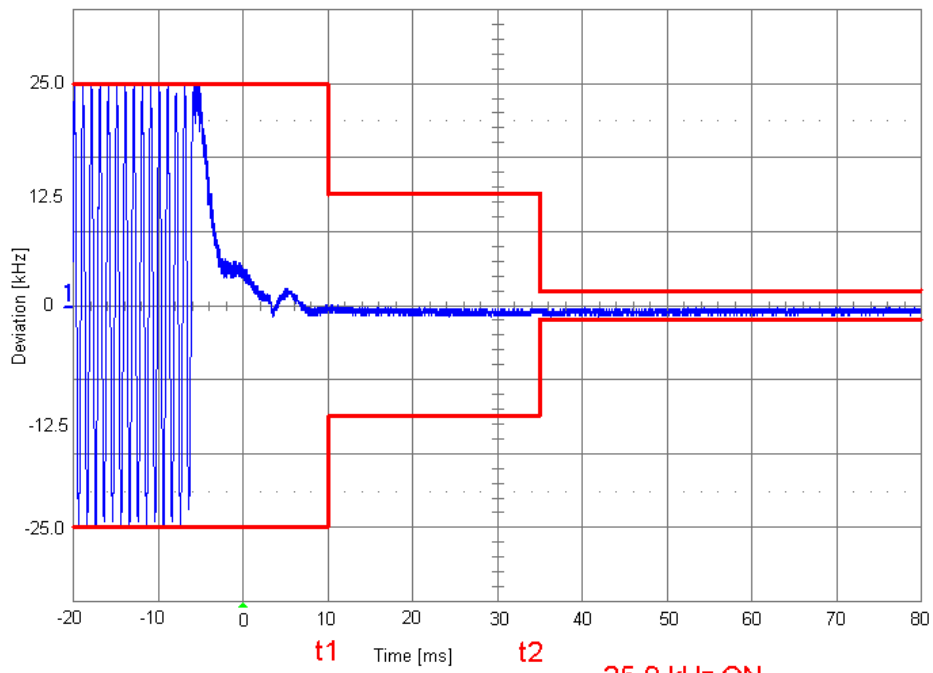

25.0 kHz ON

10 ms 0.74 V

NORMAL