

**HOLZBERG**



## **KY104L Portable Transceiver**

### **Users Manual**

## KY104L Quick Reference

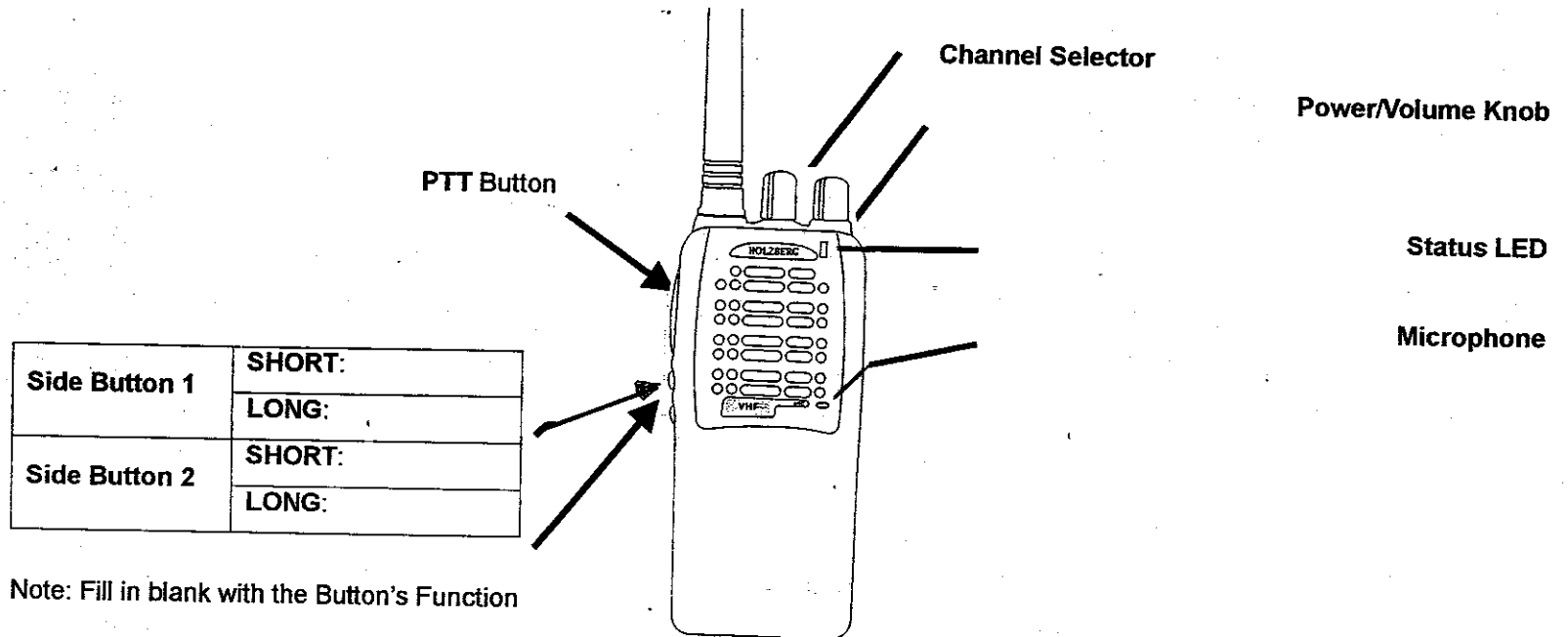

### Turning Power On

Rotate the **Power/Volume Knob** clockwise to turn on the transceiver. If the **LED Indicator** light GREEN to RED then OFF, and a high voice beep means that the transceiver is ok, otherwise, a low long beep means that Self-Tests failure.

### Turning Power Off

Rotate the **Power/Volume Knob** anti-clockwise until a click is heard to turn the transceiver off.

### Adjusting Volume

1. If there is no receive audio, you need hold down the

## KY104L Quick Reference

Monitor button to open the squelch, so you can hear background noise.

2. Continue to hold the Monitor Button and rotary the **Power/Volume Knob** to desired volume level, turn clockwise to increase or anti-clockwise to reduce the volume.
3. Release the Monitor Button.

### To Select a Channel

Rotate the **Channel Selector Knob** to select the channel number.

### To Transmit

1. Rotate the **Channel Selector Knob** to select a desired channel.
2. Press and hold down **PTT** button, hold the transceiver about 2.5 ~ 5cm (1 to 2 inches) from your lips to microphone and speak in your normal speaking voice.
3. Release the **PTT** button to return to the receive mode.

### To Receive

1. Turn on power.
2. Adjust the volume
3. Select a desired channel
4. When a signal with proper or matching sub-tones is received, you will hear the transmissions from other transceivers. You may need to adjust the volume more precisely.

### Deleting Nuisance Channel

1. While transceiver locked onto unwanted channel in the SCAN Mode, press the "Nuisance Delete" Button until you hear two beeps.
2. Release the "Nuisance Delete" Button.

#### Note:

"Nuisance Delete" can only be used if your dealer has programmed one function button for it.

## KY104L Quick Reference

### LED Indicator

LED indicate / color	Explain
Light "RED" continuously	Transmitting a message
Light "GREEN" continuously	Receiving a signal
"GREEN" flash	Scanning
Light "ORANGE" continuously	A sub-tone code is received that is matching the code programmed in your radio. The code may be a CTCSS code or DCS code.

### Beep for Side Button Operating

Button Function	Positive Beep	Negative Beep
Scan	Scan ON	Scan OFF
Power	High Power	Low Power
Squelch	Tight squelch	Normal squelch
Repeater/Talk-around	Without using a repeater	Using a repeater

## CONTENTS

### INTRODUCTION

TRANSCEIVER DETAILS

LED INDICATOR

PROGRAMMABLE BUTTON

BEEPS

### GETTING STARTS

BATTERY INFORMATION

INSTALLING BATTERY PACK

REMOVAL OF BATTERY

INSTALLING THE ANTENNA

REMOVING THE ANTENNA

ATTACHING THE BELT CLIP

REMOVING THE BELT CLIP

### BASIC OPERATION

SWITCHING POWER ON/OFF

ADJUSTING THE VOLUME

SELECTING A CHANNEL

TRANSMITTING A MESSAGE

RECEIVING A MESSAGE

## CONTENTS

### ADVANCED OPERATION

REPEATER/TALK-AROUND

SETTING SQUELCH LEVEL FOR TIGHT OR NORMAL

SELECTING OUTPUT POWER

HANDSFREE TRANSMISSION (VOX)

### SCAN

SCAN MODEL

SCAN OPERATION

TALKBACK

DELETE A NUISANCE CHANNEL

TO RESTORE THE DELETED CHANNEL TO THE SCAN LIST

PRIORITY FUNCTION

## Introduction

### TRANSCEIVER DETAILS

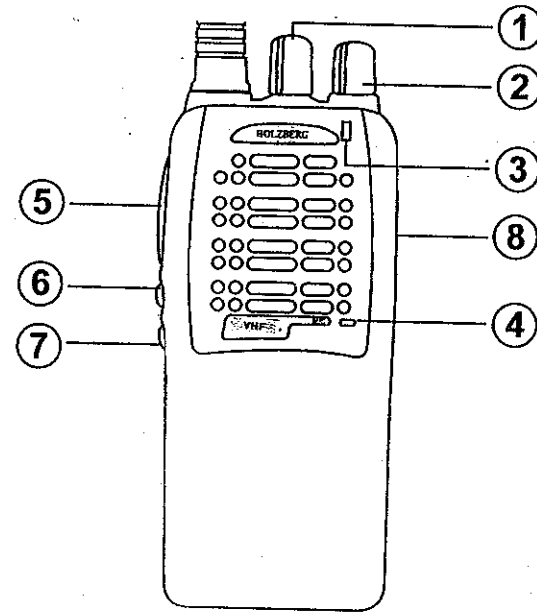

**① Channel Selector Knob**

Selects operating channels.

**② Power/Volume Knob**

Switches the transceiver ON or OFF. Also increases or decreases the transceiver volume.

## Introduction

### ③ LED Indicator

Indicate radio's status

LED indicate / color	Explain
Light "RED" continuously	Transmitting a message
Light "GREEN" continuously	Receiving a signal
"GREEN" flash	Scanning
Light "ORANGE" continuously	A matching sub-tones code is received. It can be a CTCSS code or DCS code.

### ④ Microphone

Hold radio upright while speaking clearly into the microphone.

### ⑤ PTT (Push-to-Talk) Button

This button is used to switch between transmission and reception. To transmit, hold in this button. To receive, just release this button.

### ⑥ Side Button 1 (Programmable)

### ⑦ Side Button 2 (Programmable)

There are two Side Button in your radio and they can be programmed with different function by your dealer.

Please contact your dealer to know what function programmed for your side button.



## Introduction

Press the side button as one of three methods of operation:

- **SHORT** means click the button then release it, or
- **LONG** means press the button for the long time then release it, your dealer may programmed the long time different, or
- **HOLD** down the button, while you need check the status of radio or adjust the radio's parameter, just hold down the button.







You may operate the side button as **SHORT** or **LONG** to activate one of its functions, but not two for once pressing.

Button Function	SHORT/LONG	HOLD
Monitor	-	Monitor activity on your selected channel
Scan	To starts scanning from current channel or quit scanning	-
Nuisance Delete	When radio is scanning, you can temporary remove the unwanted channel from the scan list.	-
Power	The output power is toggled between low and high.	-
Repeater/Talk-around	Using a repeater or allow communication direct with other transceivers without using a repeater.	-
Squelch	To toggle the squelch level between normal and tight.	-

### ⑧ Accessory Connector Cap

## Introduction

### BEEP

1. Power ON Self Tests Success Beep 
2. Power ON Self Tests Failure Beep 
3. VOX Power ON Beep ( High Sensitivity ) 
4. VOX Power ON Beep ( Low Sensitivity ) 
5. Positive Beep 
6. Negative Beep 

Note:  Mark means high voice beep.

 Mark means low voice beep

## Introduction

### Beep for Side Button

Some beeps of the programmed **Side Button** are exchangeable, it means the function are exchangeable.

Side Button Function	Positive Beep	Negative Beep
Scan	Start scanning	Quit scan mode
Power	High output power	Low output power
Squelch	Tight squelch	Normal squelch
Repeater/Talk-around	Without using a repeater	Using a repeater

## BATTERY INFORMATION

### FOR LONGEST BATTERY LIFE AND USING KNACKS

There is one type of rechargeable battery that can be used as the power supply; it is nickel metal hydride (NiMH).

To assure the highest performance and longest cycle life, should you properly use the battery pack comply with following simple rules:

- To enable you to obtain maximum battery capacity, a new battery must be fully charged for at least 14 to 16 hours continuously.
- Using a non- Kyosey brand charger may damage your battery, also will expire its warrant.

## Getting Started

- You can charge the battery that is connected to a transceiver, but please turn the radio off to fully charge it.
- If possible, store and charge the battery at a room temperature (25°C). Do not charge a cold battery that is at 10°C or below, if so may cause the battery to leak and become an inefficient battery.
- Don't charge a hot battery that is at above 35°C. This will decrease cycle life.  
Note: The Kyosey brand Quick Charger built-in a temperature sensor to ensure your battery charged within above temperature range.
- New batteries can be stored up to two years without significant cycle loss. Store new / unused batteries at room temperature in a cool, dry area.
- A battery that has been in storage should be recharged at least 14 to 16 hours continuously before being put into service.
- Don't return fully charged batteries to the charger for an "extra boost." This will significantly reduce cycle life.
- Don't leave your transceiver and battery in the charger when not charging. Continuous charging will shorten battery life (Don't use your charger as a transceiver stand).
- For optimum battery life and operation, use Kyosey brand chargers only. Our batteries and chargers have been designed to operate as an integrated energy system.

## Getting Started

### INSTALLING BATTERY PACK

1. Put the battery pack onto the bottom of the transceiver.
2. Gently push the battery pack toward the transceiver back edge until you hear a click.

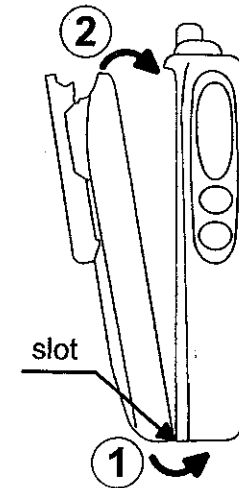

### REMOVAL OF BATTERY

1. Before removing the battery, you must turn the radio off.
2. Press down the battery release button located in the back of the battery pack.
3. Remove the upside of the battery pack separate from the transceiver body and take away then.

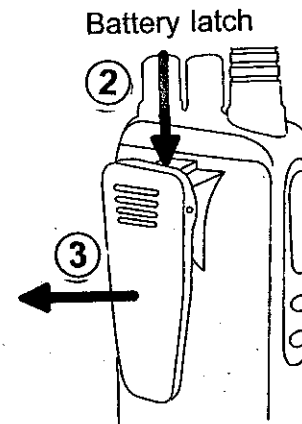

## Getting Started

### INSTALLING THE ANTENNA

Fasten the antenna to the radio by placing the threaded end of the antenna into the antenna connector. Rotate the antenna clockwise until tight.



### REMOVING THE ANTENNA

Turn the antenna in an anti-clockwise direction until it disengages from the transceiver.

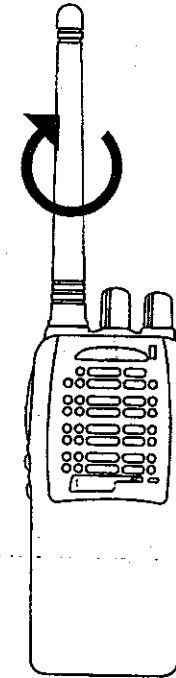

## Getting Started

### ATTACHING THE BELT CLIP

1. Align mounting rails of the radio with the grooves of belt clip.
2. Slide the belt clip downwards until it clicks into place.

### REMOVING THE BELT CLIP

1. Insert the end of a key to push the release tab of radio away.
2. Slide the belt clip upwards.

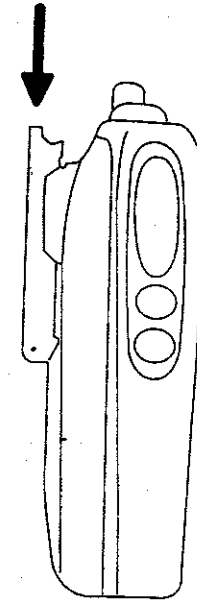
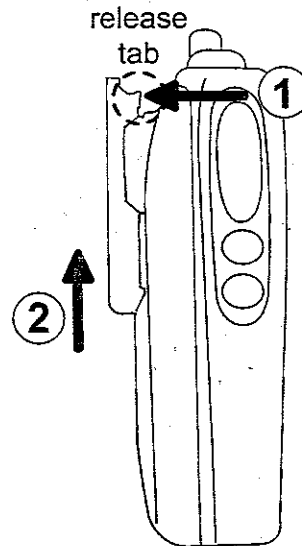

## Getting Started

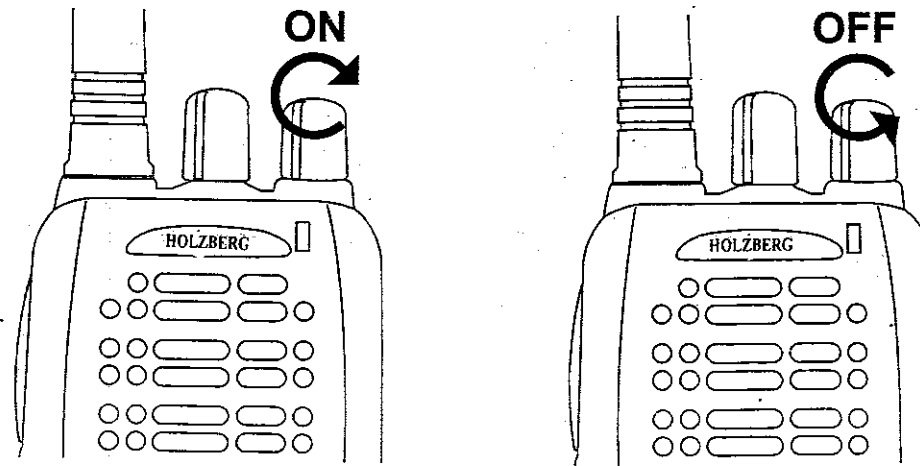

### WITCHING POWER ON/OFF

- To switch ON your transceiver, rotate the **Power/Volume Knob** clockwise. If the transceiver works proper, **LED Indicator** will light GREEN, then RED and finally OFF, and you can hear the Self-Tests success beep, otherwise the Self-Tests failure beep may be heard.
- To switch OFF the transceiver, turn the **Power/Volume Knob** fully anti-clockwise until a "click" is heard.

### ADJUSTING THE VOLUME



## Basic Operations

- If there is no receive audio, you need hold down the **Monitor** button to open the squelch, so you can hear background noise.
- Continue to hold the **Monitor Button** and rotary the **Power/Volume Knob** to desired volume level, turn clockwise to increase or anti-clockwise to reduce the volume.
- Release the **Monitor Button**.

### SELECTING A CHANNEL

The 16-channel provide for regular operating channel. Use the **Channel Selector Knob** to choose your desired channel. You should not select a channel unless it is programmed in the transceiver. Your dealer can best explain how channel had programmed.

- Rotate the **Channel Selector Knob** to select your desired channel number.

### TRANSMITTING A MESSAGE

1. Turn ON your transceiver.
2. Rotate the **Channel Selector Knob** to select a desired channel.
3. Press and hold down **PTT**, hold the transceiver about 2.5 ~ 5cm (1 to 2 inches) from your lips to microphone and speak in your normal speaking voice.
4. Release the **PTT** button to return to the receive mode.

## Basic Operations

### RECEIVING A MESSAGE

1. Turn your transceiver ON.
2. Adjust the volume
3. Select a desired channel
4. When a signal with proper or matching sub-tones is received, you will hear the transmissions from other transceivers; you may need to adjust the volume more precisely.

## Advanced Operations

### REPEATER/TALK-AROUND

At following condition, the Talk-around function will make you can talk directly to other transceiver without using a repeater:

- If the repeater is deactivate, or
- You are out of the repeater range, but you can directly talk to other transceiver.

To toggle Talk-around ON or OFF, your dealer must program a **Side Button** for the “**Repeater/Talk-around**” function.

Pressing the **Repeater/Talk-around** button, if you hear the **Positive Beep**, your transceiver is without using a repeater.

Others, for the **Negative Beep**, your transceiver is using a repeater.

### SETTING SQUELCH LEVEL

Squelch acts as a kind of filtering system, which control the amount of signals the transceiver receives. Setting the transceiver to the **Tight Squelch**, you can avoid some unwanted signals or noise. But you may not receive a weak signal far from you. So you should select the **Normal Squelch** for it.

Pressing the **Squelch** button to select the squelch level between **Tight** and **Normal**.

- The **Positive Beep** means your transceiver is **Tight Squelch**.
- The **Negative Beep** means your transceiver is **Normal Squelch**.

### SELECTING OUTPUT POWER

Each channel independently programmed for either low power or high output power. However, you can change the output power by yourself.

- With high output power, your signal may transmit farther.
- Selecting low power conserves the battery if you can reliably communicate with others.

## Advanced Operations

Each time you pressing the **Power Button**, the output power is toggle between **LOW** and **HIGH**.

- The **Positive Beep** means output power is **HIGH**.
- The **Negative Beep** means output power is **LOW**.

### HANDSFREE TRANSMISSION (VOX)

VOX (Voice Operated eXchange) is an automatic system witch allows you to automatically switch the transmission in hands free mode just by speaking in the built-in microphone of a headset.

### VOX OPERATIONS

To set your transceiver's VOX active or disable, you have to:

1. Turn OFF your radio, then
2. Switch on the radio while holding press the **Side Button 1**.
3. Connect the optional headset with built-in microphone to the microphone connector located on the transceiver's side.
4. Ensure that the headset's built-in microphone is located close to the side of your mouth.

None: **PTT** button is disabled during VOX.

### SELECTING VOX SENSITIVITY

To change the VOX sensitivity between low and high, you should

1. Turn OFF your radio, then
2. Switch on the radio keeping pressed the **Side Button 2**.
3. The beep tone will tell you that the VOX sensitivity is high or low

## Advanced Operations

### SCAN

Scan operation tells the radio to monitor a number of channels where are some activities. Your dealer can program more than 16 channels on the scan list.

When scanning, the transceiver checks each channel for activity and only stops on a channel if a signal is present.

### SCAN OPERATION

To toggle scan ON/OFF by using the **Side Button** which programmed for **"SCAN"**.

1. Press the **"SCAN"** button to begin scanning.
2. Press the **"SCAN"** button to stop scanning while the radio works at scan model.

Note: The **LED Indicator** flashes the **GREEN** when scanning.

### TALKBACK

If the "Talkback" function is active, direct you can communicate with others who call you just before the scan resume time finish. Your dealer may tell you more detail about this function.

### DELETE A NUISANCE CHANNEL

When the transceiver scans to a channel that you do not wish to hear, you can temporarily remove the channel from the scan list using the Nuisance Channel Delete feature.

While the transceiver locked onto unwanted channel, press the **"Nuisance Delete"** Button until you hear two beeps.

## Advanced Operations

Note: If the **priority** function is active by your dealer, you cannot remove the priority channel from the scan list. The last channel cannot delete from the scan list too.

### TO ADD A DELETED CHANNEL

To add a deleted nuisance channel back into the scan list, you must

1. Turn OFF your radio, then
2. Switch on the radio and restart the "SCAN"

### PRIORITY FUNCTION

The priority function would spend more time to monitor the priority channel during scanning. Your dealer can program the priority function using the CPS software.

PRIORITY FUNCTION	SCAN SEQUENCE
Activity	ch1 à ch2 à ch3 à ch4 ... ch1
Inactivity	ch1 à ch2 à ch1 à ch3 à ch1 à ch4 à ch1

## Advanced Operations

### SAFETY TRAINING INFORMATION



WARNING

Your Kyosey radio generates RF electromagnetic energy during transmit mode. This radio is designed for and classified as "Occupational Use Only", meaning it must be used only during the course of employment by individuals aware of the hazards, and the ways to minimize such hazards. This radio is NOT intended for use by the "General Population" In an uncontrolled environment.



**CAUTION** To ensure that your exposure to RF electromagnetic energy is within the FCC allowable limits for occupational use, always adhere to the following guidelines:

- DO NOT operate the radio without a proper antenna attached, as this may damage the radio and may also cause you to exceed FCC RF exposure limits. A proper antenna is the antenna supplied with this radio by the manufacturer or an antenna specifically authorized by the manufacturer for use with this radio.
- DO NOT transmit for more than 50% of total radio use time("50% duty cycle"). Transmitting more than 50% of the time can cause FCC RF exposure compliance requirements to be exceeded. The radio is transmitting when the "TX indicator" lights red. You can cause the radio to transmit by pressing the "PTT" switch
- ALWAYS use Kyosey authorized accessories(antennas, batteries, belt clips, speaker/mics, etc). Use of unauthorized accessories can cause the FCC RF exposure compliance requirements to be exceeded.
- ALWAYS keep the antenna at least 2.5 cm (1 inch) away from the body when transmitting and only use the provided clips

## Advanced Operations

when attaching the radio to your belt, etc....to ensure FCC RF exposure compliance requirements are not exceeded. To provide the recipients of your transmission the best sound quality, hold the antenna at least 5 cm (2 inches) from mouth, and slightly off to one side.

The information listed above provides the user with the information needed to make him or her aware of RF exposure, and what to do to assure that this radio operates within the FCC RF exposure limits of this radio.

### **Electromagnetic Interference/Compatibility**

During transmissions, your Kyosey radio generates RF energy that can possibly cause interference with other devices or systems. To avoid such interference, turn off the radio in areas where signs are posted to do so. DO NOT operate the transmitter in areas that are sensitive to electromagnetic radiation such as hospitals, aircraft, and blasting sites.