

Antenna Composite Gain Test Report

1. Test Information

Equipment	Campus Access Points
Brand Name	Aruba
Model Name	Blackbird
Applicant	Aruba
Manufacturer	Aruba

2. Testing Location

Testing Location	
WNC	ADD : 20 Park Ave. II, Hsinchu Science Park, Hsinchu 308 Taiwan

Test Condition	Test Engineer	Test Environment (°C / %)	Test Date
Radiated	Roye Chen	20-24 / 45-60	06.26.2023~07.03.2023

3. Test Frequency

Frequency (MHz) Uplink / Downlink	Test Frequency (MHz)
698~716 / 728~746(B12)	707 / 737
777~787 / 746~756(B13)	782 / 751
824~849 / 869~894(B5)	837 / 882
880~915 / 925~960(B8)	898 / 943
1710~1785 / 1805~1880(B3)	1748 / 1843
1710~1755 / 2110~2155(B4)	1733 / 2133
1850~1910 / 1930~1990(B2)	1880 / 1960
1920~1980 / 2110~2170(B1)	1950 / 2140
2300~2400 / 2300~2400(B40)	2350 / 2350
2400-2480	2450
2500~2570 / 2620~2690(B7)	2535 / 2655
5150-5250	5150
5470-5725	5550
5725-5850	5850
5850~5895	5895
5925-6425	5925
6425-6525	6500
6875-7125	7000

4. Antenna Information

Ant. Position	Brand Name	Model Name	Ant. Type	Connector
Antenna 1 (2G/5G)	Aruba	95XEAK15.GAH	PIFA	I-PEX
Antenna 2 (2G/5G)	Aruba	95XEAK15.GAI	PIFA	I-PEX
Antenna 3 (2G/6G)	Aruba	95XEAK15.GAJ	Dipole	I-PEX

Antenna 4 (2G/6G)	Aruba	95XEAK15.GAK	Dipole	I-PEX
Antenna 5 (Main)	Aruba	95XEAK15.GAL	PIFA	I-PEX
Antenna 6 (Aux)	Aruba	95XEAK15.GAM	PIFA	I-PEX
Antenna 7 (BLE)	Aruba	95XEAK15.GAN	PIFA	I-PEX

5. Test Configuration

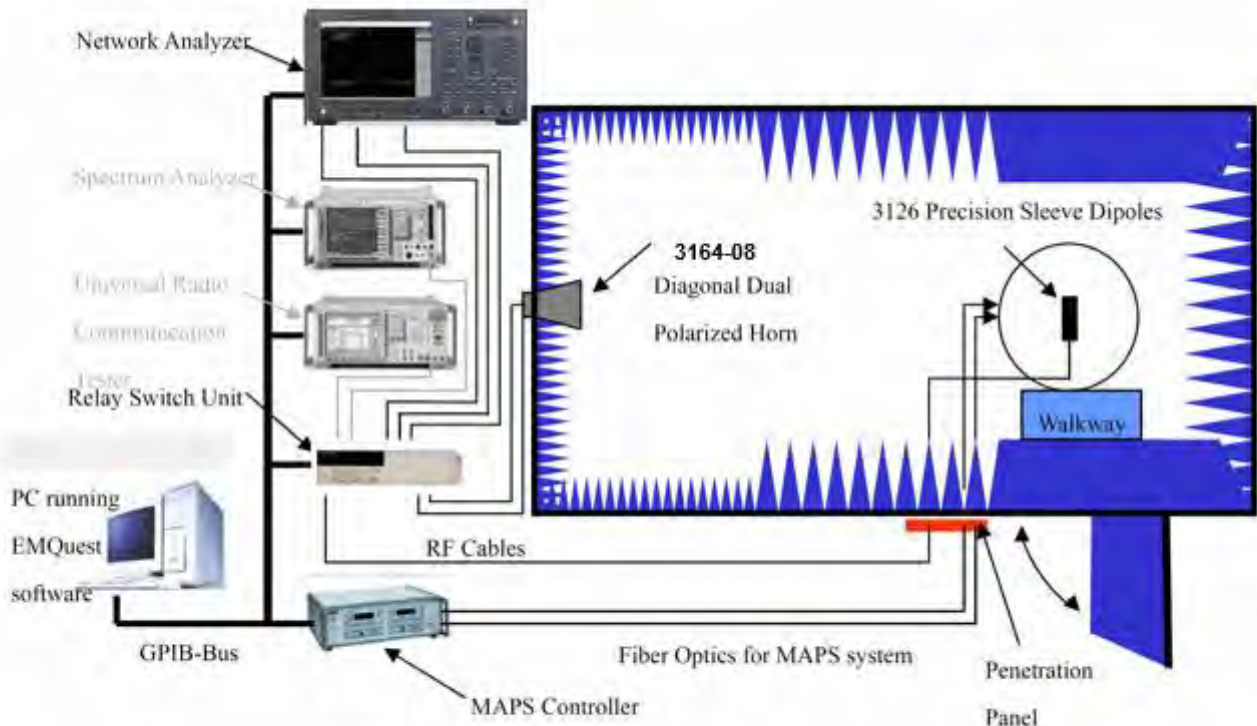

ETS-AMS 8500 System

Item	Device	Type/Model	Serial#	Manufacturer	Cal. Date	Cal. Due Date
1	Anechoic Chamber	ETS-AMS	8500	ETS-Lindgren	2023/03/09	2024/03/08
2	Turn Table	ETS		ETS-Lindgren	2023/03/09	2024/03/08
3	Multi-Device Positioning Controller	Model 2090	142407	ETS-Lindgren	2023/03/09	2024/03/08
4	Network Analyzer	E5071C	0171E5485A6J	Keysight	2023/05/31	2024/05/30
5	Horn antenna	3164-08	140264	ETS-Lindgren	2023/03/09	2024/03/08
6	Cable 7.5m 400MHz to 18GHz (H-pol)	SS402	00100A1F5A1XXS	Woken	2023/03/09	2024/03/08
7	Cable 7.5m 400MHz to 18GHz (V-pol)	SS402	00100A1F5A1XXS	Woken	2023/03/09	2024/03/08
8	Cable 14m 400MHz to 18GHz	SS402	00100A1F5A1XXS	Woken	2023/03/09	2024/03/08
9	Temperature & Humidity Meter	HTC-01		Metravi	2023/03/09	2024/03/08

6. Reference Calibration

Range Calibration Configuration (Passive)

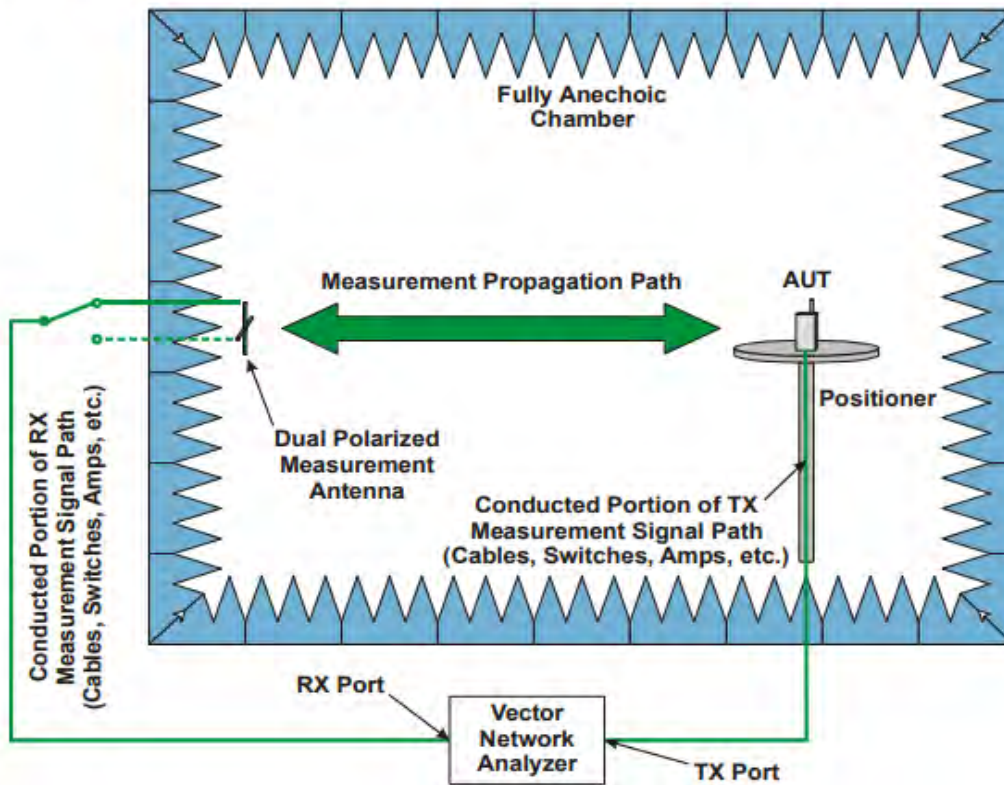

7. Test Method

The “great circle” cut method, whereby the Measurement Antenna remains fixed and the EUT is rotated about two axes in sequential order. The radiated RF performance of the Equipment Under Test (EUT) is measured by sampling the radiated transmit power of the mobile at various locations surrounding the device. A three-dimensional characterization of the 'transmit' performance of the EUT is pieced together by analyzing the data from the spatially distributed measurements.

Data points taken every 15 degrees in the theta and in the phi axes are deemed sufficient to fully characterize the EUT's Far-Field radiation pattern and total radiated power. All of the measured power values will be integrated.

8. Measured Values and Calculation of Correlated / Uncorrelated Gains

Antenna Peak Gain Table (Ant. Position : 2G/5G Ant.1~2)

Band (MHz)	2400-2480
Frequency (MHz)	2450
Ant.1 Max Gain (dBi)	2.8
Ant.2 Max Gain (dBi)	3.1
Max Gain (dBi)	3.1

Band (MHz)	5150-5470	5470-5725	5725-5850	5850~5895
Frequency (MHz)	5150	5550	5850	5895
Ant.1 Max Gain (dBi)	3.4	4.8	4.1	4.1
Ant.2 Max Gain (dBi)	4.4	5.6	6.0	5.8
Max Gain (dBi)	4.4	5.6	6.0	5.8

Antenna Peak Gain Table (Ant. Position : 2G/6G Ant.3~4)

Band (MHz)	2400-2480
Frequency (MHz)	2450
Ant.3 Max Gain (dBi)	3.8
Ant.4 Max Gain (dBi)	1.9
Max Gain (dBi)	3.8

Band (MHz)	5925-6425	6425-6525	6525-7125
Frequency (MHz)	5925	6500	7000
Ant.3 Max Gain (dBi)	5.2	3.2	3.4
Ant.4 Max Gain (dBi)	4.0	4.6	4.0
Max Gain (dBi)	5.2	4.6	4.0

Antenna Peak Gain Table (Ant. Position : LTE Main Ant.5)

Band (MHz)	Frequency (MHz)	Max Gain (dBi)
698~716 / 728~746(B12)	707 / 737	1.7 / 3.0
777~787 / 746~756(B13)	782 / 751	1.6 / 2.9
824~849 / 869~894(B5)	837 / 882	0.1 / -0.7
880~915 / 925~960(B8)	898 / 943	-0.5 / -1.3
1710~1785 / 1805~1880(B3)	1748 / 1843	3.7 / 2.5
1710~1755 / 2110~2155(B4)	1733 / 2133	4.0 / 1.9
1850~1910 / 1930~1990(B2)	1880 / 1960	2.2 / 1.7
1920~1980 / 2110~2170(B1)	1950 / 2140	1.6 / 2.1
2300~2400 / 2300~2400(B40)	2350 / 2350	1.4 / 1.4
2500~2570 / 2620~2690(B7)	2535 / 2655	2.1 / 1.5

Antenna Peak Gain Table (Ant. Position : LTE Aux Ant.6)

Band (MHz)	Frequency (MHz)	Max Gain (dBi)
698~716 / 728~746(B12)	707 / 737	-1.9 / -0.5
777~787 / 746~756(B13)	782 / 751	0.5 / -0.3
824~849 / 869~894(B5)	837 / 882	0.4 / -0.7
880~915 / 925~960(B8)	898 / 943	-1.1 / -3.4
1710~1785 / 1805~1880(B3)	1748 / 1843	1.3 / 2.2
1710~1755 / 2110~2155(B4)	1733 / 2133	1.3 / 3.0
1850~1910 / 1930~1990(B2)	1880 / 1960	2.1 / 1.3

1920~1980 / 2110~2170(B1)	1950 / 2140	1.4 / 2.5
2300~2400 / 2300~2400(B40)	2350 / 2350	4.0 / 4.0
2500~2570 / 2620~2690(B7)	2535 / 2655	3.7 / 4.3

Antenna Peak Gain Table (Ant. Position : BLE Ant.7)

Band (MHz)	2400-2480
Frequency (MHz)	2450
Max Gain (dBi)	2.3

Antenna Correlated / Uncorrelated Gain Table (Ant. Position : 2G/5G Ant.1~2)

Frequency (MHz)	Correlated Gain (dBi)	Uncorrelated Gain (dBi)
2450	5.0	2.1
5150	6.5	3.5
5550	6.3	3.5
5850	6.0	3.5
5895	6.2	3.6

Antenna Correlated / Uncorrelated Gain Table (Ant. Position : 2G/6G Ant.3~4)

Frequency (MHz)	Correlated Gain (dBi)	Uncorrelated Gain (dBi)
2450	4.8	2.0
5925	5.5	2.7
6500	6.0	3.1
7000	6.1	3.2

Because the antennas are fixed in location within the device the directional antenna gain for MIMO is calculated over a sphere using the raw spatial data taken at 5 degree steps of theta and phi for each antenna using the equations from KDB 662911 D01. The raw antenna data is located in the appendix of this report.

The correlated antenna gain was calculated using KDB 662911 D01, F(2)(d)(i). The uncorrelated antenna gain was calculated using KDB 662911 D01, F(2)(d)(ii).

The uncorrelated and correlated gains were calculated for each point in the spatial data, and the highest values reported.

Note :

KDB 662911 D01, F(2)(d)(i)

$$\text{Correlated Gain} = 10 \log \left[\left(10^{\frac{G_1}{20}} + 10^{\frac{G_2}{20}} + \dots + 10^{\frac{G_n}{20}} \right)^2 / N_{Ant.} \right] \text{ dBi}$$

KDB 662911 D01, F(2)(d)(ii)

$$\text{Uncorrelated Gain} = 10 \log \left[\left(10^{\frac{G_1}{10}} + 10^{\frac{G_2}{10}} + \dots + 10^{\frac{G_n}{10}} \right) / N_{Ant.} \right] \text{ dBi}$$

$N_{Ant.}$: Number of antenna

G_n : Gain of antenna

Maximum Correlated / Uncorrelated Gain Calculation (Ant. Position : 2G/5G Ant.1~2)

Frequency (MHz)	2450	5150
Ant.1 Gain (dBi)	0.8	2.4
Ant.2 Gain (dBi)	3.1	4.4
Phi (°)	5	240
Theta(°)	60	20
Corr. Ant. Gain (dBi) $[10^{(G_1/20)}+10^{(G_2/20)}]^2/N_{ANT.}$	3.2	4.5
Uncor. Ant. Gain (dBi) $[10^{(G_1/10)}+10^{(G_2/10)}]/N_{ANT.}$	1.6	2.3
Corr. Gain (dBi) $10 \cdot \log(\text{Corr. Ant. Gain})$	5.0	6.5
Uncor. Gain (dBi) $10 \cdot \log(\text{Uncor. Ant. Gain})$	2.1	3.5

(Ant. Position : 2G/6G Ant.3~4)

Frequency (MHz)	2450	7000
Ant.3 Gain (dBi)	3.5	2.5
Ant.4 Gain (dBi)	-0.4	3.8
Phi (°)	315	15
Theta(°)	0	45
Corr. Ant. Gain (dBi) $[10^{(G_1/20)}+10^{(G_2/20)}]^2/N_{ANT.}$	3.0	4.1
Uncor. Ant. Gain (dBi) $[10^{(G_1/10)}+10^{(G_2/10)}]/N_{ANT.}$	1.6	2.1
Corr. Gain (dBi) $10 \cdot \log(\text{Corr. Ant. Gain})$	4.8	6.1
Uncor. Gain (dBi) $10 \cdot \log(\text{Uncor. Ant. Gain})$	2.0	3.2

Note : Antenna gain is the correlated / uncorrelated gain position in the appendix gain table.

9. Test Setup

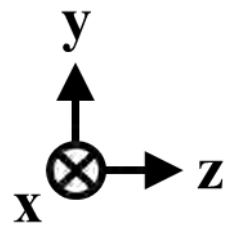

Note :
Top cover toward +Z direction

10. Radiation Pattern

Ant. Position : 2G/5G Ant.1~2

XY_Pol._Phi_Ant.1

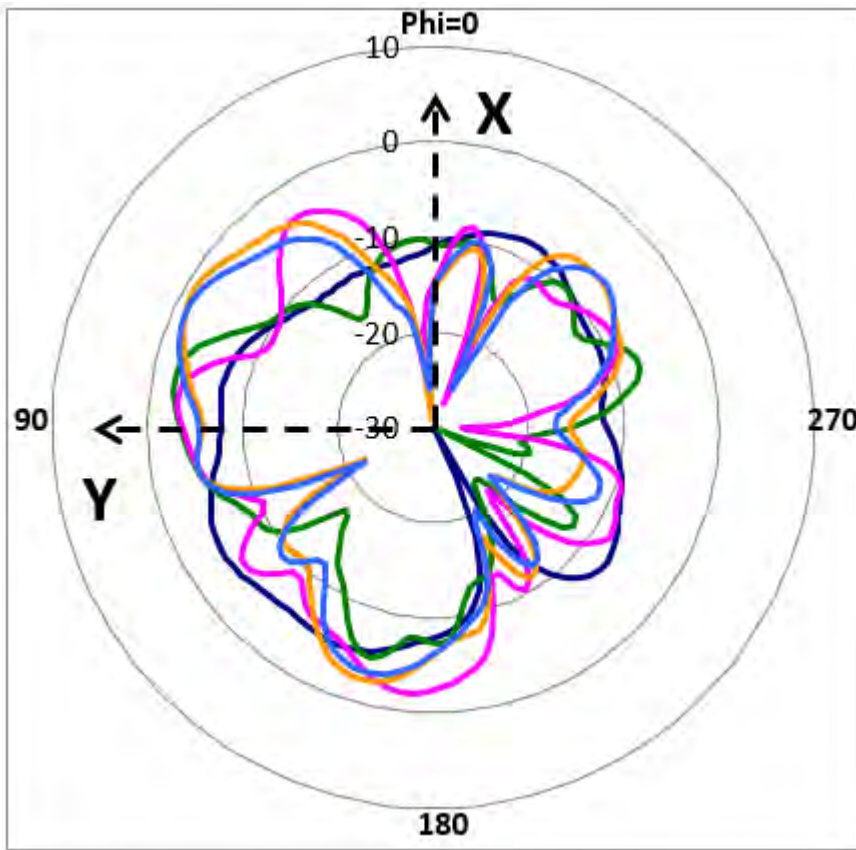

- 2450MHz_Gain_-4.25
- 5150MHz_Gain_-2.33
- 5550MHz_Gain_-1.99
- 5850MHz_Gain_-0.97
- 5895MHz_Gain_-1.28

XY_Pol._Phi_Ant.2

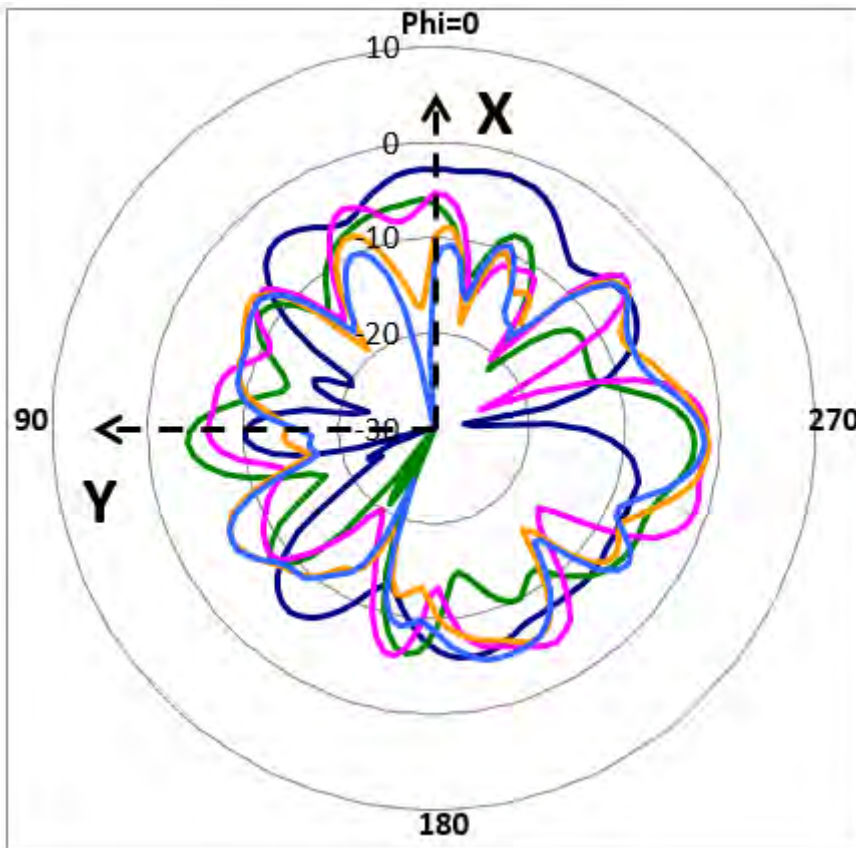

- 2450MHz_Gain_-2.34
- 5150MHz_Gain_-2.61
- 5550MHz_Gain_-1.28
- 5850MHz_Gain_-1.22
- 5895MHz_Gain_-1.57

XY_Pol._Theta_Ant.1

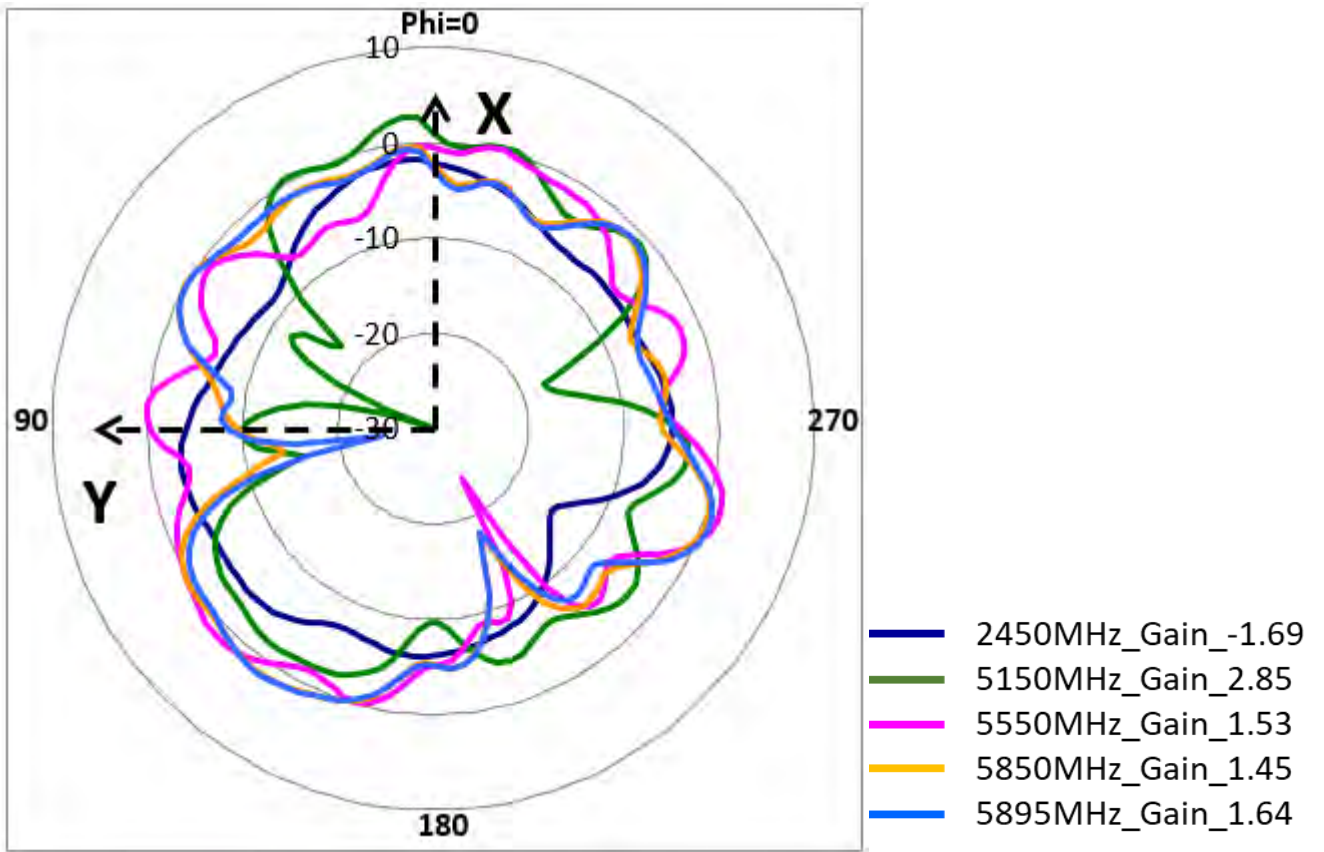

XY_Pol._Theta_Ant.2

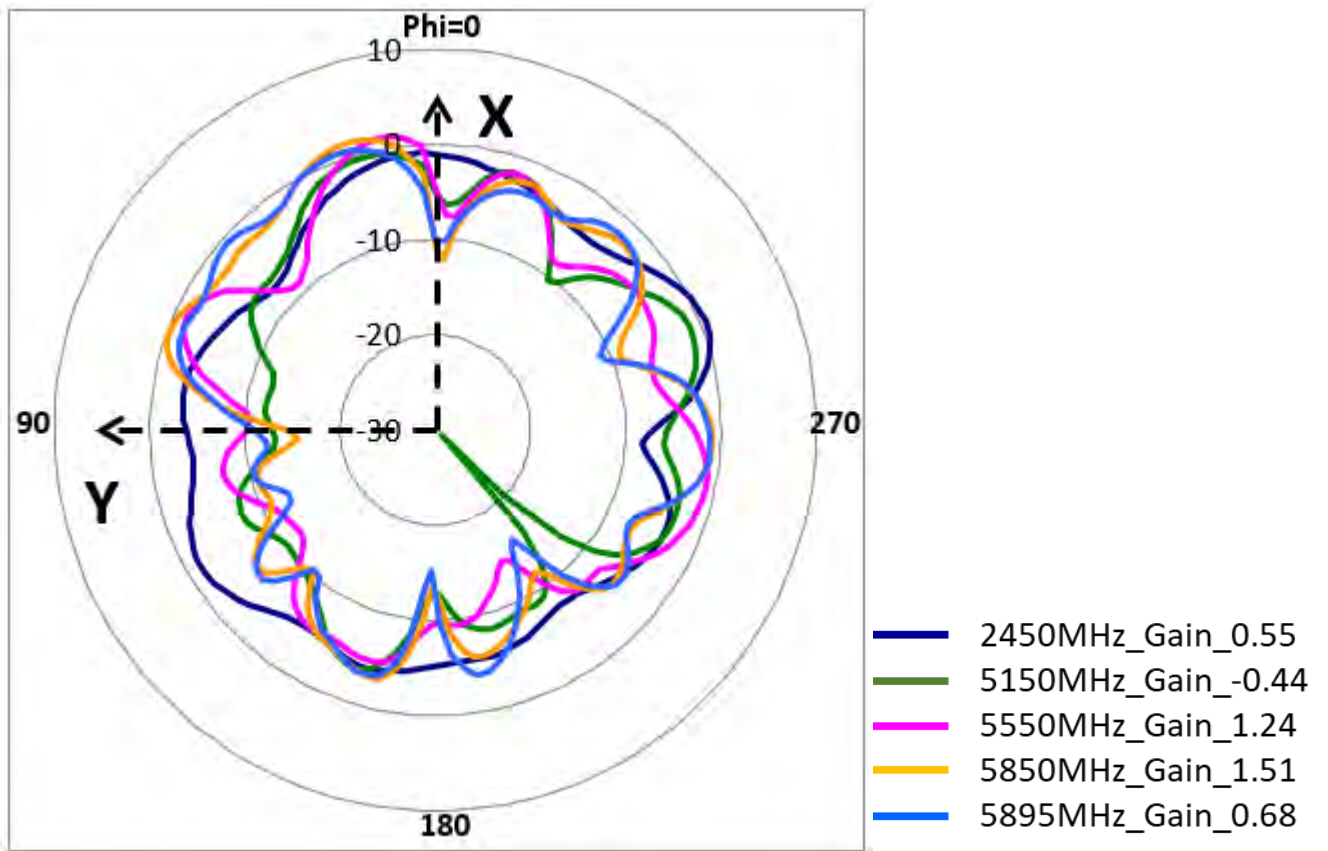

XZ_Pol._Phi_Ant.1

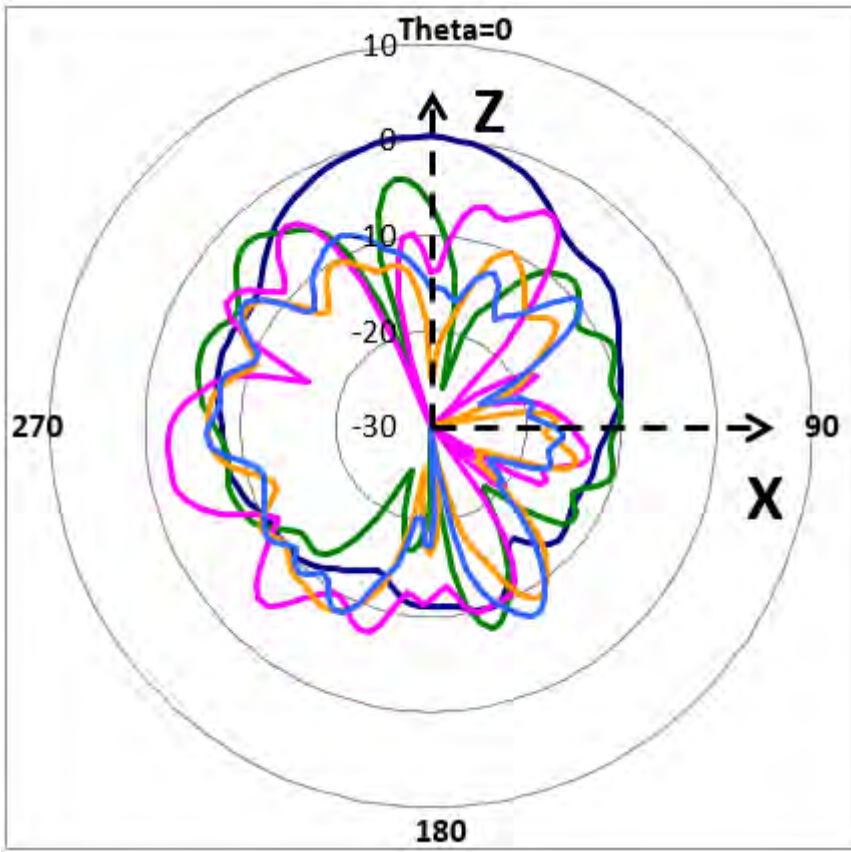

XZ_Pol._Phi_Ant.2

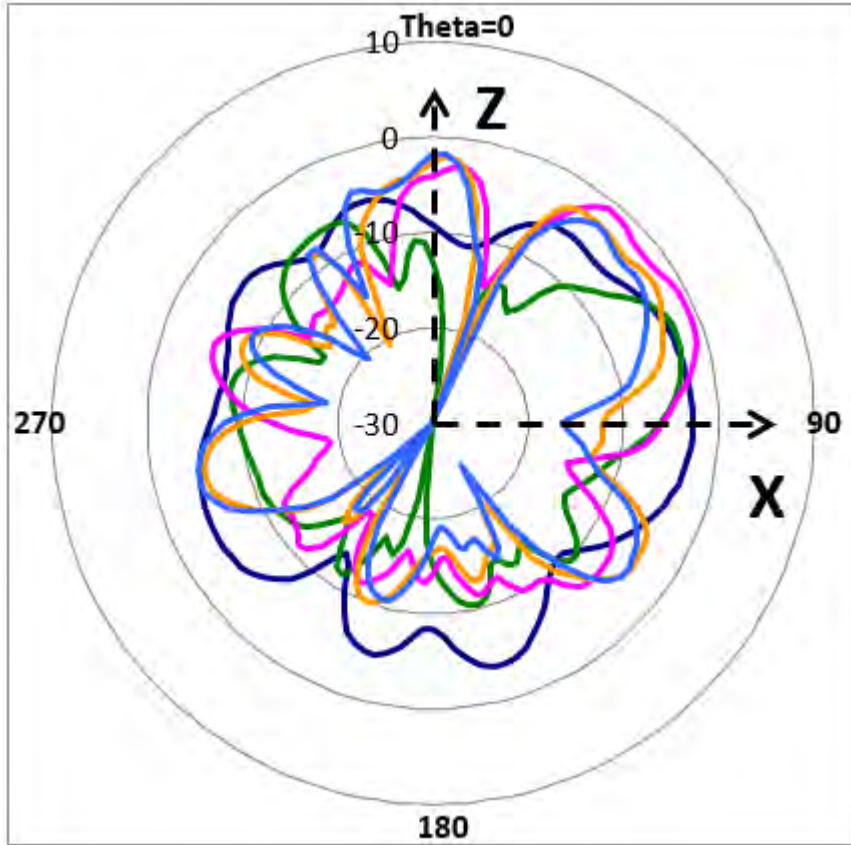

XZ_Pol._Theta_Ant.1

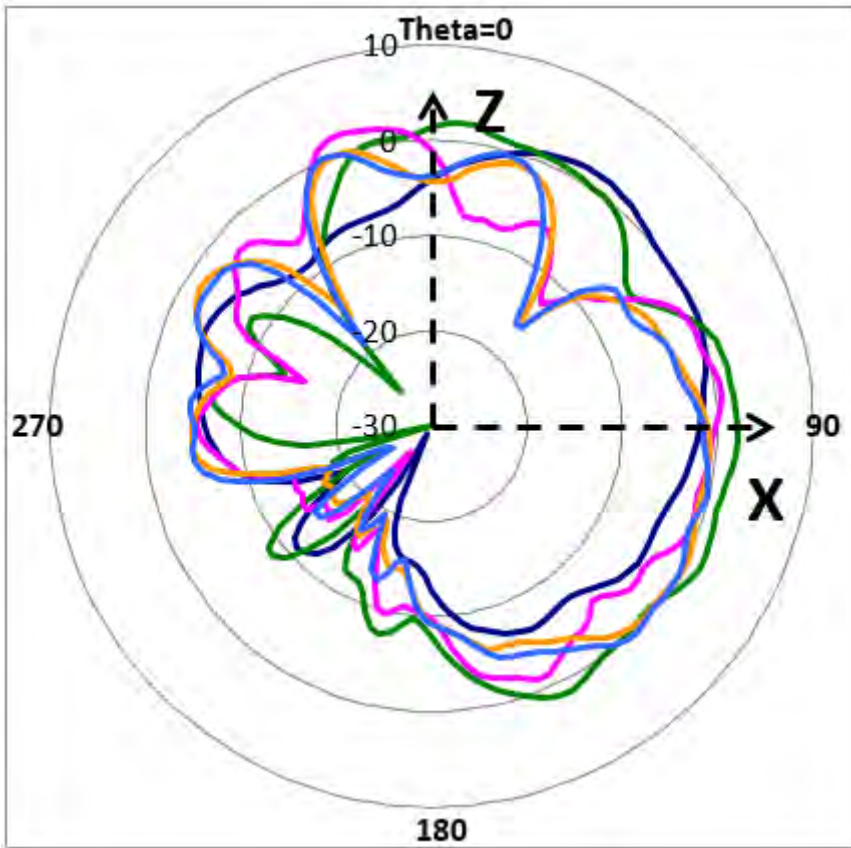

- 2450MHz_Gain_1.76
- 5150MHz_Gain_2.10
- 5550MHz_Gain_2.17
- 5850MHz_Gain_0.41
- 5895MHz_Gain_0.63

XZ_Pol._Theta_Ant.2

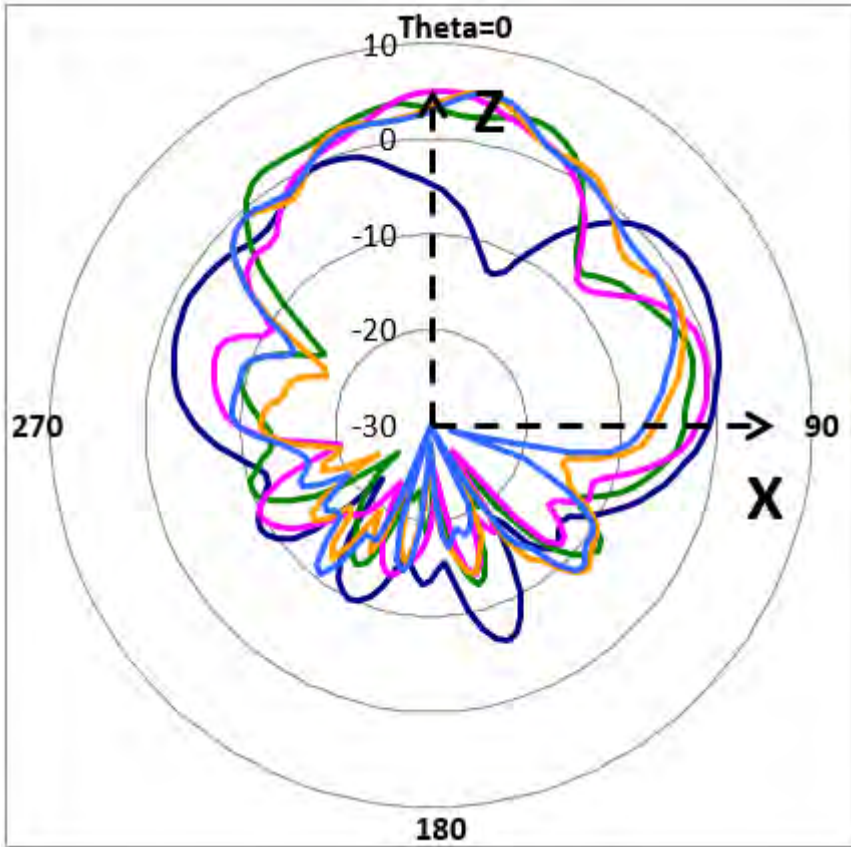

- 2450MHz_Gain_2.09
- 5150MHz_Gain_3.85
- 5550MHz_Gain_5.00
- 5850MHz_Gain_5.21
- 5895MHz_Gain_5.30

YZ_Pol._Phi_Ant.1

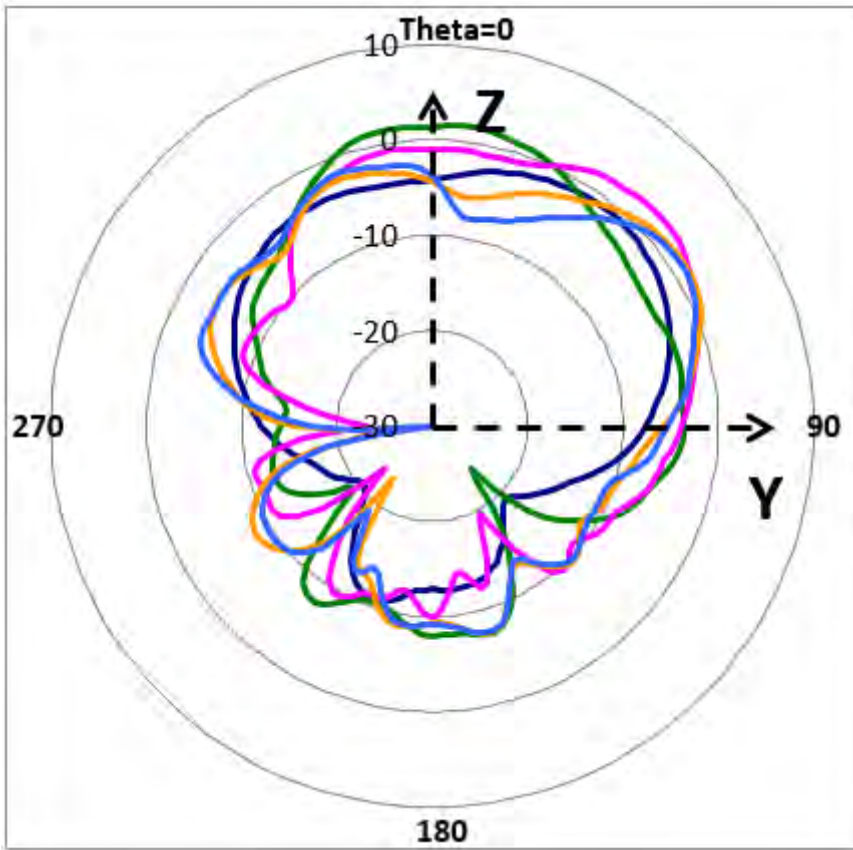

- 2450MHz_Gain_-0.84
- 5150MHz_Gain_1.61
- 5550MHz_Gain_2.54
- 5850MHz_Gain_1.50
- 5895MHz_Gain_1.17

YZ_Pol._Phi_Ant.2

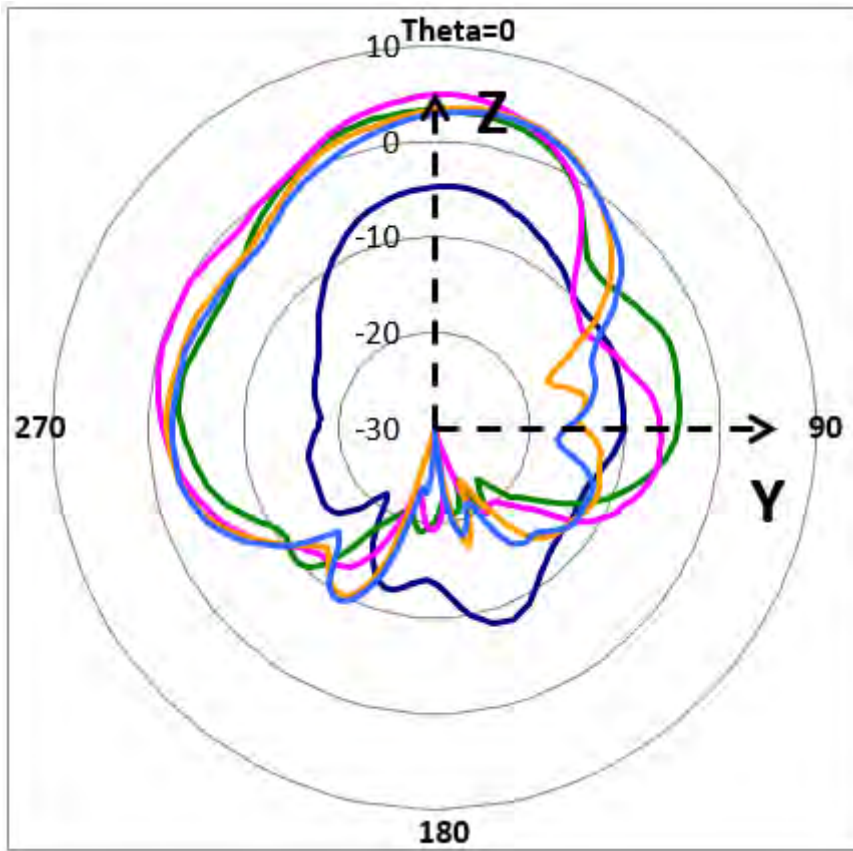

- 2450MHz_Gain_-4.62
- 5150MHz_Gain_3.31
- 5550MHz_Gain_5.04
- 5850MHz_Gain_3.77
- 5895MHz_Gain_3.39

YZ_Pol._Theta_Ant.1

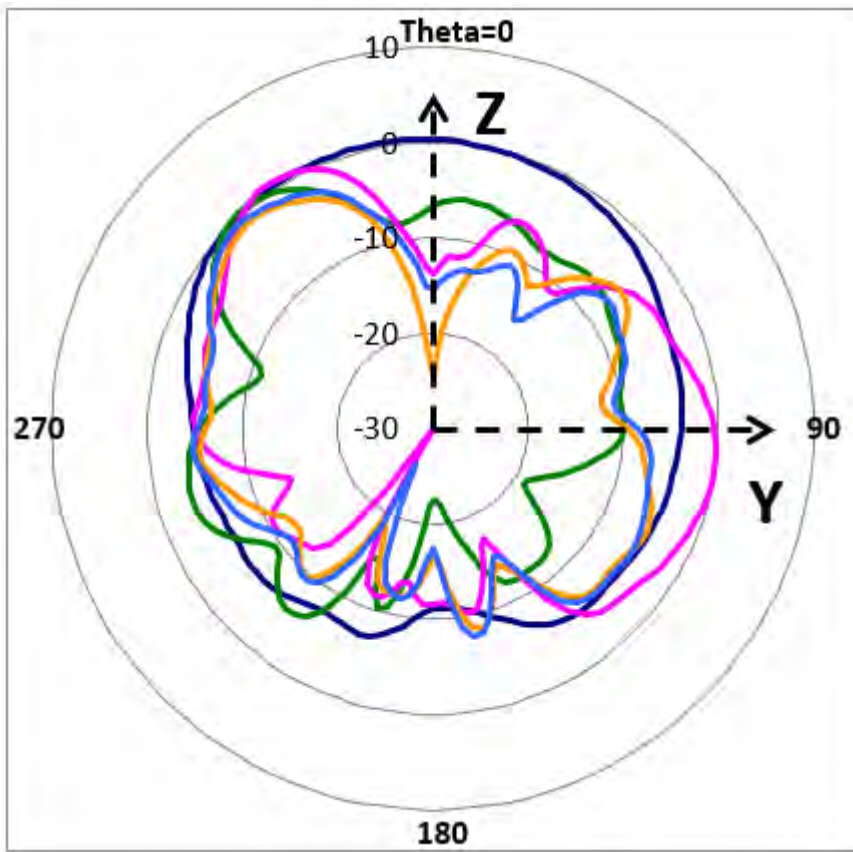

- 2450MHz_Gain_0.55
- 5150MHz_Gain_0.43
- 5550MHz_Gain_0.91
- 5850MHz_Gain_-1.09
- 5895MHz_Gain_-0.50

YZ_Pol._Theta_Ant.2

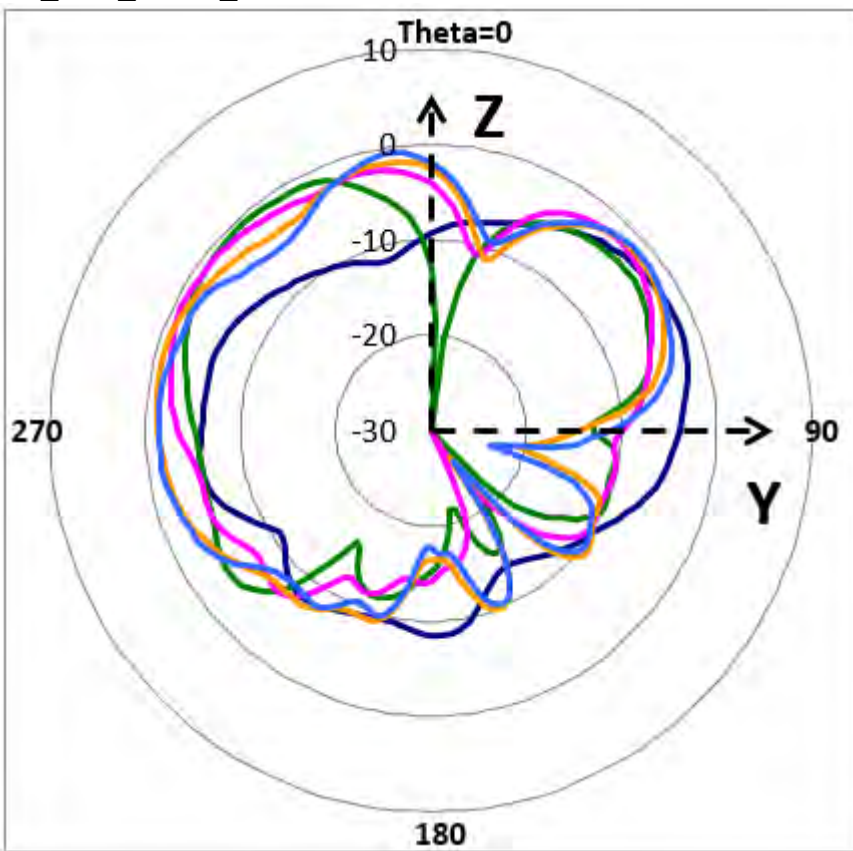

- 2450MHz_Gain_-1.78
- 5150MHz_Gain_-0.65
- 5550MHz_Gain_-0.84
- 5850MHz_Gain_-0.79
- 5895MHz_Gain_-0.59

Ant. Position : 2G/6G Ant.3~4

XY_Pol._Phi_Ant.3

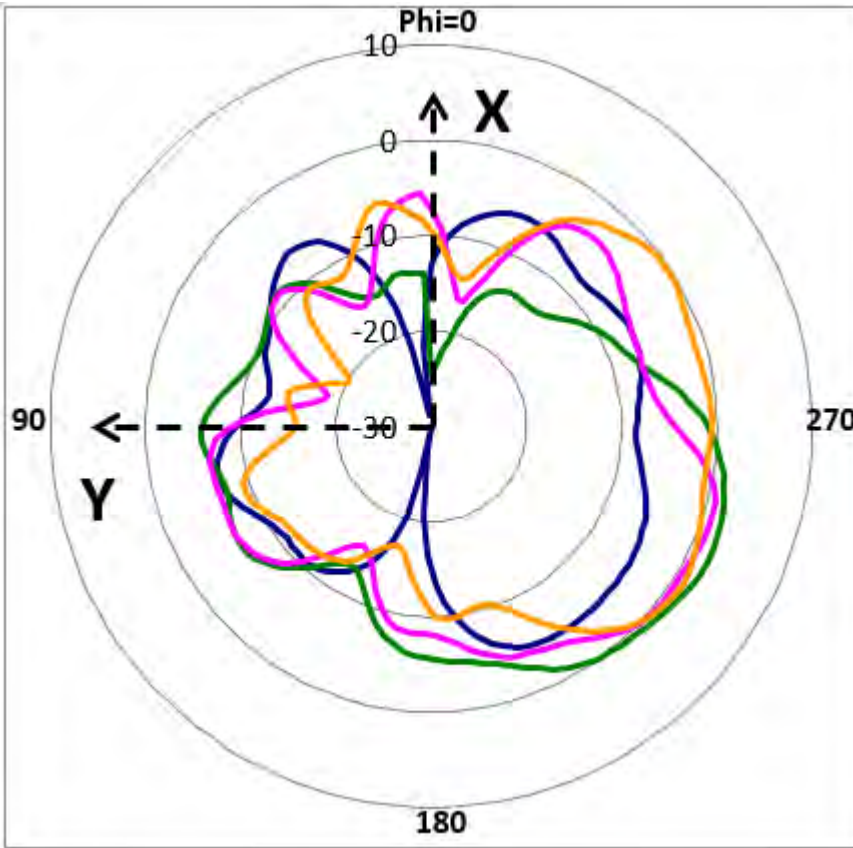

XY_Pol._Phi_Ant.4

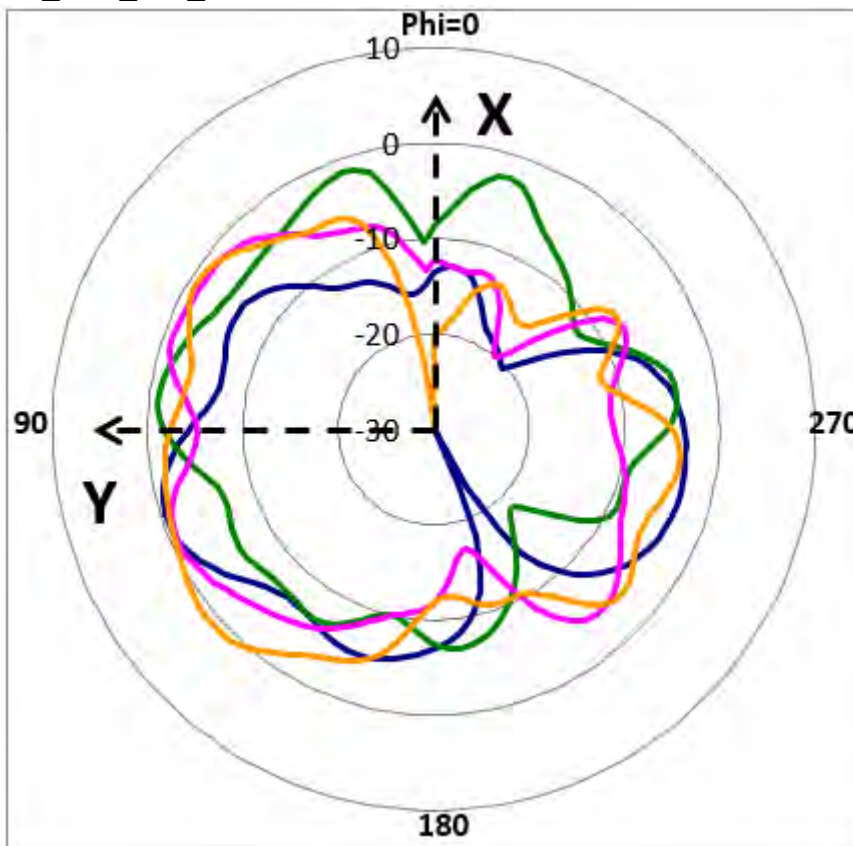

XY_Pol._Theta_Ant.3

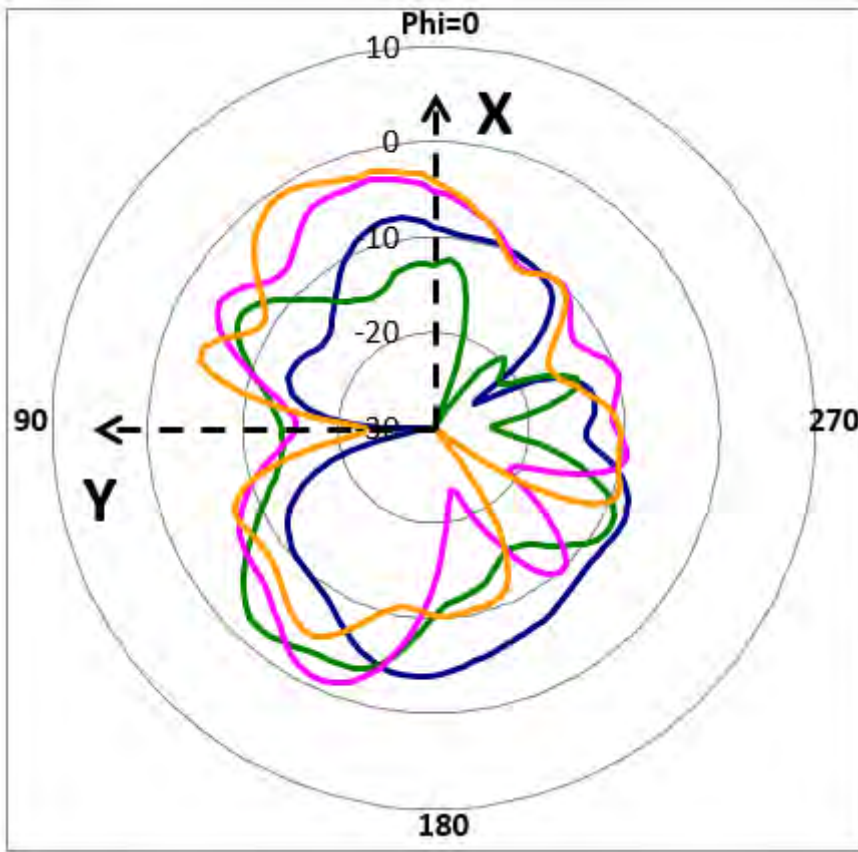

XY_Pol._Theta_Ant.4

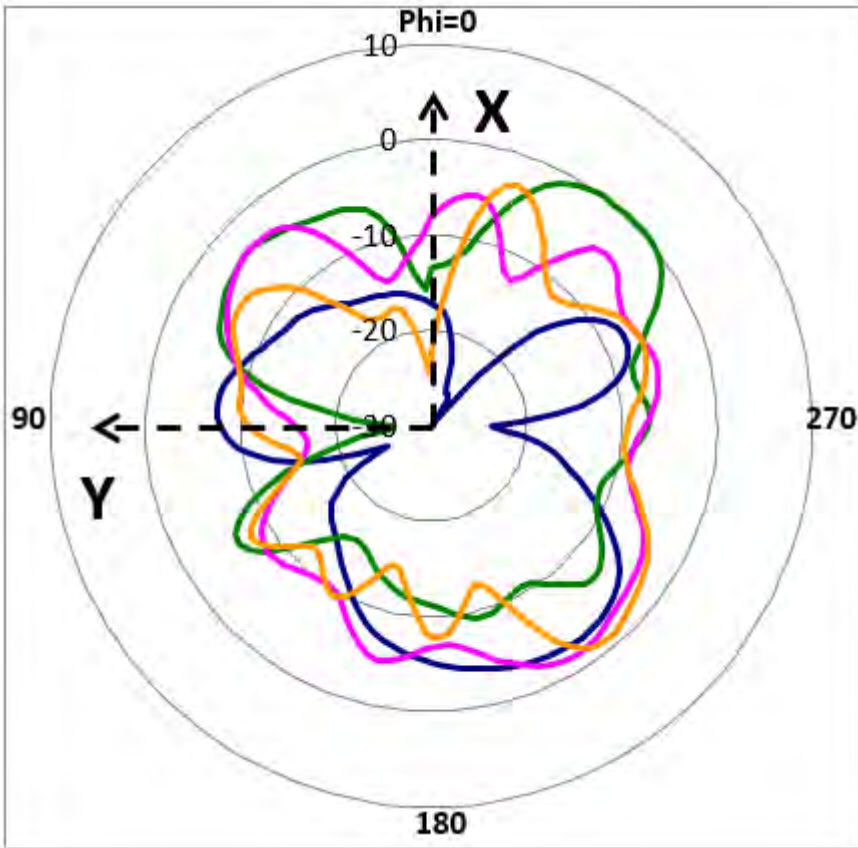

XZ_Pol._Phi_Ant.3

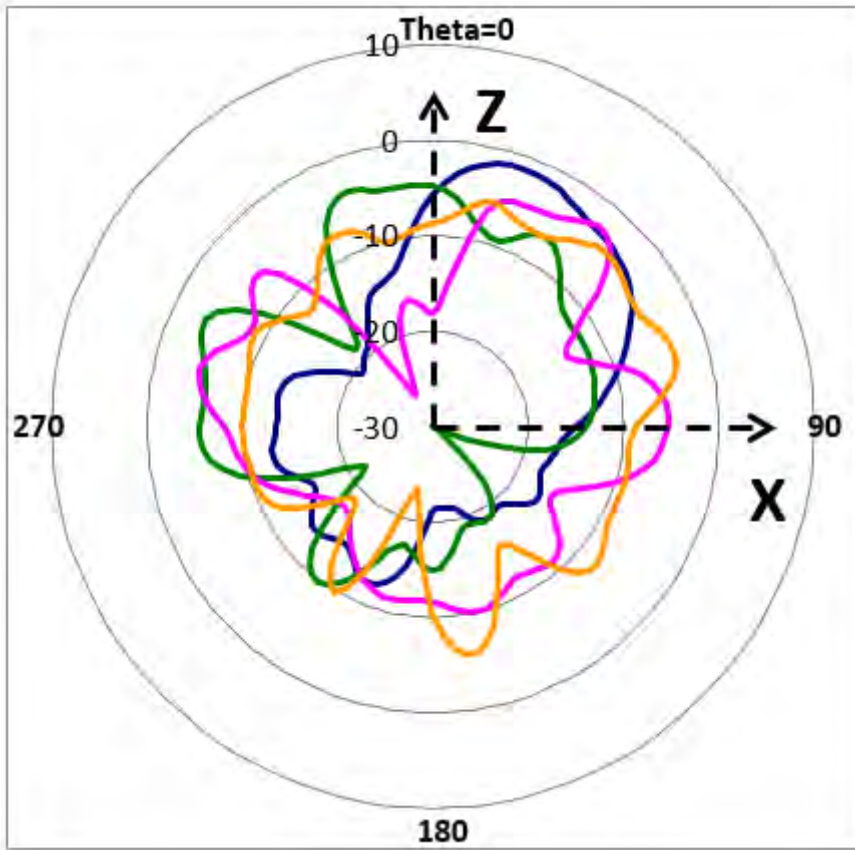

XZ_Pol._Phi_Ant.4

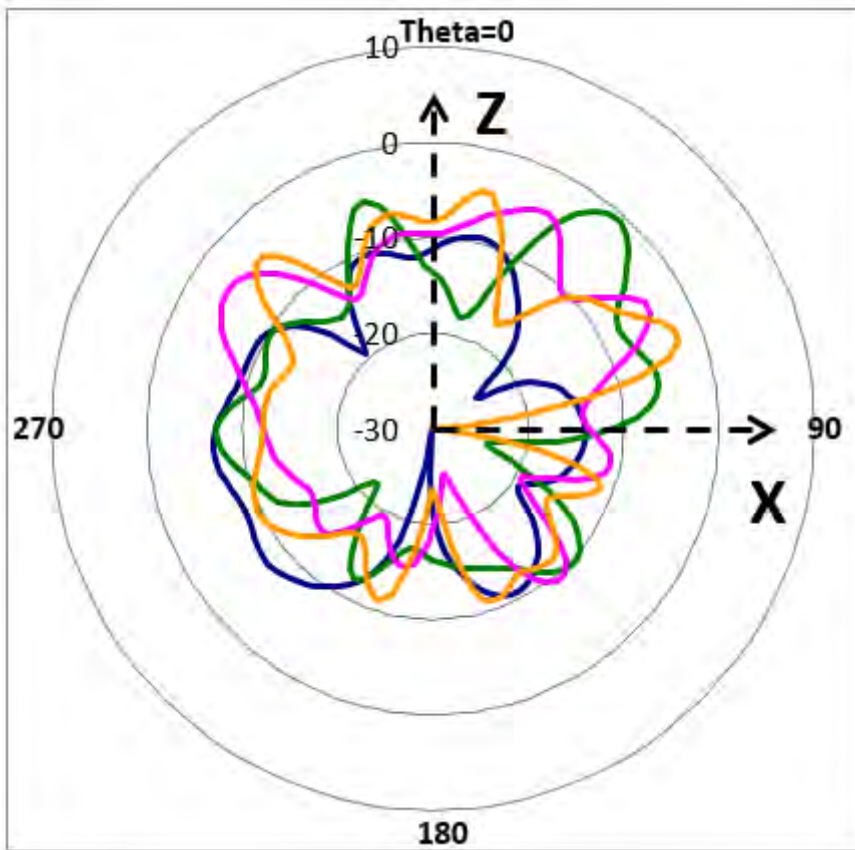

XZ_Pol._Theta_Ant.3

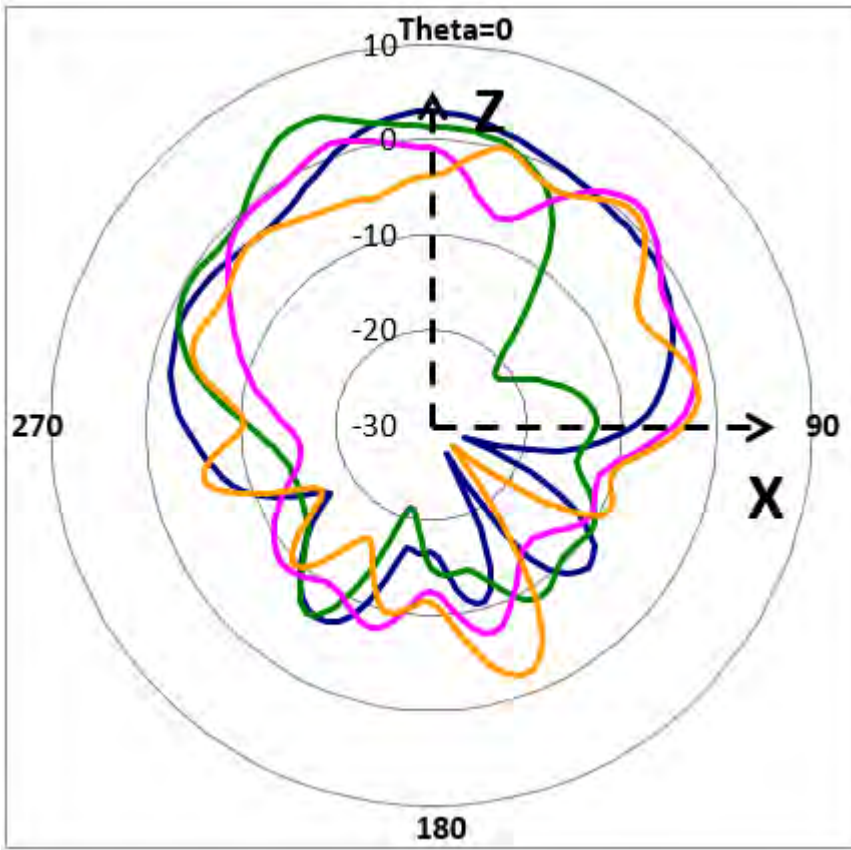

XZ_Pol._Theta_Ant.4

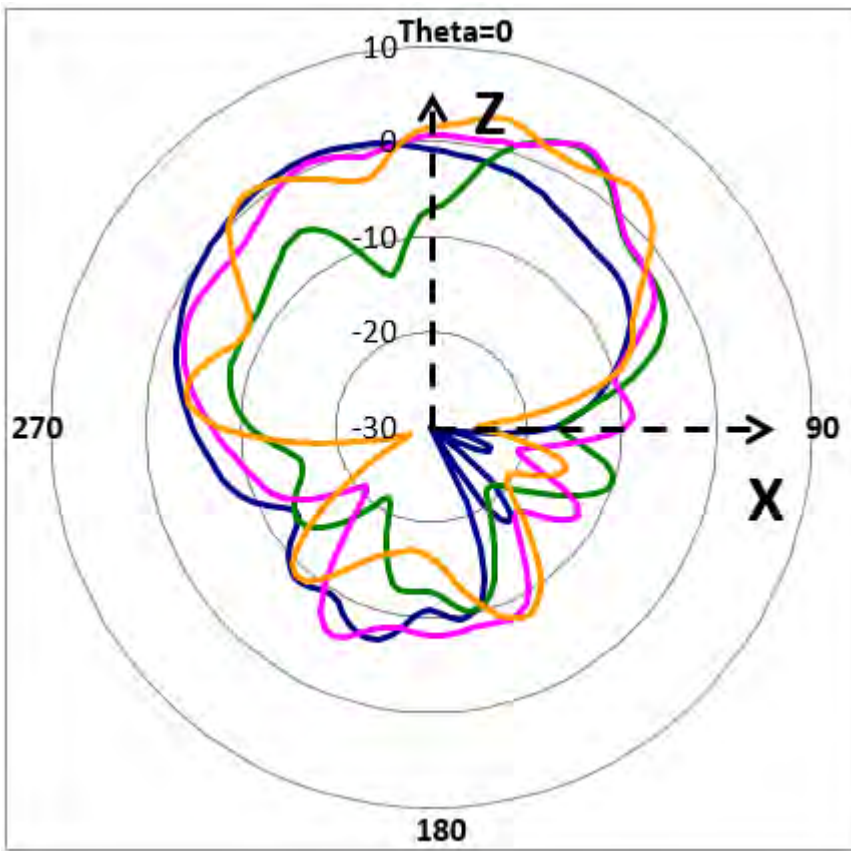

YZ_Pol._Phi_Ant.3

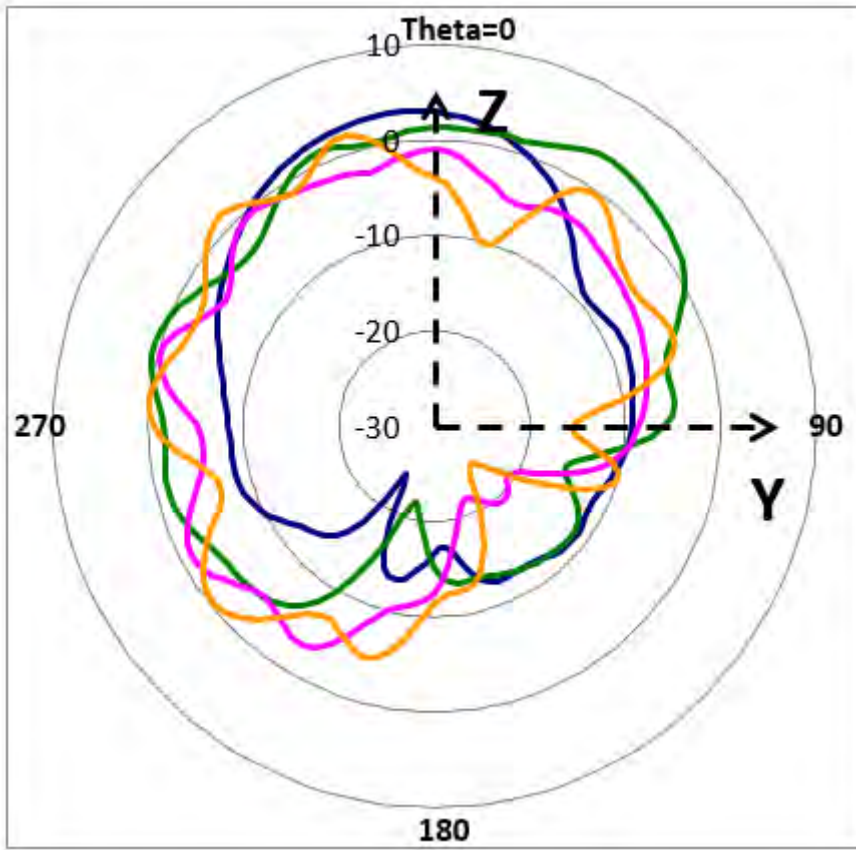

- 2450MHz_Gain_3.16
- 5925MHz_Gain_3.55
- 6500MHz_Gain_-0.24
- 7000MHz_Gain_1.96

YZ_Pol._Phi_Ant.4

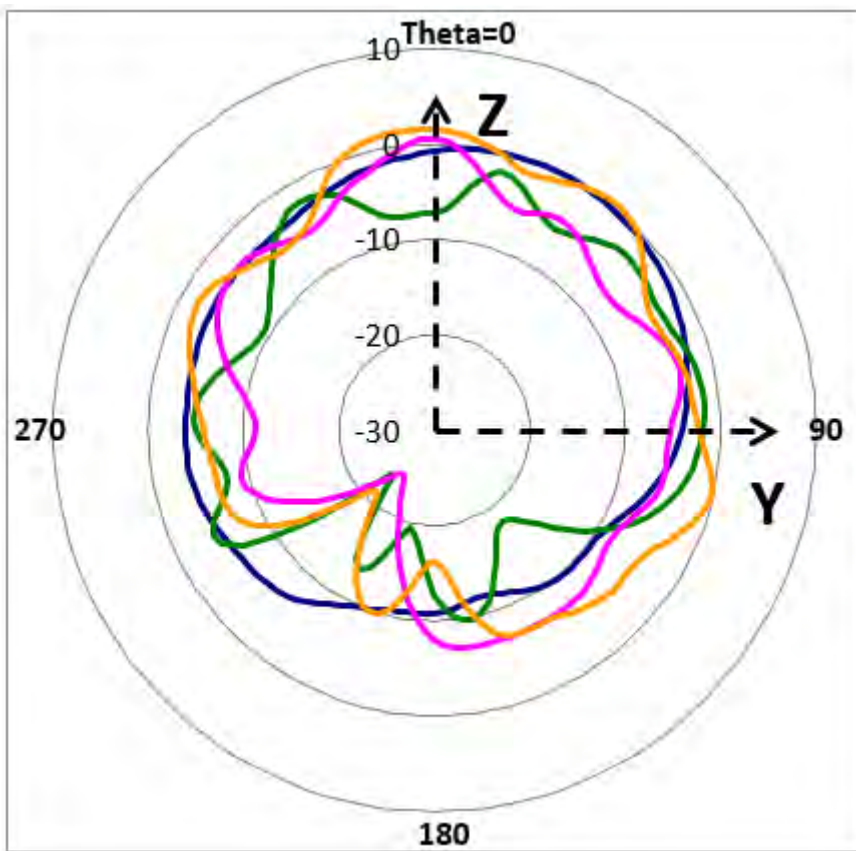

- 2450MHz_Gain_0.09
- 5925MHz_Gain_-1.62
- 6500MHz_Gain_0.66
- 7000MHz_Gain_1.64

YZ_Pol._Theta_Ant.3

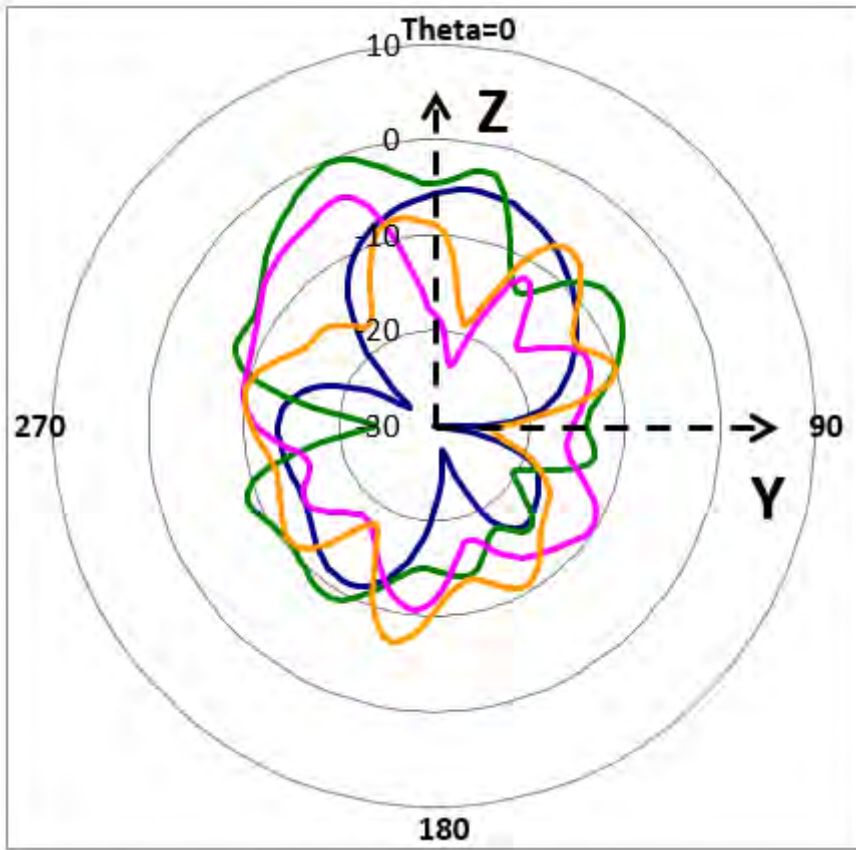

YZ_Pol._Theta_Ant.4

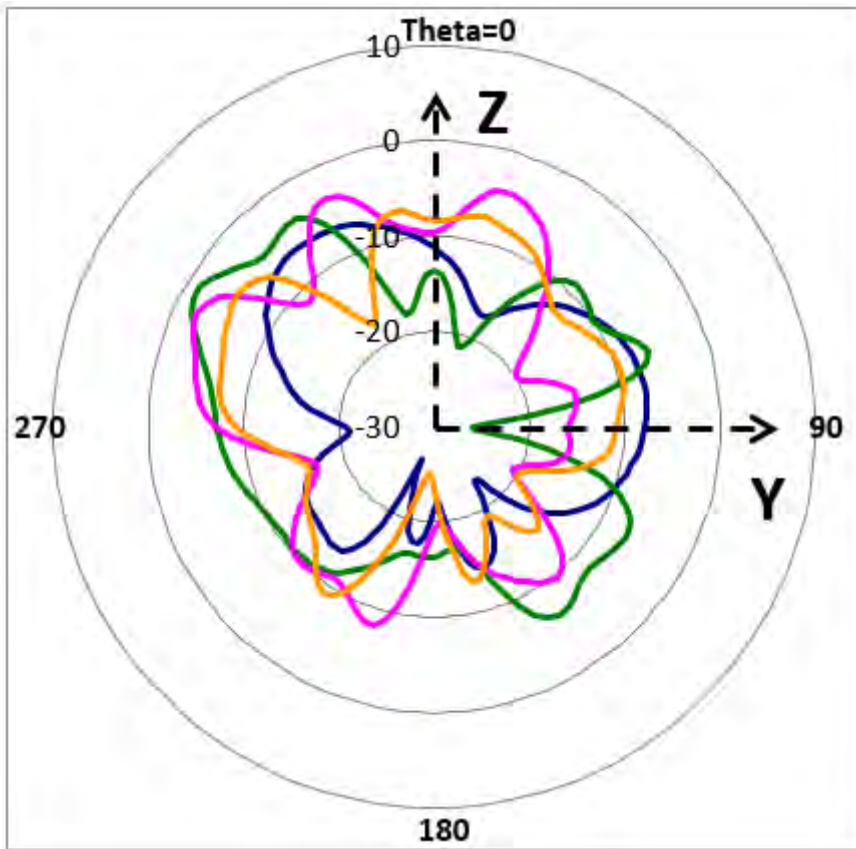

Ant. Position : LTE Main Ant.5

XY_Pol._Phi_Ant.5 (Uplink)

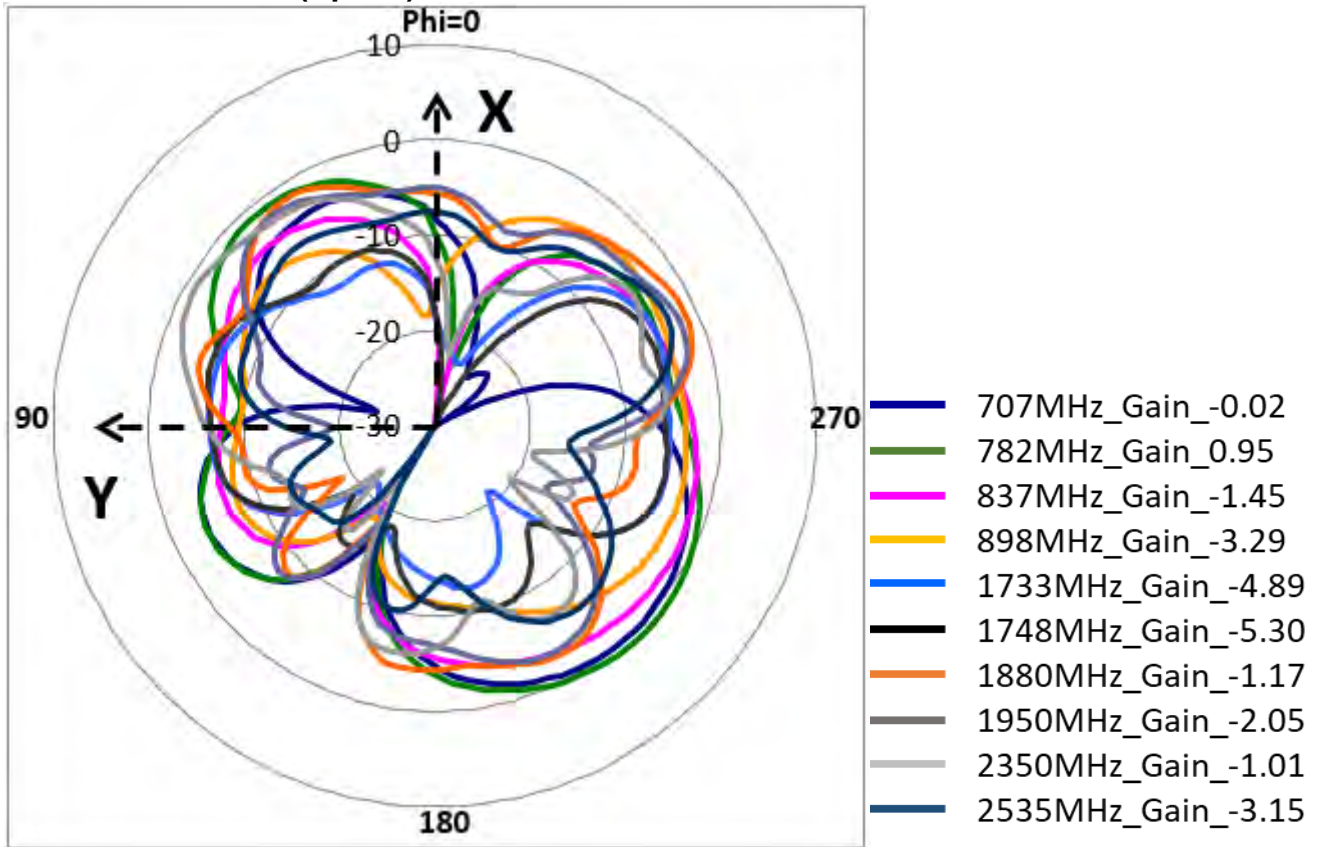

XY_Pol._Phi_Ant.5 (Downlink)

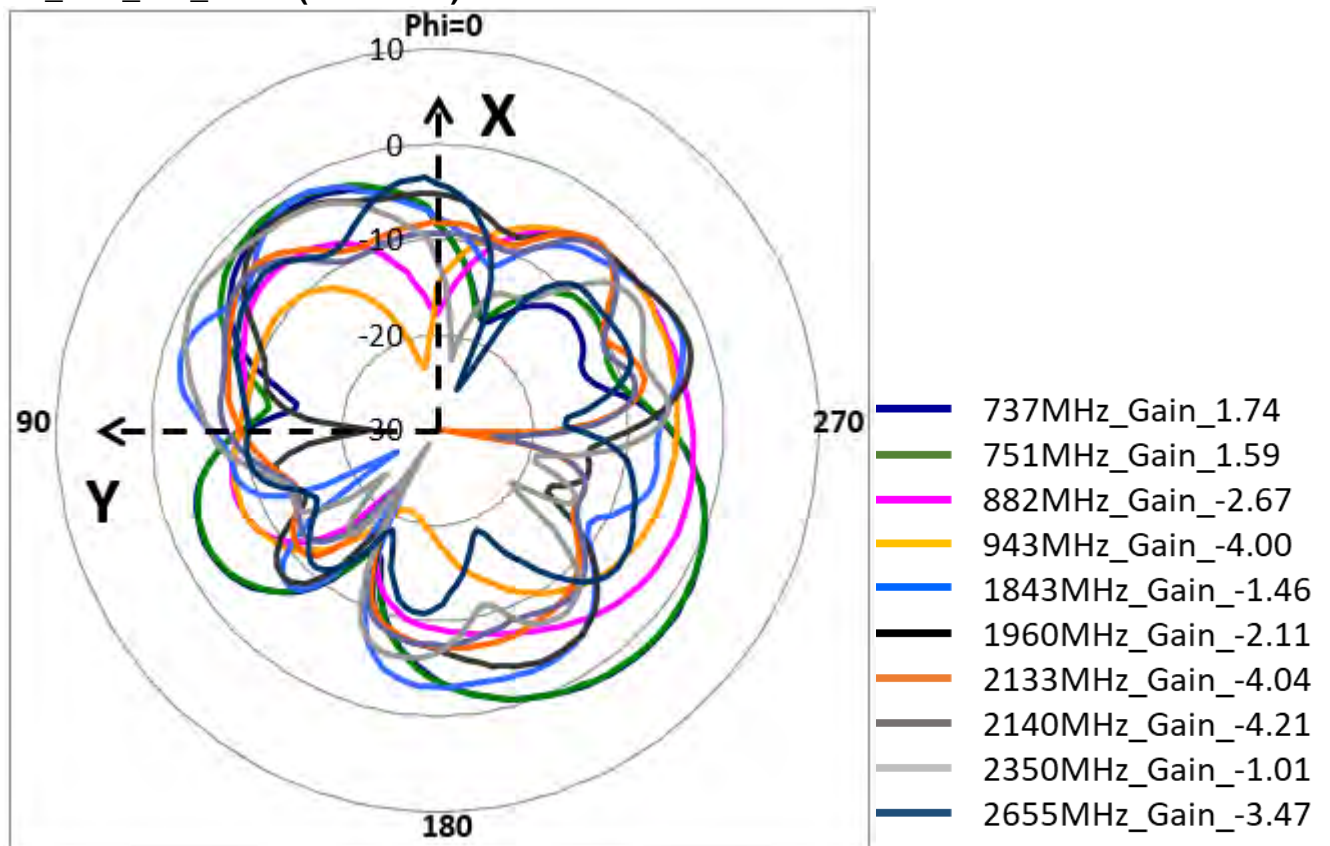

XY_Pol._Theta_Ant.5 (Uplink)

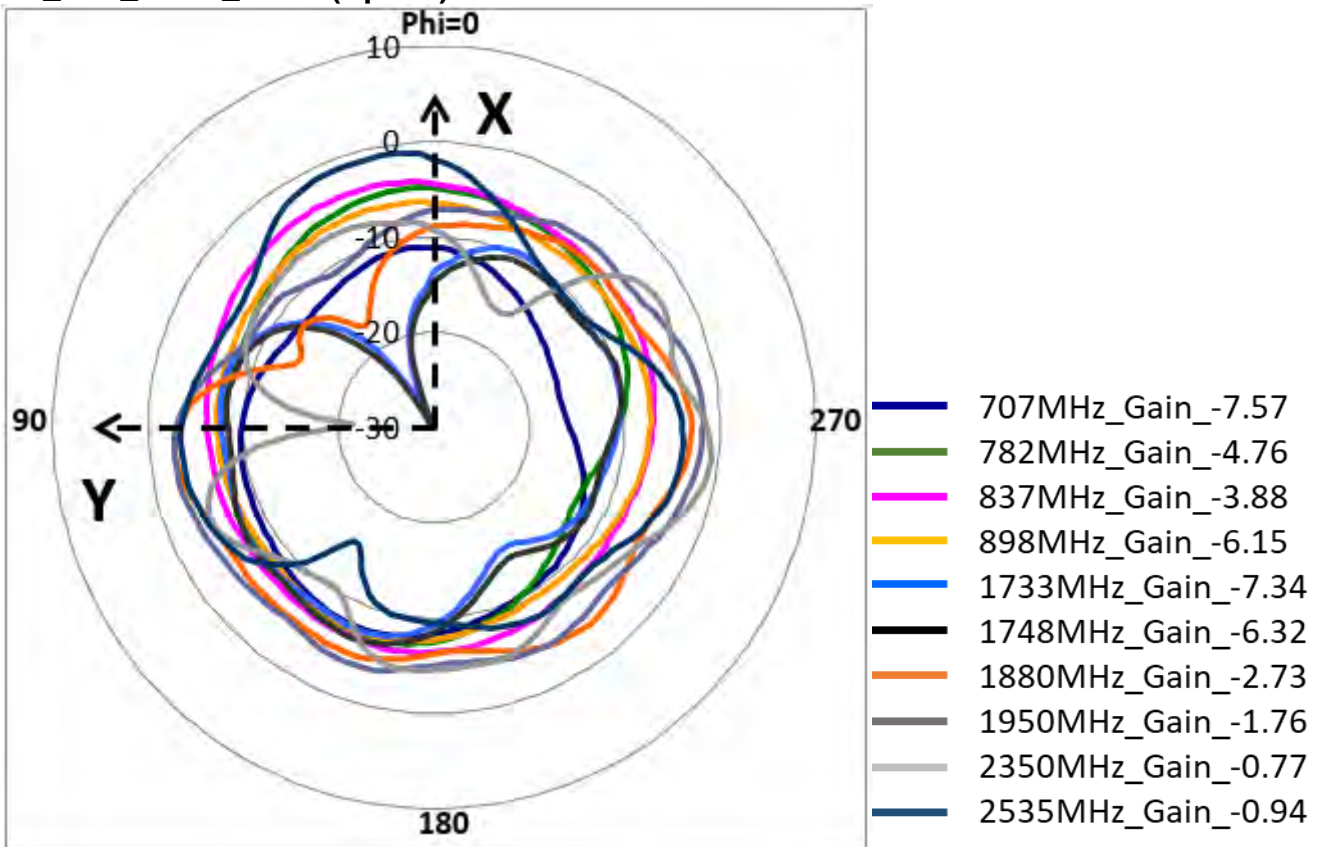

XY_Pol._Theta_Ant.5 (Downlink)

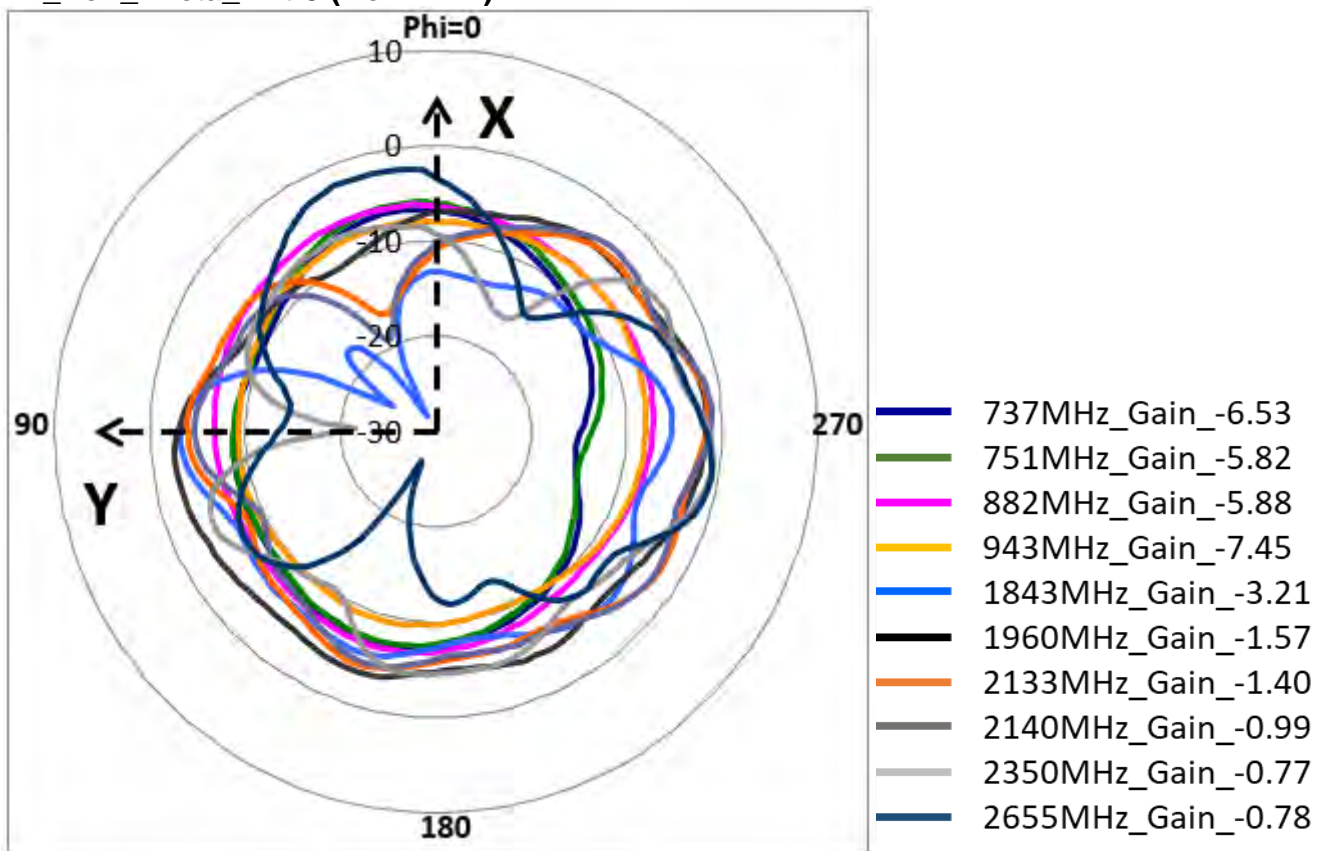

XZ_Pol._Phi_Ant.5 (Uplink)

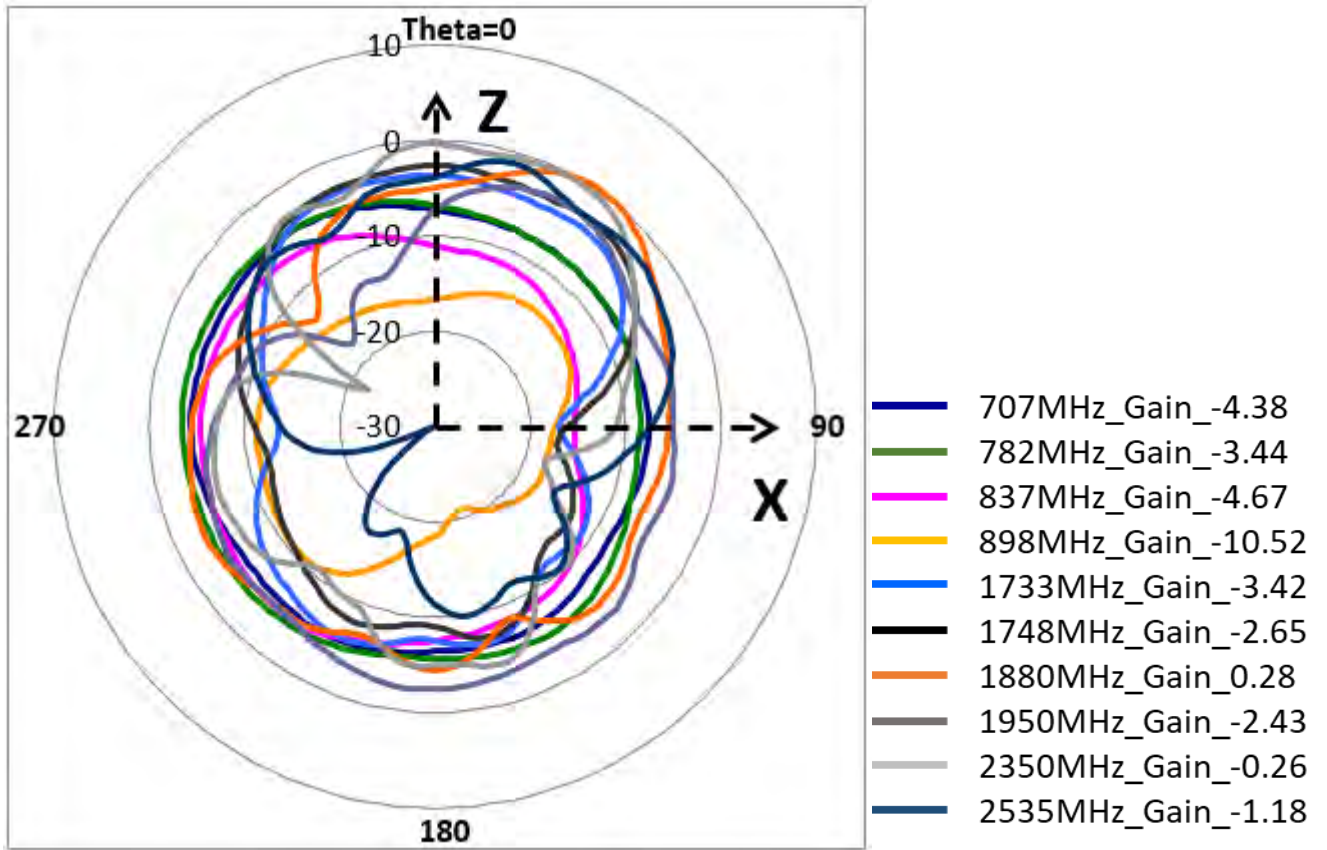

XZ_Pol._Phi_Ant.5 (Downlink)

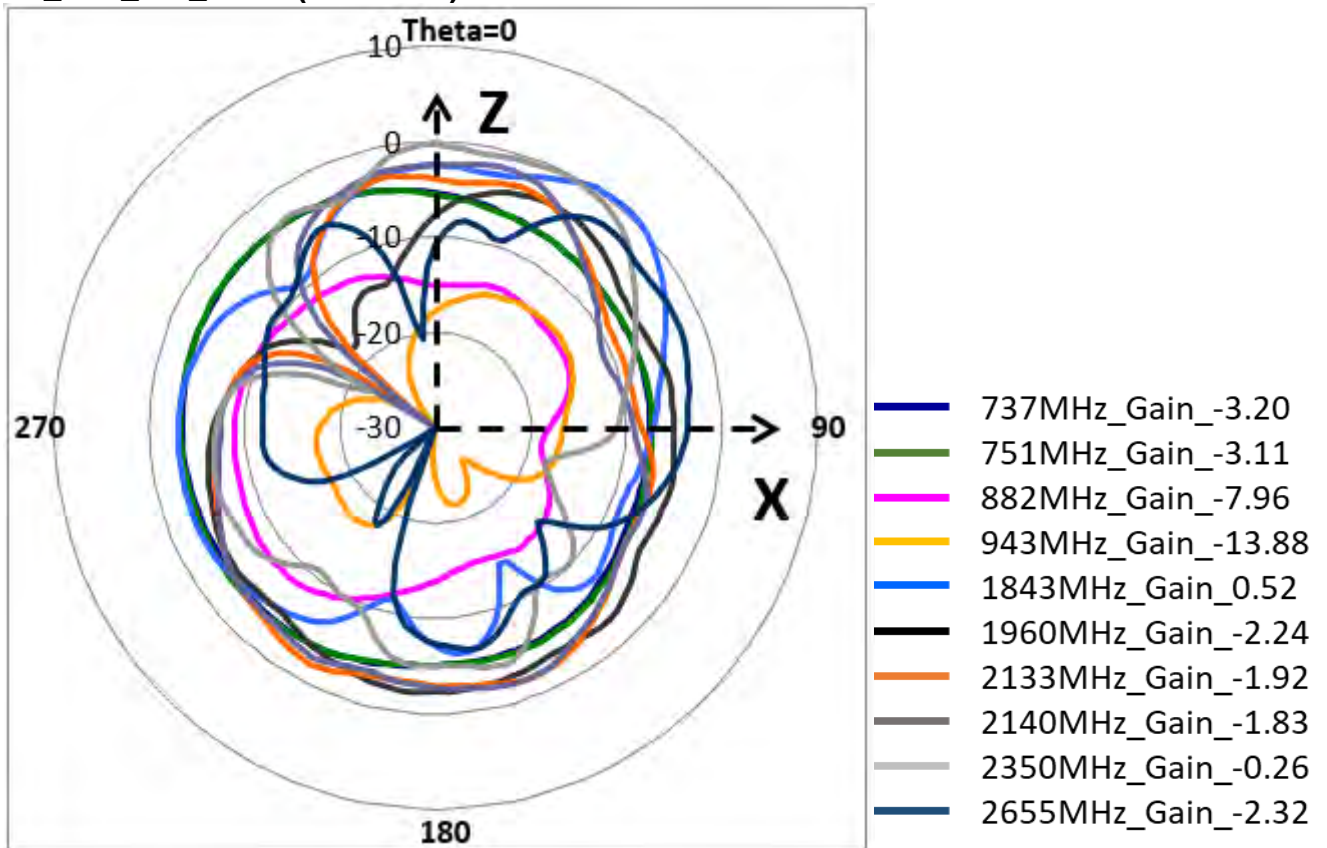

XZ_Pol._Theta_Ant.5 (Uplink)

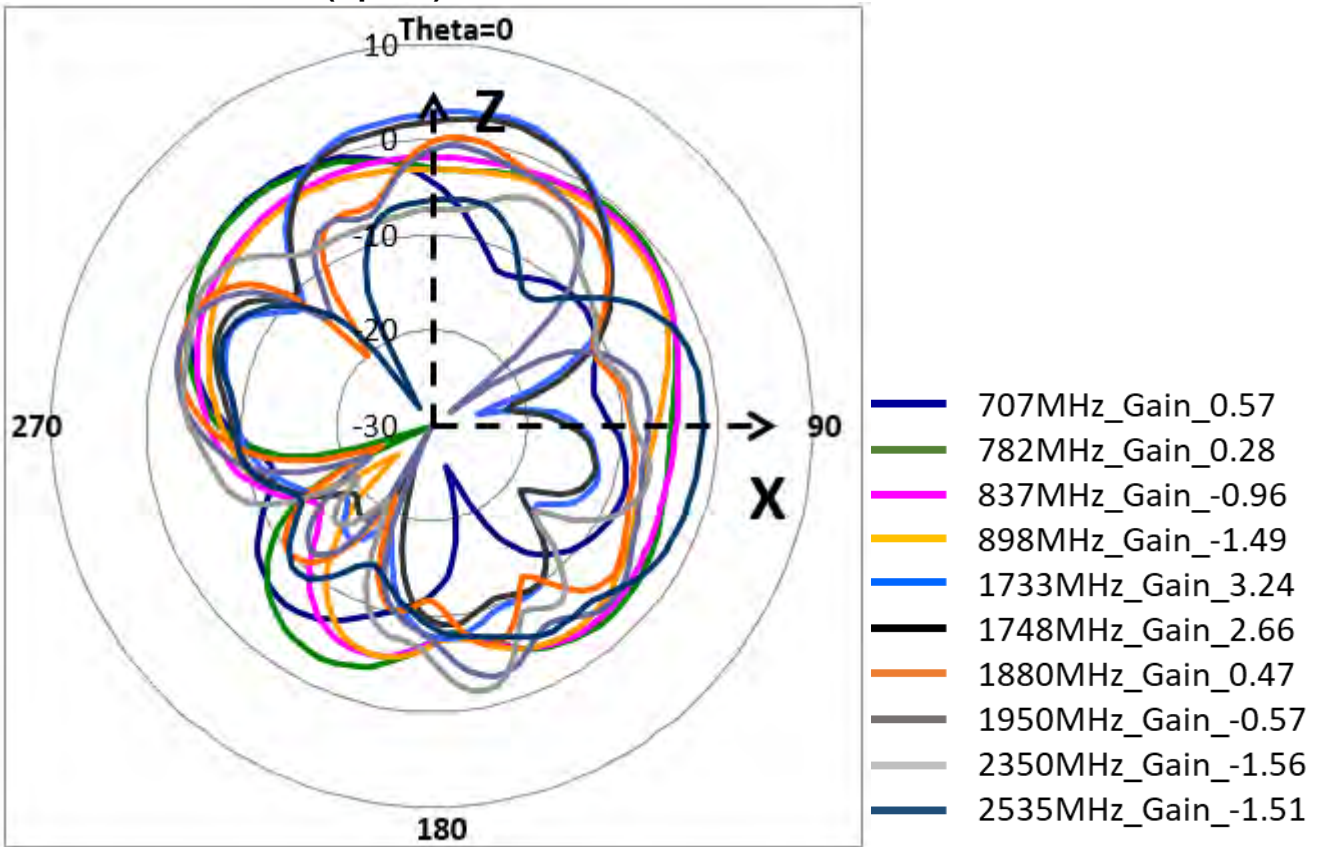

XZ_Pol._Theta_Ant.5 (Downlink)

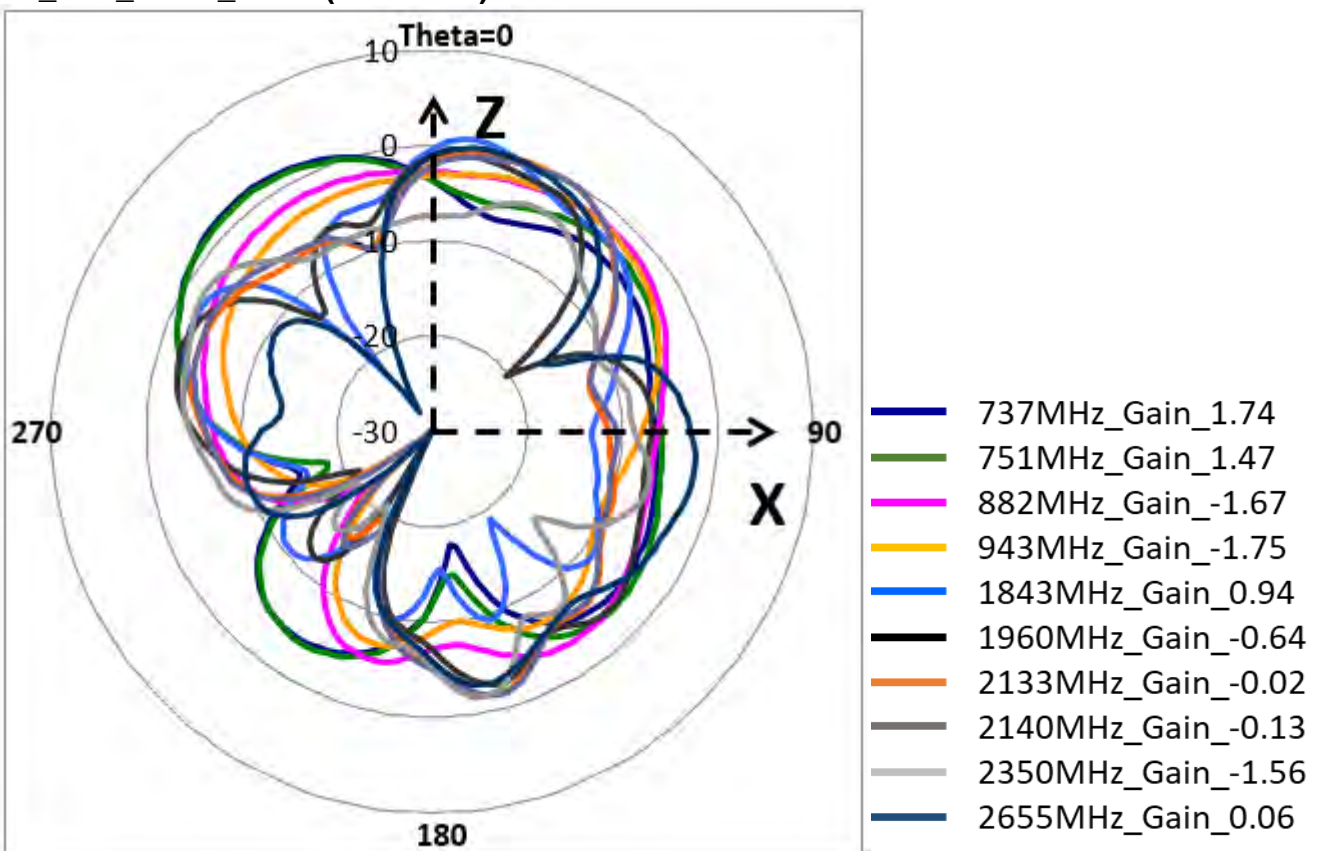

YZ_Pol._Phi_Ant.5 (Uplink)

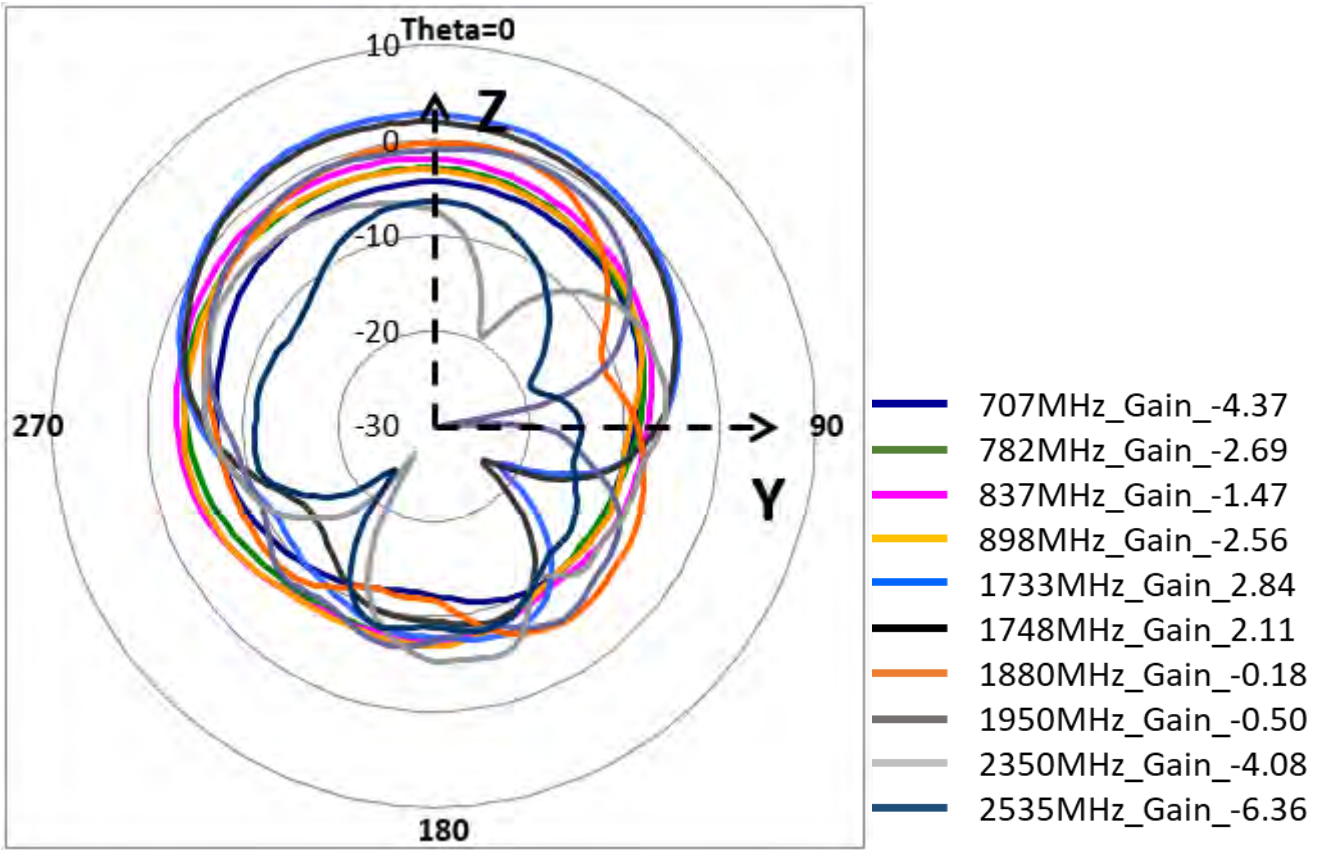

YZ_Pol._Phi_Ant.5 (Downlink)

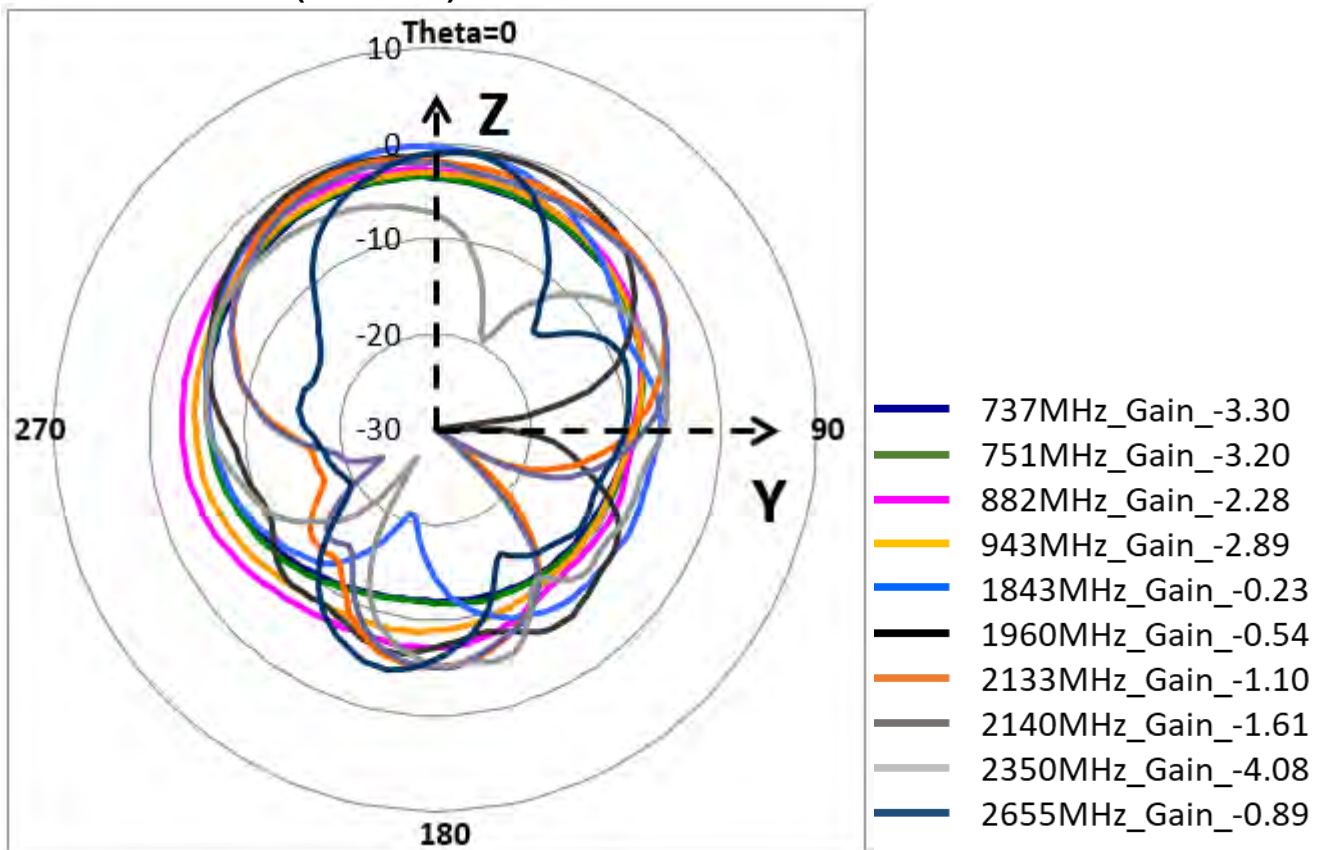

YZ_Pol._Theta_Ant.5 (Uplink)

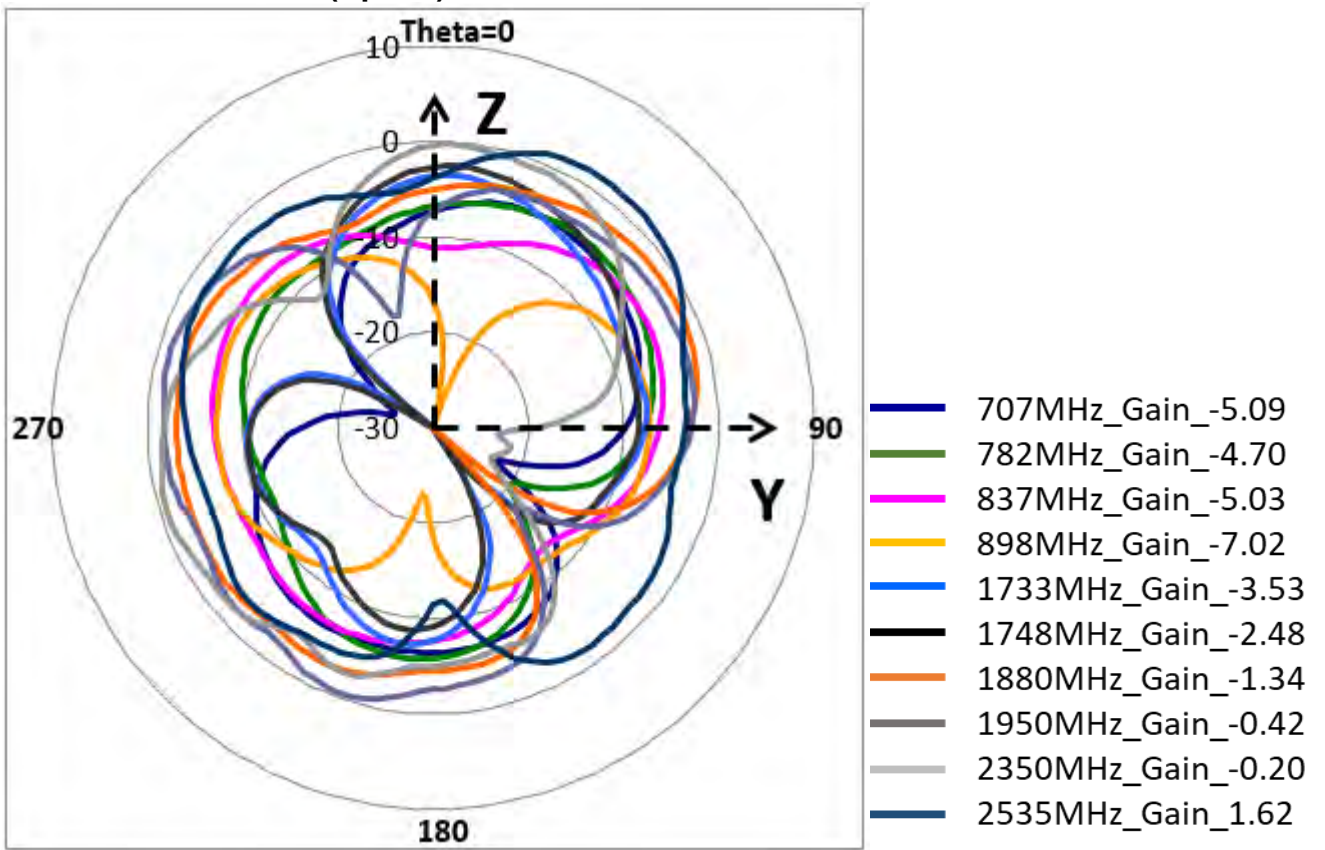

YZ_Pol._Theta_Ant.5 (Downlink)

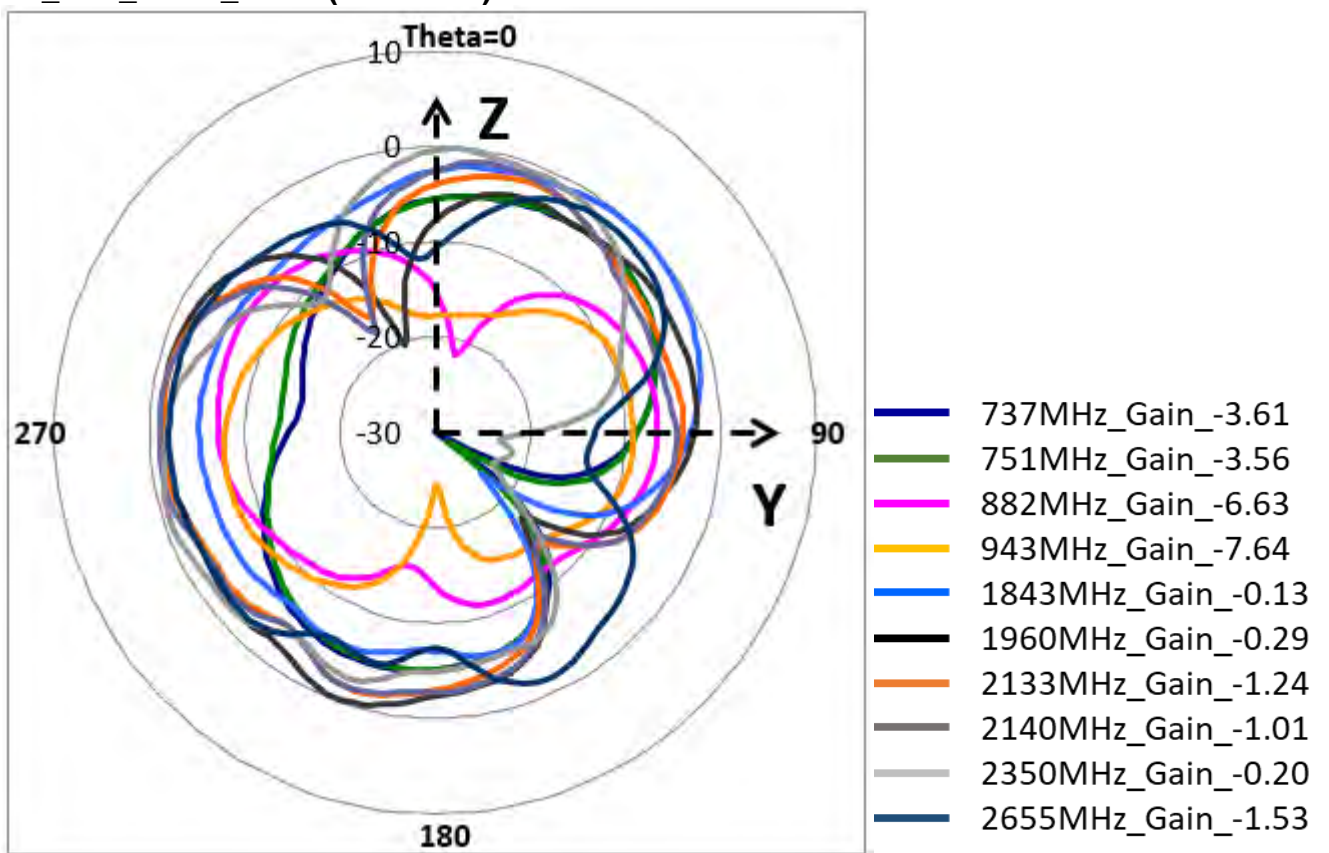

Ant. Position : LTE Aux Ant.6

XY_Pol._Phi_Ant.6 (Uplink)

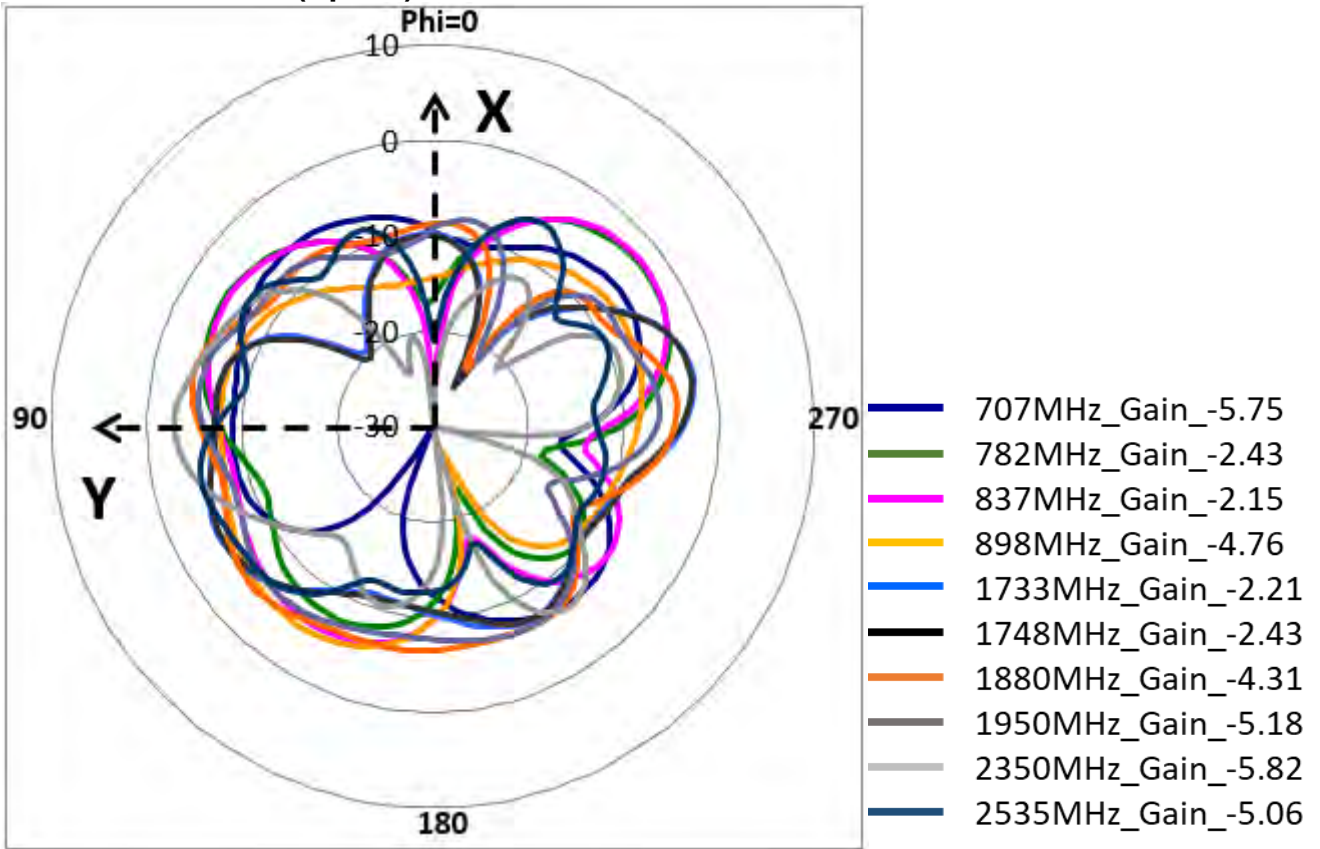

XY_Pol._Phi_Ant.6 (Downlink)

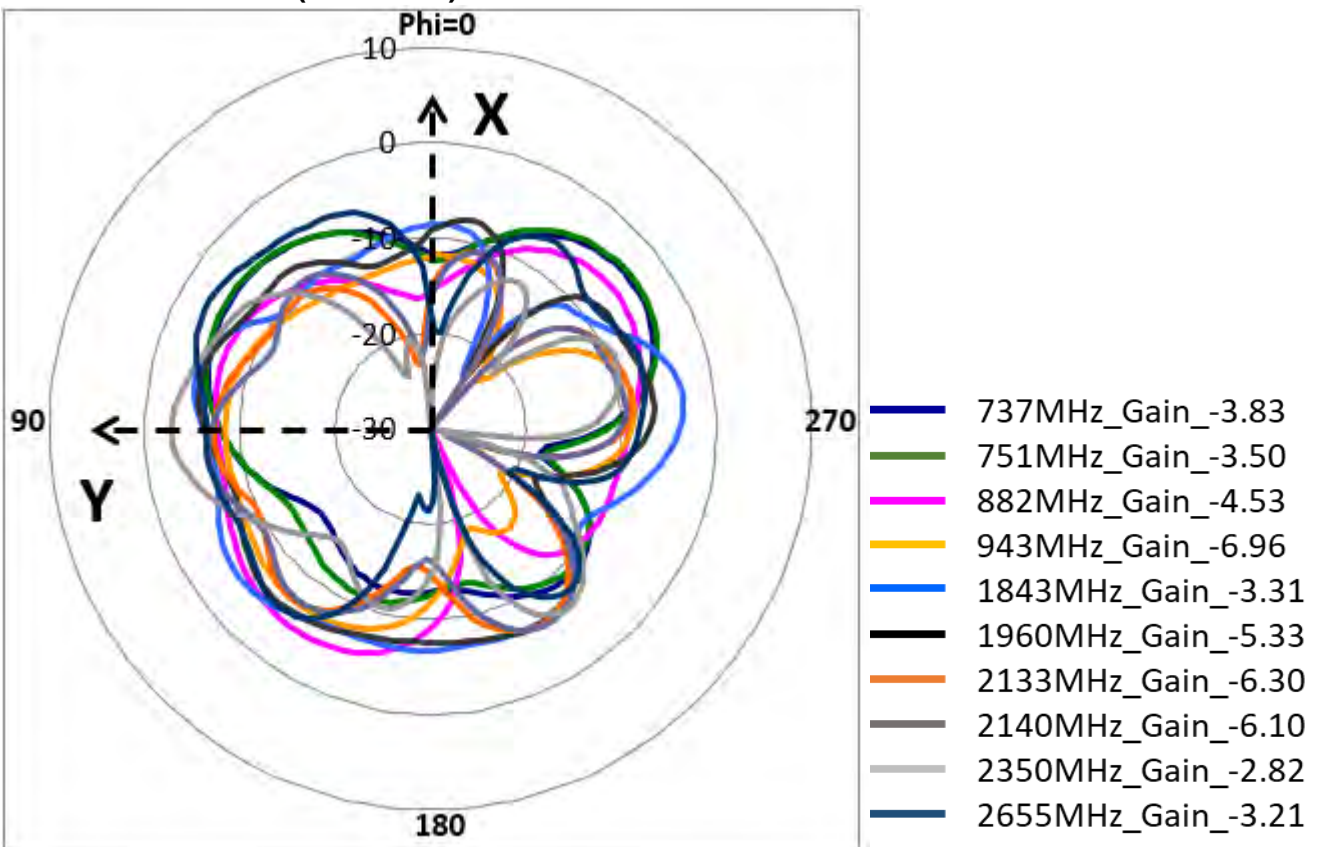

XY_Pol._Theta_Ant.6 (Uplink)

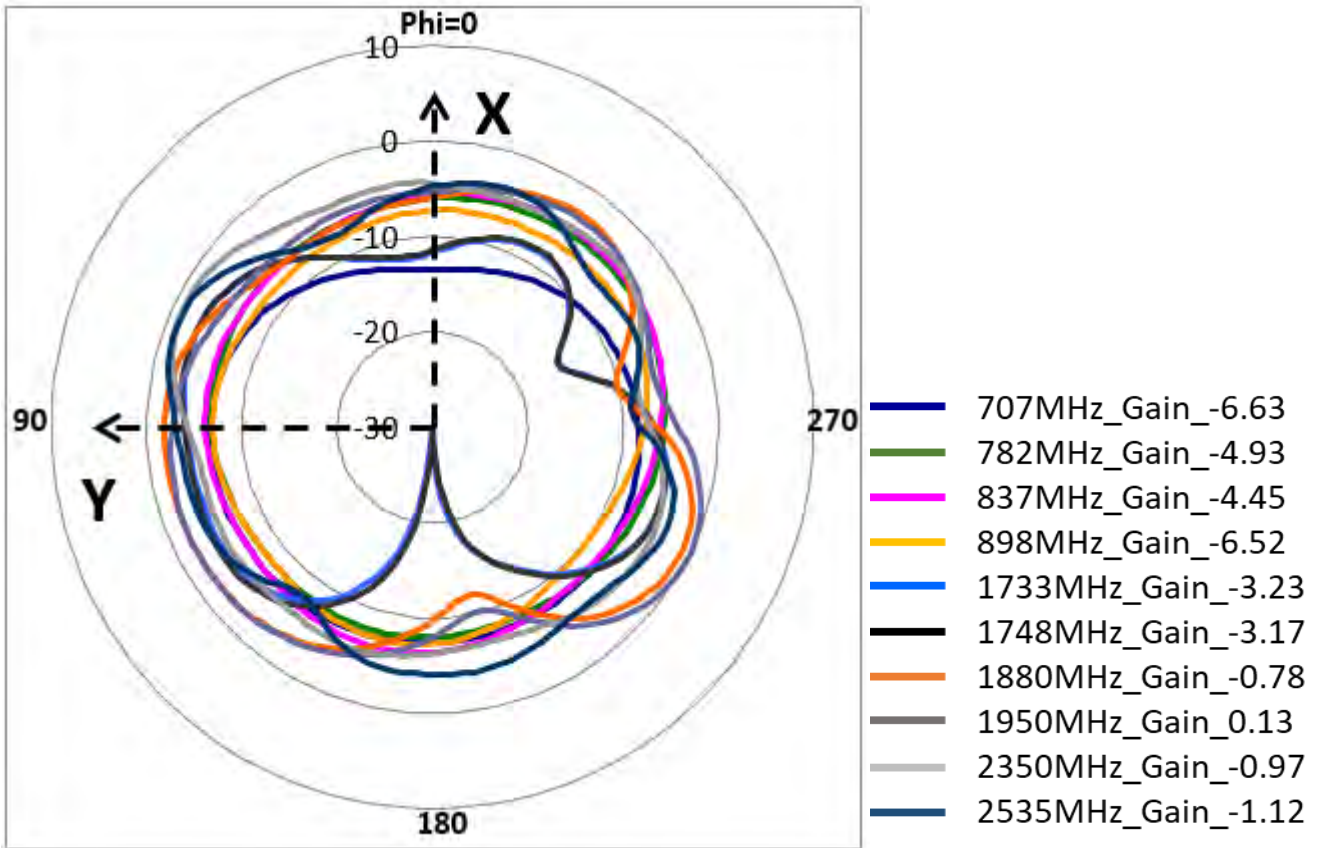

XY_Pol._Theta_Ant.6 (Downlink)

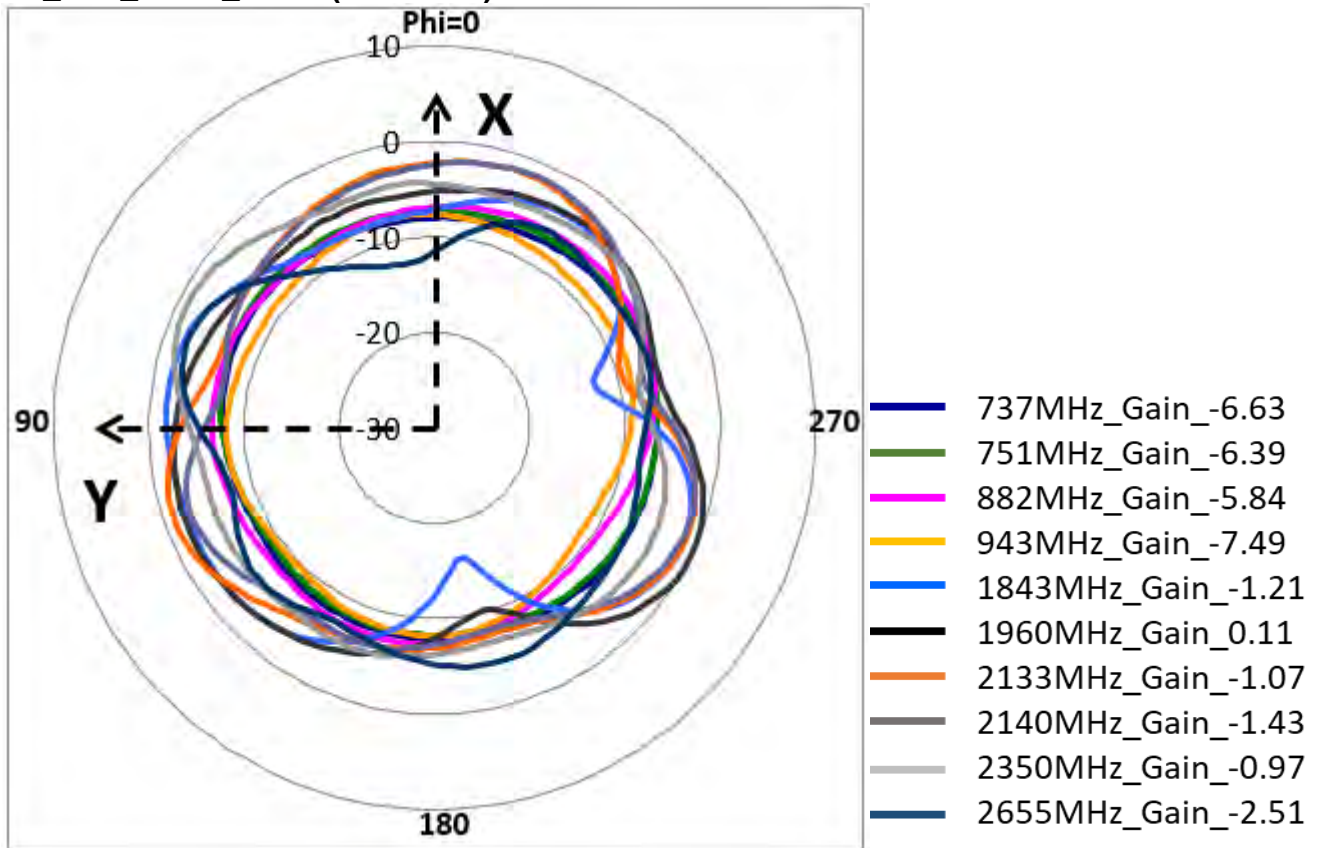

XZ_Pol._Phi_Ant.6 (Uplink)

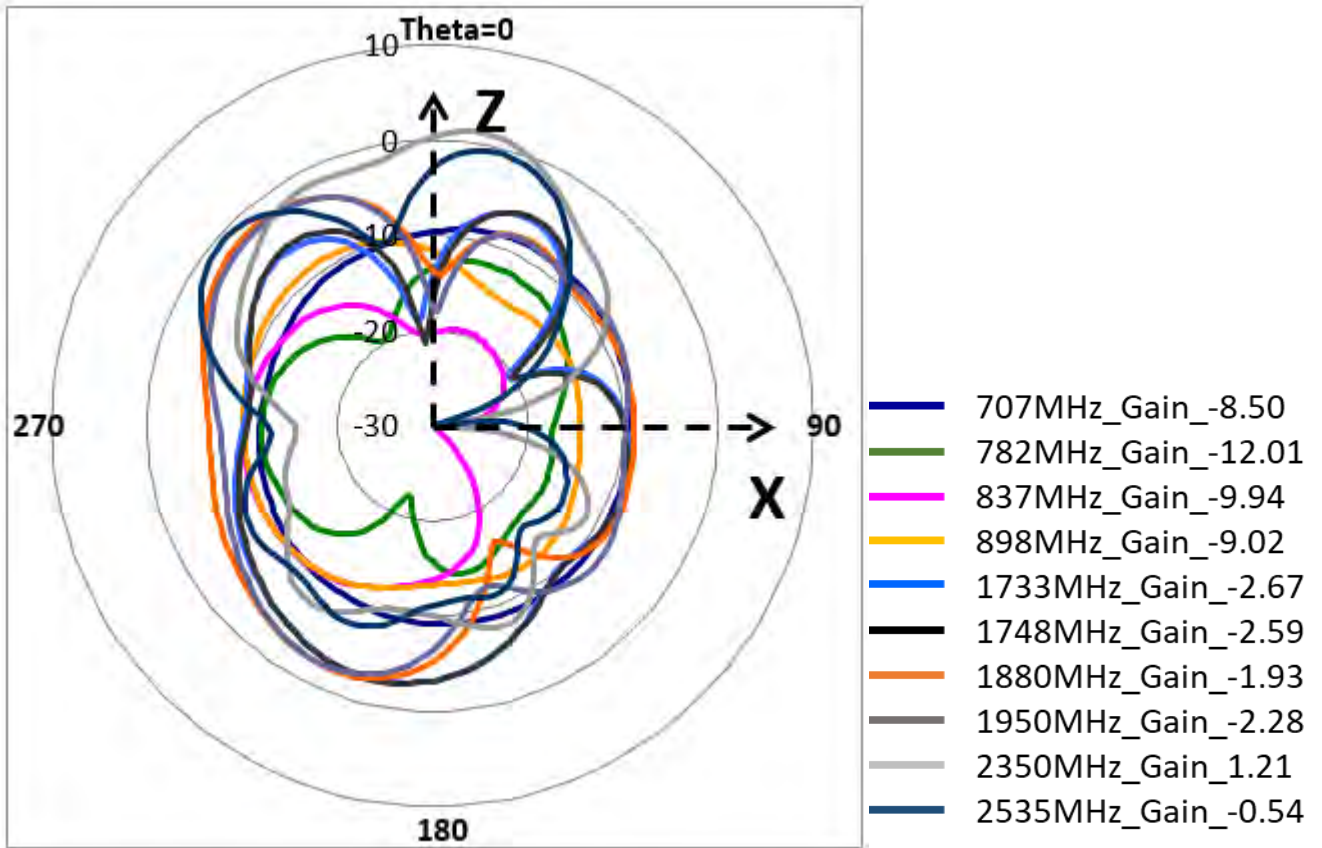

XZ_Pol._Phi_Ant.6 (Downlink)

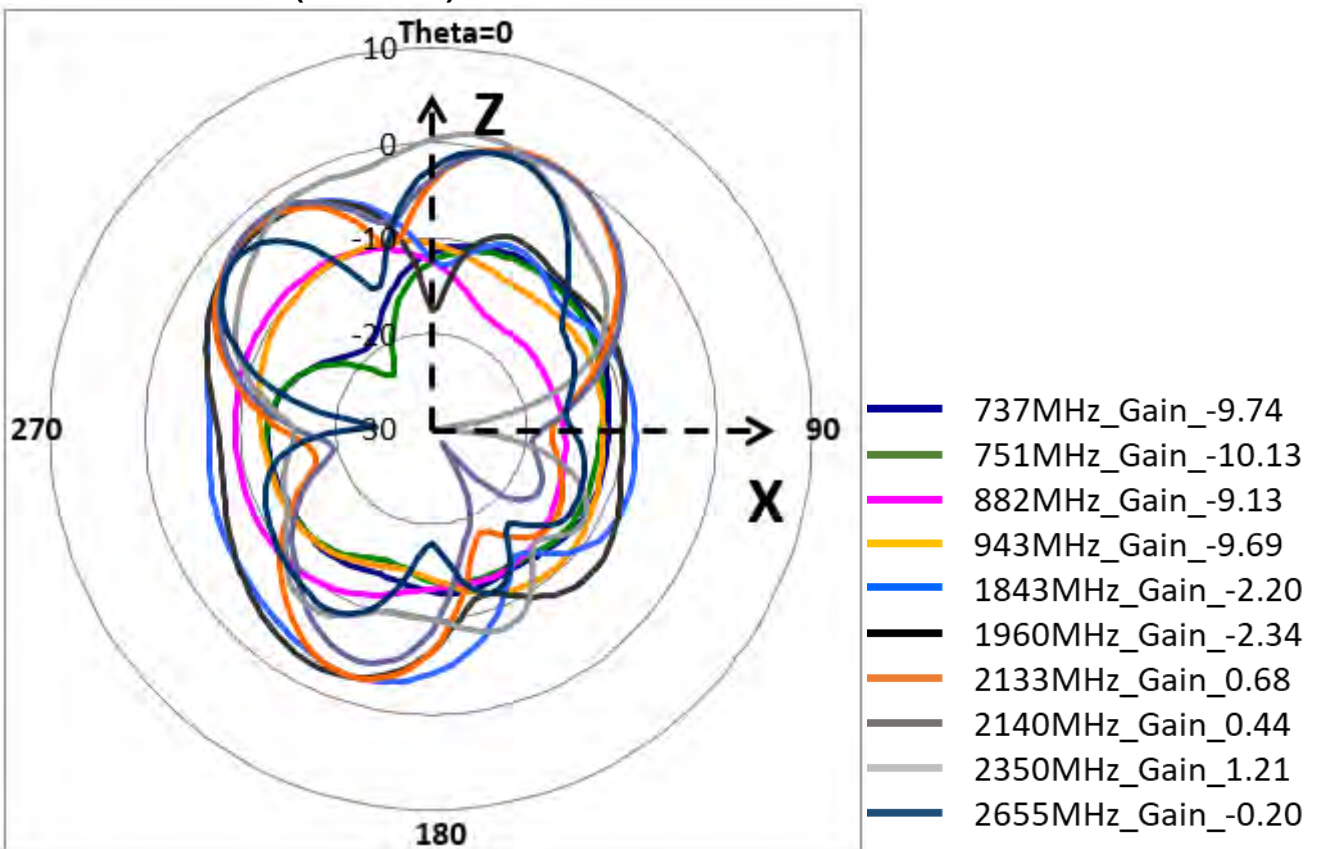

XZ_Pol._Theta_Ant.6 (Uplink)

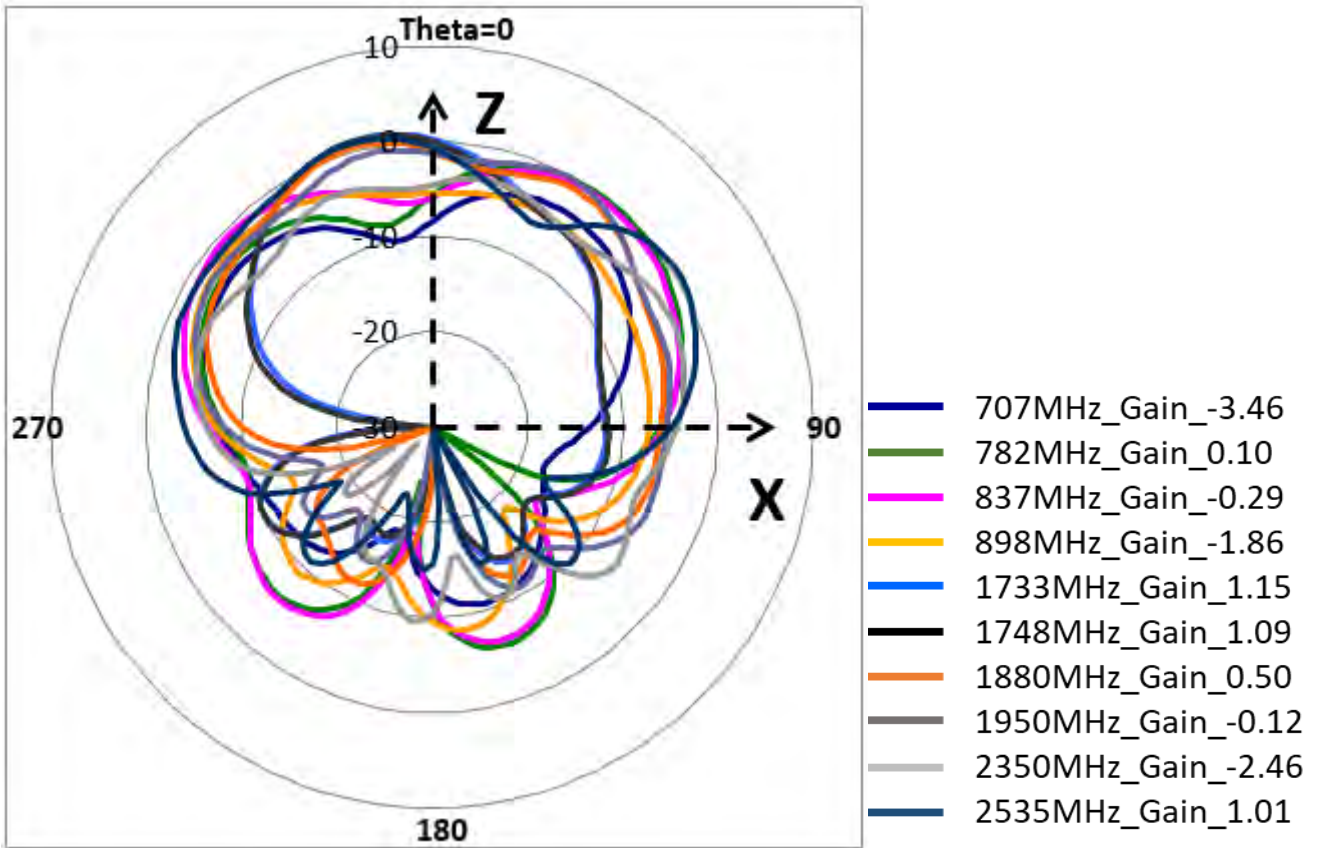

XZ_Pol._Theta_Ant.6 (Downlink)

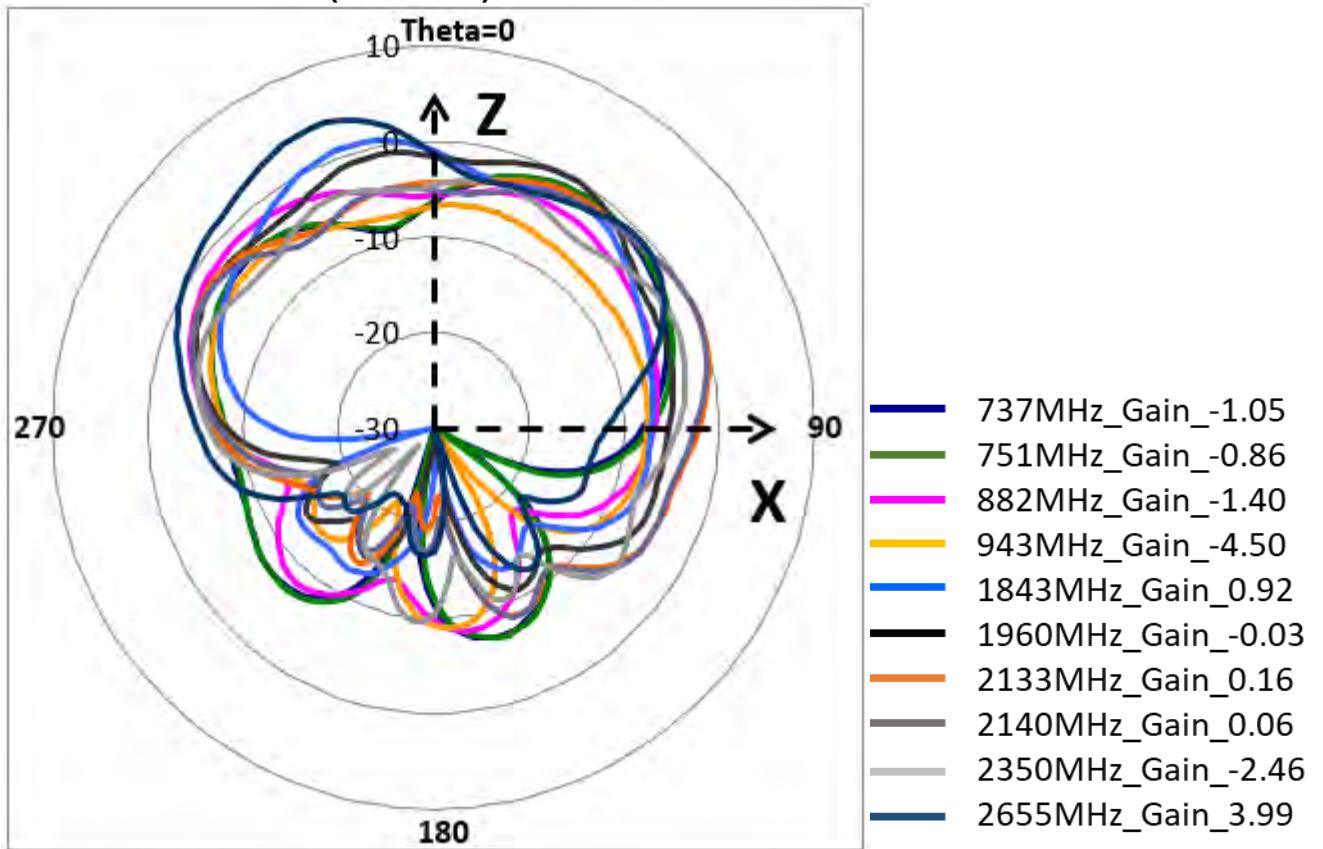

YZ_Pol._Phi_Ant.6 (Uplink)

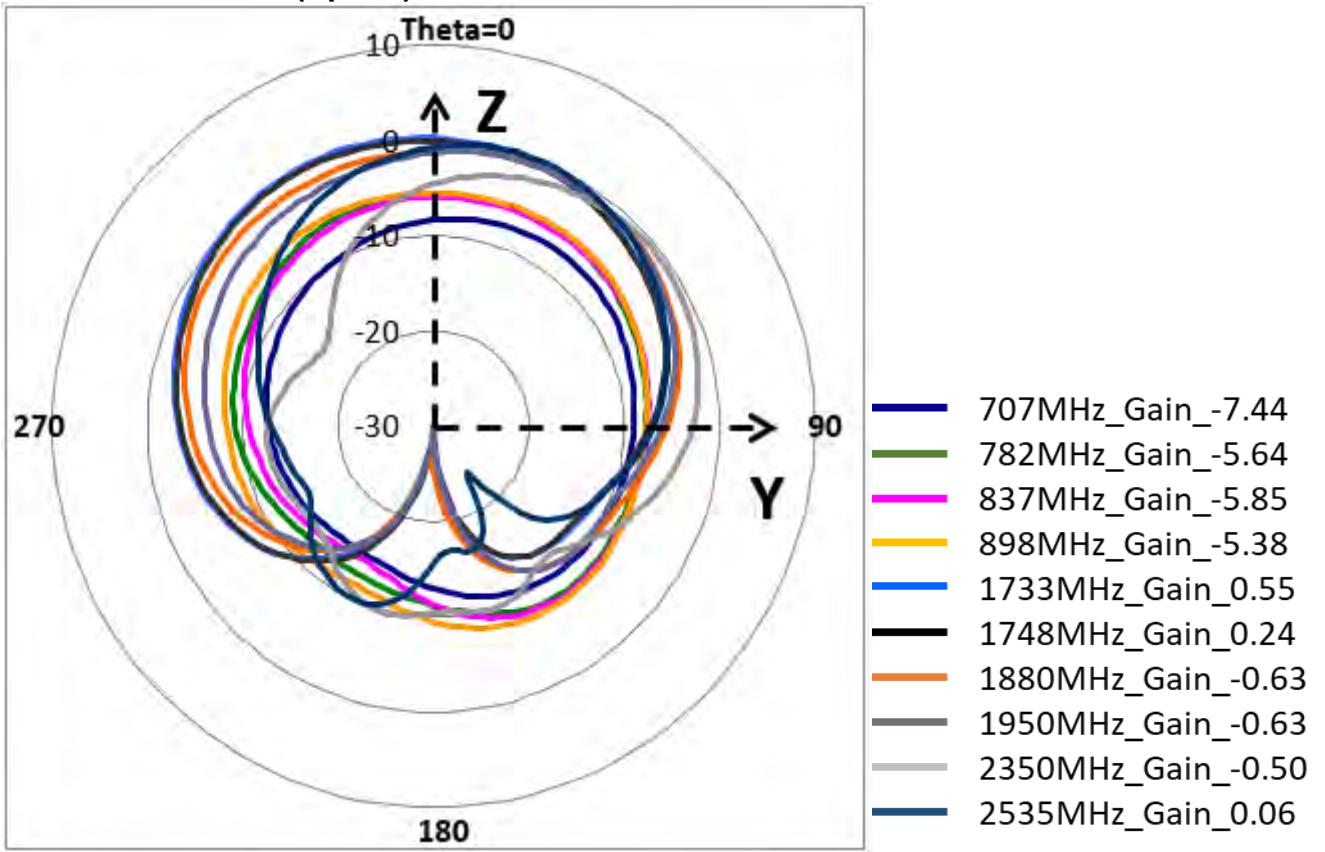

YZ_Pol._Phi_Ant.6 (Downlink)

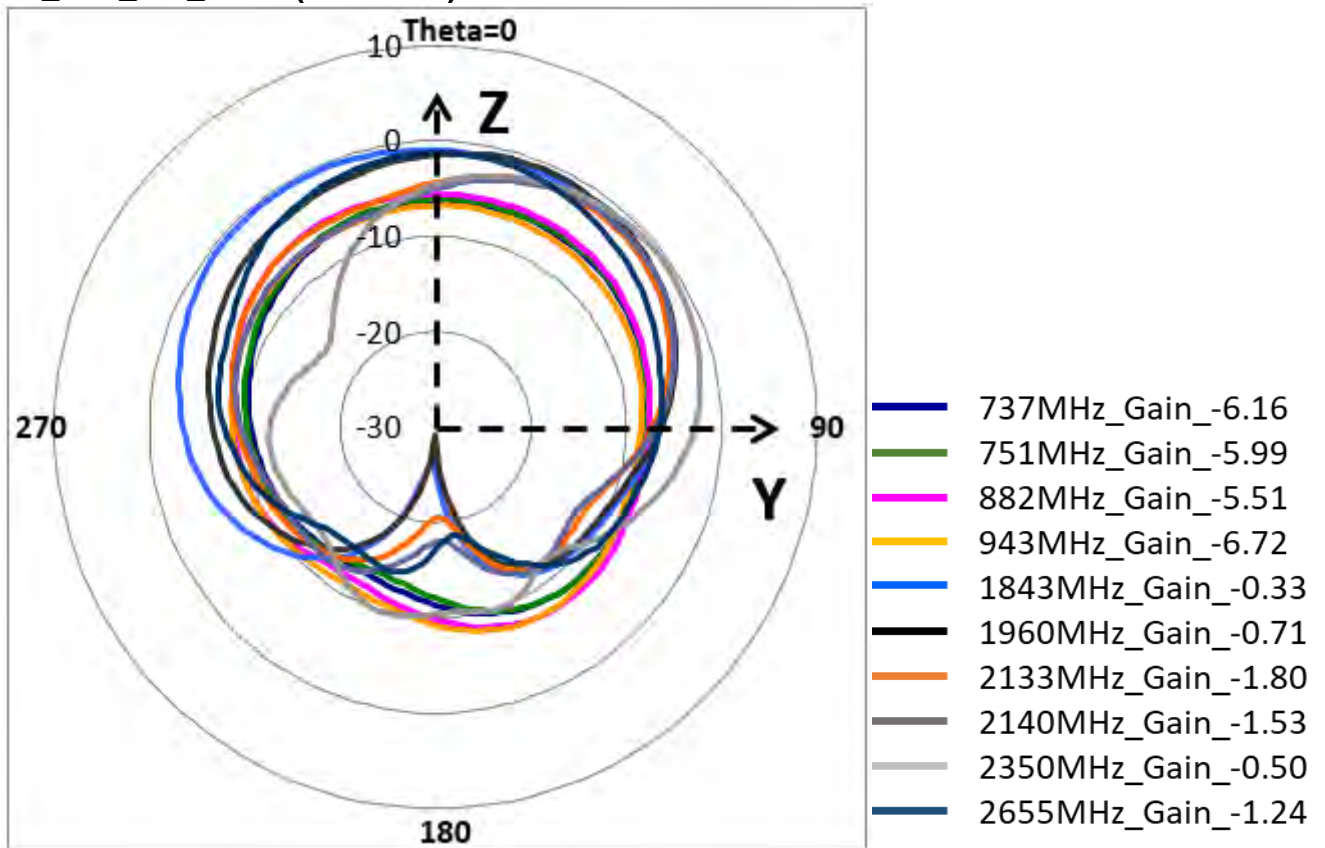

YZ_Pol._Theta_Ant.6 (Uplink)

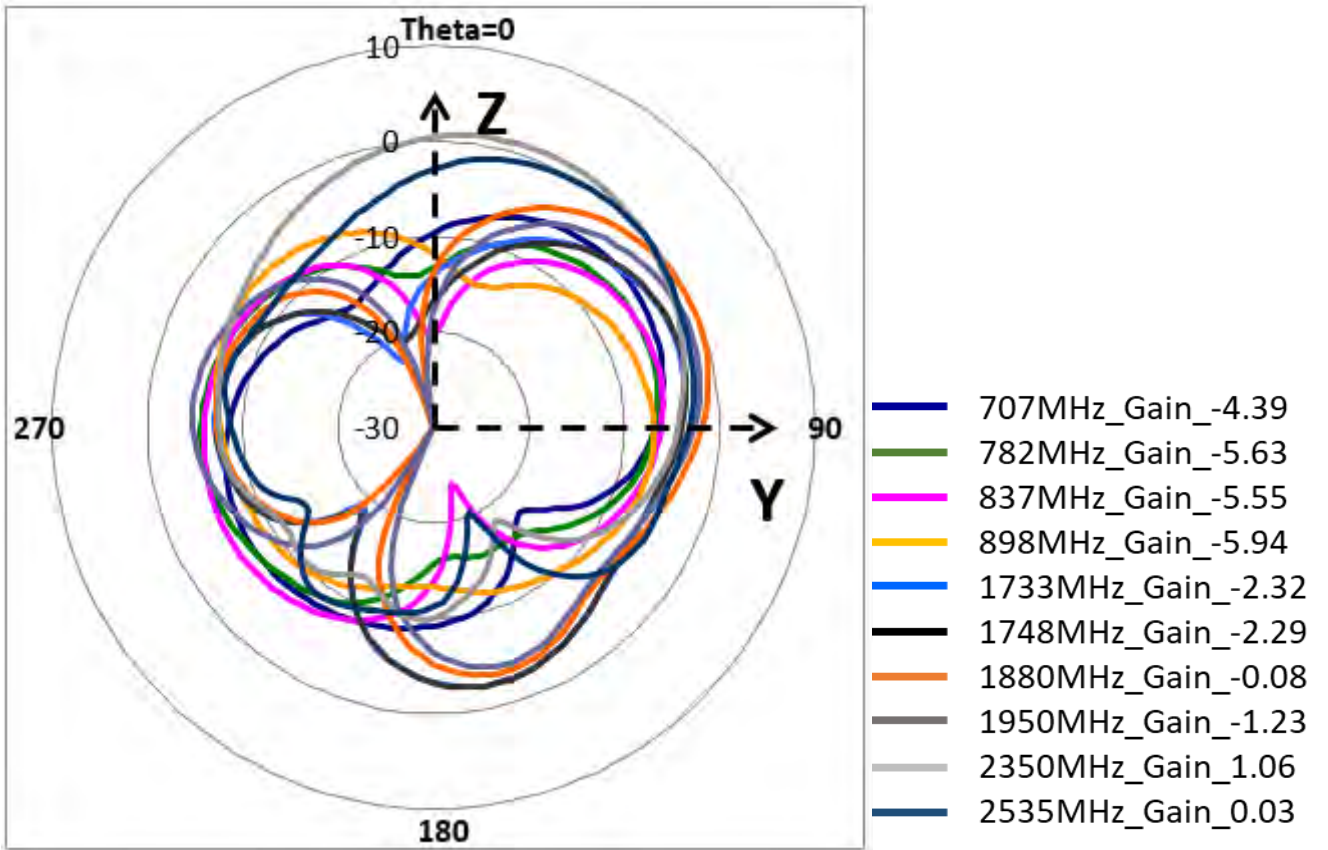

YZ_Pol._Theta_Ant.6 (Downlink)

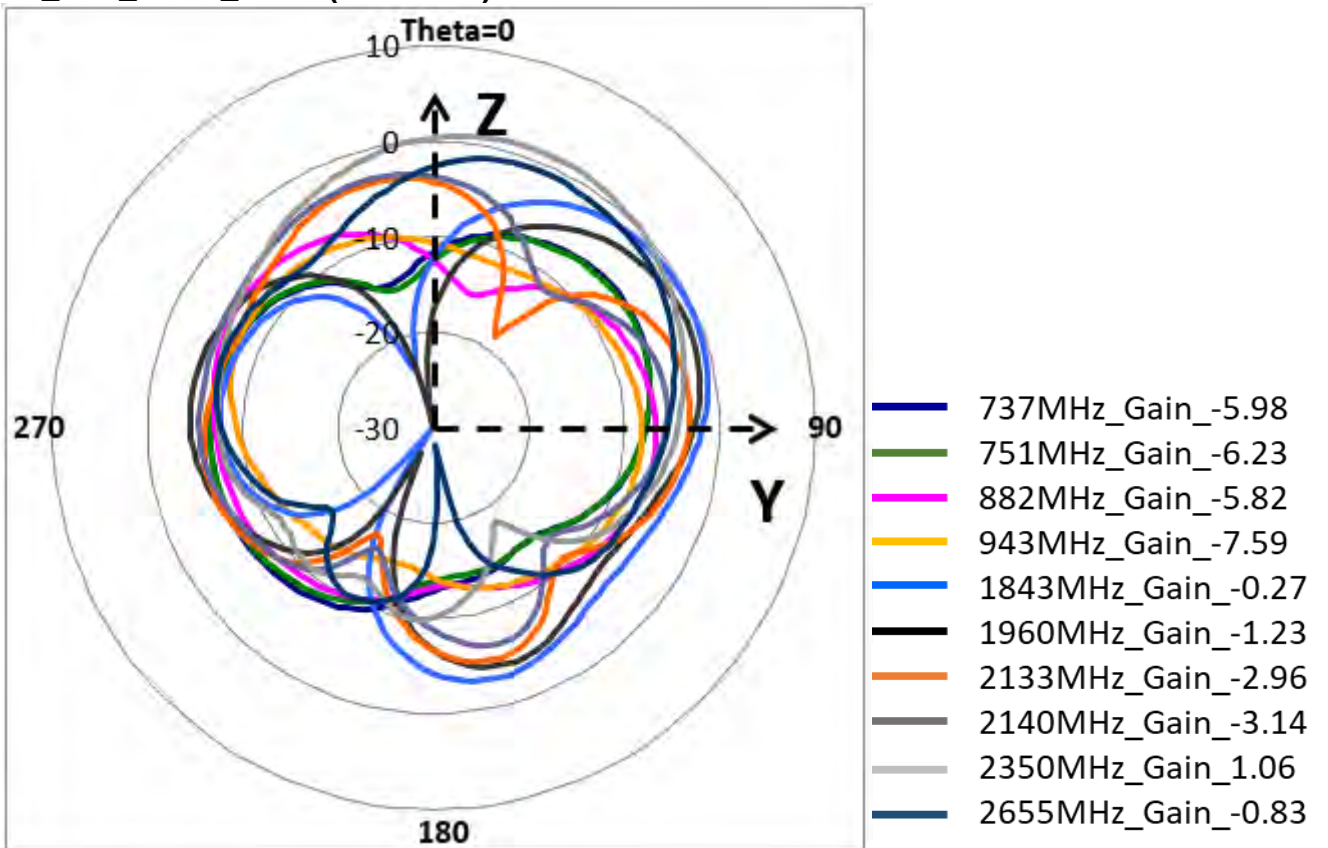

Ant. Position : BLE Ant.7

XY_Pol._Phi_Ant.7

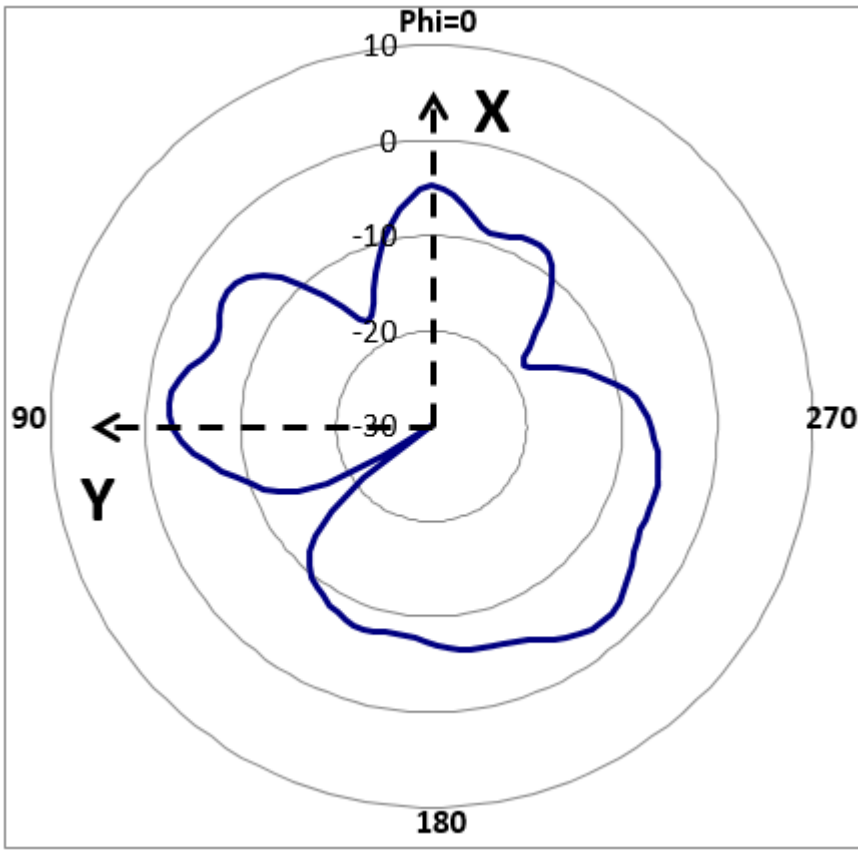

2450MHz_Gain_-2.32

XY_Pol._Theta_Ant.7

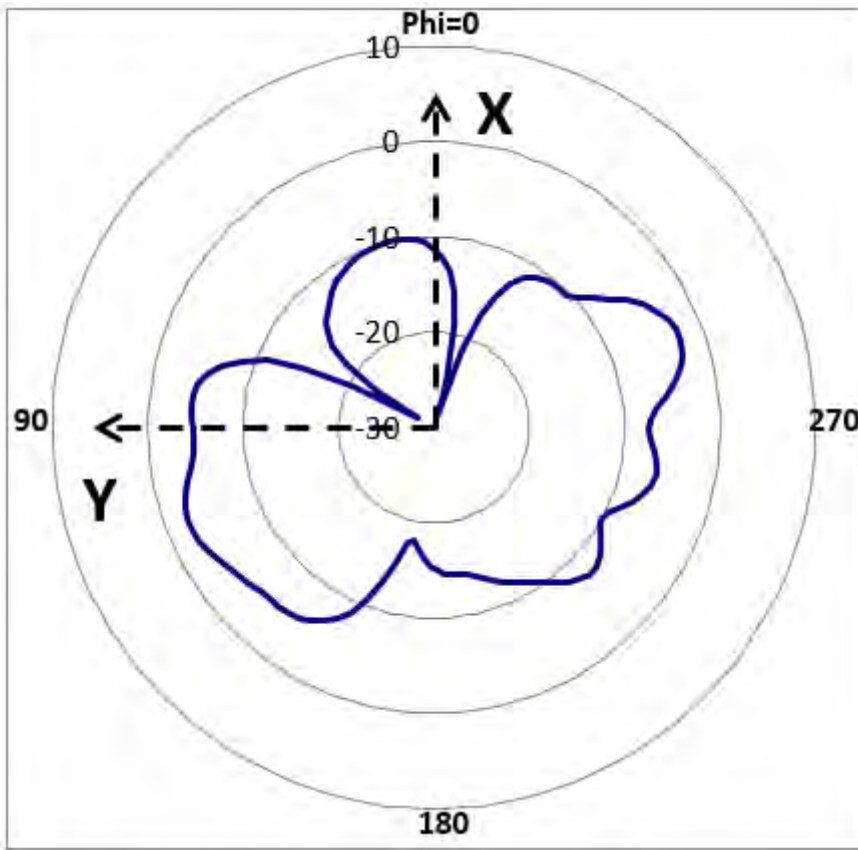

2450MHz_Gain_-2.47

XZ_Pol._Phi_Ant.7

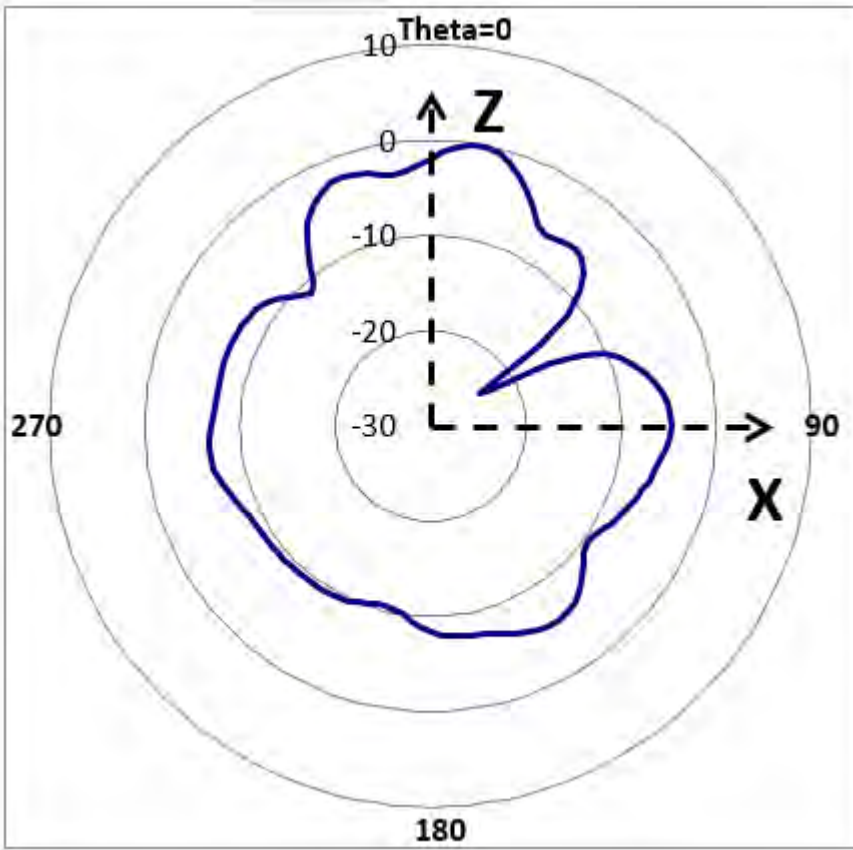

— 2450MHz_Gain_-0.10

XZ_Pol._Theta_Ant.7

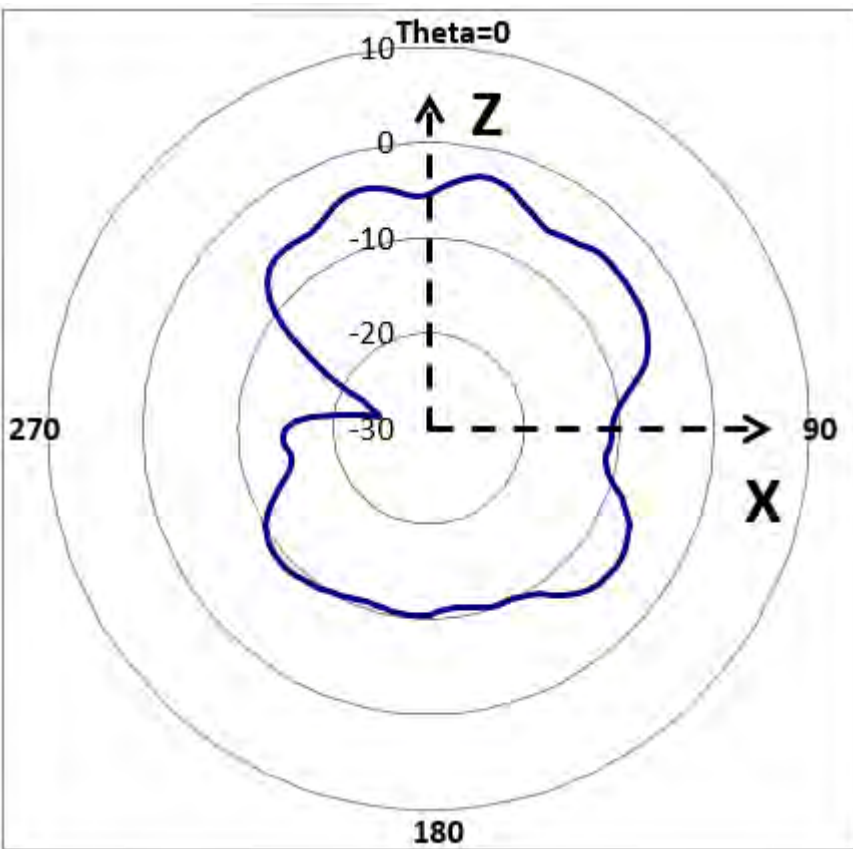

— 2450MHz_Gain_-2.99

YZ_Pol._Phi_Ant.7

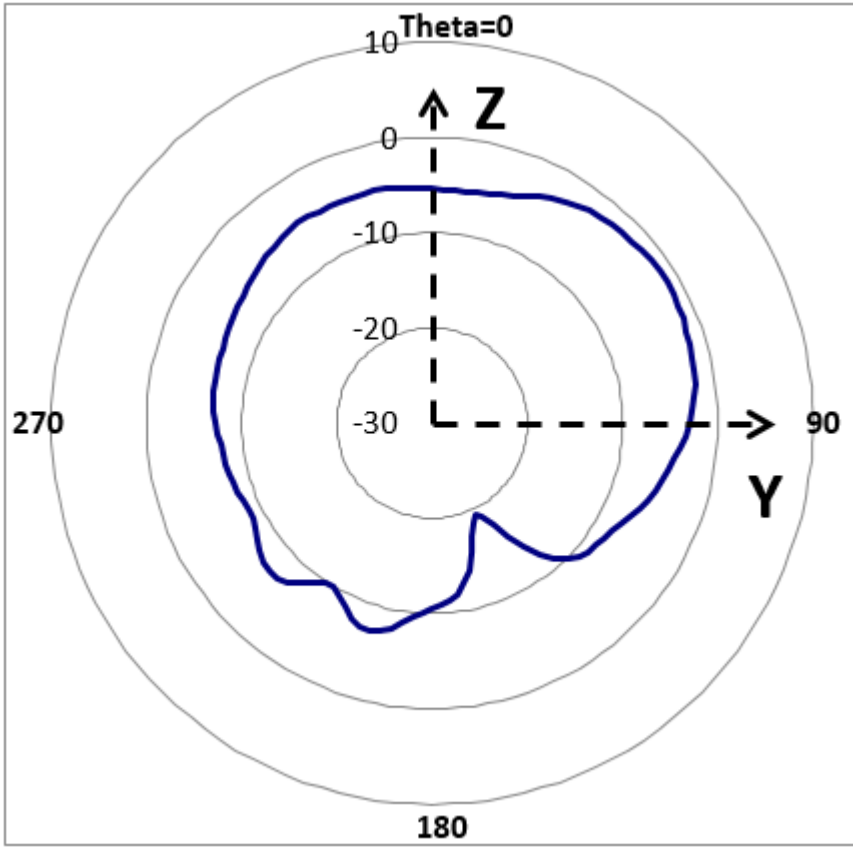

— 2450MHz_Gain_-1.25

YZ_Pol._Theta_Ant.7

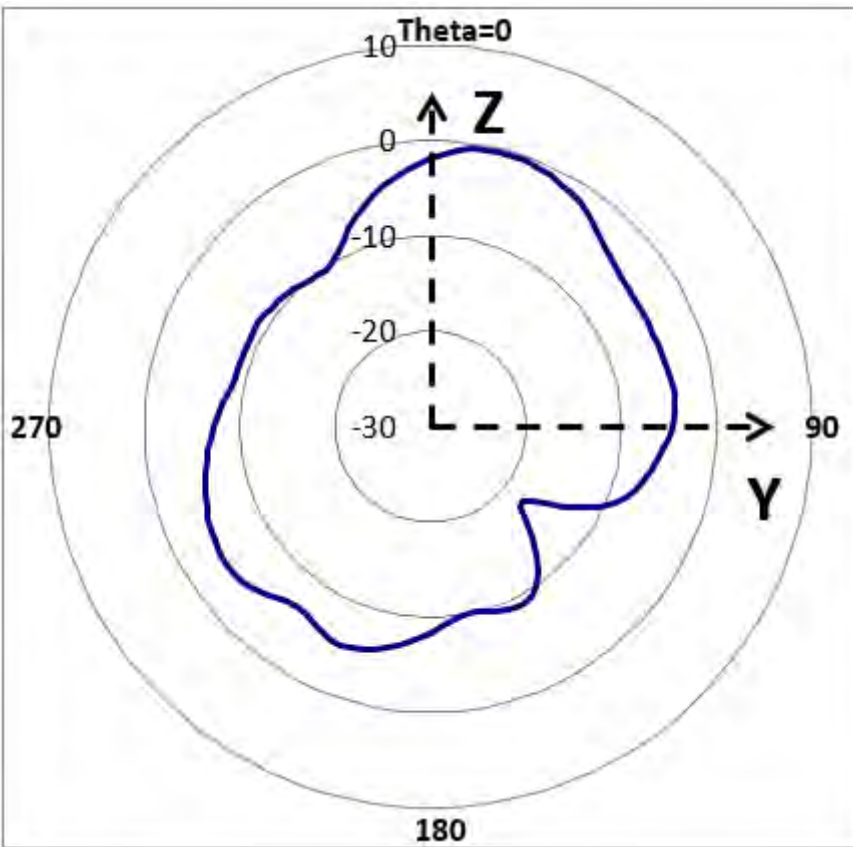

— 2450MHz_Gain_-0.30

Table with 180 columns (0-180) and 35 rows (1-35). Each cell contains a numerical value representing a data point for a specific row and column.

Table with 180 columns (0-180) and 35 rows (1-35). Each cell contains a numerical value representing a data point for a specific row and column.

Table with 180 columns (5895, 5896, ..., 1880) and 180 rows. Each cell contains a numerical value representing a data point for a specific antenna element.

Ant. Position : 2G/5G Ant.2

Table with 180 columns (2450, 2451, ..., 1880) and 180 rows. Each cell contains a numerical value representing a data point for a specific antenna element.

Table with 18 columns (0-180) and 35 rows (0-35). Each cell contains a numerical value representing data points for various parameters.

Table with 18 columns (0-180) and 35 rows (0-35). Each cell contains a numerical value representing data points for various parameters.

Table with 180 columns (5856, 5857, 5858, 5859, 5860, 5861, 5862, 5863, 5864, 5865, 5866, 5867, 5868, 5869, 5870, 5871, 5872, 5873, 5874, 5875, 5876, 5877, 5878, 5879, 5880, 5881, 5882, 5883, 5884, 5885, 5886, 5887, 5888, 5889, 5890, 5891, 5892, 5893, 5894, 5895, 5896, 5897, 5898, 5899, 5900, 5901, 5902, 5903, 5904, 5905, 5906, 5907, 5908, 5909, 5910, 5911, 5912, 5913, 5914, 5915, 5916, 5917, 5918, 5919, 5920, 5921, 5922, 5923, 5924, 5925, 5926, 5927, 5928, 5929, 5930, 5931, 5932, 5933, 5934, 5935, 5936, 5937, 5938, 5939, 5940, 5941, 5942, 5943, 5944, 5945, 5946, 5947, 5948, 5949, 5950, 5951, 5952, 5953, 5954, 5955, 5956, 5957, 5958, 5959, 5960, 5961, 5962, 5963, 5964, 5965, 5966, 5967, 5968, 5969, 5970, 5971, 5972, 5973, 5974, 5975, 5976, 5977, 5978, 5979, 5980, 5981, 5982, 5983, 5984, 5985, 5986, 5987, 5988, 5989, 5990, 5991, 5992, 5993, 5994, 5995, 5996, 5997, 5998, 5999, 6000) and 180 rows of numerical data.

Table with 180 columns (5856, 5857, 5858, 5859, 5860, 5861, 5862, 5863, 5864, 5865, 5866, 5867, 5868, 5869, 5870, 5871, 5872, 5873, 5874, 5875, 5876, 5877, 5878, 5879, 5880, 5881, 5882, 5883, 5884, 5885, 5886, 5887, 5888, 5889, 5890, 5891, 5892, 5893, 5894, 5895, 5896, 5897, 5898, 5899, 5900, 5901, 5902, 5903, 5904, 5905, 5906, 5907, 5908, 5909, 5910, 5911, 5912, 5913, 5914, 5915, 5916, 5917, 5918, 5919, 5920, 5921, 5922, 5923, 5924, 5925, 5926, 5927, 5928, 5929, 5930, 5931, 5932, 5933, 5934, 5935, 5936, 5937, 5938, 5939, 5940, 5941, 5942, 5943, 5944, 5945, 5946, 5947, 5948, 5949, 5950, 5951, 5952, 5953, 5954, 5955, 5956, 5957, 5958, 5959, 5960, 5961, 5962, 5963, 5964, 5965, 5966, 5967, 5968, 5969, 5970, 5971, 5972, 5973, 5974, 5975, 5976, 5977, 5978, 5979, 5980, 5981, 5982, 5983, 5984, 5985, 5986, 5987, 5988, 5989, 5990, 5991, 5992, 5993, 5994, 5995, 5996, 5997, 5998, 5999, 6000) and 180 rows of numerical data.

Table with 180 columns (0-180) and 35 rows (0-35). Each cell contains numerical data representing a response value for a specific angle and response number.

Table with 180 columns (0-180) and 35 rows (0-35). Each cell contains numerical data representing a response value for a specific angle and response number.

Ant. Position : I TE Main Ant.5.

707 (Theta/Ant. E)	0	5	10	15	20	25	30	35	40	45	50	55	60	65	70	75	80	85	90	95	100	105	110	115	120	125	130	135	140	145	150	155	160	165	170	175	180																																																																																																																																																																																																																																																																																																																																																																																																																																																																																																																																																																																																																																																																																																																																																																																																																																																																																																																																																																																																																																																																			
Response (dB)	Response (dB)	Response (dB)	Response (dB)	Response (dB)	Response (dB)	Response (dB)	Response (dB)	Response (dB)	Response (dB)	Response (dB)	Response (dB)	Response (dB)	Response (dB)	Response (dB)	Response (dB)	Response (dB)	Response (dB)	Response (dB)	Response (dB)	Response (dB)	Response (dB)	Response (dB)	Response (dB)	Response (dB)	Response (dB)	Response (dB)	Response (dB)	Response (dB)	Response (dB)	Response (dB)	Response (dB)	Response (dB)	Response (dB)	Response (dB)	Response (dB)	Response (dB)	Response (dB)	Response (dB)	Response (dB)																																																																																																																																																																																																																																																																																																																																																																																																																																																																																																																																																																																																																																																																																																																																																																																																																																																																																																																																																																																																																																																																	
-257	-3.73	-4.73	-5.74	-6.73	-7.49	-8.41	-9.21	-10.00	-10.55	-11.25	-11.85	-12.45	-13.05	-13.65	-14.25	-14.85	-15.45	-16.05	-16.65	-17.25	-17.85	-18.45	-19.05	-19.65	-20.25	-20.85	-21.45	-22.05	-22.65	-23.25	-23.85	-24.45	-25.05	-25.65	-26.25	-26.85	-27.45	-28.05	-28.65	-29.25	-29.85	-30.45	-31.05	-31.65	-32.25	-32.85	-33.45	-34.05	-34.65	-35.25	-35.85	-36.45	-37.05	-37.65	-38.25	-38.85	-39.45	-40.05	-40.65	-41.25	-41.85	-42.45	-43.05	-43.65	-44.25	-44.85	-45.45	-46.05	-46.65	-47.25	-47.85	-48.45	-49.05	-49.65	-50.25	-50.85	-51.45	-52.05	-52.65	-53.25	-53.85	-54.45	-55.05	-55.65	-56.25	-56.85	-57.45	-58.05	-58.65	-59.25	-59.85	-60.45	-61.05	-61.65	-62.25	-62.85	-63.45	-64.05	-64.65	-65.25	-65.85	-66.45	-67.05	-67.65	-68.25	-68.85	-69.45	-70.05	-70.65	-71.25	-71.85	-72.45	-73.05	-73.65	-74.25	-74.85	-75.45	-76.05	-76.65	-77.25	-77.85	-78.45	-79.05	-79.65	-80.25	-80.85	-81.45	-82.05	-82.65	-83.25	-83.85	-84.45	-85.05	-85.65	-86.25	-86.85	-87.45	-88.05	-88.65	-89.25	-89.85	-90.45	-91.05	-91.65	-92.25	-92.85	-93.45	-94.05	-94.65	-95.25	-95.85	-96.45	-97.05	-97.65	-98.25	-98.85	-99.45	-100.05	-100.65	-101.25	-101.85	-102.45	-103.05	-103.65	-104.25	-104.85	-105.45	-106.05	-106.65	-107.25	-107.85	-108.45	-109.05	-109.65	-110.25	-110.85	-111.45	-112.05	-112.65	-113.25	-113.85	-114.45	-115.05	-115.65	-116.25	-116.85	-117.45	-118.05	-118.65	-119.25	-119.85	-120.45	-121.05	-121.65	-122.25	-122.85	-123.45	-124.05	-124.65	-125.25	-125.85	-126.45	-127.05	-127.65	-128.25	-128.85	-129.45	-130.05	-130.65	-131.25	-131.85	-132.45	-133.05	-133.65	-134.25	-134.85	-135.45	-136.05	-136.65	-137.25	-137.85	-138.45	-139.05	-139.65	-140.25	-140.85	-141.45	-142.05	-142.65	-143.25	-143.85	-144.45	-145.05	-145.65	-146.25	-146.85	-147.45	-148.05	-148.65	-149.25	-149.85	-150.45	-151.05	-151.65	-152.25	-152.85	-153.45	-154.05	-154.65	-155.25	-155.85	-156.45	-157.05	-157.65	-158.25	-158.85	-159.45	-160.05	-160.65	-161.25	-161.85	-162.45	-163.05	-163.65	-164.25	-164.85	-165.45	-166.05	-166.65	-167.25	-167.85	-168.45	-169.05	-169.65	-170.25	-170.85	-171.45	-172.05	-172.65	-173.25	-173.85	-174.45	-175.05	-175.65	-176.25	-176.85	-177.45	-178.05	-178.65	-179.25	-179.85	-180.45	-181.05	-181.65	-182.25	-182.85	-183.45	-184.05	-184.65	-185.25	-185.85	-186.45	-187.05	-187.65	-188.25	-188.85	-189.45	-190.05	-190.65	-191.25	-191.85	-192.45	-193.05	-193.65	-194.25	-194.85	-195.45	-196.05	-196.65	-197.25	-197.85	-198.45	-199.05	-199.65	-200.25	-200.85	-201.45	-202.05	-202.65	-203.25	-203.85	-204.45	-205.05	-205.65	-206.25	-206.85	-207.45	-208.05	-208.65	-209.25	-209.85	-210.45	-211.05	-211.65	-212.25	-212.85	-213.45	-214.05	-214.65	-215.25	-215.85	-216.45	-217.05	-217.65	-218.25	-218.85	-219.45	-220.05	-220.65	-221.25	-221.85	-222.45	-223.05	-223.65	-224.25	-224.85	-225.45	-226.05	-226.65	-227.25	-227.85	-228.45	-229.05	-229.65	-230.25	-230.85	-231.45	-232.05	-232.65	-233.25	-233.85	-234.45	-235.05	-235.65	-236.25	-236.85	-237.45	-238.05	-238.65	-239.25	-239.85	-240.45	-241.05	-241.65	-242.25	-242.85	-243.45	-244.05	-244.65	-245.25	-245.85	-246.45	-247.05	-247.65	-248.25	-248.85	-249.45	-250.05	-250.65	-251.25	-251.85	-252.45	-253.05	-253.65	-254.25	-254.85	-255.45	-256.05	-256.65	-257.25	-257.85	-258.45	-259.05	-259.65	-260.25	-260.85	-261.45	-262.05	-262.65	-263.25	-263.85	-264.45	-265.05	-265.65	-266.25	-266.85	-267.45	-268.05	-268.65	-269.25	-269.85	-270.45	-271.05	-271.65	-272.25	-272.85	-273.45	-274.05	-274.65	-275.25	-275.85	-276.45	-277.05	-277.65	-278.25	-278.85	-279.45	-280.05	-280.65	-281.25	-281.85	-282.45	-283.05	-283.65	-284.25	-284.85	-285.45	-286.05	-286.65	-287.25	-287.85	-288.45	-289.05	-289.65	-290.25	-290.85	-291.45	-292.05	-292.65	-293.25	-293.85	-294.45	-295.05	-295.65	-296.25	-296.85	-297.45	-298.05	-298.65	-299.25	-299.85	-300.45	-301.05	-301.65	-302.25	-302.85	-303.45	-304.05	-304.65	-305.25	-305.85	-306.45	-307.05	-307.65	-308.25	-308.85	-309.45	-310.05	-310.65	-311.25	-311.85	-312.45	-313.05	-313.65	-314.25	-314.85	-315.45	-316.05	-316.65	-317.25	-317.85	-318.45	-319.05	-319.65	-320.25	-320.85	-321.45	-322.05	-322.65	-323.25	-323.85	-324.45	-325.05	-325.65	-326.25	-326.85	-327.45	-328.05	-328.65	-329.25	-329.85	-330.45	-331.05	-331.65	-332.25	-332.85	-333.45	-334.05	-334.65	-335.25	-335.85	-336.45	-337.05	-337.65	-338.25	-338.85	-339.45	-340.05	-340.65	-341.25	-341.85	-342.45	-343.05	-343.65	-344.25	-344.85	-345.45	-346.05	-346.65	-347.25	-347.85	-348.45	-349.05	-349.65	-350.25	-350.85	-351.45	-352.05	-352.65	-353.25	-353.85	-354.45	-355.05	-355.65	-356.25	-356.85	-357.45	-358.05	-358.65	-359.25	-359.85	-360.45	-361.05	-361.65	-362.25	-362.85	-363.45	-364.05	-364.65	-365.25	-365.85	-366.45	-367.05	-367.65	-368.25	-368.85	-369.45	-370.05	-370.65	-371.25	-371.85	-372.45	-373.05	-373.65	-374.25	-374.85	-375.45	-376.05	-376.65	-377.25	-377.85	-378.45	-379.05	-379.65	-380.25	-380.85	-381.45	-382.05	-382.65	-383.25	-383.85	-384.45	-385.05	-385.65	-386.25	-386.85	-387.45	-388.05	-388.65	-389.25	-389.85	-390.45	-391.05	-391.65	-392.25	-392.85	-393.45	-394.05	-394.65	-395.25	-395.85	-396.45	-397.05	-397.65	-398.25	-398.85	-399.45	-400.05	-400.65	-401.25	-401.85	-402.45	-403.05	-403.65	-404.25	-404.85	-405.45	-406.05	-406.65	-407.25	-407.85	-408.45	-409.05	-409.65	-410.25	-410.85	-411.45	-412.05	-412.65	-413.25	-413.85	-414.45	-415.05	-415.65	-416.25	-416.85	-417.45	-418.05	-418.65	-419.25	-419.85	-420.45	-421.05	-421.65	-422.25	-422.85	-423.45	-424.05	-424.65	-425.25	-425.85	-426.45	-427.05	-427.65	-428.25	-428.85	-429.45	-430.05	-430.65	-431.25	-431.85	-432.45	-433.05	-433.65	-434.25	-434.85	-435.45	-436.05	-436.65	-437.25	-437.85	-438.45	-439.05	-439.65	-440.25	-440.85	-441.45	-442.05	-442.65	-443.25	-443.85	-444.45	-445.05	-445.65	-446.25	-446.85	-447.45	-448.05	-448.65	-449.25	-449.85	-450.45	-451.05	-451.65	-452.25	-452.85	-453.45	-454.05	-454.65	-455.25	-455.85	-456.45	-457.05	-457.65	-458.25	-458.85	-459.45	-460.05	-460.65	-461.25	-461.85	-462.45	-463.05	-463.65	-464.25	-464.85	-465.45	-466.05	-466.65	-467.25	-467.85	-468.45	-469.05	-469.65	-470.25	-470.85	-471.45	-472.05	-472.65	-473.25	-473.85	-474.45	-475.05	-475.65	-476.25	-476.85	-477.45	-478.05	-478.65	-479.25	-479.85	-480.45	-481.05	-481.65	-482.25	-482.85	-483.45	-484.05	-484.65	-485.25	-485.85	-486.45	-487.05	-487.65	-488.25	-488.85	-489.45	-490.05	-490.65	-491.25	-491.85	-492.45	-493.05	-493.65	-494.25	-494.85	-495.45	-496.05	-496.65	-497.25	-497.85	-498.45	-499.05	-499.65	-500.25	-500.85	-501.45	-502.05	-502.65	-503.25	-503.85	-504.45	-505.05	-505.65	-506.25	-506.85	-507.45	-508.05	-508.65	-509.25	-509.85	-510.45	-511.05	-511.65	-512.25	-512.85	-513.45	-514.05	-514.65	-515.25	-515.85	-516.45	-517.05	-517.65	-518.25	-518.85	-519.45	-520.05	-520.65	-521.25	-521.85	-522.45	-523.05	-523.65	-524.25	-524.85	-525.45	-526.05	-526.65	-527.25	-527.85	-528.45	-529.05	-529.65	-530.25	-530.85	-531.45	-532.05	-532.65	-533.25	-533.85	-534.45	-535.05	-535.65	-536.25	-536.85	-537.45	-538.05	-538.65	-539.25	-539.85	-540.45	-541.05	-541.65	-542.25	-542.85	-543.45	-544.05	-544.65	-545.25	-545.85	-546.45	-547.05	-547.65	-548.25	-548.85	-549.45	-550.05	-550.65	-551.25	-551.85	-552.45	-553.05	-553.65	-554.25	-554.85	-555.45	-556.05	-556.65	-557.25	-557.85	-558.45	-559.05	-559.65	-560.25	-560.85	-561.45	-562.05	-562.65	-563.25	-563.85	-564.45	-565.05	-565.65	-566.25	-566.85	-567.45	-568.05	-568.65	-569.25	-569.85	-570.45	-571.05	-571.65	-572.25	-572.85	-573.45	-574.05	-574.65	-575.25	-575.85	-576.45	-577.05	-577.65	-578.25	-578.85	-579.45	-580.05	-580.65	-581.25	-581.85	-582.45	-583.05	-583.65	-584.25	-584.85	-585.45	-586.05	-586.65	-587.25	-587.85	-588.45	-589.05	-589.65	-590.25	-590.85	-591.45	-592.05	-592.65	-593.25	-593.85	-594.45	-595.05	-595.65	-596.25	-596.85	-597.45	-598.05	-598.65	-599.25	-599.85	-600.45	-601.05	-601.65	-602.25	-602.85	-603.45	-604.05	-604.65	-605.25	-605.85	-606.45	-607.05	-607.65	-608.25	-608.85	-609.45	-610.05	-610.65	-611.25	-611.85	-612.45	-613.05	-613.65	-614.25	-614.85	-615.45	-616.05	-616.65	-617.25	-617.85	-618.45	-619.05	-619.65	-620.25	-620.85	-621.45	-622.05	-622.65	-623.25	-623.85	-624.45	-625.05	-625.65	-626.25	-626.85	-627.45	-628.05	-628.65	-629.25	-629.85	-630.45	-631.05	-631.65	-632.25	-632.85	-633.45	-634.05	-634.65	-635.25	-635.85	-636.45	-637.05	-637.65	-638.25	-638.85	-639.45	-640.05	-640.65	-641.25	-641.85	-642.45	-643.05	-643.65

Table with 18 columns (Ph.Ancle, Response, etc.) and 180 rows of numerical data.

Table with 18 columns (Ph.Ancle, Response, etc.) and 180 rows of numerical data.

Table with 180 columns (labeled 0 to 180) and 180 rows (labeled 0 to 180). Each cell contains a numerical value representing a data point for a specific row and column index.

Table with 180 columns (labeled 0 to 180) and 180 rows (labeled 0 to 180). Each cell contains a numerical value representing a data point for a specific row and column index.

Table with 180 columns (Theta/Angle 0 to 180) and 180 rows (Phi/Angle 0 to 180). Each cell contains a numerical value representing a response or gain at a specific angle.

Table with 180 columns (Theta/Angle 0 to 180) and 180 rows (Phi/Angle 0 to 180). Each cell contains a numerical value representing a response or gain at a specific angle.

Table with 173 columns (Theta/Azimuth) and 180 rows (Response values). The table contains numerical data for various angles and response levels.

Table with 173 columns (Theta/Azimuth) and 180 rows (Response values). This table is a continuation of the data from the first table, covering a different range of response values.

Table with 180 columns (0-179) and 35 rows (1-35). Each cell contains a numerical value representing a response or response rate for a specific theta/azimuth angle and frequency.

Table with 180 columns (0-179) and 35 rows (1-35). Each cell contains a numerical value representing a response or response rate for a specific theta/azimuth angle and frequency.

Table with 18 columns (2133 thru 180) and 35 rows of numerical data. Each row contains 18 values corresponding to the columns.

Table with 18 columns (2140 thru 180) and 35 rows of numerical data. Each row contains 18 values corresponding to the columns.

Table with 18 columns (0-180) and 35 rows (1-35). Each cell contains a numerical value representing a response or response rate.

Table with 18 columns (0-180) and 35 rows (1-35). Each cell contains a numerical value representing a response or response rate.

Table with 18 columns (0-180) and 35 rows (1-35). Each cell contains a numerical value representing a response or response rate for a specific frequency and antenna configuration.

Table with 18 columns (0-180) and 35 rows (1-35). Each cell contains a numerical value representing a response or response rate for a specific frequency and antenna configuration.

Table with 180 columns (0-179) and 35 rows (1-35). Each cell contains a numerical value representing a data point for a specific antenna model and frequency.

Table with 180 columns (0-179) and 35 rows (1-35). Each cell contains a numerical value representing a data point for a specific antenna model and frequency.

Table with 180 columns (Theta/Angle 0 to 180) and 35 rows of numerical data. Each cell contains a value representing a specific parameter at a given angle.

Table with 180 columns (Theta/Angle 0 to 180) and 35 rows of numerical data. Each cell contains a value representing a specific parameter at a given angle.

Table with 1733 columns (labeled 0 to 1733) and 180 rows. Each cell contains a numerical value representing a response or response rate for a specific parameter and row index.

Table with 1733 columns (labeled 0 to 1733) and 180 rows. Each cell contains a numerical value representing a response or response rate for a specific parameter and row index.

Table with 184 columns (Theta/Azimuth) and 184 rows (Response). Each cell contains a numerical value representing a response at a specific angle.

Table with 1880 columns (Theta/Azimuth) and 1880 rows (Response). Each cell contains a numerical value representing a response at a specific angle.

Table with 180 columns (1950-1980) and 180 rows. Each cell contains a numerical value representing a response or response rate for a specific year and index.

Table with 180 columns (1950-1980) and 180 rows. Each cell contains a numerical value representing a response or response rate for a specific year and index.

Table with 180 columns (2133, 0, 5, 10, 15, 20, 25, 30, 35, 40, 45, 50, 55, 60, 65, 70, 75, 80, 85, 90, 95, 100, 105, 110, 115, 120, 125, 130, 135, 140, 145, 150, 155, 160, 165, 170, 175, 180) and 180 rows. Each cell contains a numerical value representing a data point for a specific coordinate.

Table with 180 columns (2140, 0, 5, 10, 15, 20, 25, 30, 35, 40, 45, 50, 55, 60, 65, 70, 75, 80, 85, 90, 95, 100, 105, 110, 115, 120, 125, 130, 135, 140, 145, 150, 155, 160, 165, 170, 175, 180) and 180 rows. Each cell contains a numerical value representing a data point for a specific coordinate.

Table with 18 columns: 2550 (Theta/Anz), 0, 5, 10, 15, 20, 25, 30, 35, 40, 45, 50, 55, 60, 65, 70, 75, 80, 85, 90, 95, 100, 105, 110, 115, 120, 125, 130, 135, 140, 145, 150, 155, 160, 165, 170, 175, 180. Each column contains numerical data points for various response types.

Table with 18 columns: 2555 (Theta/Anz), 0, 5, 10, 15, 20, 25, 30, 35, 40, 45, 50, 55, 60, 65, 70, 75, 80, 85, 90, 95, 100, 105, 110, 115, 120, 125, 130, 135, 140, 145, 150, 155, 160, 165, 170, 175, 180. Each column contains numerical data points for various response types.

2655	Theta	Phi	Antenna	0	5	10	15	20	25	30	35	40	45	50	55	60	65	70	75	80	85	90	95	100	105	110	115	120	125	130	135	140	145	150	155	160	165	170	175	180	
(°)	(°)	(°)	(°)	Response (dB)	Response (dB)	Response (dB)	Response (dB)	Response (dB)	Response (dB)	Response (dB)	Response (dB)	Response (dB)	Response (dB)	Response (dB)	Response (dB)	Response (dB)	Response (dB)	Response (dB)	Response (dB)	Response (dB)	Response (dB)	Response (dB)	Response (dB)	Response (dB)	Response (dB)	Response (dB)	Response (dB)	Response (dB)	Response (dB)	Response (dB)	Response (dB)	Response (dB)	Response (dB)	Response (dB)	Response (dB)	Response (dB)	Response (dB)	Response (dB)	Response (dB)	Response (dB)	Response (dB)
40	1.16	1.10	1.34	1.47	1.31	0.84	0.22	-0.26	-0.40	-0.35	-0.44	-0.89	-1.75	-3.00	-4.59	-5.32	-6.04	-6.99	-8.16	-9.39	-10.16	-10.35	-10.35	-10.21	-10.07	-10.11	-10.61	-11.69	-12.82	-12.88	-11.47	-10.53	-10.28	-10.62	-11.40	-12.62	-14.04	-14.63	-14.47	-14.47	
5	1.16	1.13	1.41	1.59	1.50	1.11	0.58	0.13	-0.08	-0.14	-0.31	-0.74	-1.50	-2.57	-3.91	-5.43	-6.93	-8.12	-9.79	-11.01	-12.38	-13.87	-15.47	-16.87	-18.27	-19.67	-21.07	-22.47	-21.64	-19.89	-19.08	-19.90	-20.47	-20.78	-20.80	-21.43	-22.66	-25.09	-24.47	-24.47	
10	1.16	1.16	1.47	1.71	1.68	1.40	0.97	0.54	0.26	0.07	-0.17	-0.58	-1.23	-2.12	-3.20	-4.40	-5.58	-6.85	-7.79	-9.51	-10.61	-12.57	-14.47	-16.47	-18.47	-20.47	-22.47	-21.64	-19.89	-19.08	-20.23	-20.73	-20.77	-21.07	-21.29	-21.29	-21.43	-22.66	-25.09	-24.47	-24.47
15	1.16	1.19	1.53	1.81	1.87	1.60	1.36	0.96	0.60	0.30	-0.04	-0.40	-1.06	-1.78	-2.83	-3.54	-4.44	-5.24	-6.86	-8.28	-9.40	-11.50	-13.47	-15.47	-17.47	-19.47	-21.47	-20.64	-18.89	-18.08	-19.23	-19.73	-19.77	-20.07	-20.29	-20.29	-20.43	-21.66	-24.09	-23.47	-23.47
20	1.16	1.22	1.58	1.91	2.04	1.96	1.71	1.37	0.97	0.55	0.10	-0.40	-0.96	-1.58	-2.54	-3.02	-3.63	-4.31	-5.84	-6.43	-7.71	-9.74	-11.74	-13.74	-15.74	-17.74	-19.74	-18.91	-17.16	-16.35	-17.50	-18.00	-18.04	-18.34	-18.56	-18.56	-18.70	-19.93	-22.36	-21.74	-21.74
25	1.16	1.25	1.63	1.99	2.20	2.21	2.06	1.77	1.36	0.87	0.32	-0.27	-0.85	-1.42	-2.16	-3.10	-3.73	-4.38	-5.92	-6.29	-7.29	-9.29	-11.29	-13.29	-15.29	-17.29	-19.29	-18.46	-16.71	-15.90	-17.05	-17.55	-17.59	-17.89	-18.11	-18.11	-18.25	-19.48	-21.91	-21.29	-21.29
30	1.16	1.27	1.66	2.06	2.33	2.43	2.37	2.15	1.78	1.26	0.65	-0.01	-0.64	-1.20	-1.70	-2.73	-3.36	-4.02	-5.40	-5.95	-6.95	-8.95	-10.95	-12.95	-14.95	-16.95	-18.95	-18.12	-16.37	-15.56	-16.71	-17.21	-17.25	-17.55	-17.77	-17.77	-17.91	-19.14	-21.57	-20.95	-20.95
35	1.16	1.29	1.68	2.10	2.43	2.61	2.64	2.51	2.08	1.72	1.10	0.42	-0.24	-0.84	-1.35	-1.85	-2.50	-3.01	-4.39	-4.94	-5.94	-7.94	-9.94	-11.94	-13.94	-15.94	-17.94	-17.11	-15.36	-14.55	-15.70	-16.20	-16.24	-16.54	-16.76	-16.76	-16.90	-18.13	-20.56	-19.94	-19.94
40	1.16	1.31	1.70	2.13	2.49	2.74	2.86	2.82	2.60	2.30	1.65	1.00	0.33	-0.28	-0.83	-1.35	-1.80	-2.43	-3.22	-3.80	-4.80	-6.80	-8.80	-10.80	-12.80	-14.80	-16.80	-16.00	-14.25	-13.44	-14.59	-15.09	-15.13	-15.43	-15.65	-15.65	-15.79	-17.02	-19.45	-18.83	-18.83
45	1.16	1.32	1.70	2.13	2.52	2.81	3.01	3.06	2.95	2.67	2.02	1.66	1.04	0.44	-0.11	-0.65	-1.22	-1.85	-2.55	-3.26	-3.90	-4.90	-6.90	-8.90	-10.90	-12.90	-14.90	-14.10	-12.35	-11.54	-12.69	-13.19	-13.23	-13.53	-13.75	-13.75	-13.89	-15.12	-17.55	-16.93	-16.93
50	1.16	1.34	1.70	2.13	2.50	2.83	3.08	3.22	3.26	2.74	2.30	1.78	1.24	0.70	0.17	-0.40	-1.04	-1.74	-2.48	-3.23	-3.90	-4.90	-6.90	-8.90	-10.90	-12.90	-14.90	-14.10	-12.35	-11.54	-12.69	-13.19	-13.23	-13.53	-13.75	-13.75	-13.89	-15.12	-17.55	-16.93	-16.93
55	1.16	1.35	1.69	2.08	2.45	2.78	3.07	3.27	3.37	3.33	3.14	2.83	2.42	1.96	1.47	0.95	0.38	-0.24	-0.95	-1.72	-2.52	-3.30	-4.01	-4.61	-5.13	-5.53	-5.77	-5.88	-6.01	-6.45	-7.51	-8.50	-9.50	-10.50	-11.50	-12.50	-13.50	-14.50	-15.50	-16.50	-17.50
60	1.16	1.37	1.69	2.02	2.36	2.68	2.96	3.21	3.36	3.44	3.36	3.16	2.86	2.47	1.96	1.52	0.91	0.35	-0.36	-1.13	-1.96	-2.68	-3.58	-4.27	-4.65	-4.90	-5.06	-5.34	-5.78	-6.84	-7.83	-8.83	-9.83	-10.83	-11.83	-12.83	-13.83	-14.83	-15.83	-16.83	
65	1.16	1.38	1.67	1.96	2.24	2.51	2.78	3.03	3.23	3.35	3.36	3.24	3.00	2.66	2.25	1.77	1.23	0.62	-0.04	-0.84	-1.67	-2.53	-3.35	-4.08	-4.69	-5.20	-5.68	-6.18	-7.24	-8.23	-9.23	-10.23	-11.23	-12.23	-13.23	-14.23	-15.23	-16.23	-17.23	-18.23	
70	1.16	1.39	1.65	1.84	2.11	2.30	2.51	2.72	2.92	3.06	3.10	3.02	2.81	2.50	2.10	1.64	1.11	0.52	-0.15	-0.90	-1.72	-2.56	-3.38	-4.10	-4.70	-5.24	-5.61	-6.54	-7.53	-8.53	-9.53	-10.53	-11.53	-12.53	-13.53	-14.53	-15.53	-16.53	-17.53	-18.53	
75	1.16	1.41	1.65	1.84	2.19	2.37	2.58	2.79	2.93	3.24	3.28	3.20	2.92	2.51	2.09	1.58	1.12	0.61	0.04	-0.59	-1.30	-2.08	-2.88	-3.63	-4.29	-4.84	-5.20	-6.01	-7.00	-8.00	-9.00	-10.00	-11.00	-12.00	-13.00	-14.00	-15.00	-16.00	-17.00	-18.00	
80	1.16	1.43	1.65	1.79	1.85	1.87	1.87	1.80	1.95	1.97	1.93	1.78	1.54	1.18	0.76	0.29	-0.20	-0.73	-1.30	-1.94	-2.63	-3.34	-3.99	-4.54	-5.01	-5.50	-6.14	-7.07	-8.07	-9.07	-10.07	-11.07	-12.07	-13.07	-14.07	-15.07	-16.07	-17.07	-18.07		
85	1.16	1.45	1.66	1.78	1.78	1.71	1.60	1.51	1.43	1.35	1.21	0.90	0.65	0.24	-0.23	-0.71	-1.13	-1.44	-2.12	-2.85	-3.22	-3.80	-4.32	-4.74	-5.10	-5.50	-6.07	-6.94	-7.93	-8.93	-9.93	-10.93	-11.93	-12.93	-13.93	-14.93	-15.93	-16.93	-17.93		
90	1.16	1.47	1.68	1.78	1.76	1.64	1.46	1.26	1.07	0.87	0.62	0.13	-0.62	-1.13	-1.63	-2.08	-2.48	-2.88	-3.30	-3.75	-4.19	-4.57	-4.95	-5.34	-5.74	-6.14	-6.84	-7.83	-8.83	-9.83	-10.83	-11.83	-12.83	-13.83	-14.83	-15.83	-16.83	-17.83			
95	1.16	1.50	1.74	1.85	1.82	1.68	1.48	1.23	0.97	0.68	0.34	-0.08	-0.58	-1.14	-1.72	-2.25	-2.71	-3.11	-3.48	-3.85	-4.23	-4.57	-4.94	-5.00	-5.11	-5.26	-5.56	-6.00	-6.97	-7.97	-8.97	-9.97	-10.97	-11.97	-12.97	-13.97	-14.97	-15.97	-16.97		
100	1.16	1.52	1.80	1.94	1.96	1.86	1.67	1.43	1.15	0.81	0.41	-0.08	-0.65	-1.27	-1.90	-2.50	-3.02	-3.48	-3.91	-4.32	-4.71	-5.02	-5.19	-5.24	-5.21	-5.22	-5.37	-5.76	-6.76	-7.76	-8.76	-9.76	-10.76	-11.76	-12.76	-13.76	-14.76	-15.76	-16.76		
105	1.16	1.55	1.87	2.08	2.16	2.13	2.01	1.80	1.52	1.17	0.72	0.18	-0.44	-1.12	-1.81	-2.46	-3.07	-3.65	-4.19	-4.72	-5.18	-5.58	-5.83	-5.91	-5.86	-5.81	-5.86	-6.25	-7.25	-8.25	-9.25	-10.25	-11.25	-12.25	-13.25	-14.25	-15.25	-16.25	-17.25		
110	1.16	1.58	1.96	2.24	2.41	2.47	2.41	2.25	1.98	1.61	1.12	0.54	-0.13	-0.84	-1.55	-2.25	-2.82	-3.30	-3.78	-4.28	-4.85	-5.52	-6.01	-6.04	-6.03	-6.04	-6.55	-7.55	-8.55	-9.55	-10.55	-11.55	-12.55	-13.55	-14.55	-15.55	-16.55	-17.55			
115	1.16	1.62	2.05	2.42	2.68	2.83	2.84	2.71	2.44	2.03	1.51	0.89	0.21	-0.49	-1.19	-1.88	-2.58	-3.33	-4.12	-4.92	-5.63	-6.12	-6.32	-6.25	-6.06	-5.92	-5.98	-6.32	-7.32	-8.32	-9.32	-10.32	-11.32	-12.32	-13.32	-14.32	-15.32	-16.32	-17.32		
120	1.16	1.65	2.15	2.61	2.96	3.18	3.23	3.12	2.83	2.41	1.87	1.25	0.69	0.07	-0.41	-1.38	-2.08	-2.87	-3.74	-4.65	-5.49	-6.14	-6.51	-6.59	-6.52	-6.50	-6.69	-7.18	-8.18	-9.18	-10.18	-11.18	-12.18	-13.18	-14.18	-15.18	-16.18	-17.18			
125	1.16	1.68	2.26	2.80	3.23	3.50	3.58	3.46	3.17	2.73	2.20	1.61	1.01	0.41	-0.19	-0.82	-1.53	-2.35	-3.27	-4.26	-5.23	-6.06	-6.65	-6.98	-7.15	-7.25	-7.74	-8.46	-9.46	-10.46	-11.46	-12.46	-13.46	-14.46	-15.46	-16.46	-17.46	-18.46			
130	1.16	1.70	2.36	2.96	3.49	3.86	3.93	3.81	3.52	3.08	2.55	1.96	1.34	0.75	0.15	-0.46	-1.28	-2.19	-3.18	-4.19	-5.18	-5.98	-6.65	-7.24	-7.57	-7.57	-7.57	-8.06	-9.06	-10.06	-11.06	-12.06	-13.06	-14.06	-15.06	-16.06	-17.06	-18.06			
135	1.16	1.75	2.46	3.15	3.68	3.99	4																																		

2460 (MHz)	0	5	10	15	20	25	30	35	40	45	50	55	60	65	70	75	80	85	90	95	100	105	110	115	120	125	130	135	140	145	150	155	160	165	170	175	180
Response (dB)	Response (dB)	Response (dB)	Response (dB)	Response (dB)	Response (dB)	Response (dB)	Response (dB)	Response (dB)	Response (dB)	Response (dB)	Response (dB)	Response (dB)	Response (dB)	Response (dB)	Response (dB)	Response (dB)	Response (dB)	Response (dB)	Response (dB)	Response (dB)	Response (dB)	Response (dB)	Response (dB)	Response (dB)	Response (dB)	Response (dB)	Response (dB)	Response (dB)	Response (dB)	Response (dB)	Response (dB)	Response (dB)	Response (dB)	Response (dB)	Response (dB)	Response (dB)	Response (dB)
0	0.02	1.27	1.95	1.67	0.33	-1.48	-2.75	-2.59	-2.12	-2.27	-3.03	-3.82	-3.97	-3.68	-3.55	-3.62	-3.65	-3.92	-3.50	-3.83	-4.40	-4.68	-4.39	-4.01	-3.89	-3.84	-3.66	-3.45	-3.41	-3.59	-3.94	-4.36	-4.83	-5.36	-5.72	-6.32	-5.90
5	0.02	1.32	2.02	1.75	0.46	-1.40	-2.58	-2.33	-1.82	-1.92	-2.61	-3.34	-3.57	-3.55	-3.72	-4.04	-4.21	-4.17	-4.13	-4.29	-4.54	-4.46	-4.01	-3.61	-3.50	-3.54	-3.58	-3.68	-3.88	-4.09	-4.27	-4.45	-4.77	-5.32	-5.78	-6.30	-5.90
10	0.02	1.35	2.08	1.80	0.57	-1.29	-2.40	-2.25	-1.72	-1.75	-2.39	-3.10	-3.30	-3.20	-3.49	-4.04	-4.17	-4.13	-4.29	-4.54	-4.46	-4.01	-3.61	-3.50	-3.54	-3.58	-3.68	-3.88	-4.09	-4.27	-4.45	-4.77	-5.32	-5.78	-6.30	-5.90	
15	0.02	1.38	2.13	1.90	0.71	-1.14	-2.43	-2.31	-1.79	-1.74	-2.29	-3.19	-3.35	-3.20	-3.50	-4.05	-4.06	-4.02	-4.18	-4.43	-4.35	-3.90	-3.50	-3.40	-3.44	-3.48	-3.58	-3.78	-3.99	-4.17	-4.35	-4.67	-5.22	-5.68	-6.20	-5.80	
20	0.02	1.39	2.17	2.01	0.87	-0.95	-2.40	-2.51	-2.00	-1.83	-2.22	-2.96	-3.70	-4.45	-5.32	-6.19	-6.94	-7.66	-8.00	-7.21	-5.71	-4.45	-3.75	-3.51	-3.57	-3.66	-4.48	-5.54	-6.80	-7.27	-8.49	-9.54	-10.51	-11.51	-12.51	-13.51	
25	0.02	1.40	2.20	2.10	1.05	-0.71	-2.33	-2.73	-2.29	-1.97	-2.14	-2.68	-3.38	-4.26	-5.43	-6.75	-7.93	-8.85	-9.89	-7.78	-6.08	-4.81	-4.12	-3.81	-3.74	-3.97	-4.72	-6.12	-7.95	-8.00	-9.59	-10.98	-12.57	-14.16	-15.75	-17.34	
30	0.02	1.39	2.22	2.18	1.25	-0.42	-2.15	-2.89	-2.81	-2.19	-2.09	-2.37	-2.82	-3.79	-5.15	-6.93	-8.70	-9.86	-11.74	-8.35	-6.73	-5.58	-4.86	-4.36	-4.04	-4.11	-4.85	-6.46	-8.00	-10.27	-12.73	-15.44	-18.41	-21.60	-25.00		
35	0.02	1.38	2.21	2.25	1.44	-0.07	-2.03	-2.91	-2.93	-2.62	-2.22	-2.24	-2.84	-3.79	-5.28	-7.06	-8.91	-10.85	-13.04	-8.89	-7.52	-6.58	-5.73	-4.96	-4.34	-4.22	-4.91	-6.59	-8.26	-10.85	-13.66	-16.68	-19.90	-23.34	-26.90		
40	0.02	1.35	2.20	2.30	1.64	0.31	-1.37	-2.41	-3.17	-2.99	-2.65	-2.46	-2.65	-3.00	-3.94	-5.54	-7.36	-8.70	-10.84	-13.36	-15.69	-16.60	-15.61	-13.77	-12.22	-10.95	-9.70	-8.44	-7.15	-5.92	-4.76	-3.61	-2.54	-1.54	-0.64	-0.14	
45	0.02	1.32	2.16	2.32	1.81	0.68	-0.81	-2.24	-3.17	-3.50	-4.00	-4.35	-4.27	-3.84	-3.53	-4.48	-5.62	-6.44	-8.44	-10.46	-12.46	-15.41	-17.41	-19.41	-21.41	-23.41	-25.41	-27.41	-29.41	-31.41	-33.41	-35.41	-37.41	-39.41	-41.41	-43.41	
50	0.02	1.27	2.10	2.32	1.94	1.06	-0.19	-1.56	-2.78	-3.76	-4.28	-4.27	-3.87	-3.52	-3.44	-3.75	-4.27	-4.66	-4.77	-4.74	-4.68	-4.54	-4.29	-4.06	-4.07	-4.58	-5.78	-7.68	-10.01	-12.11	-13.92	-15.44	-16.61	-17.32	-17.99	-18.55	
55	0.02	1.22	2.03	2.28	2.04	1.38	0.39	-1.31	-2.82	-3.93	-4.66	-5.08	-5.11	-4.66	-4.09	-3.82	-3.99	-4.02	-4.06	-4.12	-4.14	-4.13	-4.23	-4.63	-5.40	-6.80	-8.82	-11.24	-13.86	-16.60	-19.46	-22.44	-25.54	-28.84	-32.34		
60	0.02	1.16	1.93	2.21	2.07	1.62	0.90	-1.06	-2.35	-3.84	-5.08	-5.65	-5.59	-5.26	-4.92	-4.62	-4.40	-4.29	-4.36	-4.53	-4.70	-4.88	-5.20	-5.78	-6.73	-8.06	-9.16	-8.94	-7.87	-7.04	-6.61	-6.44	-6.62	-6.93	-7.67		
65	0.02	1.09	1.82	2.11	2.06	1.77	1.29	0.64	-1.13	-1.67	-1.10	-1.28	-1.40	-1.73	-2.16	-2.31	-2.12	-1.81	-1.67	-1.81	-2.12	-2.51	-3.05	-3.72	-4.51	-5.45	-6.52	-7.81	-9.24	-10.80	-12.49	-14.30	-16.24	-18.30	-20.48		
70	0.02	1.01	1.69	1.98	1.98	1.82	1.53	1.10	0.58	0.02	-0.57	-1.14	-1.69	-2.29	-2.92	-3.41	-3.97	-4.46	-4.93	-5.33	-5.73	-6.11	-6.48	-6.87	-7.25	-7.61	-7.95	-8.26	-8.54	-8.79	-9.00	-9.20	-9.41	-9.61	-9.81		
75	0.02	0.93	1.55	1.81	1.85	1.76	1.54	1.01	0.21	-0.52	-1.06	-1.58	-2.14	-2.70	-3.25	-3.77	-4.27	-4.74	-5.19	-5.64	-6.08	-6.51	-6.93	-7.34	-7.73	-8.10	-8.45	-8.76	-9.03	-9.26	-9.46	-9.64	-9.81	-10.00	-10.18		
80	0.02	0.83	1.39	1.63	1.67	1.65	1.57	1.37	1.13	0.98	0.99	1.06	1.05	0.88	0.62	0.40	0.25	0.06	-0.31	-0.88	-1.54	-2.20	-2.90	-3.67	-4.35	-4.78	-5.14	-5.58	-5.97	-6.41	-6.76	-7.15	-7.53	-7.93	-8.32		
85	0.02	0.74	1.23	1.43	1.47	1.47	1.42	1.25	1.02	0.83	0.93	1.05	1.11	1.05	0.91	0.81	0.71	0.50	0.08	-0.58	-1.28	-2.00	-2.84	-3.84	-4.81	-5.44	-5.89	-6.45	-6.91	-7.40	-7.45	-8.06	-8.21	-7.67	-6.83		
90	0.02	0.64	1.06	1.23	1.26	1.27	1.23	1.09	0.84	0.85	0.61	0.66	0.66	0.67	0.46	0.41	0.34	0.09	-0.43	-1.17	-1.96	-2.76	-3.73	-5.02	-6.41	-7.39	-7.97	-8.62	-9.08	-9.83	-9.66	-8.29	-6.51	-6.36	-6.68		
95	0.02	0.54	0.89	1.04	1.07	1.00	1.00	0.80	0.59	0.47	0.41	0.30	0.11	-0.09	-0.19	-0.32	-0.50	-0.70	-1.00	-1.30	-2.22	-3.10	-4.12	-5.24	-6.63	-8.04	-10.50	-13.40	-17.13	-21.23	-25.21	-29.51	-34.01	-38.61			
100	0.02	0.43	0.73	0.86	0.90	0.93	1.03	1.06	1.01	0.91	0.82	0.74	0.58	0.33	0.02	-0.24	-0.52	-0.80	-1.13	-1.50	-2.02	-2.57	-3.64	-4.45	-5.11	-5.85	-6.84	-8.13	-10.00	-12.33	-15.02	-18.09	-21.44	-25.00			
105	0.02	0.33	0.58	0.70	0.78	0.88	1.06	1.25	1.38	1.44	1.45	1.25	0.97	0.60	-0.20	-0.22	-0.82	-1.27	-1.89	-2.60	-3.53	-4.72	-5.72	-6.59	-7.32	-8.19	-9.18	-10.32	-11.60	-13.00	-14.50	-16.10	-17.80	-19.60			
110	0.02	0.23	0.43	0.58	0.69	0.86	1.13	1.45	1.71	1.88	1.93	1.88	1.70	1.39	0.85	0.45	0.06	-0.71	-1.64	-2.66	-4.04	-5.69	-7.55	-9.35	-11.54	-13.95	-16.32	-18.35	-20.99	-23.75	-27.11	-30.66	-34.41	-38.34	-42.41		
115	0.02	0.13	0.30	0.40	0.45	0.65	1.00	1.54	1.84	1.99	1.96	1.61	1.20	0.67	0.09	-0.48	-1.13	-2.03	-3.31	-4.89	-6.42	-8.19	-10.30	-12.81	-16.20	-19.97	-24.60	-29.60	-34.90	-40.40	-46.10	-52.00	-58.10	-64.40	-70.90		
120	0.02	0.04	0.19	0.41	0.62	0.86	1.15	1.47	1.83	1.72	1.57	1.30	0.91	0.33	-0.24	-0.80	-1.50	-2.11	-3.23	-4.16	-5.68	-7.91	-10.09	-12.01	-14.51	-18.32	-22.94	-28.44	-34.74	-41.60	-48.10	-55.20	-62.50	-70.00	-77.60		
125	0.02	-0.05	-0.09	0.36	0.62	0.84	1.05	1.23	1.27	1.09	0.73	0.30	-0.10	-0.74	-1.30	-2.06	-2.82	-3.12	-3.83	-4.91	-6.15	-7.62	-9.52	-12.07	-15.07	-18.43	-22.60	-27.00	-31.60	-36.40	-41.40	-46.60	-52.00	-57.60	-63.40		
130	0.02	-0.14	0.01	0.33	0.62	0.78	0.66	0.85	0.64	0.22	-0.20	-0.80	-1.20	-1.60	-2.10	-2.65	-3.12	-3.53	-4.13	-5.09	-6.68	-7.78	-9.00	-10.60	-12.60	-14.60	-16.60	-18.60	-20.60	-22.60	-24.60	-26.60	-28.60	-30.60	-32.60		
135	0.02	-0.22	-0.20	0.32	0.61	0.70	0.62	0.37	-0.08	-0.68	-1.24	-1.57	-1.80	-2.10	-2.56	-2.98	-3.36	-3.97	-4.97	-6.60	-7.70	-9.50	-11.20	-13.20	-15.20	-17.20	-19.20	-21.20	-23.20	-25.20	-27.20	-29.20	-31.20	-33.20	-35.20		
140	0.02	-0.30	-0.12	0.31	0.60	0.59	0.33	-0.14	-0.75	-1.36	-1.74	-1.81	-1.70	-1.68	-1.90	-2.35	-2.76	-3.12	-3.68	-4.44	-5.89	-7.41	-9.41	-11.41	-13.41	-15.41	-17.41	-19.41	-21.41	-23.41	-25.41	-27.41	-29.41	-31.41	-33.41		
145	0.02	-0.38	-0.10	0.30	0.56	0.46	0.03	-0.60	-1.25	-1.70	-1.84	-1.74	-1.60	-1.65	-1.98	-2.42	-2.81	-3.19	-3.76	-4.73	-6.27	-7.70	-9.35	-11.35	-13.35	-15.35	-17.35	-19.35	-21.35	-23.35	-25.35	-27.35	-29.35	-31.35	-33.35		
150	0.02	-0.45	-0.22	0.29	0.53	0.32	-0.26	-0.97	-1.55	-1.81	-1.81	-1.73	-1.75	-2.02	-2.51	-2.97	-3.29	-3.67	-4.19	-5.37	-7.14	-9.25	-11.40	-13.40	-15.40	-17.40	-19.40	-21.40	-23.40	-25.40	-27.40	-29.40	-31.40	-33.40			
155	0.02</																																				