

Company: Hewlett Packard Enterprise

Test of: APINR203 & APINP203 (1x1)

To: FCC CFR 47 Part 15 Subpart E 15.407

Report No.: HPEN96-U12 Rev A (1x1)

**TEST REPORT (CONDUCTED & RADIATED DATA)**





Test of: Hewlett Packard Enterprise APINR203 & APINP203 (1x1)

to

To: FCC CFR 47 Part 15 Subpart E 15.407

Test Report Serial No.: HPEN96-U12 Rev A (1x1)

This report supersedes: NONE

As a result of the 6 Mbyte FCC file size limitation potentially large test reports require to be split into smaller components. This DFS report combined with the reports listed in the table below demonstrate compliance with the 15.407 standard.

Test Reports
HPEN96-U12_DFS
HPEN96-U12 Rev A (1x1) (Conducted & Radiated Data)
HPEN96-U12 Rev A (2x2) (Conducted & Radiated Data)

Applicant: Hewlett Packard Enterprise  
3000 Hanover St.  
Palo Alto, California 94034  
USA

Product Function: Wireless LAN Access Point

Issue Date: 13th June 2017

**This Test Report is Issued Under the Authority of:**

**MiCOM Labs, Inc.**  
575 Boulder Court  
Pleasanton California 94566  
USA  
Phone: +1 (925) 462-0304  
Fax: +1 (925) 462-0306  
[www.micomlabs.com](http://www.micomlabs.com)



**MiCOM Labs is an ISO 17025 Accredited Testing Laboratory**



**Title:** Hewlett Packard Enterprise APINR203 & APINP203  
**To:** FCC CFR 47 Part 15 Subpart E 15.407  
**Serial #:** HPEN96-U12 Rev A (1x1) (Conducted & Radiated Data)  
**Issue Date:** 13th June 2017  
**Page:** 3 of 147

---

## Table of Contents

<b>1. ACCREDITATION, LISTINGS &amp; RECOGNITION</b> .....	<b>4</b>
1.1. TESTING ACCREDITATION.....	4
1.2. RECOGNITION .....	5
1.3. PRODUCT CERTIFICATION .....	6
<b>2. DOCUMENT HISTORY</b> .....	<b>7</b>
<b>3. TEST RESULT CERTIFICATE</b> .....	<b>8</b>
<b>4. REFERENCES AND MEASUREMENT UNCERTAINTY</b> .....	<b>9</b>
4.1. Normative References .....	9
4.2. Test and Uncertainty Procedure .....	10
<b>5. PRODUCT DETAILS AND TEST CONFIGURATIONS</b> .....	<b>11</b>
5.1. Technical Details .....	11
5.2. Scope Of Test Program .....	12
5.3. Equipment Model(s) and Serial Number(s) .....	13
5.4. Antenna Details .....	13
5.5. Cabling and I/O Ports .....	13
5.6. Test Configurations.....	14
5.7. Equipment Modifications .....	14
5.8. Deviations from the Test Standard .....	14
<b>6. TEST SUMMARY</b> .....	<b>15</b>
<b>7. TEST EQUIPMENT CONFIGURATION(S)</b> .....	<b>16</b>
7.1. Conducted .....	16
7.2. Radiated Emissions - 3m Chamber.....	18
<b>8. MEASUREMENT AND PRESENTATION OF TEST DATA</b> .....	<b>21</b>
<b>9. TEST RESULTS</b> .....	<b>22</b>
9.1. Peak Transmit Power .....	22
9.2. 26 dB & 99% Bandwidth .....	32
9.3. Power Spectral Density .....	41
9.4. Radiated .....	51
9.4.1. <i>TX Spurious &amp; Restricted Band Emissions</i> .....	54
9.4.2. <i>Restricted Edge &amp; Band-Edge Emissions</i> .....	60
<b>A. APPENDIX - GRAPHICAL IMAGES</b> .....	<b>69</b>
A.1. 26 dB & 99% Bandwidth .....	70
A.2. Power Spectral Density .....	91
A.3. Radiated .....	133
A.3.1. <i>TX Spurious &amp; Restricted Band Emissions</i> .....	133
A.3.2. <i>Restricted Edge &amp; Band-Edge Emissions</i> .....	139

---

This test report may be reproduced in full only. The document may only be updated by MiCOM Labs personnel. All changes will be noted in the Document History section of the report.

## 1. ACCREDITATION, LISTINGS & RECOGNITION

### 1.1. TESTING ACCREDITATION

MiCOM Labs, Inc. is an accredited Electrical testing laboratory per the international standard ISO/IEC 17025:2005. The company is accredited by the American Association for Laboratory Accreditation (A2LA) [www.a2la.org](http://www.a2la.org) test laboratory number 2381.01. MiCOM Labs test schedule is available at the following URL; <http://www.a2la.org/scopepdf/2381-01.pdf>



### Accredited Laboratory

A2LA has accredited

**MICOM LABS**

Pleasanton, CA

for technical competence in the field of

**Electrical Testing**

This laboratory is accredited in accordance with the recognized International Standard ISO/IEC 17025:2005 General requirements for the competence of testing and calibration laboratories. This accreditation demonstrates technical competence for a defined scope and the operation of a laboratory quality management system (refer to joint ISO-ILAC-IAF Communiqué dated 8 January 2009).



Presented this 4<sup>th</sup> day of February 2016.

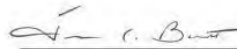

Senior Director of Quality & Communications  
For the Accreditation Council  
Certificate Number 2381.01  
Valid to November 30, 2017

For the tests or types of tests to which this accreditation applies, please refer to the laboratory's Electrical Scope of Accreditation.



This test report may be reproduced in full only. The document may only be updated by MiCOM Labs personnel. All changes will be noted in the Document History section of the report.



## 1.2. RECOGNITION

MiCOM Labs, Inc has widely recognized wireless testing capabilities. Our international recognition includes Conformity Assessment Body designation by APEC MRA countries. MiCOM Labs test reports are accepted globally.

Country	Recognition Body	Status	Phase	Identification No.
USA	Federal Communications Commission (FCC)	TCB	-	US0159 Listing #: 102167
Canada	Industry Canada (IC)	FCB	APEC MRA 2	US0159 Listing #: 4143A-2 4143A-3
Japan	MIC (Ministry of Internal Affairs and Communication)	CAB	APEC MRA 2	RCB 210
	VCCI	--	--	A-0012
Europe	European Commission	NB	EU MRA	NB 2280
Australia	Australian Communications and Media Authority (ACMA)	CAB	APEC MRA 1	US0159
Hong Kong	Office of the Telecommunication Authority (OFTA)	CAB	APEC MRA 1	
Korea	Ministry of Information and Communication Radio Research Laboratory (RRL)	CAB	APEC MRA 1	
Singapore	Infocomm Development Authority (IDA)	CAB	APEC MRA 1	
Taiwan	National Communications Commission (NCC) Bureau of Standards, Metrology and Inspection (BSMI)	CAB	APEC MRA 1	
Vietnam	Ministry of Communication (MIC)	CAB	APEC MRA 1	

EU MRA – European Union Mutual Recognition Agreement.

NB – Notified Body

APEC MRA – Asia Pacific Economic Community Mutual Recognition Agreement. Recognition agreement under which test lab is accredited to regulatory standards of the APEC member countries.

Phase I - recognition for product testing

Phase II – recognition for both product testing and certification

### 1.3. PRODUCT CERTIFICATION

MiCOM Labs, Inc. is an accredited Product Certification Body per the international standard ISO/IEC 17065:2012. The company is accredited by the American Association for Laboratory Accreditation (A2LA) [www.a2la.org](http://www.a2la.org) test laboratory number 2381.02. MiCOM Labs test schedule is available at the following URL; <http://www.a2la.org/scopepdf/2381-02.pdf>



**Accredited Product Certification Body**

A2LA has accredited  
**MICOM LABS**  
Pleasanton, CA

This product certification body is accredited in accordance with the recognized International Standard ISO/IEC 17065:2012 *Requirements for bodies certifying products, processes and services*. This accreditation demonstrates technical competence for a defined scope and the operation of a management system.



Presented this 4<sup>th</sup> day of February 2016.



Senior Director of Quality & Communications  
For the Accreditation Council  
Certificate Number 2381.02  
Valid to November 30, 2017

For the product certification schemes to which this accreditation applies, please refer to the organization's Product Certification Scope of Accreditation.

- United States of America – Telecommunication Certification Body (TCB)
- Industry Canada – Certification Body, CAB Identifier – US0159
- Europe – Notified Body (NB), NB Identifier - 2280
- Japan – Recognized Certification Body (RCB), RCB Identifier - 210

This test report may be reproduced in full only. The document may only be updated by MiCOM Labs personnel. All changes will be noted in the Document History section of the report.



**Title:** Hewlett Packard Enterprise APINR203 & APINP203  
**To:** FCC CFR 47 Part 15 Subpart E 15.407  
**Serial #:** HPEN96-U12 Rev A (1x1) (Conducted & Radiated Data)  
**Issue Date:** 13th June 2017  
**Page:** 7 of 147

---

## 2. DOCUMENT HISTORY

Document History			
Document	Revision	Date	Comments
HPEN96-U12_DFS	Draft	23 <sup>rd</sup> May 2017	Draft for client review
HPEN96-U12 Rev A (1x1)	Draft	23 <sup>rd</sup> May 2017	Draft for client review (Conducted & Radiated Data)
HPEN96-U12_DFS	Rev A	13th June 2017	Initial release (1x1 & 2x2 Data)
HPEN96-U12 Rev A (1x1)	Rev A	13th June 2017	Initial release (Conducted & Radiated Data)

In the above table the latest report revision will replace all earlier versions.

---

This test report may be reproduced in full only. The document may only be updated by MiCOM Labs personnel. All changes will be noted in the Document History section of the report.





**Title:** Hewlett Packard Enterprise APINR203 & APINP203  
**To:** FCC CFR 47 Part 15 Subpart E 15.407  
**Serial #:** HPEN96-U12 Rev A (1x1) (Conducted & Radiated Data)  
**Issue Date:** 13th June 2017  
**Page:** 8 of 147

### 3. TEST RESULT CERTIFICATE

<b>Manufacturer:</b> Hewlett Packard Enterprise 3000 Hanover St. Palo Alto California 94034 USA	<b>Tested By:</b> MiCOM Labs, Inc. 575 Boulder Court Pleasanton California 94566 USA
<b>Model:</b> APINR203 & APINP203	<b>Telephone:</b> +1 925 462 0304
<b>Type Of Equipment:</b> Wireless Access Point	<b>Fax:</b> +1 925 462 0306
<b>S/N's:</b> CNCPK2T006, CNCPK2T00L CNCQK2T03Y (DFS)	
<b>Test Date(s):</b> 31st January to 1st February 2017 12 April – 19 May 2017 (DFS)	<b>Website:</b> www.micomlabs.com

STANDARD(S)	TEST RESULTS
FCC CFR 47 Part 15 Subpart E 15.407	EQUIPMENT COMPLIES

MiCOM Labs, Inc. tested the equipment mentioned in accordance with the requirements set forth in the above standards. Test results indicate that the equipment tested is capable of demonstrating compliance with the requirements as documented within this report.

**Notes:**

1. This document reports conditions under which testing was conducted and the results of testing performed.
2. Details of test methods used have been recorded and kept on file by the laboratory.
3. Test results apply only to the item(s) tested.

**Approved & Released for MiCOM Labs, Inc. by:**

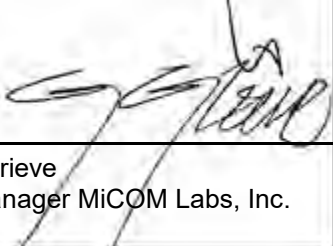

  
 Graeme Grieve  
 Quality Manager MiCOM Labs, Inc.

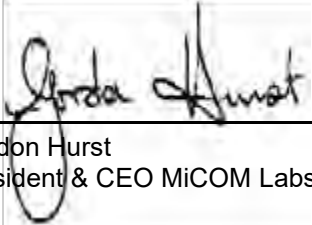
  
 Gordon Hurst  
 President & CEO MiCOM Labs, Inc.

This test report may be reproduced in full only. The document may only be updated by MiCOM Labs personnel. All changes will be noted in the Document History section of the report.



## 4. REFERENCES AND MEASUREMENT UNCERTAINTY

### 4.1. Normative References

REF.	PUBLICATION	YEAR	TITLE
I	KDB 662911 D01 & D02	Oct 31 2013	Guidance for measurement of output emission of devices that employ single transmitter with multiple outputs or systems with multiple transmitters operating simultaneously in the same frequency band
II	KDB 905462 D07 v02	22nd August 2016	Test guidance to demonstrate compliance for U-NII devices subject to DFS requirements.
III	KDB 926956 D01 v02	22nd August 2016	U-NII Device Transition Plan
IV	KDB 789033 D02 v01r03	22nd August 2016	General UNII Test Procedures New Rules
V	A2LA	June 2015	R105 - Requirement's When Making Reference to A2LA Accreditation Status
VI	ANSI C63.10	2013	American National Standard for Testing Unlicensed Wireless Devices
VII	ANSI C63.4	2014	American National Standards for Methods of Measurement of Radio-Noise Emissions from Low-Voltage Electrical and Electronic Equipment in the Range of 9 kHz to 40 GHz
VIII	CISPR 22	2008	Information technology equipment - Radio disturbance characteristics - Limits and methods of measurement
IX	ETSI TR 100 028	2001-12	Parts 1 and 2 Electromagnetic compatibility and Radio Spectrum Matters (ERM); Uncertainties in the measurement of mobile radio equipment characteristics
X	FCC 06-96	Jun 30 2006	Memorandum Opinion and Order
XI	FCC 47 CFR Part 15.407	2016	Radio Frequency Devices; Subpart E –Unlicensed National Information Infrastructure Devices
XII	ICES-003	Issue 6 Jan 2016	Spectrum Management and Telecommunications; Interference-Causing Equipment Standard. Information Technology Equipment (Including Digital Apparatus) – Limits and methods of measurement.
XIII	M 3003	Edition 3 Nov.2012	Expression of Uncertainty and Confidence in Measurements
XIV	RSS-247 Issue 1	May 2015	Digital Transmission Systems (DTSS), Frequency Hopping System (FHSs) and Licence-Exempt Local Area Network (LE-LEN) Devices
XV	RSS-Gen Issue 4	November 2014	General Requirements and Information for the Certification of Radiocommunication Equipment
XVI	KDB 644545 D03 v01	August 14th 2014	Guidance for IEEE 802.11ac New Rules
XVII	FCC 47 CFR Part 2.1033	2016	FCC requirements and rules regarding photographs and test setup diagrams.

This test report may be reproduced in full only. The document may only be updated by MiCOM Labs personnel. All changes will be noted in the Document History section of the report.



**Title:** Hewlett Packard Enterprise APINR203 & APINP203  
**To:** FCC CFR 47 Part 15 Subpart E 15.407  
**Serial #:** HPEN96-U12 Rev A (1x1) (Conducted & Radiated Data)  
**Issue Date:** 13th June 2017  
**Page:** 10 of 147

---

#### **4.2. Test and Uncertainty Procedure**

Conducted and radiated emission measurements were conducted in accordance with American National Standards Institute ANSI C63.4, listed in the Normative References section of this report.

Measurement uncertainty figures are calculated in accordance with ETSI TR 100 028 Parts 1 and 2.

Measurement uncertainties stated are based on a standard uncertainty multiplied by a coverage factor  $k = 2$ , providing a level of confidence of approximately 95 % in accordance with UKAS document M 3003 listed in the Normative References section of this report.

---

This test report may be reproduced in full only. The document may only be updated by MiCOM Labs personnel. All changes will be noted in the Document History section of the report.



**Title:** Hewlett Packard Enterprise APINR203 & APINP203  
**To:** FCC CFR 47 Part 15 Subpart E 15.407  
**Serial #:** HPEN96-U12 Rev A (1x1) (Conducted & Radiated Data)  
**Issue Date:** 13th June 2017  
**Page:** 11 of 147

## 5. PRODUCT DETAILS AND TEST CONFIGURATIONS

### 5.1. Technical Details

Details	Description
Purpose:	Test of the Hewlett Packard Enterprise APINR203 / APINP203 (1x1 mode) to FCC CFR 47 Part 15 Subpart E 15.407. Radio Frequency Devices; Subpart E –Unlicensed National Information Infrastructure Devices
Applicant:	Hewlett Packard Enterprise 3000 Hanover St. Palo Alto California 94034 USA
Manufacturer:	Hewlett Packard Enterprise
Laboratory performing the tests:	MiCOM Labs, Inc. 575 Boulder Court Pleasanton California 94566 USA
Test report reference number:	HPEN96-U12 Draft (1x1)
Date EUT received:	23rd January 2017
Standard(s) applied:	FCC CFR 47 Part 15 Subpart E 15.407
Dates of test (from - to):	31st January to 21st February 2017
No of Units Tested:	2
Product Family Name:	Access Point
Model(s):	APINR203 / APINP203
Location for use:	Indoors
Declared Frequency Range(s):	5250 - 5350 MHz; 5470 - 5725 MHz;
Type of Modulation:	OFDM
EUT Modes of Operation:	5250 - 5350 MHz: 802.11a; ac-80; HT-20; HT-40 5470 - 5725 MHz: 802.11a; ac-80; HT-20; HT-40
Declared Nominal Output Power (dBm):	+20 dBm
Transmit/Receive Operation:	Transceiver - Full Duplex
Rated Input Voltage and Current:	AC 100-240V, APINR203: 0.3A, APINP203: 0.6A
Operating Temperature Range:	Nominal: 20 °C      Max: 40 °C      Min: 0 °C
ITU Emission Designator:	802.11a:            17M1D1D 802.11n - HT20: 17M1D1D 802.11n - HT40: 38M7D1D 802.11ac-80:      78M0D1D
Equipment Dimensions:	155mm x 50mm x 95mm
Weight:	0.320 kg (AP-203R) & 0.340 kg (AP-203RP)
Hardware Rev:	1
Software Rev:	6.5.4.0 6.5.4.0 Build 59274 (DFS)

This test report may be reproduced in full only. The document may only be updated by MiCOM Labs personnel. All changes will be noted in the Document History section of the report.

## 5.2. Scope Of Test Program

### Hewlett Packard Enterprise APINR203 & APINP203

The scope of the test program was to test the Hewlett Packard Enterprise APINR203 & APINP203 configurations in the frequency ranges 5250 - 5350 MHz; 5470 - 5725 MHz in 1x1 antenna mode for compliance against the following specification:

### FCC CFR 47 Part 15 Subpart E 15.407

Radio Frequency Devices; Subpart E –Unlicensed National Information Infrastructure Devices.

### Hewlett Packard Enterprise APINR203 & APINP203

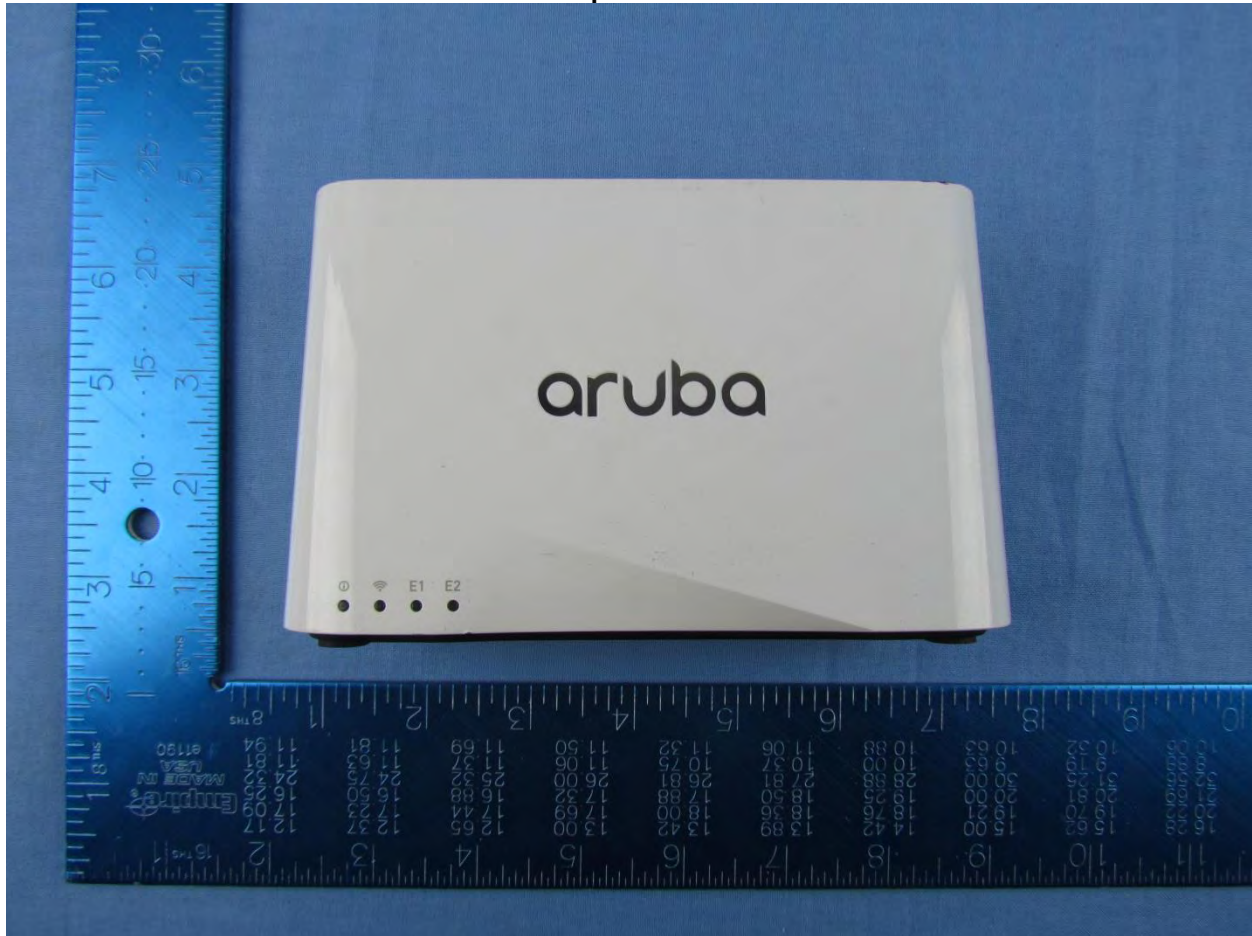

---

This test report may be reproduced in full only. The document may only be updated by MiCOM Labs personnel. All changes will be noted in the Document History section of the report.



**Title:** Hewlett Packard Enterprise APINR203 & APINP203  
**To:** FCC CFR 47 Part 15 Subpart E 15.407  
**Serial #:** HPEN96-U12 Rev A (1x1) (Conducted & Radiated Data)  
**Issue Date:** 13th June 2017  
**Page:** 13 of 147

### 5.3. Equipment Model(s) and Serial Number(s)

Type (EUT/Support)	Equipment Description (Including Brand Name)	Mfr	Model No.	Serial No.
EUT	802.11a/b/g/n	Hewlett Packard Enterprises	APINP203	CNCPK2T006
EUT	802.11a/b/g/n	Hewlett Packard Enterprises	APINP203	CNCPK2T00L
EUT	802.11a/b/g/n	Hewlett Packard Enterprises	APINP203	CNCQK2T03Y (for DFS Testing)
Support	Laptop PC	Dell	E5550	None

### 5.4. Antenna Details

Type	Manufacturer	Model	Family	Gain (dBi)	BF Gain	Dir BW	X-Pol	Frequency Band (MHz)
integral	HPE	Metal Sheet	5	2.9	-	360	-	5150 - 5250
integral	HPE	Metal Sheet	5	2.9	-	360	-	5250 - 5350
integral	HPE	Metal Sheet	5	2.9	-	360	-	5470 - 5725
integral	HPE	Metal Sheet	5	2.9	-	360	-	5725 - 5850

BF Gain - Beamforming Gain  
Dir BW - Directional BeamWidth  
X-Pol - Cross Polarization

### 5.5. Cabling and I/O Ports

Port Type	Max Cable Length	# Of Ports	Screened	Conn Type	Data Type
Ethernet	100	3	N	RJ45	Packet Data
AC Input	N/A	1	N	AC Wire	--
USB	Configuration	1	No	Micro USB	Data
USB	Mgmt only	1	No	USB	Data

This test report may be reproduced in full only. The document may only be updated by MiCOM Labs personnel. All changes will be noted in the Document History section of the report.



## 5.6. Test Configurations

Results for the following configurations are provided in this report:

Operational Mode(s) (802.11a/b/g/n/ac)	Data Rate with Highest Power MBit/s	Channel Frequency (MHz)		
		Low	Mid	High
<b>5250 - 5350 MHz</b>				
a	6	5,260.00	5,300.00	5,320.00
ac-80	29.3	--	--	5,290.00
HT-20	6.5	5,260.00	5,300.00	5,320.00
HT-40	13.5	5,270.00	--	5,310.00
<b>5470 - 5725 MHz</b>				
a	6	5,500.00	5,580.00	5,720.00
ac-80	29.3	5,530.00	5,610.00	5,690.00
HT-20	6.5	5,500.00	5,580.00	5,720.00
HT-40	13.5	5,510.00	5,550.00	5,710.00

## 5.7. Equipment Modifications

The following modifications were required to bring the equipment into compliance:

1. Software updated to 6.5.3.0:59515 in order to bring DFS Probability of Detection into compliance.

## 5.8. Deviations from the Test Standard

The following deviations from the test standard were required in order to complete the test program:

1. NONE



**Title:** Hewlett Packard Enterprise APINR203 & APINP203  
**To:** FCC CFR 47 Part 15 Subpart E 15.407  
**Serial #:** HPEN96-U12 Rev A (1x1) (Conducted & Radiated Data)  
**Issue Date:** 13th June 2017  
**Page:** 15 of 147

---

## 6. TEST SUMMARY

### List of Measurements

Test Header	Result	Data Link
Peak Transmit Power	Complies	<a href="#">View Data</a>
26 dB & 99% Bandwidth	Complies	<a href="#">View Data</a>
Power Spectral Density	Complies	<a href="#">View Data</a>
Dynamic Frequency Selection (DFS)	Complies	HPEN96-U12_DFS
Radiated	Complies	-
TX Spurious & Restricted Band Emissions	Complies	<a href="#">View Data</a>
Restricted Edge & Band-Edge Emissions	Complies	<a href="#">View Data</a>

---

This test report may be reproduced in full only. The document may only be updated by MiCOM Labs personnel. All changes will be noted in the Document History section of the report.



## 7. TEST EQUIPMENT CONFIGURATION(S)

### 7.1. Conducted

Conducted RF Emission Test Set-up(s) The following tests were performed using the conducted test set-up shown in the diagram below.

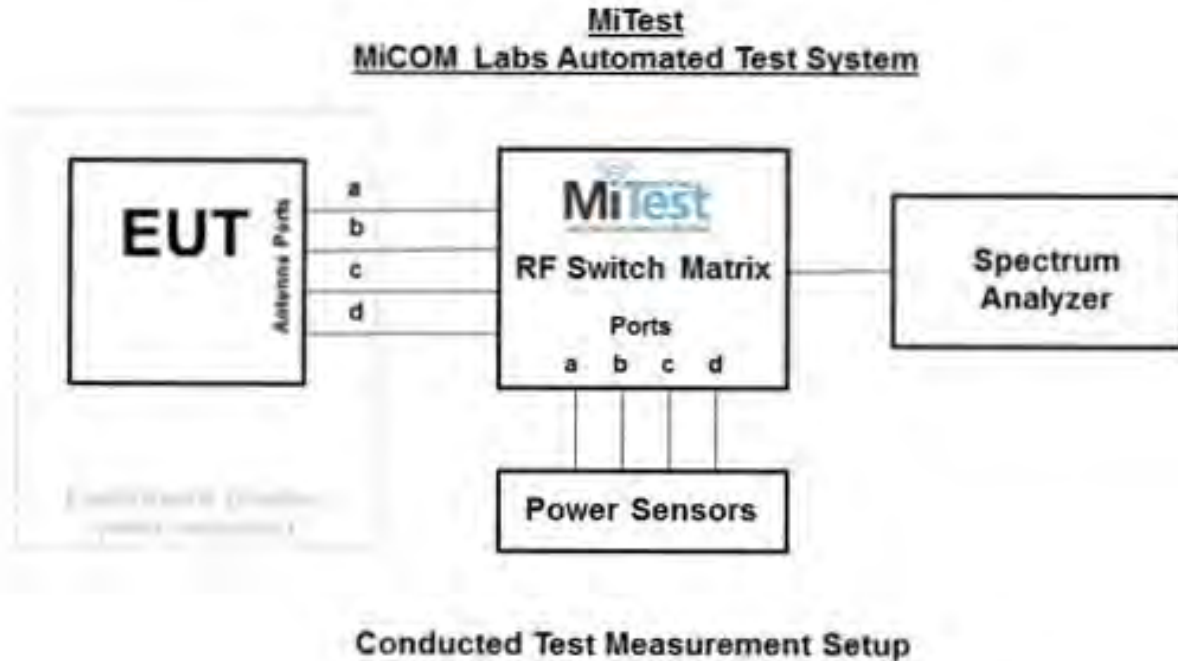

A full system calibration was performed on the test station and any resulting system losses (or gains) were taken into account in the production of all final measurement data.

Asset#	Description	Manufacturer	Model#	Serial#	Calibration Due Date
#3 SA	MiTest Box to SA	Fairview Microwave	SCA1814-0101-72	#3 SA	2 Jun 2017
#3P1	EUT to MiTest box port 1	Fairview Microwave	SCA1814-0101-72	#3P1	2 Jun 2017
#3P2	EUT to MiTest box port 2	Fairview Microwave	SCA1814-0101-72	#3P2	2 Jun 2017
#3P3	EUT to MiTest box port 3	Fairview Microwave	SCA1814-0101-72	#3P3	2 Jun 2017
#3P4	EUT to MiTest box port 4	Fairview Microwave	SCA1812-0101-72	#3P4	2 Jun 2017
158	Barometer/Thermometer	Control Company	4196	E2846	30 Nov 2017
249	Resistance Thermometer	Thermotronics	GR2105-02	9340 #2	23 Oct 2017
287	Rohde & Schwarz 40	Rhode &	ESIB40	100201	2 May 2018

This test report may be reproduced in full only. The document may only be updated by MiCOM Labs personnel. All changes will be noted in the Document History section of the report.



**Title:** Hewlett Packard Enterprise APINR203 & APINP203  
**To:** FCC CFR 47 Part 15 Subpart E 15.407  
**Serial #:** HPEN96-U12 Rev A (1x1) (Conducted & Radiated Data)  
**Issue Date:** 13th June 2017  
**Page:** 17 of 147

	GHz Receiver	Schwarz			
361	Desktop for RF#1, Labview Software installed	Dell	Vostro 220	WS RF#1	Not Required
378	Rohde & Schwarz 40 GHz Receiver with Generator	Rhode & Schwarz	ESIB40	100107/040	4 Aug 2017
390	USB Power Head 50MHz - 24GHz -60 to +20dBm	Agilent	U2002A	MY50000103	17 Oct 2017
398	MiTest RF Conducted Test Software	MiCOM	MiTest ATS	Version 4.1	Not Required
405	DC Power Supply 0-60V	Agilent	6654A	MY4001826	Cal when used
408	USB to GPIB interface	National Instruments	GPIB-USB HS	14C0DE9	Not Required
435	USB Wideband Power Sensor	Boonton	55006	8730	31 Jul 2017
436	USB Wideband Power Sensor	Boonton	55006	8731	14 Sep 2017
441	USB Wideband Power Sensor	Boonton	55006	9179	25 Sep 2017
443	4x4 RF Switch Box	MiCOM Labs	MiTest 4X4 RF Switch Box	MIC003	2 Jun 2017
445	PoE Injector	D-Link	DPE-101GL	QTAH1E2000625	Not Required
461	Spectrum Analyzer	Agilent	E4440A	MY46185537	13 Aug 2017
75	Environmental Chamber	Thermatron	SE-300-2-2	27946	24 Nov 2017

This test report may be reproduced in full only. The document may only be updated by MiCOM Labs personnel. All changes will be noted in the Document History section of the report.

## 7.2. Radiated Emissions - 3m Chamber

The following tests were performed using the radiated test set-up shown in the diagram below;- Radiated emissions below 1GHz. & Radiated Emissions above 1GHz.

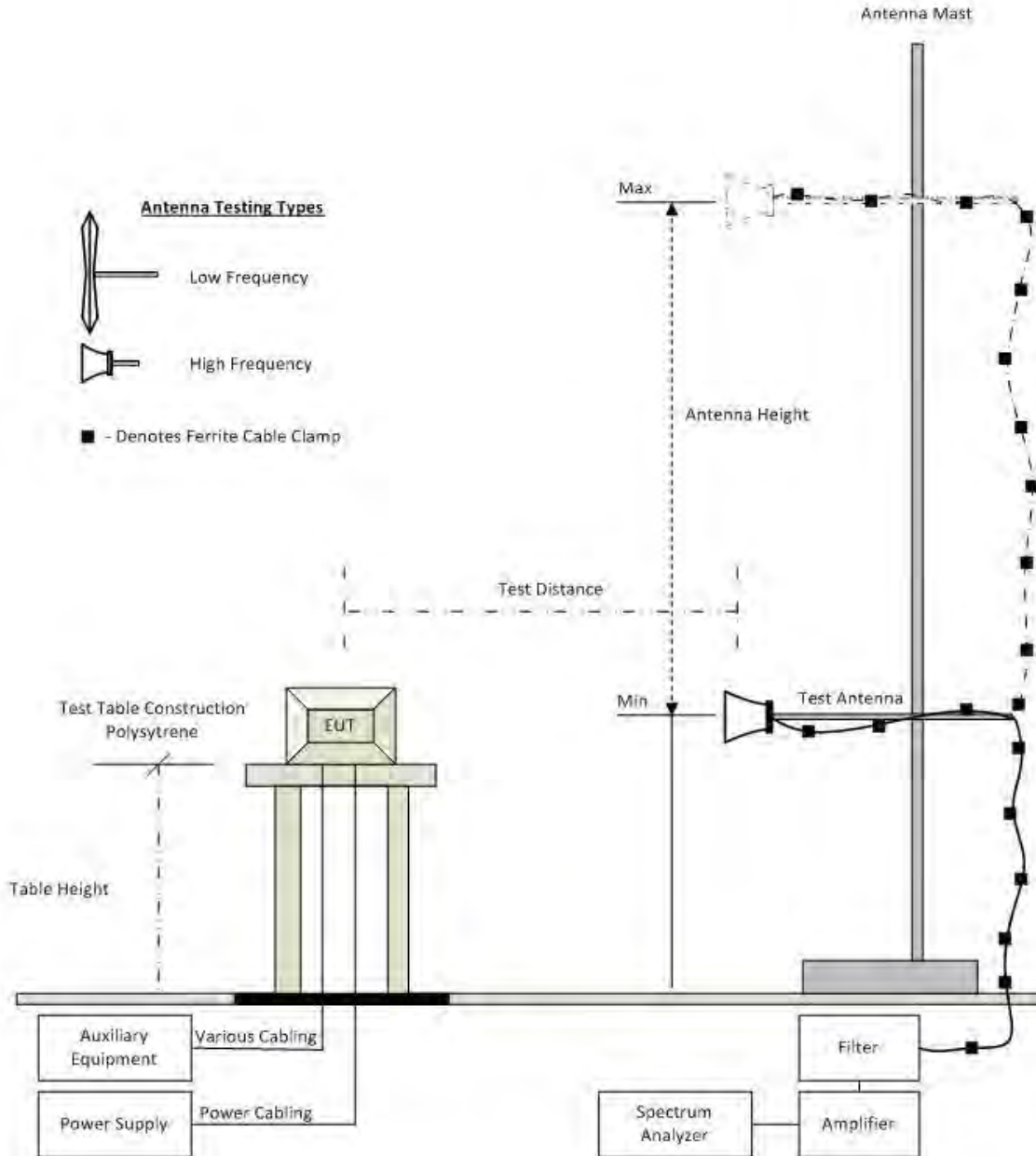

**Radiated Emission Test Setup**

This test report may be reproduced in full only. The document may only be updated by MiCOM Labs personnel. All changes will be noted in the Document History section of the report.



**Title:** Hewlett Packard Enterprise APINR203 & APINP203  
**To:** FCC CFR 47 Part 15 Subpart E 15.407  
**Serial #:** HPEN96-U12 Rev A (1x1) (Conducted & Radiated Data)  
**Issue Date:** 13th June 2017  
**Page:** 19 of 147

A full system calibration was performed on the test station and any resulting system losses (or gains) were taken into account in the production of all final measurement data.

Asset#	Description	Manufacturer	Model#	Serial#	Calibration Due Date
158	Barometer/Thermometer	Control Company	4196	E2846	30 Nov 2017
170	Video System Controller for Semi Anechoic Chamber	Panasonic	WV-CU101	04R08507	Not Required
287	Rohde & Schwarz 40 GHz Receiver	Rhode & Schwarz	ESIB40	100201	2 May 2018
330	Variac 0-280 Vac	Staco Energy Co	3PN1020B	0546	Cal when used
336	Active loop Ant 10kHz to 30 MHz	EMCO	EMCO 6502	00060498	26 Sep 2017
338	Sunol 30 to 3000 MHz Antenna	Sunol	JB3	A052907	15 Aug 2017
373	26III RMS Multimeter	Fluke	Fluke 26 series III	76080720	26 Oct 2017
377	Band Rejection Filter 5150 to 5880MHz	Microtronics	BRM50716	034	16 Aug 2017
378	Rohde & Schwarz 40 GHz Receiver with Generator	Rhode & Schwarz	ESIB40	100107/040	4 Aug 2017
396	2.4 GHz Notch Filter	Microtronics	BRM50701	001	16 Aug 2017
397	Amp 10 - 2500MHz	MiCOM Labs	Amp 10 - 2500 MHz	NA	9 Jun 2017
399	ETS 1-18 GHz Horn Antenna	ETS	3117	00154575	10 Jul 2017
406	Amplifier for Radiated Emissions	MiCOM Labs	40dB 1 to 18GHz Amp	0406	9 Jun 2017
410	Desktop Computer	Dell	Inspiron 620	WS38	Not Required
411	Mast/Turntable Controller	Sunol Sciences	SC98V	060199-1D	Not Required
412	USB to GPIB Interface	National Instruments	GPIB-USB HS	11B8DC2	Not Required
413	Mast Controller	Sunol Science	TWR95-4	030801-3	Not Required
414	DC Power Supply 0-60V	HP	6274	1029A01285	Cal when used
415	Turntable Controller	Sunol Sciences	Turntable Controller	None	Not Required
416	Gigabit ethernet filter	ETS-Lingren	Gigafoil 260366	None	Not Required
447	MiTest Rad Emissions Test Software	MiCOM	Rad Emissions Test Software Version 1.0	447	Not Required
462	Schwarzbeck cable from Antenna to Amplifier.	Schwarzbeck	AK 9513	462	31 May 2017

This test report may be reproduced in full only. The document may only be updated by MiCOM Labs personnel. All changes will be noted in the Document History section of the report.



**Title:** Hewlett Packard Enterprise APINR203 & APINP203  
**To:** FCC CFR 47 Part 15 Subpart E 15.407  
**Serial #:** HPEN96-U12 Rev A (1x1) (Conducted & Radiated Data)  
**Issue Date:** 13th June 2017  
**Page:** 20 of 147

---

463	Schwarzbeck cable from Amplifier to Bulkhead.	Schwarzbeck	AK 9513	463	31 May 2017
464	Schwarzbeck cable from Bulkhead to Receiver	Schwarzbeck	AK 9513	464	31 May 2017
480	Cable - Bulkhead to Amp	SRC Haverhill	157-157-3050360	480	2 Jun 2017
481	Cable - Bulkhead to Receiver	SRC Haverhill	151-151-3050787	481	2 Jun 2017
482	Cable - Amp to Antenna	SRC Haverhill	157-157-3051574	482	2 Jun 2017
87	Uninterruptible Power Supply	Falcon Electric	ED2000-1/2LC	F3471 02/01	Cal when used
VLF-1700	Low pass filter DC-1700 MHz	Mini Circuits	VLF-1700	None	31 May 2017

---

This test report may be reproduced in full only. The document may only be updated by MiCOM Labs personnel. All changes will be noted in the Document History section of the report.

## 8. MEASUREMENT AND PRESENTATION OF TEST DATA

The measurement and graphical data presented in this test report was generated automatically using state-of-the-art technology creating an easy to read report structure. Numerical measurement data is separated from supporting graphical data (plots) through hyperlinks. Numerical measurement data can be reviewed without scrolling through numerous graphical pages to arrive at the next data matrix.

Plots have been relegated into the Appendix 'Graphical Data'.

Test and report automation was performed by [MiTest](#). [MiTest](#) is an automated test system developed by MiCOM Labs. [MiTest](#) is the first cloud based modular test system enabling end-to-end automation of regulatory compliance testing for conducted RF testing.



The MiCOM Labs "[MiTest](#)" Automated Test System" (Patent Pending)

This test report may be reproduced in full only. The document may only be updated by MiCOM Labs personnel. All changes will be noted in the Document History section of the report.





## 9. TEST RESULTS

### 9.1. Peak Transmit Power

Conducted Test Conditions for Maximum Conducted Output Power			
<b>Standard:</b>	FCC CFR 47:15.407	<b>Ambient Temp. (°C):</b>	24.0 - 27.5
<b>Test Heading:</b>	Maximum Conducted Output Power	<b>Rel. Humidity (%):</b>	32 - 45
<b>Standard Section(s):</b>	15.407 (a)	<b>Pressure (mBars):</b>	999 - 1001
<b>Reference Document(s):</b>	See Normative References		

#### Test Procedure for Maximum Conducted Output Power Measurement

Method PM (Measurement using an RF average power meter). KDB 789033 defines a methodology using an average wideband power meter. Measurements were made while the EUT was operating in a continuous transmission mode (100% duty cycle) at the appropriate center frequency. All operational modes and frequency bands were measured independently and the resultant calculated. Where the device operated with multiple antenna ports i.e. MIMO device, each port was measured and reported separately. A summation ( $\Sigma$ ) of each antenna port output power is provided which includes any offset due to Duty Cycle Correction Factor (DCCF). Testing was performed under ambient conditions at nominal voltage.

Test configuration and setup used for the measurement was per the Conducted Test Set-up section specified in this document. Supporting Information

Calculated Power =  $A + G + Y + 10 \log (1/x)$  dBm

A = Total Power [ $10^* \text{Log}_{10} (10^{a/10} + 10^{b/10} + 10^{c/10} + 10^{d/10})$ ]

G = Antenna Gain

Y = Beamforming Gain

x = Duty Cycle (average power measurements only)

#### Limits Maximum Conducted Output Power

##### Operating Frequency Band 5150-5250 MHz

###### 15.407 (a)(1)

(i) For an outdoor access point operating in the band 5.15-5.25 GHz, the maximum conducted output power over the frequency band of operation shall not exceed 1 W provided the maximum antenna gain does not exceed 6 dBi. In addition, the maximum power spectral density shall not exceed 17 dBm in any 1 megahertz band. If transmitting antennas of directional gain greater than 6 dBi are used, both the maximum conducted output power and the maximum power spectral density shall be reduced by the amount in dB that the directional gain of the antenna exceeds 6 dBi. The maximum e.i.r.p. at any elevation angle above 30 degrees as measured from the horizon must not exceed 125 mW (21 dBm).

(ii) For an indoor access point operating in the band 5.15-5.25 GHz, the maximum conducted output power over the frequency band of operation shall not exceed 1 W provided the maximum antenna gain does not exceed 6 dBi. In addition, the maximum power spectral density shall not exceed 17 dBm in any 1 megahertz band. If transmitting antennas of directional gain greater than 6 dBi are used, both the maximum conducted output power and the maximum power spectral density shall be reduced by the amount in dB that the directional gain of the antenna exceeds 6 dBi.

(iii) For fixed point-to-point access points operating in the band 5.15-5.25 GHz, the maximum conducted output power over the frequency band of operation shall not exceed 1 W. In addition, the maximum power spectral density shall not exceed 17 dBm in any 1 megahertz band. Fixed point-to-point U-NII devices may employ antennas with directional gain up to 23 dBi without any corresponding reduction in the maximum conducted output power or maximum power spectral density. For fixed point-to-point transmitters that employ a directional antenna gain greater than 23 dBi, a 1 dB reduction in maximum conducted output power and maximum power spectral density is required for each 1 dB of antenna gain in excess of 23 dBi. Fixed, point-to-point operations exclude the use of point-to-multipoint systems, omnidirectional applications, and multiple collocated transmitters transmitting the same information. The operator of the U-NII device, or if the equipment is professionally installed, the installer, is responsible for ensuring that systems employing high gain directional antennas are used exclusively for fixed, point-to-point operations.

(iv) For mobile and portable client devices in the 5.15-5.25 GHz band, the maximum conducted output power over the frequency band

This test report may be reproduced in full only. The document may only be updated by MiCOM Labs personnel. All changes will be noted in the Document History section of the report.





**Title:** Hewlett Packard Enterprise APINR203 & APINP203  
**To:** FCC CFR 47 Part 15 Subpart E 15.407  
**Serial #:** HPEN96-U12 Rev A (1x1) (Conducted & Radiated Data)  
**Issue Date:** 13th June 2017  
**Page:** 23 of 147

of operation shall not exceed 250 mW provided the maximum antenna gain does not exceed 6 dBi. In addition, the maximum power spectral density shall not exceed 11 dBm in any 1 megahertz band. If transmitting antennas of directional gain greater than 6 dBi are used, both the maximum conducted output power and the maximum power spectral density shall be reduced by the amount in dB that the directional gain of the antenna exceeds 6 dBi.

**Operating Frequency Band 5250-5350 and 5470 – 5725 MHz**

15. 407 (a)(2)

For the 5.25-5.35 GHz and 5.47-5.725 GHz bands, the maximum conducted output power over the frequency bands of operation shall not exceed the lesser of 250 mW or  $11 \text{ dBm} + 10 \log B$ , where B is the 26 dB emission bandwidth in megahertz. In addition, the maximum power spectral density shall not exceed 11 dBm in any 1 megahertz band. If transmitting antennas of directional gain greater than 6 dBi are used, both the maximum conducted output power and the maximum power spectral density shall be reduced by the amount in dB that the directional gain of the antenna exceeds 6 dBi.

**Operating Frequency Band 5725 – 5850 MHz**

15. 407 (a)(3)

For the band 5.725-5.85 GHz, the maximum conducted output power over the frequency band of operation shall not exceed 1 W. In addition, the maximum power spectral density shall not exceed 30 dBm in any 500-kHz band. If transmitting antennas of directional gain greater than 6 dBi are used, both the maximum conducted output power and the maximum power spectral density shall be reduced by the amount in dB that the directional gain of the antenna exceeds 6 dBi. However, fixed point-to-point U-NII devices operating in this band may employ transmitting antennas with directional gain greater than 6 dBi without any corresponding reduction in transmitter conducted power. Fixed, point-to-point operations exclude the use of point-to-multipoint systems, omnidirectional applications, and multiple collocated transmitters transmitting the same information. The operator of the U-NII device, or if the equipment is professionally installed, the installer, is responsible for ensuring that systems employing high gain directional antennas are used exclusively for fixed, point-to-point operations.

This test report may be reproduced in full only. The document may only be updated by MiCOM Labs personnel. All changes will be noted in the Document History section of the report.



**Title:** Hewlett Packard Enterprise APINR203 & APINP203  
**To:** FCC CFR 47 Part 15 Subpart E 15.407  
**Serial #:** HPEN96-U12 Rev A (1x1) (Conducted & Radiated Data)  
**Issue Date:** 13th June 2017  
**Page:** 24 of 147

**Equipment Configuration for Peak Transmit Power**

<b>Variant:</b>	802.11a	<b>Duty Cycle (%):</b>	99.0
<b>Data Rate:</b>	6.00 MBit/s	<b>Antenna Gain (dBi):</b>	2.90
<b>Modulation:</b>	OFDM	<b>Beam Forming Gain (Y)(dB):</b>	Not Applicable
<b>TPC:</b>	Not Applicable	<b>Tested By:</b>	SB
<b>Engineering Test Notes:</b>			

**Test Measurement Results**

Test Frequency	Measured Conducted Output Power (dBm)				Calculated Total Power	Minimum 26 dB Bandwidth	Limit	Margin	EUT Power Setting
	Port(s)								
MHz	a	b	c	d	Σ Port(s) dBm	MHz	dBm	dB	
5260.0	16.40				16.40	23.407	24.00	-7.60	72.00
5300.0	16.68				16.68	26.293	24.00	-7.32	72.00
5320.0	14.82				14.82	24.609	24.00	-9.18	63.00

**Traceability to Industry Recognized Test Methodologies**

Work Instruction:	WI-03 MEASURING RF SPECTRUM MASK
Measurement Uncertainty:	±2.81 dB

The above measurements are true pulse readings and therefore a Duty Cycling correction factor is not required.

This test report may be reproduced in full only. The document may only be updated by MiCOM Labs personnel. All changes will be noted in the Document History section of the report.



**Title:** Hewlett Packard Enterprise APINR203 & APINP203  
**To:** FCC CFR 47 Part 15 Subpart E 15.407  
**Serial #:** HPEN96-U12 Rev A (1x1) (Conducted & Radiated Data)  
**Issue Date:** 13th June 2017  
**Page:** 25 of 147

<b>Variant:</b>	802.11ac-80	<b>Duty Cycle (%):</b>	80.0
<b>Data Rate:</b>	29.30 MBit/s	<b>Antenna Gain (dBi):</b>	2.90
<b>Modulation:</b>	OFDM	<b>Beam Forming Gain (Y)(dB):</b>	Not Applicable
<b>TPC:</b>	Not Applicable	<b>Tested By:</b>	SB
<b>Engineering Test Notes:</b>			

Test Measurement Results									
Test Frequency	Measured Conducted Output Power (dBm)				Calculated Total Power	Minimum 26 dB Bandwidth	Limit	Margin	EUT Power Setting
	Port(s)								
MHz	a	b	c	d	Σ Port(s) dBm	MHz	dBm	dB	
5290.0	13.12				13.12	137.234	24.00	-10.88	56.00

Traceability to Industry Recognized Test Methodologies	
Work Instruction:	WI-03 MEASURING RF SPECTRUM MASK
Measurement Uncertainty:	

The above measurements are true pulse readings and therefore a Duty Cycling correction factor is not required.

This test report may be reproduced in full only. The document may only be updated by MiCOM Labs personnel. All changes will be noted in the Document History section of the report.



**Title:** Hewlett Packard Enterprise APINR203 & APINP203  
**To:** FCC CFR 47 Part 15 Subpart E 15.407  
**Serial #:** HPEN96-U12 Rev A (1x1) (Conducted & Radiated Data)  
**Issue Date:** 13th June 2017  
**Page:** 26 of 147

**Equipment Configuration for Peak Transmit Power**

<b>Variant:</b>	802.11n HT-20	<b>Duty Cycle (%):</b>	99.0
<b>Data Rate:</b>	6.50 MBit/s	<b>Antenna Gain (dBi):</b>	2.90
<b>Modulation:</b>	OFDM	<b>Beam Forming Gain (Y)(dB):</b>	Not Applicable
<b>TPC:</b>	Not Applicable	<b>Tested By:</b>	SB
<b>Engineering Test Notes:</b>			

**Test Measurement Results**

Test Frequency	Measured Conducted Output Power (dBm)				Calculated Total Power	Minimum 26 dB Bandwidth	Limit	Margin	EUT Power Setting
	Port(s)								
MHz	a	b	c	d	Σ Port(s) dBm	MHz	dBm	dB	
5260.0	16.48				16.48	26.293	24.00	-7.52	72.00
5300.0	16.62				16.62	25.972	24.00	-7.38	72.00
5320.0	16.37				16.37	24.529	24.00	-7.63	70.00

**Traceability to Industry Recognized Test Methodologies**

Work Instruction:	WI-03 MEASURING RF SPECTRUM MASK
Measurement Uncertainty:	±2.81 dB

The above measurements are true pulse readings and therefore a Duty Cycling correction factor is not required.

This test report may be reproduced in full only. The document may only be updated by MiCOM Labs personnel. All changes will be noted in the Document History section of the report.



**Title:** Hewlett Packard Enterprise APINR203 & APINP203  
**To:** FCC CFR 47 Part 15 Subpart E 15.407  
**Serial #:** HPEN96-U12 Rev A (1x1) (Conducted & Radiated Data)  
**Issue Date:** 13th June 2017  
**Page:** 27 of 147

**Equipment Configuration for Peak Transmit Power**

<b>Variant:</b>	802.11n HT-40	<b>Duty Cycle (%):</b>	89.8
<b>Data Rate:</b>	13.50 MBit/s	<b>Antenna Gain (dBi):</b>	2.90
<b>Modulation:</b>	OFDM	<b>Beam Forming Gain (Y)(dB):</b>	Not Applicable
<b>TPC:</b>	Not Applicable	<b>Tested By:</b>	SB
<b>Engineering Test Notes:</b>			

**Test Measurement Results**

Test Frequency	Measured Conducted Output Power (dBm)				Calculated Total Power	Minimum 26 dB Bandwidth	Limit	Margin	EUT Power Setting
	Port(s)								
MHz	a	b	c	d	Σ Port(s) dBm	MHz	dBm	dB	
5270.0	16.98				16.98	72.305	24.00	-7.02	72.00
5310.0	10.33				10.33	64.128	24.00	-13.67	53.00

**Traceability to Industry Recognized Test Methodologies**

Work Instruction:	WI-03 MEASURING RF SPECTRUM MASK
Measurement Uncertainty:	±2.81 dB

The above measurements are true pulse readings and therefore a Duty Cycling correction factor is not required.

This test report may be reproduced in full only. The document may only be updated by MiCOM Labs personnel. All changes will be noted in the Document History section of the report.



**Title:** Hewlett Packard Enterprise APINR203 & APINP203  
**To:** FCC CFR 47 Part 15 Subpart E 15.407  
**Serial #:** HPEN96-U12 Rev A (1x1) (Conducted & Radiated Data)  
**Issue Date:** 13th June 2017  
**Page:** 28 of 147

**Equipment Configuration for Peak Transmit Power**

<b>Variant:</b>	802.11a	<b>Duty Cycle (%):</b>	99.0
<b>Data Rate:</b>	6.00 MBit/s	<b>Antenna Gain (dBi):</b>	2.90
<b>Modulation:</b>	OFDM	<b>Beam Forming Gain (Y)(dB):</b>	Not Applicable
<b>TPC:</b>	Not Applicable	<b>Tested By:</b>	SB
<b>Engineering Test Notes:</b>			

**Test Measurement Results**

Test Frequency	Measured Conducted Output Power (dBm)				Calculated Total Power	Minimum 26 dB Bandwidth	Limit	Margin	EUT Power Setting
	Port(s)								
MHz	a	b	c	d	Σ Port(s) dBm	MHz	dBm	dB	
5500.0	15.14				15.14	23.086	24.00	-8.86	65.00
5580.0	16.93				16.93	23.647	24.00	-7.07	72.00
5720.0	16.99				16.99	23.647	24.00	-7.01	72.00

**Traceability to Industry Recognized Test Methodologies**

Work Instruction:	WI-03 MEASURING RF SPECTRUM MASK
Measurement Uncertainty:	±2.81 dB

The above measurements are true pulse readings and therefore a Duty Cycling correction factor is not required.

This test report may be reproduced in full only. The document may only be updated by MiCOM Labs personnel. All changes will be noted in the Document History section of the report.



**Title:** Hewlett Packard Enterprise APINR203 & APINP203  
**To:** FCC CFR 47 Part 15 Subpart E 15.407  
**Serial #:** HPEN96-U12 Rev A (1x1) (Conducted & Radiated Data)  
**Issue Date:** 13th June 2017  
**Page:** 29 of 147

**Equipment Configuration for Peak Transmit Power**

<b>Variant:</b>	802.11ac-80	<b>Duty Cycle (%):</b>	80.0
<b>Data Rate:</b>	29.30 MBit/s	<b>Antenna Gain (dBi):</b>	2.90
<b>Modulation:</b>	OFDM	<b>Beam Forming Gain (Y)(dB):</b>	Not Applicable
<b>TPC:</b>	Not Applicable	<b>Tested By:</b>	SB
<b>Engineering Test Notes:</b>			

Test Measurement Results									
Test Frequency	Measured Conducted Output Power (dBm)				Calculated Total Power	Minimum 26 dB Bandwidth	Limit	Margin	EUT Power Setting
	Port(s)								
MHz	a	b	c	d	Σ Port(s) dBm	MHz	dBm	dB	
5530.0	10.18				10.18	140.441	24.00	-13.82	57.00
5610.0	15.49				15.49	79.679	24.00	-8.51	72.00
5690.0	15.41				15.41	159.679	24.00	-8.59	72.00

Traceability to Industry Recognized Test Methodologies	
Work Instruction:	WI-03 MEASURING RF SPECTRUM MASK
Measurement Uncertainty:	±2.81 dB

The above measurements are true pulse readings and therefore a Duty Cycling correction factor is not required.

This test report may be reproduced in full only. The document may only be updated by MiCOM Labs personnel. All changes will be noted in the Document History section of the report.





**Title:** Hewlett Packard Enterprise APINR203 & APINP203  
**To:** FCC CFR 47 Part 15 Subpart E 15.407  
**Serial #:** HPEN96-U12 Rev A (1x1) (Conducted & Radiated Data)  
**Issue Date:** 13th June 2017  
**Page:** 30 of 147

**Equipment Configuration for Peak Transmit Power**

<b>Variant:</b>	802.11n HT-20	<b>Duty Cycle (%):</b>	99.0
<b>Data Rate:</b>	6.50 MBit/s	<b>Antenna Gain (dBi):</b>	2.90
<b>Modulation:</b>	OFDM	<b>Beam Forming Gain (Y)(dB):</b>	Not Applicable
<b>TPC:</b>	Not Applicable	<b>Tested By:</b>	SB
<b>Engineering Test Notes:</b>			

**Test Measurement Results**

Test Frequency	Measured Conducted Output Power (dBm)				Calculated Total Power	Minimum 26 dB Bandwidth	Limit	Margin	EUT Power Setting
	Port(s)								
MHz	a	b	c	d	Σ Port(s) dBm	MHz	dBm	dB	
5500.0	16.18				16.18	23.727	24.00	-7.82	70.00
5580.0	16.90				16.90	23.808	24.00	-7.10	72.00
5720.0	17.10				17.10	23.647	24.00	-6.90	72.00

**Traceability to Industry Recognized Test Methodologies**

Work Instruction:	WI-03 MEASURING RF SPECTRUM MASK
Measurement Uncertainty:	±2.81 dB

The above measurements are true pulse readings and therefore a Duty Cycling correction factor is not required.

This test report may be reproduced in full only. The document may only be updated by MiCOM Labs personnel. All changes will be noted in the Document History section of the report.



**Title:** Hewlett Packard Enterprise APINR203 & APINP203  
**To:** FCC CFR 47 Part 15 Subpart E 15.407  
**Serial #:** HPEN96-U12 Rev A (1x1) (Conducted & Radiated Data)  
**Issue Date:** 13th June 2017  
**Page:** 31 of 147

**Equipment Configuration for Peak Transmit Power**

<b>Variant:</b>	802.11n HT-40	<b>Duty Cycle (%):</b>	89.8
<b>Data Rate:</b>	13.50 MBit/s	<b>Antenna Gain (dBi):</b>	2.90
<b>Modulation:</b>	OFDM	<b>Beam Forming Gain (Y)(dB):</b>	Not Applicable
<b>TPC:</b>	Not Applicable	<b>Tested By:</b>	SB
<b>Engineering Test Notes:</b>			

**Test Measurement Results**

Test Frequency	Measured Conducted Output Power (dBm)				Calculated Total Power	Minimum 26 dB Bandwidth	Limit	Margin	EUT Power Setting
	Port(s)								
MHz	a	b	c	d	Σ Port(s) dBm	MHz	dBm	dB	
5510.0	17.27				17.27	78.878	24.00	-6.73	72.00
5550.0	16.43				16.43	39.840	24.00	-7.57	72.00
5710.0	16.50				16.50	39.840	24.00	-7.50	72.00

**Traceability to Industry Recognized Test Methodologies**

Work Instruction:	WI-03 MEASURING RF SPECTRUM MASK
Measurement Uncertainty:	±2.81 dB

The above measurements are true pulse readings and therefore a Duty Cycling correction factor is not required.

This test report may be reproduced in full only. The document may only be updated by MiCOM Labs personnel. All changes will be noted in the Document History section of the report.



**Title:** Hewlett Packard Enterprise APINR203 & APINP203  
**To:** FCC CFR 47 Part 15 Subpart E 15.407  
**Serial #:** HPEN96-U12 Rev A (1x1) (Conducted & Radiated Data)  
**Issue Date:** 13th June 2017  
**Page:** 32 of 147

## 9.2. 26 dB & 99% Bandwidth

Conducted Test Conditions for 26 dB and 99% Bandwidth			
<b>Standard:</b>	FCC CFR 47:15.407	<b>Ambient Temp. (°C):</b>	24.0 - 27.5
<b>Test Heading:</b>	26 dB and 99 % Bandwidth	<b>Rel. Humidity (%):</b>	32 - 45
<b>Standard Section(s):</b>	15.407 (a)	<b>Pressure (mBars):</b>	999 - 1001
<b>Reference Document(s):</b>	See Normative References		
<b>Test Procedure for 26 dB and 99% Bandwidth Measurement</b> The bandwidth at 26 dB and 99 % is measured with a spectrum analyzer connected to the antenna terminal, while EUT is operating in transmission mode at the appropriate center frequency. The Resolution Bandwidth was set to approximately 1% of the emission bandwidth. Testing was performed under ambient conditions at nominal voltage. Where the device operated with multiple antenna ports i.e. MIMO device, each port was measured and reported.  Test configuration and setup used for the measurement was per the Conducted Test Set-up section specified in this document.			

This test report may be reproduced in full only. The document may only be updated by MiCOM Labs personnel. All changes will be noted in the Document History section of the report.



**Title:** Hewlett Packard Enterprise APINR203 & APINP203  
**To:** FCC CFR 47 Part 15 Subpart E 15.407  
**Serial #:** HPEN96-U12 Rev A (1x1) (Conducted & Radiated Data)  
**Issue Date:** 13th June 2017  
**Page:** 33 of 147

**Equipment Configuration for 26 dB & 99% Occupied Bandwidth**

<b>Variant:</b>	802.11a	<b>Duty Cycle (%):</b>	99.0
<b>Data Rate:</b>	6.00 MBit/s	<b>Antenna Gain (dBi):</b>	2.90
<b>Modulation:</b>	OFDM	<b>Beam Forming Gain (Y)(dB):</b>	Not Applicable
<b>TPC:</b>	Not Applicable	<b>Tested By:</b>	SB
<b>Engineering Test Notes:</b>			

**Test Measurement Results**

Test Frequency	Measured 26 dB Bandwidth (MHz)				26 dB Bandwidth (MHz)			
	Port(s)				Highest	Lowest		
MHz	a	b	c	d				
5260.0	<a href="#">23.407</a>				23.407	23.407		
5300.0	<a href="#">26.293</a>				26.293	26.293		
5320.0	<a href="#">24.609</a>				24.609	24.609		

Test Frequency	Measured 99% Bandwidth (MHz)				99% Bandwidth (MHz)			
	Port(s)				Highest	Lowest		
MHz	a	b	c	d				
5260.0	<a href="#">17.074</a>				17.074	17.074		
5300.0	<a href="#">17.074</a>				17.074	17.074		
5320.0	<a href="#">16.994</a>				16.994	16.994		

**Traceability to Industry Recognized Test Methodologies**

Work Instruction:	WI-03 MEASURING RF SPECTRUM MASK
Measurement Uncertainty:	±2.81 dB

Note: click the links in the above matrix to view the graphical image (plot).

This test report may be reproduced in full only. The document may only be updated by MiCOM Labs personnel. All changes will be noted in the Document History section of the report.



**Title:** Hewlett Packard Enterprise APINR203 & APINP203  
**To:** FCC CFR 47 Part 15 Subpart E 15.407  
**Serial #:** HPEN96-U12 Rev A (1x1) (Conducted & Radiated Data)  
**Issue Date:** 13th June 2017  
**Page:** 34 of 147

**Equipment Configuration for 26 dB & 99% Occupied Bandwidth**

<b>Variant:</b>	802.11ac-80	<b>Duty Cycle (%):</b>	80.0
<b>Data Rate:</b>	29.30 MBit/s	<b>Antenna Gain (dBi):</b>	2.90
<b>Modulation:</b>	OFDM	<b>Beam Forming Gain (Y)(dB):</b>	Not Applicable
<b>TPC:</b>	Not Applicable	<b>Tested By:</b>	SB
<b>Engineering Test Notes:</b>			

**Test Measurement Results**

Test Frequency	Measured 26 dB Bandwidth (MHz)				26 dB Bandwidth (MHz)			
	Port(s)				Highest	Lowest		
MHz	a	b	c	d				
5290.0	<a href="#">137.234</a>				137.234	137.234		

Test Frequency	Measured 99% Bandwidth (MHz)				99% Bandwidth (MHz)			
	Port(s)				Highest	Lowest		
MHz	a	b	c	d				
5290.0	<a href="#">77.916</a>				77.916	77.916		

**Traceability to Industry Recognized Test Methodologies**

Work Instruction:	WI-03 MEASURING RF SPECTRUM MASK
Measurement Uncertainty:	±2.81 dB

Note: click the links in the above matrix to view the graphical image (plot).

This test report may be reproduced in full only. The document may only be updated by MiCOM Labs personnel. All changes will be noted in the Document History section of the report.



**Title:** Hewlett Packard Enterprise APINR203 & APINP203  
**To:** FCC CFR 47 Part 15 Subpart E 15.407  
**Serial #:** HPEN96-U12 Rev A (1x1) (Conducted & Radiated Data)  
**Issue Date:** 13th June 2017  
**Page:** 35 of 147

**Equipment Configuration for 26 dB & 99% Occupied Bandwidth**

<b>Variant:</b>	802.11n HT-20	<b>Duty Cycle (%):</b>	99.0
<b>Data Rate:</b>	6.50 MBit/s	<b>Antenna Gain (dBi):</b>	2.90
<b>Modulation:</b>	OFDM	<b>Beam Forming Gain (Y)(dB):</b>	Not Applicable
<b>TPC:</b>	Not Applicable	<b>Tested By:</b>	SB
<b>Engineering Test Notes:</b>			

**Test Measurement Results**

Test Frequency	Measured 26 dB Bandwidth (MHz)				26 dB Bandwidth (MHz)			
	Port(s)				Highest	Lowest		
MHz	a	b	c	d				
5260.0	<a href="#">26.293</a>				26.293	26.293		
5300.0	<a href="#">25.972</a>				25.972	25.972		
5320.0	<a href="#">24.529</a>				24.529	24.529		

Test Frequency	Measured 99% Bandwidth (MHz)				99% Bandwidth (MHz)			
	Port(s)				Highest	Lowest		
MHz	a	b	c	d				
5260.0	<a href="#">17.074</a>				17.074	17.074		
5300.0	<a href="#">17.074</a>				17.074	17.074		
5320.0	<a href="#">16.994</a>				16.994	16.994		

**Traceability to Industry Recognized Test Methodologies**

Work Instruction:	WI-03 MEASURING RF SPECTRUM MASK
Measurement Uncertainty:	±2.81 dB

Note: click the links in the above matrix to view the graphical image (plot).

This test report may be reproduced in full only. The document may only be updated by MiCOM Labs personnel. All changes will be noted in the Document History section of the report.



**Title:** Hewlett Packard Enterprise APINR203 & APINP203  
**To:** FCC CFR 47 Part 15 Subpart E 15.407  
**Serial #:** HPEN96-U12 Rev A (1x1) (Conducted & Radiated Data)  
**Issue Date:** 13th June 2017  
**Page:** 36 of 147

**Equipment Configuration for 26 dB & 99% Occupied Bandwidth**

<b>Variant:</b>	802.11n HT-40	<b>Duty Cycle (%):</b>	89.8
<b>Data Rate:</b>	13.50 MBit/s	<b>Antenna Gain (dBi):</b>	2.90
<b>Modulation:</b>	OFDM	<b>Beam Forming Gain (Y)(dB):</b>	Not Applicable
<b>TPC:</b>	Not Applicable	<b>Tested By:</b>	SB
<b>Engineering Test Notes:</b>			

**Test Measurement Results**

Test Frequency	Measured 26 dB Bandwidth (MHz)				26 dB Bandwidth (MHz)			
	Port(s)				Highest	Lowest		
MHz	a	b	c	d				
5270.0	<a href="#">72.305</a>				72.305	72.305		
5310.0	<a href="#">64.128</a>				64.128	64.128		

Test Frequency	Measured 99% Bandwidth (MHz)				99% Bandwidth (MHz)			
	Port(s)				Highest	Lowest		
MHz	a	b	c	d				
5270.0	<a href="#">37.515</a>				37.515	37.515		
5310.0	<a href="#">38.637</a>				38.637	38.637		

**Traceability to Industry Recognized Test Methodologies**

Work Instruction:	WI-03 MEASURING RF SPECTRUM MASK
Measurement Uncertainty:	±2.81 dB

Note: click the links in the above matrix to view the graphical image (plot).

This test report may be reproduced in full only. The document may only be updated by MiCOM Labs personnel. All changes will be noted in the Document History section of the report.



**Title:** Hewlett Packard Enterprise APINR203 & APINP203  
**To:** FCC CFR 47 Part 15 Subpart E 15.407  
**Serial #:** HPEN96-U12 Rev A (1x1) (Conducted & Radiated Data)  
**Issue Date:** 13th June 2017  
**Page:** 37 of 147

**Equipment Configuration for 26 dB & 99% Occupied Bandwidth**

<b>Variant:</b>	802.11a	<b>Duty Cycle (%):</b>	99.0
<b>Data Rate:</b>	6.00 MBit/s	<b>Antenna Gain (dBi):</b>	2.90
<b>Modulation:</b>	OFDM	<b>Beam Forming Gain (Y)(dB):</b>	Not Applicable
<b>TPC:</b>	Not Applicable	<b>Tested By:</b>	SB
<b>Engineering Test Notes:</b>			

**Test Measurement Results**

Test Frequency	Measured 26 dB Bandwidth (MHz)				26 dB Bandwidth (MHz)			
	Port(s)				Highest	Lowest		
MHz	a	b	c	d				
5500.0	<a href="#">23.086</a>				23.086	23.086		
5580.0	<a href="#">23.647</a>				23.647	23.647		
5720.0	<a href="#">23.647</a>				23.647	23.647		

Test Frequency	Measured 99% Bandwidth (MHz)				99% Bandwidth (MHz)			
	Port(s)				Highest	Lowest		
MHz	a	b	c	d				
5500.0	<a href="#">16.994</a>				16.994	16.994		
5580.0	<a href="#">17.074</a>				17.074	17.074		
5720.0	<a href="#">17.074</a>				17.074	17.074		

**Traceability to Industry Recognized Test Methodologies**

Work Instruction:	WI-03 MEASURING RF SPECTRUM MASK
Measurement Uncertainty:	±2.81 dB

Note: click the links in the above matrix to view the graphical image (plot).

This test report may be reproduced in full only. The document may only be updated by MiCOM Labs personnel. All changes will be noted in the Document History section of the report.





**Title:** Hewlett Packard Enterprise APINR203 & APINP203  
**To:** FCC CFR 47 Part 15 Subpart E 15.407  
**Serial #:** HPEN96-U12 Rev A (1x1) (Conducted & Radiated Data)  
**Issue Date:** 13th June 2017  
**Page:** 38 of 147

**Equipment Configuration for 26 dB & 99% Occupied Bandwidth**

<b>Variant:</b>	802.11ac-80	<b>Duty Cycle (%):</b>	80.0
<b>Data Rate:</b>	29.30 MBit/s	<b>Antenna Gain (dBi):</b>	2.90
<b>Modulation:</b>	OFDM	<b>Beam Forming Gain (Y)(dB):</b>	Not Applicable
<b>TPC:</b>	Not Applicable	<b>Tested By:</b>	SB
<b>Engineering Test Notes:</b>			

**Test Measurement Results**

Test Frequency	Measured 26 dB Bandwidth (MHz)				26 dB Bandwidth (MHz)			
	Port(s)				Highest	Lowest		
MHz	a	b	c	d				
5530.0	<a href="#">140.441</a>				140.441	140.441		
5610.0	<a href="#">183.176</a>				183.176	183.176		
5690.0	<a href="#">159.679</a>				159.679	159.679		

Test Frequency	Measured 99% Bandwidth (MHz)				99% Bandwidth (MHz)			
	Port(s)				Highest	Lowest		
MHz	a	b	c	d				
5530.0	<a href="#">76.954</a>				76.954	76.954		
5610.0	<a href="#">99.379</a>				99.379	99.379		
5690.0	<a href="#">79.519</a>				79.519	79.519		

**Traceability to Industry Recognized Test Methodologies**

Work Instruction:	WI-03 MEASURING RF SPECTRUM MASK
Measurement Uncertainty:	±2.81 dB

Note: click the links in the above matrix to view the graphical image (plot).

This test report may be reproduced in full only. The document may only be updated by MiCOM Labs personnel. All changes will be noted in the Document History section of the report.



**Title:** Hewlett Packard Enterprise APINR203 & APINP203  
**To:** FCC CFR 47 Part 15 Subpart E 15.407  
**Serial #:** HPEN96-U12 Rev A (1x1) (Conducted & Radiated Data)  
**Issue Date:** 13th June 2017  
**Page:** 39 of 147

**Equipment Configuration for 26 dB & 99% Occupied Bandwidth**

<b>Variant:</b>	802.11n HT-20	<b>Duty Cycle (%):</b>	99.0
<b>Data Rate:</b>	6.50 MBit/s	<b>Antenna Gain (dBi):</b>	2.90
<b>Modulation:</b>	OFDM	<b>Beam Forming Gain (Y)(dB):</b>	Not Applicable
<b>TPC:</b>	Not Applicable	<b>Tested By:</b>	SB
<b>Engineering Test Notes:</b>			

**Test Measurement Results**

Test Frequency	Measured 26 dB Bandwidth (MHz)				26 dB Bandwidth (MHz)			
	Port(s)				Highest	Lowest		
MHz	a	b	c	d				
5500.0	<a href="#">23.727</a>				23.727	23.727		
5580.0	<a href="#">23.808</a>				23.808	23.808		
5720.0	<a href="#">23.647</a>				23.647	23.647		

Test Frequency	Measured 99% Bandwidth (MHz)				99% Bandwidth (MHz)			
	Port(s)				Highest	Lowest		
MHz	a	b	c	d				
5500.0	<a href="#">16.994</a>				16.994	16.994		
5580.0	<a href="#">16.994</a>				16.994	16.994		
5720.0	<a href="#">17.074</a>				17.074	17.074		

**Traceability to Industry Recognized Test Methodologies**

Work Instruction:	WI-03 MEASURING RF SPECTRUM MASK
Measurement Uncertainty:	±2.81 dB

Note: click the links in the above matrix to view the graphical image (plot).

This test report may be reproduced in full only. The document may only be updated by MiCOM Labs personnel. All changes will be noted in the Document History section of the report.



**Title:** Hewlett Packard Enterprise APINR203 & APINP203  
**To:** FCC CFR 47 Part 15 Subpart E 15.407  
**Serial #:** HPEN96-U12 Rev A (1x1) (Conducted & Radiated Data)  
**Issue Date:** 13th June 2017  
**Page:** 40 of 147

**Equipment Configuration for 26 dB & 99% Occupied Bandwidth**

<b>Variant:</b>	802.11n HT-40	<b>Duty Cycle (%):</b>	89.8
<b>Data Rate:</b>	13.50 MBit/s	<b>Antenna Gain (dBi):</b>	2.90
<b>Modulation:</b>	OFDM	<b>Beam Forming Gain (Y)(dB):</b>	Not Applicable
<b>TPC:</b>	Not Applicable	<b>Tested By:</b>	SB
<b>Engineering Test Notes:</b>			

**Test Measurement Results**

Test Frequency	Measured 26 dB Bandwidth (MHz)				26 dB Bandwidth (MHz)			
	Port(s)				Highest	Lowest		
MHz	a	b	c	d				
5510.0	<a href="#">78.878</a>				78.878	78.878		
5550.0	<a href="#">89.820</a>				89.820	89.820		
5710.0	<a href="#">97.455</a>				97.455	97.455		

Test Frequency	Measured 99% Bandwidth (MHz)				99% Bandwidth (MHz)			
	Port(s)				Highest	Lowest		
MHz	a	b	c	d				
5510.0	<a href="#">37.675</a>				37.675	37.675		
5550.0	<a href="#">51.944</a>				51.944	51.944		
5710.0	<a href="#">57.715</a>				57.715	57.715		

**Traceability to Industry Recognized Test Methodologies**

Work Instruction:	WI-03 MEASURING RF SPECTRUM MASK
Measurement Uncertainty:	±2.81 dB

Note: click the links in the above matrix to view the graphical image (plot).

This test report may be reproduced in full only. The document may only be updated by MiCOM Labs personnel. All changes will be noted in the Document History section of the report.



### 9.3. Power Spectral Density

Conducted Test Conditions for Power Spectral Density			
<b>Standard:</b>	FCC CFR 47:15.407	<b>Ambient Temp. (°C):</b>	24.0 - 27.5
<b>Test Heading:</b>	Power Spectral Density	<b>Rel. Humidity (%):</b>	32 - 45
<b>Standard Section(s):</b>	15.407 (a)	<b>Pressure (mBars):</b>	999 - 1001
<b>Reference Document(s):</b>	See Normative References		

#### Test Procedure for Power Spectral Density

The in-band power spectral density was measured using the test technique specified in KDB 789033. A 1 MHz measurement bandwidth was implemented for the analyzer sweep. Once the sweep is complete the analyzer trace data is downloaded and used for post processing purposes.

Where the device operated with multiple antenna ports i.e. MIMO device, each port was measured separately. The Peak Power Spectral Density is the highest level found across the emission bandwidth. With multiple antenna port measurements the numerical analyzer data from each port is summed (à) and a link to this additional graphic is provided.

Test configuration and setup used for the measurement was per the Conducted Test Set-up section specified in this document.

Measure and sum the spectra across the outputs. With this technique, spectra are measured at each output of the device at the required resolution bandwidth. The individual spectra are then summed mathematically in linear power units. Unlike in-band power measurements, in which the sum involves a single measured value (output power) from each output, measurements for compliance with PSD limits involve summing entire spectra across corresponding frequency bins on the various outputs. Consistency is maintained for any device with multiple transmitter outputs to be certain the individual outputs are all aligned with the same span and same number of points. In this instance, the linear power spectrum value within the first spectral bin of output 0 is summed with that in the first spectral bin of output 1, and the first spectral bin of output 2, and so on up to the Nth output to obtain the true value for the first frequency bin of the summed spectrum. The summed spectrum value for each frequency bin is computed in this fashion. These summed spectral values were post processed and the resulting numerical and graphical data presented.

NOTE: It may be observed that spectrum in some plots break the limit line however this in itself does NOT constitute a failure. In all cases a spectrum summation plot is provided in order to prove compliance. A failure occurs only after the summation of all spectrum plots have been summed and are found to be greater than the limit line.

#### Supporting Information

Calculated Power = A + 10 log (1/x) dBm

A = Total Power Spectral Density [ $10^x \text{Log}_{10} (10^{a/10} + 10^{b/10} + 10^{c/10} + 10^{d/10})$ ]

x = Duty Cycle

#### Limits Power Spectral Density

##### Operating Frequency Band 5150-5250 MHz

15.407 (a)(1)

(i) For an outdoor access point operating in the band 5.15-5.25 GHz, the maximum conducted output power over the frequency band of operation shall not exceed 1 W provided the maximum antenna gain does not exceed 6 dBi. In addition, the maximum power spectral density shall not exceed 17 dBm in any 1 megahertz band. If transmitting antennas of directional gain greater than 6 dBi are used, both the maximum conducted output power and the maximum power spectral density shall be reduced by the amount in dB that the directional gain of the antenna exceeds 6 dBi. The maximum e.i.r.p. at any elevation angle above 30 degrees as measured from the horizon must not exceed 125 mW (21 dBm).

(ii) For an indoor access point operating in the band 5.15-5.25 GHz, the maximum conducted output power over the frequency band of operation shall not exceed 1 W provided the maximum antenna gain does not exceed 6 dBi. In addition, the maximum power spectral density shall not exceed 17 dBm in any 1 megahertz band. If transmitting antennas of directional gain greater than 6 dBi are used, both the maximum conducted output power and the maximum power spectral density shall be reduced by the amount in dB that the directional gain of the antenna exceeds 6 dBi.

(iii) For fixed point-to-point access points operating in the band 5.15-5.25 GHz, the maximum conducted output power over the

This test report may be reproduced in full only. The document may only be updated by MiCOM Labs personnel. All changes will be noted in the Document History section of the report.



**Title:** Hewlett Packard Enterprise APINR203 & APINP203  
**To:** FCC CFR 47 Part 15 Subpart E 15.407  
**Serial #:** HPEN96-U12 Rev A (1x1) (Conducted & Radiated Data)  
**Issue Date:** 13th June 2017  
**Page:** 42 of 147

frequency band of operation shall not exceed 1 W. In addition, the maximum power spectral density shall not exceed 17 dBm in any 1 megahertz band. Fixed point-to-point U-NII devices may employ antennas with directional gain up to 23 dBi without any corresponding reduction in the maximum conducted output power or maximum power spectral density. For fixed point-to-point transmitters that employ a directional antenna gain greater than 23 dBi, a 1 dB reduction in maximum conducted output power and maximum power spectral density is required for each 1 dB of antenna gain in excess of 23 dBi. Fixed, point-to-point operations exclude the use of point-to-multipoint systems, omnidirectional applications, and multiple collocated transmitters transmitting the same information. The operator of the U-NII device, or if the equipment is professionally installed, the installer, is responsible for ensuring that systems employing high gain directional antennas are used exclusively for fixed, point-to-point operations.

(iv) For mobile and portable client devices in the 5.15-5.25 GHz band, the maximum conducted output power over the frequency band of operation shall not exceed 250 mW provided the maximum antenna gain does not exceed 6 dBi. In addition, the maximum power spectral density shall not exceed 11 dBm in any 1 megahertz band. If transmitting antennas of directional gain greater than 6 dBi are used, both the maximum conducted output power and the maximum power spectral density shall be reduced by the amount in dB that the directional gain of the antenna exceeds 6 dBi.

#### **Operating Frequency Band 5250-5350 and 5470 – 5725 MHz**

##### **15. 407 (a)(2)**

For the 5.25-5.35 GHz and 5.47-5.725 GHz bands, the maximum conducted output power over the frequency bands of operation shall not exceed the lesser of 250 mW or  $11 \text{ dBm} + 10 \log B$ , where B is the 26 dB emission bandwidth in megahertz. In addition, the maximum power spectral density shall not exceed 11 dBm in any 1 megahertz band. If transmitting antennas of directional gain greater than 6 dBi are used, both the maximum conducted output power and the maximum power spectral density shall be reduced by the amount in dB that the directional gain of the antenna exceeds 6 dBi.

#### **Operating Frequency Band 5725 – 5850 MHz**

##### **15. 407 (a)(3)**

For the band 5.725-5.85 GHz, the maximum conducted output power over the frequency band of operation shall not exceed 1 W. In addition, the maximum power spectral density shall not exceed 30 dBm in any 500-kHz band. If transmitting antennas of directional gain greater than 6 dBi are used, both the maximum conducted output power and the maximum power spectral density shall be reduced by the amount in dB that the directional gain of the antenna exceeds 6 dBi. However, fixed point-to-point U-NII devices operating in this band may employ transmitting antennas with directional gain greater than 6 dBi without any corresponding reduction in transmitter conducted power. Fixed, point-to-point operations exclude the use of point-to-multipoint systems, omnidirectional applications, and multiple collocated transmitters transmitting the same information. The operator of the U-NII device, or if the equipment is professionally installed, the installer, is responsible for ensuring that systems employing high gain directional antennas are used exclusively for fixed, point-to-point operations.

This test report may be reproduced in full only. The document may only be updated by MiCOM Labs personnel. All changes will be noted in the Document History section of the report.



**Title:** Hewlett Packard Enterprise APINR203 & APINP203  
**To:** FCC CFR 47 Part 15 Subpart E 15.407  
**Serial #:** HPEN96-U12 Rev A (1x1) (Conducted & Radiated Data)  
**Issue Date:** 13th June 2017  
**Page:** 43 of 147

**Equipment Configuration for Power Spectral Density**

<b>Variant:</b>	802.11a	<b>Duty Cycle (%):</b>	99.0
<b>Data Rate:</b>	6.00 MBit/s	<b>Antenna Gain (dBi):</b>	2.90
<b>Modulation:</b>	OFDM	<b>Beam Forming Gain (Y)(dB):</b>	Not Applicable
<b>TPC:</b>	Not Applicable	<b>Tested By:</b>	SB
<b>Engineering Test Notes:</b>			

**Test Measurement Results**

Test Frequency	Measured Power Spectral Density				Summation Peak Marker + DCCF (+0.04 dB)	Limit	Margin
	Port(s) (dBm/MHz)						
MHz	a	b	c	d	dBm/MHz	dBm/MHz	dB
5260.0	<a href="#">4.632</a>				<a href="#">4.676</a>	11.0	-6.3
5300.0	<a href="#">3.967</a>				<a href="#">4.011</a>	11.0	-7.0
5320.0	<a href="#">4.560</a>				<a href="#">4.604</a>	11.0	-6.4

**Traceability to Industry Recognized Test Methodologies**

Work Instruction:	WI-03 MEASURING RF SPECTRUM MASK
Measurement Uncertainty:	±2.81 dB

DCCF - Duty Cycle Correction Factor

Note: click the links in the above matrix to view the graphical image (plot).

This test report may be reproduced in full only. The document may only be updated by MiCOM Labs personnel. All changes will be noted in the Document History section of the report.



**Title:** Hewlett Packard Enterprise APINR203 & APINP203  
**To:** FCC CFR 47 Part 15 Subpart E 15.407  
**Serial #:** HPEN96-U12 Rev A (1x1) (Conducted & Radiated Data)  
**Issue Date:** 13th June 2017  
**Page:** 44 of 147

**Equipment Configuration for Power Spectral Density**

<b>Variant:</b>	802.11ac-80	<b>Duty Cycle (%):</b>	80.0
<b>Data Rate:</b>	29.30 MBit/s	<b>Antenna Gain (dBi):</b>	2.90
<b>Modulation:</b>	OFDM	<b>Beam Forming Gain (Y)(dB):</b>	Not Applicable
<b>TPC:</b>	Not Applicable	<b>Tested By:</b>	SB
<b>Engineering Test Notes:</b>			

**Test Measurement Results**

Test Frequency	Measured Power Spectral Density				Summation Peak Marker + DCCF (+0.97 dB)	Limit	Margin
	Port(s) (dBm/MHz)						
MHz	a	b	c	d	dBm/MHz	dBm/MHz	dB
5290.0	<a href="#">-2.656</a>				<a href="#">-1.687</a>	11.0	-12.7

**Traceability to Industry Recognized Test Methodologies**

Work Instruction:	WI-03 MEASURING RF SPECTRUM MASK
Measurement Uncertainty:	±2.81 dB

DCCF - Duty Cycle Correction Factor

Note: click the links in the above matrix to view the graphical image (plot).

This test report may be reproduced in full only. The document may only be updated by MiCOM Labs personnel. All changes will be noted in the Document History section of the report.



**Title:** Hewlett Packard Enterprise APINR203 & APINP203  
**To:** FCC CFR 47 Part 15 Subpart E 15.407  
**Serial #:** HPEN96-U12 Rev A (1x1) (Conducted & Radiated Data)  
**Issue Date:** 13th June 2017  
**Page:** 45 of 147

**Equipment Configuration for Power Spectral Density**

<b>Variant:</b>	802.11n HT-20	<b>Duty Cycle (%):</b>	99.0
<b>Data Rate:</b>	6.50 MBit/s	<b>Antenna Gain (dBi):</b>	2.90
<b>Modulation:</b>	OFDM	<b>Beam Forming Gain (Y)(dB):</b>	Not Applicable
<b>TPC:</b>	Not Applicable	<b>Tested By:</b>	SB
<b>Engineering Test Notes:</b>			

**Test Measurement Results**

Test Frequency	Measured Power Spectral Density				Summation Peak Marker + DCCF (+0.04 dB)	Limit	Margin
	Port(s) (dBm/MHz)						
MHz	a	b	c	d	dBm/MHz	dBm/MHz	dB
5260.0	<a href="#">4.855</a>				<a href="#">4.899</a>	11.0	-6.1
5300.0	<a href="#">3.990</a>				<a href="#">4.034</a>	11.0	-7.0
5320.0	<a href="#">4.519</a>				<a href="#">4.563</a>	11.0	-6.4

**Traceability to Industry Recognized Test Methodologies**

Work Instruction:	WI-03 MEASURING RF SPECTRUM MASK
Measurement Uncertainty:	±2.81 dB

DCCF - Duty Cycle Correction Factor

Note: click the links in the above matrix to view the graphical image (plot).

This test report may be reproduced in full only. The document may only be updated by MiCOM Labs personnel. All changes will be noted in the Document History section of the report.





**Title:** Hewlett Packard Enterprise APINR203 & APINP203  
**To:** FCC CFR 47 Part 15 Subpart E 15.407  
**Serial #:** HPEN96-U12 Rev A (1x1) (Conducted & Radiated Data)  
**Issue Date:** 13th June 2017  
**Page:** 46 of 147

**Equipment Configuration for Power Spectral Density**

<b>Variant:</b>	802.11n HT-40	<b>Duty Cycle (%):</b>	89.8
<b>Data Rate:</b>	13.50 MBit/s	<b>Antenna Gain (dBi):</b>	2.90
<b>Modulation:</b>	OFDM	<b>Beam Forming Gain (Y)(dB):</b>	Not Applicable
<b>TPC:</b>	Not Applicable	<b>Tested By:</b>	SB
<b>Engineering Test Notes:</b>			

**Test Measurement Results**

Test Frequency	Measured Power Spectral Density				Summation Peak Marker + DCCF (+0.46 dB)	Limit	Margin
	Port(s) (dBm/MHz)						
MHz	a	b	c	d	dBm/MHz	dBm/MHz	dB
5270.0	<a href="#">2.215</a>				<a href="#">2.683</a>	11.0	-8.3
5310.0	<a href="#">2.724</a>				<a href="#">3.192</a>	11.0	-7.8

**Traceability to Industry Recognized Test Methodologies**

Work Instruction:	WI-03 MEASURING RF SPECTRUM MASK
Measurement Uncertainty:	±2.81 dB

DCCF - Duty Cycle Correction Factor

Note: click the links in the above matrix to view the graphical image (plot).

This test report may be reproduced in full only. The document may only be updated by MiCOM Labs personnel. All changes will be noted in the Document History section of the report.



**Title:** Hewlett Packard Enterprise APINR203 & APINP203  
**To:** FCC CFR 47 Part 15 Subpart E 15.407  
**Serial #:** HPEN96-U12 Rev A (1x1) (Conducted & Radiated Data)  
**Issue Date:** 13th June 2017  
**Page:** 47 of 147

**Equipment Configuration for Power Spectral Density**

<b>Variant:</b>	802.11a	<b>Duty Cycle (%):</b>	99.0
<b>Data Rate:</b>	6.00 MBit/s	<b>Antenna Gain (dBi):</b>	2.90
<b>Modulation:</b>	OFDM	<b>Beam Forming Gain (Y)(dB):</b>	Not Applicable
<b>TPC:</b>	Not Applicable	<b>Tested By:</b>	SB
<b>Engineering Test Notes:</b>			

**Test Measurement Results**

Test Frequency	Measured Power Spectral Density				Summation Peak Marker + DCCF (+0.04 dB)	Limit	Margin
	Port(s) (dBm/MHz)						
MHz	a	b	c	d	dBm/MHz	dBm/MHz	dB
5500.0	<a href="#">5.481</a>				<a href="#">5.525</a>	11.0	-5.5
5580.0	<a href="#">4.776</a>				<a href="#">4.820</a>	11.0	-6.2
5720.0	<a href="#">4.455</a>				<a href="#">4.499</a>	11.0	-6.5

**Traceability to Industry Recognized Test Methodologies**

Work Instruction:	WI-03 MEASURING RF SPECTRUM MASK
Measurement Uncertainty:	±2.81 dB

DCCF - Duty Cycle Correction Factor

Note: click the links in the above matrix to view the graphical image (plot).

This test report may be reproduced in full only. The document may only be updated by MiCOM Labs personnel. All changes will be noted in the Document History section of the report.



**Title:** Hewlett Packard Enterprise APINR203 & APINP203  
**To:** FCC CFR 47 Part 15 Subpart E 15.407  
**Serial #:** HPEN96-U12 Rev A (1x1) (Conducted & Radiated Data)  
**Issue Date:** 13th June 2017  
**Page:** 48 of 147

**Equipment Configuration for Power Spectral Density**

<b>Variant:</b>	802.11ac-80	<b>Duty Cycle (%):</b>	80.0
<b>Data Rate:</b>	29.30 MBit/s	<b>Antenna Gain (dBi):</b>	2.90
<b>Modulation:</b>	OFDM	<b>Beam Forming Gain (Y)(dB):</b>	Not Applicable
<b>TPC:</b>	Not Applicable	<b>Tested By:</b>	SB
<b>Engineering Test Notes:</b>			

**Test Measurement Results**

Test Frequency	Measured Power Spectral Density				Summation Peak Marker + DCCF (+0.97 dB)	Limit	Margin
	Port(s) (dBm/MHz)						
MHz	a	b	c	d	dBm/MHz	dBm/MHz	dB
5530.0	<a href="#">-5.165</a>				<a href="#">-4.196</a>	11.0	-15.2
5610.0	<a href="#">-6.041</a>				<a href="#">-5.072</a>	11.0	-16.1
5690.0	<a href="#">-6.447</a>				<a href="#">-5.478</a>	11.0	-16.5

**Traceability to Industry Recognized Test Methodologies**

Work Instruction:	WI-03 MEASURING RF SPECTRUM MASK
Measurement Uncertainty:	±2.81 dB

DCCF - Duty Cycle Correction Factor

Note: click the links in the above matrix to view the graphical image (plot).

This test report may be reproduced in full only. The document may only be updated by MiCOM Labs personnel. All changes will be noted in the Document History section of the report.



**Title:** Hewlett Packard Enterprise APINR203 & APINP203  
**To:** FCC CFR 47 Part 15 Subpart E 15.407  
**Serial #:** HPEN96-U12 Rev A (1x1) (Conducted & Radiated Data)  
**Issue Date:** 13th June 2017  
**Page:** 49 of 147

**Equipment Configuration for Power Spectral Density**

<b>Variant:</b>	802.11n HT-20	<b>Duty Cycle (%):</b>	99.0
<b>Data Rate:</b>	6.50 MBit/s	<b>Antenna Gain (dBi):</b>	2.90
<b>Modulation:</b>	OFDM	<b>Beam Forming Gain (Y)(dB):</b>	Not Applicable
<b>TPC:</b>	Not Applicable	<b>Tested By:</b>	SB
<b>Engineering Test Notes:</b>			

**Test Measurement Results**

Test Frequency	Measured Power Spectral Density				Summation Peak Marker + DCCF (+0.04 dB)	Limit	Margin
	Port(s) (dBm/MHz)						
MHz	a	b	c	d	dBm/MHz	dBm/MHz	dB
5500.0	<a href="#">5.525</a>				<a href="#">5.569</a>	11.0	-5.4
5580.0	<a href="#">4.700</a>				<a href="#">4.744</a>	11.0	-6.3
5720.0	<a href="#">4.552</a>				<a href="#">4.596</a>	11.0	-6.4

**Traceability to Industry Recognized Test Methodologies**

Work Instruction:	WI-03 MEASURING RF SPECTRUM MASK
Measurement Uncertainty:	±2.81 dB

DCCF - Duty Cycle Correction Factor

Note: click the links in the above matrix to view the graphical image (plot).

This test report may be reproduced in full only. The document may only be updated by MiCOM Labs personnel. All changes will be noted in the Document History section of the report.



**Title:** Hewlett Packard Enterprise APINR203 & APINP203  
**To:** FCC CFR 47 Part 15 Subpart E 15.407  
**Serial #:** HPEN96-U12 Rev A (1x1) (Conducted & Radiated Data)  
**Issue Date:** 13th June 2017  
**Page:** 50 of 147

**Equipment Configuration for Power Spectral Density**

<b>Variant:</b>	802.11n HT-40	<b>Duty Cycle (%):</b>	89.8
<b>Data Rate:</b>	13.50 MBit/s	<b>Antenna Gain (dBi):</b>	2.90
<b>Modulation:</b>	OFDM	<b>Beam Forming Gain (Y)(dB):</b>	Not Applicable
<b>TPC:</b>	Not Applicable	<b>Tested By:</b>	SB
<b>Engineering Test Notes:</b>			

**Test Measurement Results**

Test Frequency	Measured Power Spectral Density				Summation Peak Marker + DCCF (+0.46 dB)	Limit	Margin
	Port(s) (dBm/MHz)						
MHz	a	b	c	d	dBm/MHz	dBm/MHz	dB
5510.0	<a href="#">1.774</a>				<a href="#">2.242</a>	11.0	-8.8
5550.0	<a href="#">0.031</a>				<a href="#">0.499</a>	11.0	-10.5
5710.0	<a href="#">-0.410</a>				<a href="#">0.058</a>	11.0	-10.9

**Traceability to Industry Recognized Test Methodologies**

Work Instruction:	WI-03 MEASURING RF SPECTRUM MASK
Measurement Uncertainty:	±2.81 dB

DCCF - Duty Cycle Correction Factor

Note: click the links in the above matrix to view the graphical image (plot).

This test report may be reproduced in full only. The document may only be updated by MiCOM Labs personnel. All changes will be noted in the Document History section of the report.



## 9.4. Radiated

Radiated Test Conditions for Radiated Spurious and Band-Edge Emissions			
<b>Standard:</b>	FCC CFR 47:15.407	<b>Ambient Temp. (°C):</b>	20.0 - 24.5
<b>Test Heading:</b>	Radiated Spurious and Band-Edge Emissions	<b>Rel. Humidity (%):</b>	32 - 45
<b>Standard Section(s):</b>	15.407 (b), 15.205, 15.209	<b>Pressure (mBars):</b>	999 - 1001
<b>Reference Document(s):</b>	See Normative References		

### Test Procedure for Radiated Spurious and Band-Edge Emissions

Radiated emissions for restricted bands above 1 GHz are measured in the anechoic chamber at a 3-meter distance on every azimuth in both horizontal and vertical polarities. The emissions are recorded and maximized as a function of azimuth by rotation through 360° with a spectrum analyzer in peak hold mode. Depending on the frequency band spanned a notch filter was used to remove the fundamental frequency. The highest emissions relative to the limit are listed for each frequency spanned.

Measurements on any restricted band frequency or frequencies above 1 GHz are based on the use of measurement instrumentation employing peak and average detectors. All measurements were performed using a resolution bandwidth of 1 MHz.

Test configuration and setup for Undesirable Measurement were per the Radiated Test Set-up specified in this document.

15.407 (b) Undesirable emission limits. Except as shown in paragraph (b)(7) of this section, the maximum emissions outside of the frequency bands of operation shall be attenuated in accordance with the following limits:

- (1) For transmitters operating in the 5.15-5.25 GHz band: All emissions outside of the 5.15-5.35 GHz band shall not exceed an e.i.r.p. of -27 dBm/MHz.
- (2) For transmitters operating in the 5.25-5.35 GHz band: All emissions outside of the 5.15-5.35 GHz band shall not exceed an e.i.r.p. of -27 dBm/MHz.
- (3) For transmitters operating in the 5.47-5.725 GHz band: All emissions outside of the 5.47-5.725 GHz band shall not exceed an e.i.r.p. of -27 dBm/MHz.
- (4) For transmitters operating in the 5.725-5.85 GHz band: All emissions within the frequency range from the band edge to 10 MHz above or below the band edge shall not exceed an e.i.r.p. of -17 dBm/MHz; for frequencies 10 MHz or greater above or below the band edge, emissions shall not exceed an e.i.r.p. of -27 dBm/MHz.
- (5) The emission measurements shall be performed using a minimum resolution bandwidth of 1 MHz. A lower resolution bandwidth may be employed near the band edge, when necessary, provided the measured energy is integrated to show the total power over 1 MHz.
- (6) Unwanted emissions below 1 GHz must comply with the general field strength limits set forth in §15.209. Further, any U-NII devices using an AC power line are required to comply also with the conducted limits set forth in §15.207.
- (7) The provisions of §15.205 apply to intentional radiators operating under this section.
- (8) When measuring the emission limits, the nominal carrier frequency shall be adjusted as close to the upper and lower frequency band edges as the design of the equipment permits.

### Limits for Restricted Bands (15.205, 15.209)

**Peak emission: 74 dBuV/m**

**Average emission: 54 dBuV/m**

### Field Strength Calculation

The field strength is calculated by adding the Antenna Factor and Cable Loss, and subtracting Amplifier Gain from the measured reading. All factors are included in the reported data.

$$FS = R + AF + CORR - FO$$

where:

This test report may be reproduced in full only. The document may only be updated by MiCOM Labs personnel. All changes will be noted in the Document History section of the report.



**Title:** Hewlett Packard Enterprise APINR203 & APINP203  
**To:** FCC CFR 47 Part 15 Subpart E 15.407  
**Serial #:** HPEN96-U12 Rev A (1x1) (Conducted & Radiated Data)  
**Issue Date:** 13th June 2017  
**Page:** 52 of 147

**FS = Field Strength**  
**R = Measured Spectrum analyzer Input Amplitude**  
**AF = Antenna Factor**  
**CORR = Correction Factor = CL – AG + NFL**  
**CL = Cable Loss**  
**AG = Amplifier Gain**  
**FO = Distance Falloff Factor**  
**NFL = Notch Filter Loss**

**Example:**

The following formula is used to convert the equipment isotropic radiated power (eirp) to field strength (dBµV/m);

$$E = 1000000 \times \sqrt{30P} / 3 \mu\text{V/m}$$

where P is the EIRP in Watts

Therefore: -27 dBm/MHz equates to 68.23 dBuV/m

Conversion between dBmV/m (or dBmV) and mV/m (or mV) are as follows:  
 Level (dBmV/m) = 20 \* Log (level (mV/m))

40 dBmV/m = 100 mV/m  
 48 dBmV/m = 250 mV/m

**Restricted Bands of Operation (15.205)**

(a) Except as shown in paragraph (d) of this section, only spurious emissions are permitted in any of the frequency bands listed below:

Frequency Band			
MHz	MHz	MHz	GHz
0.090-0.110	16.42-16.423	399.9-410	4.5-5.15
0.495-0.505	16.69475-16.69525	608-614	5.35-5.46
2.1735-2.1905	16.80425-16.80475	960-1240	7.25-7.75
4.125-4.128	25.5-25.67	1300-1427	8.025-8.5
4.17725-4.17775	37.5-38.25	1435-1626.5	9.0-9.2
4.20725-4.20775	73-74.6	1645.5-1646.5	9.3-9.5
6.215-6.218	74.8-75.2	1660-1710	10.6-12.7
6.26775-6.26825	108-121.94	1718.8-1722.2	13.25-13.4
6.31175-6.31225	123-138	2200-2300	14.47-14.5
8.291-8.294	149.9-150.05	2310-2390	15.35-16.2
8.362-8.366	156.52475-156.52525	2483.5-2500	17.7-21.4
8.37625-8.38675	156.7-156.9	2690-2900	22.01-23.12
8.41425-8.41475	162.0125-167.17	3260-3267	23.6-24.0
12.29-12.293	167.72-173.2	3332-3339	31.2-31.8
12.51975-12.52025	240-285	3345.8-3358	36.43-36.5
12.57675-12.57725	322-335.4	3600-4400	Above 38.6

This test report may be reproduced in full only. The document may only be updated by MiCOM Labs personnel. All changes will be noted in the Document History section of the report.



**Title:** Hewlett Packard Enterprise APINR203 & APINP203  
**To:** FCC CFR 47 Part 15 Subpart E 15.407  
**Serial #:** HPEN96-U12 Rev A (1x1) (Conducted & Radiated Data)  
**Issue Date:** 13th June 2017  
**Page:** 53 of 147

13.36-13.41			
<p>(b) Except as provided in paragraphs (d) and (e) of this section, the field strength of emissions appearing within these frequency bands shall not exceed the limits shown in §15.209. At frequencies equal to or less than 1000 MHz, compliance with the limits in §15.209 shall be demonstrated using measurement instrumentation employing a CISPR quasi-peak detector. Above 1000 MHz, compliance with the emission limits in §15.209 shall be demonstrated based on the average value of the measured emissions. The provisions in §15.35 apply to these measurements.</p> <p>(c) Except as provided in paragraphs (d) and (e) of this section, regardless of the field strength limits specified elsewhere in this subpart, the provisions of this section apply to emissions from any intentional radiator.</p> <p>(d) The following devices are exempt from the requirements of this section:</p> <ul style="list-style-type: none"><li>(1) Swept frequency field disturbance sensors operating between 1.705 and 37 MHz provided their emissions only sweep through the bands listed in paragraph (a) of this section, the sweep is never stopped with the fundamental emission within the bands listed in paragraph (a) of this section, and the fundamental emission is outside of the bands listed in paragraph (a) of this section more than 99% of the time the device is actively transmitting, without compensation for duty cycle.</li><li>(2) Transmitters used to detect buried electronic markers at 101.4 kHz which are employed by telephone companies.</li><li>(3) Cable locating equipment operated pursuant to §15.213.</li><li>(4) Any equipment operated under the provisions of §15.253, 15.255, and 15.256 in the frequency band 75-85 GHz, or §15.257 of this part.</li><li>(5) Biomedical telemetry devices operating under the provisions of §15.242 of this part are not subject to the restricted band 608-614 MHz but are subject to compliance within the other restricted bands.</li><li>(6) Transmitters operating under the provisions of subparts D or F of this part.</li><li>(7) Devices operated pursuant to §15.225 are exempt from complying with this section for the 13.36-13.41 MHz band only.</li><li>(8) Devices operated in the 24.075-24.175 GHz band under §15.245 are exempt from complying with the requirements of this section for the 48.15-48.35 GHz and 72.225-72.525 GHz bands only, and shall not exceed the limits specified in §15.245(b).</li><li>(9) Devices operated in the 24.0-24.25 GHz band under §15.249 are exempt from complying with the requirements of this section for the 48.0-48.5 GHz and 72.0-72.75 GHz bands only, and shall not exceed the limits specified in §15.249(a).</li></ul> <p>(e) Harmonic emissions appearing in the restricted bands above 17.7 GHz from field disturbance sensors operating under the provisions of §15.245 shall not exceed the limits specified in §15.245(b).</p>			

This test report may be reproduced in full only. The document may only be updated by MiCOM Labs personnel. All changes will be noted in the Document History section of the report.





**Title:** Hewlett Packard Enterprise APINR203 & APINP203  
**To:** FCC CFR 47 Part 15 Subpart E 15.407  
**Serial #:** HPEN96-U12 Rev A (1x1) (Conducted & Radiated Data)  
**Issue Date:** 13th June 2017  
**Page:** 54 of 147

### 9.4.1. TX Spurious & Restricted Band Emissions

#### Equipment Configuration for TX Spurious & Restricted Band Emissions

<b>Antenna:</b>	HPE Metal Sheet	<b>Variant:</b>	802.11a
<b>Antenna Gain (dBi):</b>	2.90	<b>Modulation:</b>	OFDM
<b>Beam Forming Gain (Y):</b>	Not Applicable	<b>Duty Cycle (%):</b>	99
<b>Channel Frequency (MHz):</b>	5260.00	<b>Data Rate:</b>	6.00 MBit/s
<b>Power Setting:</b>	72	<b>Tested By:</b>	JMH

#### Test Measurement Results

1000.00 - 18000.00 MHz												
Num	Frequency MHz	Raw dBµV	Cable Loss dB	AF dB	Level dBµV/m	Measurement Type	Pol	Hgt cm	Azt Deg	Limit dBµV/m	Margin dB	Pass /Fail
#1	5261.44	72.32	3.66	-11.29	64.69	Fundamental	Horizontal	100	0	--	--	
#2	10519.94	50.02	5.43	-4.21	51.24	Peak (NRB)	Vertical	151	7	--	--	Pass

Test Notes: APINP203 SN# CNCPK2T00L on 150cm table powered by AC.

This test report may be reproduced in full only. The document may only be updated by MiCOM Labs personnel. All changes will be noted in the Document History section of the report.



**Title:** Hewlett Packard Enterprise APINR203 & APINP203  
**To:** FCC CFR 47 Part 15 Subpart E 15.407  
**Serial #:** HPEN96-U12 Rev A (1x1) (Conducted & Radiated Data)  
**Issue Date:** 13th June 2017  
**Page:** 55 of 147

**Equipment Configuration for TX Spurious & Restricted Band Emissions**

<b>Antenna:</b>	HPE Metal Sheet	<b>Variant:</b>	802.11a
<b>Antenna Gain (dBi):</b>	2.90	<b>Modulation:</b>	OFDM
<b>Beam Forming Gain (Y):</b>	Not Applicable	<b>Duty Cycle (%):</b>	99
<b>Channel Frequency (MHz):</b>	5300.00	<b>Data Rate:</b>	6.00 MBit/s
<b>Power Setting:</b>	72	<b>Tested By:</b>	JMH

**Test Measurement Results**

1000.00 - 18000.00 MHz												
Num	Frequency MHz	Raw dBµV	Cable Loss dB	AF dB	Level dBµV/m	Measurement Type	Pol	Hgt cm	Azt Deg	Limit dBµV/m	Margin dB	Pass /Fail
#1	5295.84	73.38	3.79	-11.11	66.06	Fundamental	Horizontal	100	0	--	--	
#2	10604.94	55.48	5.56	-3.92	57.12	Max Peak	Horizontal	185	193	74.0	-16.9	Pass
#3	10604.94	41.15	5.56	-3.92	42.79	Max Avg	Horizontal	185	193	54.0	-11.2	Pass

Test Notes: APINP203 SN# CNCPK2T00L on 150cm table powered by AC.

This test report may be reproduced in full only. The document may only be updated by MiCOM Labs personnel. All changes will be noted in the Document History section of the report.



**Title:** Hewlett Packard Enterprise APINR203 & APINP203  
**To:** FCC CFR 47 Part 15 Subpart E 15.407  
**Serial #:** HPEN96-U12 Rev A (1x1) (Conducted & Radiated Data)  
**Issue Date:** 13th June 2017  
**Page:** 56 of 147

**Equipment Configuration for TX Spurious & Restricted Band Emissions**

<b>Antenna:</b>	HPE Metal Sheet	<b>Variant:</b>	802.11a
<b>Antenna Gain (dBi):</b>	2.90	<b>Modulation:</b>	OFDM
<b>Beam Forming Gain (Y):</b>	Not Applicable	<b>Duty Cycle (%):</b>	99
<b>Channel Frequency (MHz):</b>	5320.00	<b>Data Rate:</b>	6.00 MBit/s
<b>Power Setting:</b>	72	<b>Tested By:</b>	JMH

**Test Measurement Results**

1000.00 - 18000.00 MHz												
Num	Frequency MHz	Raw dBµV	Cable Loss dB	AF dB	Level dBµV/m	Measurement Type	Pol	Hgt cm	Azt Deg	Limit dBµV/m	Margin dB	Pass /Fail
#1	5323.73	72.98	3.74	-11.06	65.66	Fundamental	Horizontal	100	0	--	--	
#2	10640.33	51.07	5.39	-3.89	52.57	Max Peak	Vertical	98	18	74.0	-21.4	Pass
#3	10640.33	37.71	5.39	-3.89	39.21	Max Avg	Vertical	98	18	54.0	-14.8	Pass

Test Notes: APINP203 SN# CNCPK2T00L on 150cm table powered by AC.

This test report may be reproduced in full only. The document may only be updated by MiCOM Labs personnel. All changes will be noted in the Document History section of the report.



**Title:** Hewlett Packard Enterprise APINR203 & APINP203  
**To:** FCC CFR 47 Part 15 Subpart E 15.407  
**Serial #:** HPEN96-U12 Rev A (1x1) (Conducted & Radiated Data)  
**Issue Date:** 13th June 2017  
**Page:** 57 of 147

**Equipment Configuration for TX Spurious & Restricted Band Emissions**

<b>Antenna:</b>	HPE Metal Sheet	<b>Variant:</b>	802.11a
<b>Antenna Gain (dBi):</b>	2.90	<b>Modulation:</b>	OFDM
<b>Beam Forming Gain (Y):</b>	Not Applicable	<b>Duty Cycle (%):</b>	99
<b>Channel Frequency (MHz):</b>	5500.00	<b>Data Rate:</b>	6.00 MBit/s
<b>Power Setting:</b>	72	<b>Tested By:</b>	JMH

**Test Measurement Results**

1000.00 - 18000.00 MHz												
Num	Frequency MHz	Raw dBµV	Cable Loss dB	AF dB	Level dBµV/m	Measurement Type	Pol	Hgt cm	Azt Deg	Limit dBµV/m	Margin dB	Pass /Fail
#1	5504.21	62.41	3.75	-11.18	54.98	Fundamental	Horizontal	100	0	--	--	
#2	10995.83	51.77	5.60	-4.26	53.11	Max Peak	Vertical	155	267	74.0	-20.9	Pass
#3	10995.83	38.37	5.60	-4.26	39.71	Max Avg	Vertical	155	267	54.0	-14.3	Pass

Test Notes: APINP203 SN# CNCPK2T00L on 150cm table powered by AC.

This test report may be reproduced in full only. The document may only be updated by MiCOM Labs personnel. All changes will be noted in the Document History section of the report.



**Title:** Hewlett Packard Enterprise APINR203 & APINP203  
**To:** FCC CFR 47 Part 15 Subpart E 15.407  
**Serial #:** HPEN96-U12 Rev A (1x1) (Conducted & Radiated Data)  
**Issue Date:** 13th June 2017  
**Page:** 58 of 147

**Equipment Configuration for TX Spurious & Restricted Band Emissions**

<b>Antenna:</b>	HPE Metal Sheet	<b>Variant:</b>	802.11a
<b>Antenna Gain (dBi):</b>	2.90	<b>Modulation:</b>	OFDM
<b>Beam Forming Gain (Y):</b>	Not Applicable	<b>Duty Cycle (%):</b>	99
<b>Channel Frequency (MHz):</b>	5580.00	<b>Data Rate:</b>	6.00 MBit/s
<b>Power Setting:</b>	72	<b>Tested By:</b>	JMH

**Test Measurement Results**

1000.00 - 18000.00 MHz												
Num	Frequency MHz	Raw dBµV	Cable Loss dB	AF dB	Level dBµV/m	Measurement Type	Pol	Hgt cm	Azt Deg	Limit dBµV/m	Margin dB	Pass /Fail
#1	5576.21	69.56	3.81	-11.21	62.16	Fundamental	Horizontal	100	0	--	--	
#2	11157.98	50.94	5.94	-4.06	52.82	Max Peak	Vertical	140	357	74.0	-21.2	Pass
#3	11157.98	37.39	5.94	-4.06	39.27	Max Avg	Vertical	140	357	54.0	-14.7	Pass

Test Notes: APINP203 SN# CNCPK2T00L on 150cm table powered by AC.

This test report may be reproduced in full only. The document may only be updated by MiCOM Labs personnel. All changes will be noted in the Document History section of the report.



**Title:** Hewlett Packard Enterprise APINR203 & APINP203  
**To:** FCC CFR 47 Part 15 Subpart E 15.407  
**Serial #:** HPEN96-U12 Rev A (1x1) (Conducted & Radiated Data)  
**Issue Date:** 13th June 2017  
**Page:** 59 of 147

**Equipment Configuration for TX Spurious & Restricted Band Emissions**

<b>Antenna:</b>	HPE Metal Sheet	<b>Variant:</b>	802.11a
<b>Antenna Gain (dBi):</b>	2.90	<b>Modulation:</b>	OFDM
<b>Beam Forming Gain (Y):</b>	Not Applicable	<b>Duty Cycle (%):</b>	99
<b>Channel Frequency (MHz):</b>	5720.00	<b>Data Rate:</b>	6.00 MBit/s
<b>Power Setting:</b>	72	<b>Tested By:</b>	JMH

**Test Measurement Results**

1000.00 - 18000.00 MHz												
Num	Frequency MHz	Raw dBµV	Cable Loss dB	AF dB	Level dBµV/m	Measurement Type	Pol	Hgt cm	Azt Deg	Limit dBµV/m	Margin dB	Pass /Fail
#1	5715.24	59.08	3.81	-10.76	52.13	Fundamental	Vertical	100	0	--	--	
#2	11439.80	55.80	5.35	-4.93	56.22	Max Peak	Horizontal	187	304	74.0	-17.8	Pass
#3	11439.80	44.98	5.35	-4.93	45.40	Max Avg	Horizontal	187	304	54.0	-8.6	Pass

Test Notes: APINP203 SN# CNCPK2T00L on 150cm table powered by AC.

This test report may be reproduced in full only. The document may only be updated by MiCOM Labs personnel. All changes will be noted in the Document History section of the report.



### 9.4.2. Restricted Edge & Band-Edge Emissions

#### RESULTS SUMMARY FOR RADIATED BAND-EDGE EMISSIONS

##### 5250 - 5350 MHz

HPE Metal Sheet		Band-Edge Freq	Limit 74.0dB $\mu$ V/m	Limit 54.0dB $\mu$ V/m	Power Setting
Operational Mode	Operating Frequency (MHz)	MHz	dB $\mu$ V/m	dB $\mu$ V/m	
802.11a	5320.00	5350.00	70.87	53.68	63
802.11ac-80	5290.00	5350.00	72.85	52.87	56
802.11n HT-20	5320.00	5350.00	68.70	53.29	70
802.11n HT-40	5310.00	5350.00	72.30	53.48	53

##### 5470 - 5725 MHz

HPE Metal Sheet		Restricted-Edge Freq	Limit 74.0dB $\mu$ V/m	Limit 54.0dB $\mu$ V/m	Power Setting
Operational Mode	Operating Frequency (MHz)	MHz	dB $\mu$ V/m	dB $\mu$ V/m	
802.11a	5500.00	5460.00	72.64	53.59	65
802.11ac-80	5530.00	5460.00	71.06	53.68	57
802.11n HT-20	5500.00	5460.00	68.00	53.20	70
802.11n HT-40	5510.00	5460.00	72.03	53.59	72

HPE Metal Sheet		Band-Edge Freq	Limit 68.23dB $\mu$ V/m	Power Setting
Operational Mode	Operating Frequency (MHz)	MHz	dB $\mu$ V/m	
802.11a	5500.00	5470.00	56.66	65
802.11ac-80	5530.00	5470.00	54.85	57
802.11n HT-20	5500.00	5470.00	57.12	70
802.11n HT-40	5510.00	5470.00	58.15	72

Click on the links to view the data.

This test report may be reproduced in full only. The document may only be updated by MiCOM Labs personnel. All changes will be noted in the Document History section of the report.



**Title:** Hewlett Packard Enterprise APINR203 & APINP203  
**To:** FCC CFR 47 Part 15 Subpart E 15.407  
**Serial #:** HPEN96-U12 Rev A (1x1) (Conducted & Radiated Data)  
**Issue Date:** 13th June 2017  
**Page:** 61 of 147

**Equipment Configuration for Restricted Upper Band-Edge Emissions**

<b>Antenna:</b>	HPE Metal Sheet	<b>Variant:</b>	802.11a
<b>Antenna Gain (dBi):</b>	2.90	<b>Modulation:</b>	OFDM
<b>Beam Forming Gain (Y):</b>	Not Applicable	<b>Duty Cycle (%):</b>	99
<b>Channel Frequency (MHz):</b>	5320.00	<b>Data Rate:</b>	6.00 MBit/s
<b>Power Setting:</b>	63	<b>Tested By:</b>	JMH

**Test Measurement Results**

**5300.00 - 5460.00 MHz**

Num	Frequency MHz	Raw dB $\mu$ V	Cable Loss dB	AF dB	Level dB $\mu$ V/m	Measurement Type	Pol	Hgt cm	Azt Deg	Limit dB $\mu$ V/m	Margin dB	Pass /Fail
#2	5350.32	15.47	3.70	34.51	53.68	Max Avg	Horizontal	187	351	54.0	-0.3	Pass
#3	5350.64	32.65	3.71	34.51	70.87	Max Peak	Horizontal	187	351	74.0	-3.1	Pass
#1	5350.00	--	--	--	--	Restricted-Band	--	--	--	--	--	--

Test Notes: UT APINP203 SN# CNCPK2T00L on 150cm table powered by AC. Power reduced to 63 to meet band edge limit.

This test report may be reproduced in full only. The document may only be updated by MiCOM Labs personnel. All changes will be noted in the Document History section of the report.





**Title:** Hewlett Packard Enterprise APINR203 & APINP203  
**To:** FCC CFR 47 Part 15 Subpart E 15.407  
**Serial #:** HPEN96-U12 Rev A (1x1) (Conducted & Radiated Data)  
**Issue Date:** 13th June 2017  
**Page:** 62 of 147

**Equipment Configuration for Restricted Upper Band-Edge Emissions**

<b>Antenna:</b>	HPE Metal Sheet	<b>Variant:</b>	802.11ac-80
<b>Antenna Gain (dBi):</b>	2.90	<b>Modulation:</b>	OFDM
<b>Beam Forming Gain (Y):</b>	Not Applicable	<b>Duty Cycle (%):</b>	99
<b>Channel Frequency (MHz):</b>	5290.00	<b>Data Rate:</b>	29.30 MBit/s
<b>Power Setting:</b>	56	<b>Tested By:</b>	JMH

**Test Measurement Results**

**5290.00 - 5460.00 MHz**

Num	Frequency MHz	Raw dBµV	Cable Loss dB	AF dB	Level dBµV/m	Measurement Type	Pol	Hgt cm	Azt Deg	Limit dBµV/m	Margin dB	Pass /Fail
#2	5353.75	14.66	3.71	34.50	52.87	Max Avg	Horizontal	187	351	54.0	-1.1	Pass
#3	5363.97	34.67	3.70	34.48	72.85	Max Peak	Horizontal	187	351	74.0	-1.2	Pass
#1	5350.00	--	--	--	--	Restricted-Band	--	--	--	--	--	--

Test Notes: UT APINP203 SN# CNCPK2T00L on 150cm table powered by AC. Power reduced to 54 to meet band edge limit.

This test report may be reproduced in full only. The document may only be updated by MiCOM Labs personnel. All changes will be noted in the Document History section of the report.



**Title:** Hewlett Packard Enterprise APINR203 & APINP203  
**To:** FCC CFR 47 Part 15 Subpart E 15.407  
**Serial #:** HPEN96-U12 Rev A (1x1) (Conducted & Radiated Data)  
**Issue Date:** 13th June 2017  
**Page:** 63 of 147

**Equipment Configuration for Restricted Upper Band-Edge Emissions**

<b>Antenna:</b>	HPE Metal Sheet	<b>Variant:</b>	802.11n HT-20
<b>Antenna Gain (dBi):</b>	2.90	<b>Modulation:</b>	OFDM
<b>Beam Forming Gain (Y):</b>	Not Applicable	<b>Duty Cycle (%):</b>	99
<b>Channel Frequency (MHz):</b>	5320.00	<b>Data Rate:</b>	6.50 MBit/s
<b>Power Setting:</b>	70	<b>Tested By:</b>	JMH

**Test Measurement Results**

**5320.00 - 5460.00 MHz**

Num	Frequency MHz	Raw dBµV	Cable Loss dB	AF dB	Level dBµV/m	Measurement Type	Pol	Hgt cm	Azt Deg	Limit dBµV/m	Margin dB	Pass /Fail
#1	5350.00	15.08	3.70	34.51	53.29	Max Avg	Horizontal	187	351	54.0	-0.7	Pass
#3	5351.68	30.48	3.71	34.51	68.70	Max Peak	Horizontal	187	351	74.0	-5.3	Pass
#2	5350.00	--	--	--	--	Restricted-Band	--	--	--	--	--	--

Test Notes: UT APINP203 SN# CNCPK2T00L on 150cm table powered by AC. Power reduced to 70 to meet band edge limit.

This test report may be reproduced in full only. The document may only be updated by MiCOM Labs personnel. All changes will be noted in the Document History section of the report.



**Title:** Hewlett Packard Enterprise APINR203 & APINP203  
**To:** FCC CFR 47 Part 15 Subpart E 15.407  
**Serial #:** HPEN96-U12 Rev A (1x1) (Conducted & Radiated Data)  
**Issue Date:** 13th June 2017  
**Page:** 64 of 147

**Equipment Configuration for Restricted Upper Band-Edge Emissions**

<b>Antenna:</b>	HPE Metal Sheet	<b>Variant:</b>	802.11n HT-40
<b>Antenna Gain (dBi):</b>	2.90	<b>Modulation:</b>	OFDM
<b>Beam Forming Gain (Y):</b>	Not Applicable	<b>Duty Cycle (%):</b>	99
<b>Channel Frequency (MHz):</b>	5310.00	<b>Data Rate:</b>	13.50 MBit/s
<b>Power Setting:</b>	53	<b>Tested By:</b>	JMH

**Test Measurement Results**

**5300.00 - 5460.00 MHz**

Num	Frequency MHz	Raw dBµV	Cable Loss dB	AF dB	Level dBµV/m	Measurement Type	Pol	Hgt cm	Azt Deg	Limit dBµV/m	Margin dB	Pass /Fail
#1	5350.00	15.27	3.70	34.51	53.48	Max Avg	Horizontal	187	351	54.0	-0.5	Pass
#3	5351.60	34.08	3.71	34.51	72.30	Max Peak	Horizontal	187	351	74.0	-1.7	Pass
#2	5350.00	--	--	--	--	Restricted-Band	--	--	--	--	--	--

Test Notes: UT APINP203 SN# CNCPK2T00L on 150cm table powered by AC. Power reduced to 53 to meet band edge limit.

This test report may be reproduced in full only. The document may only be updated by MiCOM Labs personnel. All changes will be noted in the Document History section of the report.



**Title:** Hewlett Packard Enterprise APINR203 & APINP203  
**To:** FCC CFR 47 Part 15 Subpart E 15.407  
**Serial #:** HPEN96-U12 Rev A (1x1) (Conducted & Radiated Data)  
**Issue Date:** 13th June 2017  
**Page:** 65 of 147

**Equipment Configuration for Restricted Lower Band-Edge Emissions**

<b>Antenna:</b>	HPE Metal Sheet	<b>Variant:</b>	802.11a
<b>Antenna Gain (dBi):</b>	2.90	<b>Modulation:</b>	OFDM
<b>Beam Forming Gain (Y):</b>	Not Applicable	<b>Duty Cycle (%):</b>	99
<b>Channel Frequency (MHz):</b>	5500.00	<b>Data Rate:</b>	6.00 MBit/s
<b>Power Setting:</b>	65	<b>Tested By:</b>	JMH

**Test Measurement Results**

**5325.00 - 5500.00 MHz**

Num	Frequency MHz	Raw dBµV	Cable Loss dB	AF dB	Level dBµV/m	Measurement Type	Pol	Hgt cm	Azt Deg	Limit dBµV/m	Margin dB	Pass /Fail
#1	5457.55	15.49	3.80	34.30	53.59	Max Avg	Horizontal	184	351	54.0	-0.4	Pass
#2	5458.25	34.54	3.80	34.30	72.64	Max Peak	Horizontal	184	351	74.0	-1.4	Pass
#4	5467.19	18.58	3.77	34.31	56.66	Max Avg	Horizontal	184	351	68.2	-11.5	Pass
#3	5460.00	--	--	--	--	Restricted-Band	--	--	--	--	--	--
#5	5470.00	--	--	--	--	Band-Edge	--	--	--	--	--	--

Test Notes: UT APINP203 SN# CNCPK2T00L on 150cm table powered by AC. Power reduced to 65 to meet band edge limit.

This test report may be reproduced in full only. The document may only be updated by MiCOM Labs personnel. All changes will be noted in the Document History section of the report.



**Title:** Hewlett Packard Enterprise APINR203 & APINP203  
**To:** FCC CFR 47 Part 15 Subpart E 15.407  
**Serial #:** HPEN96-U12 Rev A (1x1) (Conducted & Radiated Data)  
**Issue Date:** 13th June 2017  
**Page:** 66 of 147

**Equipment Configuration for Restricted Lower Band-Edge Emissions**

<b>Antenna:</b>	HPE Metal Sheet	<b>Variant:</b>	802.11ac-80
<b>Antenna Gain (dBi):</b>	2.90	<b>Modulation:</b>	OFDM
<b>Beam Forming Gain (Y):</b>	Not Applicable	<b>Duty Cycle (%):</b>	99
<b>Channel Frequency (MHz):</b>	5530.00	<b>Data Rate:</b>	29.30 MBit/s
<b>Power Setting:</b>	57	<b>Tested By:</b>	JMH

**Test Measurement Results**

**5350.00 - 5530.00 MHz**

Num	Frequency MHz	Raw dBµV	Cable Loss dB	AF dB	Level dBµV/m	Measurement Type	Pol	Hgt cm	Azt Deg	Limit dBµV/m	Margin dB	Pass /Fail
#1	5457.47	15.58	3.80	34.30	53.68	Max Avg	Horizontal	184	351	54.0	-0.3	Pass
#2	5457.84	32.96	3.80	34.30	71.06	Max Peak	Horizontal	184	351	74.0	-2.9	Pass
#4	5467.47	16.77	3.77	34.31	54.85	Max Avg	Horizontal	184	351	68.2	-13.4	Pass
#3	5460.00	--	--	--	--	Restricted-Band	--	--	--	--	--	--
#5	5470.00	--	--	--	--	Band-Edge	--	--	--	--	--	--

Test Notes: UT APINP203 SN# CNCPK2T00L on 150cm table powered by AC. Power reduced to 57 to meet band edge limit.

This test report may be reproduced in full only. The document may only be updated by MiCOM Labs personnel. All changes will be noted in the Document History section of the report.



**Title:** Hewlett Packard Enterprise APINR203 & APINP203  
**To:** FCC CFR 47 Part 15 Subpart E 15.407  
**Serial #:** HPEN96-U12 Rev A (1x1) (Conducted & Radiated Data)  
**Issue Date:** 13th June 2017  
**Page:** 67 of 147

**Equipment Configuration for Restricted Lower Band-Edge Emissions**

<b>Antenna:</b>	HPE Metal Sheet	<b>Variant:</b>	802.11n HT-20
<b>Antenna Gain (dBi):</b>	2.90	<b>Modulation:</b>	OFDM
<b>Beam Forming Gain (Y):</b>	Not Applicable	<b>Duty Cycle (%):</b>	99
<b>Channel Frequency (MHz):</b>	5500.00	<b>Data Rate:</b>	6.50 MBit/s
<b>Power Setting:</b>	70	<b>Tested By:</b>	JMH

**Test Measurement Results**

**5350.00 - 5500.00 MHz**

Num	Frequency MHz	Raw dBµV	Cable Loss dB	AF dB	Level dBµV/m	Measurement Type	Pol	Hgt cm	Azt Deg	Limit dBµV/m	Margin dB	Pass /Fail
#1	5460.00	15.10	3.79	34.31	53.20	Max Avg	Horizontal	184	351	54.0	-0.8	Pass
#2	5460.00	29.90	3.79	34.31	68.00	Max Peak	Horizontal	184	351	74.0	-6.0	Pass
#4	5470.00	19.04	3.76	34.32	57.12	Max Avg	Horizontal	184	351	68.2	-11.1	Pass
#3	5460.00	--	--	--	--	Restricted-Band	--	--	--	--	--	--
#5	5470.00	--	--	--	--	Band-Edge	--	--	--	--	--	--

Test Notes: UT APINP203 SN# CNCPK2T00L on 150cm table powered by AC. Power reduced to 70 to meet band edge limit.

This test report may be reproduced in full only. The document may only be updated by MiCOM Labs personnel. All changes will be noted in the Document History section of the report.



**Title:** Hewlett Packard Enterprise APINR203 & APINP203  
**To:** FCC CFR 47 Part 15 Subpart E 15.407  
**Serial #:** HPEN96-U12 Rev A (1x1) (Conducted & Radiated Data)  
**Issue Date:** 13th June 2017  
**Page:** 68 of 147

**Equipment Configuration for Restricted Lower Band-Edge Emissions**

<b>Antenna:</b>	HPE Metal Sheet	<b>Variant:</b>	802.11n HT-40
<b>Antenna Gain (dBi):</b>	2.90	<b>Modulation:</b>	OFDM
<b>Beam Forming Gain (Y):</b>	Not Applicable	<b>Duty Cycle (%):</b>	99
<b>Channel Frequency (MHz):</b>	5510.00	<b>Data Rate:</b>	13.50 MBit/s
<b>Power Setting:</b>	72	<b>Tested By:</b>	JMH

**Test Measurement Results**

**5325.00 - 5510.00 MHz**

Num	Frequency MHz	Raw dBµV	Cable Loss dB	AF dB	Level dBµV/m	Measurement Type	Pol	Hgt cm	Azt Deg	Limit dBµV/m	Margin dB	Pass /Fail
#1	5460.00	15.49	3.79	34.31	53.59	Max Avg	Horizontal	184	351	54.0	-0.4	Pass
#2	5460.00	33.93	3.79	34.31	72.03	Max Peak	Horizontal	184	351	74.0	-2.0	Pass
#4	5470.00	20.07	3.76	34.32	58.15	Max Avg	Horizontal	184	351	68.2	-10.1	Pass
#3	5460.00	--	--	--	--	Restricted-Band	--	--	--	--	--	--
#5	5470.00	--	--	--	--	Band-Edge	--	--	--	--	--	--

Test Notes: EUT APINP203 SN# CNCPK2T00L on 150cm table powered by AC. Power reduced to 57 to meet band edge limit.

This test report may be reproduced in full only. The document may only be updated by MiCOM Labs personnel. All changes will be noted in the Document History section of the report.



**Title:** Hewlett Packard Enterprise APINR203 & APINP203  
**To:** FCC CFR 47 Part 15 Subpart E 15.407  
**Serial #:** HPEN96-U12 Rev A (1x1) (Conducted & Radiated Data)  
**Issue Date:** 13th June 2017  
**Page:** 69 of 147

---

## **A. APPENDIX - GRAPHICAL IMAGES**

---

This test report may be reproduced in full only. The document may only be updated by MiCOM Labs personnel. All changes will be noted in the Document History section of the report.





### A.1. 26 dB & 99% Bandwidth



#### 26 dB & 99% BANDWIDTH

Variat: 802.11a, Channel: 5260.00 MHz, Chain a, Temp: 20, Voltage: 110 Vac

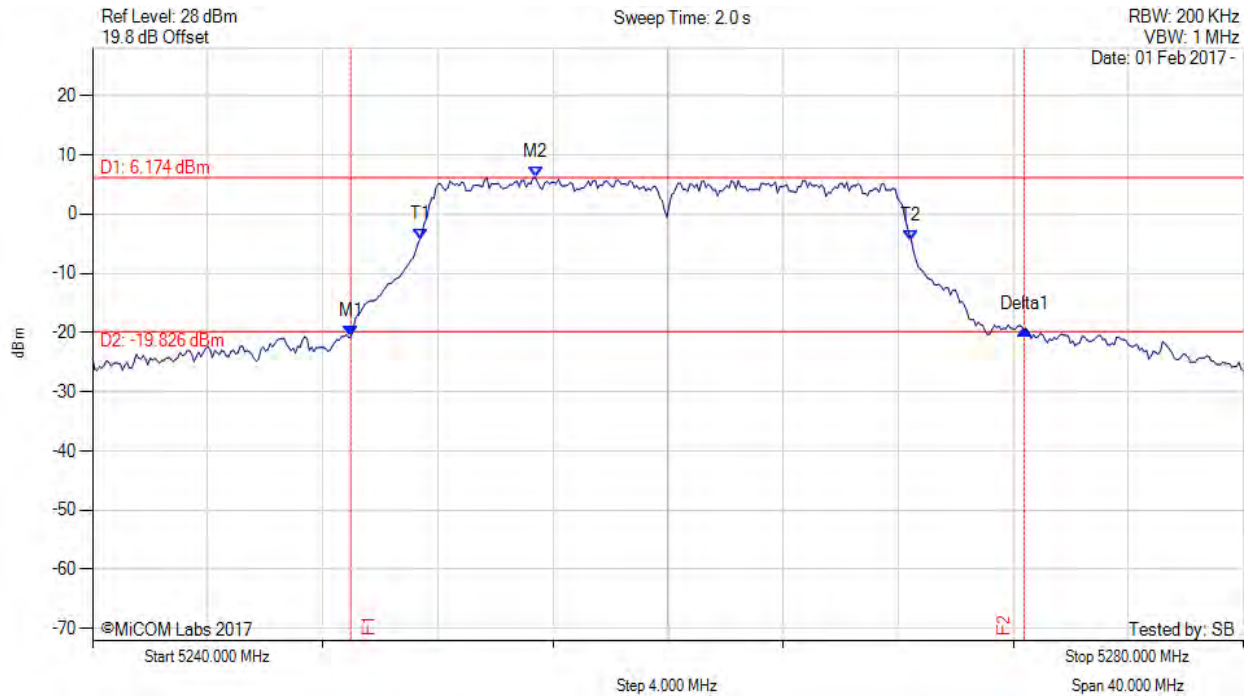

Analyzer Setup	Marker:Frequency:Amplitude	Test Results
Detector = MAX PEAK Sweep Count = 0 RF Atten (dB) = 20 Trace Mode = MAX HOLD	M1 : 5248.978 MHz : -20.735 dBm M2 : 5255.391 MHz : 6.174 dBm Delta1 : 23.407 MHz : 1.202 dB T1 : 5251.383 MHz : -4.213 dBm T2 : 5268.457 MHz : -4.426 dBm OBW : 17.074 MHz	Measured 26 dB Bandwidth: 23.407 MHz Measured 99% Bandwidth: 17.074 MHz

[back to matrix](#)

This test report may be reproduced in full only. The document may only be updated by MiCOM Labs personnel. All changes will be noted in the Document History section of the report.



**Title:** Hewlett Packard Enterprise APINR203 & APINP203  
**To:** FCC CFR 47 Part 15 Subpart E 15.407  
**Serial #:** HPEN96-U12 Rev A (1x1) (Conducted & Radiated Data)  
**Issue Date:** 13th June 2017  
**Page:** 71 of 147

26 dB & 99% BANDWIDTH



Variant: 802.11a, Channel: 5300.00 MHz, Chain a, Temp: 20, Voltage: 110 Vac

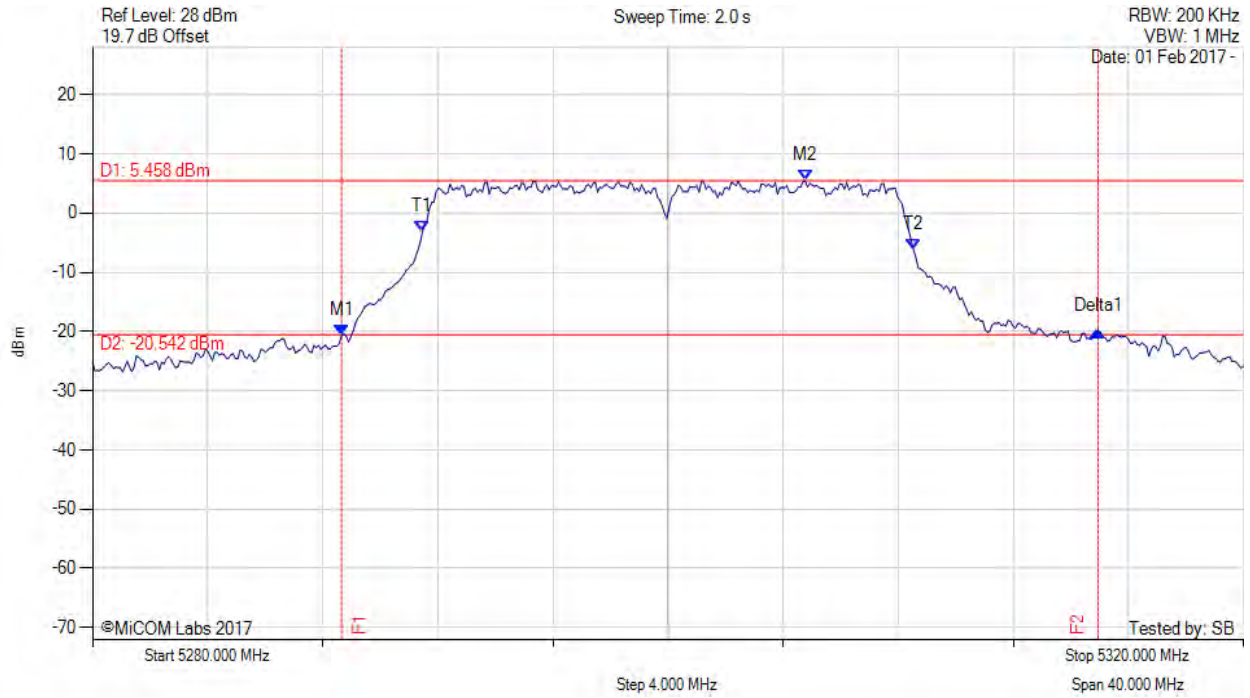

Analyzer Setup	Marker:Frequency:Amplitude	Test Results
Detector = MAX PEAK Sweep Count = 0 RF Atten (dB) = 20 Trace Mode = MAX HOLD	M1 : 5288.657 MHz : -20.657 dBm M2 : 5304.770 MHz : 5.458 dBm Delta1 : 26.293 MHz : 0.781 dB T1 : 5291.463 MHz : -3.173 dBm T2 : 5308.537 MHz : -6.224 dBm OBW : 17.074 MHz	Measured 26 dB Bandwidth: 26.293 MHz Measured 99% Bandwidth: 17.074 MHz

[back to matrix](#)

This test report may be reproduced in full only. The document may only be updated by MiCOM Labs personnel. All changes will be noted in the Document History section of the report.



26 dB & 99% BANDWIDTH



Variant: 802.11a, Channel: 5320.00 MHz, Chain a, Temp: 20, Voltage: 110 Vac

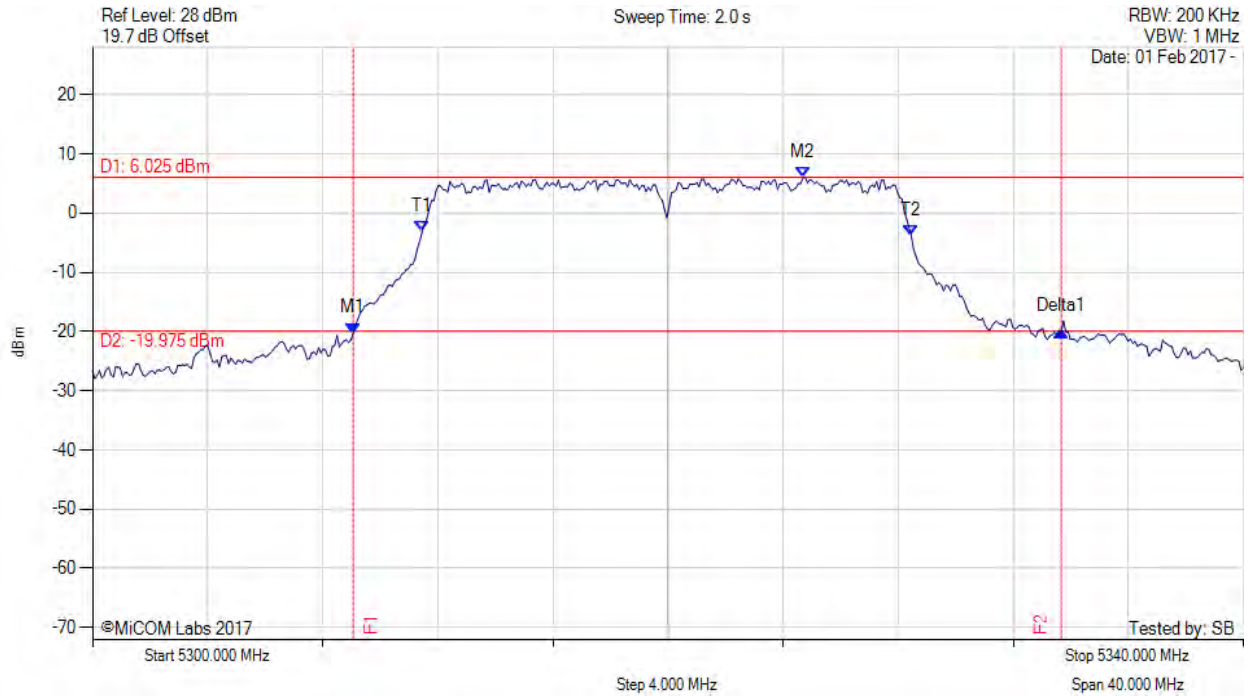

Analyzer Setup	Marker:Frequency:Amplitude	Test Results
Detector = MAX PEAK Sweep Count = 0 RF Atten (dB) = 20 Trace Mode = MAX HOLD	M1 : 5309.058 MHz : -20.283 dBm M2 : 5324.689 MHz : 6.025 dBm Delta1 : 24.609 MHz : 0.293 dB T1 : 5311.463 MHz : -3.041 dBm T2 : 5328.457 MHz : -3.897 dBm OBW : 16.994 MHz	Measured 26 dB Bandwidth: 24.609 MHz Measured 99% Bandwidth: 16.994 MHz

[back to matrix](#)

This test report may be reproduced in full only. The document may only be updated by MiCOM Labs personnel. All changes will be noted in the Document History section of the report.



**Title:** Hewlett Packard Enterprise APINR203 & APINP203  
**To:** FCC CFR 47 Part 15 Subpart E 15.407  
**Serial #:** HPEN96-U12 Rev A (1x1) (Conducted & Radiated Data)  
**Issue Date:** 13th June 2017  
**Page:** 73 of 147

26 dB & 99% BANDWIDTH



Variant: 802.11ac-80, Channel: 5290.00 MHz, Chain a, Temp: 20, Voltage: 110 Vac

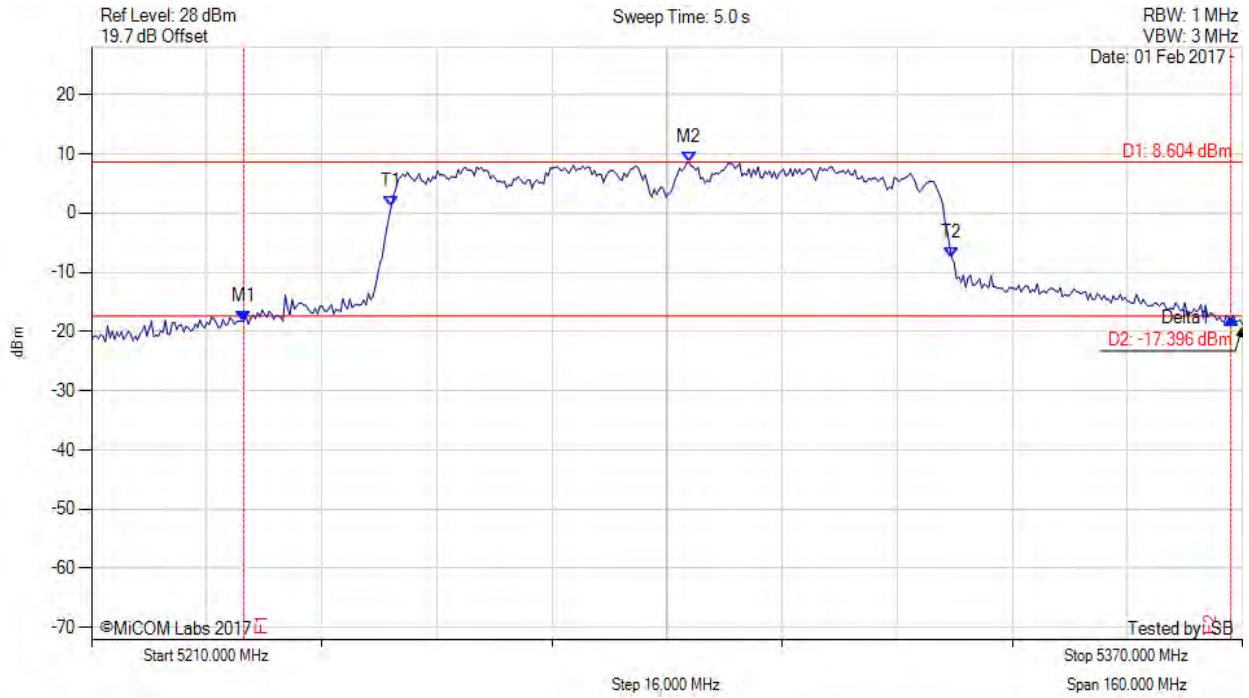

Analyzer Setup	Marker:Frequency:Amplitude	Test Results
Detector = MAX PEAK Sweep Count = 0 RF Atten (dB) = 20 Trace Mode = MAX HOLD	M1 : 5231.162 MHz : -18.327 dBm M2 : 5293.046 MHz : 8.604 dBm Delta1 : 137.234 MHz : 0.567 dB T1 : 5251.683 MHz : 1.173 dBm T2 : 5329.599 MHz : -7.574 dBm OBW : 77.916 MHz	Measured 26 dB Bandwidth: 137.234 MHz Measured 99% Bandwidth: 77.916 MHz

[back to matrix](#)

This test report may be reproduced in full only. The document may only be updated by MiCOM Labs personnel. All changes will be noted in the Document History section of the report.



**Title:** Hewlett Packard Enterprise APINR203 & APINP203  
**To:** FCC CFR 47 Part 15 Subpart E 15.407  
**Serial #:** HPEN96-U12 Rev A (1x1) (Conducted & Radiated Data)  
**Issue Date:** 13th June 2017  
**Page:** 74 of 147

26 dB & 99% BANDWIDTH



Variant: 802.11n HT-20, Channel: 5260.00 MHz, Chain a, Temp: 20, Voltage: 110 Vac

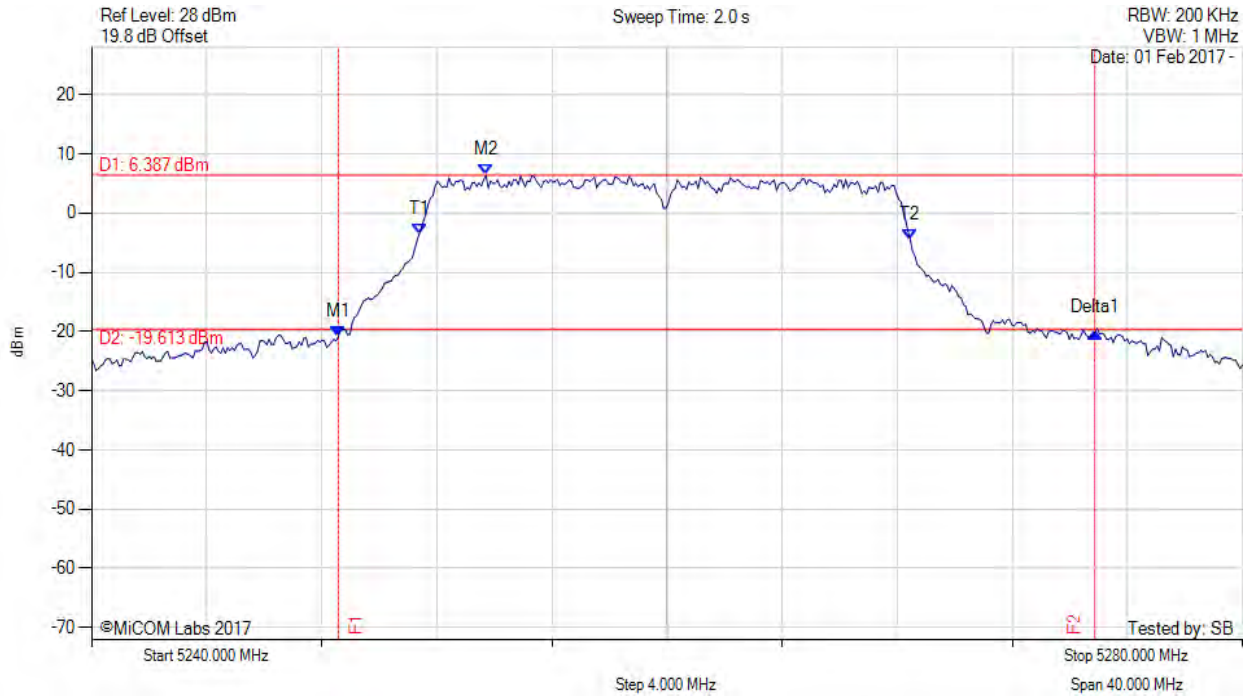

Analyzer Setup	Marker:Frequency:Amplitude	Test Results
Detector = MAX PEAK Sweep Count = 0 RF Atten (dB) = 20 Trace Mode = MAX HOLD	M1 : 5248.577 MHz : -20.877 dBm M2 : 5253.707 MHz : 6.387 dBm Delta1 : 26.293 MHz : 0.755 dB T1 : 5251.383 MHz : -3.602 dBm T2 : 5268.457 MHz : -4.516 dBm OBW : 17.074 MHz	Measured 26 dB Bandwidth: 26.293 MHz Measured 99% Bandwidth: 17.074 MHz

[back to matrix](#)

This test report may be reproduced in full only. The document may only be updated by MiCOM Labs personnel. All changes will be noted in the Document History section of the report.



26 dB & 99% BANDWIDTH



Variant: 802.11n HT-20, Channel: 5300.00 MHz, Chain a, Temp: 20, Voltage: 110 Vac

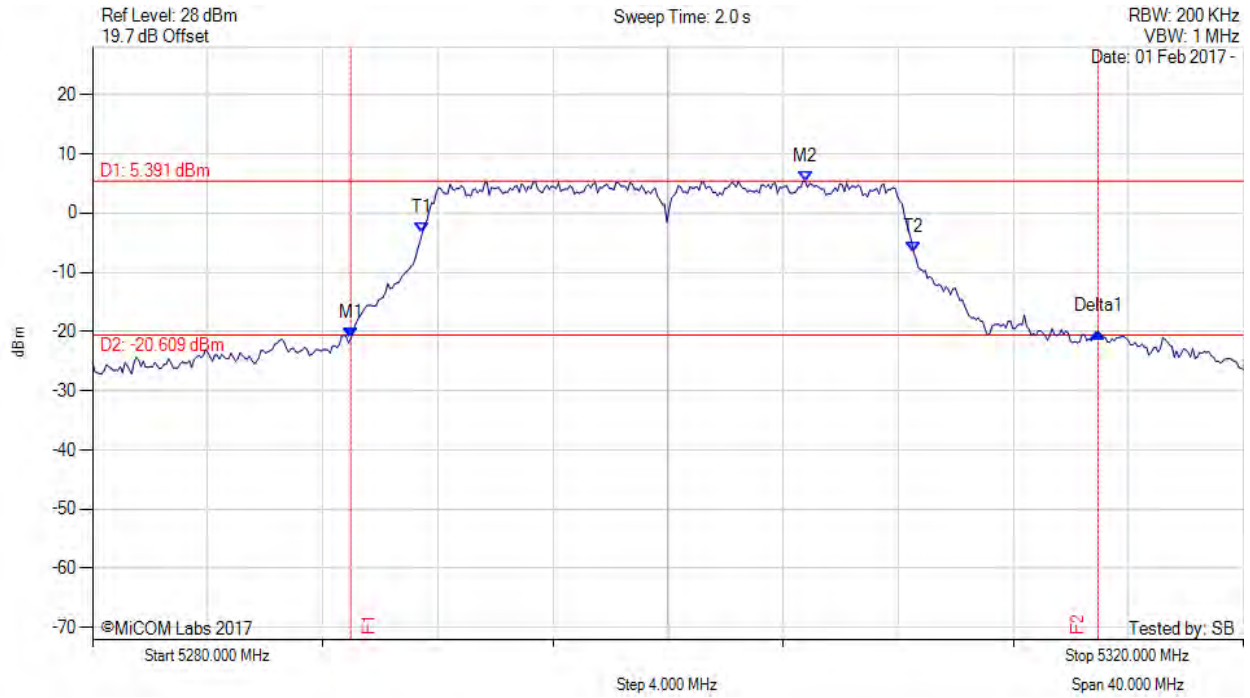

Analyzer Setup	Marker:Frequency:Amplitude	Test Results
Detector = MAX PEAK Sweep Count = 0 RF Atten (dB) = 20 Trace Mode = MAX HOLD	M1 : 5288.978 MHz : -21.200 dBm M2 : 5304.770 MHz : 5.391 dBm Delta1 : 25.972 MHz : 1.135 dB T1 : 5291.463 MHz : -3.310 dBm T2 : 5308.537 MHz : -6.635 dBm OBW : 17.074 MHz	Measured 26 dB Bandwidth: 25.972 MHz Measured 99% Bandwidth: 17.074 MHz

[back to matrix](#)

This test report may be reproduced in full only. The document may only be updated by MiCOM Labs personnel. All changes will be noted in the Document History section of the report.





26 dB & 99% BANDWIDTH



Variant: 802.11n HT-20, Channel: 5320.00 MHz, Chain a, Temp: 20, Voltage: 110 Vac

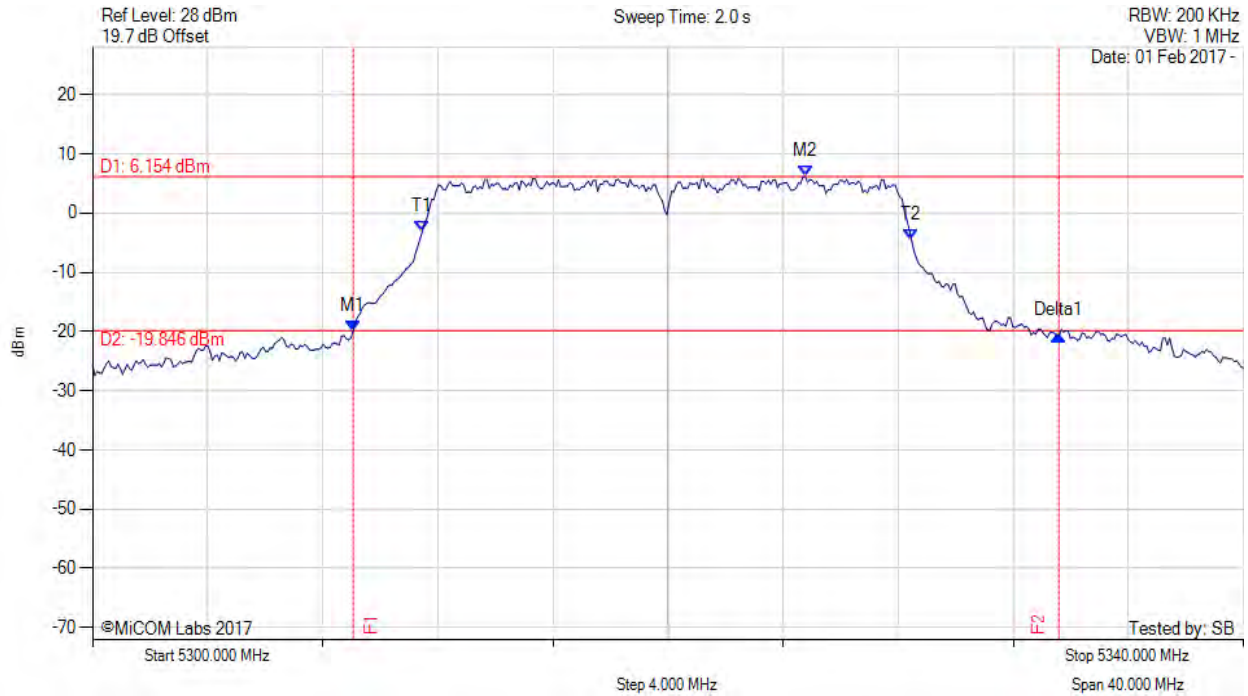

Analyzer Setup	Marker:Frequency:Amplitude	Test Results
Detector = MAX PEAK Sweep Count = 0 RF Atten (dB) = 20 Trace Mode = MAX HOLD	M1 : 5309.058 MHz : -19.899 dBm M2 : 5324.770 MHz : 6.154 dBm Delta1 : 24.529 MHz : -0.771 dB T1 : 5311.463 MHz : -3.102 dBm T2 : 5328.457 MHz : -4.414 dBm OBW : 16.994 MHz	Measured 26 dB Bandwidth: 24.529 MHz Measured 99% Bandwidth: 16.994 MHz

[back to matrix](#)

This test report may be reproduced in full only. The document may only be updated by MiCOM Labs personnel. All changes will be noted in the Document History section of the report.



**Title:** Hewlett Packard Enterprise APINR203 & APINP203  
**To:** FCC CFR 47 Part 15 Subpart E 15.407  
**Serial #:** HPEN96-U12 Rev A (1x1) (Conducted & Radiated Data)  
**Issue Date:** 13th June 2017  
**Page:** 77 of 147

26 dB & 99% BANDWIDTH



Variant: 802.11n HT-40, Channel: 5270.00 MHz, Chain a, Temp: 20, Voltage: 110 Vac

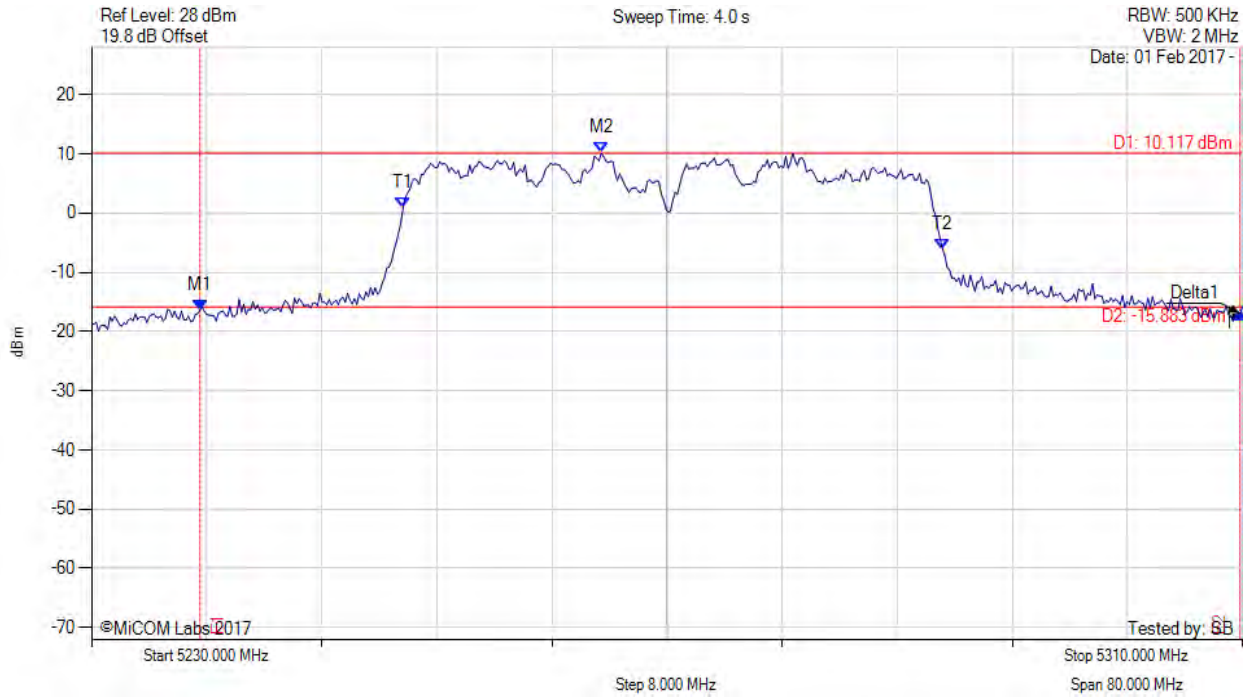

Analyzer Setup	Marker:Frequency:Amplitude	Test Results
Detector = MAX PEAK Sweep Count = 0 RF Atten (dB) = 20 Trace Mode = MAX HOLD	M1 : 5237.535 MHz : -16.403 dBm M2 : 5265.431 MHz : 10.117 dBm Delta1 : 72.305 MHz : -0.574 dB T1 : 5251.643 MHz : 0.813 dBm T2 : 5289.158 MHz : -6.057 dBm OBW : 37.515 MHz	Measured 26 dB Bandwidth: 72.305 MHz Measured 99% Bandwidth: 37.515 MHz

[back to matrix](#)

This test report may be reproduced in full only. The document may only be updated by MiCOM Labs personnel. All changes will be noted in the Document History section of the report.





**Title:** Hewlett Packard Enterprise APINR203 & APINP203  
**To:** FCC CFR 47 Part 15 Subpart E 15.407  
**Serial #:** HPEN96-U12 Rev A (1x1) (Conducted & Radiated Data)  
**Issue Date:** 13th June 2017  
**Page:** 78 of 147

26 dB & 99% BANDWIDTH



Variant: 802.11n HT-40, Channel: 5310.00 MHz, Chain a, Temp: 20, Voltage: 110 Vac

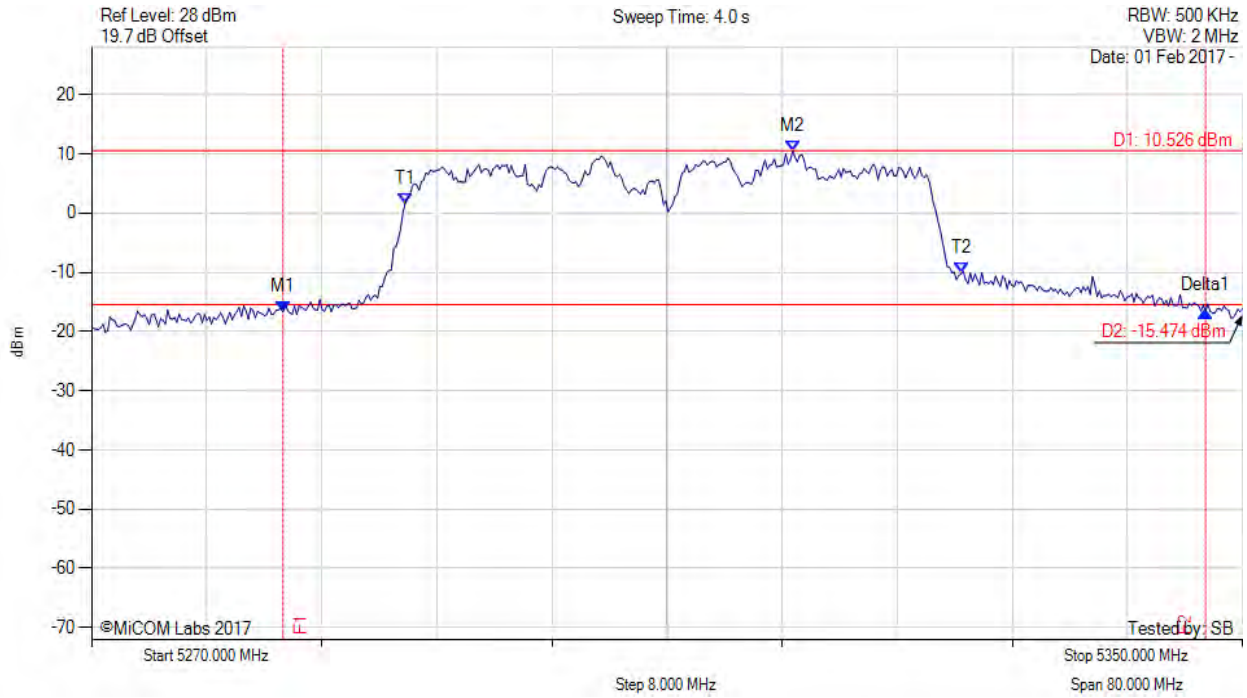

Analyzer Setup	Marker:Frequency:Amplitude	Test Results
Detector = MAX PEAK Sweep Count = 0 RF Atten (dB) = 20 Trace Mode = MAX HOLD	M1 : 5283.307 MHz : -16.675 dBm M2 : 5318.737 MHz : 10.526 dBm Delta1 : 64.128 MHz : 0.134 dB T1 : 5291.804 MHz : 1.649 dBm T2 : 5330.441 MHz : -10.220 dBm OBW : 38.637 MHz	Measured 26 dB Bandwidth: 64.128 MHz Measured 99% Bandwidth: 38.637 MHz

[back to matrix](#)

This test report may be reproduced in full only. The document may only be updated by MiCOM Labs personnel. All changes will be noted in the Document History section of the report.



26 dB & 99% BANDWIDTH

Variant: 802.11a, Channel: 5500.00 MHz, Chain a, Temp: 20, Voltage: 110 Vac

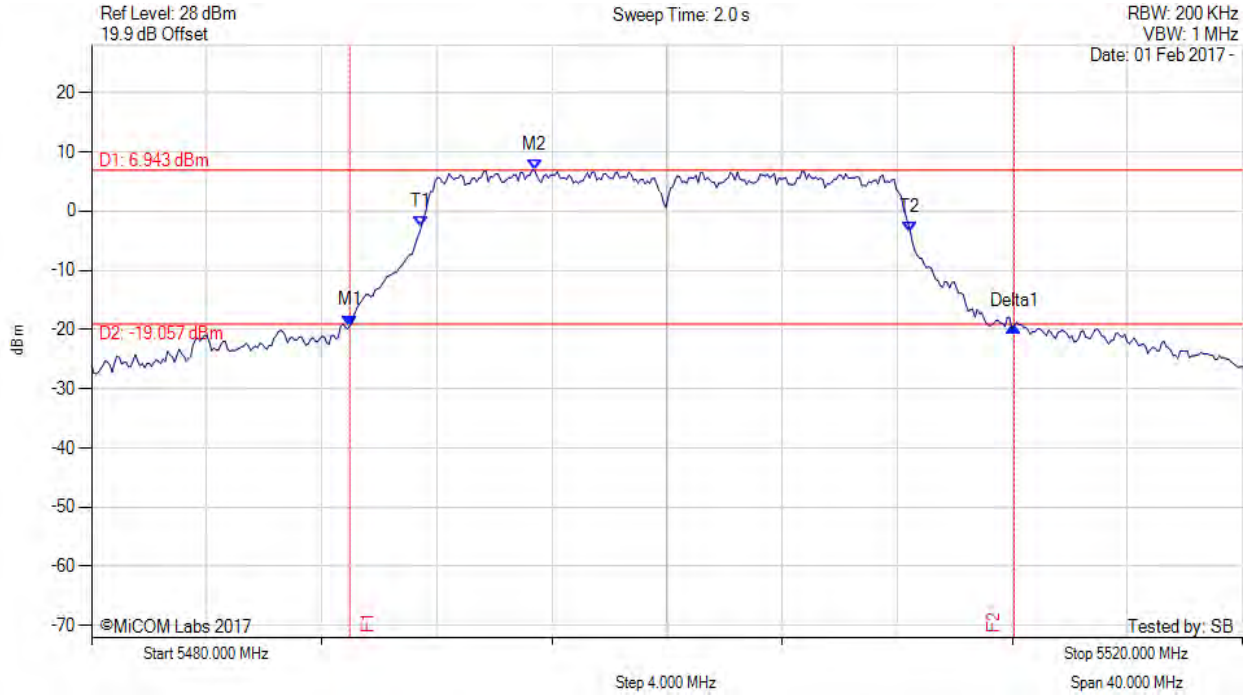

Analyzer Setup	Marker:Frequency:Amplitude	Test Results
Detector = MAX PEAK Sweep Count = 0 RF Atten (dB) = 20 Trace Mode = MAX HOLD	M1 : 5488.978 MHz : -19.344 dBm M2 : 5495.391 MHz : 6.943 dBm Delta1 : 23.086 MHz : -0.087 dB T1 : 5491.463 MHz : -2.614 dBm T2 : 5508.457 MHz : -3.513 dBm OBW : 16.994 MHz	Measured 26 dB Bandwidth: 23.086 MHz Measured 99% Bandwidth: 16.994 MHz

[back to matrix](#)

This test report may be reproduced in full only. The document may only be updated by MiCOM Labs personnel. All changes will be noted in the Document History section of the report.



26 dB & 99% BANDWIDTH



Variant: 802.11a, Channel: 5580.00 MHz, Chain a, Temp: 20, Voltage: 110 Vac

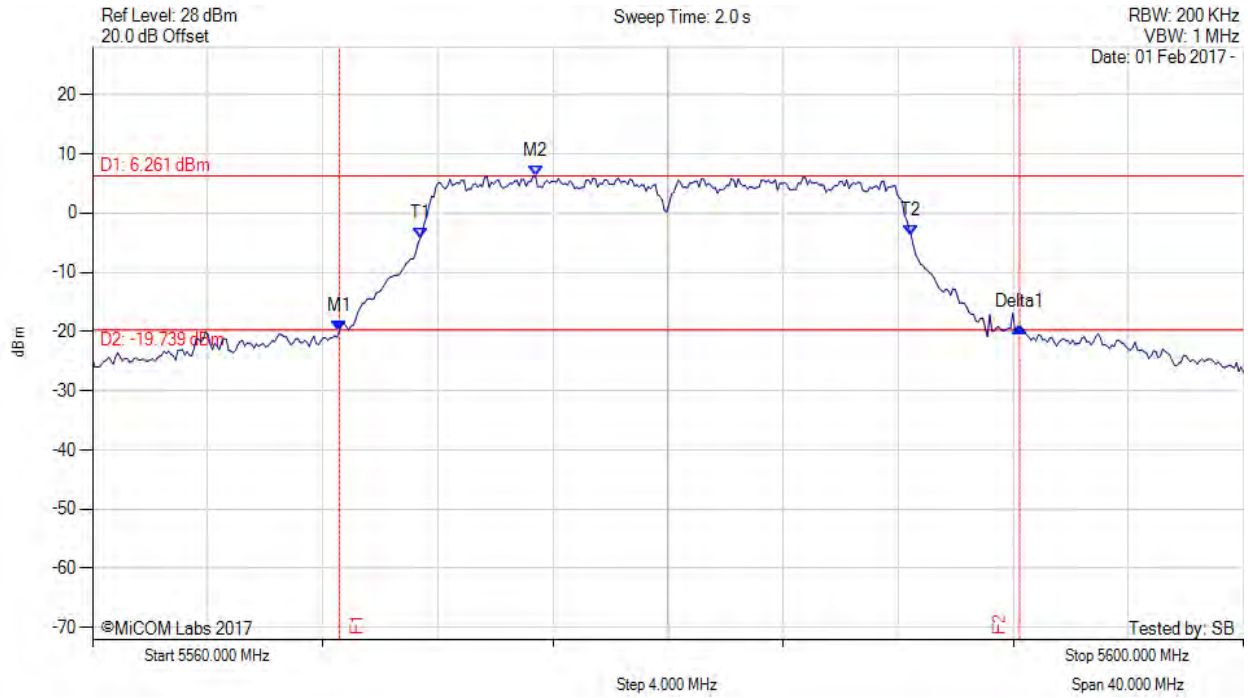

Analyzer Setup	Marker:Frequency:Amplitude	Test Results
Detector = MAX PEAK Sweep Count = 0 RF Atten (dB) = 20 Trace Mode = MAX HOLD	M1 : 5568.577 MHz : -19.864 dBm M2 : 5575.391 MHz : 6.261 dBm Delta1 : 23.647 MHz : 0.667 dB T1 : 5571.383 MHz : -4.288 dBm T2 : 5588.457 MHz : -3.891 dBm OBW : 17.074 MHz	Measured 26 dB Bandwidth: 23.647 MHz Measured 99% Bandwidth: 17.074 MHz

[back to matrix](#)

This test report may be reproduced in full only. The document may only be updated by MiCOM Labs personnel. All changes will be noted in the Document History section of the report.



26 dB & 99% BANDWIDTH

Variant: 802.11a, Channel: 5720.00 MHz, Chain a, Temp: 20, Voltage: 110 Vac

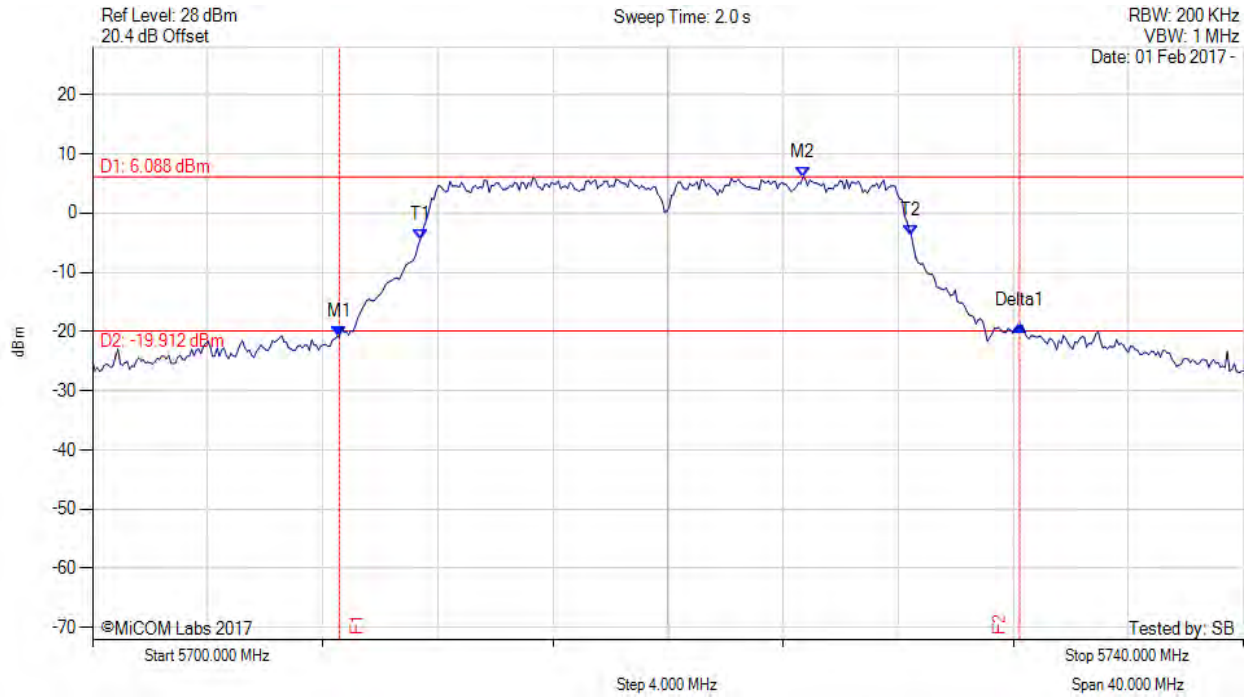

Analyzer Setup	Marker:Frequency:Amplitude	Test Results
Detector = MAX PEAK Sweep Count = 0 RF Atten (dB) = 20 Trace Mode = MAX HOLD	M1 : 5708.577 MHz : -20.922 dBm M2 : 5724.689 MHz : 6.088 dBm Delta1 : 23.647 MHz : 1.839 dB T1 : 5711.383 MHz : -4.572 dBm T2 : 5728.457 MHz : -3.745 dBm OBW : 17.074 MHz	Measured 26 dB Bandwidth: 23.647 MHz Measured 99% Bandwidth: 17.074 MHz

[back to matrix](#)

This test report may be reproduced in full only. The document may only be updated by MiCOM Labs personnel. All changes will be noted in the Document History section of the report.



26 dB & 99% BANDWIDTH

Variant: 802.11ac-80, Channel: 5530.00 MHz, Chain a, Temp: 20, Voltage: 110 Vac

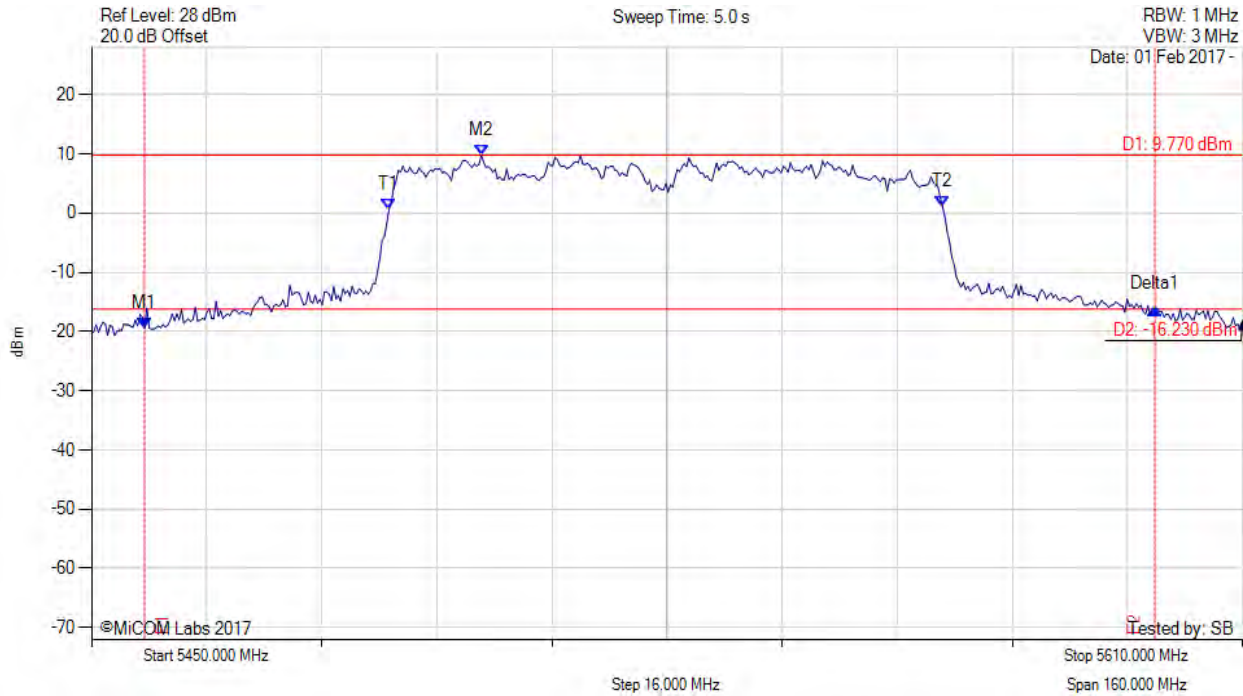

Analyzer Setup	Marker:Frequency:Amplitude	Test Results
Detector = MAX PEAK Sweep Count = 0 RF Atten (dB) = 20 Trace Mode = MAX HOLD	M1 : 5457.375 MHz : -19.439 dBm M2 : 5504.188 MHz : 9.770 dBm Delta1 : 140.441 MHz : 3.295 dB T1 : 5491.363 MHz : 0.691 dBm T2 : 5568.317 MHz : 1.047 dBm OBW : 76.954 MHz	Measured 26 dB Bandwidth: 140.441 MHz Measured 99% Bandwidth: 76.954 MHz

[back to matrix](#)

This test report may be reproduced in full only. The document may only be updated by MiCOM Labs personnel. All changes will be noted in the Document History section of the report.



**Title:** Hewlett Packard Enterprise APINR203 & APINP203  
**To:** FCC CFR 47 Part 15 Subpart E 15.407  
**Serial #:** HPEN96-U12 Rev A (1x1) (Conducted & Radiated Data)  
**Issue Date:** 13th June 2017  
**Page:** 83 of 147

26 dB & 99% BANDWIDTH



Variant: 802.11ac-80, Channel: 5610.00 MHz, Chain a, Temp: 20, Voltage: 110 Vac

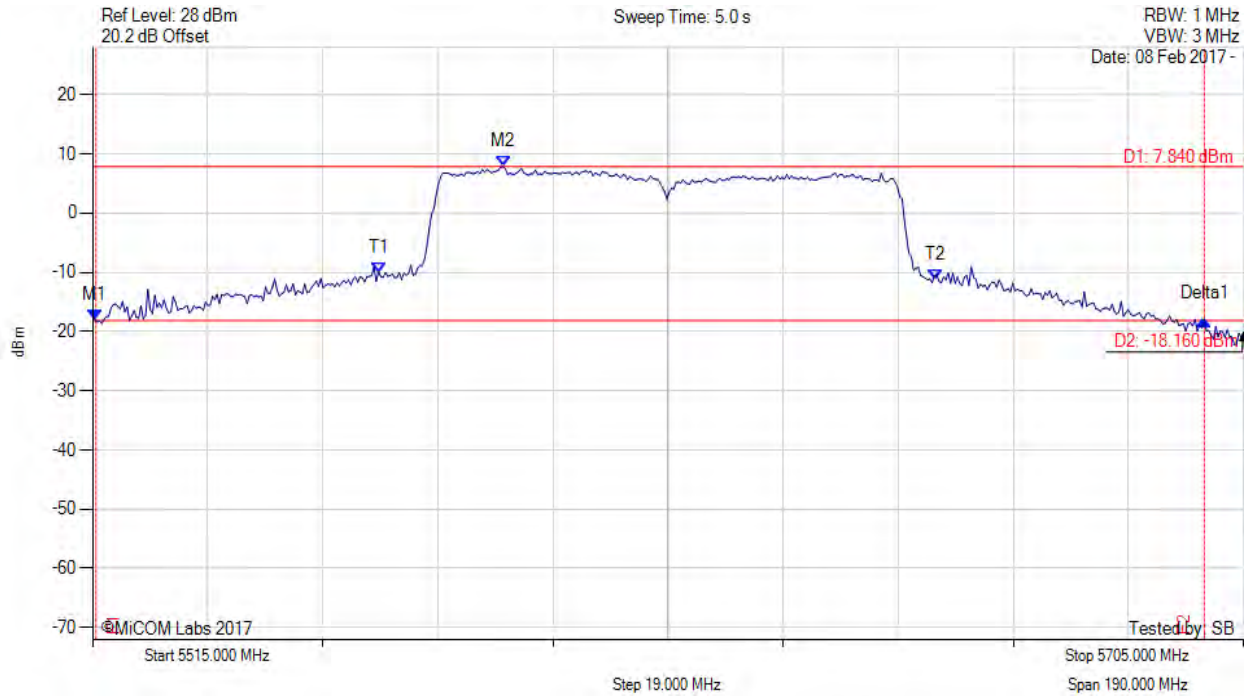

Analyzer Setup	Marker:Frequency:Amplitude	Test Results
Detector = MAX PEAK Sweep Count = 0 RF Atten (dB) = 20 Trace Mode = MAX HOLD	M1 : 5515.381 MHz : -18.036 dBm M2 : 5582.776 MHz : 7.842 dBm Delta1 : 183.176 MHz : 0.087 dB T1 : 5562.385 MHz : -10.186 dBm T2 : 5654.088 MHz : -11.392 dBm OBW : 99.379 MHz	Measured 26 dB Bandwidth: 183.176 MHz Measured 99% Bandwidth: 99.379 MHz

[back to matrix](#)

This test report may be reproduced in full only. The document may only be updated by MiCOM Labs personnel. All changes will be noted in the Document History section of the report.





26 dB & 99% BANDWIDTH

Variant: 802.11ac-80, Channel: 5690.00 MHz, Chain a, Temp: 20, Voltage: 110 Vac

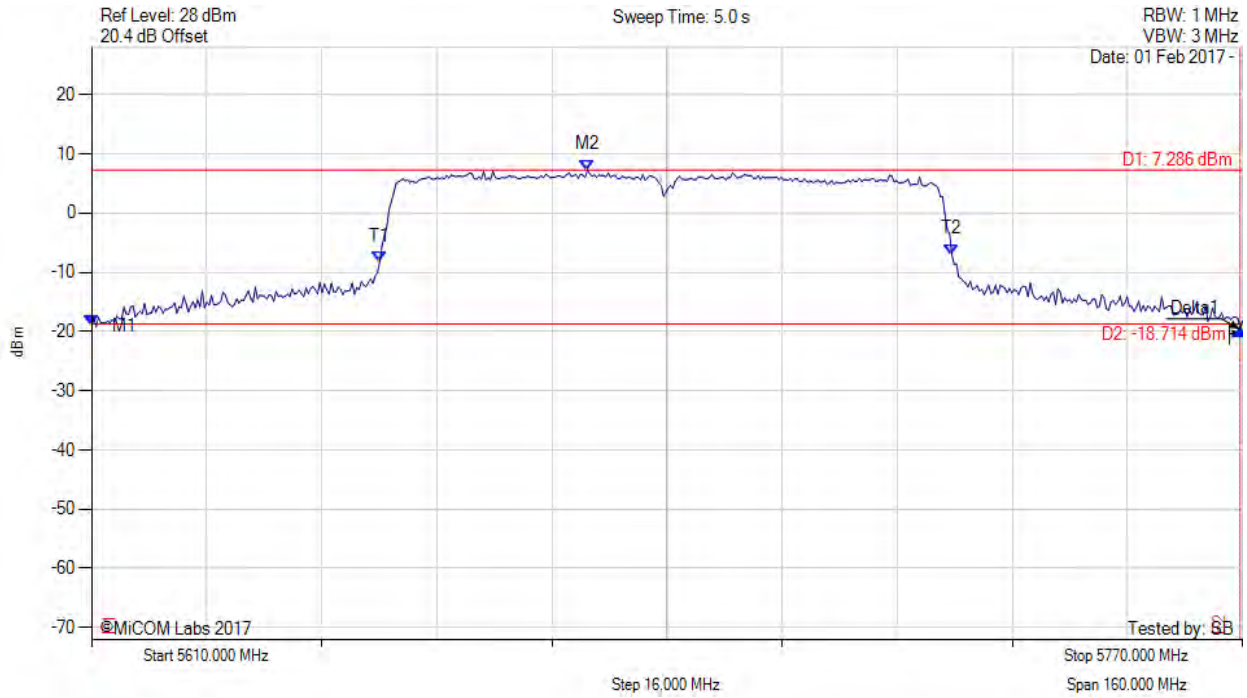

Analyzer Setup	Marker:Frequency:Amplitude	Test Results
Detector = MAX PEAK Sweep Count = 0 RF Atten (dB) = 20 Trace Mode = MAX HOLD	M1 : 5610.000 MHz : -18.973 dBm M2 : 5678.938 MHz : 7.286 dBm Delta1 : 159.679 MHz : -0.618 dB T1 : 5650.080 MHz : -8.195 dBm T2 : 5729.599 MHz : -6.974 dBm OBW : 79.519 MHz	Measured 26 dB Bandwidth: 159.679 MHz Measured 99% Bandwidth: 79.519 MHz

[back to matrix](#)

This test report may be reproduced in full only. The document may only be updated by MiCOM Labs personnel. All changes will be noted in the Document History section of the report.



26 dB & 99% BANDWIDTH



Variant: 802.11n HT-20, Channel: 5500.00 MHz, Chain a, Temp: 20, Voltage: 110 Vac

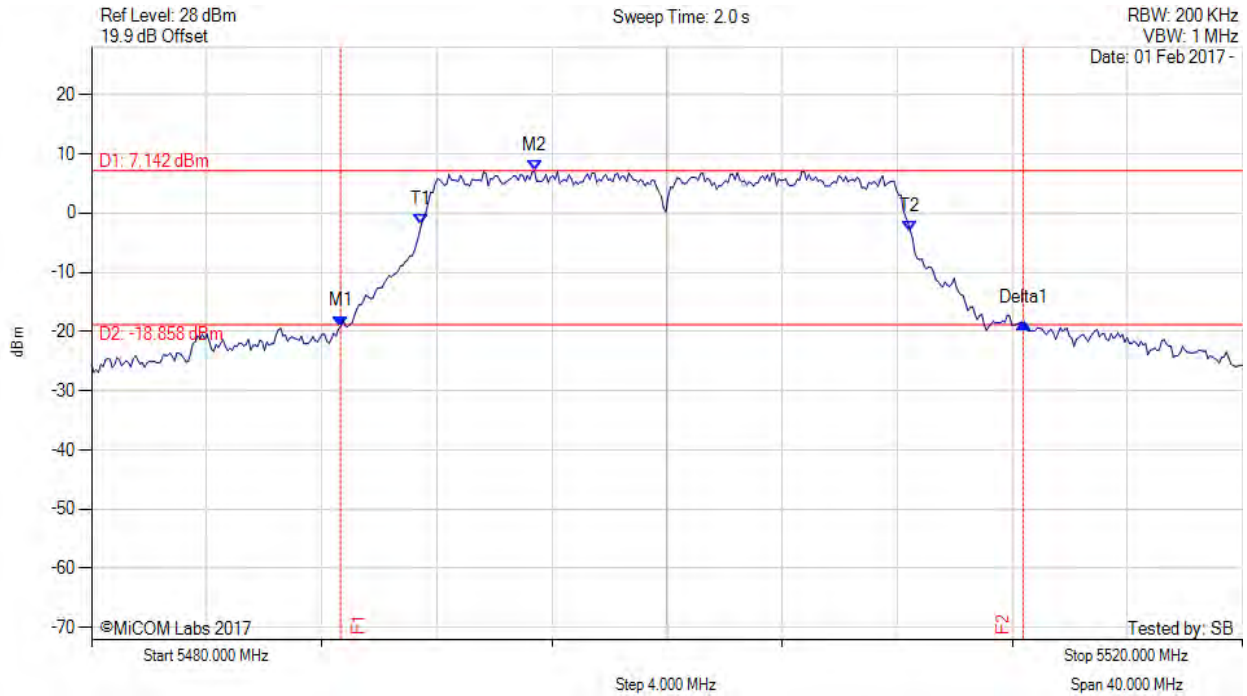

Analyzer Setup	Marker:Frequency:Amplitude	Test Results
Detector = MAX PEAK Sweep Count = 0 RF Atten (dB) = 20 Trace Mode = MAX HOLD	M1 : 5488.657 MHz : -19.112 dBm M2 : 5495.391 MHz : 7.142 dBm Delta1 : 23.727 MHz : 0.606 dB T1 : 5491.463 MHz : -1.855 dBm T2 : 5508.457 MHz : -3.047 dBm OBW : 16.994 MHz	Measured 26 dB Bandwidth: 23.727 MHz Measured 99% Bandwidth: 16.994 MHz

[back to matrix](#)

This test report may be reproduced in full only. The document may only be updated by MiCOM Labs personnel. All changes will be noted in the Document History section of the report.





26 dB & 99% BANDWIDTH



Variant: 802.11n HT-20, Channel: 5580.00 MHz, Chain a, Temp: 20, Voltage: 110 Vac

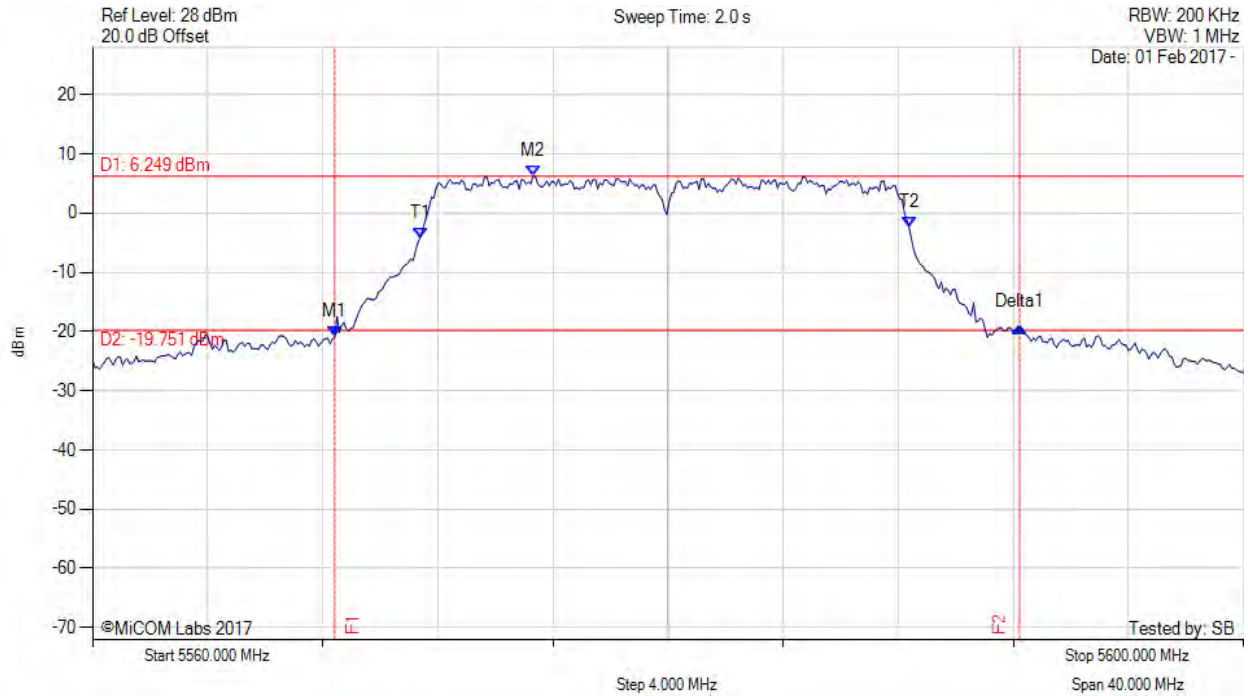

Analyzer Setup	Marker:Frequency:Amplitude	Test Results
Detector = MAX PEAK Sweep Count = 0 RF Atten (dB) = 20 Trace Mode = MAX HOLD	M1 : 5568.417 MHz : -20.875 dBm M2 : 5575.311 MHz : 6.249 dBm Delta1 : 23.808 MHz : 1.704 dB T1 : 5571.383 MHz : -4.190 dBm T2 : 5588.377 MHz : -2.374 dBm OBW : 16.994 MHz	Measured 26 dB Bandwidth: 23.808 MHz Measured 99% Bandwidth: 16.994 MHz

[back to matrix](#)

This test report may be reproduced in full only. The document may only be updated by MiCOM Labs personnel. All changes will be noted in the Document History section of the report.



**Title:** Hewlett Packard Enterprise APINR203 & APINP203  
**To:** FCC CFR 47 Part 15 Subpart E 15.407  
**Serial #:** HPEN96-U12 Rev A (1x1) (Conducted & Radiated Data)  
**Issue Date:** 13th June 2017  
**Page:** 87 of 147

26 dB & 99% BANDWIDTH



Variant: 802.11n HT-20, Channel: 5720.00 MHz, Chain a, Temp: 20, Voltage: 110 Vac

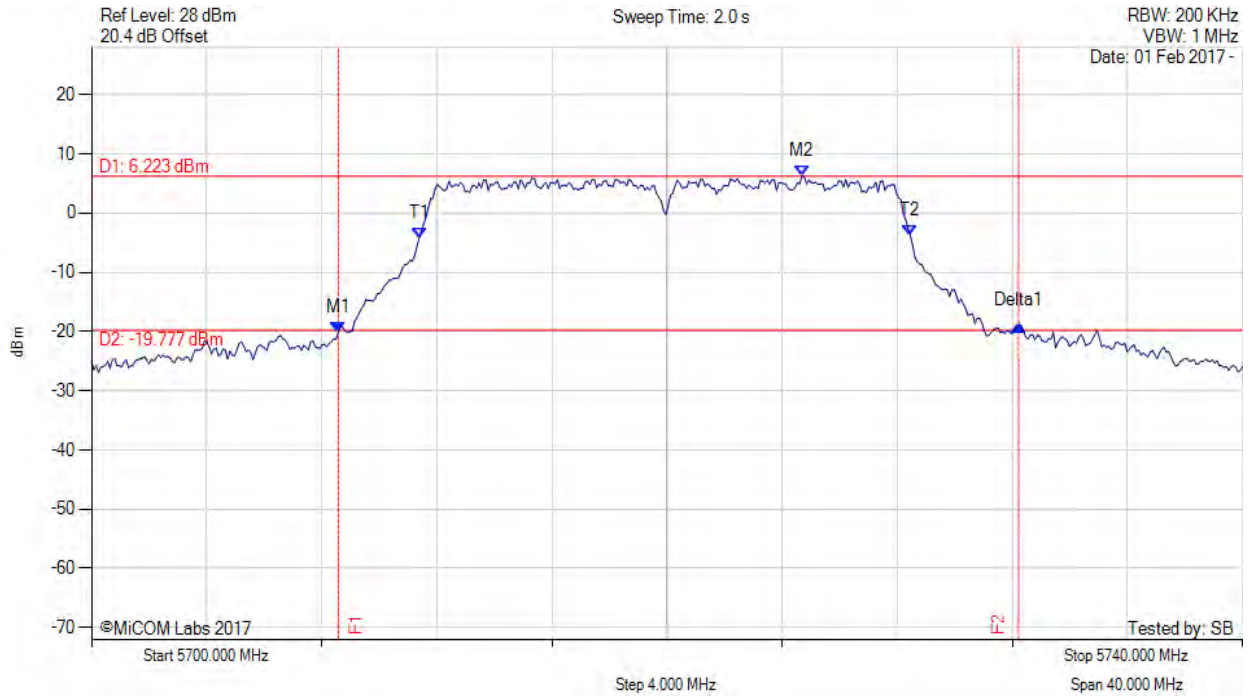

Analyzer Setup	Marker:Frequency:Amplitude	Test Results
Detector = MAX PEAK Sweep Count = 0 RF Atten (dB) = 20 Trace Mode = MAX HOLD	M1 : 5708.577 MHz : -20.141 dBm M2 : 5724.689 MHz : 6.223 dBm Delta1 : 23.647 MHz : 1.216 dB T1 : 5711.383 MHz : -4.335 dBm T2 : 5728.457 MHz : -3.832 dBm OBW : 17.074 MHz	Measured 26 dB Bandwidth: 23.647 MHz Measured 99% Bandwidth: 17.074 MHz

[back to matrix](#)

This test report may be reproduced in full only. The document may only be updated by MiCOM Labs personnel. All changes will be noted in the Document History section of the report.



**Title:** Hewlett Packard Enterprise APINR203 & APINP203  
**To:** FCC CFR 47 Part 15 Subpart E 15.407  
**Serial #:** HPEN96-U12 Rev A (1x1) (Conducted & Radiated Data)  
**Issue Date:** 13th June 2017  
**Page:** 88 of 147



26 dB & 99% BANDWIDTH

Variant: 802.11n HT-40, Channel: 5510.00 MHz, Chain a, Temp: 20, Voltage: 110 Vac

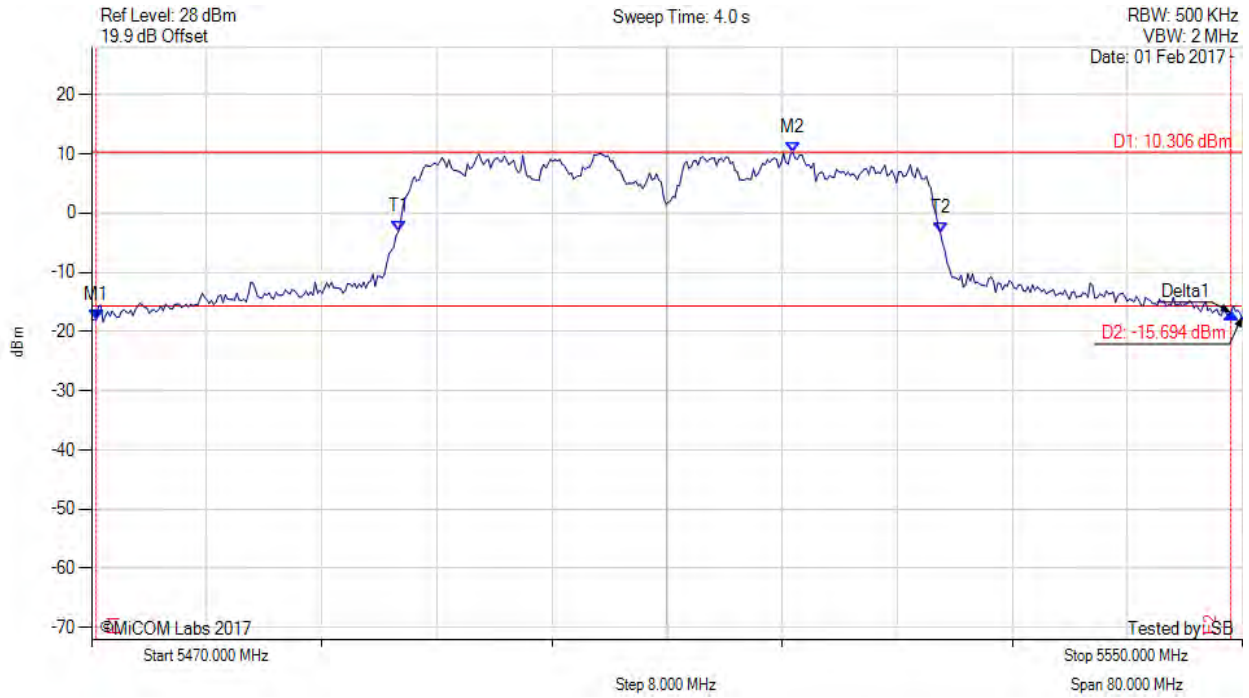

Analyzer Setup	Marker:Frequency:Amplitude	Test Results
Detector = MAX PEAK Sweep Count = 0 RF Atten (dB) = 20 Trace Mode = MAX HOLD	M1 : 5470.321 MHz : -18.097 dBm M2 : 5518.737 MHz : 10.306 dBm Delta1 : 78.878 MHz : 1.289 dB T1 : 5491.323 MHz : -3.137 dBm T2 : 5528.998 MHz : -3.277 dBm OBW : 37.675 MHz	Measured 26 dB Bandwidth: 78.878 MHz Measured 99% Bandwidth: 37.675 MHz

[back to matrix](#)

This test report may be reproduced in full only. The document may only be updated by MiCOM Labs personnel. All changes will be noted in the Document History section of the report.



26 dB & 99% BANDWIDTH



Variante: 802.11n HT-40, Channel: 5550.00 MHz, Chain a, Temp: 20, Voltage: 110 Vac

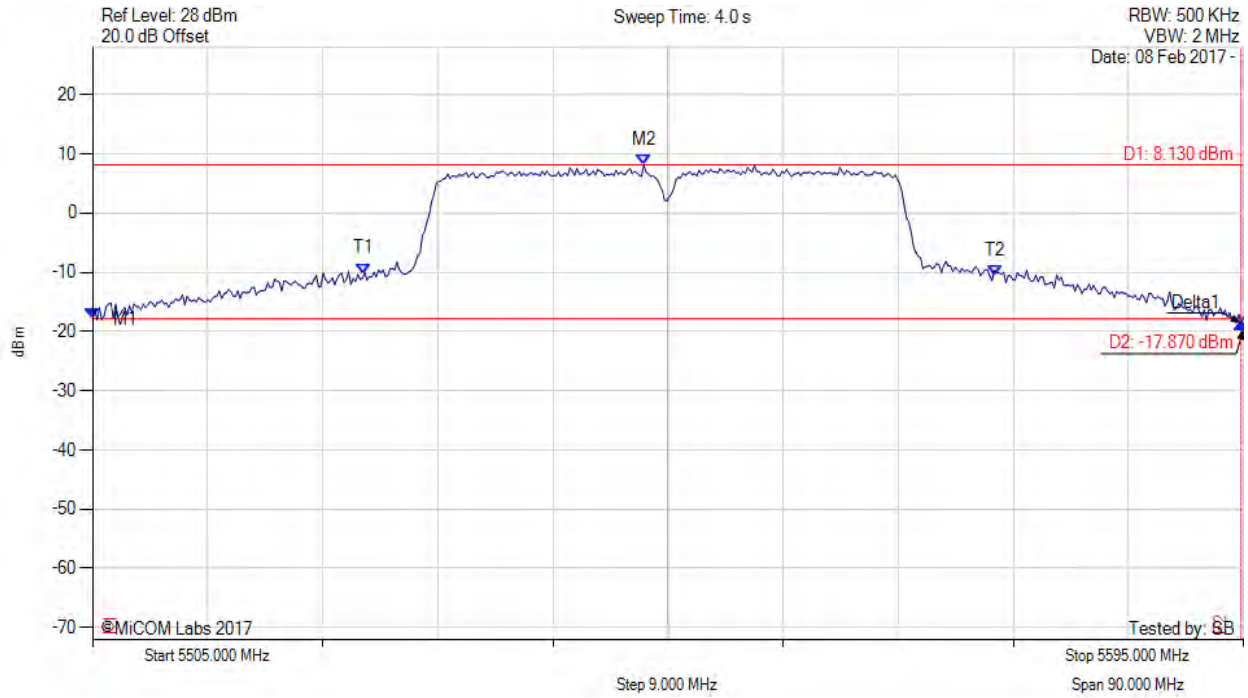

Analyzer Setup	Marker:Frequency:Amplitude	Test Results
Detector = MAX PEAK Sweep Count = 0 RF Atten (dB) = 20 Trace Mode = MAX HOLD	M1 : 5505.000 MHz : -17.808 dBm M2 : 5548.106 MHz : 8.128 dBm Delta1 : 89.820 MHz : -0.781 dB T1 : 5526.192 MHz : -10.241 dBm T2 : 5575.571 MHz : -10.668 dBm OBW : 51.944 MHz	Measured 26 dB Bandwidth: 89.820 MHz Measured 99% Bandwidth: 51.944 MHz

[back to matrix](#)

This test report may be reproduced in full only. The document may only be updated by MiCOM Labs personnel. All changes will be noted in the Document History section of the report.



26 dB & 99% BANDWIDTH

Variant: 802.11n HT-40, Channel: 5710.00 MHz, Chain a, Temp: 20, Voltage: 110 Vac

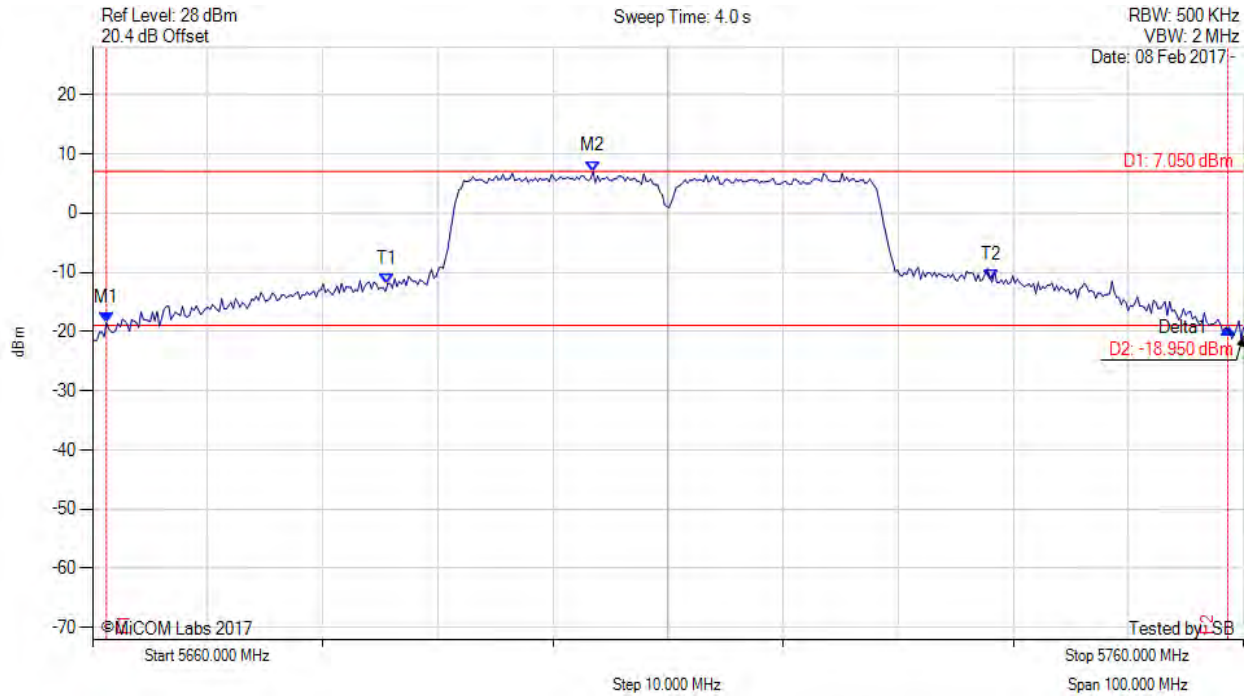

Analyzer Setup	Marker:Frequency:Amplitude	Test Results
Detector = MAX PEAK Sweep Count = 0 RF Atten (dB) = 20 Trace Mode = MAX HOLD	M1 : 5661.202 MHz : -18.485 dBm M2 : 5703.487 MHz : 7.054 dBm Delta1 : 97.455 MHz : -0.942 dB T1 : 5685.551 MHz : -12.089 dBm T2 : 5738.136 MHz : -11.325 dBm OBW : 57.715 MHz	Measured 26 dB Bandwidth: 97.455 MHz Measured 99% Bandwidth: 57.715 MHz

[back to matrix](#)

This test report may be reproduced in full only. The document may only be updated by MiCOM Labs personnel. All changes will be noted in the Document History section of the report.



## A.2. Power Spectral Density

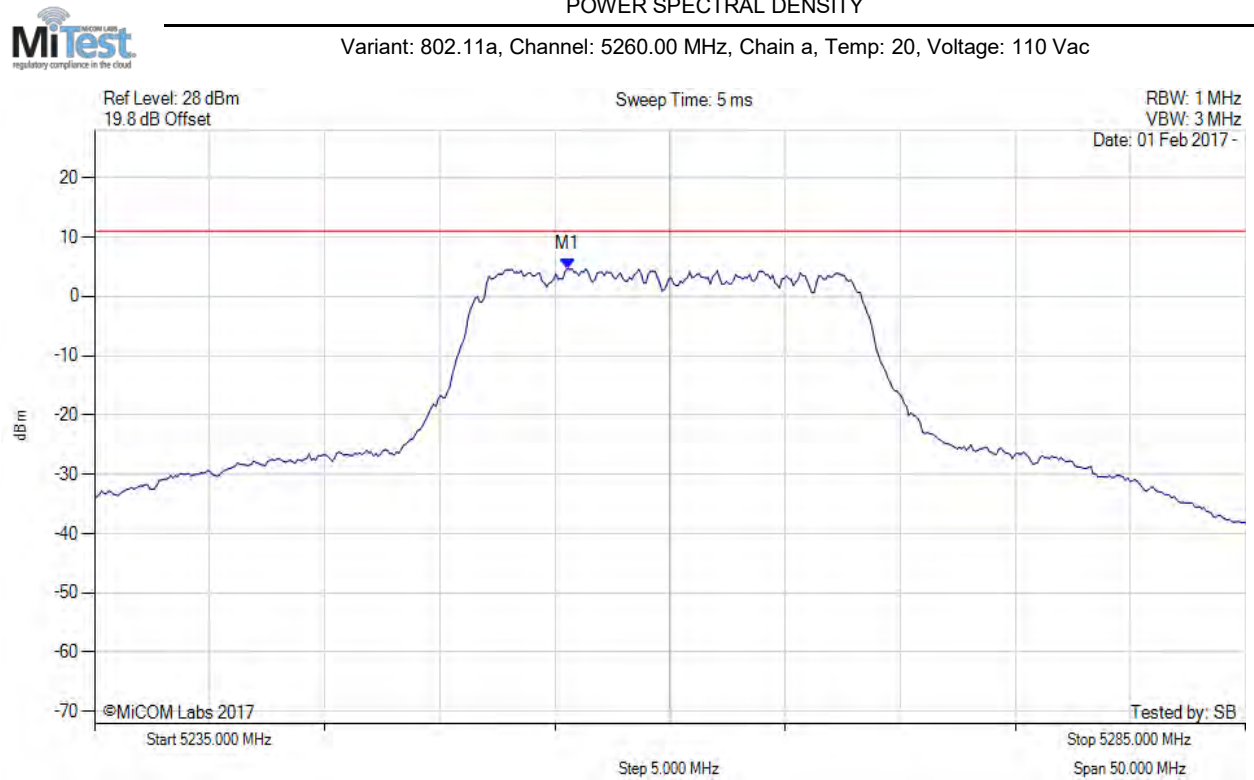

Analyzer Setup	Marker:Frequency:Amplitude	Test Results
Detector = RMS Sweep Count = 100 RF Atten (dB) = 20 Trace Mode = VIEW	M1 : 5255.541 MHz : 4.632 dBm	Limit: $\leq 11.000$ dBm

[back to matrix](#)

This test report may be reproduced in full only. The document may only be updated by MiCOM Labs personnel. All changes will be noted in the Document History section of the report.





**Title:** Hewlett Packard Enterprise APINR203 & APINP203  
**To:** FCC CFR 47 Part 15 Subpart E 15.407  
**Serial #:** HPEN96-U12 Rev A (1x1) (Conducted & Radiated Data)  
**Issue Date:** 13th June 2017  
**Page:** 92 of 147



**POWER SPECTRAL DENSITY**

Variant: 802.11a, Channel: 5260.00 MHz, SUM, Temp: 20, Voltage: 110 Vac

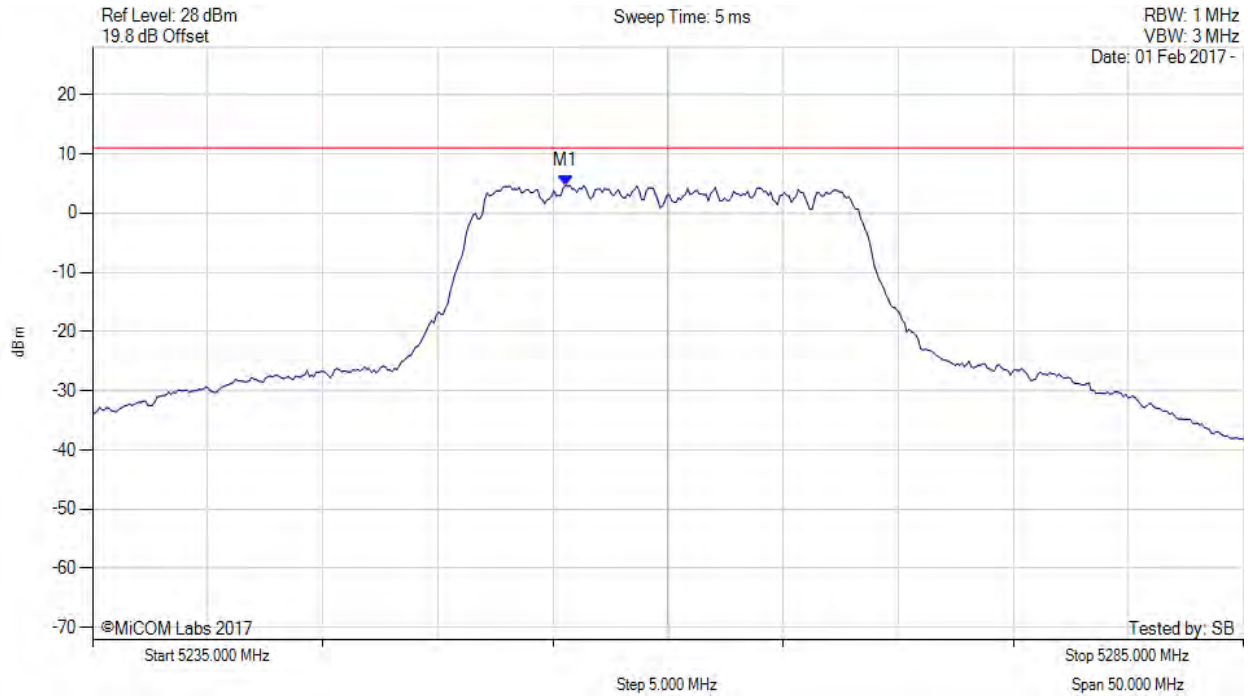

Analyzer Setup	Marker:Frequency:Amplitude	Test Results
Detector = RMS Sweep Count = 100 RF Atten (dB) = 20 Trace Mode = VIEW	M1 : 5255.500 MHz : 4.632 dBm M1 + DCCF : 5255.500 MHz : 4.676 dBm Duty Cycle Correction Factor : +0.04 dB	Limit: $\leq 11.0$ dBm Margin: -6.3 dB

[back to matrix](#)

This test report may be reproduced in full only. The document may only be updated by MiCOM Labs personnel. All changes will be noted in the Document History section of the report.



**Title:** Hewlett Packard Enterprise APINR203 & APINP203  
**To:** FCC CFR 47 Part 15 Subpart E 15.407  
**Serial #:** HPEN96-U12 Rev A (1x1) (Conducted & Radiated Data)  
**Issue Date:** 13th June 2017  
**Page:** 93 of 147

POWER SPECTRAL DENSITY



Variant: 802.11a, Channel: 5300.00 MHz, Chain a, Temp: 20, Voltage: 110 Vac

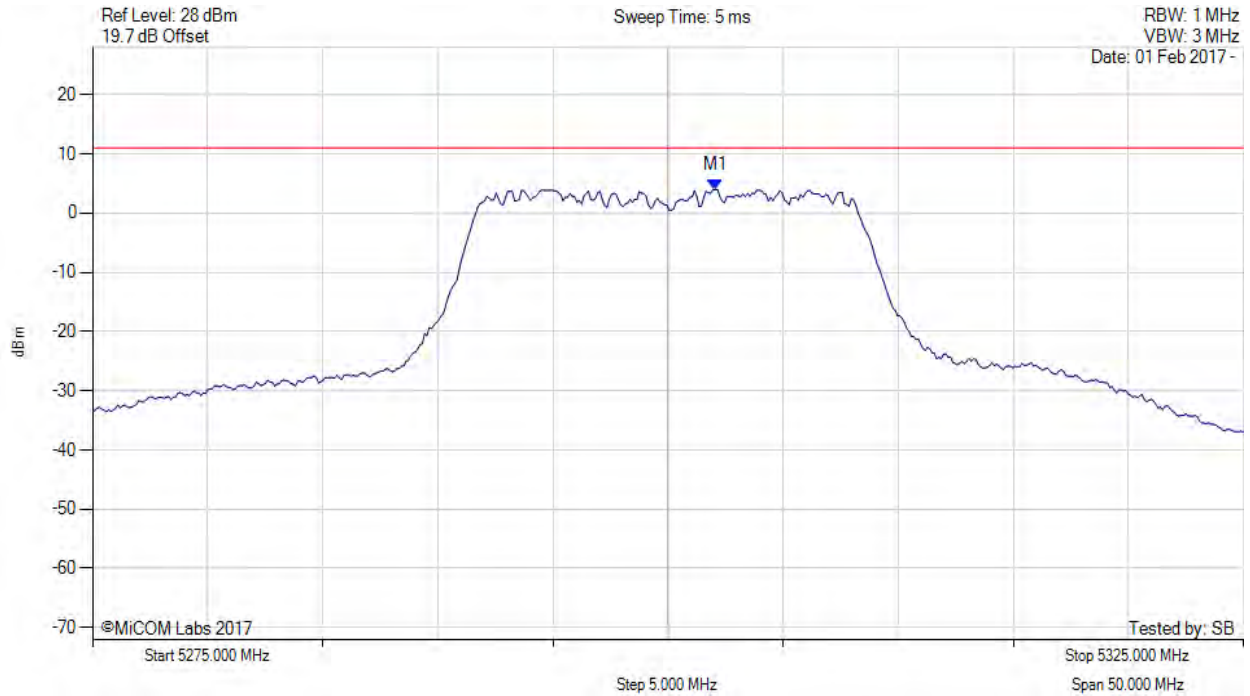

Analyzer Setup	Marker: Frequency: Amplitude	Test Results
Detector = RMS Sweep Count = 100 RF Atten (dB) = 20 Trace Mode = VIEW	M1 : 5302.054 MHz : 3.967 dBm	Limit: $\leq 11.000$ dBm

[back to matrix](#)

This test report may be reproduced in full only. The document may only be updated by MiCOM Labs personnel. All changes will be noted in the Document History section of the report.





**Title:** Hewlett Packard Enterprise APINR203 & APINP203  
**To:** FCC CFR 47 Part 15 Subpart E 15.407  
**Serial #:** HPEN96-U12 Rev A (1x1) (Conducted & Radiated Data)  
**Issue Date:** 13th June 2017  
**Page:** 94 of 147

POWER SPECTRAL DENSITY



Variant: 802.11a, Channel: 5300.00 MHz, SUM, Temp: 20, Voltage: 110 Vac

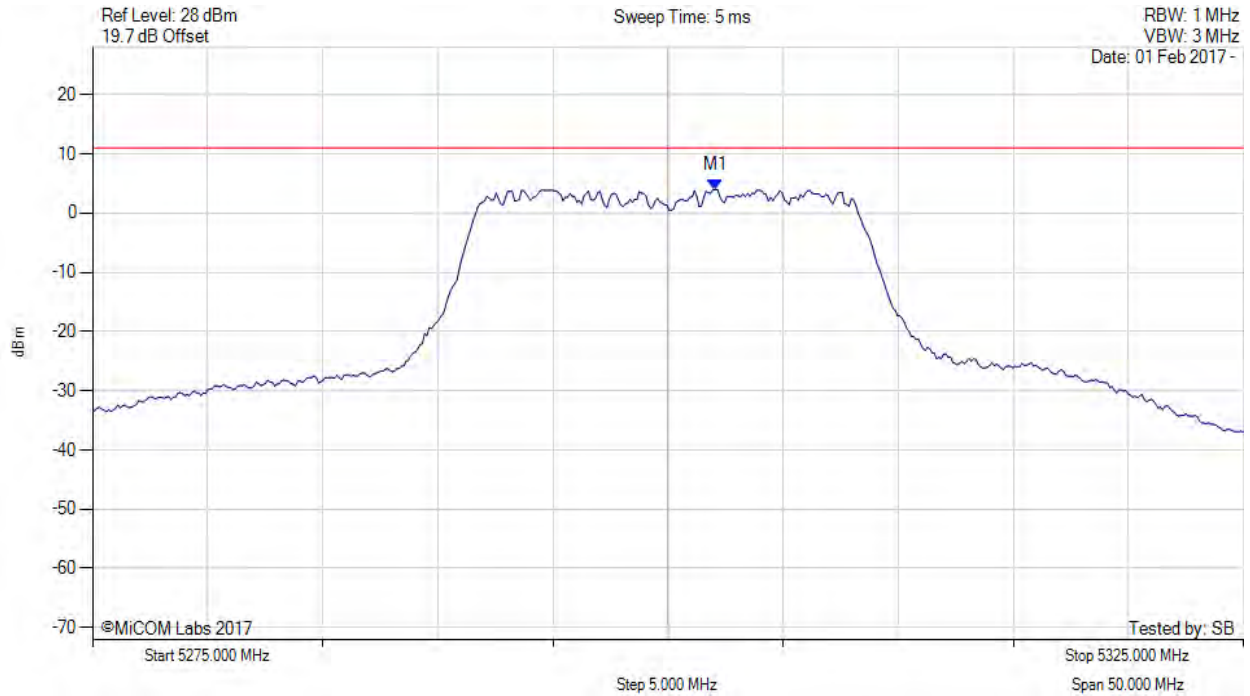

Analyzer Setup	Marker:Frequency:Amplitude	Test Results
Detector = RMS Sweep Count = 100 RF Atten (dB) = 20 Trace Mode = VIEW	M1 : 5302.100 MHz : 3.967 dBm M1 + DCCF : 5302.100 MHz : 4.011 dBm Duty Cycle Correction Factor : +0.04 dB	Limit: $\leq 11.0$ dBm Margin: -7.0 dB

[back to matrix](#)

This test report may be reproduced in full only. The document may only be updated by MiCOM Labs personnel. All changes will be noted in the Document History section of the report.



**Title:** Hewlett Packard Enterprise APINR203 & APINP203  
**To:** FCC CFR 47 Part 15 Subpart E 15.407  
**Serial #:** HPEN96-U12 Rev A (1x1) (Conducted & Radiated Data)  
**Issue Date:** 13th June 2017  
**Page:** 95 of 147

POWER SPECTRAL DENSITY



Variant: 802.11a, Channel: 5320.00 MHz, Chain a, Temp: 20, Voltage: 110 Vac

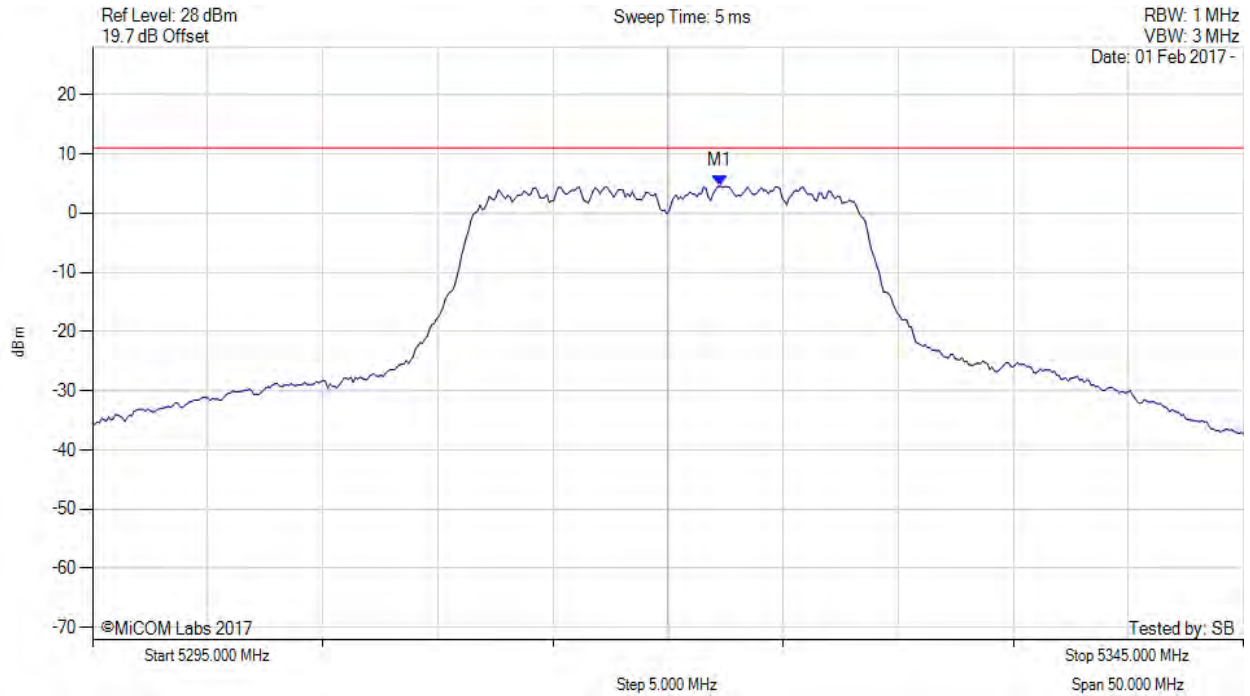

Analyzer Setup	Marker: Frequency: Amplitude	Test Results
Detector = RMS Sweep Count = 100 RF Atten (dB) = 20 Trace Mode = VIEWS	M1 : 5322.255 MHz : 4.560 dBm	Limit: $\leq 11.000$ dBm

[back to matrix](#)

This test report may be reproduced in full only. The document may only be updated by MiCOM Labs personnel. All changes will be noted in the Document History section of the report.



**Title:** Hewlett Packard Enterprise APINR203 & APINP203  
**To:** FCC CFR 47 Part 15 Subpart E 15.407  
**Serial #:** HPEN96-U12 Rev A (1x1) (Conducted & Radiated Data)  
**Issue Date:** 13th June 2017  
**Page:** 96 of 147



POWER SPECTRAL DENSITY

Variant: 802.11a, Channel: 5320.00 MHz, SUM, Temp: 20, Voltage: 110 Vac

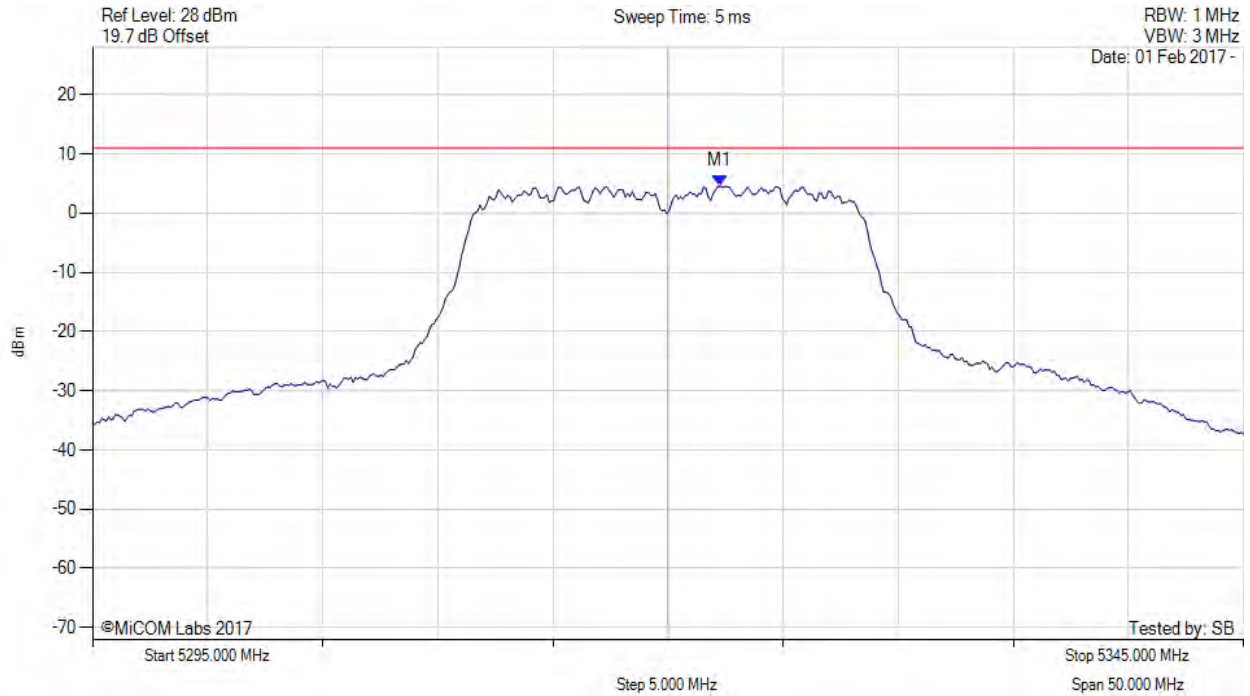

Analyzer Setup	Marker:Frequency:Amplitude	Test Results
Detector = RMS Sweep Count = 100 RF Atten (dB) = 20 Trace Mode = VIEW	M1 : 5322.300 MHz : 4.560 dBm M1 + DCCF : 5322.300 MHz : 4.604 dBm Duty Cycle Correction Factor : +0.04 dB	Limit: $\leq 11.0$ dBm Margin: -6.4 dB

[back to matrix](#)

This test report may be reproduced in full only. The document may only be updated by MiCOM Labs personnel. All changes will be noted in the Document History section of the report.



**Title:** Hewlett Packard Enterprise APINR203 & APINP203  
**To:** FCC CFR 47 Part 15 Subpart E 15.407  
**Serial #:** HPEN96-U12 Rev A (1x1) (Conducted & Radiated Data)  
**Issue Date:** 13th June 2017  
**Page:** 97 of 147

POWER SPECTRAL DENSITY



Variant: 802.11ac-80, Channel: 5290.00 MHz, Chain a, Temp: 20, Voltage: 110 Vac

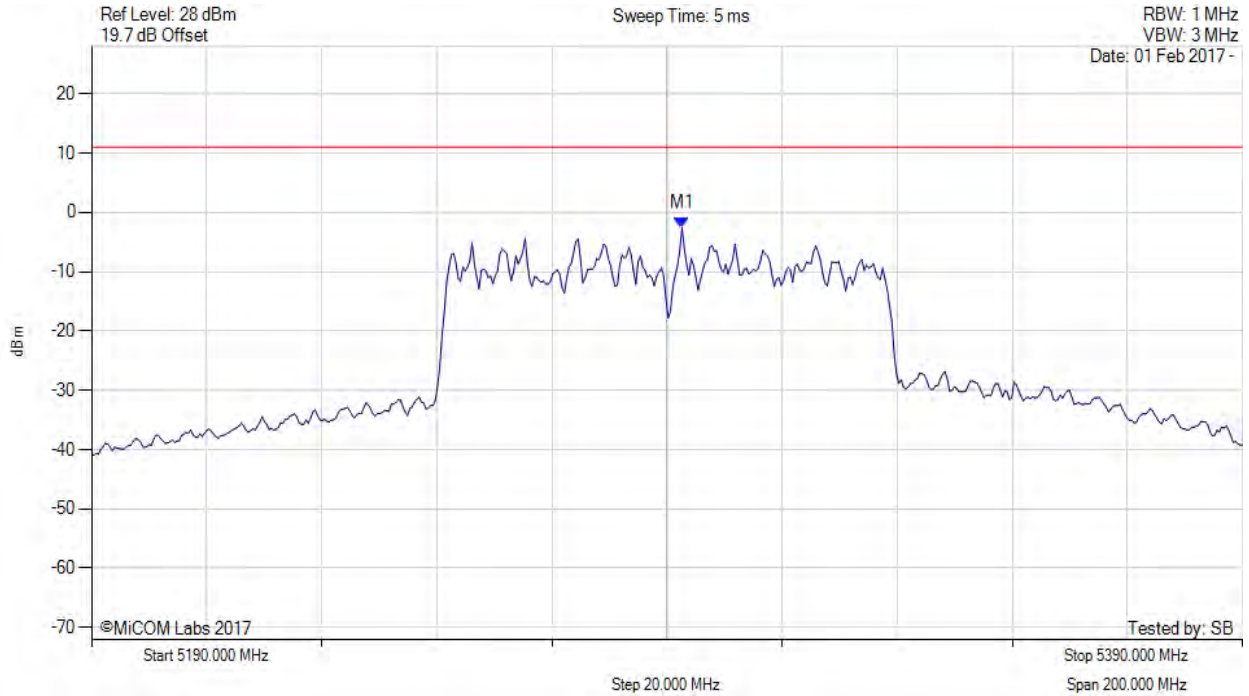

Analyzer Setup	Marker:Frequency:Amplitude	Test Results
Detector = RMS Sweep Count = 100 RF Atten (dB) = 20 Trace Mode = VIEW	M1 : 5292.605 MHz : -2.656 dBm	Limit: $\leq 11.000$ dBm

[back to matrix](#)

This test report may be reproduced in full only. The document may only be updated by MiCOM Labs personnel. All changes will be noted in the Document History section of the report.



POWER SPECTRAL DENSITY



Variant: 802.11ac-80, Channel: 5290.00 MHz, SUM, Temp: 20, Voltage: 110 Vac

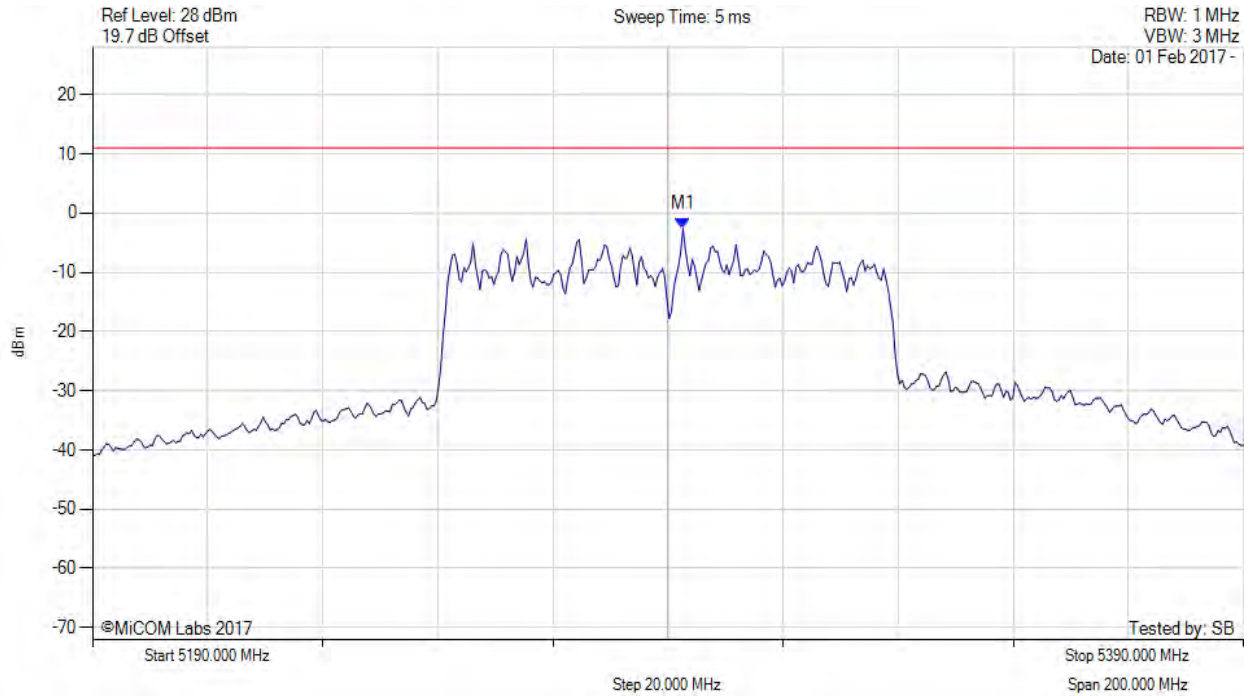

Analyzer Setup	Marker:Frequency:Amplitude	Test Results
Detector = RMS Sweep Count = 100 RF Atten (dB) = 20 Trace Mode = VIEWS	M1 : 5292.600 MHz : -2.656 dBm M1 + DCCF : 5292.600 MHz : -1.687 dBm Duty Cycle Correction Factor : +0.97 dB	Limit: $\leq 11.0$ dBm Margin: -12.7 dB

[back to matrix](#)

This test report may be reproduced in full only. The document may only be updated by MiCOM Labs personnel. All changes will be noted in the Document History section of the report.



**Title:** Hewlett Packard Enterprise APINR203 & APINP203  
**To:** FCC CFR 47 Part 15 Subpart E 15.407  
**Serial #:** HPEN96-U12 Rev A (1x1) (Conducted & Radiated Data)  
**Issue Date:** 13th June 2017  
**Page:** 99 of 147

POWER SPECTRAL DENSITY



Variant: 802.11n HT-20, Channel: 5260.00 MHz, Chain a, Temp: 20, Voltage: 110 Vac

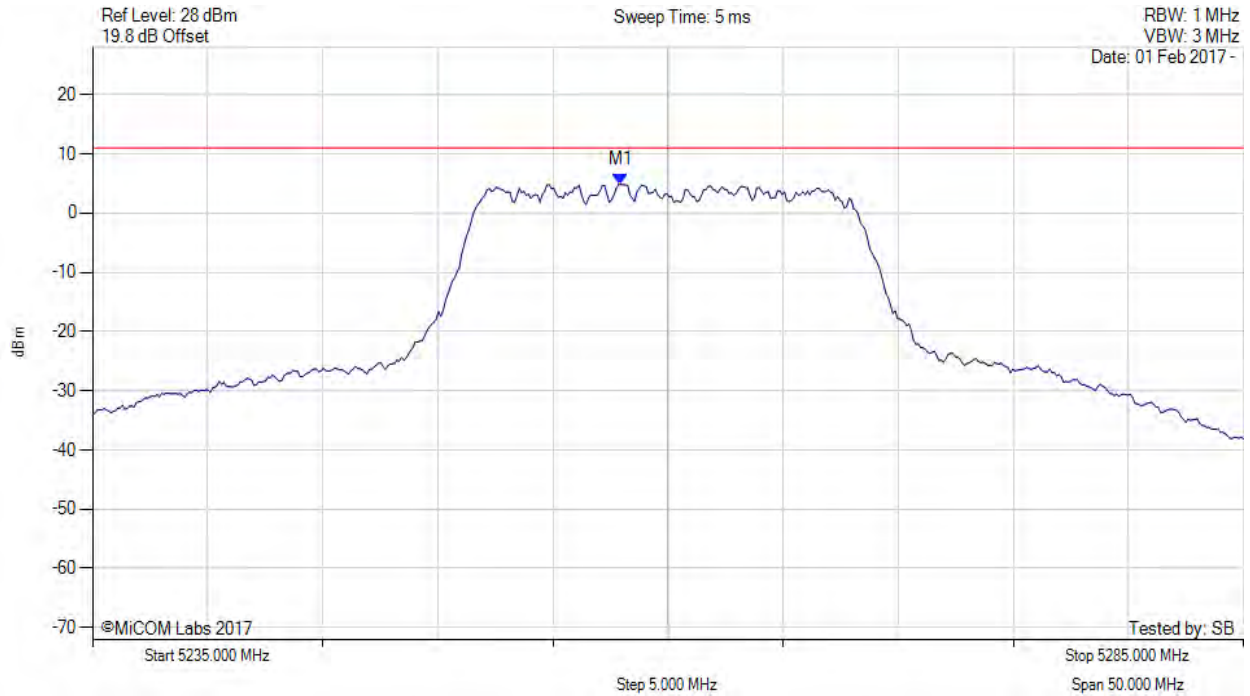

Analyzer Setup	Marker:Frequency:Amplitude	Test Results
Detector = RMS Sweep Count = 100 RF Atten (dB) = 20 Trace Mode = VIEWS	M1 : 5257.946 MHz : 4.855 dBm	Limit: $\leq 11.000$ dBm

[back to matrix](#)

This test report may be reproduced in full only. The document may only be updated by MiCOM Labs personnel. All changes will be noted in the Document History section of the report.



**Title:** Hewlett Packard Enterprise APINR203 & APINP203  
**To:** FCC CFR 47 Part 15 Subpart E 15.407  
**Serial #:** HPEN96-U12 Rev A (1x1) (Conducted & Radiated Data)  
**Issue Date:** 13th June 2017  
**Page:** 100 of 147

POWER SPECTRAL DENSITY



Variant: 802.11n HT-20, Channel: 5260.00 MHz, SUM, Temp: 20, Voltage: 110 Vac

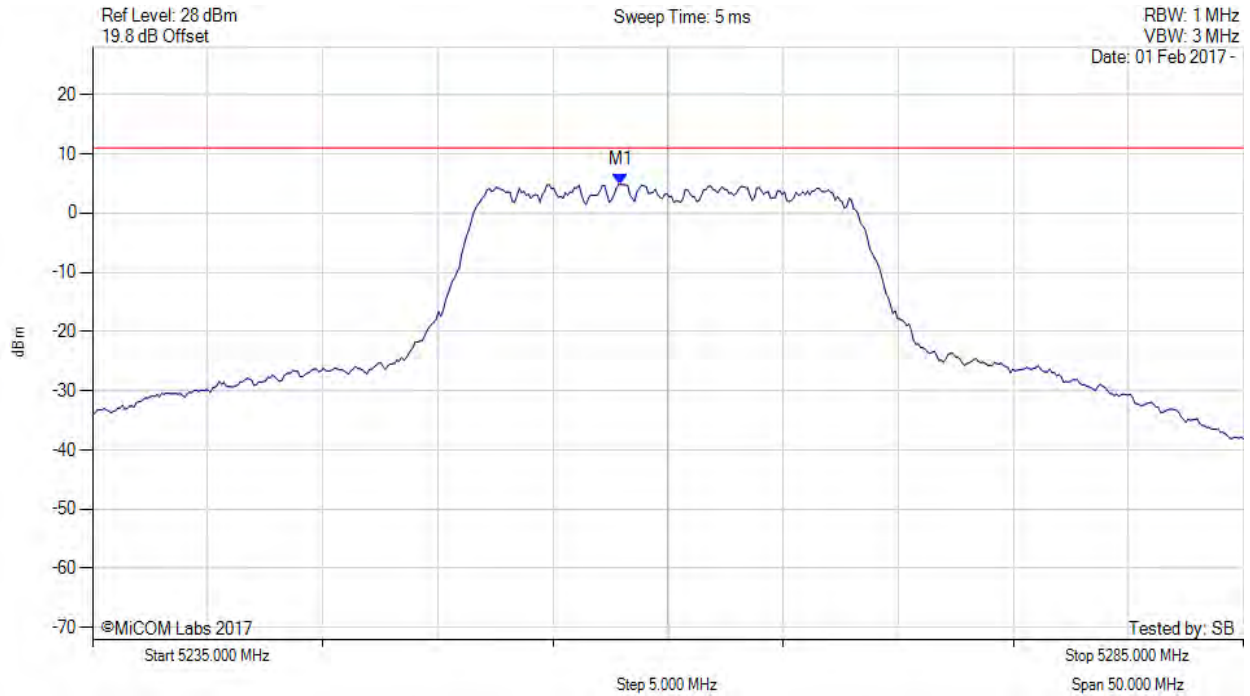

Analyzer Setup	Marker:Frequency:Amplitude	Test Results
Detector = RMS Sweep Count = 100 RF Atten (dB) = 20 Trace Mode = VIEW	M1 : 5257.900 MHz : 4.855 dBm M1 + DCCF : 5257.900 MHz : 4.899 dBm Duty Cycle Correction Factor : +0.04 dB	Limit: $\leq 11.0$ dBm Margin: -6.1 dB

[back to matrix](#)

This test report may be reproduced in full only. The document may only be updated by MiCOM Labs personnel. All changes will be noted in the Document History section of the report.





**Title:** Hewlett Packard Enterprise APINR203 & APINP203  
**To:** FCC CFR 47 Part 15 Subpart E 15.407  
**Serial #:** HPEN96-U12 Rev A (1x1) (Conducted & Radiated Data)  
**Issue Date:** 13th June 2017  
**Page:** 101 of 147

POWER SPECTRAL DENSITY



Variant: 802.11n HT-20, Channel: 5300.00 MHz, Chain a, Temp: 20, Voltage: 110 Vac

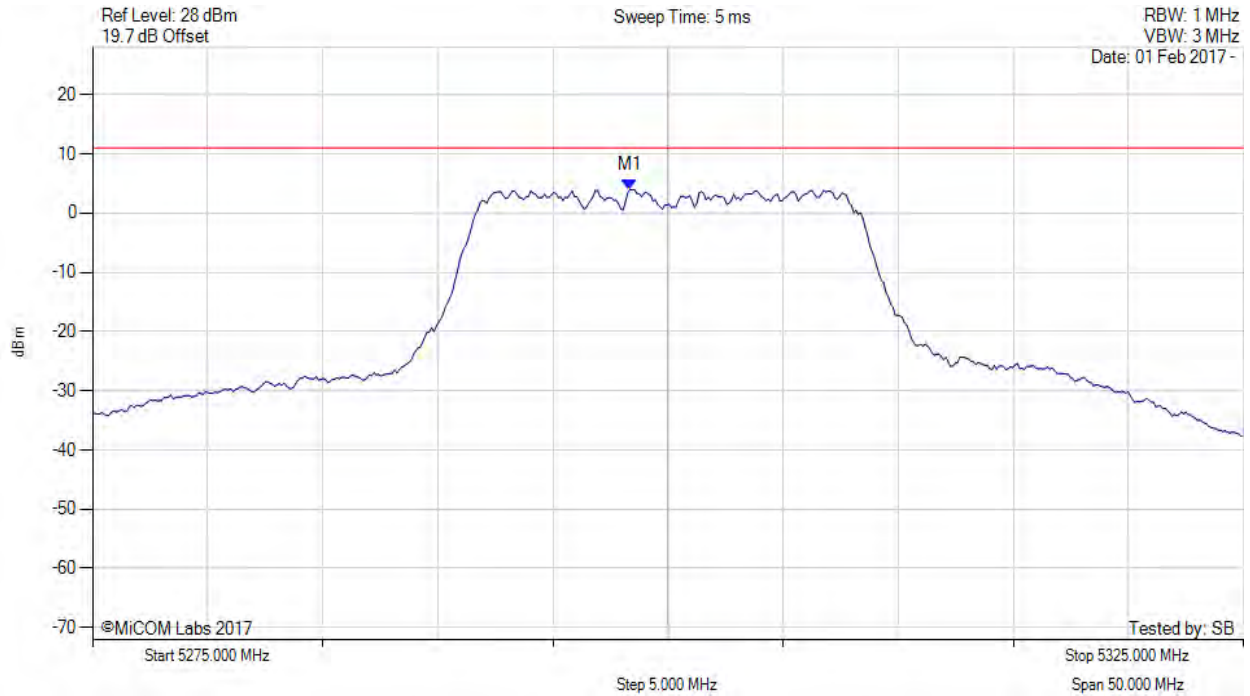

Analyzer Setup	Marker:Frequency:Amplitude	Test Results
Detector = RMS Sweep Count = 100 RF Atten (dB) = 20 Trace Mode = VIEWS	M1 : 5298.347 MHz : 3.990 dBm	Limit: $\leq 11.000$ dBm

[back to matrix](#)

This test report may be reproduced in full only. The document may only be updated by MiCOM Labs personnel. All changes will be noted in the Document History section of the report.





**Title:** Hewlett Packard Enterprise APINR203 & APINP203  
**To:** FCC CFR 47 Part 15 Subpart E 15.407  
**Serial #:** HPEN96-U12 Rev A (1x1) (Conducted & Radiated Data)  
**Issue Date:** 13th June 2017  
**Page:** 102 of 147

POWER SPECTRAL DENSITY



Variant: 802.11n HT-20, Channel: 5300.00 MHz, SUM, Temp: 20, Voltage: 110 Vac

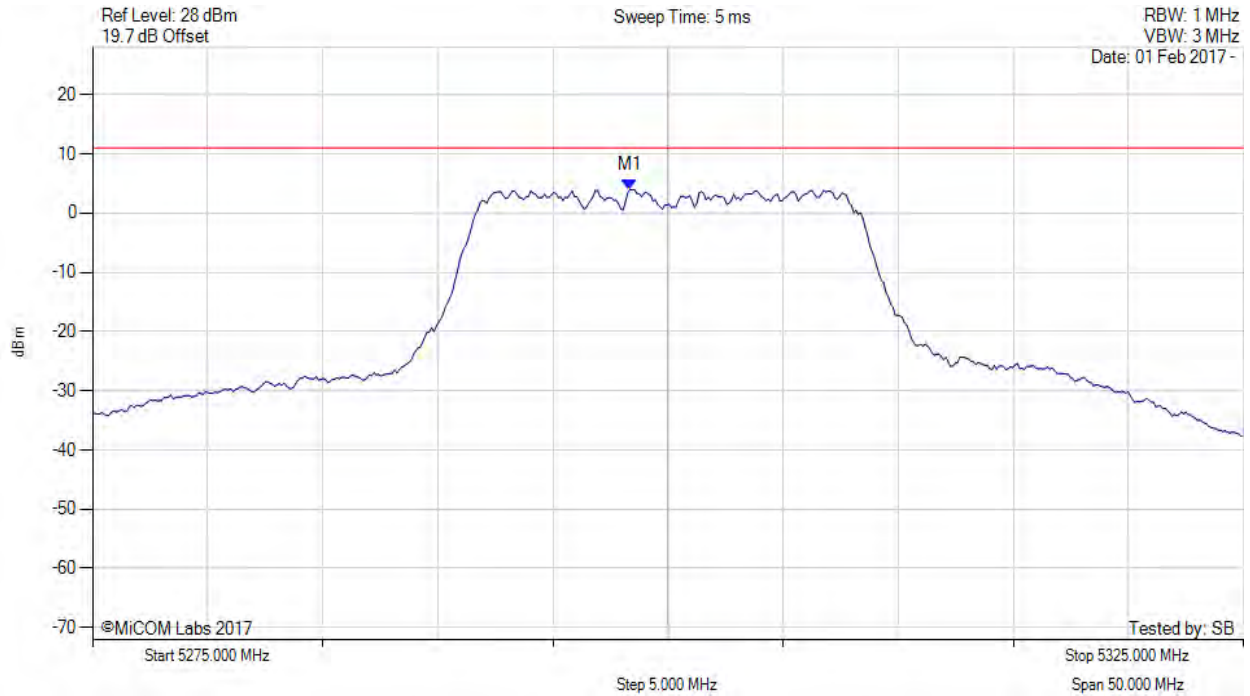

Analyzer Setup	Marker:Frequency:Amplitude	Test Results
Detector = RMS Sweep Count = 100 RF Atten (dB) = 20 Trace Mode = VIEW	M1 : 5298.300 MHz : 3.990 dBm M1 + DCCF : 5298.300 MHz : 4.034 dBm Duty Cycle Correction Factor : +0.04 dB	Limit: $\leq 11.0$ dBm Margin: $-7.0$ dB

[back to matrix](#)

This test report may be reproduced in full only. The document may only be updated by MiCOM Labs personnel. All changes will be noted in the Document History section of the report.



**Title:** Hewlett Packard Enterprise APINR203 & APINP203  
**To:** FCC CFR 47 Part 15 Subpart E 15.407  
**Serial #:** HPEN96-U12 Rev A (1x1) (Conducted & Radiated Data)  
**Issue Date:** 13th June 2017  
**Page:** 103 of 147

POWER SPECTRAL DENSITY



Variant: 802.11n HT-20, Channel: 5320.00 MHz, Chain a, Temp: 20, Voltage: 110 Vac

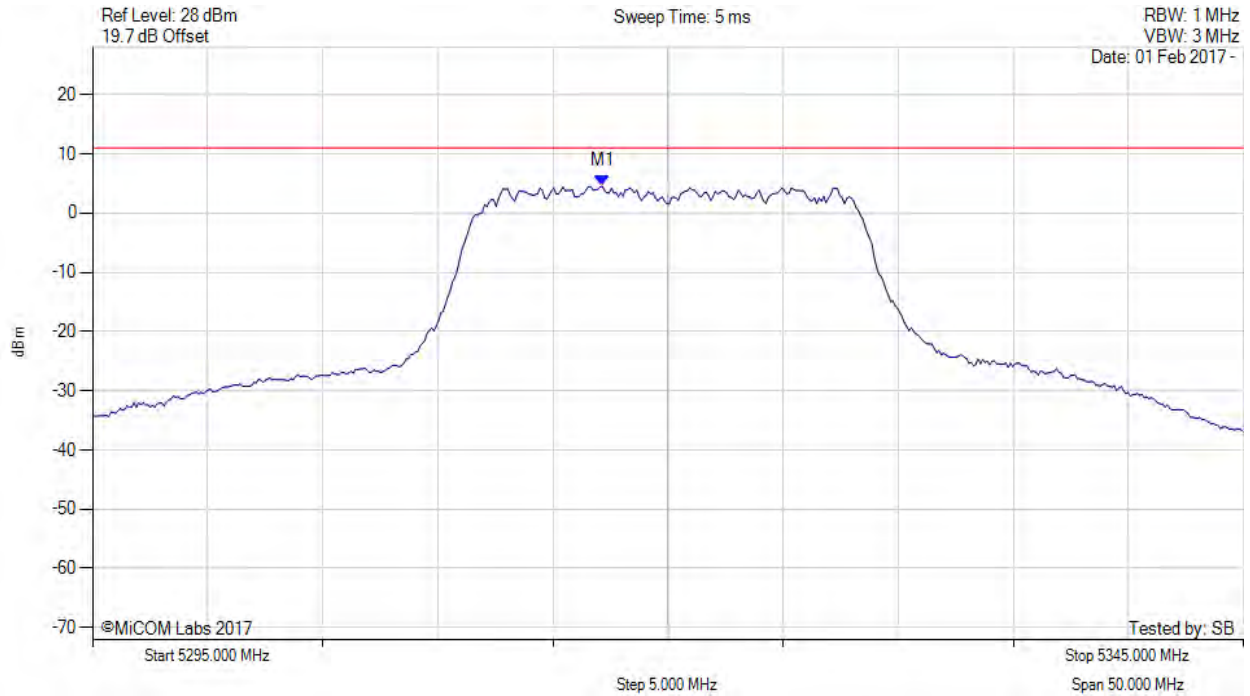

Analyzer Setup	Marker:Frequency:Amplitude	Test Results
Detector = RMS Sweep Count = 100 RF Atten (dB) = 20 Trace Mode = VIEWS	M1 : 5317.144 MHz : 4.519 dBm	Limit: $\leq 11.000$ dBm

[back to matrix](#)

This test report may be reproduced in full only. The document may only be updated by MiCOM Labs personnel. All changes will be noted in the Document History section of the report.



**Title:** Hewlett Packard Enterprise APINR203 & APINP203  
**To:** FCC CFR 47 Part 15 Subpart E 15.407  
**Serial #:** HPEN96-U12 Rev A (1x1) (Conducted & Radiated Data)  
**Issue Date:** 13th June 2017  
**Page:** 104 of 147

POWER SPECTRAL DENSITY



Variant: 802.11n HT-20, Channel: 5320.00 MHz, SUM, Temp: 20, Voltage: 110 Vac

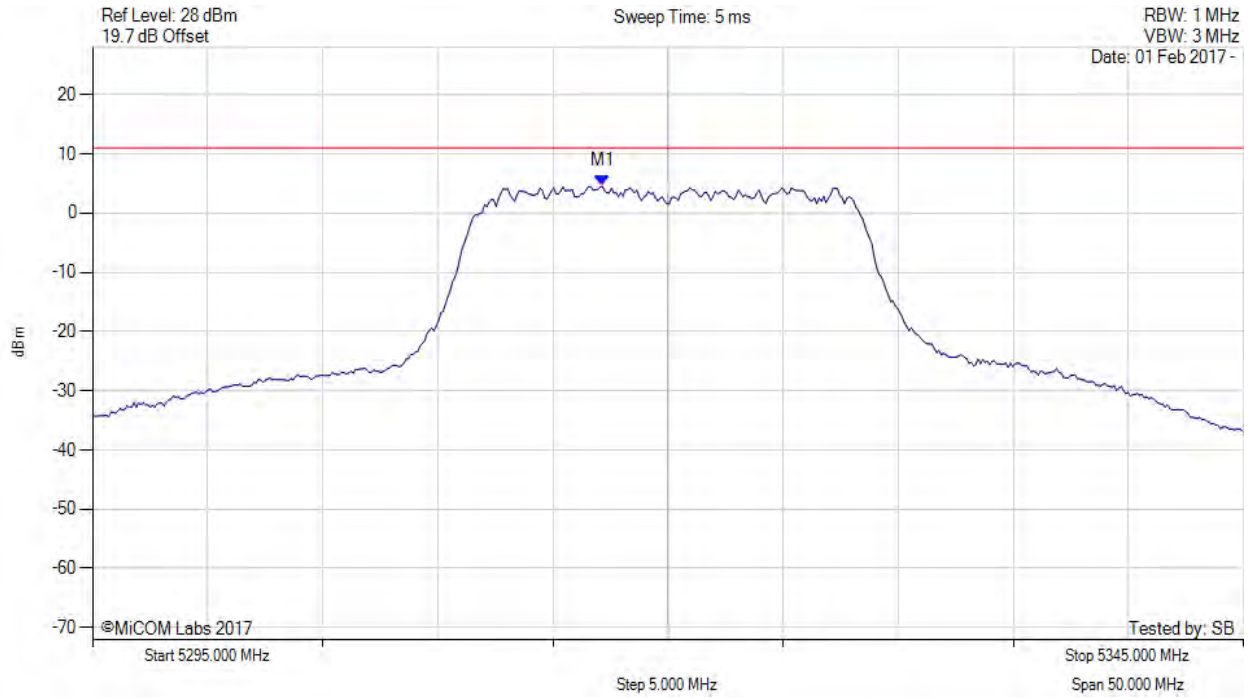

Analyzer Setup	Marker:Frequency:Amplitude	Test Results
Detector = RMS Sweep Count = 100 RF Atten (dB) = 20 Trace Mode = VIEW	M1 : 5317.100 MHz : 4.519 dBm M1 + DCCF : 5317.100 MHz : 4.563 dBm Duty Cycle Correction Factor : +0.04 dB	Limit: $\leq 11.0$ dBm Margin: -6.4 dB

[back to matrix](#)

This test report may be reproduced in full only. The document may only be updated by MiCOM Labs personnel. All changes will be noted in the Document History section of the report.



**Title:** Hewlett Packard Enterprise APINR203 & APINP203  
**To:** FCC CFR 47 Part 15 Subpart E 15.407  
**Serial #:** HPEN96-U12 Rev A (1x1) (Conducted & Radiated Data)  
**Issue Date:** 13th June 2017  
**Page:** 105 of 147

POWER SPECTRAL DENSITY



Variant: 802.11n HT-40, Channel: 5270.00 MHz, Chain a, Temp: 20, Voltage: 110 Vac

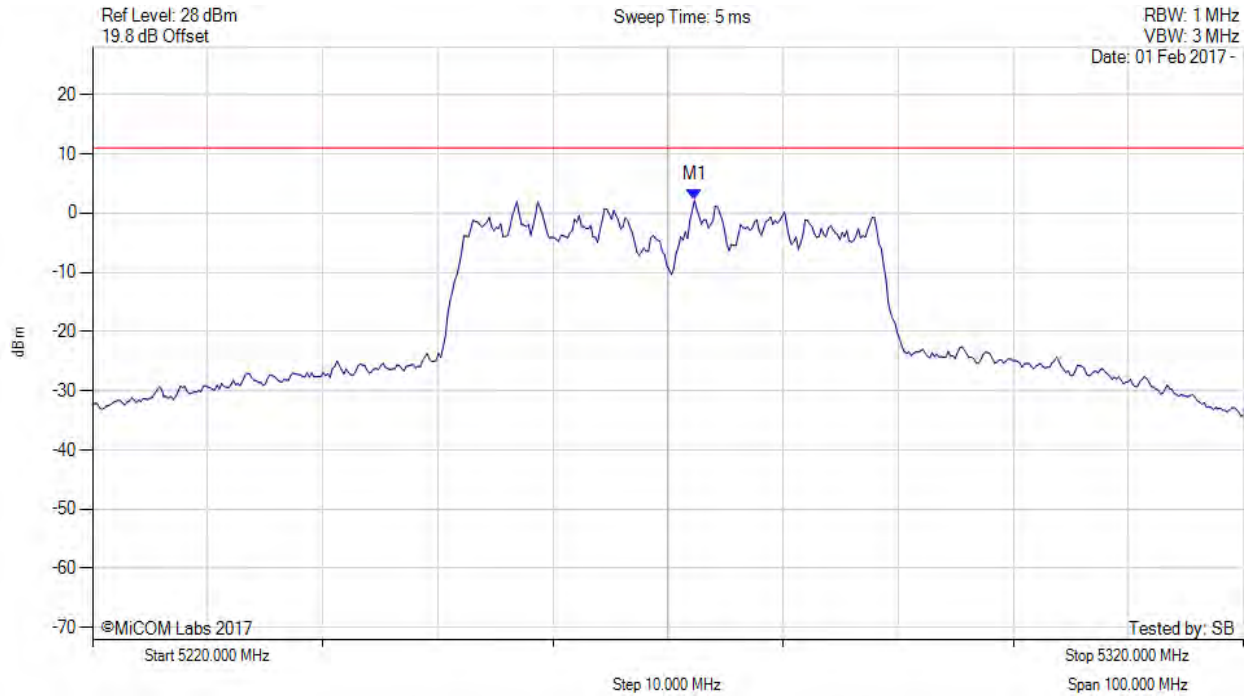

Analyzer Setup	Marker:Frequency:Amplitude	Test Results
Detector = RMS Sweep Count = 100 RF Atten (dB) = 20 Trace Mode = VIEWS	M1 : 5272.305 MHz : 2.215 dBm	Limit: $\leq 11.000$ dBm

[back to matrix](#)

This test report may be reproduced in full only. The document may only be updated by MiCOM Labs personnel. All changes will be noted in the Document History section of the report.



**Title:** Hewlett Packard Enterprise APINR203 & APINP203  
**To:** FCC CFR 47 Part 15 Subpart E 15.407  
**Serial #:** HPEN96-U12 Rev A (1x1) (Conducted & Radiated Data)  
**Issue Date:** 13th June 2017  
**Page:** 106 of 147

POWER SPECTRAL DENSITY



Variant: 802.11n HT-40, Channel: 5270.00 MHz, SUM, Temp: 20, Voltage: 110 Vac

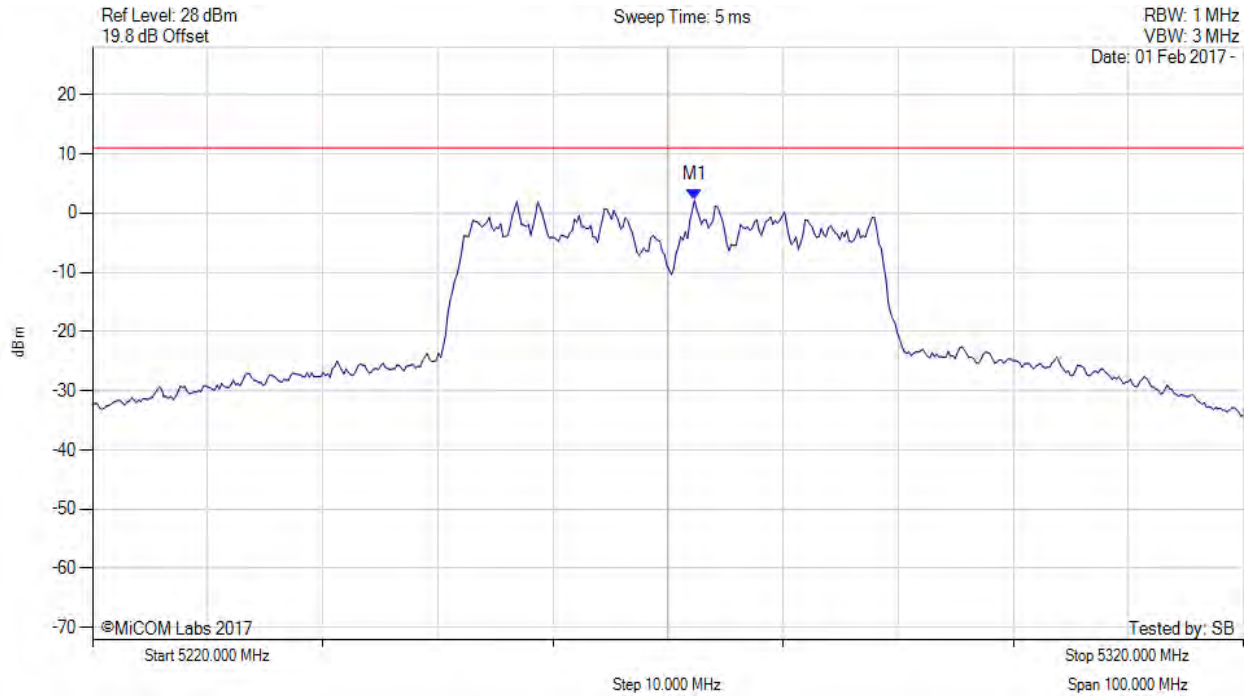

Analyzer Setup	Marker:Frequency:Amplitude	Test Results
Detector = RMS Sweep Count = 100 RF Atten (dB) = 20 Trace Mode = VIEW	M1 : 5272.300 MHz : 2.215 dBm M1 + DCCF : 5272.300 MHz : 2.683 dBm Duty Cycle Correction Factor : +0.46 dB	Limit: $\leq 11.0$ dBm Margin: -8.3 dB

[back to matrix](#)

This test report may be reproduced in full only. The document may only be updated by MiCOM Labs personnel. All changes will be noted in the Document History section of the report.



**Title:** Hewlett Packard Enterprise APINR203 & APINP203  
**To:** FCC CFR 47 Part 15 Subpart E 15.407  
**Serial #:** HPEN96-U12 Rev A (1x1) (Conducted & Radiated Data)  
**Issue Date:** 13th June 2017  
**Page:** 107 of 147

POWER SPECTRAL DENSITY



Variant: 802.11n HT-40, Channel: 5310.00 MHz, Chain a, Temp: 20, Voltage: 110 Vac

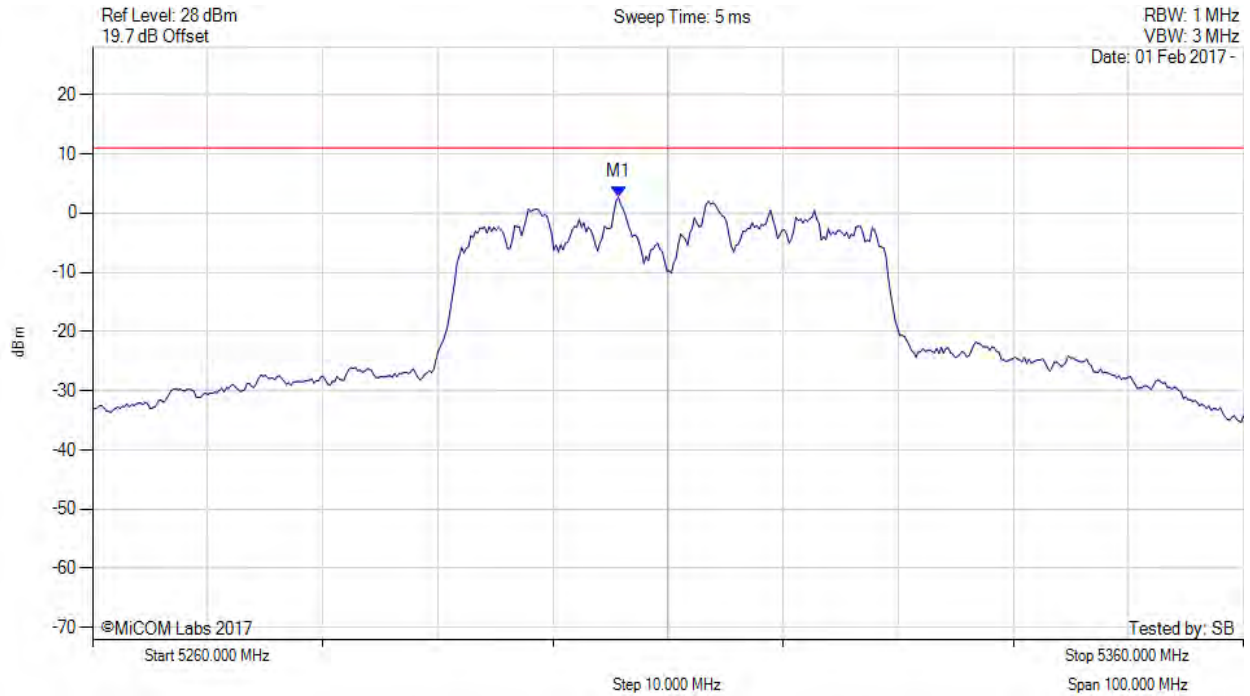

Analyzer Setup	Marker:Frequency:Amplitude	Test Results
Detector = RMS Sweep Count = 100 RF Atten (dB) = 20 Trace Mode = VIEWS	M1 : 5305.691 MHz : 2.724 dBm	Limit: $\leq 11.000$ dBm

[back to matrix](#)

This test report may be reproduced in full only. The document may only be updated by MiCOM Labs personnel. All changes will be noted in the Document History section of the report.



**Title:** Hewlett Packard Enterprise APINR203 & APINP203  
**To:** FCC CFR 47 Part 15 Subpart E 15.407  
**Serial #:** HPEN96-U12 Rev A (1x1) (Conducted & Radiated Data)  
**Issue Date:** 13th June 2017  
**Page:** 108 of 147

POWER SPECTRAL DENSITY



Variant: 802.11n HT-40, Channel: 5310.00 MHz, SUM, Temp: 20, Voltage: 110 Vac

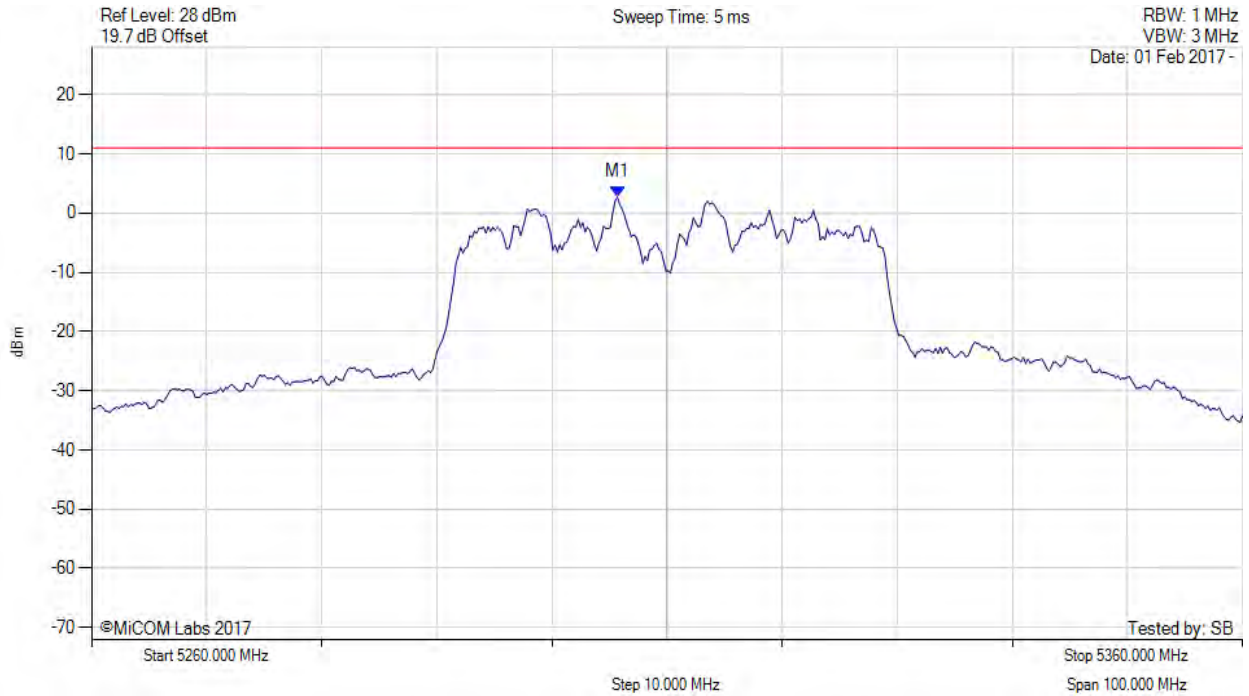

Analyzer Setup	Marker:Frequency:Amplitude	Test Results
Detector = RMS Sweep Count = 100 RF Atten (dB) = 20 Trace Mode = VIEW	M1 : 5305.700 MHz : 2.724 dBm M1 + DCCF : 5305.700 MHz : 3.192 dBm Duty Cycle Correction Factor : +0.46 dB	Limit: $\leq 11.0$ dBm Margin: -7.8 dB

[back to matrix](#)

This test report may be reproduced in full only. The document may only be updated by MiCOM Labs personnel. All changes will be noted in the Document History section of the report.





**Title:** Hewlett Packard Enterprise APINR203 & APINP203  
**To:** FCC CFR 47 Part 15 Subpart E 15.407  
**Serial #:** HPEN96-U12 Rev A (1x1) (Conducted & Radiated Data)  
**Issue Date:** 13th June 2017  
**Page:** 109 of 147

POWER SPECTRAL DENSITY



Variant: 802.11a, Channel: 5500.00 MHz, Chain a, Temp: 20, Voltage: 110 Vac

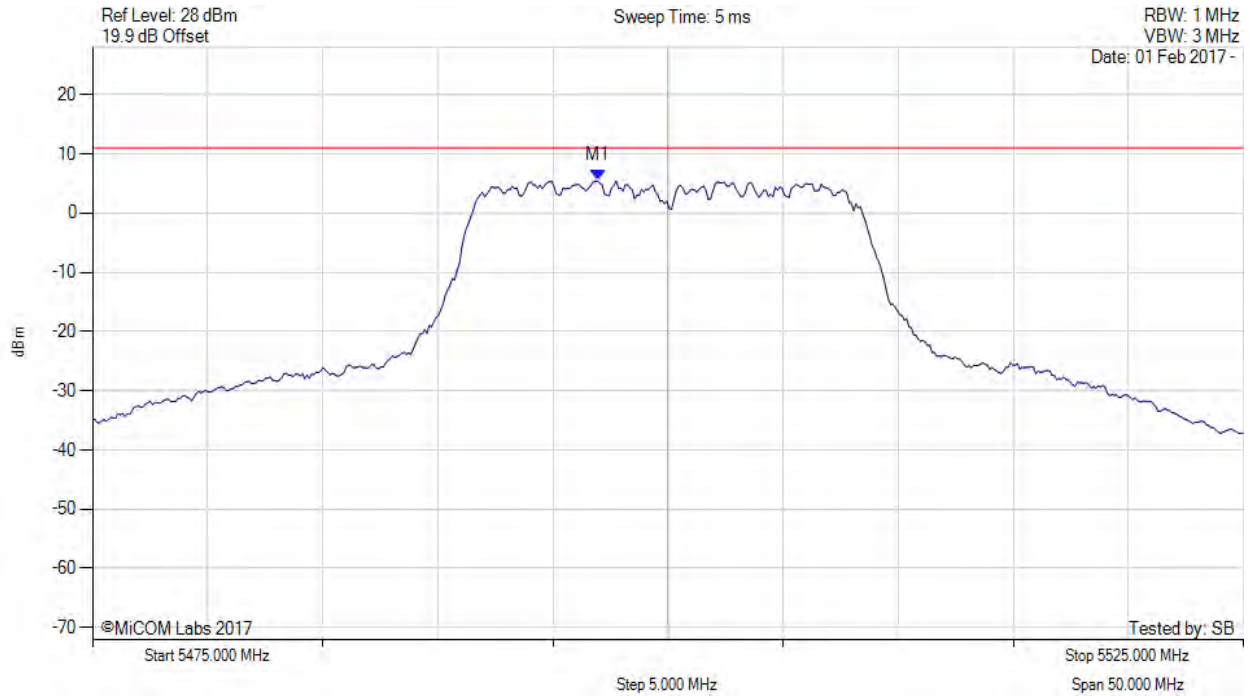

Analyzer Setup	Marker:Frequency:Amplitude	Test Results
Detector = RMS Sweep Count = 100 RF Atten (dB) = 20 Trace Mode = VIEWS	M1 : 5496.944 MHz : 5.481 dBm	Limit: $\leq 11.000$ dBm

[back to matrix](#)

This test report may be reproduced in full only. The document may only be updated by MiCOM Labs personnel. All changes will be noted in the Document History section of the report.





**Title:** Hewlett Packard Enterprise APINR203 & APINP203  
**To:** FCC CFR 47 Part 15 Subpart E 15.407  
**Serial #:** HPEN96-U12 Rev A (1x1) (Conducted & Radiated Data)  
**Issue Date:** 13th June 2017  
**Page:** 110 of 147

POWER SPECTRAL DENSITY



Variant: 802.11a, Channel: 5500.00 MHz, SUM, Temp: 20, Voltage: 110 Vac

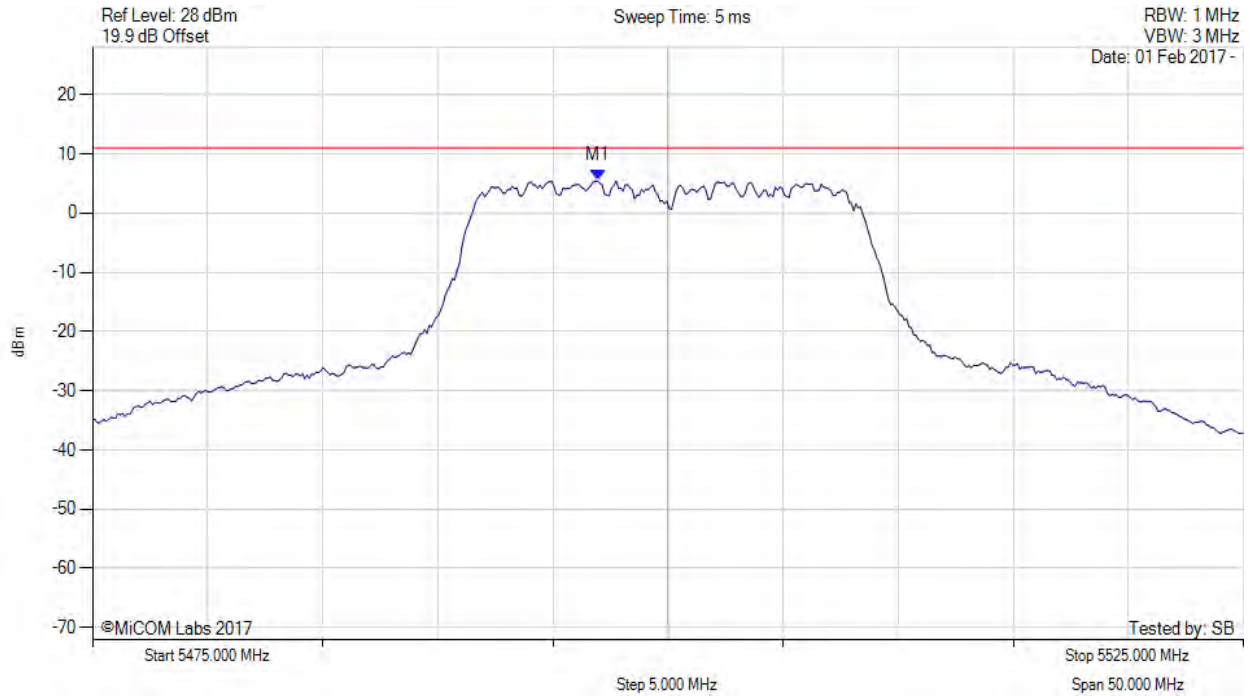

Analyzer Setup	Marker:Frequency:Amplitude	Test Results
Detector = RMS Sweep Count = 100 RF Atten (dB) = 20 Trace Mode = VIEW	M1 : 5496.900 MHz : 5.481 dBm M1 + DCCF : 5496.900 MHz : 5.525 dBm Duty Cycle Correction Factor : +0.04 dB	Limit: $\leq 11.0$ dBm Margin: -5.5 dB

[back to matrix](#)

This test report may be reproduced in full only. The document may only be updated by MiCOM Labs personnel. All changes will be noted in the Document History section of the report.



**Title:** Hewlett Packard Enterprise APINR203 & APINP203  
**To:** FCC CFR 47 Part 15 Subpart E 15.407  
**Serial #:** HPEN96-U12 Rev A (1x1) (Conducted & Radiated Data)  
**Issue Date:** 13th June 2017  
**Page:** 111 of 147

POWER SPECTRAL DENSITY



Variant: 802.11a, Channel: 5580.00 MHz, Chain a, Temp: 20, Voltage: 110 Vac

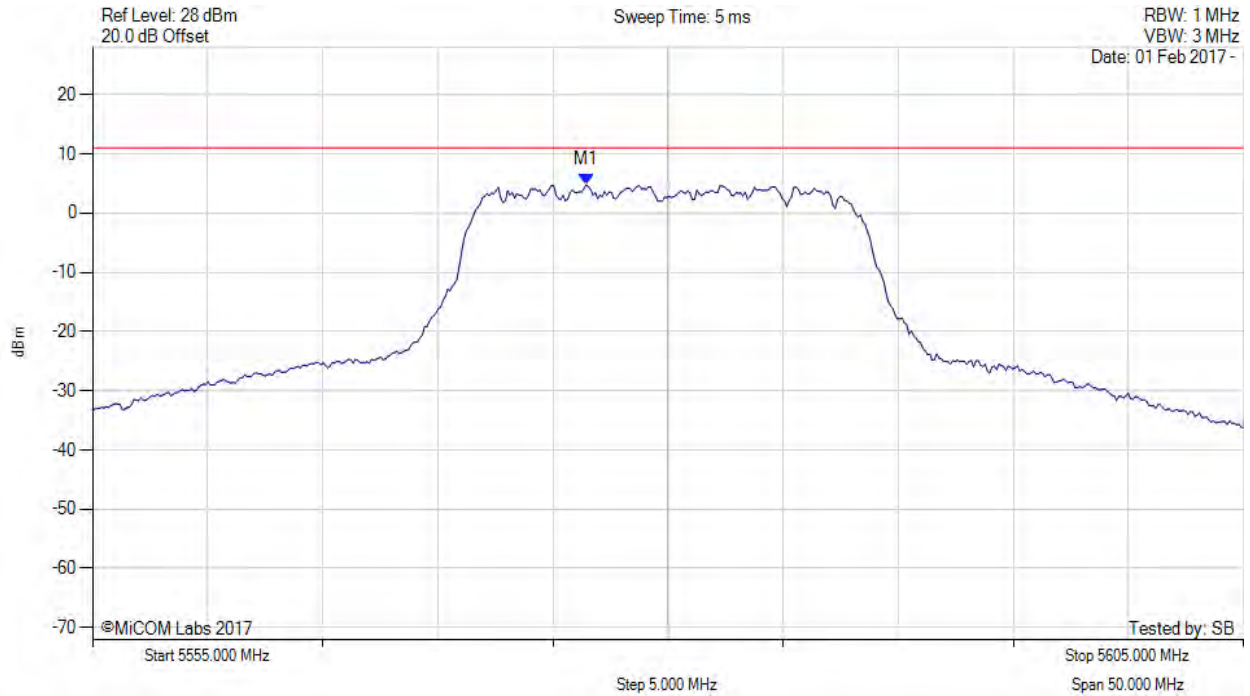

Analyzer Setup	Marker:Frequency:Amplitude	Test Results
Detector = RMS Sweep Count = 100 RF Atten (dB) = 20 Trace Mode = VIEWS	M1 : 5576.443 MHz : 4.776 dBm	Limit: $\leq 11.000$ dBm

[back to matrix](#)

This test report may be reproduced in full only. The document may only be updated by MiCOM Labs personnel. All changes will be noted in the Document History section of the report.



**Title:** Hewlett Packard Enterprise APINR203 & APINP203  
**To:** FCC CFR 47 Part 15 Subpart E 15.407  
**Serial #:** HPEN96-U12 Rev A (1x1) (Conducted & Radiated Data)  
**Issue Date:** 13th June 2017  
**Page:** 112 of 147



POWER SPECTRAL DENSITY

Variant: 802.11a, Channel: 5580.00 MHz, SUM, Temp: 20, Voltage: 110 Vac

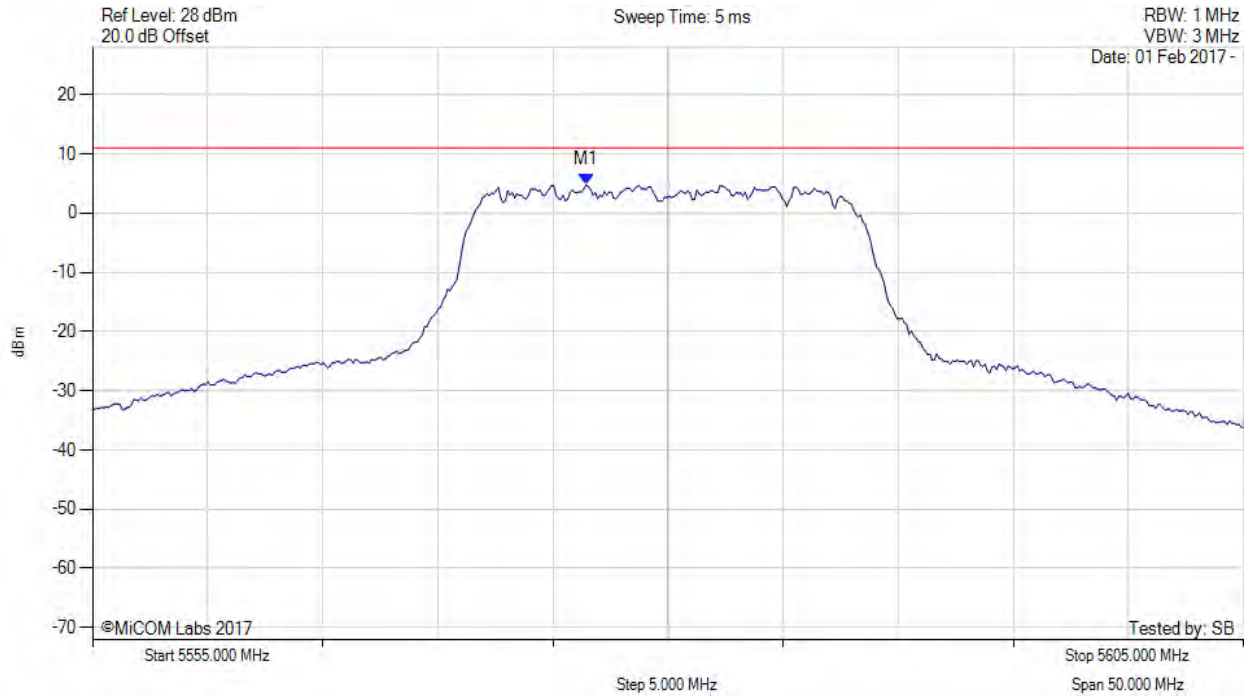

Analyzer Setup	Marker:Frequency:Amplitude	Test Results
Detector = RMS Sweep Count = 100 RF Atten (dB) = 20 Trace Mode = VIEW	M1 : 5576.400 MHz : 4.776 dBm M1 + DCCF : 5576.400 MHz : 4.820 dBm Duty Cycle Correction Factor : +0.04 dB	Limit: $\leq 11.0$ dBm Margin: -6.2 dB

[back to matrix](#)

This test report may be reproduced in full only. The document may only be updated by MiCOM Labs personnel. All changes will be noted in the Document History section of the report.



**Title:** Hewlett Packard Enterprise APINR203 & APINP203  
**To:** FCC CFR 47 Part 15 Subpart E 15.407  
**Serial #:** HPEN96-U12 Rev A (1x1) (Conducted & Radiated Data)  
**Issue Date:** 13th June 2017  
**Page:** 113 of 147

POWER SPECTRAL DENSITY



Variant: 802.11a, Channel: 5720.00 MHz, Chain a, Temp: 20, Voltage: 110 Vac

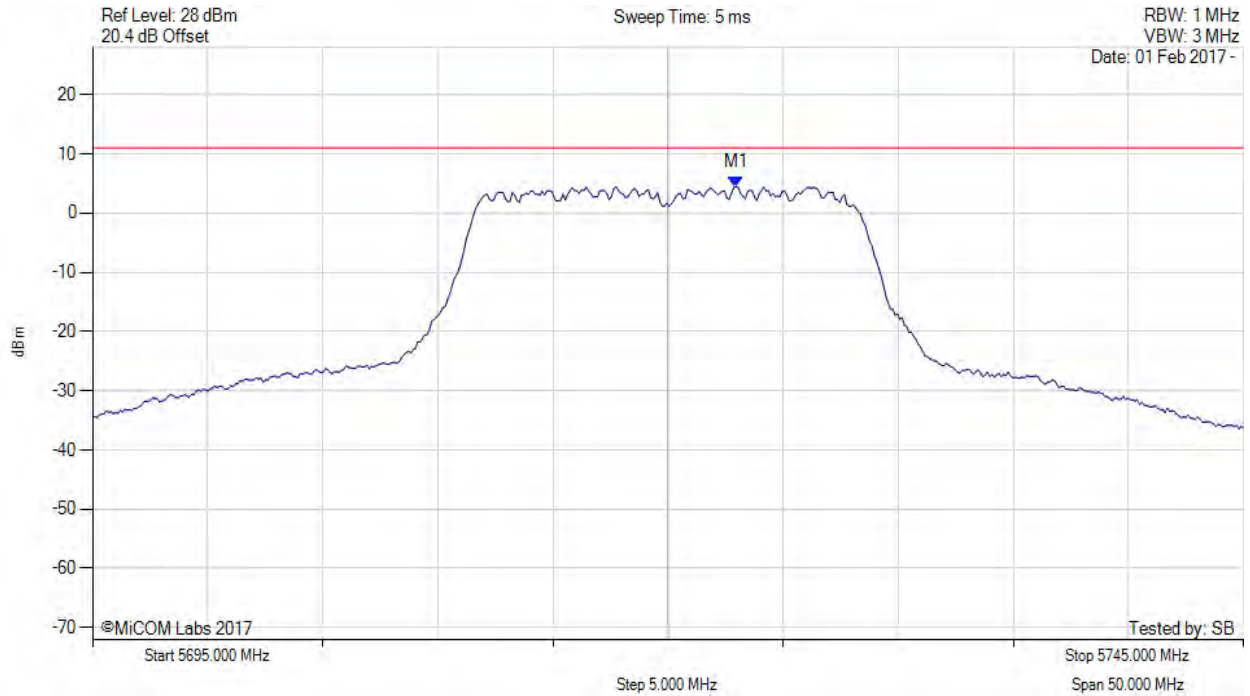

Analyzer Setup	Marker: Frequency: Amplitude	Test Results
Detector = RMS Sweep Count = 100 RF Atten (dB) = 20 Trace Mode = VIEWS	M1 : 5722.956 MHz : 4.455 dBm	Limit: $\leq 11.000$ dBm

[back to matrix](#)

This test report may be reproduced in full only. The document may only be updated by MiCOM Labs personnel. All changes will be noted in the Document History section of the report.



**Title:** Hewlett Packard Enterprise APINR203 & APINP203  
**To:** FCC CFR 47 Part 15 Subpart E 15.407  
**Serial #:** HPEN96-U12 Rev A (1x1) (Conducted & Radiated Data)  
**Issue Date:** 13th June 2017  
**Page:** 114 of 147

POWER SPECTRAL DENSITY



Variant: 802.11a, Channel: 5720.00 MHz, SUM, Temp: 20, Voltage: 110 Vac

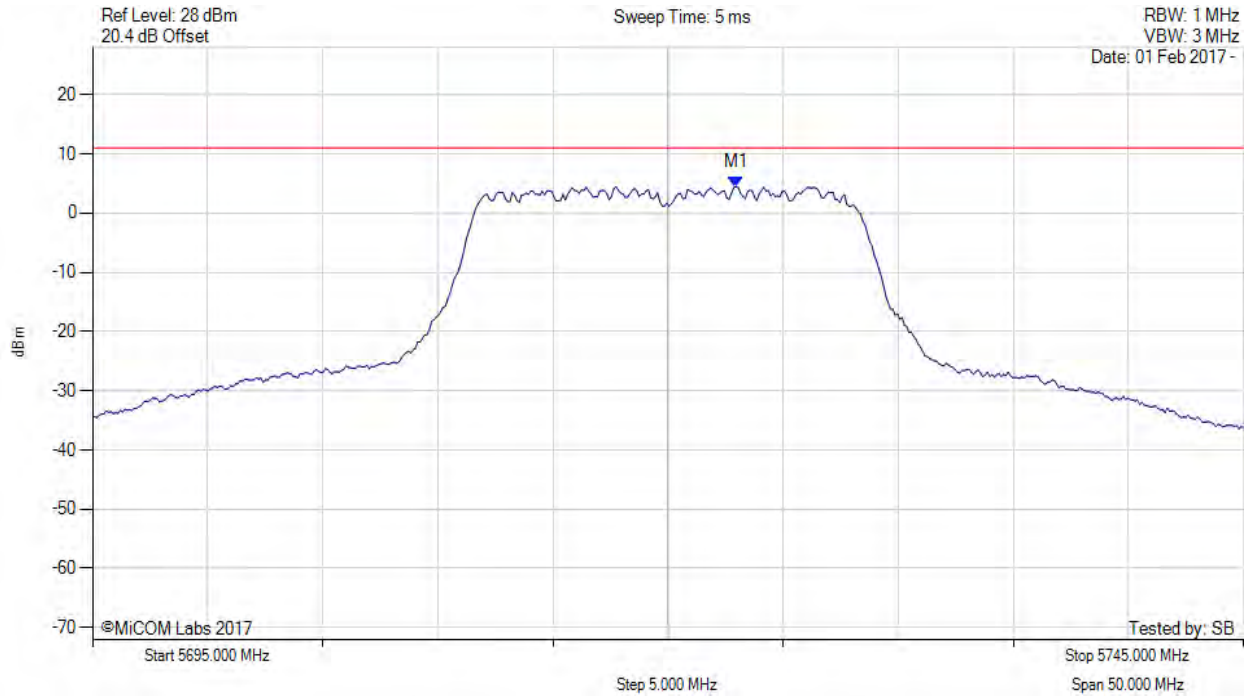

Analyzer Setup	Marker:Frequency:Amplitude	Test Results
Detector = RMS Sweep Count = 100 RF Atten (dB) = 20 Trace Mode = VIEW	M1 : 5723.000 MHz : 4.455 dBm M1 + DCCF : 5723.000 MHz : 4.499 dBm Duty Cycle Correction Factor : +0.04 dB	Limit: $\leq 11.0$ dBm Margin: -6.5 dB

[back to matrix](#)

This test report may be reproduced in full only. The document may only be updated by MiCOM Labs personnel. All changes will be noted in the Document History section of the report.



**Title:** Hewlett Packard Enterprise APINR203 & APINP203  
**To:** FCC CFR 47 Part 15 Subpart E 15.407  
**Serial #:** HPEN96-U12 Rev A (1x1) (Conducted & Radiated Data)  
**Issue Date:** 13th June 2017  
**Page:** 115 of 147

POWER SPECTRAL DENSITY



Variant: 802.11ac-80, Channel: 5530.00 MHz, Chain a, Temp: 20, Voltage: 110 Vac

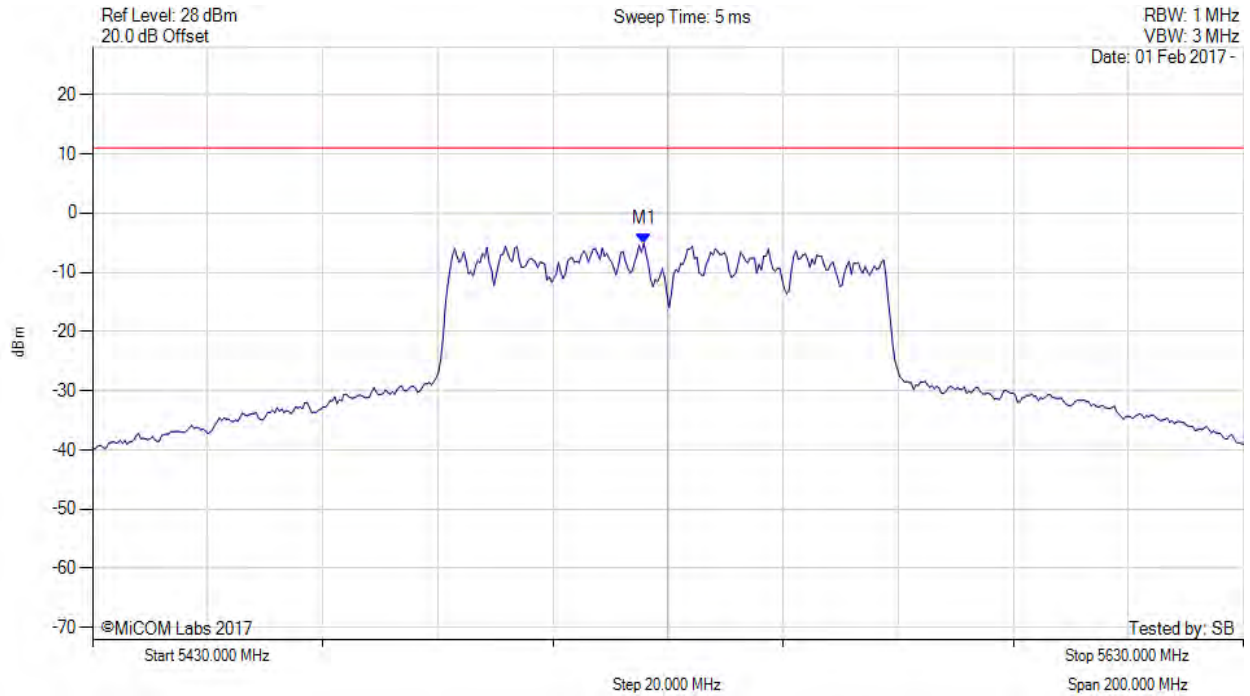

Analyzer Setup	Marker: Frequency: Amplitude	Test Results
Detector = RMS Sweep Count = 100 RF Atten (dB) = 20 Trace Mode = VIEWS	M1 : 5525.792 MHz : -5.165 dBm	Limit: $\leq 11.000$ dBm

[back to matrix](#)

This test report may be reproduced in full only. The document may only be updated by MiCOM Labs personnel. All changes will be noted in the Document History section of the report.



**Title:** Hewlett Packard Enterprise APINR203 & APINP203  
**To:** FCC CFR 47 Part 15 Subpart E 15.407  
**Serial #:** HPEN96-U12 Rev A (1x1) (Conducted & Radiated Data)  
**Issue Date:** 13th June 2017  
**Page:** 116 of 147



POWER SPECTRAL DENSITY

Variant: 802.11ac-80, Channel: 5530.00 MHz, SUM, Temp: 20, Voltage: 110 Vac

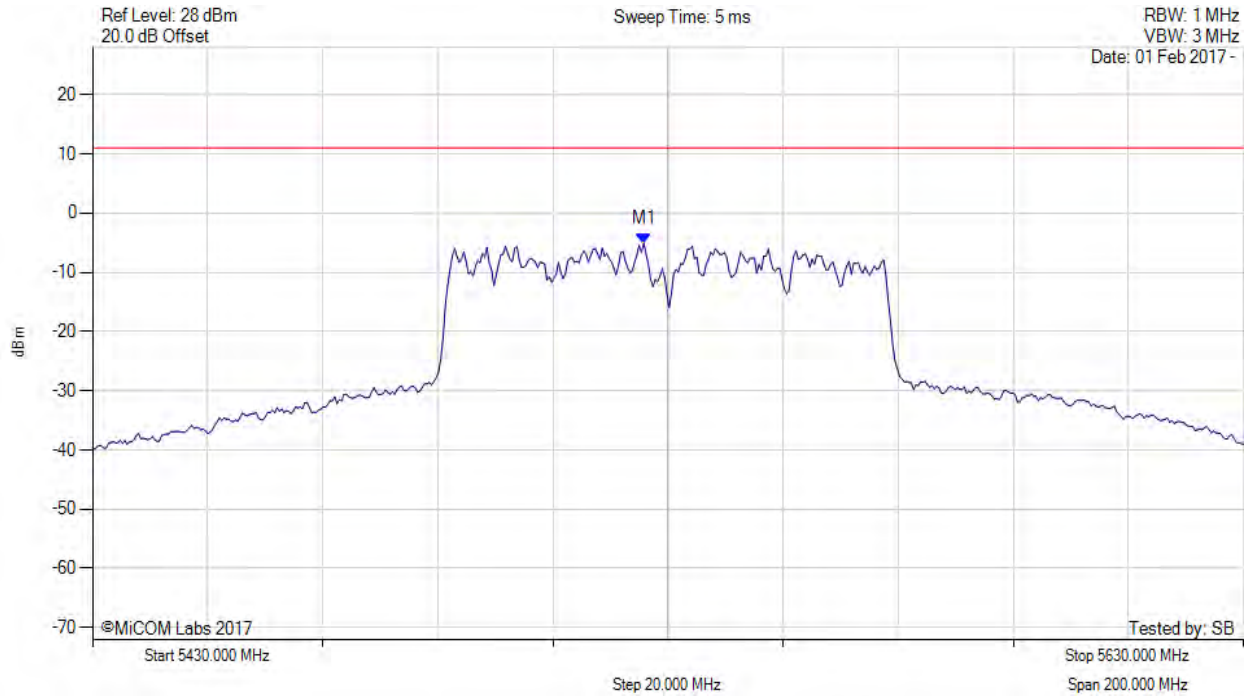

Analyzer Setup	Marker:Frequency:Amplitude	Test Results
Detector = RMS Sweep Count = 100 RF Atten (dB) = 20 Trace Mode = VIEW	M1 : 5525.800 MHz : -5.165 dBm M1 + DCCF : 5525.800 MHz : -4.196 dBm Duty Cycle Correction Factor : +0.97 dB	Limit: $\leq 11.0$ dBm Margin: -15.2 dB

[back to matrix](#)

This test report may be reproduced in full only. The document may only be updated by MiCOM Labs personnel. All changes will be noted in the Document History section of the report.





**Title:** Hewlett Packard Enterprise APINR203 & APINP203  
**To:** FCC CFR 47 Part 15 Subpart E 15.407  
**Serial #:** HPEN96-U12 Rev A (1x1) (Conducted & Radiated Data)  
**Issue Date:** 13th June 2017  
**Page:** 117 of 147

POWER SPECTRAL DENSITY



Variant: 802.11ac-80, Channel: 5610.00 MHz, Chain a, Temp: 20, Voltage: 110 Vac

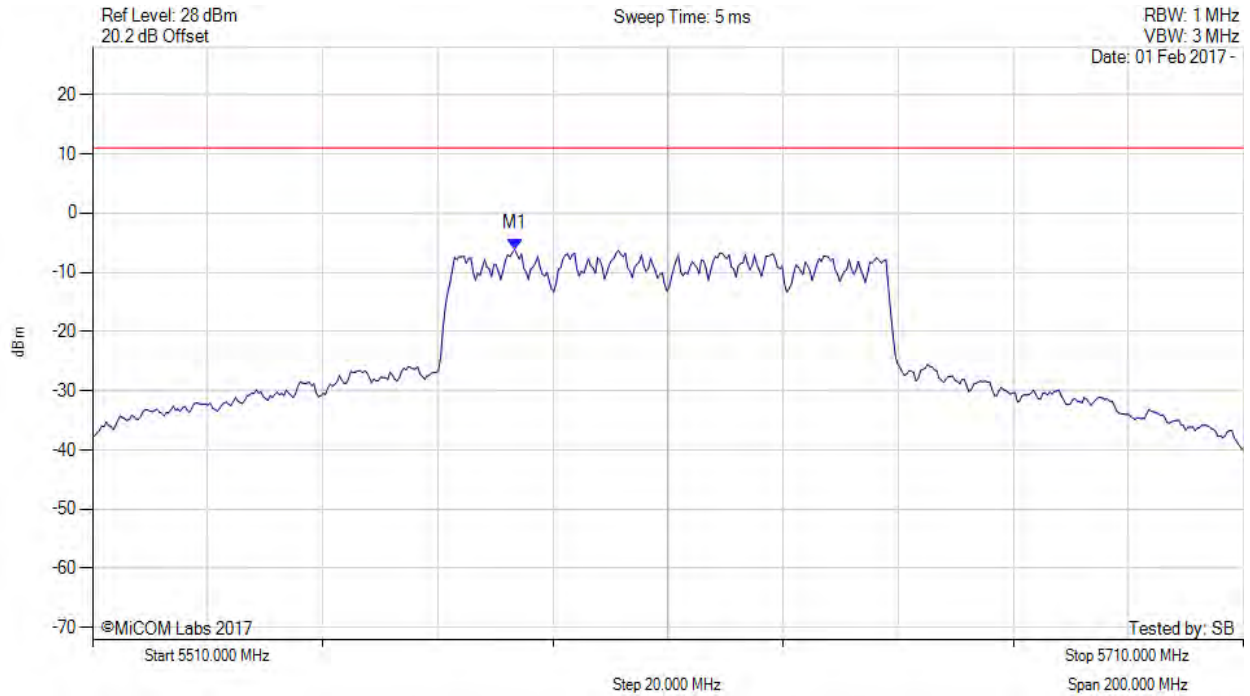

Analyzer Setup	Marker: Frequency: Amplitude	Test Results
Detector = RMS Sweep Count = 100 RF Atten (dB) = 20 Trace Mode = VIEWS	M1 : 5583.347 MHz : -6.041 dBm	Limit: $\leq 11.000$ dBm

[back to matrix](#)

This test report may be reproduced in full only. The document may only be updated by MiCOM Labs personnel. All changes will be noted in the Document History section of the report.





**Title:** Hewlett Packard Enterprise APINR203 & APINP203  
**To:** FCC CFR 47 Part 15 Subpart E 15.407  
**Serial #:** HPEN96-U12 Rev A (1x1) (Conducted & Radiated Data)  
**Issue Date:** 13th June 2017  
**Page:** 118 of 147



POWER SPECTRAL DENSITY

Variant: 802.11ac-80, Channel: 5610.00 MHz, SUM, Temp: 20, Voltage: 110 Vac

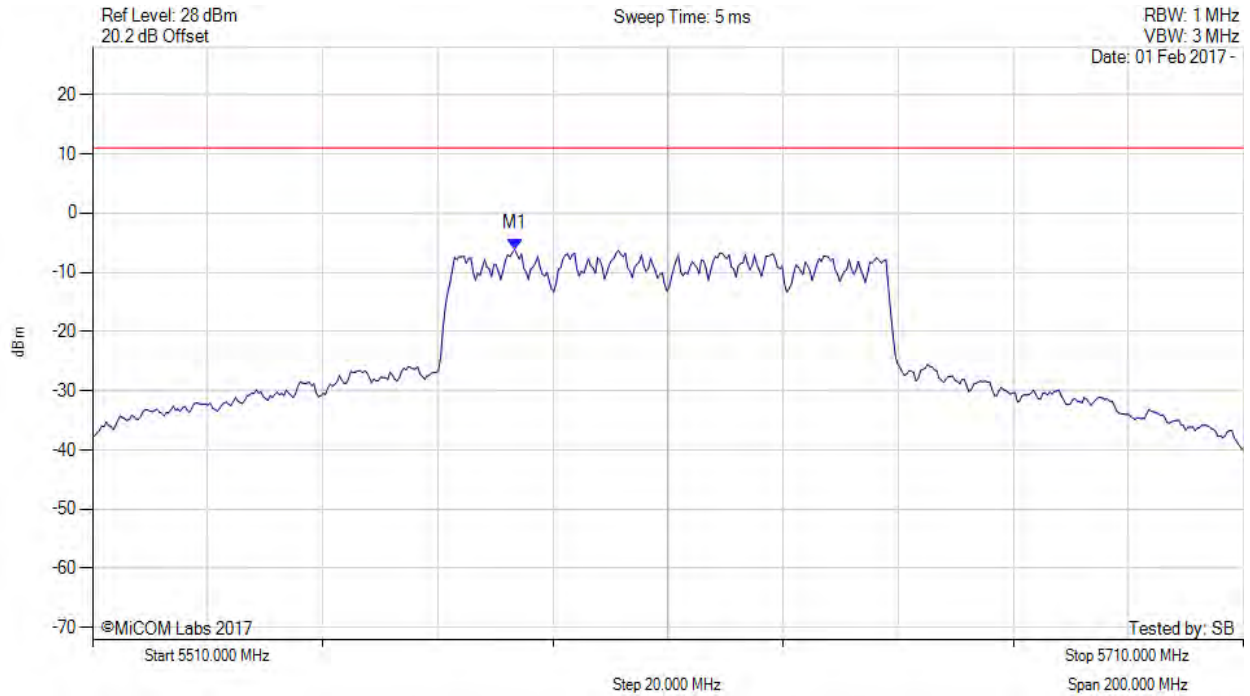

Analyzer Setup	Marker:Frequency:Amplitude	Test Results
Detector = RMS Sweep Count = 100 RF Atten (dB) = 20 Trace Mode = VIEW	M1 : 5583.300 MHz : -6.041 dBm M1 + DCCF : 5583.300 MHz : -5.072 dBm Duty Cycle Correction Factor : +0.97 dB	Limit: $\leq 11.0$ dBm Margin: -16.1 dB

[back to matrix](#)

This test report may be reproduced in full only. The document may only be updated by MiCOM Labs personnel. All changes will be noted in the Document History section of the report.



**Title:** Hewlett Packard Enterprise APINR203 & APINP203  
**To:** FCC CFR 47 Part 15 Subpart E 15.407  
**Serial #:** HPEN96-U12 Rev A (1x1) (Conducted & Radiated Data)  
**Issue Date:** 13th June 2017  
**Page:** 119 of 147



POWER SPECTRAL DENSITY

Variant: 802.11ac-80, Channel: 5690.00 MHz, Chain a, Temp: 20, Voltage: 110 Vac

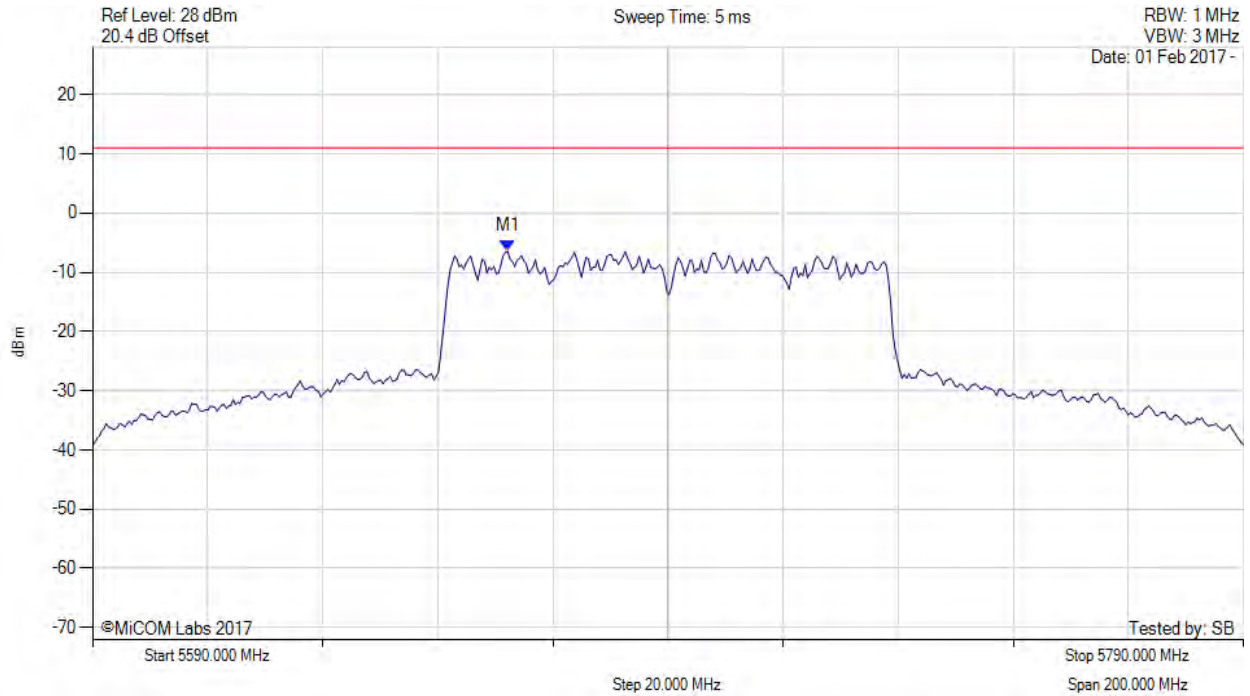

Analyzer Setup	Marker: Frequency: Amplitude	Test Results
Detector = RMS Sweep Count = 100 RF Atten (dB) = 20 Trace Mode = VIEWS	M1 : 5662.144 MHz : -6.447 dBm	Limit: $\leq 11.000$ dBm

[back to matrix](#)

This test report may be reproduced in full only. The document may only be updated by MiCOM Labs personnel. All changes will be noted in the Document History section of the report.



**Title:** Hewlett Packard Enterprise APINR203 & APINP203  
**To:** FCC CFR 47 Part 15 Subpart E 15.407  
**Serial #:** HPEN96-U12 Rev A (1x1) (Conducted & Radiated Data)  
**Issue Date:** 13th June 2017  
**Page:** 120 of 147



POWER SPECTRAL DENSITY

Variant: 802.11ac-80, Channel: 5690.00 MHz, SUM, Temp: 20, Voltage: 110 Vac

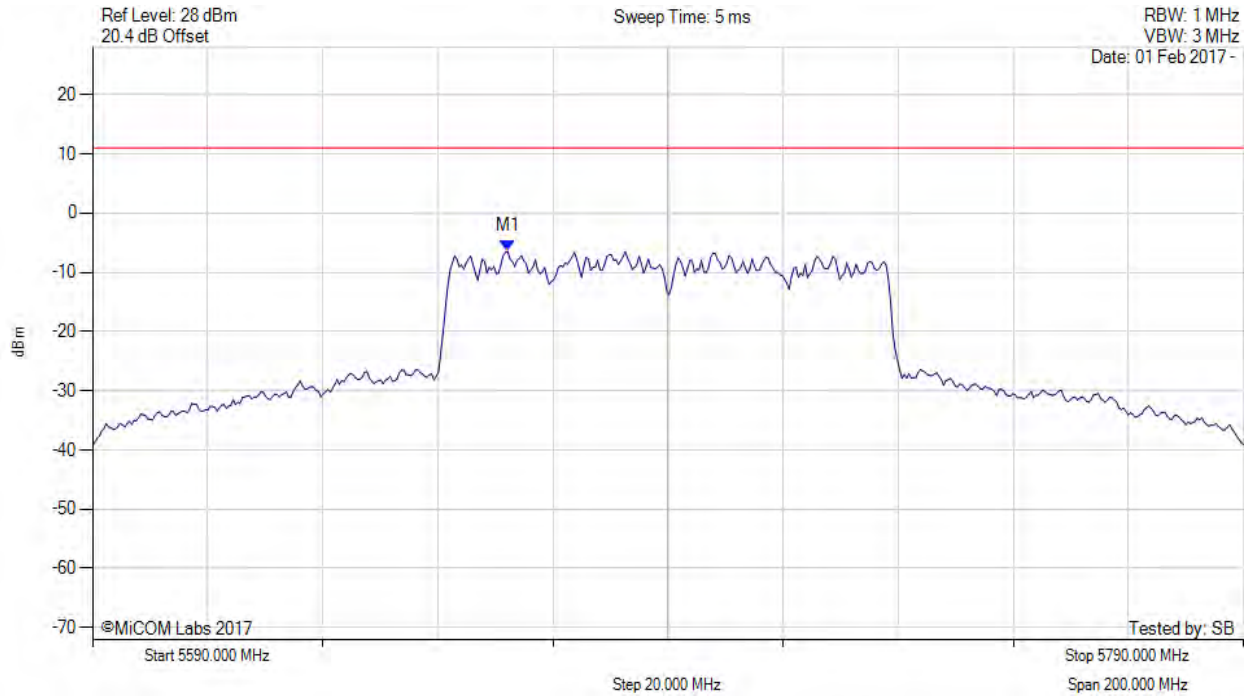

Analyzer Setup	Marker:Frequency:Amplitude	Test Results
Detector = RMS Sweep Count = 100 RF Atten (dB) = 20 Trace Mode = VIEW	M1 : 5662.100 MHz : -6.447 dBm M1 + DCCF : 5662.100 MHz : -5.478 dBm Duty Cycle Correction Factor : +0.97 dB	Limit: $\leq 11.0$ dBm Margin: -16.5 dB

[back to matrix](#)

This test report may be reproduced in full only. The document may only be updated by MiCOM Labs personnel. All changes will be noted in the Document History section of the report.



**Title:** Hewlett Packard Enterprise APINR203 & APINP203  
**To:** FCC CFR 47 Part 15 Subpart E 15.407  
**Serial #:** HPEN96-U12 Rev A (1x1) (Conducted & Radiated Data)  
**Issue Date:** 13th June 2017  
**Page:** 121 of 147

POWER SPECTRAL DENSITY



Variant: 802.11n HT-20, Channel: 5500.00 MHz, Chain a, Temp: 20, Voltage: 110 Vac

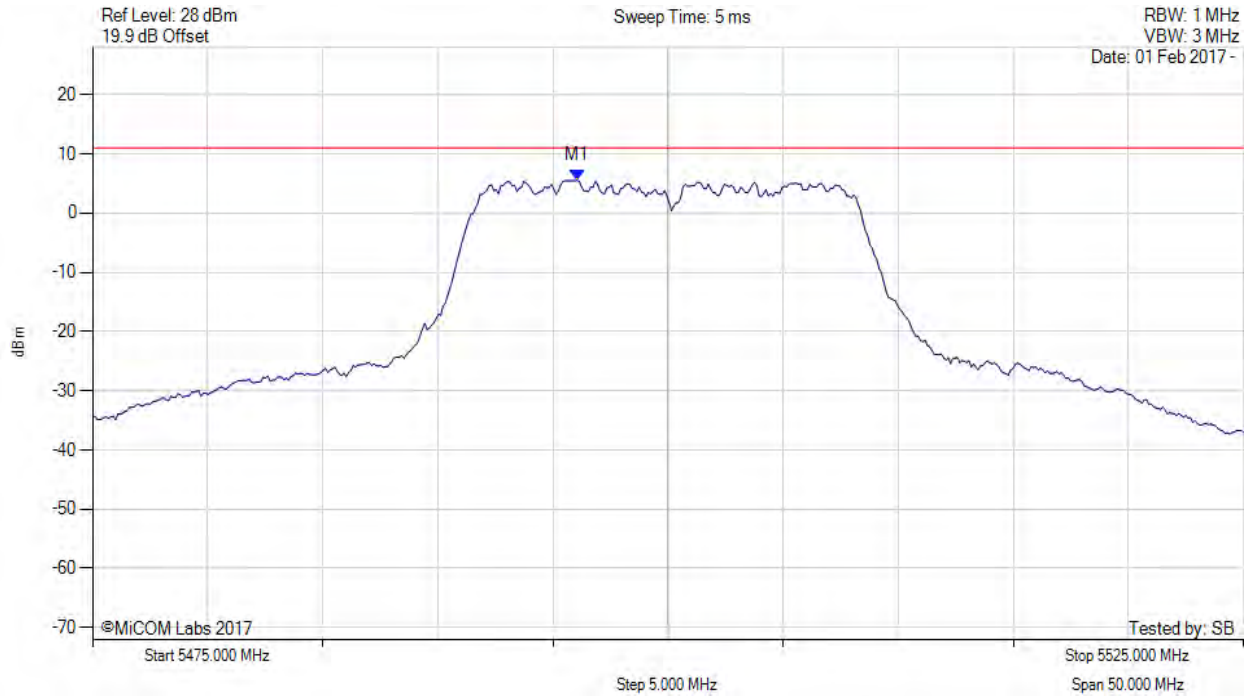

Analyzer Setup	Marker: Frequency: Amplitude	Test Results
Detector = RMS Sweep Count = 100 RF Atten (dB) = 20 Trace Mode = VIEWS	M1 : 5496.042 MHz : 5.525 dBm	Limit: $\leq 11.000$ dBm

[back to matrix](#)

This test report may be reproduced in full only. The document may only be updated by MiCOM Labs personnel. All changes will be noted in the Document History section of the report.



**Title:** Hewlett Packard Enterprise APINR203 & APINP203  
**To:** FCC CFR 47 Part 15 Subpart E 15.407  
**Serial #:** HPEN96-U12 Rev A (1x1) (Conducted & Radiated Data)  
**Issue Date:** 13th June 2017  
**Page:** 122 of 147

POWER SPECTRAL DENSITY



Variant: 802.11n HT-20, Channel: 5500.00 MHz, SUM, Temp: 20, Voltage: 110 Vac

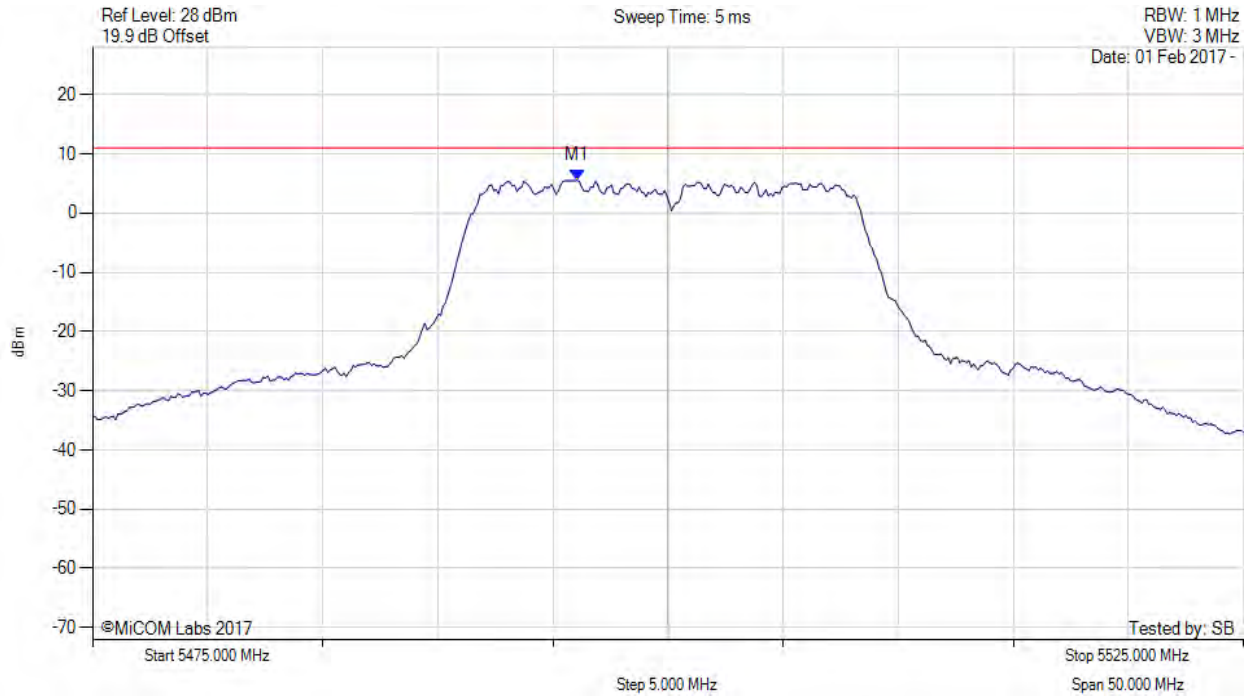

Analyzer Setup	Marker:Frequency:Amplitude	Test Results
Detector = RMS Sweep Count = 100 RF Atten (dB) = 20 Trace Mode = VIEW	M1 : 5496.000 MHz : 5.525 dBm M1 + DCCF : 5496.000 MHz : 5.569 dBm Duty Cycle Correction Factor : +0.04 dB	Limit: $\leq 11.0$ dBm Margin: -5.4 dB

[back to matrix](#)

This test report may be reproduced in full only. The document may only be updated by MiCOM Labs personnel. All changes will be noted in the Document History section of the report.



**Title:** Hewlett Packard Enterprise APINR203 & APINP203  
**To:** FCC CFR 47 Part 15 Subpart E 15.407  
**Serial #:** HPEN96-U12 Rev A (1x1) (Conducted & Radiated Data)  
**Issue Date:** 13th June 2017  
**Page:** 123 of 147

POWER SPECTRAL DENSITY



Variant: 802.11n HT-20, Channel: 5580.00 MHz, Chain a, Temp: 20, Voltage: 110 Vac

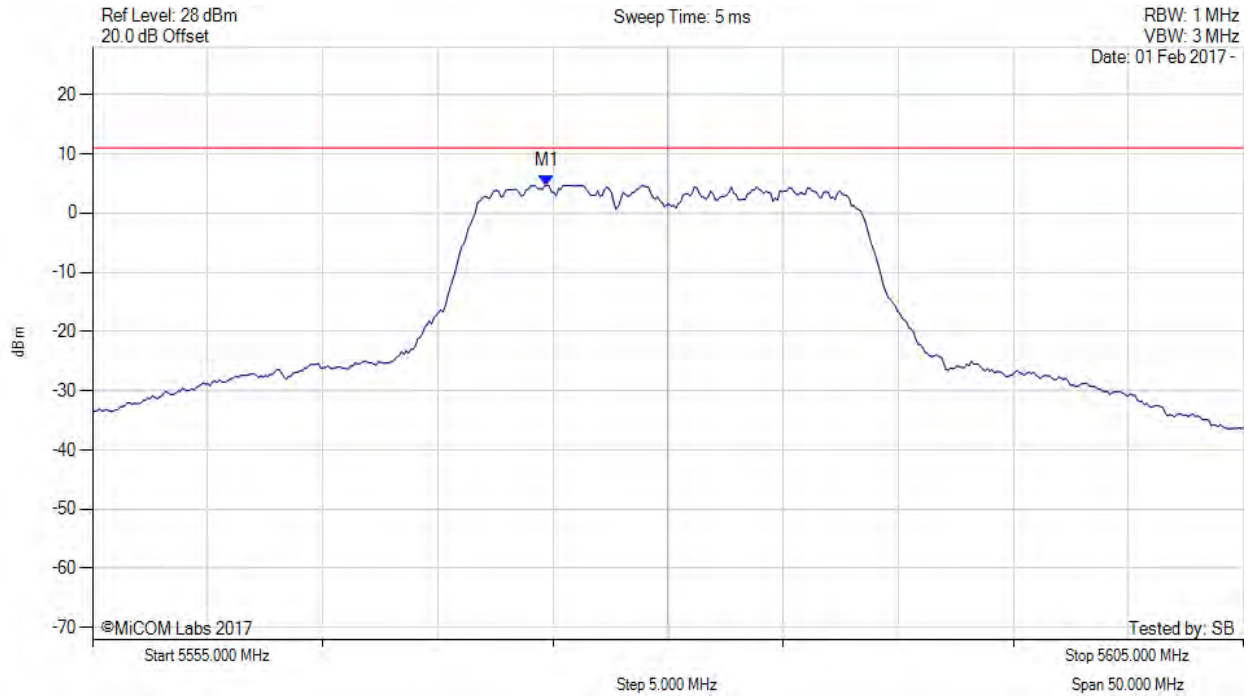

Analyzer Setup	Marker:Frequency:Amplitude	Test Results
Detector = RMS Sweep Count = 100 RF Atten (dB) = 20 Trace Mode = VIEWS	M1 : 5574.739 MHz : 4.700 dBm	Limit: $\leq 11.000$ dBm

[back to matrix](#)

This test report may be reproduced in full only. The document may only be updated by MiCOM Labs personnel. All changes will be noted in the Document History section of the report.



**Title:** Hewlett Packard Enterprise APINR203 & APINP203  
**To:** FCC CFR 47 Part 15 Subpart E 15.407  
**Serial #:** HPEN96-U12 Rev A (1x1) (Conducted & Radiated Data)  
**Issue Date:** 13th June 2017  
**Page:** 124 of 147

POWER SPECTRAL DENSITY



Variant: 802.11n HT-20, Channel: 5580.00 MHz, SUM, Temp: 20, Voltage: 110 Vac

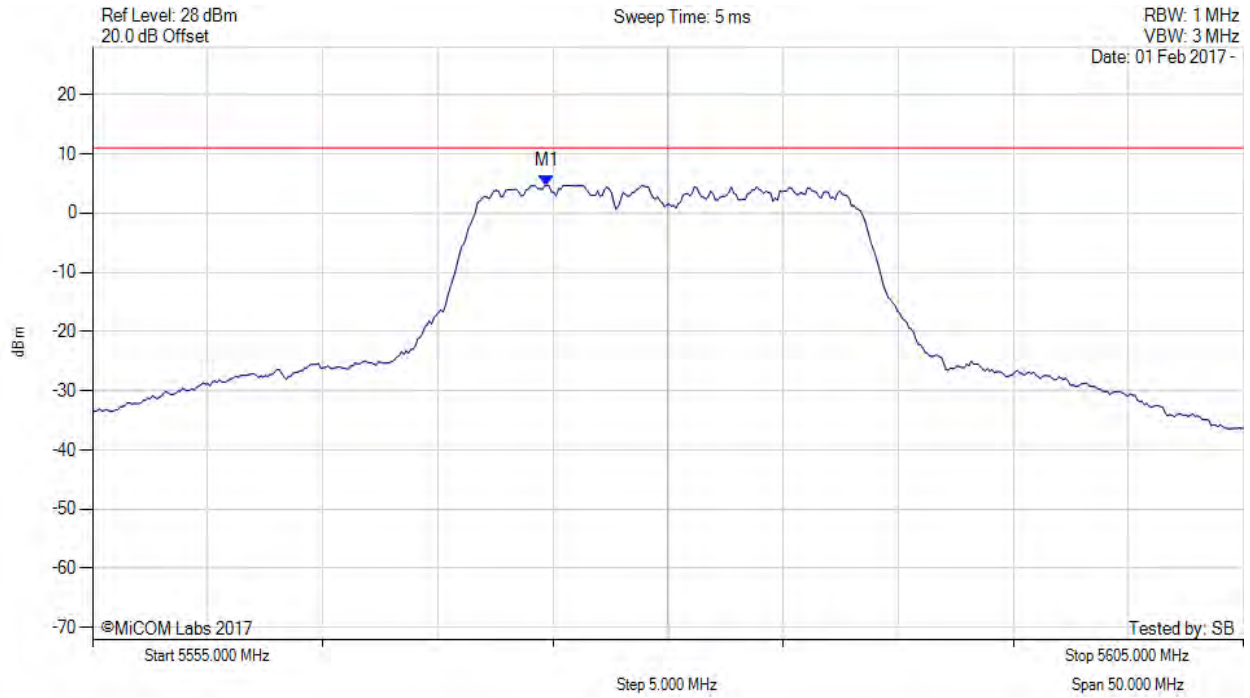

Analyzer Setup	Marker:Frequency:Amplitude	Test Results
Detector = RMS Sweep Count = 100 RF Atten (dB) = 20 Trace Mode = VIEW	M1 : 5574.700 MHz : 4.700 dBm M1 + DCCF : 5574.700 MHz : 4.744 dBm Duty Cycle Correction Factor : +0.04 dB	Limit: $\leq 11.0$ dBm Margin: -6.3 dB

[back to matrix](#)

This test report may be reproduced in full only. The document may only be updated by MiCOM Labs personnel. All changes will be noted in the Document History section of the report.





**Title:** Hewlett Packard Enterprise APINR203 & APINP203  
**To:** FCC CFR 47 Part 15 Subpart E 15.407  
**Serial #:** HPEN96-U12 Rev A (1x1) (Conducted & Radiated Data)  
**Issue Date:** 13th June 2017  
**Page:** 125 of 147

POWER SPECTRAL DENSITY



Variant: 802.11n HT-20, Channel: 5720.00 MHz, Chain a, Temp: 20, Voltage: 110 Vac

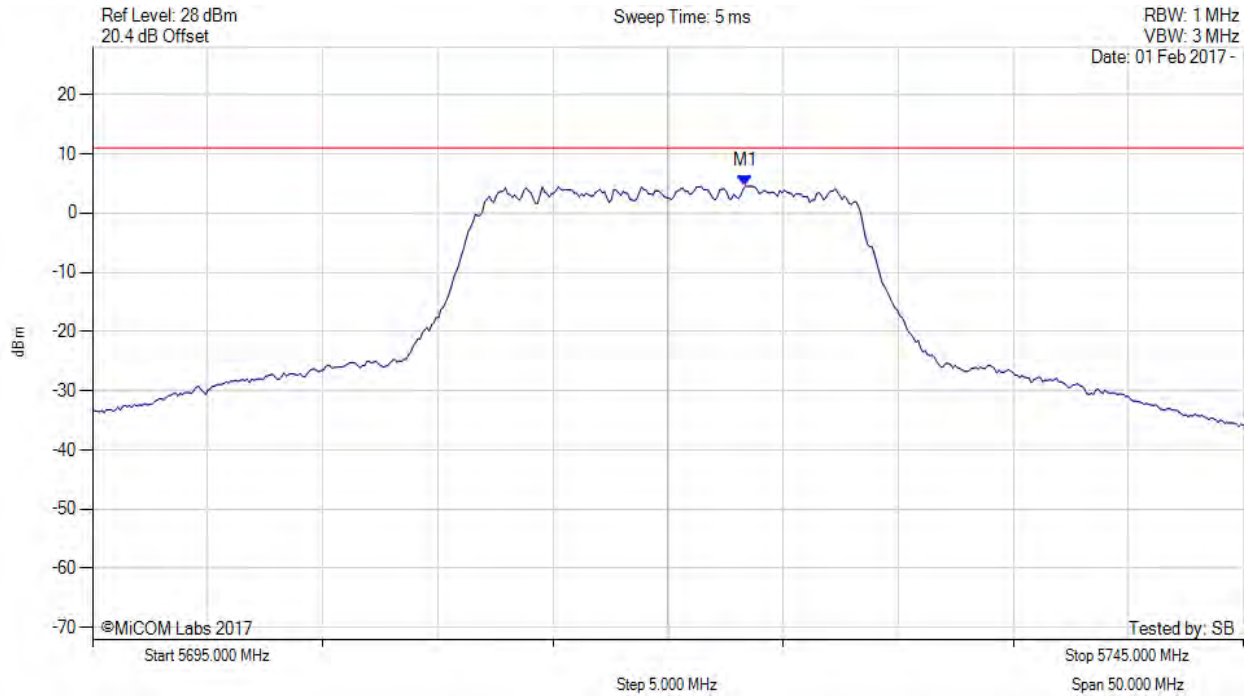

Analyzer Setup	Marker: Frequency: Amplitude	Test Results
Detector = RMS Sweep Count = 100 RF Atten (dB) = 20 Trace Mode = VIEWS	M1 : 5723.357 MHz : 4.552 dBm	Limit: $\leq 11.000$ dBm

[back to matrix](#)

This test report may be reproduced in full only. The document may only be updated by MiCOM Labs personnel. All changes will be noted in the Document History section of the report.





**Title:** Hewlett Packard Enterprise APINR203 & APINP203  
**To:** FCC CFR 47 Part 15 Subpart E 15.407  
**Serial #:** HPEN96-U12 Rev A (1x1) (Conducted & Radiated Data)  
**Issue Date:** 13th June 2017  
**Page:** 126 of 147

POWER SPECTRAL DENSITY



Variant: 802.11n HT-20, Channel: 5720.00 MHz, SUM, Temp: 20, Voltage: 110 Vac

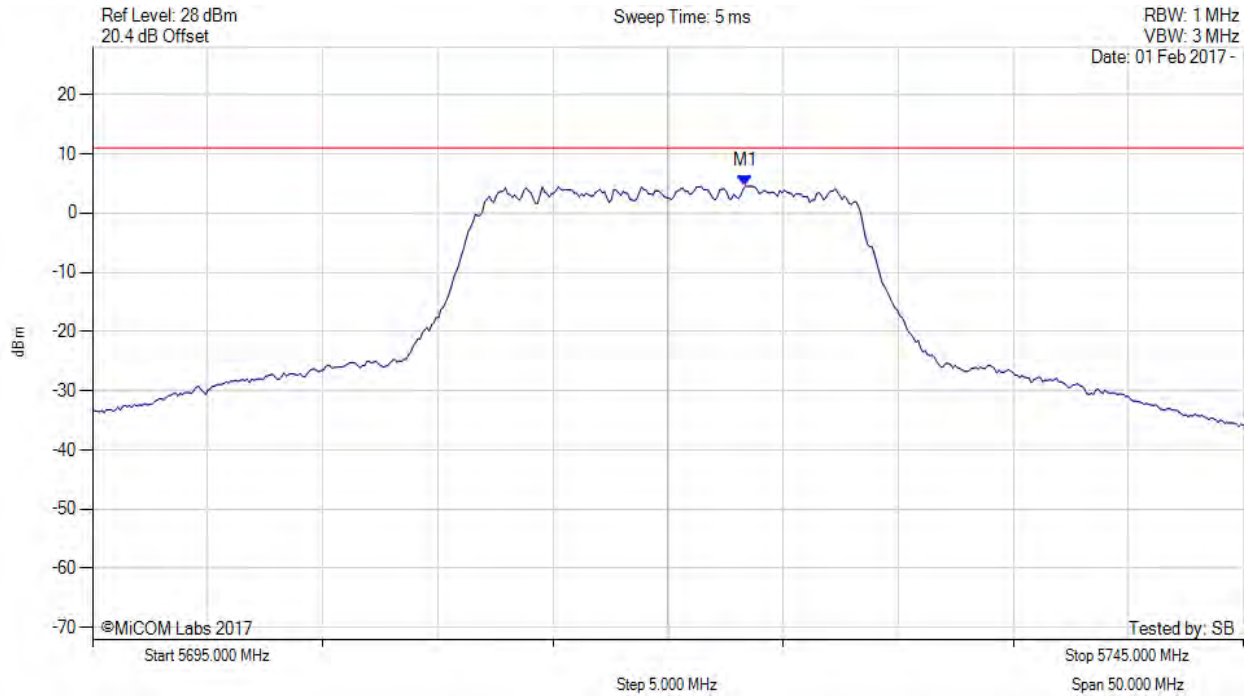

Analyzer Setup	Marker:Frequency:Amplitude	Test Results
Detector = RMS Sweep Count = 100 RF Atten (dB) = 20 Trace Mode = VIEW	M1 : 5723.400 MHz : 4.552 dBm M1 + DCCF : 5723.400 MHz : 4.596 dBm Duty Cycle Correction Factor : +0.04 dB	Limit: $\leq 11.0$ dBm Margin: -6.4 dB

[back to matrix](#)

This test report may be reproduced in full only. The document may only be updated by MiCOM Labs personnel. All changes will be noted in the Document History section of the report.



**Title:** Hewlett Packard Enterprise APINR203 & APINP203  
**To:** FCC CFR 47 Part 15 Subpart E 15.407  
**Serial #:** HPEN96-U12 Rev A (1x1) (Conducted & Radiated Data)  
**Issue Date:** 13th June 2017  
**Page:** 127 of 147



POWER SPECTRAL DENSITY

Variant: 802.11n HT-40, Channel: 5510.00 MHz, Chain a, Temp: 20, Voltage: 110 Vac

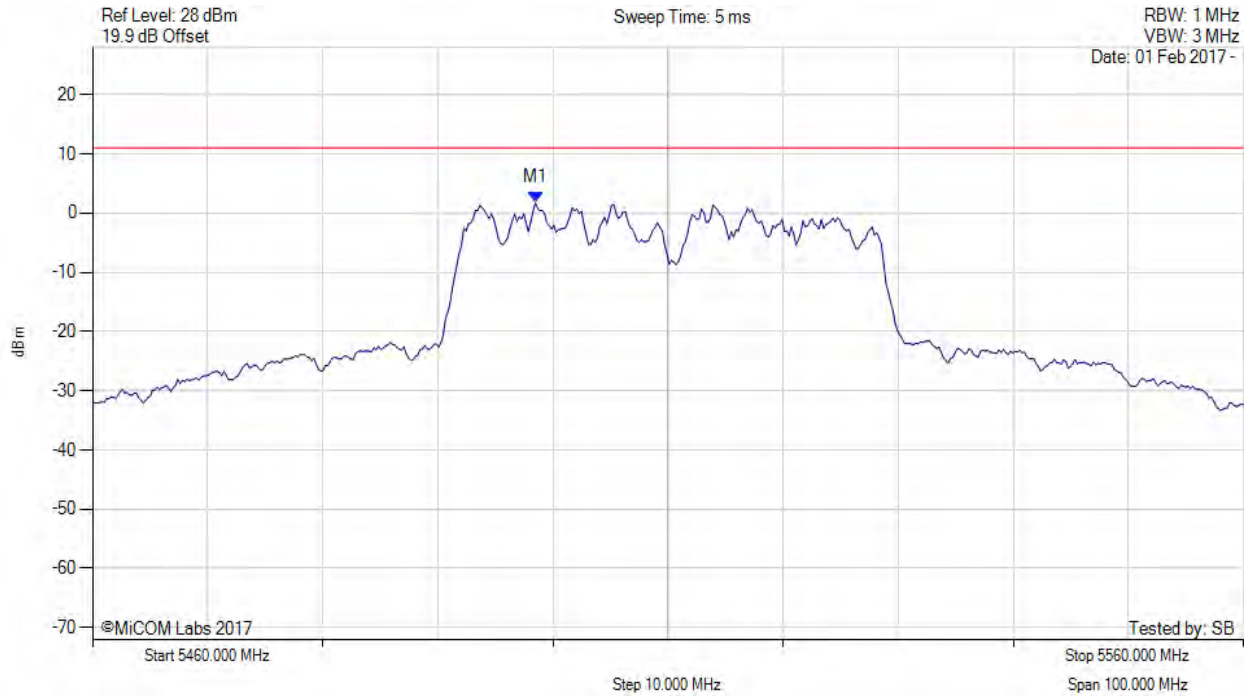

Analyzer Setup	Marker: Frequency: Amplitude	Test Results
Detector = RMS Sweep Count = 100 RF Atten (dB) = 20 Trace Mode = VIEWS	M1 : 5498.477 MHz : 1.774 dBm	Limit: $\leq 11.000$ dBm

[back to matrix](#)

This test report may be reproduced in full only. The document may only be updated by MiCOM Labs personnel. All changes will be noted in the Document History section of the report.



**Title:** Hewlett Packard Enterprise APINR203 & APINP203  
**To:** FCC CFR 47 Part 15 Subpart E 15.407  
**Serial #:** HPEN96-U12 Rev A (1x1) (Conducted & Radiated Data)  
**Issue Date:** 13th June 2017  
**Page:** 128 of 147

POWER SPECTRAL DENSITY



Variant: 802.11n HT-40, Channel: 5510.00 MHz, SUM, Temp: 20, Voltage: 110 Vac

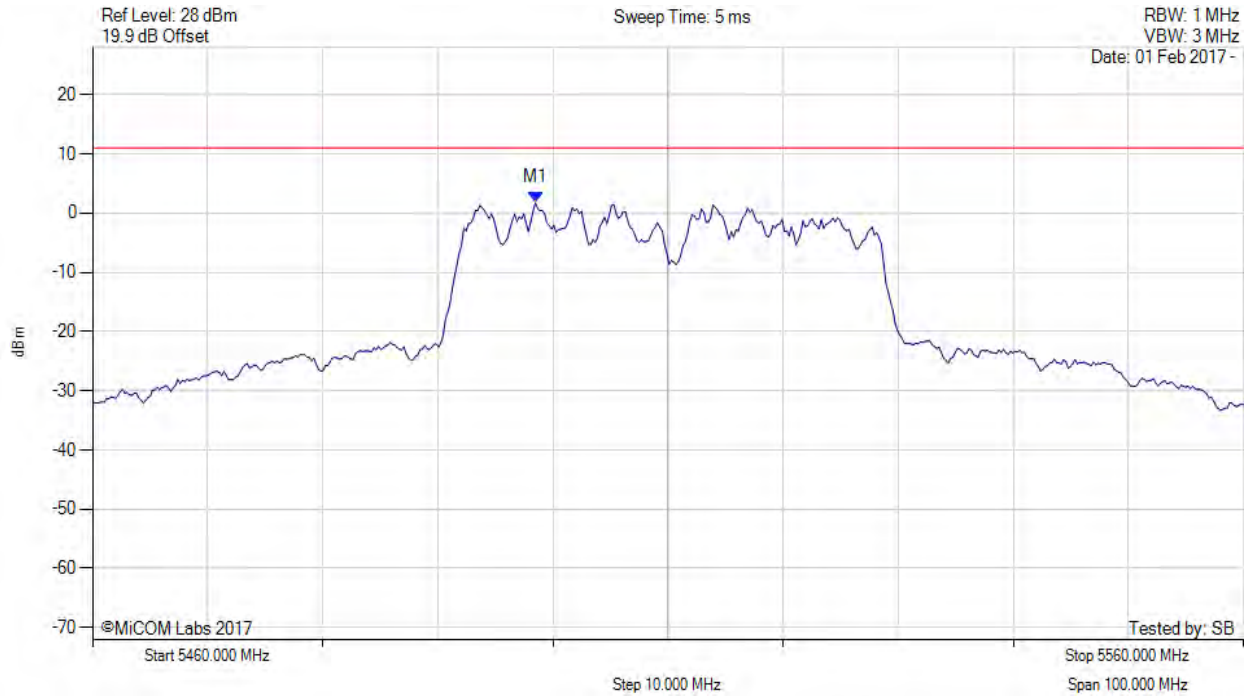

Analyzer Setup	Marker: Frequency: Amplitude	Test Results
Detector = RMS Sweep Count = 100 RF Atten (dB) = 20 Trace Mode = VIEW	M1 : 5498.500 MHz : 1.774 dBm M1 + DCCF : 5498.500 MHz : 2.242 dBm Duty Cycle Correction Factor : +0.46 dB	Limit: $\leq 11.0$ dBm Margin: -8.8 dB

[back to matrix](#)

This test report may be reproduced in full only. The document may only be updated by MiCOM Labs personnel. All changes will be noted in the Document History section of the report.



**Title:** Hewlett Packard Enterprise APINR203 & APINP203  
**To:** FCC CFR 47 Part 15 Subpart E 15.407  
**Serial #:** HPEN96-U12 Rev A (1x1) (Conducted & Radiated Data)  
**Issue Date:** 13th June 2017  
**Page:** 129 of 147



POWER SPECTRAL DENSITY

Variant: 802.11n HT-40, Channel: 5550.00 MHz, Chain a, Temp: 20, Voltage: 110 Vac

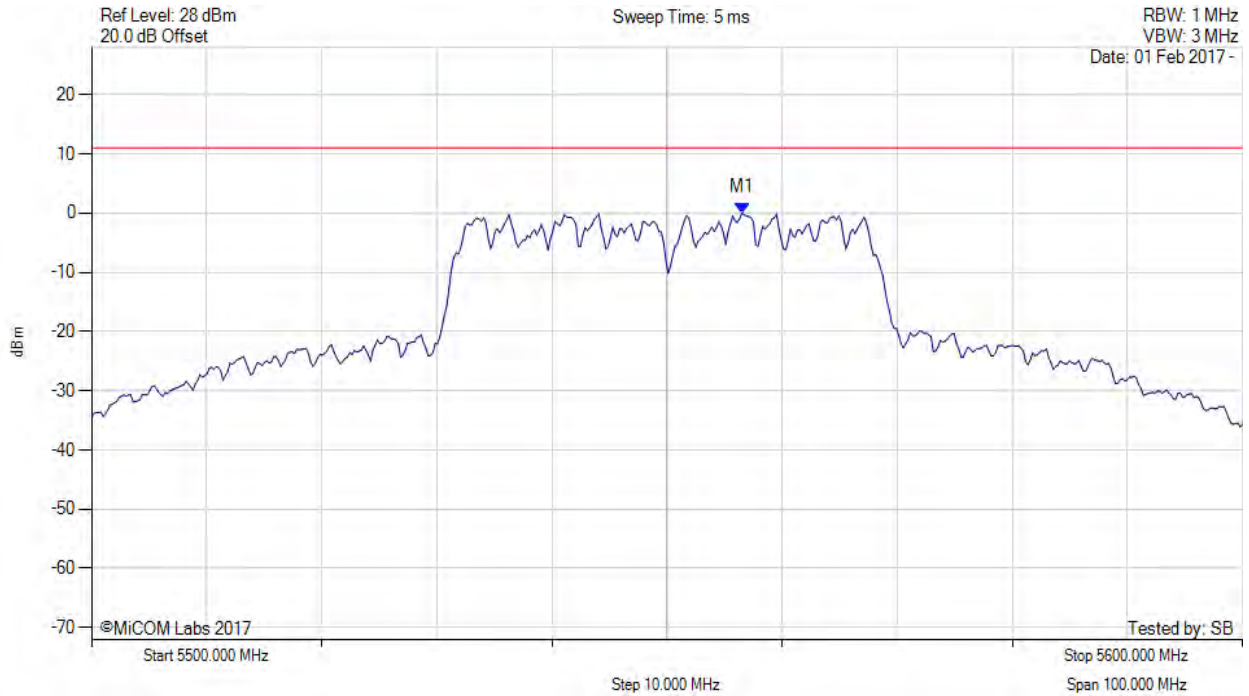

Analyzer Setup	Marker: Frequency: Amplitude	Test Results
Detector = RMS Sweep Count = 100 RF Atten (dB) = 20 Trace Mode = VIEWS	M1 : 5556.513 MHz : 0.031 dBm	Limit: $\leq 11.000$ dBm

[back to matrix](#)

This test report may be reproduced in full only. The document may only be updated by MiCOM Labs personnel. All changes will be noted in the Document History section of the report.



**Title:** Hewlett Packard Enterprise APINR203 & APINP203  
**To:** FCC CFR 47 Part 15 Subpart E 15.407  
**Serial #:** HPEN96-U12 Rev A (1x1) (Conducted & Radiated Data)  
**Issue Date:** 13th June 2017  
**Page:** 130 of 147

POWER SPECTRAL DENSITY



Variant: 802.11n HT-40, Channel: 5550.00 MHz, SUM, Temp: 20, Voltage: 110 Vac

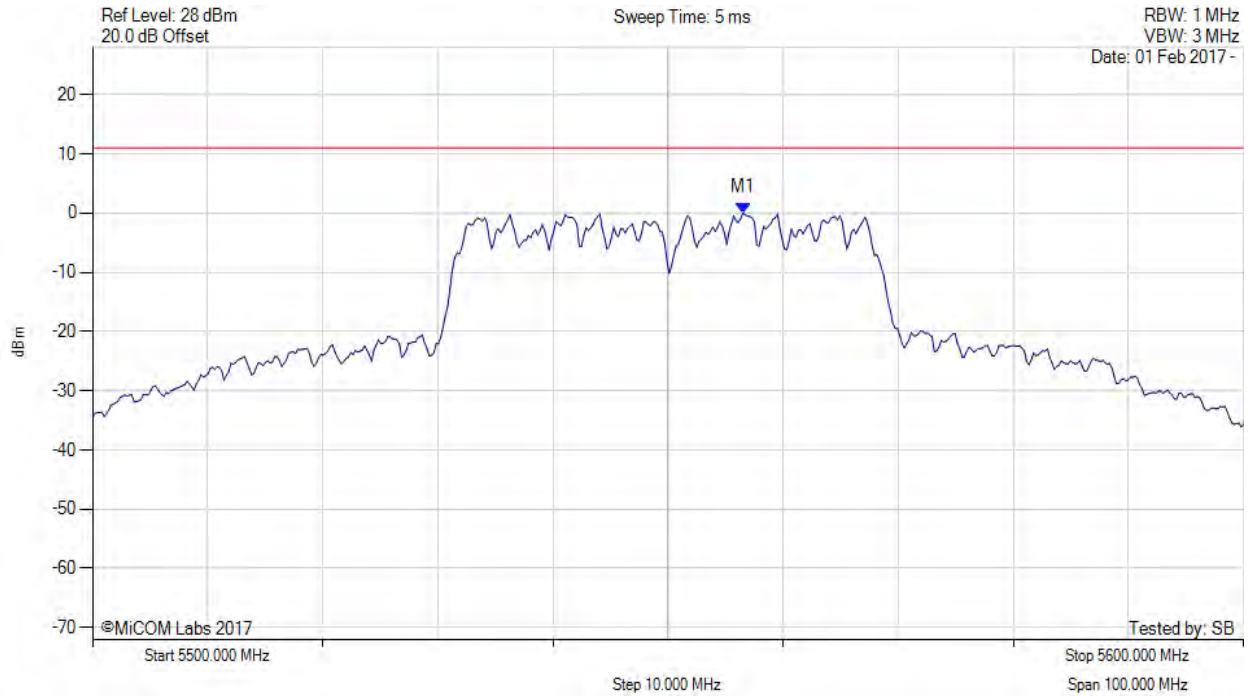

Analyzer Setup	Marker:Frequency:Amplitude	Test Results
Detector = RMS Sweep Count = 100 RF Atten (dB) = 20 Trace Mode = VIEW	M1 : 5556.500 MHz : 0.031 dBm M1 + DCCF : 5556.500 MHz : 0.499 dBm Duty Cycle Correction Factor : +0.46 dB	Limit: $\leq 11.0$ dBm Margin: -10.5 dB

[back to matrix](#)

This test report may be reproduced in full only. The document may only be updated by MiCOM Labs personnel. All changes will be noted in the Document History section of the report.



**Title:** Hewlett Packard Enterprise APINR203 & APINP203  
**To:** FCC CFR 47 Part 15 Subpart E 15.407  
**Serial #:** HPEN96-U12 Rev A (1x1) (Conducted & Radiated Data)  
**Issue Date:** 13th June 2017  
**Page:** 131 of 147



POWER SPECTRAL DENSITY

Variant: 802.11n HT-40, Channel: 5710.00 MHz, Chain a, Temp: 20, Voltage: 110 Vac

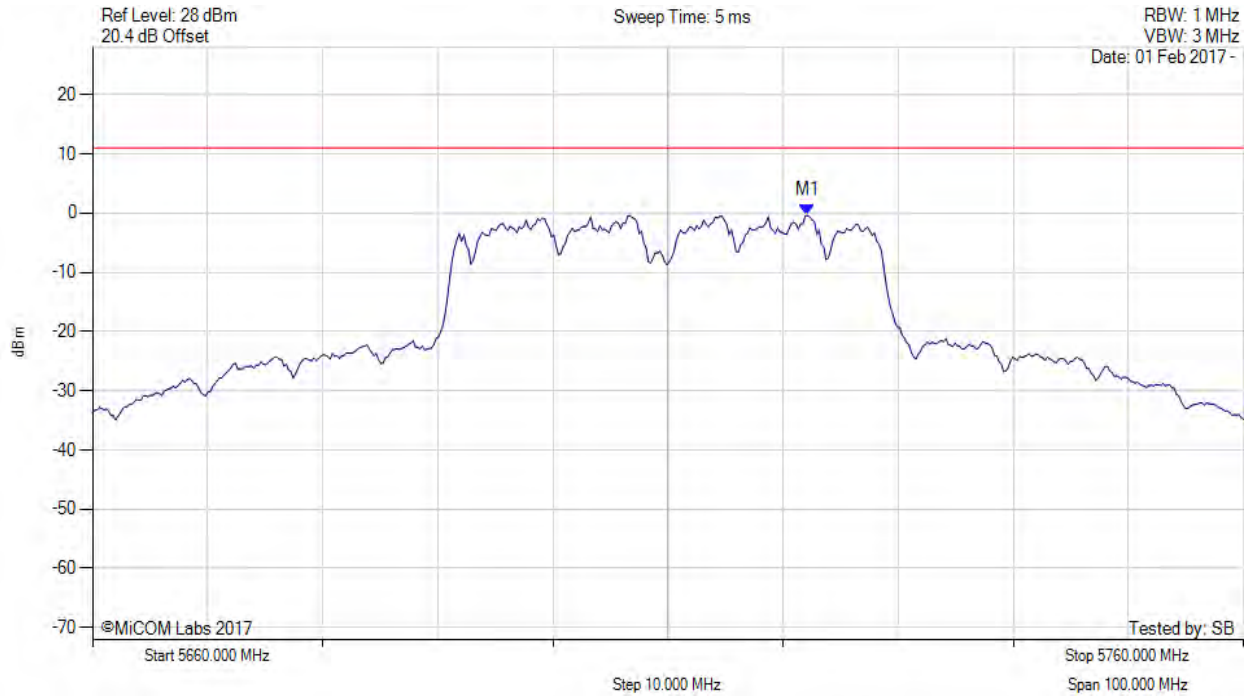

Analyzer Setup	Marker: Frequency: Amplitude	Test Results
Detector = RMS Sweep Count = 100 RF Atten (dB) = 20 Trace Mode = VIEWS	M1 : 5722.124 MHz : -0.410 dBm	Limit: $\leq 11.000$ dBm

[back to matrix](#)

This test report may be reproduced in full only. The document may only be updated by MiCOM Labs personnel. All changes will be noted in the Document History section of the report.



**Title:** Hewlett Packard Enterprise APINR203 & APINP203  
**To:** FCC CFR 47 Part 15 Subpart E 15.407  
**Serial #:** HPEN96-U12 Rev A (1x1) (Conducted & Radiated Data)  
**Issue Date:** 13th June 2017  
**Page:** 132 of 147

POWER SPECTRAL DENSITY



Variant: 802.11n HT-40, Channel: 5710.00 MHz, SUM, Temp: 20, Voltage: 110 Vac

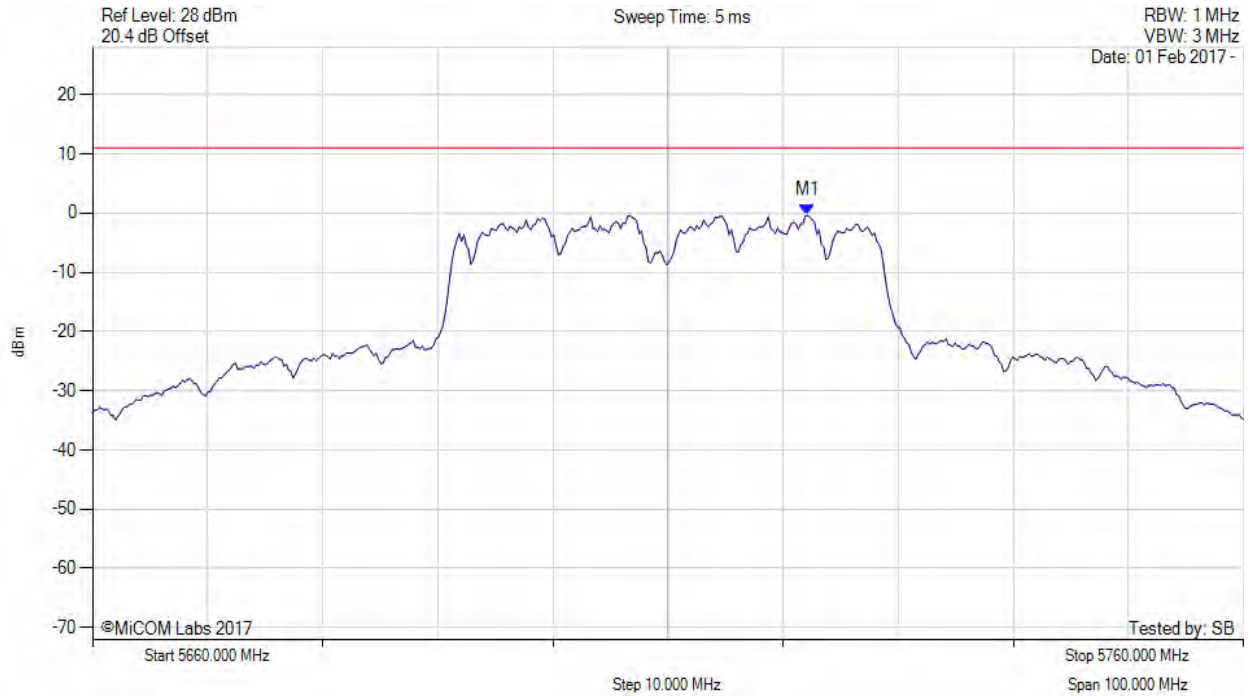

Analyzer Setup	Marker:Frequency:Amplitude	Test Results
Detector = RMS Sweep Count = 100 RF Atten (dB) = 20 Trace Mode = VIEW	M1 : 5722.100 MHz : -0.410 dBm M1 + DCCF : 5722.100 MHz : 0.058 dBm Duty Cycle Correction Factor : +0.46 dB	Limit: $\leq 11.0$ dBm Margin: -10.9 dB

[back to matrix](#)

This test report may be reproduced in full only. The document may only be updated by MiCOM Labs personnel. All changes will be noted in the Document History section of the report.





### A.3. Radiated

#### A.3.1. TX Spurious & Restricted Band Emissions

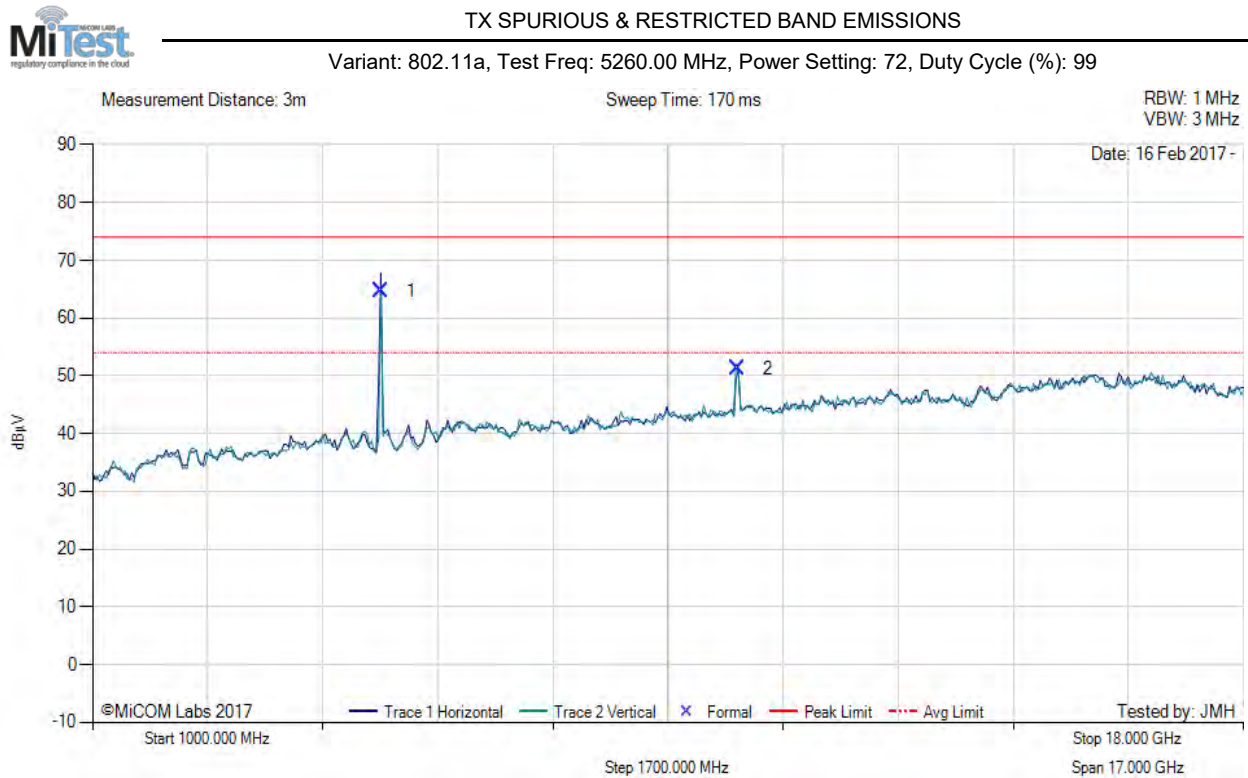

1000.00 - 18000.00 MHz												
Num	Frequency MHz	Raw dBµV	Cable Loss dB	AF dB	Level dBµV/m	Measurement Type	Pol	Hgt cm	Azt Deg	Limit dBµV/m	Margin dB	Pass /Fail
1	5261.44	72.32	3.66	-11.29	64.69	Fundamental	Horizontal	100	0	--	--	
2	10519.94	50.02	5.43	-4.21	51.24	Peak (NRB)	Vertical	151	7	--	--	Pass

**Test Notes:** APINP203 SN# CNCPK2T00L on 150cm table powered by AC.

[back to matrix](#)

This test report may be reproduced in full only. The document may only be updated by MiCOM Labs personnel. All changes will be noted in the Document History section of the report.





**Title:** Hewlett Packard Enterprise APINR203 & APINP203  
**To:** FCC CFR 47 Part 15 Subpart E 15.407  
**Serial #:** HPEN96-U12 Rev A (1x1) (Conducted & Radiated Data)  
**Issue Date:** 13th June 2017  
**Page:** 134 of 147



**TX SPURIOUS & RESTRICTED BAND EMISSIONS**

Variant: 802.11a, Test Freq: 5300.00 MHz, Power Setting: 72, Duty Cycle (%): 99

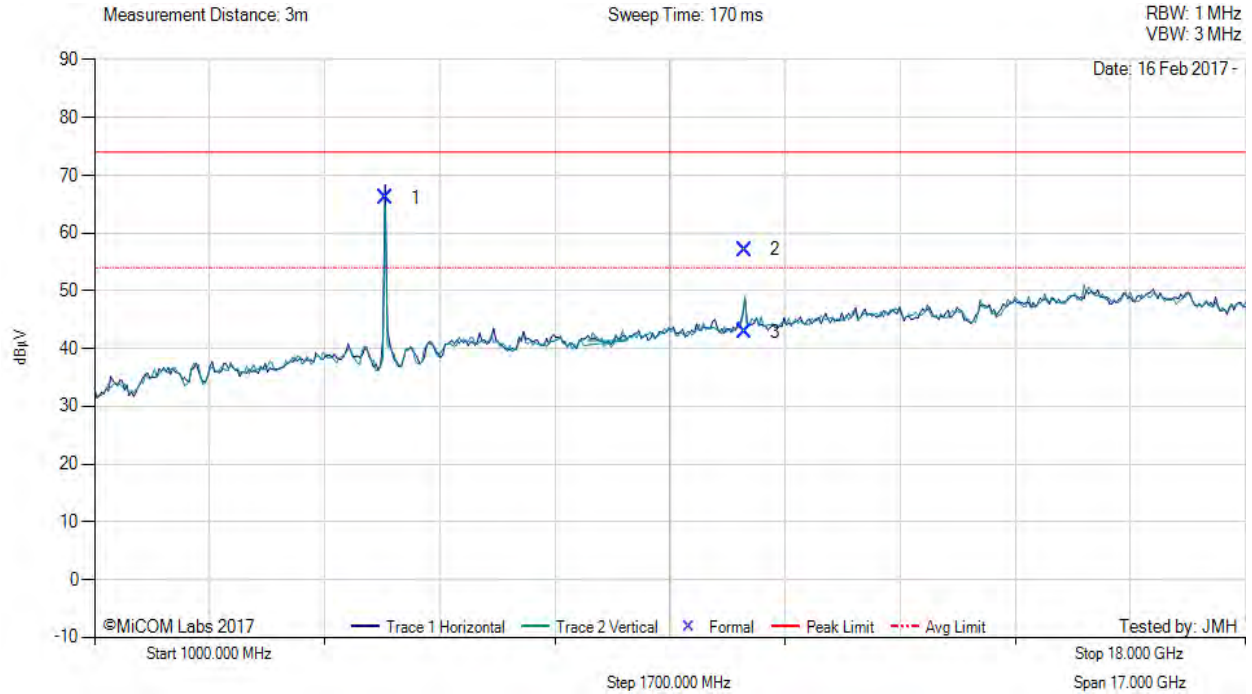

1000.00 - 18000.00 MHz												
Num	Frequency MHz	Raw dBµV	Cable Loss dB	AF dB	Level dBµV/m	Measurement Type	Pol	Hgt cm	Azt Deg	Limit dBµV/m	Margin dB	Pass /Fail
1	5295.84	73.38	3.79	-11.11	66.06	Fundamental	Horizontal	100	0	--	--	
2	10604.94	55.48	5.56	-3.92	57.12	Max Peak	Horizontal	185	193	74.0	-16.9	Pass
3	10604.94	41.15	5.56	-3.92	42.79	Max Avg	Horizontal	185	193	54.0	-11.2	Pass

**Test Notes:** APINP203 SN# CNCPK2T00L on 150cm table powered by AC.

[back to matrix](#)

This test report may be reproduced in full only. The document may only be updated by MiCOM Labs personnel. All changes will be noted in the Document History section of the report.



**Title:** Hewlett Packard Enterprise APINR203 & APINP203  
**To:** FCC CFR 47 Part 15 Subpart E 15.407  
**Serial #:** HPEN96-U12 Rev A (1x1) (Conducted & Radiated Data)  
**Issue Date:** 13th June 2017  
**Page:** 135 of 147



**TX SPURIOUS & RESTRICTED BAND EMISSIONS**

Variant: 802.11a, Test Freq: 5320.00 MHz, Power Setting: 72, Duty Cycle (%): 99

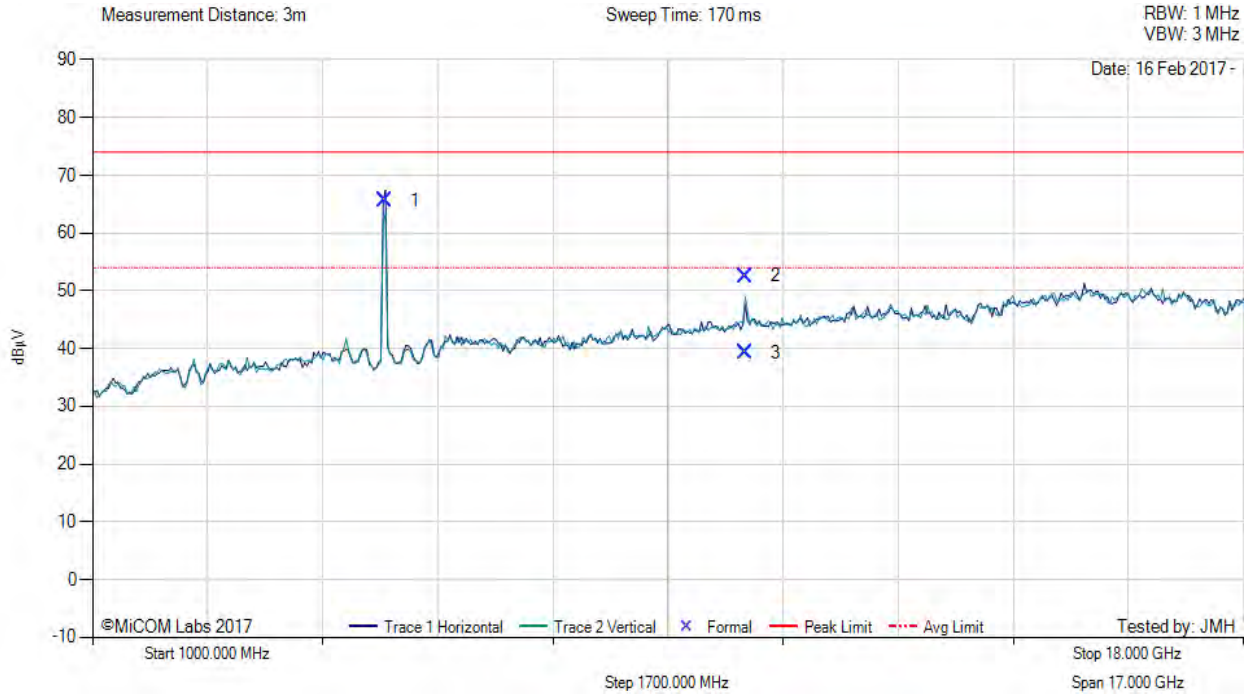

1000.00 - 18000.00 MHz												
Num	Frequency MHz	Raw dBµV	Cable Loss dB	AF dB	Level dBµV/m	Measurement Type	Pol	Hgt cm	Azt Deg	Limit dBµV/m	Margin dB	Pass /Fail
1	5323.73	72.98	3.74	-11.06	65.66	Fundamental	Horizontal	100	0	--	--	
2	10640.33	51.07	5.39	-3.89	52.57	Max Peak	Vertical	98	18	74.0	-21.4	Pass
3	10640.33	37.71	5.39	-3.89	39.21	Max Avg	Vertical	98	18	54.0	-14.8	Pass

**Test Notes:** APINP203 SN# CNCPK2T00L on 150cm table powered by AC.

[back to matrix](#)

This test report may be reproduced in full only. The document may only be updated by MiCOM Labs personnel. All changes will be noted in the Document History section of the report.



**Title:** Hewlett Packard Enterprise APINR203 & APINP203  
**To:** FCC CFR 47 Part 15 Subpart E 15.407  
**Serial #:** HPEN96-U12 Rev A (1x1) (Conducted & Radiated Data)  
**Issue Date:** 13th June 2017  
**Page:** 136 of 147



**TX SPURIOUS & RESTRICTED BAND EMISSIONS**

Variant: 802.11a, Test Freq: 5500.00 MHz, Power Setting: 72, Duty Cycle (%): 99

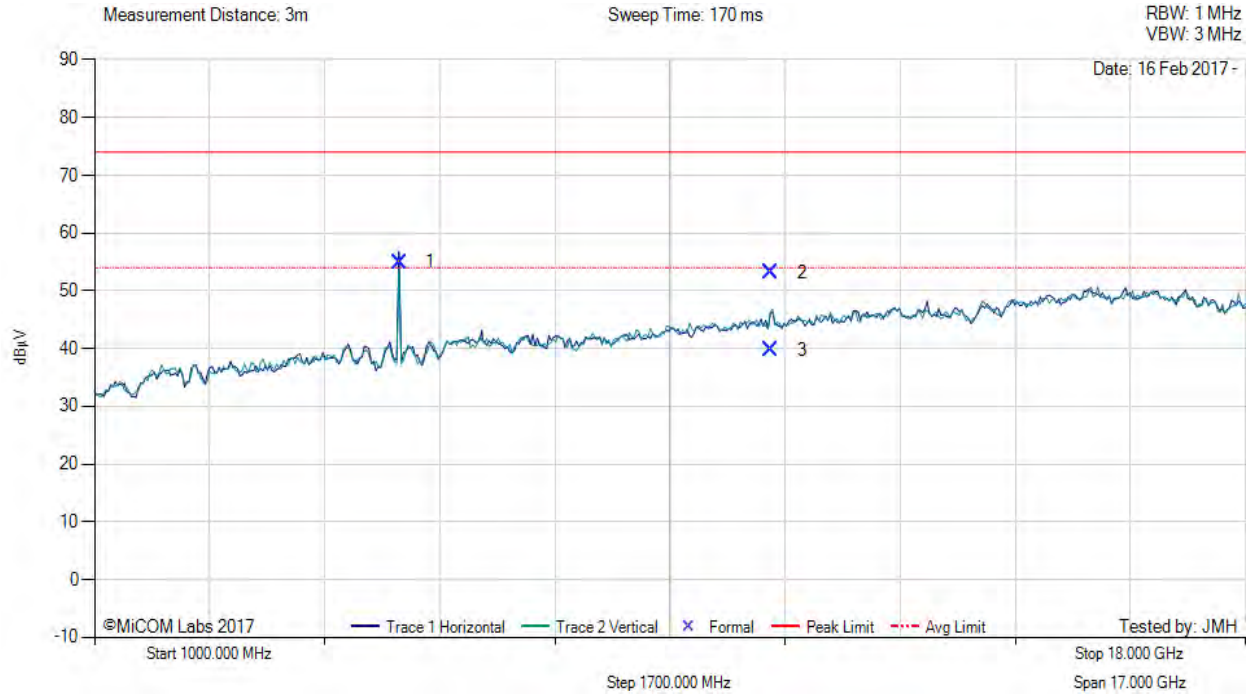

1000.00 - 18000.00 MHz												
Num	Frequency MHz	Raw dBµV	Cable Loss dB	AF dB	Level dBµV/m	Measurement Type	Pol	Hgt cm	Azt Deg	Limit dBµV/m	Margin dB	Pass /Fail
1	5504.21	62.41	3.75	-11.18	54.98	Fundamental	Horizontal	100	0	--	--	
2	10995.83	51.77	5.60	-4.26	53.11	Max Peak	Vertical	155	267	74.0	-20.9	Pass
3	10995.83	38.37	5.60	-4.26	39.71	Max Avg	Vertical	155	267	54.0	-14.3	Pass

**Test Notes:** APINP203 SN# CNCPK2T00L on 150cm table powered by AC.

[back to matrix](#)

This test report may be reproduced in full only. The document may only be updated by MiCOM Labs personnel. All changes will be noted in the Document History section of the report.



**Title:** Hewlett Packard Enterprise APINR203 & APINP203  
**To:** FCC CFR 47 Part 15 Subpart E 15.407  
**Serial #:** HPEN96-U12 Rev A (1x1) (Conducted & Radiated Data)  
**Issue Date:** 13th June 2017  
**Page:** 137 of 147



**TX SPURIOUS & RESTRICTED BAND EMISSIONS**

Variant: 802.11a, Test Freq: 5580.00 MHz, Power Setting: 72, Duty Cycle (%): 99

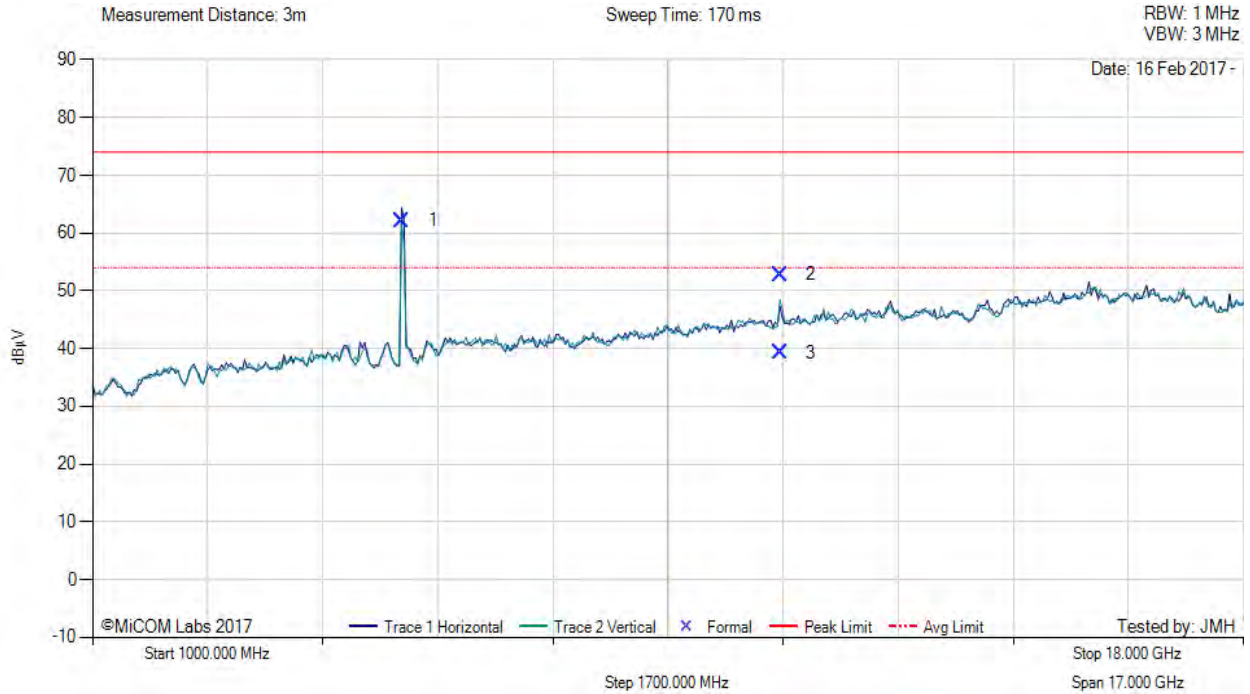

1000.00 - 18000.00 MHz												
Num	Frequency MHz	Raw dBµV	Cable Loss dB	AF dB	Level dBµV/m	Measurement Type	Pol	Hgt cm	Azt Deg	Limit dBµV/m	Margin dB	Pass /Fail
1	5576.21	69.56	3.81	-11.21	62.16	Fundamental	Horizontal	100	0	--	--	
2	11157.98	50.94	5.94	-4.06	52.82	Max Peak	Vertical	140	357	74.0	-21.2	Pass
3	11157.98	37.39	5.94	-4.06	39.27	Max Avg	Vertical	140	357	54.0	-14.7	Pass

**Test Notes:** APINP203 SN# CNCPK2T00L on 150cm table powered by AC.

[back to matrix](#)

This test report may be reproduced in full only. The document may only be updated by MiCOM Labs personnel. All changes will be noted in the Document History section of the report.



**Title:** Hewlett Packard Enterprise APINR203 & APINP203  
**To:** FCC CFR 47 Part 15 Subpart E 15.407  
**Serial #:** HPEN96-U12 Rev A (1x1) (Conducted & Radiated Data)  
**Issue Date:** 13th June 2017  
**Page:** 138 of 147



**TX SPURIOUS & RESTRICTED BAND EMISSIONS**

Variant: 802.11a, Test Freq: 5720.00 MHz, Power Setting: 72, Duty Cycle (%): 99

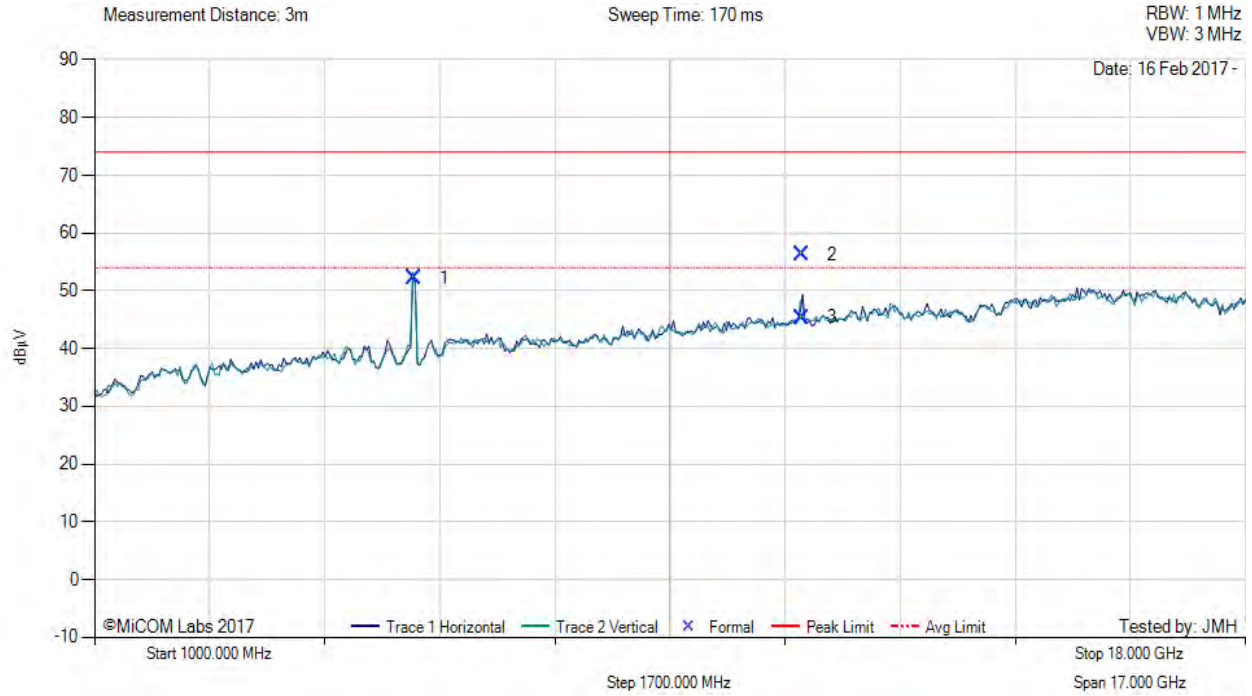

1000.00 - 18000.00 MHz												
Num	Frequency MHz	Raw dBµV	Cable Loss dB	AF dB	Level dBµV/m	Measurement Type	Pol	Hgt cm	Azt Deg	Limit dBµV/m	Margin dB	Pass /Fail
1	5715.24	59.08	3.81	-10.76	52.13	Fundamental	Vertical	100	0	--	--	
2	11439.80	55.80	5.35	-4.93	56.22	Max Peak	Horizontal	187	304	74.0	-17.8	Pass
3	11439.80	44.98	5.35	-4.93	45.40	Max Avg	Horizontal	187	304	54.0	-8.6	Pass

**Test Notes:** APINP203 SN# CNCPK2T00L on 150cm table powered by AC.

[back to matrix](#)

This test report may be reproduced in full only. The document may only be updated by MiCOM Labs personnel. All changes will be noted in the Document History section of the report.



### A.3.2. Restricted Edge & Band-Edge Emissions



#### RESTRICTED LOWER BAND-EDGE EMISSIONS

Variant: 802.11a, Test Freq: 5500.00 MHz, Antenna: HPE Metal Sheet, Power Setting: 65, Duty Cycle (%): 99

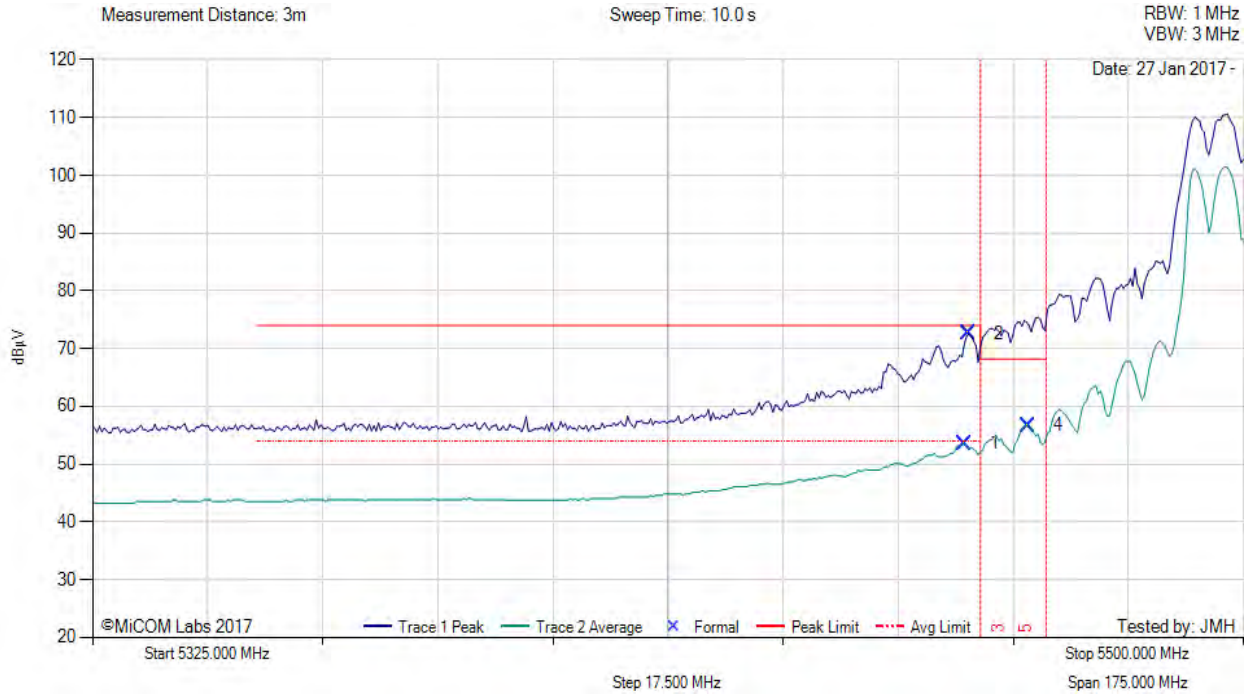

5325.00 - 5500.00 MHz												
Num	Frequency MHz	Raw dBµV	Cable Loss dB	AF dB	Level dBµV/m	Measurement Type	Pol	Hgt cm	Azt Deg	Limit dBµV/m	Margin dB	Pass /Fail
1	5457.55	15.49	3.80	34.30	53.59	Max Avg	Horizontal	184	351	54.0	-0.4	Pass
2	5458.25	34.54	3.80	34.30	72.64	Max Peak	Horizontal	184	351	74.0	-1.4	Pass
4	5467.19	18.58	3.77	34.31	56.66	Max Avg	Horizontal	184	351	68.2	-11.5	Pass
3	5460.00	--	--	--	--	Restricted-Band	--	--	--	--	--	--
5	5470.00	--	--	--	--	Band-Edge	--	--	--	--	--	--

**Test Notes:** UT APINP203 SN# CNCPK2T00L on 150cm table powered by AC. Power reduced to 65 to meet band edge limit.

[back to matrix](#)

This test report may be reproduced in full only. The document may only be updated by MiCOM Labs personnel. All changes will be noted in the Document History section of the report.





**Title:** Hewlett Packard Enterprise APINR203 & APINP203  
**To:** FCC CFR 47 Part 15 Subpart E 15.407  
**Serial #:** HPEN96-U12 Rev A (1x1) (Conducted & Radiated Data)  
**Issue Date:** 13th June 2017  
**Page:** 140 of 147



RESTRICTED LOWER BAND-EDGE EMISSIONS

Variant: 802.11ac-80, Test Freq: 5530.00 MHz, Antenna: HPE Metal Sheet, Power Setting: 57, Duty Cycle (%): 99



5350.00 - 5530.00 MHz												
Num	Frequency MHz	Raw dBµV	Cable Loss dB	AF dB	Level dBµV/m	Measurement Type	Pol	Hgt cm	Azt Deg	Limit dBµV/m	Margin dB	Pass /Fail
1	5457.47	15.58	3.80	34.30	53.68	Max Avg	Horizontal	184	351	54.0	-0.3	Pass
2	5457.84	32.96	3.80	34.30	71.06	Max Peak	Horizontal	184	351	74.0	-2.9	Pass
4	5467.47	16.77	3.77	34.31	54.85	Max Avg	Horizontal	184	351	68.2	-13.4	Pass
3	5460.00	--	--	--	--	Restricted-Band	--	--	--	--	--	--
5	5470.00	--	--	--	--	Band-Edge	--	--	--	--	--	--

**Test Notes:** UT APINP203 SN# CNCPK2T00L on 150cm table powered by AC. Power reduced to 57 to meet band edge limit.

[back to matrix](#)

This test report may be reproduced in full only. The document may only be updated by MiCOM Labs personnel. All changes will be noted in the Document History section of the report.



**Title:** Hewlett Packard Enterprise APINR203 & APINP203  
**To:** FCC CFR 47 Part 15 Subpart E 15.407  
**Serial #:** HPEN96-U12 Rev A (1x1) (Conducted & Radiated Data)  
**Issue Date:** 13th June 2017  
**Page:** 141 of 147



RESTRICTED LOWER BAND-EDGE EMISSIONS

Variant: 802.11n HT-20, Test Freq: 5500.00 MHz, Antenna: HPE Metal Sheet, Power Setting: 70, Duty Cycle (%): 99

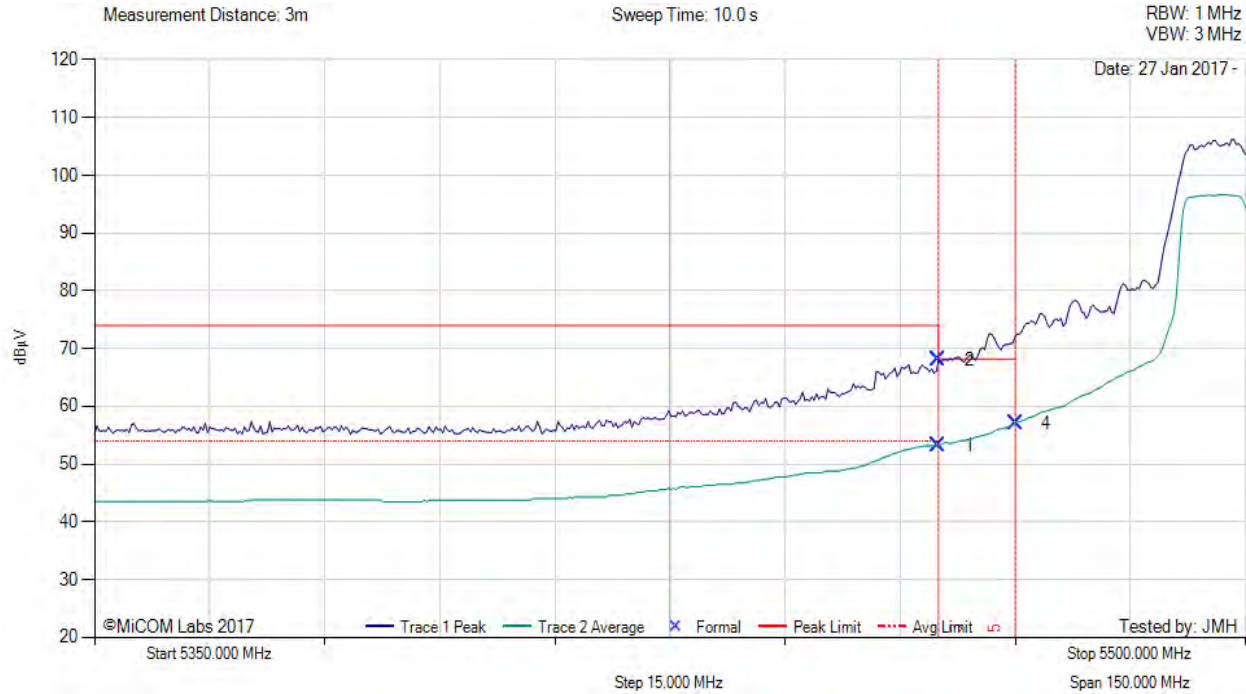

5350.00 - 5500.00 MHz												
Num	Frequency MHz	Raw dBµV	Cable Loss dB	AF dB	Level dBµV/m	Measurement Type	Pol	Hgt cm	Azt Deg	Limit dBµV/m	Margin dB	Pass /Fail
1	5460.00	15.10	3.79	34.31	53.20	Max Avg	Horizontal	184	351	54.0	-0.8	Pass
2	5460.00	29.90	3.79	34.31	68.00	Max Peak	Horizontal	184	351	74.0	-6.0	Pass
4	5470.00	19.04	3.76	34.32	57.12	Max Avg	Horizontal	184	351	68.2	-11.1	Pass
3	5460.00	--	--	--	--	Restricted-Band	--	--	--	--	--	--
5	5470.00	--	--	--	--	Band-Edge	--	--	--	--	--	--

**Test Notes:** UT APINP203 SN# CNCPK2T00L on 150cm table powered by AC. Power reduced to 70 to meet band edge limit.

[back to matrix](#)

This test report may be reproduced in full only. The document may only be updated by MiCOM Labs personnel. All changes will be noted in the Document History section of the report.





**Title:** Hewlett Packard Enterprise APINR203 & APINP203  
**To:** FCC CFR 47 Part 15 Subpart E 15.407  
**Serial #:** HPEN96-U12 Rev A (1x1) (Conducted & Radiated Data)  
**Issue Date:** 13th June 2017  
**Page:** 142 of 147



RESTRICTED LOWER BAND-EDGE EMISSIONS

Variant: 802.11n HT-40, Test Freq: 5510.00 MHz, Antenna: HPE Metal Sheet, Power Setting: 72, Duty Cycle (%): 99

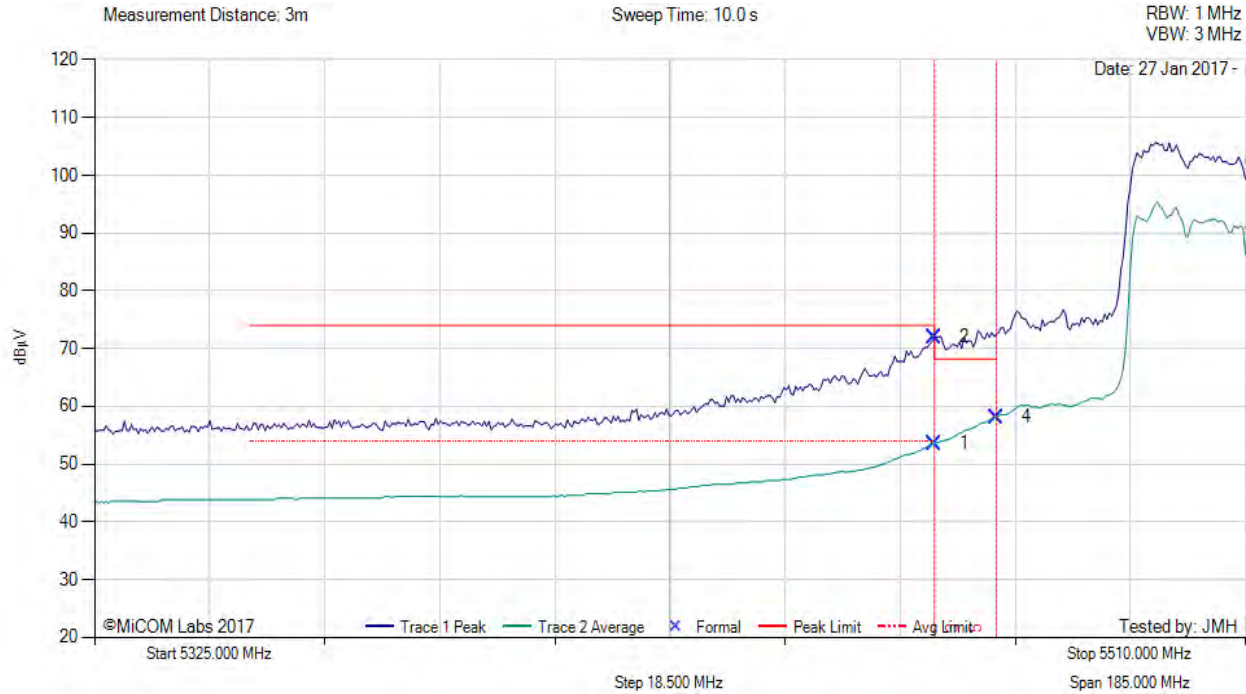

5325.00 - 5510.00 MHz												
Num	Frequency MHz	Raw dBµV	Cable Loss dB	AF dB	Level dBµV/m	Measurement Type	Pol	Hgt cm	Azt Deg	Limit dBµV/m	Margin dB	Pass /Fail
1	5460.00	15.49	3.79	34.31	53.59	Max Avg	Horizontal	184	351	54.0	-0.4	Pass
2	5460.00	33.93	3.79	34.31	72.03	Max Peak	Horizontal	184	351	74.0	-2.0	Pass
4	5470.00	20.07	3.76	34.32	58.15	Max Avg	Horizontal	184	351	68.2	-10.1	Pass
3	5460.00	--	--	--	--	Restricted-Band	--	--	--	--	--	--
5	5470.00	--	--	--	--	Band-Edge	--	--	--	--	--	--

**Test Notes:** EUT APINP203 SN# CNCPK2T00L on 150cm table powered by AC. Power reduced to 57 to meet band edge limit.

[back to matrix](#)

This test report may be reproduced in full only. The document may only be updated by MiCOM Labs personnel. All changes will be noted in the Document History section of the report.



**Title:** Hewlett Packard Enterprise APINR203 & APINP203  
**To:** FCC CFR 47 Part 15 Subpart E 15.407  
**Serial #:** HPEN96-U12 Rev A (1x1) (Conducted & Radiated Data)  
**Issue Date:** 13th June 2017  
**Page:** 143 of 147



RESTRICTED UPPER BAND-EDGE EMISSIONS

Variant: 802.11a, Test Freq: 5320.00 MHz, Antenna: HPE Metal Sheet, Power Setting: 63, Duty Cycle (%): 99

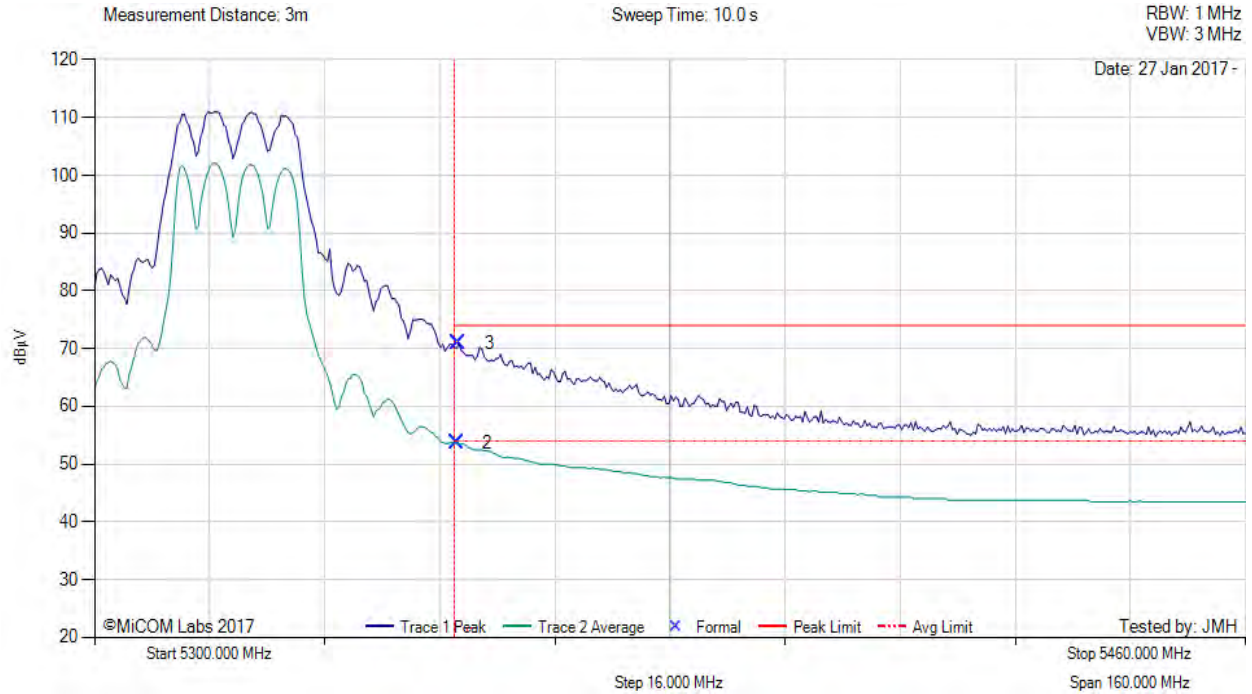

5300.00 - 5460.00 MHz												
Num	Frequency MHz	Raw dBµV	Cable Loss dB	AF dB	Level dBµV/m	Measurement Type	Pol	Hgt cm	Azt Deg	Limit dBµV/m	Margin dB	Pass /Fail
2	5350.32	15.47	3.70	34.51	53.68	Max Avg	Horizontal	187	351	54.0	-0.3	Pass
3	5350.64	32.65	3.71	34.51	70.87	Max Peak	Horizontal	187	351	74.0	-3.1	Pass
1	5350.00	--	--	--	--	Restricted-Band	--	--	--	--	--	--

**Test Notes:** UT APINP203 SN# CNCPK2T00L on 150cm table powered by AC. Power reduced to 63 to meet band edge limit.

[back to matrix](#)

This test report may be reproduced in full only. The document may only be updated by MiCOM Labs personnel. All changes will be noted in the Document History section of the report.



**Title:** Hewlett Packard Enterprise APINR203 & APINP203  
**To:** FCC CFR 47 Part 15 Subpart E 15.407  
**Serial #:** HPEN96-U12 Rev A (1x1) (Conducted & Radiated Data)  
**Issue Date:** 13th June 2017  
**Page:** 144 of 147



RESTRICTED UPPER BAND-EDGE EMISSIONS

Variant: 802.11ac-80, Test Freq: 5290.00 MHz, Antenna: HPE Metal Sheet, Power Setting: 56, Duty Cycle (%): 99

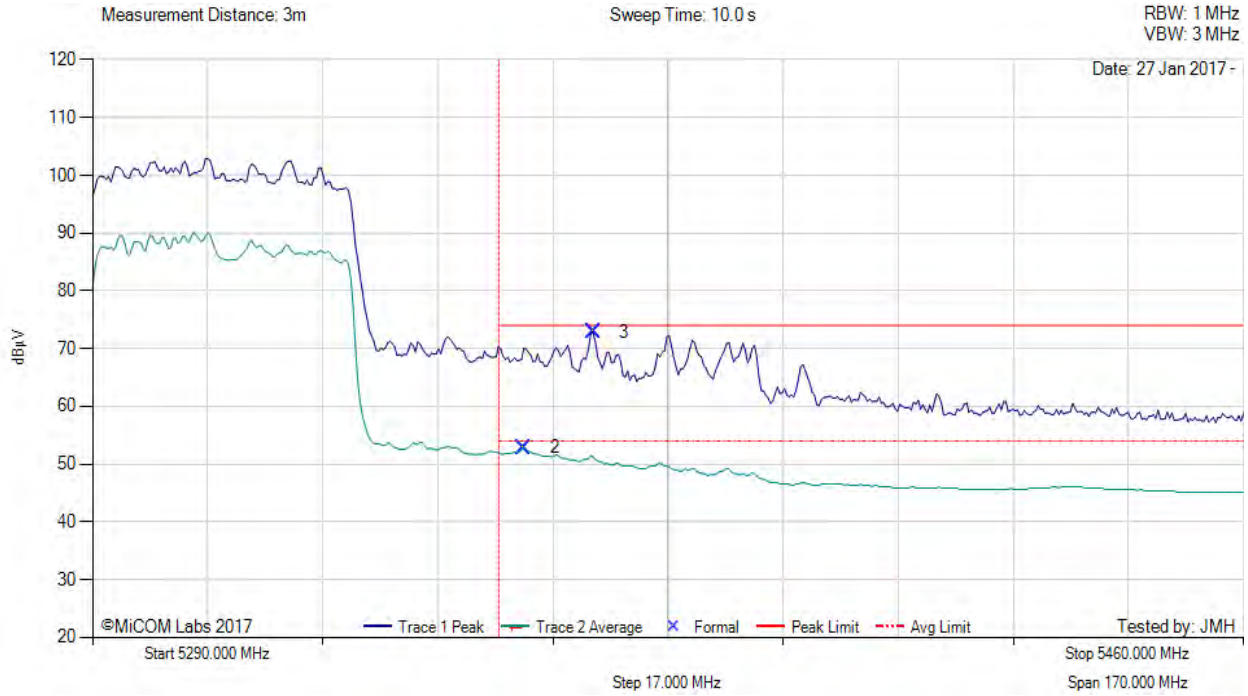

5290.00 - 5460.00 MHz												
Num	Frequency MHz	Raw dBµV	Cable Loss dB	AF dB	Level dBµV/m	Measurement Type	Pol	Hgt cm	Azt Deg	Limit dBµV/m	Margin dB	Pass /Fail
2	5353.75	14.66	3.71	34.50	52.87	Max Avg	Horizontal	187	351	54.0	-1.1	Pass
3	5363.97	34.67	3.70	34.48	72.85	Max Peak	Horizontal	187	351	74.0	-1.2	Pass
1	5350.00	--	--	--	--	Restricted-Band	--	--	--	--	--	--

**Test Notes:** UT APINP203 SN# CNCPK2T00L on 150cm table powered by AC. Power reduced to 54 to meet band edge limit.

[back to matrix](#)

This test report may be reproduced in full only. The document may only be updated by MiCOM Labs personnel. All changes will be noted in the Document History section of the report.



**Title:** Hewlett Packard Enterprise APINR203 & APINP203  
**To:** FCC CFR 47 Part 15 Subpart E 15.407  
**Serial #:** HPEN96-U12 Rev A (1x1) (Conducted & Radiated Data)  
**Issue Date:** 13th June 2017  
**Page:** 145 of 147



RESTRICTED UPPER BAND-EDGE EMISSIONS

Variant: 802.11n HT-20, Test Freq: 5320.00 MHz, Antenna: HPE Metal Sheet, Power Setting: 70, Duty Cycle (%): 99

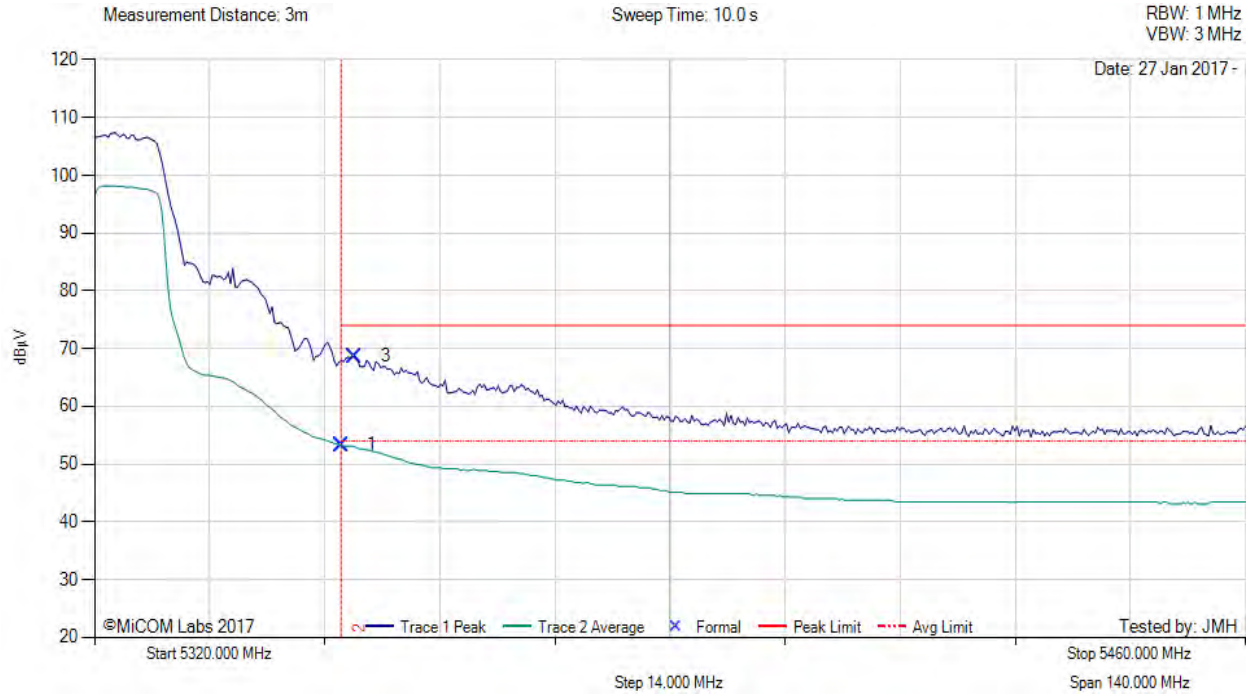

5320.00 - 5460.00 MHz												
Num	Frequency MHz	Raw dBµV	Cable Loss dB	AF dB	Level dBµV/m	Measurement Type	Pol	Hgt cm	Azt Deg	Limit dBµV/m	Margin dB	Pass /Fail
1	5350.00	15.08	3.70	34.51	53.29	Max Avg	Horizontal	187	351	54.0	-0.7	Pass
3	5351.68	30.48	3.71	34.51	68.70	Max Peak	Horizontal	187	351	74.0	-5.3	Pass
2	5350.00	--	--	--	--	Restricted-Band	--	--	--	--	--	--

**Test Notes:** UT APINP203 SN# CNCPK2T00L on 150cm table powered by AC. Power reduced to 70 to meet band edge limit.

[back to matrix](#)

This test report may be reproduced in full only. The document may only be updated by MiCOM Labs personnel. All changes will be noted in the Document History section of the report.



**Title:** Hewlett Packard Enterprise APINR203 & APINP203  
**To:** FCC CFR 47 Part 15 Subpart E 15.407  
**Serial #:** HPEN96-U12 Rev A (1x1) (Conducted & Radiated Data)  
**Issue Date:** 13th June 2017  
**Page:** 146 of 147



RESTRICTED UPPER BAND-EDGE EMISSIONS

Variant: 802.11n HT-40, Test Freq: 5310.00 MHz, Antenna: HPE Metal Sheet, Power Setting: 53, Duty Cycle (%): 99

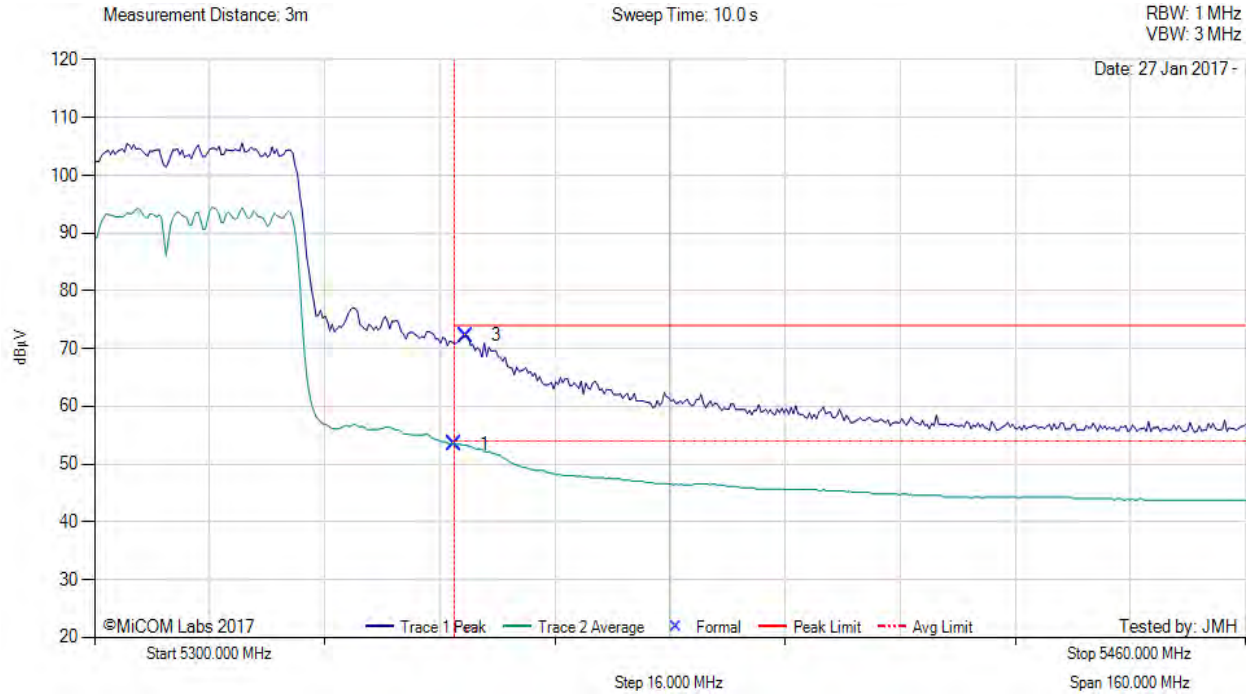

5300.00 - 5460.00 MHz												
Num	Frequency MHz	Raw dBµV	Cable Loss dB	AF dB	Level dBµV/m	Measurement Type	Pol	Hgt cm	Azt Deg	Limit dBµV/m	Margin dB	Pass /Fail
1	5350.00	15.27	3.70	34.51	53.48	Max Avg	Horizontal	187	351	54.0	-0.5	Pass
3	5351.60	34.08	3.71	34.51	72.30	Max Peak	Horizontal	187	351	74.0	-1.7	Pass
2	5350.00	--	--	--	--	Restricted-Band	--	--	--	--	--	--

**Test Notes:** UT APINP203 SN# CNCPK2T00L on 150cm table powered by AC. Power reduced to 53 to meet band edge limit.

[back to matrix](#)

This test report may be reproduced in full only. The document may only be updated by MiCOM Labs personnel. All changes will be noted in the Document History section of the report.



575 Boulder Court  
Pleasanton, California 94566, USA  
Tel: +1 (925) 462 0304  
Fax: +1 (925) 462 0306  
[www.micomlabs.com](http://www.micomlabs.com)