

Company: Hewlett Packard Enterprise

Test of: APINR203, APINP203

To: FCC CFR 47 Part 15 Subpart C 15.247 (DTS) & IC  
RSS-247

Report No.: HPEN96-U5\_Rev A (1x1)

**COMPLETE TEST REPORT**





Test of: Hewlett Packard Enterprise APINR203, APINP203

to

To: FCC CFR 47 Part 15 Subpart C 15.247 (DTS) & IC RSS-247

Test Report Serial No.: HPEN96-U5\_Rev A (1x1)

This report supersedes: NONE

Applicant: Hewlett Packard Enterprise  
3000 Hanover St.  
Palo Alto, California 94034  
USA

Product Function Wireless Access Point

Issue Date: 23<sup>rd</sup> March 2017

**This Test Report is Issued Under the Authority of:**

**MiCOM Labs, Inc.**  
575 Boulder Court  
Pleasanton California 94566  
USA  
Phone: +1 (925) 462-0304  
Fax: +1 (925) 462-0306  
[www.micomlabs.com](http://www.micomlabs.com)



**MiCOM Labs is an ISO 17025 Accredited Testing Laboratory**



## Table of Contents

<b>1. ACCREDITATION, LISTINGS &amp; RECOGNITION.....</b>	<b>4</b>
1.1. TESTING ACCREDITATION.....	4
1.2. RECOGNITION .....	5
1.3. PRODUCT CERTIFICATION .....	6
<b>2. DOCUMENT HISTORY .....</b>	<b>7</b>
<b>3. TEST RESULT CERTIFICATE.....</b>	<b>8</b>
<b>4. REFERENCES AND MEASUREMENT UNCERTAINTY .....</b>	<b>9</b>
4.1. Normative References .....	9
4.2. Test and Uncertainty Procedure .....	10
<b>5. PRODUCT DETAILS AND TEST CONFIGURATIONS.....</b>	<b>11</b>
5.1. Technical Details .....	11
5.2. Scope Of Test Program .....	12
5.3. Equipment Model(s) and Serial Number(s) .....	13
5.4. Antenna Details .....	13
5.5. Cabling and I/O Ports .....	13
5.6. Test Configurations.....	14
5.7. Equipment Modifications .....	14
5.8. Deviations from the Test Standard .....	14
<b>6. TEST SUMMARY .....</b>	<b>15</b>
<b>7. TEST EQUIPMENT CONFIGURATION(S) .....</b>	<b>16</b>
7.1. Conducted .....	16
7.2. Radiated Emissions - 3m Chamber.....	18
<b>8. MEASUREMENT AND PRESENTATION OF TEST DATA .....</b>	<b>21</b>
<b>9. TEST RESULTS .....</b>	<b>22</b>
9.1. 6 dB & 99% Bandwidth .....	22
9.2. Conducted Output Power .....	27
9.3. Power Spectral Density .....	33
9.4. Emissions .....	38
9.4.1. <i>Conducted Emissions</i> .....	38
9.4.1.1. Conducted Spurious Emissions .....	38
9.4.1.2. Conducted Band-Edge Emissions .....	43
9.4.2. <i>Radiated Emissions</i> .....	52
9.4.2.1. TX Spurious & Restricted Band Emissions .....	55
9.4.2.2. Restricted Edge & Band-Edge Emissions.....	58
<b>A. APPENDIX - GRAPHICAL IMAGES .....</b>	<b>67</b>
A.1. 6 dB & 99% Bandwidth .....	68
A.2. Power Spectral Density .....	80
A.3. Emissions .....	104
A.3.1. <i>Conducted Emissions</i> .....	104
A.3.1.1. Conducted Spurious Emissions .....	104
A.3.1.2. Conducted Band-Edge Emissions .....	116
A.3.2. <i>Radiated Emissions</i> .....	124
A.3.2.1. TX Spurious & Restricted Band Emissions.....	124
A.3.2.2. Restricted Edge & Band-Edge Emissions .....	127

---

This test report may be reproduced in full only. The document may only be updated by MiCOM Labs personnel. All changes will be noted in the Document History section of the report.

## 1. ACCREDITATION, LISTINGS & RECOGNITION

### 1.1. TESTING ACCREDITATION

MiCOM Labs, Inc. is an accredited Electrical testing laboratory per the international standard ISO/IEC 17025:2005. The company is accredited by the American Association for Laboratory Accreditation (A2LA) [www.a2la.org](http://www.a2la.org) test laboratory number 2381.01. MiCOM Labs test schedule is available at the following URL; <http://www.a2la.org/scopepdf/2381-01.pdf>



### Accredited Laboratory

A2LA has accredited

**MICOM LABS**

Pleasanton, CA

for technical competence in the field of

**Electrical Testing**

This laboratory is accredited in accordance with the recognized International Standard ISO/IEC 17025:2005 General requirements for the competence of testing and calibration laboratories. This accreditation demonstrates technical competence for a defined scope and the operation of a laboratory quality management system (refer to joint ISO-ILAC-IAF Communiqué dated 8 January 2009).



Presented this 4<sup>th</sup> day of February 2016.

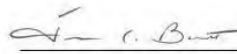

Senior Director of Quality & Communications  
For the Accreditation Council  
Certificate Number 2381.01  
Valid to November 30, 2017

For the tests or types of tests to which this accreditation applies, please refer to the laboratory's Electrical Scope of Accreditation.

This test report may be reproduced in full only. The document may only be updated by MiCOM Labs personnel. All changes will be noted in the Document History section of the report.



**Title:** Hewlett Packard Enterprise APINR203, APINP203  
**To:** FCC CFR 47 Part 15 Subpart C 15.247 (DTS)  
**Serial #:** HPEN96-U5\_Rev A (1x1)  
**Issue Date:** 23<sup>rd</sup> March 2017  
**Page:** 5 of 135

## 1.2. RECOGNITION

MiCOM Labs, Inc has widely recognized wireless testing capabilities. Our international recognition includes Conformity Assessment Body designation by APEC MRA countries. MiCOM Labs test reports are accepted globally.

Country	Recognition Body	Status	Phase	Identification No.
USA	Federal Communications Commission (FCC)	TCB	-	US0159 Listing #: 102167
Canada	Industry Canada (IC)	FCB	APEC MRA 2	US0159 Listing #: 4143A-2 4143A-3
Japan	MIC (Ministry of Internal Affairs and Communication)	CAB	APEC MRA 2	RCB 210
	VCCI	--	--	A-0012
Europe	European Commission	NB	EU MRA	NB 2280
Australia	Australian Communications and Media Authority (ACMA)	CAB	APEC MRA 1	US0159
Hong Kong	Office of the Telecommunication Authority (OFTA)	CAB	APEC MRA 1	
Korea	Ministry of Information and Communication Radio Research Laboratory (RRL)	CAB	APEC MRA 1	
Singapore	Infocomm Development Authority (IDA)	CAB	APEC MRA 1	
Taiwan	National Communications Commission (NCC) Bureau of Standards, Metrology and Inspection (BSMI)	CAB	APEC MRA 1	
Vietnam	Ministry of Communication (MIC)	CAB	APEC MRA 1	

EU MRA – European Union Mutual Recognition Agreement.

NB – Notified Body

APEC MRA – Asia Pacific Economic Community Mutual Recognition Agreement. Recognition agreement under which test lab is accredited to regulatory standards of the APEC member countries.

Phase I - recognition for product testing

Phase II – recognition for both product testing and certification

This test report may be reproduced in full only. The document may only be updated by MiCOM Labs personnel. All changes will be noted in the Document History section of the report.

### 1.3. PRODUCT CERTIFICATION

MiCOM Labs, Inc. is an accredited Product Certification Body per the international standard ISO/IEC 17065:2012. The company is accredited by the American Association for Laboratory Accreditation (A2LA) [www.a2la.org](http://www.a2la.org) test laboratory number 2381.02. MiCOM Labs test schedule is available at the following URL; <http://www.a2la.org/scopepdf/2381-02.pdf>



## Accredited Product Certification Body

A2LA has accredited

**MICOM LABS**

Pleasanton, CA

This product certification body is accredited in accordance with the recognized International Standard ISO/IEC 17065:2012 *Requirements for bodies certifying products, processes and services*. This accreditation demonstrates technical competence for a defined scope and the operation of a management system.



Presented this 4<sup>th</sup> day of February 2016.

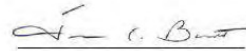

Senior Director of Quality & Communications  
For the Accreditation Council  
Certificate Number 2381.02  
Valid to November 30, 2017

*For the product certification schemes to which this accreditation applies, please refer to the organization's Product Certification Scope of Accreditation.*

United States of America – Telecommunication Certification Body (TCB)  
Industry Canada – Certification Body, CAB Identifier – US0159  
Europe – Notified Body (NB), NB Identifier - 2280  
Japan – Recognized Certification Body (RCB), RCB Identifier - 210

This test report may be reproduced in full only. The document may only be updated by MiCOM Labs personnel. All changes will be noted in the Document History section of the report.



**Title:** Hewlett Packard Enterprise APINR203, APINP203  
**To:** FCC CFR 47 Part 15 Subpart C 15.247 (DTS)  
**Serial #:** HPEN96-U5\_Rev A (1x1)  
**Issue Date:** 23<sup>rd</sup> March 2017  
**Page:** 7 of 135

---

## 2. DOCUMENT HISTORY

Document History		
Revision	Date	Comments
Draft	27 <sup>th</sup> February 2017	
Rev A	23 <sup>rd</sup> March 2017	Initial Release
.		
.		
.		
.		
.		

In the above table the latest report revision will replace all earlier versions.

---

This test report may be reproduced in full only. The document may only be updated by MiCOM Labs personnel. All changes will be noted in the Document History section of the report.



**Title:** Hewlett Packard Enterprise APINR203, APINP203  
**To:** FCC CFR 47 Part 15 Subpart C 15.247 (DTS)  
**Serial #:** HPEN96-U5\_Rev A (1x1)  
**Issue Date:** 23<sup>rd</sup> March 2017  
**Page:** 8 of 135

### 3. TEST RESULT CERTIFICATE

<b>Manufacturer:</b> Hewlett Packard Enterprise 3000 Hanover St. Palo Alto California 94034 USA	<b>Tested By:</b> MiCOM Labs, Inc. 575 Boulder Court Pleasanton California 94566 USA
<b>Model:</b> APINR203, APINP203	<b>Telephone:</b> +1 925 462 0304 <b>Fax:</b> +1 925 462 0306
<b>Type Of Equipment:</b> Wireless Access Point	
<b>S/N's:</b> CNCPK2T006, CNCPK2T00L	
<b>Test Date(s):</b> 26th January 2017 – 22nd February 2017	<b>Website:</b> www.micomlabs.com

STANDARD(S)	TEST RESULTS
FCC CFR 47 Part 15 Subpart C 15.247 (DTS) & IC RSS-247	EQUIPMENT COMPLIES

MiCOM Labs, Inc. tested the equipment mentioned in accordance with the requirements set forth in the above standards. Test results indicate that the equipment tested is capable of demonstrating compliance with the requirements as documented within this report.

**Notes:**

1. This document reports conditions under which testing was conducted and the results of testing performed.
2. Details of test methods used have been recorded and kept on file by the laboratory.
3. Test results apply only to the item(s) tested.

**Approved & Released for MiCOM Labs, Inc. by:**

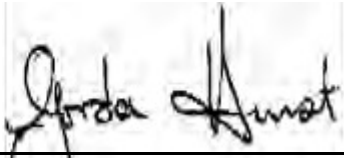

  
 \_\_\_\_\_  
 Graeme Grieve  
 Quality Manager MiCOM Labs, Inc.

  
 \_\_\_\_\_  
 Gordon Hurst  
 President & CEO MiCOM Labs, Inc.

This test report may be reproduced in full only. The document may only be updated by MiCOM Labs personnel. All changes will be noted in the Document History section of the report.



## 4. REFERENCES AND MEASUREMENT UNCERTAINTY

### 4.1. Normative References

REF.	PUBLICATION	YEAR	TITLE
I	KDB 662911 D01 & D02	Oct 31 2013	Guidance for measurement of output emission of devices that employ single transmitter with multiple outputs or systems with multiple transmitters operating simultaneously in the same frequency band
II	KDB 558074 D01 v03r05	8th April 2016	Guidance for performing compliance measurements on Digital Transmission Systems (DTS) operating under section 15.247.
III	A2LA	June 2015	R105 - Requirement's When Making Reference to A2LA Accreditation Status
IV	ANSI C63.10	2013	American National Standard for Testing Unlicensed Wireless Devices
V	ANSI C63.4	2014	American National Standards for Methods of Measurement of Radio-Noise Emissions from Low-Voltage Electrical and Electronic Equipment in the Range of 9 kHz to 40 GHz
VI	CISPR 22	2008	Information technology equipment - Radio disturbance characteristics - Limits and methods of measurement
VII	ETSI TR 100 028	2001-12	Parts 1 and 2 Electromagnetic compatibility and Radio Spectrum Matters (ERM); Uncertainties in the measurement of mobile radio equipment characteristics
VIII	FCC 47 CFR Part 15.247	2016	Radio Frequency Devices; Subpart C – Intentional Radiators
IX	ICES-003	Issue 6 Jan 2016	Spectrum Management and Telecommunications; Interference-Causing Equipment Standard. Information Technology Equipment (Including Digital Apparatus) – Limits and methods of measurement.
X	M 3003	Edition 3 Nov.2012	Expression of Uncertainty and Confidence in Measurements
XI	RSS-247 Issue 2	Feb 2017	Digital Transmission Systems (DTSs), Frequency Hopping System (FHSs) and License-Exempt Local Area Network (LE-LEN) Devices
XII	RSS-Gen Issue 4	November 2014	General Requirements and Information for the Certification of Radio communication Equipment
XIII	KDB 644545 D03 v01	August 14th 2014	Guidance for IEEE 802.11ac New Rules
XIV	FCC 47 CFR Part 2.1033	2016	FCC requirements and rules regarding photographs and test setup diagrams.

This test report may be reproduced in full only. The document may only be updated by MiCOM Labs personnel. All changes will be noted in the Document History section of the report.



**Title:** Hewlett Packard Enterprise APINR203, APINP203  
**To:** FCC CFR 47 Part 15 Subpart C 15.247 (DTS)  
**Serial #:** HPEN96-U5\_Rev A (1x1)  
**Issue Date:** 23<sup>rd</sup> March 2017  
**Page:** 10 of 135

---

#### **4.2. Test and Uncertainty Procedure**

Conducted and radiated emission measurements were conducted in accordance with American National Standards Institute ANSI C63.4, listed in the Normative References section of this report.

Measurement uncertainty figures are calculated in accordance with ETSI TR 100 028 Parts 1 and 2.

Measurement uncertainties stated are based on a standard uncertainty multiplied by a coverage factor  $k = 2$ , providing a level of confidence of approximately 95 % in accordance with UKAS document M 3003 listed in the Normative References section of this report.

---

This test report may be reproduced in full only. The document may only be updated by MiCOM Labs personnel. All changes will be noted in the Document History section of the report.



**Title:** Hewlett Packard Enterprise APINR203, APINP203  
**To:** FCC CFR 47 Part 15 Subpart C 15.247 (DTS)  
**Serial #:** HPEN96-U5\_Rev A (1x1)  
**Issue Date:** 23<sup>rd</sup> March 2017  
**Page:** 11 of 135

## 5. PRODUCT DETAILS AND TEST CONFIGURATIONS

### 5.1. Technical Details

Details	Description
Purpose:	Test of the Hewlett Packard Enterprise Millstone (1x1 mode) to FCC CFR 47 Part 15 Subpart C 15.247 (DTS) & IC RSS-247. Radio Frequency Devices; Subpart C – Intentional Radiators
Applicant:	Hewlett Packard Enterprise 3000 Hanover St. Palo Alto California 94034 USA
Manufacturer:	Hewlett Packard Enterprise
Laboratory performing the tests:	MiCOM Labs, Inc. 575 Boulder Court Pleasanton California 94566 USA
Test report reference number:	HPEN96-U2_Draft (1x1)
Date EUT received:	23 <sup>rd</sup> January 2017
Standard(s) applied:	FCC CFR 47 Part 15 Subpart C 15.247 (DTS) & IC RSS-247
Dates of test (from - to):	26 <sup>th</sup> January 2017 - 2 <sup>nd</sup> February 2017
No of Units Tested:	2
Product Family Name:	Access Point
Model(s):	APINR203 / APINP203
Location for use:	Indoors
Declared Frequency Range(s):	2400 - 2483.5 MHz;
Type of Modulation:	OFDM
EUT Modes of Operation:	802.11b, 802.11g, 802.11n HT20, 802.11n HT40
Declared Nominal Output Power (dBm):	+30 dBm
Transmit/Receive Operation:	Transceiver - Full Duplex
Rated Input Voltage and Current:	Ac 100-240V, AP203R: 0.3A, AP203RP: 0.6A
Operating Temperature Range:	Nominal: 20 °C      Max: 40 °C      Min: 0 °C
ITU Emission Designator:	802.11b: 12M0G1D 802.11g: 16M5D1D 802.11n - HT20: 17M6D1D 802.11n - HT40: 35M6D1D
Equipment Dimensions:	155mm x 50mm x 95mm [CLIENT INFO REQUIRED]
Weight:	0.320 kg (AP-203R) & 0.340 kg (AP-203RP)
Hardware Rev:	1
Software Rev:	WNC RF Load Rev. 1.0

This test report may be reproduced in full only. The document may only be updated by MiCOM Labs personnel. All changes will be noted in the Document History section of the report.

## 5.2. Scope Of Test Program

### Hewlett Packard Enterprise APINR203 / APINP203

The scope of the test program was to test the Hewlett Packard Enterprise APINR203 / APINP203, configurations in the frequency ranges 2400 - 2483.5 MHz in 1x1 antenna mode; for compliance against the following specification:

**FCC CFR 47 Part 15 Subpart C 15.247 (DTS) & IC RSS-247**  
Radio Frequency Devices; Subpart C – Intentional Radiators

### Hewlett Packard Enterprise APINR203 / APINP203

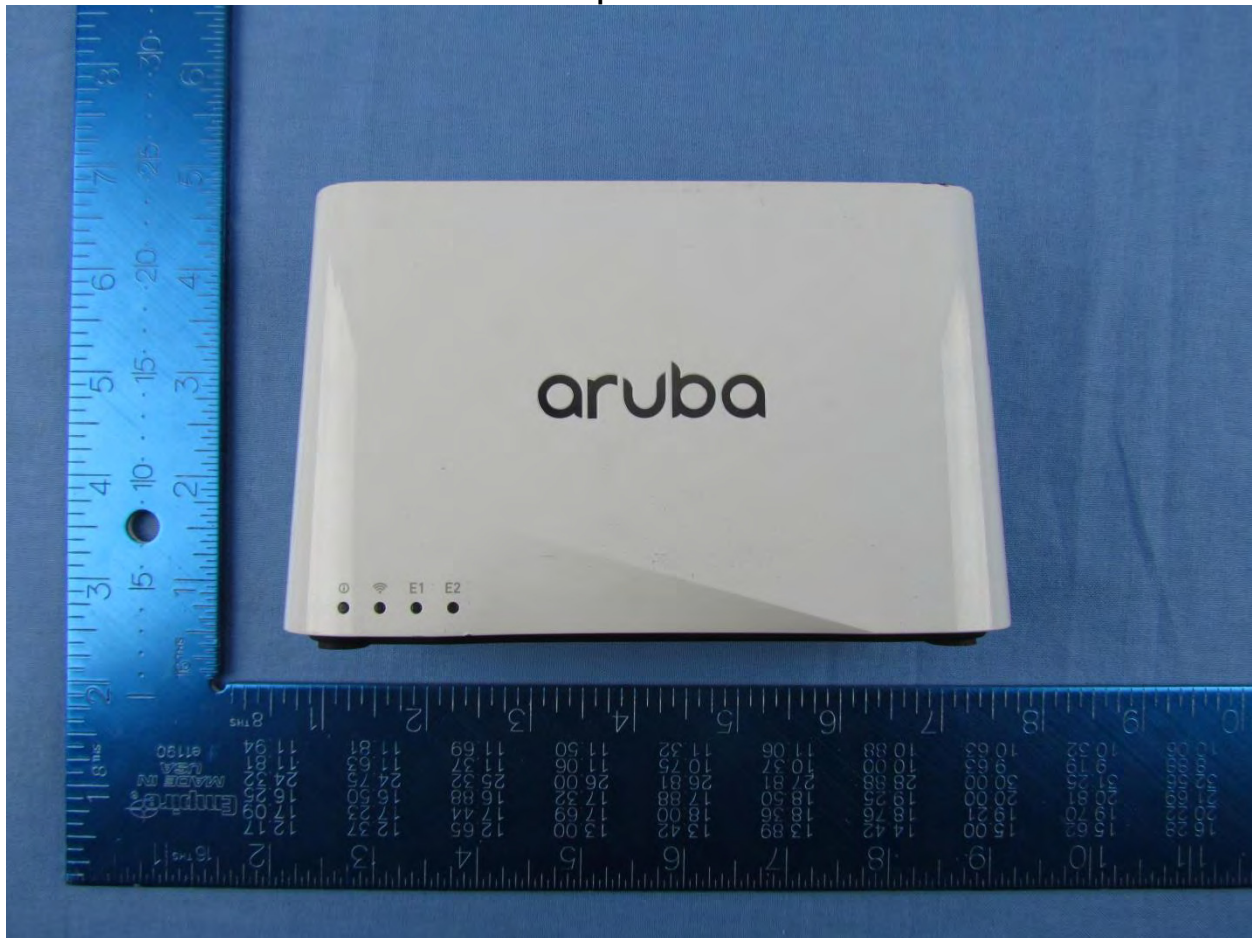

---

This test report may be reproduced in full only. The document may only be updated by MiCOM Labs personnel. All changes will be noted in the Document History section of the report.



**Title:** Hewlett Packard Enterprise APINR203, APINP203  
**To:** FCC CFR 47 Part 15 Subpart C 15.247 (DTS)  
**Serial #:** HPEN96-U5\_Rev A (1x1)  
**Issue Date:** 23<sup>rd</sup> March 2017  
**Page:** 13 of 135

### 5.3. Equipment Model(s) and Serial Number(s)

Type (EUT/Support)	Equipment Description (Including Brand Name)	Mfr	Model No.	Serial No.
EUT	802.11a/b/g/n	Hewlett Packard Enterprises	APINP203	CNCPK2T006
EUT	802.11a/b/g/n	Hewlett Packard Enterprises	APINP203	CNCPK2T00L
Support	Laptop PC	Dell	E5550	None

### 5.4. Antenna Details

Type	Manufacturer	Model	Family	Gain (dBi)	BF Gain	Dir BW	X-Pol	Frequency Band (MHz)
integral	HPE	Metal Sheet	5	1.0	-	360	-	2400 - 2483.5
integral	HPE	Metal Sheet	5	1.0	-	360	-	2400 - 2483.5
integral	HPE	Metal Sheet	5	2.9	-	360	-	5150 - 5850

BF Gain - Beamforming Gain  
Dir BW - Directional BeamWidth  
X-Pol - Cross Polarization

### 5.5. Cabling and I/O Ports

Port Type	Max Cable Length	# Of Ports	Screened	Conn Type	Data Type
Ethernet	100	3	N	RJ45	Packet Data
AC Input	N/A	1	N	AC Wire	--
USB	Configuration	1	No	Micro USB	Data
USB	Mgmt only	1	No	USB	Data

This test report may be reproduced in full only. The document may only be updated by MiCOM Labs personnel. All changes will be noted in the Document History section of the report.



**Title:** Hewlett Packard Enterprise APINR203, APINP203  
**To:** FCC CFR 47 Part 15 Subpart C 15.247 (DTS)  
**Serial #:** HPEN96-U5\_Rev A (1x1)  
**Issue Date:** 23<sup>rd</sup> March 2017  
**Page:** 14 of 135

---

## 5.6. Test Configurations

Results for the following configurations are provided in this report:

Operational Mode(s) (802.11a/b/g/n/ac)	Data Rate with Highest Power MBit/s	Channel Frequency (MHz)		
		Low	Mid	High
802.11b	1 Mbit/s	2412	2437	2462
802.11g	6 Mbit/s	2412	2437	2462
802.11n HT20	6.5 Mbit/s	2412	2437	2462
802.11n HT40	13.5 Mbit/s	2422	2437	2452

## 5.7. Equipment Modifications

The following modifications were required to bring the equipment into compliance:

1. NONE

## 5.8. Deviations from the Test Standard

The following deviations from the test standard were required in order to complete the test program:

1. NONE

---

This test report may be reproduced in full only. The document may only be updated by MiCOM Labs personnel. All changes will be noted in the Document History section of the report.



**Title:** Hewlett Packard Enterprise APINR203, APINP203  
**To:** FCC CFR 47 Part 15 Subpart C 15.247 (DTS)  
**Serial #:** HPEN96-U5\_Rev A (1x1)  
**Issue Date:** 23<sup>rd</sup> March 2017  
**Page:** 15 of 135

---

## 6. TEST SUMMARY

### List of Measurements

Test Header	Result	Data Link
6 dB & 99% Bandwidth	Complies	<a href="#">View Data</a>
Conducted Output Power	Complies	<a href="#">View Data</a>
Power Spectral Density	Complies	<a href="#">View Data</a>
Emissions	Complies	-
(1) Conducted Emissions	Complies	-
(i) Conducted Spurious Emissions	Complies	<a href="#">View Data</a>
(ii) Conducted Band-Edge Emissions	Complies	<a href="#">View Data</a>
(2) Radiated Emissions	Complies	-
(i) TX Spurious & Restricted Band Emissions	Not Tested	<a href="#">View Data</a>
(ii) Restricted Edge & Band-Edge Emissions	Complies	<a href="#">View Data</a>

---

This test report may be reproduced in full only. The document may only be updated by MiCOM Labs personnel. All changes will be noted in the Document History section of the report.

## 7. TEST EQUIPMENT CONFIGURATION(S)

### 7.1. Conducted

Conducted RF Emission Test Set-up(s) The following tests were performed using the conducted test set-up shown in the diagram below.

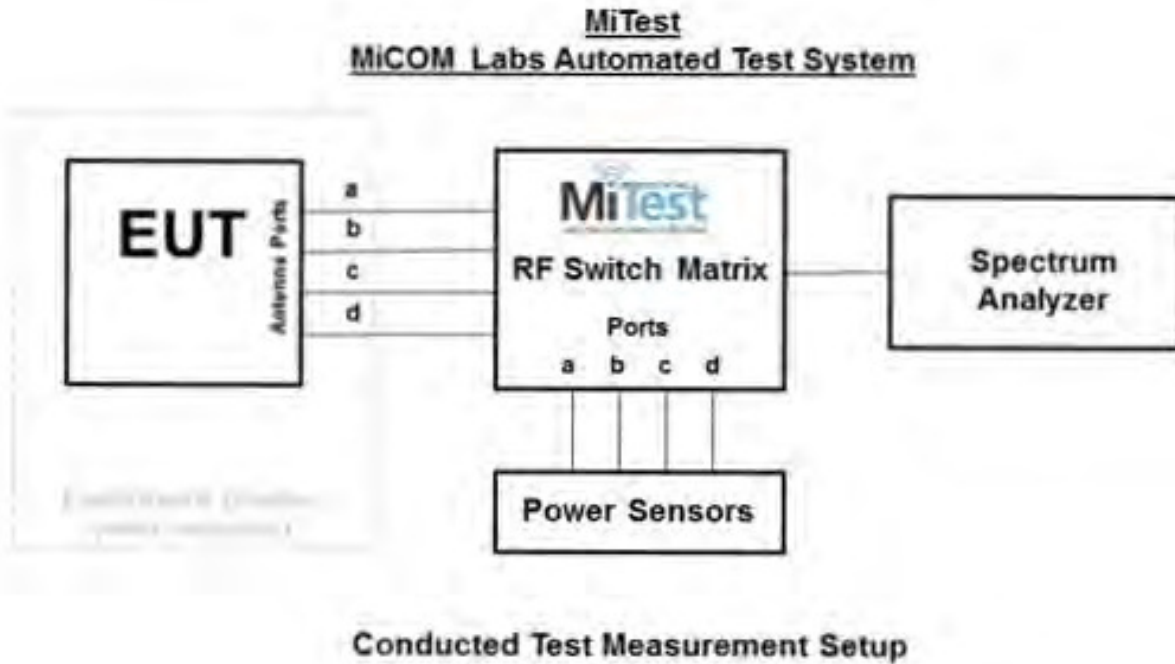

A full system calibration was performed on the test station and any resulting system losses (or gains) were taken into account in the production of all final measurement data.

Asset#	Description	Manufacturer	Model#	Serial#	Calibration Due Date
#3 SA	MiTest Box to SA	Fairview Microwave	SCA1814-0101-72	#3 SA	2 Jun 2017
#3P1	EUT to MiTest box port 1	Fairview Microwave	SCA1814-0101-72	#3P1	2 Jun 2017
#3P2	EUT to MiTest box port 2	Fairview Microwave	SCA1814-0101-72	#3P2	2 Jun 2017
#3P3	EUT to MiTest box port 3	Fairview Microwave	SCA1814-0101-72	#3P3	2 Jun 2017
#3P4	EUT to MiTest box port 4	Fairview Microwave	SCA1812-0101-72	#3P4	2 Jun 2017
158	Barometer/Thermometer	Control Company	4196	E2846	30 Nov 2017
249	Resistance Thermometer	Thermotronics	GR2105-02	9340 #2	23 Oct 2017

This test report may be reproduced in full only. The document may only be updated by MiCOM Labs personnel. All changes will be noted in the Document History section of the report.





**Title:** Hewlett Packard Enterprise APINR203, APINP203  
**To:** FCC CFR 47 Part 15 Subpart C 15.247 (DTS)  
**Serial #:** HPEN96-U5\_Rev A (1x1)  
**Issue Date:** 23<sup>rd</sup> March 2017  
**Page:** 17 of 135

---

287	Rohde & Schwarz 40 GHz Receiver	Rhode & Schwarz	ESIB40	100201	2 May 2017
361	Desktop for RF#1, Labview Software installed	Dell	Vostro 220	WS RF#1	Not Required
390	USB Power Head 50MHz - 24GHz -60 to +20dBm	Agilent	U2002A	MY50000103	17 Oct 2017
398	Test Software	MiCOM	MiTest ATS	Version 4.1.0.76	Not Required
405	DC Power Supply 0-60V	Agilent	6654A	MY4001826	Cal when used
408	USB to GPIB interface	National Instruments	GPIB-USB HS	14C0DE9	Not Required
441	USB Wideband Power Sensor	Boonton	55006	9179	25 Sep 2017
443	4x4 RF Switch Box	MiCOM Labs	MiTest 4X4 RF Switch Box	MIC003	2 Jun 2017
75	Environmental Chamber	Thermatron	SE-300-2-2	27946	24 Nov 2017

---

This test report may be reproduced in full only. The document may only be updated by MiCOM Labs personnel. All changes will be noted in the Document History section of the report.

## 7.2. Radiated Emissions - 3m Chamber

The following tests were performed using the radiated test set-up shown in the diagram below.:-  
 Radiated emissions below 1GHz. Radiated Emissions above 1GHz.

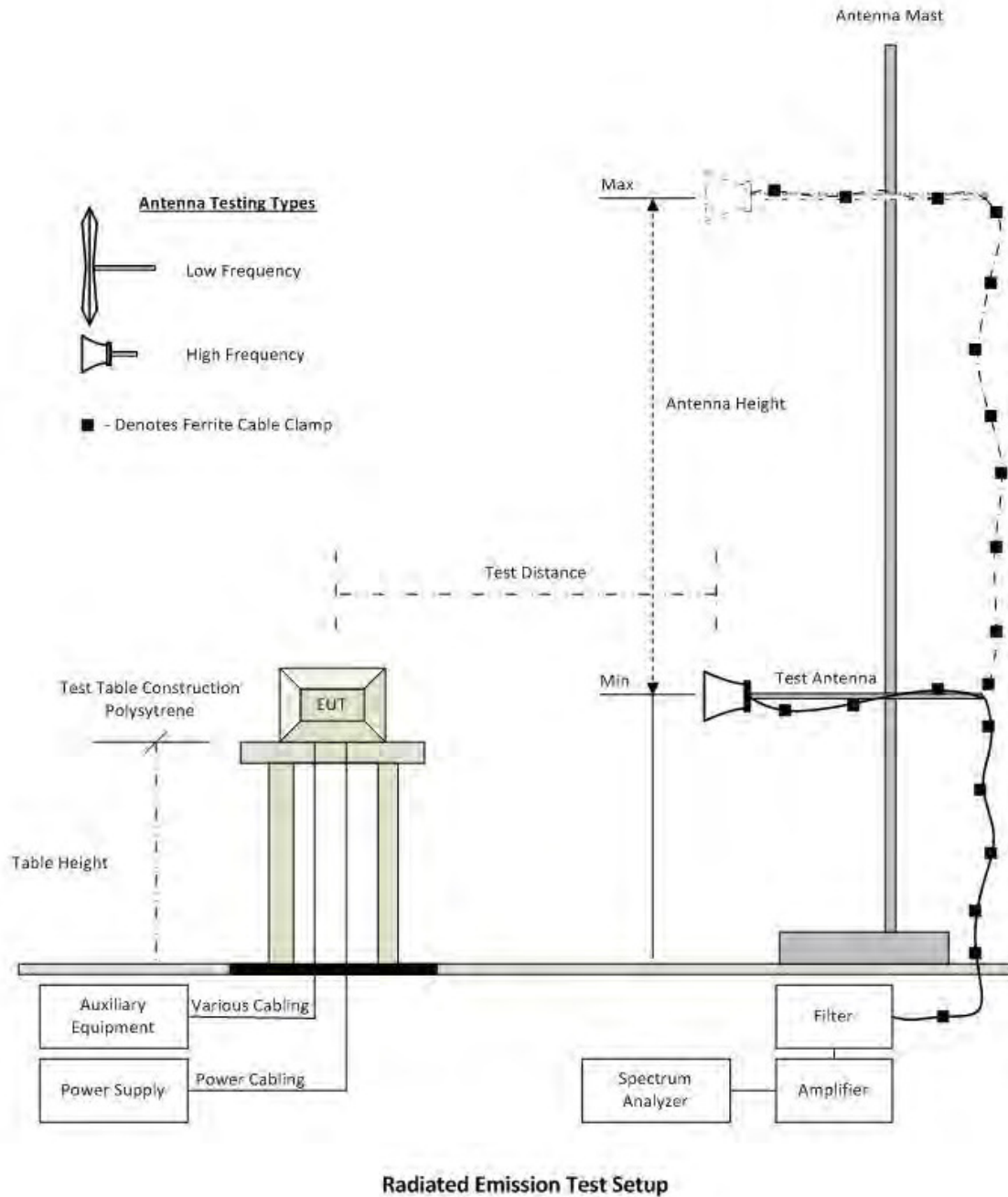

This test report may be reproduced in full only. The document may only be updated by MiCOM Labs personnel. All changes will be noted in the Document History section of the report.



**Title:** Hewlett Packard Enterprise APINR203, APINP203  
**To:** FCC CFR 47 Part 15 Subpart C 15.247 (DTS)  
**Serial #:** HPEN96-U5\_Rev A (1x1)  
**Issue Date:** 23<sup>rd</sup> March 2017  
**Page:** 19 of 135

A full system calibration was performed on the test station and any resulting system losses (or gains) were taken into account in the production of all final measurement data.

Asset#	Description	Manufacturer	Model#	Serial#	Calibration Due Date
158	Barometer/Thermometer	Control Company	4196	E2846	30 Nov 2017
170	Video System Controller for Semi Anechoic Chamber	Panasonic	WV-CU101	04R08507	Not Required
330	Variac 0-280 Vac	Staco Energy Co	3PN1020B	0546	Cal when used
336	Active loop Ant 10kHz to 30 MHz	EMCO	EMCO 6502	00060498	26 Sep 2017
338	Sunol 30 to 3000 MHz Antenna	Sunol	JB3	A052907	15 Aug 2017
373	26III RMS Multimeter	Fluke	Fluke 26 series III	76080720	26 Oct 2017
378	Rohde & Schwarz 40 GHz Receiver with Generator	Rhode & Schwarz	ESIB40	100107/040	4 Aug 2017
393	DC - 1050 MHz Low Pass Filter	Microcircuits	VLFX-1050	N/A	16 Aug 2017
396	2.4 GHz Notch Filter	Microtronics	BRM50701	001	16 Aug 2017
397	Amp 10 - 2500MHz	MiCOM Labs	Amp 10 - 2500 MHz	NA	9 Jun 2017
399	ETS 1-18 GHz Horn Antenna	ETS	3117	00154575	10 Apr 2017
406	Amplifier for Radiated Emissions	MiCOM Labs	40dB 1 to 18GHz Amp	0406	9 Jun 2017
410	Desktop Computer	Dell	Inspiron 620	WS38	Not Required
411	Mast/Turntable Controller	Sunol Sciences	SC98V	060199-1D	Not Required
412	USB to GPIB Interface	National Instruments	GPIB-USB HS	11B8DC2	Not Required
413	Mast Controller	Sunol Science	TWR95-4	030801-3	Not Required
415	Turntable Controller	Sunol Sciences	Turntable Controller	None	Not Required
416	Gigabit ethernet filter	ETS-Lingren	Gigafoil 260366	None	Not Required
447	Rad Emissions Test Software	MiCOM	Rad Emissions Test Software Version 1.0.109	447	Not Required
462	Schwarzbeck cable from Antenna to Amplifier.	Schwarzbeck	AK 9513	462	31 May 2017
463	Schwarzbeck cable from	Schwarzbeck	AK 9513	463	31 May 2017

This test report may be reproduced in full only. The document may only be updated by MiCOM Labs personnel. All changes will be noted in the Document History section of the report.



**Title:** Hewlett Packard Enterprise APINR203, APINP203  
**To:** FCC CFR 47 Part 15 Subpart C 15.247 (DTS)  
**Serial #:** HPEN96-U5\_Rev A (1x1)  
**Issue Date:** 23<sup>rd</sup> March 2017  
**Page:** 20 of 135

---

	Amplifier to Bulkhead.				
464	Schwarzbeck cable from Bulkhead to Receiver	Schwarzbeck	AK 9513	464	31 May 2017
465	Low Pass Filter DC-1000 MHz	Mini-Circuits	NLP-1200+	VUU01901402	2 Jun 2017
480	Cable - Bulkhead to Amp	SRC Haverhill	157-157-3050360	480	2 Jun 2017
481	Cable - Bulkhead to Receiver	SRC Haverhill	151-151-3050787	481	2 Jun 2017
482	Cable - Amp to Antenna	SRC Haverhill	157-157-3051574	482	2 Jun 2017
502	Test Software for Radiated Emissions	EMISoft	Vasona	Version 5 Build 59	Not Required
87	Uninterruptible Power Supply	Falcon Electric	ED2000-1/2LC	F3471 02/01	Cal when used
CC05	Confidence Check	MiCOM	CC05	None	26 Apr 2017

---

This test report may be reproduced in full only. The document may only be updated by MiCOM Labs personnel. All changes will be noted in the Document History section of the report.

## 8. MEASUREMENT AND PRESENTATION OF TEST DATA

The measurement and graphical data presented in this test report was generated automatically using state-of-the-art technology creating an easy to read report structure. Numerical measurement data is separated from supporting graphical data (plots) through hyperlinks. Numerical measurement data can be reviewed without scrolling through numerous graphical pages to arrive at the next data matrix.

Plots have been relegated into the Appendix 'Graphical Data'.

Test and report automation was performed by [MiTest](#). [MiTest](#) is an automated test system developed by MiCOM Labs. [MiTest](#) is the first cloud based modular test system enabling end-to-end automation of regulatory compliance testing for conducted RF testing.



The MiCOM Labs "[MiTest](#)" Automated Test System" (Patent Pending)

---

This test report may be reproduced in full only. The document may only be updated by MiCOM Labs personnel. All changes will be noted in the Document History section of the report.



**Title:** Hewlett Packard Enterprise APINR203, APINP203  
**To:** FCC CFR 47 Part 15 Subpart C 15.247 (DTS)  
**Serial #:** HPEN96-U5\_Rev A (1x1)  
**Issue Date:** 23<sup>rd</sup> March 2017  
**Page:** 22 of 135

## 9. TEST RESULTS

### 9.1. 6 dB & 99% Bandwidth

Conducted Test Conditions for 6 dB and 99% Bandwidth			
<b>Standard:</b>	FCC CFR 47:15.247 & IC RSS-247	<b>Ambient Temp. (°C):</b>	24.0 - 27.5
<b>Test Heading:</b>	6 dB and 99 % Bandwidth	<b>Rel. Humidity (%):</b>	32 - 45
<b>Standard Section(s):</b>	15.247 (a)(2) & RSS-247 (5.2)	<b>Pressure (mBars):</b>	999 - 1001
<b>Reference Document(s):</b>	See Normative References		
<p>Test Procedure for 6 dB and 99% Bandwidth Measurement The bandwidth at 6 dB and 99 % was measured with a spectrum analyzer connected to the antenna terminal, while EUT is operating in transmission mode at the appropriate center frequency.</p> <p>Testing was performed under ambient conditions at nominal voltage. Where the device operated with multiple antenna ports i.e. MIMO device, each port was measured and reported.</p> <p>Test configuration and setup used for the measurement was per the Conducted Test Set-up specified in this document.</p> <p><b>Limits for 6 dB and 99% Bandwidth</b> (a) Operation under the provisions of this Section is limited to frequency hopping and digitally modulated intentional radiators that comply with the following provisions: (2) Systems using digital modulation techniques may operate in the 902-928 MHz and 2400-2483.5 MHz bands. The minimum 6 dB bandwidth shall be at least 500 kHz.</p>			

This test report may be reproduced in full only. The document may only be updated by MiCOM Labs personnel. All changes will be noted in the Document History section of the report.



**Title:** Hewlett Packard Enterprise APINR203, APINP203  
**To:** FCC CFR 47 Part 15 Subpart C 15.247 (DTS)  
**Serial #:** HPEN96-U5\_Rev A (1x1)  
**Issue Date:** 23<sup>rd</sup> March 2017  
**Page:** 23 of 135

**Equipment Configuration for 6 dB & 99% Bandwidth**

<b>Variant:</b>	802.11b	<b>Duty Cycle (%):</b>	99
<b>Data Rate:</b>	1.00 MBit/s	<b>Antenna Gain (dBi):</b>	Not Applicable
<b>Modulation:</b>	CCK	<b>Beam Forming Gain (Y)(dB):</b>	Not Applicable
<b>TPC:</b>	Not Applicable	<b>Tested By:</b>	SB
<b>Engineering Test Notes:</b>			

**Test Measurement Results**

Test Frequency	Measured 6 dB Bandwidth (MHz)				6 dB Bandwidth (MHz)		Limit	Lowest Margin
	Port(s)				Highest	Lowest		
MHz	a	b	c	d			KHz	MHz
2412.0	<a href="#">7.535</a>				7.535	7.535	≥500.0	-7.04
2437.0	<a href="#">7.535</a>				7.535	7.535	≥500.0	-7.04
2462.0	<a href="#">7.535</a>				7.535	7.535	≥500.0	-7.04

Test Frequency	Measured 99% Bandwidth (MHz)				Maximum 99% Bandwidth (MHz)		
	Port(s)						
MHz	a	b	c	d			
2412.0	<a href="#">12.024</a>				12.024		
2437.0	<a href="#">12.024</a>				12.024		
2462.0	<a href="#">11.944</a>				11.944		

**Traceability to Industry Recognized Test Methodologies**

Work Instruction:	WI-03 MEASURING RF SPECTRUM MASK
Measurement Uncertainty:	±2.81 dB

Note: click the links in the above matrix to view the graphical image (plot).

This test report may be reproduced in full only. The document may only be updated by MiCOM Labs personnel. All changes will be noted in the Document History section of the report.



**Title:** Hewlett Packard Enterprise APINR203, APINP203  
**To:** FCC CFR 47 Part 15 Subpart C 15.247 (DTS)  
**Serial #:** HPEN96-U5\_Rev A (1x1)  
**Issue Date:** 23<sup>rd</sup> March 2017  
**Page:** 24 of 135

**Equipment Configuration for 6 dB & 99% Bandwidth**

<b>Variant:</b>	802.11g	<b>Duty Cycle (%):</b>	99
<b>Data Rate:</b>	6.00 MBit/s	<b>Antenna Gain (dBi):</b>	Not Applicable
<b>Modulation:</b>	OFDM	<b>Beam Forming Gain (Y)(dB):</b>	Not Applicable
<b>TPC:</b>	Not Applicable	<b>Tested By:</b>	SB
<b>Engineering Test Notes:</b>			

**Test Measurement Results**

Test Frequency	Measured 6 dB Bandwidth (MHz)				6 dB Bandwidth (MHz)		Limit	Lowest Margin
	Port(s)				Highest	Lowest		
MHz	a	b	c	d			KHz	MHz
2412.0	<a href="#">15.471</a>				15.471	15.471	≥500.0	-14.97
2437.0	<a href="#">15.471</a>				15.471	15.471	≥500.0	-14.97
2462.0	<a href="#">15.471</a>				15.471	15.471	≥500.0	-14.97

Test Frequency	Measured 99% Bandwidth (MHz)				Maximum 99% Bandwidth (MHz)		
	Port(s)						
MHz	a	b	c	d			
2412.0	<a href="#">16.433</a>				16.433		
2437.0	<a href="#">16.353</a>				16.353		
2462.0	<a href="#">16.433</a>				16.433		

**Traceability to Industry Recognized Test Methodologies**

Work Instruction:	WI-03 MEASURING RF SPECTRUM MASK
Measurement Uncertainty:	±2.81 dB

Note: click the links in the above matrix to view the graphical image (plot).

This test report may be reproduced in full only. The document may only be updated by MiCOM Labs personnel. All changes will be noted in the Document History section of the report.





**Title:** Hewlett Packard Enterprise APINR203, APINP203  
**To:** FCC CFR 47 Part 15 Subpart C 15.247 (DTS)  
**Serial #:** HPEN96-U5\_Rev A (1x1)  
**Issue Date:** 23<sup>rd</sup> March 2017  
**Page:** 25 of 135

**Equipment Configuration for 6 dB & 99% Bandwidth**

<b>Variant:</b>	802.11n HT-20	<b>Duty Cycle (%):</b>	99
<b>Data Rate:</b>	6.50 MBit/s	<b>Antenna Gain (dBi):</b>	Not Applicable
<b>Modulation:</b>	OFDM	<b>Beam Forming Gain (Y)(dB):</b>	Not Applicable
<b>TPC:</b>	Not Applicable	<b>Tested By:</b>	SB
<b>Engineering Test Notes:</b>			

**Test Measurement Results**

Test Frequency	Measured 6 dB Bandwidth (MHz)				6 dB Bandwidth (MHz)		Limit	Lowest Margin
	Port(s)				Highest	Lowest		
MHz	a	b	c	d				
2412.0	<a href="#">15.150</a>				15.150	15.150	≥500.0	-14.65
2437.0	<a href="#">15.150</a>				15.150	15.150	≥500.0	-14.65
2462.0	<a href="#">15.150</a>				15.150	15.150	≥500.0	-14.65

Test Frequency	Measured 99% Bandwidth (MHz)				Maximum 99% Bandwidth (MHz)		
	Port(s)						
MHz	a	b	c	d			
2412.0	<a href="#">17.555</a>				17.555		
2437.0	<a href="#">17.555</a>				17.555		
2462.0	<a href="#">17.555</a>				17.555		

**Traceability to Industry Recognized Test Methodologies**

Work Instruction:	WI-03 MEASURING RF SPECTRUM MASK
Measurement Uncertainty:	±2.81 dB

Note: click the links in the above matrix to view the graphical image (plot).

This test report may be reproduced in full only. The document may only be updated by MiCOM Labs personnel. All changes will be noted in the Document History section of the report.



**Title:** Hewlett Packard Enterprise APINR203, APINP203  
**To:** FCC CFR 47 Part 15 Subpart C 15.247 (DTS)  
**Serial #:** HPEN96-U5\_Rev A (1x1)  
**Issue Date:** 23<sup>rd</sup> March 2017  
**Page:** 26 of 135

**Equipment Configuration for 6 dB & 99% Bandwidth**

<b>Variants:</b>	802.11n HT-40	<b>Duty Cycle (%):</b>	99
<b>Data Rate:</b>	13.50 MBit/s	<b>Antenna Gain (dBi):</b>	Not Applicable
<b>Modulation:</b>	OFDM	<b>Beam Forming Gain (Y)(dB):</b>	Not Applicable
<b>TPC:</b>	Not Applicable	<b>Tested By:</b>	SB
<b>Engineering Test Notes:</b>			

**Test Measurement Results**

Test Frequency	Measured 6 dB Bandwidth (MHz)				6 dB Bandwidth (MHz)		Limit	Lowest Margin
	Port(s)				Highest	Lowest		
MHz	a	b	c	d				
2422.0	<a href="#">35.110</a>				35.110	35.110	≥500.0	-34.61
2437.0	<a href="#">35.110</a>				35.110	35.110	≥500.0	-34.61
2452.0	<a href="#">35.110</a>				35.110	35.110	≥500.0	-34.61

Test Frequency	Measured 99% Bandwidth (MHz)				Maximum 99% Bandwidth (MHz)		
	Port(s)						
MHz	a	b	c	d			
2422.0	<a href="#">35.752</a>				35.752		
2437.0	<a href="#">35.591</a>				35.591		
2452.0	<a href="#">35.591</a>				35.591		

**Traceability to Industry Recognized Test Methodologies**

Work Instruction:	WI-03 MEASURING RF SPECTRUM MASK
Measurement Uncertainty:	±2.81 dB

Note: click the links in the above matrix to view the graphical image (plot).

This test report may be reproduced in full only. The document may only be updated by MiCOM Labs personnel. All changes will be noted in the Document History section of the report.



## 9.2. Conducted Output Power

Conducted Test Conditions for Fundamental Emission Output Power			
<b>Standard:</b>	FCC CFR 47:15.247 & IC RSS-247	<b>Ambient Temp. (°C):</b>	24.0 - 27.5
<b>Test Heading:</b>	Output Power	<b>Rel. Humidity (%):</b>	32 - 45
<b>Standard Section(s):</b>	15.247 (b) & (c) & RSS-247 (5.4)	<b>Pressure (mBars):</b>	999 - 1001
<b>Reference Document(s):</b>	See Normative References		

Test Procedure for Fundamental Emission Output Power Measurement  
In the case of average power measurements an average power sensor was utilized.

For peak power measurements the spectrum analyzer built-in power function was used to integrate peak power over the 20 dB bandwidth.

Testing was performed under ambient conditions at nominal voltage only. Where the device operated with multiple antenna ports i.e. MIMO device, each port was measured, summed ( $\Sigma$ ) and reported.

Test configuration and setup used for the measurement was per the Conducted Test Set-up specified in this document.

Supporting Information

Calculated Power = A + G + Y + 10 log (1/x) dBm

A = Total Power [ $10 \cdot \text{Log}_{10} (10^{a/10} + 10^{b/10} + 10^{c/10} + 10^{d/10})$ ]

G = Antenna Gain

Y = Beamforming Gain

x = Duty Cycle (average power measurements only)

### Limits for Fundamental Emission Output Power

(b) The maximum peak conducted output power of the intentional radiator shall not exceed the following for non-frequency hopping systems:

(3) For systems using digital modulation in the 902-928 MHz and 2400-2483.5 MHz bands: 1 Watt. As an alternative to a peak power measurement, compliance with the one Watt limit can be based on a measurement of the maximum conducted output power. Maximum Conducted Output Power is defined as the total transmit power delivered to all antennas and antenna elements averaged across all symbols in the signaling alphabet when the transmitter is operating at its maximum power control level. Power must be summed across all antennas and antenna elements. The average must not include any time intervals during which the transmitter is off or is transmitting at a reduced power level. If multiple modes of operation are possible (e.g., alternative modulation methods), the maximum conducted output power is the highest total transmit power occurring in any mode.

(4) The conducted output power limit specified in paragraph (b) of this section is based on the use of antennas with directional gains that do not exceed 6 dBi. Except as shown in paragraph (c) of this section, if transmitting antennas of directional gain greater than 6 dBi are used, the conducted output power from the intentional radiator shall be reduced below the stated values in paragraphs (b)(3) of this section, as appropriate, by the amount in dB that the directional gain of the antenna exceeds 6 dBi.

(c) Operation with directional antenna gains greater than 6 dBi.

(1) Fixed point-to-point operation:

(i) Systems operating in the 2400-2483.5 MHz band that are used exclusively for fixed, point-to-point operations may employ transmitting antennas with directional gain greater than 6 dBi provided the maximum conducted output power of the intentional radiator is reduced by 1 dB for every 3 dB that the directional gain of the antenna exceeds 6 dBi.

(iii) Fixed, point-to-point operation, as used in paragraphs (c)(1)(i) and (c)(1)(ii) of this section, excludes the use of point-to-multipoint systems, omnidirectional applications, and multiple co-located intentional radiators transmitting the same information. The operator of the spread spectrum or digitally modulated intentional radiator or, if the equipment is professionally installed, the installer is responsible for ensuring that the system is used exclusively for fixed, point-to-point

This test report may be reproduced in full only. The document may only be updated by MiCOM Labs personnel. All changes will be noted in the Document History section of the report.



**Title:** Hewlett Packard Enterprise APINR203, APINP203  
**To:** FCC CFR 47 Part 15 Subpart C 15.247 (DTS)  
**Serial #:** HPEN96-U5\_Rev A (1x1)  
**Issue Date:** 23<sup>rd</sup> March 2017  
**Page:** 28 of 135

---

operations. The instruction manual furnished with the intentional radiator shall contain language in the installation instructions informing the operator and the installer of this responsibility.

(2) In addition to the provisions in paragraphs (b)(3), (b)(4) and (c)(1)(i) of this section, transmitters operating in the 2400-2483.5 MHz band that emit multiple directional beams, simultaneously or sequentially, for the purpose of directing signals to individual receivers or to groups of receivers provided the emissions comply with the following:

(i) Different information must be transmitted to each receiver.

(ii) If the transmitter employs an antenna system that emits multiple directional beams but does not do emit multiple directional beams simultaneously, the total output power conducted to the array or arrays that comprise the device, i.e., the sum of the power supplied to all antennas, antenna elements, staves, etc. and summed across all carriers or frequency channels, shall not exceed the limit specified in paragraph (b)(1) or (b)(3) of this section, as applicable. However, the total conducted output power shall be reduced by 1 dB below the specified limits for each 3 dB that the directional gain of the antenna/antenna array exceeds 6 dBi. The directional antenna gain shall be computed as follows:

(A) The directional gain shall be calculated as the sum of 10 log (number of array elements or staves) plus the directional gain of the element or stave having the highest gain.

(B) A lower value for the directional gain than that calculated in paragraph (c)(2)(ii)(A) of this section will be accepted if sufficient evidence is presented, e.g., due to shading of the array or coherence loss in the beamforming.

(iii) If a transmitter employs an antenna that operates simultaneously on multiple directional beams using the same or different frequency channels, the power supplied to each emission beam is subject to the power limit specified in paragraph (c)(2)(ii) of this section. If transmitted beams overlap, the power shall be reduced to ensure that their aggregate power does not exceed the limit specified in paragraph (c)(2)(ii) of this section. In addition, the aggregate power transmitted simultaneously on all beams shall not exceed the limit specified in paragraph (c)(2)(ii) of this section by more than 8 dB.

(iv) Transmitters that emit a single directional beam shall operate under the provisions of paragraph (c)(1) of this section.

---

This test report may be reproduced in full only. The document may only be updated by MiCOM Labs personnel. All changes will be noted in the Document History section of the report.



**Title:** Hewlett Packard Enterprise APINR203, APINP203  
**To:** FCC CFR 47 Part 15 Subpart C 15.247 (DTS)  
**Serial #:** HPEN96-U5\_Rev A (1x1)  
**Issue Date:** 23<sup>rd</sup> March 2017  
**Page:** 29 of 135

**Equipment Configuration for Average Output Power**

<b>Variant:</b>	802.11b	<b>Duty Cycle (%):</b>	99.0
<b>Data Rate:</b>	1.00 MBit/s	<b>Antenna Gain (dBi):</b>	1.00
<b>Modulation:</b>	CCK	<b>Beam Forming Gain (Y)(dB):</b>	Not Applicable
<b>TPC:</b>	Not Applicable	<b>Tested By:</b>	SB
<b>Engineering Test Notes:</b>			

**Test Measurement Results**

Test Frequency	Measured Output Power (dBm)				Calculated Total Power $\Sigma$ Port(s)	Limit	Margin	EUT Power Setting
	Port(s)							
MHz	a	b	c	d	dBm	dBm	dB	
2412.0	19.98				19.98	30.00	-10.02	78.00
2437.0	20.30				20.30	30.00	-9.70	78.00
2462.0	20.22				20.22	30.00	-9.78	78.00

**Traceability to Industry Recognized Test Methodologies**

Work Instruction:	WI-01 MEASURING RF OUTPUT POWER
Measurement Uncertainty:	$\pm 1.33$ dB

The above measurements are true pulse readings and therefore a Duty Cycling correction factor is not required.

This test report may be reproduced in full only. The document may only be updated by MiCOM Labs personnel. All changes will be noted in the Document History section of the report.



**Title:** Hewlett Packard Enterprise APINR203, APINP203  
**To:** FCC CFR 47 Part 15 Subpart C 15.247 (DTS)  
**Serial #:** HPEN96-U5\_Rev A (1x1)  
**Issue Date:** 23<sup>rd</sup> March 2017  
**Page:** 30 of 135

**Equipment Configuration for Average Output Power**

<b>Variant:</b>	802.11g	<b>Duty Cycle (%):</b>	99.0
<b>Data Rate:</b>	6.00 MBit/s	<b>Antenna Gain (dBi):</b>	1.00
<b>Modulation:</b>	OFDM	<b>Beam Forming Gain (Y)(dB):</b>	Not Applicable
<b>TPC:</b>	Not Applicable	<b>Tested By:</b>	SB
<b>Engineering Test Notes:</b>			

**Test Measurement Results**

Test Frequency	Measured Output Power (dBm)				Calculated Total Power $\Sigma$ Port(s)	Limit	Margin	EUT Power Setting
	Port(s)							
MHz	a	b	c	d	dBm	dBm	dB	
2412.0	18.99				18.99	30.00	-11.01	77.00
2437.0	19.40				19.40	30.00	-10.60	78.00
2462.0	19.51				19.51	30.00	-10.49	78.00

**Traceability to Industry Recognized Test Methodologies**

Work Instruction:	WI-01 MEASURING RF OUTPUT POWER
Measurement Uncertainty:	±1.33 dB

The above measurements are true pulse readings and therefore a Duty Cycling correction factor is not required.

This test report may be reproduced in full only. The document may only be updated by MiCOM Labs personnel. All changes will be noted in the Document History section of the report.



**Title:** Hewlett Packard Enterprise APINR203, APINP203  
**To:** FCC CFR 47 Part 15 Subpart C 15.247 (DTS)  
**Serial #:** HPEN96-U5\_Rev A (1x1)  
**Issue Date:** 23<sup>rd</sup> March 2017  
**Page:** 31 of 135

**Equipment Configuration for Average Output Power**

<b>Variant:</b>	802.11n HT-20	<b>Duty Cycle (%):</b>	99.0
<b>Data Rate:</b>	6.50 MBit/s	<b>Antenna Gain (dBi):</b>	1.00
<b>Modulation:</b>	OFDM	<b>Beam Forming Gain (Y)(dB):</b>	Not Applicable
<b>TPC:</b>	Not Applicable	<b>Tested By:</b>	SB
<b>Engineering Test Notes:</b>			

**Test Measurement Results**

Test Frequency	Measured Output Power (dBm)				Calculated Total Power $\Sigma$ Port(s)	Limit	Margin	EUT Power Setting
	Port(s)							
MHz	a	b	c	d	dBm	dBm	dB	
2412.0	18.00				18.00	30.00	-12.00	78.00
2437.0	18.25				18.25	30.00	-11.75	78.00
2462.0	18.29				18.29	30.00	-11.71	78.00

**Traceability to Industry Recognized Test Methodologies**

Work Instruction:	WI-01 MEASURING RF OUTPUT POWER
Measurement Uncertainty:	±1.33 dB

The above measurements are true pulse readings and therefore a Duty Cycling correction factor is not required.

This test report may be reproduced in full only. The document may only be updated by MiCOM Labs personnel. All changes will be noted in the Document History section of the report.



**Title:** Hewlett Packard Enterprise APINR203, APINP203  
**To:** FCC CFR 47 Part 15 Subpart C 15.247 (DTS)  
**Serial #:** HPEN96-U5\_Rev A (1x1)  
**Issue Date:** 23<sup>rd</sup> March 2017  
**Page:** 32 of 135

**Equipment Configuration for Average Output Power**

<b>Variants:</b>	802.11n HT-40	<b>Duty Cycle (%):</b>	99.0
<b>Data Rate:</b>	13.50 MBit/s	<b>Antenna Gain (dBi):</b>	1.00
<b>Modulation:</b>	OFDM	<b>Beam Forming Gain (Y)(dB):</b>	Not Applicable
<b>TPC:</b>	Not Applicable	<b>Tested By:</b>	SB
<b>Engineering Test Notes:</b>			

**Test Measurement Results**

Test Frequency	Measured Output Power (dBm)				Calculated Total Power $\Sigma$ Port(s)	Limit	Margin	EUT Power Setting
	Port(s)							
MHz	a	b	c	d	dBm	dBm	dB	
2422.0	17.580				17.58	30.00	-12.42	74.00
2437.0	18.82				18.82	30.00	-11.18	78.00
2452.0	18.73				18.73	30.00	-11.27	78.00

**Traceability to Industry Recognized Test Methodologies**

Work Instruction:	WI-01 MEASURING RF OUTPUT POWER
Measurement Uncertainty:	±1.33 dB

The above measurements are true pulse readings and therefore a Duty Cycling correction factor is not required.

This test report may be reproduced in full only. The document may only be updated by MiCOM Labs personnel. All changes will be noted in the Document History section of the report.





### 9.3. Power Spectral Density

Conducted Test Conditions for Power Spectral Density			
<b>Standard:</b>	FCC CFR 47:15.247 & IC RSS-247	<b>Ambient Temp. (°C):</b>	24.0 - 27.5
<b>Test Heading:</b>	Power Spectral Density	<b>Rel. Humidity (%):</b>	32 - 45
<b>Standard Section(s):</b>	15.247 (e) & RSS-247 (5.2)	<b>Pressure (mBars):</b>	999 - 1001
<b>Reference Document(s):</b>	See Normative References		

#### Test Procedure for Power Spectral Density

The transmitter output was connected to a spectrum analyzer and the measured made in a 3 kHz resolution bandwidth using the analyzer auto-coupled sweep-time. A peak value was found over the full emission bandwidth and the spectrum downloaded for post processing purposes.

Where the device operated with multiple antenna ports i.e. MIMO device, each port was measured separately. The Peak Power Spectral Density is the highest level found across the emission bandwidth. With multiple antenna port measurements the numerical analyzer data from each port is summed ( $\hat{a}$ ) and a link to this additional graphic is provided.

Testing was performed under ambient conditions at nominal voltage only.

Test configuration and setup used for the measurement was per the Conducted Test Set-up specified in this document.

Measure and sum the spectra across the outputs. With this technique, spectra are measured at each output of the device at the required resolution bandwidth. The individual spectra are then summed mathematically in linear power units. Unlike in-band power measurements, in which the sum involves a single measured value (output power) from each output, measurements for compliance with PSD limits involve summing entire spectra across corresponding frequency bins on the various outputs. Consistency is maintained for any device with multiple transmitter outputs to be certain the individual outputs are all aligned with the same span and same number of points. In this instance, the linear power spectrum value within the first spectral bin of output 0 is summed with that in the first spectral bin of output 1, and the first spectral bin of output 2, and so on up to the Nth output to obtain the true value for the first frequency bin of the summed spectrum. The summed spectrum value for each frequency bin is computed in this fashion. These summed spectral values were post processed and the resulting numerical and graphical data presented.

#### NOTE:

It may be observed that the spectrum in some antenna port plots break the limit line however this in itself does NOT constitute a failure. In all cases a spectrum summation plot is provided in order to prove compliance. A failure occurs only after the summation of all spectrum plots have been summed and are found to be greater than the limit line.

#### Supporting Information

Calculated Power = A + 10 log (1/x) dBm

A = Total Power Spectral Density [10 Log<sub>10</sub> (10<sup>a/10</sup> + 10<sup>b/10</sup> + 10<sup>c/10</sup> + 10<sup>d/10</sup>)]

x = Duty Cycle

#### Limits Power Spectral Density

For digitally modulated systems, the power spectral density conducted from the intentional radiator to the antenna shall not be greater than +8 dBm in any 3 kHz band during any time interval of continuous transmission. This power spectral density shall be determined in accordance with the provisions of paragraph (b) of this section. The same method of determining the conducted output power shall be used to determine the power spectral density.



**Title:** Hewlett Packard Enterprise APINR203, APINP203  
**To:** FCC CFR 47 Part 15 Subpart C 15.247 (DTS)  
**Serial #:** HPEN96-U5\_Rev A (1x1)  
**Issue Date:** 23<sup>rd</sup> March 2017  
**Page:** 34 of 135

**Equipment Configuration for Power Spectral Density - Average**

<b>Variant:</b>	802.11b	<b>Duty Cycle (%):</b>	99.0
<b>Data Rate:</b>	1.00 MBit/s	<b>Antenna Gain (dBi):</b>	1.00
<b>Modulation:</b>	CCK	<b>Beam Forming Gain (Y)(dB):</b>	Not Applicable
<b>TPC:</b>	Not Applicable	<b>Tested By:</b>	SB
<b>Engineering Test Notes:</b>			

**Test Measurement Results**

Test Frequency	Measured Power Spectral Density				Amplitude Summation + DCCF (+0.04 dB)	Limit	Margin
	Port(s) (dBm/3KHz)						
MHz	a	b	c	d	dBm/3KHz	dBm/3KHz	dB
2412.0	<a href="#">-14.990</a>				<a href="#">-14.946</a>	8.0	-22.9
2437.0	<a href="#">-13.034</a>				<a href="#">-12.990</a>	8.0	-21.0
2462.0	<a href="#">-13.407</a>				<a href="#">-13.363</a>	8.0	-21.4

**Traceability to Industry Recognized Test Methodologies**

Work Instruction:	WI-03 MEASURING RF SPECTRUM MASK
Measurement Uncertainty:	±2.81 dB

DCCF - Duty Cycle Correction Factor

Note: click the links in the above matrix to view the graphical image (plot).

This test report may be reproduced in full only. The document may only be updated by MiCOM Labs personnel. All changes will be noted in the Document History section of the report.



**Title:** Hewlett Packard Enterprise APINR203, APINP203  
**To:** FCC CFR 47 Part 15 Subpart C 15.247 (DTS)  
**Serial #:** HPEN96-U5\_Rev A (1x1)  
**Issue Date:** 23<sup>rd</sup> March 2017  
**Page:** 35 of 135

**Equipment Configuration for Power Spectral Density - Average**

<b>Variant:</b>	802.11g	<b>Duty Cycle (%):</b>	99.0
<b>Data Rate:</b>	6.00 MBit/s	<b>Antenna Gain (dBi):</b>	1.00
<b>Modulation:</b>	OFDM	<b>Beam Forming Gain (Y)(dB):</b>	Not Applicable
<b>TPC:</b>	Not Applicable	<b>Tested By:</b>	SB
<b>Engineering Test Notes:</b>			

**Test Measurement Results**

Test Frequency	Measured Power Spectral Density				Amplitude Summation + DCCF (+0.04 dB)	Limit	Margin
	Port(s) (dBm/3KHz)						
MHz	a	b	c	d	dBm/3KHz	dBm/3KHz	dB
2412.0	<a href="#">-16.483</a>				<a href="#">-16.439</a>	8.0	-24.4
2437.0	<a href="#">-14.809</a>				<a href="#">-14.765</a>	8.0	-22.8
2462.0	<a href="#">-15.557</a>				<a href="#">-15.513</a>	8.0	-23.5

**Traceability to Industry Recognized Test Methodologies**

Work Instruction:	WI-03 MEASURING RF SPECTRUM MASK
Measurement Uncertainty:	±2.81 dB

DCCF - Duty Cycle Correction Factor

Note: click the links in the above matrix to view the graphical image (plot).

This test report may be reproduced in full only. The document may only be updated by MiCOM Labs personnel. All changes will be noted in the Document History section of the report.



**Title:** Hewlett Packard Enterprise APINR203, APINP203  
**To:** FCC CFR 47 Part 15 Subpart C 15.247 (DTS)  
**Serial #:** HPEN96-U5\_Rev A (1x1)  
**Issue Date:** 23<sup>rd</sup> March 2017  
**Page:** 36 of 135

**Equipment Configuration for Power Spectral Density - Average**

<b>Variant:</b>	802.11n HT-20	<b>Duty Cycle (%):</b>	99.0
<b>Data Rate:</b>	6.50 MBit/s	<b>Antenna Gain (dBi):</b>	1.00
<b>Modulation:</b>	OFDM	<b>Beam Forming Gain (Y)(dB):</b>	Not Applicable
<b>TPC:</b>	Not Applicable	<b>Tested By:</b>	SB
<b>Engineering Test Notes:</b>			

**Test Measurement Results**

Test Frequency	Measured Power Spectral Density				Amplitude Summation + DCCF (+0.04 dB)	Limit	Margin
	Port(s) (dBm/3KHz)						
MHz	a	b	c	d	dBm/3KHz	dBm/3KHz	dB
2412.0	<a href="#">-18.088</a>				<a href="#">-18.044</a>	8.0	-26.0
2437.0	<a href="#">-16.322</a>				<a href="#">-16.278</a>	8.0	-24.3
2462.0	<a href="#">-17.278</a>				<a href="#">-17.234</a>	8.0	-25.2

**Traceability to Industry Recognized Test Methodologies**

Work Instruction:	WI-03 MEASURING RF SPECTRUM MASK
Measurement Uncertainty:	±2.81 dB

DCCF - Duty Cycle Correction Factor

Note: click the links in the above matrix to view the graphical image (plot).

This test report may be reproduced in full only. The document may only be updated by MiCOM Labs personnel. All changes will be noted in the Document History section of the report.



**Title:** Hewlett Packard Enterprise APINR203, APINP203  
**To:** FCC CFR 47 Part 15 Subpart C 15.247 (DTS)  
**Serial #:** HPEN96-U5\_Rev A (1x1)  
**Issue Date:** 23<sup>rd</sup> March 2017  
**Page:** 37 of 135

**Equipment Configuration for Power Spectral Density - Average**

<b>Variant:</b>	802.11n HT-40	<b>Duty Cycle (%):</b>	99.0
<b>Data Rate:</b>	13.50 MBit/s	<b>Antenna Gain (dBi):</b>	1.00
<b>Modulation:</b>	OFDM	<b>Beam Forming Gain (Y)(dB):</b>	Not Applicable
<b>TPC:</b>	Not Applicable	<b>Tested By:</b>	SB
<b>Engineering Test Notes:</b>			

**Test Measurement Results**

Test Frequency	Measured Power Spectral Density				Amplitude Summation + DCCF (+0.04 dB)	Limit	Margin
	Port(s) (dBm/3KHz)						
MHz	a	b	c	d	dBm/3KHz	dBm/3KHz	dB
2422.0	<a href="#">-21.103</a>				<a href="#">-21.059</a>	8.0	-29.1
2437.0	<a href="#">-20.059</a>				<a href="#">-19.836</a>	8.0	-27.8
2452.0	<a href="#">-19.581</a>				<a href="#">-19.358</a>	8.0	-27.4

**Traceability to Industry Recognized Test Methodologies**

Work Instruction:	WI-03 MEASURING RF SPECTRUM MASK
Measurement Uncertainty:	±2.81 dB

DCCF - Duty Cycle Correction Factor

Note: click the links in the above matrix to view the graphical image (plot).

This test report may be reproduced in full only. The document may only be updated by MiCOM Labs personnel. All changes will be noted in the Document History section of the report.



**Title:** Hewlett Packard Enterprise APINR203, APINP203  
**To:** FCC CFR 47 Part 15 Subpart C 15.247 (DTS)  
**Serial #:** HPEN96-U5\_Rev A (1x1)  
**Issue Date:** 23<sup>rd</sup> March 2017  
**Page:** 38 of 135

## 9.4. Emissions

### 9.4.1. Conducted Emissions

#### 9.4.1.1. Conducted Spurious Emissions

Conducted Test Conditions for Transmitter Conducted Spurious and Band-Edge Emissions			
<b>Standard:</b>	FCC CFR 47:15.247 & IC RSS-247	<b>Ambient Temp. (°C):</b>	24.0 - 27.5
<b>Test Heading:</b>	Max Unwanted Emission Levels	<b>Rel. Humidity (%):</b>	32 - 45
<b>Standard Section(s):</b>	15.247 (d) & RSS-247 (5.5)	<b>Pressure (mBars):</b>	999 - 1001
<b>Reference Document(s):</b>	See Normative References		

#### Test Procedure for Transmitter Conducted Spurious and Band-Edge Emissions Measurement

Transmitter Conducted Spurious and Band-Edge emissions were measured at a limit of 30 dBc (average detector) or 20 dBc (peak detector) below the highest in-band spectral density measured with a spectrum analyzer connected to the antenna terminal. Measurements were made while EUT was operating in transmit mode of operation at the appropriate centre frequency closest to the band-edge. Emissions were maximized during the measurement and limits derived from the peak spectral power and drawn on each plot.

Where the device operated with multiple antenna ports i.e. MIMO device, each port was measured separately. Testing was performed under ambient conditions at nominal voltage only.

Test configuration and setup used for the measurement was per the Conducted Test Set-up specified in this document.

#### Limits Transmitter Conducted Spurious and Band-Edge Emissions

(d) In any 100 kHz bandwidth outside the frequency band in which the spread spectrum or digitally modulated intentional radiator is operating, the radio frequency power that is produced by the intentional radiator shall be at least 20 dB below that in the 100 kHz bandwidth within the band that contains the highest level of the desired power, based on either an RF conducted or a radiated measurement, provided the transmitter demonstrates compliance with the peak conducted power limits. If the transmitter complies with the conducted power limits based on the use of RMS averaging over a time interval, as permitted under paragraph (b)(3) of this section, the attenuation required under this paragraph shall be 30 dB instead of 20 dB. Attenuation below the general limits specified in §15.209(a) is not required. In addition, radiated emissions which fall in the restricted bands, as defined in §15.205(a), must also comply with the radiated emission limits specified in §15.209(a) (see §15.205(c)).

This test report may be reproduced in full only. The document may only be updated by MiCOM Labs personnel. All changes will be noted in the Document History section of the report.



**Title:** Hewlett Packard Enterprise APINR203, APINP203  
**To:** FCC CFR 47 Part 15 Subpart C 15.247 (DTS)  
**Serial #:** HPEN96-U5\_Rev A (1x1)  
**Issue Date:** 23<sup>rd</sup> March 2017  
**Page:** 39 of 135

**Equipment Configuration for Conducted Spurious Emissions - Average**

<b>Variant:</b>	802.11b	<b>Duty Cycle (%):</b>	99
<b>Data Rate:</b>	1.00 MBit/s	<b>Antenna Gain (dBi):</b>	Not Applicable
<b>Modulation:</b>	CCK	<b>Beam Forming Gain (Y):</b>	Not Applicable
<b>TPC:</b>	Not Applicable	<b>Tested By:</b>	SB
<b>Engineering Test Notes:</b>			

**Test Measurement Results**

Test Frequency	Frequency Range	Conducted Spurious Emissions - Average (dBm)							
		Port a		Port b		Port c		Port d	
MHz	MHz	SE	Limit	SE	Limit	SE	Limit	SE	Limit
2412.0	30.0 - 26000.0	<a href="#">-56.480</a>	-46.00						
2437.0	30.0 - 26000.0	<a href="#">-56.480</a>	-45.00						
2462.0	30.0 - 26000.0	<a href="#">-56.480</a>	-46.00						

**Traceability to Industry Recognized Test Methodologies**

Work Instruction:	WI-05 MEASUREMENT OF SPURIOUS EMISSIONS
Measurement Uncertainty:	<=40 GHz ±2.37 dB, > 40 GHz ±4.6 dB

Note: click the links in the above matrix to view the graphical image (plot).

This test report may be reproduced in full only. The document may only be updated by MiCOM Labs personnel. All changes will be noted in the Document History section of the report.



**Title:** Hewlett Packard Enterprise APINR203, APINP203  
**To:** FCC CFR 47 Part 15 Subpart C 15.247 (DTS)  
**Serial #:** HPEN96-U5\_Rev A (1x1)  
**Issue Date:** 23<sup>rd</sup> March 2017  
**Page:** 40 of 135

**Equipment Configuration for Conducted Spurious Emissions - Average**

<b>Variant:</b>	802.11g	<b>Duty Cycle (%):</b>	99
<b>Data Rate:</b>	6.00 MBit/s	<b>Antenna Gain (dBi):</b>	Not Applicable
<b>Modulation:</b>	OFDM	<b>Beam Forming Gain (Y):</b>	Not Applicable
<b>TPC:</b>	Not Applicable	<b>Tested By:</b>	SB
<b>Engineering Test Notes:</b>			

**Test Measurement Results**

Test Frequency	Frequency Range	Conducted Spurious Emissions - Average (dBm)							
		Port a		Port b		Port c		Port d	
MHz	MHz	SE	Limit	SE	Limit	SE	Limit	SE	Limit
2412.0	30.0 - 26000.0	<a href="#">-56.480</a>	-45.00						
2437.0	30.0 - 26000.0	<a href="#">-56.480</a>	-43.00						
2462.0	30.0 - 26000.0	<a href="#">-56.480</a>	-44.00						

**Traceability to Industry Recognized Test Methodologies**

Work Instruction:	WI-05 MEASUREMENT OF SPURIOUS EMISSIONS
Measurement Uncertainty:	<=40 GHz ±2.37 dB, > 40 GHz ±4.6 dB

Note: click the links in the above matrix to view the graphical image (plot).

This test report may be reproduced in full only. The document may only be updated by MiCOM Labs personnel. All changes will be noted in the Document History section of the report.





**Title:** Hewlett Packard Enterprise APINR203, APINP203  
**To:** FCC CFR 47 Part 15 Subpart C 15.247 (DTS)  
**Serial #:** HPEN96-U5\_Rev A (1x1)  
**Issue Date:** 23<sup>rd</sup> March 2017  
**Page:** 41 of 135

**Equipment Configuration for Conducted Spurious Emissions - Average**

<b>Variant:</b>	802.11n HT-20	<b>Duty Cycle (%):</b>	99
<b>Data Rate:</b>	6.50 MBit/s	<b>Antenna Gain (dBi):</b>	Not Applicable
<b>Modulation:</b>	OFDM	<b>Beam Forming Gain (Y):</b>	Not Applicable
<b>TPC:</b>	Not Applicable	<b>Tested By:</b>	SB
<b>Engineering Test Notes:</b>			

**Test Measurement Results**

Test Frequency	Frequency Range	Conducted Spurious Emissions - Average (dBm)							
		Port a		Port b		Port c		Port d	
MHz	MHz	SE	Limit	SE	Limit	SE	Limit	SE	Limit
2412.0	30.0 - 26000.0	<a href="#">-56.480</a>	-47.00						
2437.0	30.0 - 26000.0	<a href="#">-56.480</a>	-45.00						
2462.0	30.0 - 26000.0	<a href="#">-56.480</a>	-45.00						

**Traceability to Industry Recognized Test Methodologies**

Work Instruction:	WI-05 MEASUREMENT OF SPURIOUS EMISSIONS
Measurement Uncertainty:	<=40 GHz ±2.37 dB, > 40 GHz ±4.6 dB

Note: click the links in the above matrix to view the graphical image (plot).

This test report may be reproduced in full only. The document may only be updated by MiCOM Labs personnel. All changes will be noted in the Document History section of the report.



**Title:** Hewlett Packard Enterprise APINR203, APINP203  
**To:** FCC CFR 47 Part 15 Subpart C 15.247 (DTS)  
**Serial #:** HPEN96-U5\_Rev A (1x1)  
**Issue Date:** 23<sup>rd</sup> March 2017  
**Page:** 42 of 135

**Equipment Configuration for Conducted Spurious Emissions - Average**

<b>Variant:</b>	802.11n HT-40	<b>Duty Cycle (%):</b>	99
<b>Data Rate:</b>	13.50 MBit/s	<b>Antenna Gain (dBi):</b>	Not Applicable
<b>Modulation:</b>	OFDM	<b>Beam Forming Gain (Y):</b>	Not Applicable
<b>TPC:</b>	Not Applicable	<b>Tested By:</b>	SB
<b>Engineering Test Notes:</b>			

**Test Measurement Results**

Test Frequency	Frequency Range	Conducted Spurious Emissions - Average (dBm)							
		Port a		Port b		Port c		Port d	
MHz	MHz	SE	Limit	SE	Limit	SE	Limit	SE	Limit
2422.0	30.0 - 26000.0	<a href="#">-56.480</a>	-46.00						
2437.0	30.0 - 26000.0	<a href="#">-56.480</a>	-41.00						
2452.0	30.0 - 26000.0	<a href="#">-56.480</a>	-41.00						

**Traceability to Industry Recognized Test Methodologies**

Work Instruction:	WI-05 MEASUREMENT OF SPURIOUS EMISSIONS
Measurement Uncertainty:	<=40 GHz ±2.37 dB, > 40 GHz ±4.6 dB

Note: click the links in the above matrix to view the graphical image (plot).

This test report may be reproduced in full only. The document may only be updated by MiCOM Labs personnel. All changes will be noted in the Document History section of the report.



**Title:** Hewlett Packard Enterprise APINR203, APINP203  
**To:** FCC CFR 47 Part 15 Subpart C 15.247 (DTS)  
**Serial #:** HPEN96-U5\_Rev A (1x1)  
**Issue Date:** 23<sup>rd</sup> March 2017  
**Page:** 43 of 135

### 9.4.1.2. Conducted Band-Edge Emissions

Conducted Test Conditions for Transmitter Conducted Spurious and Band-Edge Emissions			
<b>Standard:</b>	FCC CFR 47:15.247 & IC RSS-247	<b>Ambient Temp. (°C):</b>	24.0 - 27.5
<b>Test Heading:</b>	Max Unwanted Emission Levels	<b>Rel. Humidity (%):</b>	32 - 45
<b>Standard Section(s):</b>	15.247 (d) RSS-247 (5.5)	<b>Pressure (mBars):</b>	999 - 1001
<b>Reference Document(s):</b>	See Normative References		

#### Test Procedure for Transmitter Conducted Spurious and Band-Edge Emissions Measurement

Transmitter Conducted Spurious and Band-Edge emissions were measured at a limit of 30 dBc (average detector) or 20 dBc (peak detector) below the highest in-band spectral density measured with a spectrum analyzer connected to the antenna terminal. Measurements were made while EUT was operating in transmit mode of operation at the appropriate centre frequency closest to the band-edge. Emissions were maximized during the measurement and limits derived from the peak spectral power and drawn on each plot.

Where the device operated with multiple antenna ports i.e. MIMO device, each port was measured separately. Testing was performed under ambient conditions at nominal voltage only.

Test configuration and setup used for the measurement was per the Conducted Test Set-up specified in this document.

#### Limits Transmitter Conducted Spurious and Band-Edge Emissions

(d) In any 100 kHz bandwidth outside the frequency band in which the spread spectrum or digitally modulated intentional radiator is operating, the radio frequency power that is produced by the intentional radiator shall be at least 20 dB below that in the 100 kHz bandwidth within the band that contains the highest level of the desired power, based on either an RF conducted or a radiated measurement, provided the transmitter demonstrates compliance with the peak conducted power limits. If the transmitter complies with the conducted power limits based on the use of RMS averaging over a time interval, as permitted under paragraph (b)(3) of this section, the attenuation required under this paragraph shall be 30 dB instead of 20 dB. Attenuation below the general limits specified in §15.209(a) is not required. In addition, radiated emissions which fall in the restricted bands, as defined in §15.205(a), must also comply with the radiated emission limits specified in §15.209(a) (see §15.205(c)).

This test report may be reproduced in full only. The document may only be updated by MiCOM Labs personnel. All changes will be noted in the Document History section of the report.



**Title:** Hewlett Packard Enterprise APINR203, APINP203  
**To:** FCC CFR 47 Part 15 Subpart C 15.247 (DTS)  
**Serial #:** HPEN96-U5\_Rev A (1x1)  
**Issue Date:** 23<sup>rd</sup> March 2017  
**Page:** 44 of 135

**Equipment Configuration for Conducted Low Band-Edge Emissions - Average**

<b>Variant:</b>	802.11b	<b>Duty Cycle (%):</b>	99.0
<b>Data Rate:</b>	1.00 MBit/s	<b>Antenna Gain (dBi):</b>	Not Applicable
<b>Modulation:</b>	CCK	<b>Beam Forming Gain (Y)(dB):</b>	Not Applicable
<b>TPC:</b>	Not Applicable	<b>Tested By:</b>	SB
<b>Engineering Test Notes:</b>			

**Test Measurement Results**

<b>Channel Frequency:</b>	2412.0 MHz					
<b>Band-Edge Frequency:</b>	2400.0 MHz					
<b>Test Frequency Range:</b>	2350.0 - 2422.0 MHz					
<b>Port(s)</b>	<b>Band-Edge Markers and Limit</b>			<b>Revised Limit</b>		<b>Margin</b>
	<b>M1 Amplitude (dBm)</b>	<b>Plot Limit (dBm)</b>	<b>M2 Frequency (MHz)</b>	<b>Amplitude (dBm)</b>	<b>M2A Frequency (MHz)</b>	<b>(MHz)</b>
a	<a href="#">-48.87</a>	-30.00	2403.80			-3.800

**Traceability to Industry Recognized Test Methodologies**

<b>Work Instruction:</b>	WI-05 MEASUREMENT OF SPURIOUS EMISSIONS
<b>Measurement Uncertainty:</b>	<=40 GHz $\pm$ 2.37 dB, > 40 GHz $\pm$ 4.6 dB

Note: click the links in the above matrix to view the graphical image (plot).

This test report may be reproduced in full only. The document may only be updated by MiCOM Labs personnel. All changes will be noted in the Document History section of the report.



**Title:** Hewlett Packard Enterprise APINR203, APINP203  
**To:** FCC CFR 47 Part 15 Subpart C 15.247 (DTS)  
**Serial #:** HPEN96-U5\_Rev A (1x1)  
**Issue Date:** 23<sup>rd</sup> March 2017  
**Page:** 45 of 135

**Equipment Configuration for Conducted Low Band-Edge Emissions - Average**

<b>Variant:</b>	802.11g	<b>Duty Cycle (%):</b>	99.0
<b>Data Rate:</b>	6.00 MBit/s	<b>Antenna Gain (dBi):</b>	Not Applicable
<b>Modulation:</b>	OFDM	<b>Beam Forming Gain (Y)(dB):</b>	Not Applicable
<b>TPC:</b>	Not Applicable	<b>Tested By:</b>	SB
<b>Engineering Test Notes:</b>			

**Test Measurement Results**

<b>Channel Frequency:</b>	2412.0 MHz					
<b>Band-Edge Frequency:</b>	2400.0 MHz					
<b>Test Frequency Range:</b>	2350.0 - 2422.0 MHz					
<b>Port(s)</b>	<b>Band-Edge Markers and Limit</b>			<b>Revised Limit</b>		<b>Margin</b>
	<b>M1 Amplitude (dBm)</b>	<b>Plot Limit (dBm)</b>	<b>M2 Frequency (MHz)</b>	<b>Amplitude (dBm)</b>	<b>M2A Frequency (MHz)</b>	<b>(MHz)</b>
<b>a</b>	<a href="#">-36.82</a>	-31.00	2401.50			-1.500

**Traceability to Industry Recognized Test Methodologies**

<b>Work Instruction:</b>	WI-05 MEASUREMENT OF SPURIOUS EMISSIONS
<b>Measurement Uncertainty:</b>	<=40 GHz ±2.37 dB, > 40 GHz ±4.6 dB

Note: click the links in the above matrix to view the graphical image (plot).

This test report may be reproduced in full only. The document may only be updated by MiCOM Labs personnel. All changes will be noted in the Document History section of the report.



**Title:** Hewlett Packard Enterprise APINR203, APINP203  
**To:** FCC CFR 47 Part 15 Subpart C 15.247 (DTS)  
**Serial #:** HPEN96-U5\_Rev A (1x1)  
**Issue Date:** 23<sup>rd</sup> March 2017  
**Page:** 46 of 135

**Equipment Configuration for Conducted Low Band-Edge Emissions - Average**

<b>Variant:</b>	802.11n HT-20	<b>Duty Cycle (%):</b>	99.0
<b>Data Rate:</b>	6.50 MBit/s	<b>Antenna Gain (dBi):</b>	Not Applicable
<b>Modulation:</b>	OFDM	<b>Beam Forming Gain (Y)(dB):</b>	Not Applicable
<b>TPC:</b>	Not Applicable	<b>Tested By:</b>	SB
<b>Engineering Test Notes:</b>			

**Test Measurement Results**

<b>Channel Frequency:</b>	2412.0 MHz					
<b>Band-Edge Frequency:</b>	2400.0 MHz					
<b>Test Frequency Range:</b>	2350.0 - 2422.0 MHz					
<b>Port(s)</b>	<b>Band-Edge Markers and Limit</b>			<b>Revised Limit</b>		<b>Margin</b>
	<b>M1 Amplitude (dBm)</b>	<b>Plot Limit (dBm)</b>	<b>M2 Frequency (MHz)</b>	<b>Amplitude (dBm)</b>	<b>M2A Frequency (MHz)</b>	<b>(MHz)</b>
a	<a href="#">-42.42</a>	-33.00	2401.50			-1.500

**Traceability to Industry Recognized Test Methodologies**

<b>Work Instruction:</b>	WI-05 MEASUREMENT OF SPURIOUS EMISSIONS
<b>Measurement Uncertainty:</b>	<=40 GHz ±2.37 dB, > 40 GHz ±4.6 dB

Note: click the links in the above matrix to view the graphical image (plot).

This test report may be reproduced in full only. The document may only be updated by MiCOM Labs personnel. All changes will be noted in the Document History section of the report.



**Title:** Hewlett Packard Enterprise APINR203, APINP203  
**To:** FCC CFR 47 Part 15 Subpart C 15.247 (DTS)  
**Serial #:** HPEN96-U5\_Rev A (1x1)  
**Issue Date:** 23<sup>rd</sup> March 2017  
**Page:** 47 of 135

**Equipment Configuration for Conducted Low Band-Edge Emissions - Average**

<b>Variant:</b>	802.11n HT-40	<b>Duty Cycle (%):</b>	99.0
<b>Data Rate:</b>	13.50 MBit/s	<b>Antenna Gain (dBi):</b>	Not Applicable
<b>Modulation:</b>	OFDM	<b>Beam Forming Gain (Y)(dB):</b>	Not Applicable
<b>TPC:</b>	Not Applicable	<b>Tested By:</b>	SB
<b>Engineering Test Notes:</b>			

**Test Measurement Results**

<b>Channel Frequency:</b>	2422.0 MHz					
<b>Band-Edge Frequency:</b>	2400.0 MHz					
<b>Test Frequency Range:</b>	2292.0 - 2442.0 MHz					
<b>Port(s)</b>	<b>Band-Edge Markers and Limit</b>			<b>Revised Limit</b>		<b>Margin</b>
	<b>M1 Amplitude (dBm)</b>	<b>Plot Limit (dBm)</b>	<b>M2 Frequency (MHz)</b>	<b>Amplitude (dBm)</b>	<b>M2A Frequency (MHz)</b>	<b>(MHz)</b>
a	<a href="#">-40.24</a>	-37.00	2402.60			-2.600

**Traceability to Industry Recognized Test Methodologies**

<b>Work Instruction:</b>	WI-05 MEASUREMENT OF SPURIOUS EMISSIONS
<b>Measurement Uncertainty:</b>	<=40 GHz $\pm$ 2.37 dB, > 40 GHz $\pm$ 4.6 dB

Note: click the links in the above matrix to view the graphical image (plot).

This test report may be reproduced in full only. The document may only be updated by MiCOM Labs personnel. All changes will be noted in the Document History section of the report.



**Title:** Hewlett Packard Enterprise APINR203, APINP203  
**To:** FCC CFR 47 Part 15 Subpart C 15.247 (DTS)  
**Serial #:** HPEN96-U5\_Rev A (1x1)  
**Issue Date:** 23<sup>rd</sup> March 2017  
**Page:** 48 of 135

Equipment Configuration for Conducted High Band-Edge Emissions - Average			
<b>Variant:</b>	802.11b	<b>Duty Cycle (%):</b>	99.0
<b>Data Rate:</b>	1.00 MBit/s	<b>Antenna Gain (dBi):</b>	Not Applicable
<b>Modulation:</b>	CCK	<b>Beam Forming Gain (Y)(dB):</b>	Not Applicable
<b>TPC:</b>	Not Applicable	<b>Tested By:</b>	SB
<b>Engineering Test Notes:</b>			

Test Measurement Results
--------------------------

<b>Channel Frequency:</b>	2462.0 MHz					
<b>Band-Edge Frequency:</b>	2483.5 MHz					
<b>Test Frequency Range:</b>	2452.0 - 2524.0 MHz					
Port(s)	Band-Edge Markers and Limit			Revised Limit		Margin (MHz)
	M3 Amplitude (dBm)	Plot Limit (dBm)	M2 Frequency (MHz)	Amplitude (dBm)	M2A Frequency (MHz)	
a	<a href="#">-59.32</a>	-29.00	2470.20			-13.300

Traceability to Industry Recognized Test Methodologies	
Work Instruction:	WI-05 MEASUREMENT OF SPURIOUS EMISSIONS
Measurement Uncertainty:	<=40 GHz ±2.37 dB, > 40 GHz ±4.6 dB

Note: click the links in the above matrix to view the graphical image (plot).

This test report may be reproduced in full only. The document may only be updated by MiCOM Labs personnel. All changes will be noted in the Document History section of the report.





**Title:** Hewlett Packard Enterprise APINR203, APINP203  
**To:** FCC CFR 47 Part 15 Subpart C 15.247 (DTS)  
**Serial #:** HPEN96-U5\_Rev A (1x1)  
**Issue Date:** 23<sup>rd</sup> March 2017  
**Page:** 49 of 135

**Equipment Configuration for Conducted High Band-Edge Emissions - Average**

<b>Variant:</b>	802.11g	<b>Duty Cycle (%):</b>	99.0
<b>Data Rate:</b>	6.00 MBit/s	<b>Antenna Gain (dBi):</b>	Not Applicable
<b>Modulation:</b>	OFDM	<b>Beam Forming Gain (Y)(dB):</b>	Not Applicable
<b>TPC:</b>	Not Applicable	<b>Tested By:</b>	SB
<b>Engineering Test Notes:</b>			

**Test Measurement Results**

<b>Channel Frequency:</b>	2462.0 MHz					
<b>Band-Edge Frequency:</b>	2483.5 MHz					
<b>Test Frequency Range:</b>	2452.0 - 2524.0 MHz					
<b>Port(s)</b>	<b>Band-Edge Markers and Limit</b>			<b>Revised Limit</b>		<b>Margin</b>
	<b>M3 Amplitude (dBm)</b>	<b>Plot Limit (dBm)</b>	<b>M2 Frequency (MHz)</b>	<b>Amplitude (dBm)</b>	<b>M2A Frequency (MHz)</b>	<b>(MHz)</b>
<b>a</b>	<a href="#">-44.78</a>	-30.00	2472.20			-11.300

**Traceability to Industry Recognized Test Methodologies**

<b>Work Instruction:</b>	WI-05 MEASUREMENT OF SPURIOUS EMISSIONS
<b>Measurement Uncertainty:</b>	<=40 GHz ±2.37 dB, > 40 GHz ±4.6 dB

Note: click the links in the above matrix to view the graphical image (plot).

This test report may be reproduced in full only. The document may only be updated by MiCOM Labs personnel. All changes will be noted in the Document History section of the report.



**Title:** Hewlett Packard Enterprise APINR203, APINP203  
**To:** FCC CFR 47 Part 15 Subpart C 15.247 (DTS)  
**Serial #:** HPEN96-U5\_Rev A (1x1)  
**Issue Date:** 23<sup>rd</sup> March 2017  
**Page:** 50 of 135

**Equipment Configuration for Conducted High Band-Edge Emissions - Average**

<b>Variant:</b>	802.11n HT-20	<b>Duty Cycle (%):</b>	99.0
<b>Data Rate:</b>	6.50 MBit/s	<b>Antenna Gain (dBi):</b>	Not Applicable
<b>Modulation:</b>	OFDM	<b>Beam Forming Gain (Y)(dB):</b>	Not Applicable
<b>TPC:</b>	Not Applicable	<b>Tested By:</b>	SB
<b>Engineering Test Notes:</b>			

**Test Measurement Results**

<b>Channel Frequency:</b>	2462.0 MHz					
<b>Band-Edge Frequency:</b>	2483.5 MHz					
<b>Test Frequency Range:</b>	2452.0 - 2524.0 MHz					
<b>Port(s)</b>	<b>Band-Edge Markers and Limit</b>			<b>Revised Limit</b>		<b>Margin</b>
	<b>M3 Amplitude (dBm)</b>	<b>Plot Limit (dBm)</b>	<b>M2 Frequency (MHz)</b>	<b>Amplitude (dBm)</b>	<b>M2A Frequency (MHz)</b>	<b>(MHz)</b>
<b>a</b>	<a href="#">-49.78</a>	-32.00	2472.20			-11.300

**Traceability to Industry Recognized Test Methodologies**

<b>Work Instruction:</b>	WI-05 MEASUREMENT OF SPURIOUS EMISSIONS
<b>Measurement Uncertainty:</b>	<=40 GHz ±2.37 dB, > 40 GHz ±4.6 dB

Note: click the links in the above matrix to view the graphical image (plot).

This test report may be reproduced in full only. The document may only be updated by MiCOM Labs personnel. All changes will be noted in the Document History section of the report.



**Title:** Hewlett Packard Enterprise APINR203, APINP203  
**To:** FCC CFR 47 Part 15 Subpart C 15.247 (DTS)  
**Serial #:** HPEN96-U5\_Rev A (1x1)  
**Issue Date:** 23<sup>rd</sup> March 2017  
**Page:** 51 of 135

**Equipment Configuration for Conducted High Band-Edge Emissions - Average**

<b>Variant:</b>	802.11n HT-40	<b>Duty Cycle (%):</b>	95.0
<b>Data Rate:</b>	13.50 MBit/s	<b>Antenna Gain (dBi):</b>	Not Applicable
<b>Modulation:</b>	OFDM	<b>Beam Forming Gain (Y)(dB):</b>	Not Applicable
<b>TPC:</b>	Not Applicable	<b>Tested By:</b>	SB
<b>Engineering Test Notes:</b>			

**Test Measurement Results**

<b>Channel Frequency:</b>	2452.0 MHz					
<b>Band-Edge Frequency:</b>	2483.5 MHz					
<b>Test Frequency Range:</b>	2432.0 - 2582.0 MHz					
<b>Port(s)</b>	<b>Band-Edge Markers and Limit</b>			<b>Revised Limit</b>		<b>Margin</b>
	<b>M3 Amplitude (dBm)</b>	<b>Plot Limit (dBm)</b>	<b>M2 Frequency (MHz)</b>	<b>Amplitude (dBm)</b>	<b>M2A Frequency (MHz)</b>	<b>(MHz)</b>
<b>a</b>	<a href="#">-43.29</a>	-35.00	2470.80			-12.700

**Traceability to Industry Recognized Test Methodologies**

<b>Work Instruction:</b>	WI-05 MEASUREMENT OF SPURIOUS EMISSIONS
<b>Measurement Uncertainty:</b>	<=40 GHz ±2.37 dB, > 40 GHz ±4.6 dB

Note: click the links in the above matrix to view the graphical image (plot).

This test report may be reproduced in full only. The document may only be updated by MiCOM Labs personnel. All changes will be noted in the Document History section of the report.



### 9.4.2. Radiated Emissions

Radiated Test Conditions for Radiated Spurious and Band-Edge Emissions			
<b>Standard:</b>	FCC CFR 47:15.247 (DTS)	<b>Ambient Temp. (°C):</b>	20.0 - 24.5
<b>Test Heading:</b>	Radiated Spurious and Band-Edge Emissions	<b>Rel. Humidity (%):</b>	32 - 45
<b>Standard Section(s):</b>	15.247 (c), 15.205, 15.209	<b>Pressure (mBars):</b>	999 - 1001
<b>Reference Document(s):</b>	See Normative References		

#### Test Procedure for Radiated Spurious and Band-Edge Emissions

Radiated emissions for restricted bands above 1 GHz are measured in the anechoic chamber at a 3-meter distance on every azimuth in both horizontal and vertical polarities. The emissions are recorded and maximized as a function of azimuth by rotation through 360° with a spectrum analyzer in peak hold mode. Depending on the frequency band spanned a notch filter was used to remove the fundamental frequency. The highest emissions relative to the limit are listed for each frequency spanned. Measurements on any restricted band frequency or frequencies above 1 GHz are based on the use of measurement instrumentation employing peak and average detectors. All measurements were performed using a resolution bandwidth of 1 MHz.

Test configuration and setup for Undesirable Measurement were per the Radiated Test Set-up specified in this document.

15.407 (b) Undesirable emission limits. Except as shown in paragraph (b)(7) of this section, the maximum emissions outside of the frequency bands of operation shall be attenuated in accordance with the following limits:

- (1) For transmitters operating in the 5.15-5.25 GHz band: All emissions outside of the 5.15-5.35 GHz band shall not exceed an e.i.r.p. of -27 dBm/MHz.
- (2) For transmitters operating in the 5.25-5.35 GHz band: All emissions outside of the 5.15-5.35 GHz band shall not exceed an e.i.r.p. of -27 dBm/MHz.
- (3) For transmitters operating in the 5.47-5.725 GHz band: All emissions outside of the 5.47-5.725 GHz band shall not exceed an e.i.r.p. of -27 dBm/MHz.
- (4) For transmitters operating in the 5.725-5.85 GHz band: All emissions within the frequency range from the band edge to 10 MHz above or below the band edge shall not exceed an e.i.r.p. of -17 dBm/MHz; for frequencies 10 MHz or greater above or below the band edge, emissions shall not exceed an e.i.r.p. of -27 dBm/MHz.
- (5) The emission measurements shall be performed using a minimum resolution bandwidth of 1 MHz. A lower resolution bandwidth may be employed near the band edge, when necessary, provided the measured energy is integrated to show the total power over 1 MHz.
- (6) Unwanted emissions below 1 GHz must comply with the general field strength limits set forth in §15.209. Further, any U-NII devices using an AC power line are required to comply also with the conducted limits set forth in §15.207.
- (7) The provisions of §15.205 apply to intentional radiators operating under this section.
- (8) When measuring the emission limits, the nominal carrier frequency shall be adjusted as close to the upper and lower frequency band edges as the design of the equipment permits.

#### Limits for Restricted Bands (15.205, 15.209)

**Peak emission: 74 dBuV/m**

**Average emission: 54 dBuV/m**

#### Field Strength Calculation

The field strength is calculated by adding the Antenna Factor and Cable Loss, and subtracting Amplifier Gain from the measured reading. All factors are included in the reported data.

$$FS = R + AF + CORR - FO$$

where:

**FS = Field Strength**

**R = Measured Spectrum analyzer Input Amplitude**

**AF = Antenna Factor**

**CORR = Correction Factor = CL - AG + NFL**

**CL = Cable Loss**

**AG = Amplifier Gain**

This test report may be reproduced in full only. The document may only be updated by MiCOM Labs personnel. All changes will be noted in the Document History section of the report.



**FO = Distance Falloff Factor**  
**NFL = Notch Filter Loss**

**Example:**

The following formula is used to convert the equipment isotropic radiated power (eirp) to field strength (dBµV/m);

$$E = 1000000 \times \sqrt[3]{30P} / 3 \text{ } \mu\text{V/m}$$

where P is the EIRP in Watts

Therefore: -27 dBm/MHz equates to 68.23 dBuV/m

Conversion between dBmV/m (or dBmV) and mV/m (or mV) are as follows:

$$\text{Level (dBmV/m)} = 20 * \text{Log (level (mV/m))}$$

40 dBmV/m = 100 mV/m

48 dBmV/m = 250 mV/m

**Restricted Bands of Operation (15.205)**

(a) Except as shown in paragraph (d) of this section, only spurious emissions are permitted in any of the frequency bands listed below:

Frequency Band			
MHz	MHz	MHz	GHz
0.090-0.110	16.42-16.423	399.9-410	4.5-5.15
0.495-0.505	16.69475-16.69525	608-614	5.35-5.46
2.1735-2.1905	16.80425-16.80475	960-1240	7.25-7.75
4.125-4.128	25.5-25.67	1300-1427	8.025-8.5
4.17725-4.17775	37.5-38.25	1435-1626.5	9.0-9.2
4.20725-4.20775	73-74.6	1645.5-1646.5	9.3-9.5
6.215-6.218	74.8-75.2	1660-1710	10.6-12.7
6.26775-6.26825	108-121.94	1718.8-1722.2	13.25-13.4
6.31175-6.31225	123-138	2200-2300	14.47-14.5
8.291-8.294	149.9-150.05	2310-2390	15.35-16.2
8.362-8.366	156.52475-156.52525	2483.5-2500	17.7-21.4
8.37625-8.38675	156.7-156.9	2690-2900	22.01-23.12
8.41425-8.41475	162.0125-167.17	3260-3267	23.6-24.0
12.29-12.293	167.72-173.2	3332-3339	31.2-31.8
12.51975-12.52025	240-285	3345.8-3358	36.43-36.5
12.57675-12.57725	322-335.4	3600-4400	Above 38.6
13.36-13.41			

This test report may be reproduced in full only. The document may only be updated by MiCOM Labs personnel. All changes will be noted in the Document History section of the report.



**Title:** Hewlett Packard Enterprise APINR203, APINP203  
**To:** FCC CFR 47 Part 15 Subpart C 15.247 (DTS)  
**Serial #:** HPEN96-U5\_Rev A (1x1)  
**Issue Date:** 23<sup>rd</sup> March 2017  
**Page:** 54 of 135

---

(b) Except as provided in paragraphs (d) and (e) of this section, the field strength of emissions appearing within these frequency bands shall not exceed the limits shown in §15.209. At frequencies equal to or less than 1000 MHz, compliance with the limits in §15.209 shall be demonstrated using measurement instrumentation employing a CISPR quasi-peak detector. Above 1000 MHz, compliance with the emission limits in §15.209 shall be demonstrated based on the average value of the measured emissions. The provisions in §15.35 apply to these measurements.

(c) Except as provided in paragraphs (d) and (e) of this section, regardless of the field strength limits specified elsewhere in this subpart, the provisions of this section apply to emissions from any intentional radiator.

(d) The following devices are exempt from the requirements of this section:

- (1) Swept frequency field disturbance sensors operating between 1.705 and 37 MHz provided their emissions only sweep through the bands listed in paragraph (a) of this section, the sweep is never stopped with the fundamental emission within the bands listed in paragraph (a) of this section, and the fundamental emission is outside of the bands listed in paragraph (a) of this section more than 99% of the time the device is actively transmitting, without compensation for duty cycle.
- (2) Transmitters used to detect buried electronic markers at 101.4 kHz which are employed by telephone companies.
- (3) Cable locating equipment operated pursuant to §15.213.
- (4) Any equipment operated under the provisions of §15.253, 15.255, and 15.256 in the frequency band 75-85 GHz, or §15.257 of this part.
- (5) Biomedical telemetry devices operating under the provisions of §15.242 of this part are not subject to the restricted band 608-614 MHz but are subject to compliance within the other restricted bands.
- (6) Transmitters operating under the provisions of subparts D or F of this part.
- (7) Devices operated pursuant to §15.225 are exempt from complying with this section for the 13.36-13.41 MHz band only.
- (8) Devices operated in the 24.075-24.175 GHz band under §15.245 are exempt from complying with the requirements of this section for the 48.15-48.35 GHz and 72.225-72.525 GHz bands only, and shall not exceed the limits specified in §15.245(b).
- (9) Devices operated in the 24.0-24.25 GHz band under §15.249 are exempt from complying with the requirements of this section for the 48.0-48.5 GHz and 72.0-72.75 GHz bands only, and shall not exceed the limits specified in §15.249(a).

(e) Harmonic emissions appearing in the restricted bands above 17.7 GHz from field disturbance sensors operating under the provisions of §15.245 shall not exceed the limits specified in §15.245(b).

---

This test report may be reproduced in full only. The document may only be updated by MiCOM Labs personnel. All changes will be noted in the Document History section of the report.



**Title:** Hewlett Packard Enterprise APINR203, APINP203  
**To:** FCC CFR 47 Part 15 Subpart C 15.247 (DTS)  
**Serial #:** HPEN96-U5\_Rev A (1x1)  
**Issue Date:** 23<sup>rd</sup> March 2017  
**Page:** 55 of 135

### 9.4.2.1. TX Spurious & Restricted Band Emissions

#### Equipment Configuration for TX Spurious & Restricted Band Emissions

<b>Antenna:</b>	HPE Metal Sheet	<b>Variant:</b>	802.11b
<b>Antenna Gain (dBi):</b>	1.00	<b>Modulation:</b>	CCK
<b>Beam Forming Gain (Y):</b>	Not Applicable	<b>Duty Cycle (%):</b>	99
<b>Channel Frequency (MHz):</b>	2412.00	<b>Data Rate:</b>	1.00 MBit/s
<b>Power Setting:</b>	78	<b>Tested By:</b>	JMH

#### Test Measurement Results

1000.00 - 18000.00 MHz												
Num	Frequency MHz	Raw dBµV	Cable Loss dB	AF dB	Level dBµV/m	Measurement Type	Pol	Hgt cm	Azt Deg	Limit dBµV/m	Margin dB	Pass /Fail
#1	4823.95	62.34	3.54	-11.15	54.73	Max Peak	Vertical	179	92	74.0	-19.3	Pass
#2	4823.95	57.99	3.54	-11.15	50.38	Max Avg	Vertical	179	92	54.0	-3.6	Pass
#3	7234.96	59.59	4.26	-7.34	56.51	Peak (NRB)	Vertical	100	0	--	--	Pass
#4	9647.94	51.31	5.29	-6.08	50.52	Peak (NRB)	Vertical	100	0	--	--	Pass

Test Notes: AP203RP SN# CNCPK2T00L on 150cm table powered by AC.

This test report may be reproduced in full only. The document may only be updated by MiCOM Labs personnel. All changes will be noted in the Document History section of the report.



**Title:** Hewlett Packard Enterprise APINR203, APINP203  
**To:** FCC CFR 47 Part 15 Subpart C 15.247 (DTS)  
**Serial #:** HPEN96-U5\_Rev A (1x1)  
**Issue Date:** 23<sup>rd</sup> March 2017  
**Page:** 56 of 135

**Equipment Configuration for TX Spurious & Restricted Band Emissions**

<b>Antenna:</b>	HPE Metal Sheet	<b>Variant:</b>	802.11b
<b>Antenna Gain (dBi):</b>	1.00	<b>Modulation:</b>	CCK
<b>Beam Forming Gain (Y):</b>	Not Applicable	<b>Duty Cycle (%):</b>	99
<b>Channel Frequency (MHz):</b>	2437.00	<b>Data Rate:</b>	1.00 MBit/s
<b>Power Setting:</b>	78	<b>Tested By:</b>	JMH

**Test Measurement Results**

1000.00 - 18000.00 MHz												
Num	Frequency MHz	Raw dBµV	Cable Loss dB	AF dB	Level dBµV/m	Measurement Type	Pol	Hgt cm	Azt Deg	Limit dBµV/m	Margin dB	Pass /Fail
#1	2437.98	55.19	2.72	-11.73	46.18	Fundamental	Horizontal	100	0	--	--	
#2	4874.00	63.27	3.53	-11.24	55.56	Max Peak	Horizontal	102	338	74.0	-18.4	Pass
#3	4874.00	60.65	3.53	-11.24	52.94	Max Avg	Horizontal	102	338	54.0	-1.1	Pass
#4	7310.04	66.00	4.24	-7.29	62.95	Max Peak	Vertical	115	313	74.0	-11.1	Pass
#5	7310.04	56.30	4.24	-7.29	53.25	Max Avg	Vertical	115	313	54.0	-0.8	Pass
#6	9747.94	50.32	5.29	-6.23	49.38	Peak (NRB)	Vertical	100	0	--	--	Pass

Test Notes: AP203RP SN# CNCPK2T00L on 150cm table powered by AC.

This test report may be reproduced in full only. The document may only be updated by MiCOM Labs personnel. All changes will be noted in the Document History section of the report.





**Title:** Hewlett Packard Enterprise APINR203, APINP203  
**To:** FCC CFR 47 Part 15 Subpart C 15.247 (DTS)  
**Serial #:** HPEN96-U5\_Rev A (1x1)  
**Issue Date:** 23<sup>rd</sup> March 2017  
**Page:** 57 of 135

**Equipment Configuration for TX Spurious & Restricted Band Emissions**

<b>Antenna:</b>	HPE Metal Sheet	<b>Variant:</b>	802.11b
<b>Antenna Gain (dBi):</b>	1.00	<b>Modulation:</b>	CCK
<b>Beam Forming Gain (Y):</b>	Not Applicable	<b>Duty Cycle (%):</b>	99
<b>Channel Frequency (MHz):</b>	2462.00	<b>Data Rate:</b>	1.00 MBit/s
<b>Power Setting:</b>	78	<b>Tested By:</b>	JMH

**Test Measurement Results**

1000.00 - 18000.00 MHz												
Num	Frequency MHz	Raw dBµV	Cable Loss dB	AF dB	Level dBµV/m	Measurement Type	Pol	Hgt cm	Azt Deg	Limit dBµV/m	Margin dB	Pass /Fail
#1	2462.89	57.31	2.74	-11.67	48.38	Fundamental	Horizontal	100	0	--	--	
#2	4923.95	63.51	3.58	-11.38	55.71	Max Peak	Horizontal	98	70	74.0	-18.3	Pass
#3	4923.95	60.31	3.58	-11.38	52.51	Max Avg	Horizontal	98	70	54.0	-1.5	Pass
#4	7384.95	63.02	4.29	-7.17	60.14	Max Peak	Vertical	98	319	74.0	-13.9	Pass
#5	7384.95	54.04	4.29	-7.17	51.16	Max Avg	Vertical	98	319	54.0	-2.8	Pass
#6	9847.92	50.14	5.39	-5.94	49.59	Peak (NRB)	Horizontal	100	0	--	--	Pass

Test Notes: AP203RP SN# CNCPK2T00L on 150cm table powered by AC.

This test report may be reproduced in full only. The document may only be updated by MiCOM Labs personnel. All changes will be noted in the Document History section of the report.



**Title:** Hewlett Packard Enterprise APINR203, APINP203  
**To:** FCC CFR 47 Part 15 Subpart C 15.247 (DTS)  
**Serial #:** HPEN96-U5\_Rev A (1x1)  
**Issue Date:** 23<sup>rd</sup> March 2017  
**Page:** 58 of 135

---

#### 9.4.2.2. Restricted Edge & Band-Edge Emissions

HPE Metal Sheet		Band-Edge Freq	Limit 74.0dB $\mu$ V/m	Limit 54.0dB $\mu$ V/m	Power Setting
Operational Mode	Operating Frequency (MHz)	MHz	dB $\mu$ V/m	dB $\mu$ V/m	
802.11b	2412.00	2390.00	57.81	50.86	78
802.11b	2462.00	2483.50	57.32	42.43	78
802.11g	2412.00	2390.00	72.55	52.79	77
802.11g	2462.00	2483.50	63.73	46.81	78
802.11n HT-20	2412.00	2390.00	73.89	50.49	78
802.11n HT-20	2462.00	2483.50	65.99	43.36	78
802.11n HT-40	2422.00	2390.00	73.41	51.55	74
802.11n HT-40	2452.00	2483.50	71.45	51.80	78

Click on the links to view the data.

---

This test report may be reproduced in full only. The document may only be updated by MiCOM Labs personnel. All changes will be noted in the Document History section of the report.



**Title:** Hewlett Packard Enterprise APINR203, APINP203  
**To:** FCC CFR 47 Part 15 Subpart C 15.247 (DTS)  
**Serial #:** HPEN96-U5\_Rev A (1x1)  
**Issue Date:** 23<sup>rd</sup> March 2017  
**Page:** 59 of 135

**Equipment Configuration for Radiated - Lower Restricted Band-Edge Emissions**

<b>Antenna:</b>	HPE Metal Sheet	<b>Variant:</b>	802.11b
<b>Antenna Gain (dBi):</b>	1.00	<b>Modulation:</b>	CCK
<b>Beam Forming Gain (Y):</b>	Not Applicable	<b>Duty Cycle (%):</b>	99
<b>Channel Frequency (MHz):</b>	2412.00	<b>Data Rate:</b>	1.00 MBit/s
<b>Power Setting:</b>	78	<b>Tested By:</b>	JMH

**Test Measurement Results**

**2310.00 - 2422.00 MHz**

Num	Frequency MHz	Raw dB $\mu$ V	Cable Loss dB	AF dB	Level dB $\mu$ V/m	Measurement Type	Pol	Hgt cm	Azt Deg	Limit dB $\mu$ V/m	Margin dB	Pass /Fail
#1	2385.41	16.18	2.68	32.00	50.86	Max Avg	Horizontal	190	334	54.0	-3.1	Pass
#2	2385.74	23.12	2.68	32.01	57.81	Max Peak	Horizontal	190	334	74.0	-16.2	Pass
#3	2390.00	--	--	--	--	Restricted-Band	--	--	--	--	--	--

Test Notes: EUT on 150cm table powered by AC.

This test report may be reproduced in full only. The document may only be updated by MiCOM Labs personnel. All changes will be noted in the Document History section of the report.



**Title:** Hewlett Packard Enterprise APINR203, APINP203  
**To:** FCC CFR 47 Part 15 Subpart C 15.247 (DTS)  
**Serial #:** HPEN96-U5\_Rev A (1x1)  
**Issue Date:** 23<sup>rd</sup> March 2017  
**Page:** 60 of 135

**Equipment Configuration for Radiated - Lower Restricted Band-Edge Emissions**

<b>Antenna:</b>	HPE Metal Sheet	<b>Variant:</b>	802.11g
<b>Antenna Gain (dBi):</b>	1.00	<b>Modulation:</b>	OFDM
<b>Beam Forming Gain (Y):</b>	Not Applicable	<b>Duty Cycle (%):</b>	99
<b>Channel Frequency (MHz):</b>	2412.00	<b>Data Rate:</b>	6.00 MBit/s
<b>Power Setting:</b>	77	<b>Tested By:</b>	JMH

**Test Measurement Results**

2310.00 - 2422.00 MHz												
Num	Frequency MHz	Raw dBµV	Cable Loss dB	AF dB	Level dBµV/m	Measurement Type	Pol	Hgt cm	Azt Deg	Limit dBµV/m	Margin dB	Pass /Fail
#1	2384.74	37.87	2.68	32.00	72.55	Max Peak	Horizontal	190	334	74.0	-1.5	Pass
#2	2386.63	18.09	2.68	32.02	52.79	Max Avg	Horizontal	190	334	54.0	-1.2	Pass
#3	2390.00	--	--	--	--	Restricted-Band	--	--	--	--	--	--

Test Notes: EUT on 150cm table powered by AC. Power reduced to 77 to meet band edge limit.

This test report may be reproduced in full only. The document may only be updated by MiCOM Labs personnel. All changes will be noted in the Document History section of the report.



**Title:** Hewlett Packard Enterprise APINR203, APINP203  
**To:** FCC CFR 47 Part 15 Subpart C 15.247 (DTS)  
**Serial #:** HPEN96-U5\_Rev A (1x1)  
**Issue Date:** 23<sup>rd</sup> March 2017  
**Page:** 61 of 135

**Equipment Configuration for Radiated - Lower Restricted Band-Edge Emissions**

<b>Antenna:</b>	HPE Metal Sheet	<b>Variant:</b>	802.11n HT-20
<b>Antenna Gain (dBi):</b>	1.00	<b>Modulation:</b>	OFDM
<b>Beam Forming Gain (Y):</b>	Not Applicable	<b>Duty Cycle (%):</b>	99
<b>Channel Frequency (MHz):</b>	2412.00	<b>Data Rate:</b>	6.50 MBit/s
<b>Power Setting:</b>	78	<b>Tested By:</b>	JMH

**Test Measurement Results**

**2310.00 - 2422.00 MHz**

Num	Frequency MHz	Raw dB $\mu$ V	Cable Loss dB	AF dB	Level dB $\mu$ V/m	Measurement Type	Pol	Hgt cm	Azt Deg	Limit dB $\mu$ V/m	Margin dB	Pass /Fail
#1	2385.51	15.80	2.68	32.01	50.49	Max Avg	Horizontal	190	334	54.0	-3.5	Pass
#2	2387.53	39.18	2.68	32.03	73.89	Max Peak	Horizontal	190	334	74.0	-0.1	Pass
#3	2390.00	--	--	--	--	Restricted-Band	--	--	--	--	--	--

Test Notes: EUT on 150cm table powered by AC.

This test report may be reproduced in full only. The document may only be updated by MiCOM Labs personnel. All changes will be noted in the Document History section of the report.



**Title:** Hewlett Packard Enterprise APINR203, APINP203  
**To:** FCC CFR 47 Part 15 Subpart C 15.247 (DTS)  
**Serial #:** HPEN96-U5\_Rev A (1x1)  
**Issue Date:** 23<sup>rd</sup> March 2017  
**Page:** 62 of 135

**Equipment Configuration for Radiated - Lower Restricted Band-Edge Emissions**

<b>Antenna:</b>	HPE Metal Sheet	<b>Variant:</b>	802.11n HT-40
<b>Antenna Gain (dBi):</b>	1.00	<b>Modulation:</b>	OFDM
<b>Beam Forming Gain (Y):</b>	Not Applicable	<b>Duty Cycle (%):</b>	99
<b>Channel Frequency (MHz):</b>	2422.00	<b>Data Rate:</b>	13.50 MBit/s
<b>Power Setting:</b>	74	<b>Tested By:</b>	JMH

**Test Measurement Results**

**2310.00 - 2422.00 MHz**

Num	Frequency MHz	Raw dBµV	Cable Loss dB	AF dB	Level dBµV/m	Measurement Type	Pol	Hgt cm	Azt Deg	Limit dBµV/m	Margin dB	Pass /Fail
#1	2385.74	16.86	2.68	32.01	51.55	Max Avg	Horizontal	190	334	54.0	-2.5	Pass
#2	2386.63	38.71	2.68	32.02	73.41	Max Peak	Horizontal	190	334	74.0	-0.6	Pass
#3	2390.00	--	--	--	--	Restricted-Band	--	--	--	--	--	--

Test Notes: EUT on 150cm table powered by AC. Power reduced to 74 to meet band edge limit

This test report may be reproduced in full only. The document may only be updated by MiCOM Labs personnel. All changes will be noted in the Document History section of the report.



**Title:** Hewlett Packard Enterprise APINR203, APINP203  
**To:** FCC CFR 47 Part 15 Subpart C 15.247 (DTS)  
**Serial #:** HPEN96-U5\_Rev A (1x1)  
**Issue Date:** 23<sup>rd</sup> March 2017  
**Page:** 63 of 135

**Equipment Configuration for Radiated - Upper Restricted Band-Edge Emissions**

<b>Antenna:</b>	HPE Metal Sheet	<b>Variant:</b>	802.11b
<b>Antenna Gain (dBi):</b>	1.00	<b>Modulation:</b>	CCK
<b>Beam Forming Gain (Y):</b>	Not Applicable	<b>Duty Cycle (%):</b>	99
<b>Channel Frequency (MHz):</b>	2462.00	<b>Data Rate:</b>	1.00 MBit/s
<b>Power Setting:</b>	78	<b>Tested By:</b>	JMH

**Test Measurement Results**

2452.00 - 2500.00 MHz												
Num	Frequency MHz	Raw dBµV	Cable Loss dB	AF dB	Level dBµV/m	Measurement Type	Pol	Hgt cm	Azt Deg	Limit dBµV/m	Margin dB	Pass /Fail
#2	2488.75	7.32	2.73	32.38	42.43	Max Avg	Horizontal	190	334	54.0	-11.6	Pass
#3	2499.52	22.19	2.73	32.40	57.32	Max Peak	Horizontal	190	334	74.0	-16.7	Pass
#1	2483.50	--	--	--	--	Restricted-Band	--	--	--	--	--	--

Test Notes: EUT on 150cm table powered by AC.

This test report may be reproduced in full only. The document may only be updated by MiCOM Labs personnel. All changes will be noted in the Document History section of the report.



**Title:** Hewlett Packard Enterprise APINR203, APINP203  
**To:** FCC CFR 47 Part 15 Subpart C 15.247 (DTS)  
**Serial #:** HPEN96-U5\_Rev A (1x1)  
**Issue Date:** 23<sup>rd</sup> March 2017  
**Page:** 64 of 135

**Equipment Configuration for Radiated - Upper Restricted Band-Edge Emissions**

<b>Antenna:</b>	HPE Metal Sheet	<b>Variant:</b>	802.11g
<b>Antenna Gain (dBi):</b>	1.00	<b>Modulation:</b>	OFDM
<b>Beam Forming Gain (Y):</b>	Not Applicable	<b>Duty Cycle (%):</b>	99
<b>Channel Frequency (MHz):</b>	2462.00	<b>Data Rate:</b>	6.00 MBit/s
<b>Power Setting:</b>	78	<b>Tested By:</b>	JMH

**Test Measurement Results**

**2452.00 - 2500.00 MHz**

Num	Frequency MHz	Raw dB $\mu$ V	Cable Loss dB	AF dB	Level dB $\mu$ V/m	Measurement Type	Pol	Hgt cm	Azt Deg	Limit dB $\mu$ V/m	Margin dB	Pass /Fail
#1	2483.50	11.71	2.73	32.37	46.81	Max Avg	Horizontal	190	334	54.0	-7.2	Pass
#2	2483.50	28.63	2.73	32.37	63.73	Max Peak	Horizontal	190	334	74.0	-10.3	Pass
#3	2483.50	--	--	--	--	Restricted-Band	--	--	--	--	--	--

Test Notes: EUT on 150cm table powered by AC.

This test report may be reproduced in full only. The document may only be updated by MiCOM Labs personnel. All changes will be noted in the Document History section of the report.





**Title:** Hewlett Packard Enterprise APINR203, APINP203  
**To:** FCC CFR 47 Part 15 Subpart C 15.247 (DTS)  
**Serial #:** HPEN96-U5\_Rev A (1x1)  
**Issue Date:** 23<sup>rd</sup> March 2017  
**Page:** 65 of 135

**Equipment Configuration for Radiated - Upper Restricted Band-Edge Emissions**

<b>Antenna:</b>	HPE Metal Sheet	<b>Variant:</b>	802.11n HT-20
<b>Antenna Gain (dBi):</b>	1.00	<b>Modulation:</b>	OFDM
<b>Beam Forming Gain (Y):</b>	Not Applicable	<b>Duty Cycle (%):</b>	99
<b>Channel Frequency (MHz):</b>	2462.00	<b>Data Rate:</b>	6.50 MBit/s
<b>Power Setting:</b>	78	<b>Tested By:</b>	JMH

**Test Measurement Results**

**2452.00 - 2500.00 MHz**

Num	Frequency MHz	Raw dB $\mu$ V	Cable Loss dB	AF dB	Level dB $\mu$ V/m	Measurement Type	Pol	Hgt cm	Azt Deg	Limit dB $\mu$ V/m	Margin dB	Pass /Fail
#2	2483.58	8.26	2.73	32.37	43.36	Max Avg	Horizontal	190	334	54.0	-10.6	Pass
#3	2483.94	30.89	2.73	32.37	65.99	Max Peak	Horizontal	190	334	74.0	-8.0	Pass
#1	2483.50	--	--	--	--	Restricted-Band	--	--	--	--	--	--

Test Notes: EUT on 150cm table powered by AC.

This test report may be reproduced in full only. The document may only be updated by MiCOM Labs personnel. All changes will be noted in the Document History section of the report.



**Title:** Hewlett Packard Enterprise APINR203, APINP203  
**To:** FCC CFR 47 Part 15 Subpart C 15.247 (DTS)  
**Serial #:** HPEN96-U5\_Rev A (1x1)  
**Issue Date:** 23<sup>rd</sup> March 2017  
**Page:** 66 of 135

**Equipment Configuration for Radiated - Upper Restricted Band-Edge Emissions**

<b>Antenna:</b>	HPE Metal Sheet	<b>Variant:</b>	802.11n HT-40
<b>Antenna Gain (dBi):</b>	1.00	<b>Modulation:</b>	OFDM
<b>Beam Forming Gain (Y):</b>	Not Applicable	<b>Duty Cycle (%):</b>	99
<b>Channel Frequency (MHz):</b>	2452.00	<b>Data Rate:</b>	13.50 MBit/s
<b>Power Setting:</b>	78	<b>Tested By:</b>	JMH

**Test Measurement Results**

2452.00 - 2500.00 MHz												
Num	Frequency MHz	Raw dBµV	Cable Loss dB	AF dB	Level dBµV/m	Measurement Type	Pol	Hgt cm	Azt Deg	Limit dBµV/m	Margin dB	Pass /Fail
#2	2483.84	16.70	2.73	32.37	51.80	Max Avg	Horizontal	190	334	54.0	-2.2	Pass
#3	2492.02	36.33	2.74	32.38	71.45	Max Peak	Horizontal	190	334	74.0	-2.6	Pass
#1	2483.50	--	--	--	--	Restricted-Band	--	--	--	--	--	--

Test Notes: EUT on 150cm table powered by AC.

This test report may be reproduced in full only. The document may only be updated by MiCOM Labs personnel. All changes will be noted in the Document History section of the report.



**Title:** Hewlett Packard Enterprise APINR203, APINP203  
**To:** FCC CFR 47 Part 15 Subpart C 15.247 (DTS)  
**Serial #:** HPEN96-U5\_Rev A (1x1)  
**Issue Date:** 23<sup>rd</sup> March 2017  
**Page:** 67 of 135

---

## **A. APPENDIX - GRAPHICAL IMAGES**

---

This test report may be reproduced in full only. The document may only be updated by MiCOM Labs personnel. All changes will be noted in the Document History section of the report.



### A.1. 6 dB & 99% Bandwidth

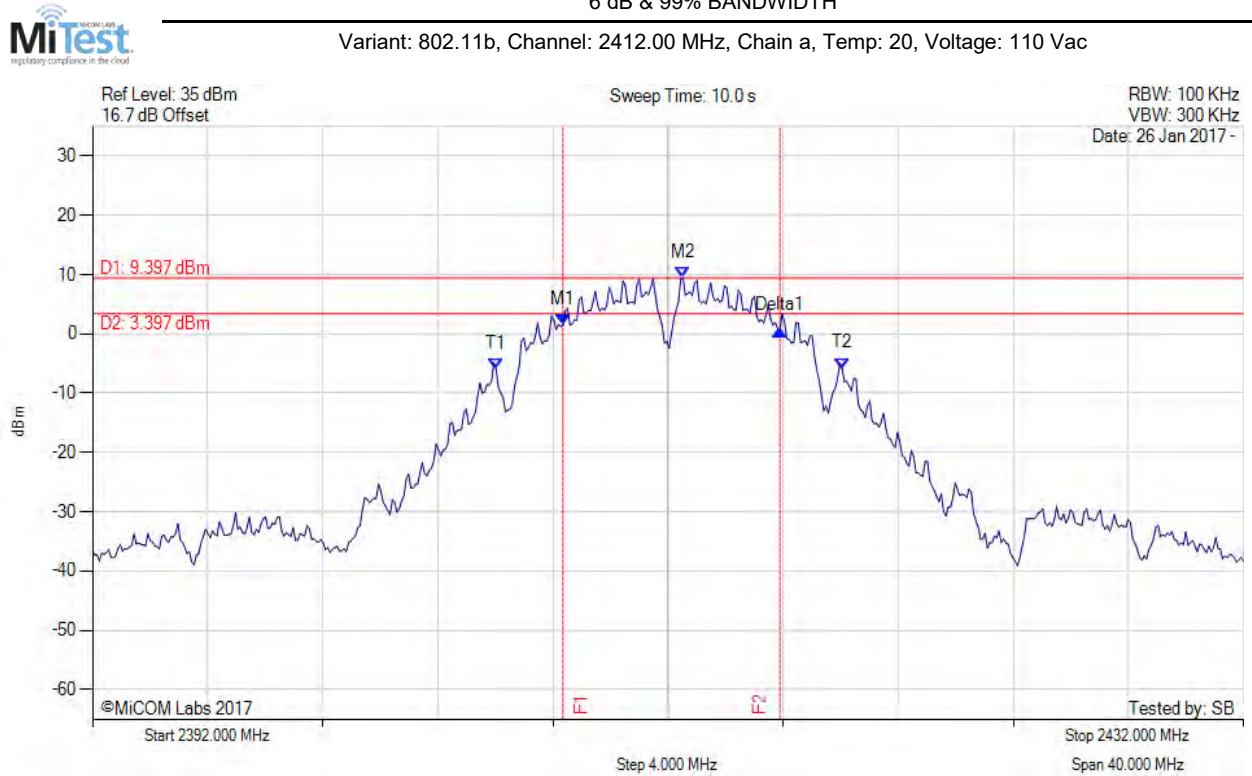

Analyzer Setup	Marker:Frequency:Amplitude	Test Results
Detector = MAX PEAK Sweep Count = 0 RF Atten (dB) = 30 Trace Mode = MAX HOLD	M1 : 2408.353 MHz : 1.486 dBm M2 : 2412.521 MHz : 9.397 dBm Delta1 : 7.535 MHz : -0.897 dB T1 : 2406.028 MHz : -5.994 dBm T2 : 2418.052 MHz : -5.809 dBm OBW : 12.024 MHz	Measured 6 dB Bandwidth: 7.535 MHz Limit: $\geq 500.0$ kHz Margin: -7.04 MHz

[back to matrix](#)

This test report may be reproduced in full only. The document may only be updated by MiCOM Labs personnel. All changes will be noted in the Document History section of the report.



**Title:** Hewlett Packard Enterprise APINR203, APINP203  
**To:** FCC CFR 47 Part 15 Subpart C 15.247 (DTS)  
**Serial #:** HPEN96-U5\_Rev A (1x1)  
**Issue Date:** 23rd March 2017  
**Page:** 69 of 135



6 dB & 99% BANDWIDTH

Variant: 802.11b, Channel: 2437.00 MHz, Chain a, Temp: 20, Voltage: 110 Vac

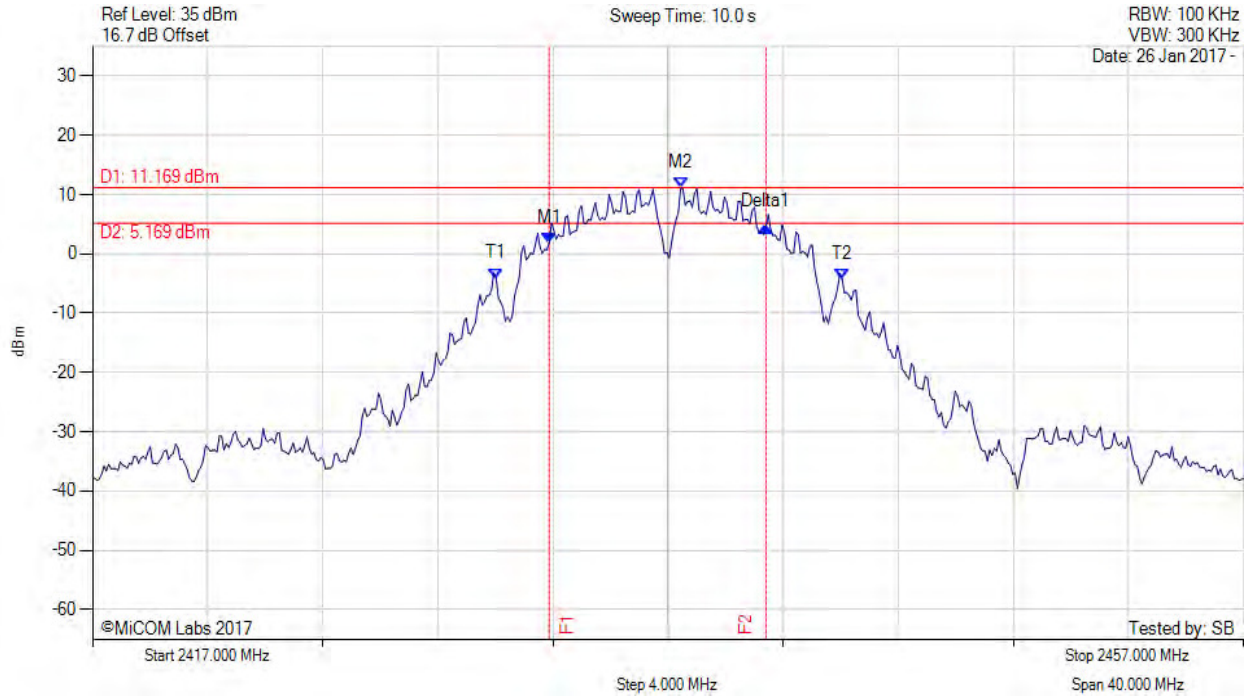

Analyzer Setup	Marker:Frequency:Amplitude	Test Results
Detector = MAX PEAK Sweep Count = 0 RF Atten (dB) = 30 Trace Mode = MAX HOLD	M1 : 2432.872 MHz : 1.844 dBm M2 : 2437.441 MHz : 11.169 dBm Delta1 : 7.535 MHz : 2.766 dB T1 : 2431.028 MHz : -4.180 dBm T2 : 2443.052 MHz : -4.259 dBm OBW : 12.024 MHz	Measured 6 dB Bandwidth: 7.535 MHz Limit: ≥500.0 kHz Margin: -7.04 MHz

[back to matrix](#)

This test report may be reproduced in full only. The document may only be updated by MiCOM Labs personnel. All changes will be noted in the Document History section of the report.



**Title:** Hewlett Packard Enterprise APINR203, APINP203  
**To:** FCC CFR 47 Part 15 Subpart C 15.247 (DTS)  
**Serial #:** HPEN96-U5\_Rev A (1x1)  
**Issue Date:** 23<sup>rd</sup> March 2017  
**Page:** 70 of 135



6 dB & 99% BANDWIDTH

Variant: 802.11b, Channel: 2462.00 MHz, Chain a, Temp: 20, Voltage: 110 Vac

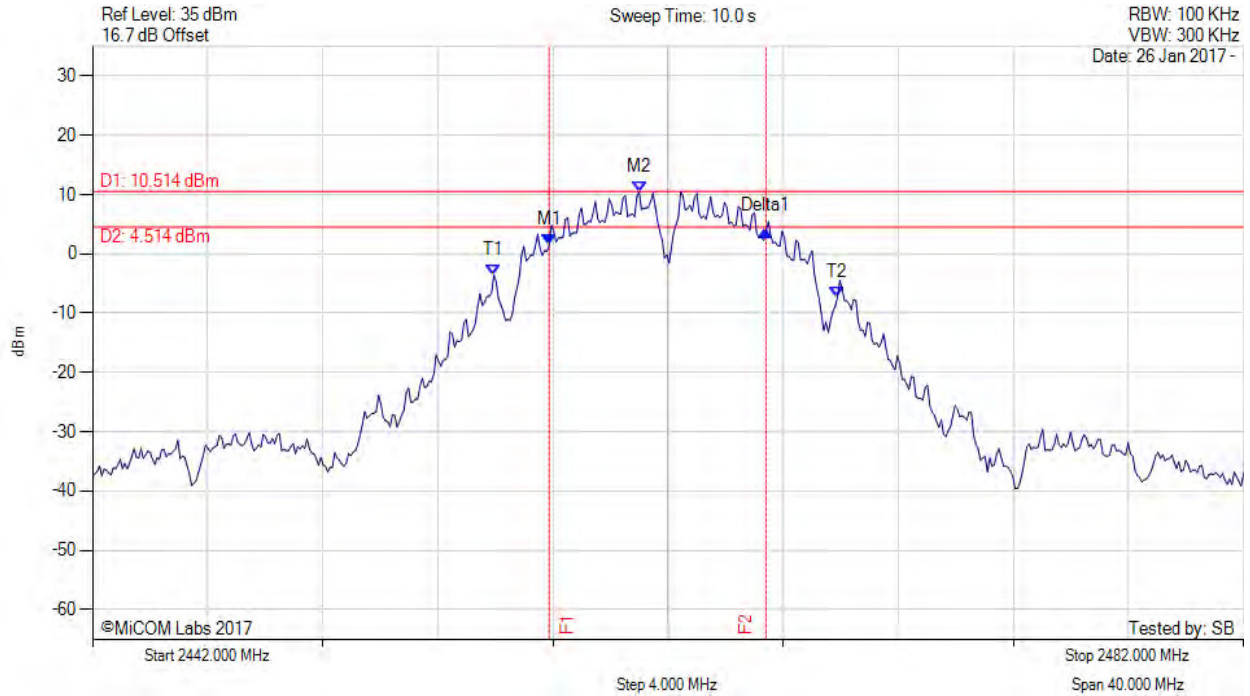

Analyzer Setup	Marker:Frequency:Amplitude	Test Results
Detector = MAX PEAK Sweep Count = 0 RF Atten (dB) = 30 Trace Mode = MAX HOLD	M1 : 2457.872 MHz : 1.494 dBm M2 : 2460.998 MHz : 10.514 dBm Delta1 : 7.535 MHz : 2.331 dB T1 : 2455.948 MHz : -3.572 dBm T2 : 2467.892 MHz : -7.273 dBm OBW : 11.944 MHz	Measured 6 dB Bandwidth: 7.535 MHz Limit: ≥500.0 kHz Margin: -7.04 MHz

[back to matrix](#)

This test report may be reproduced in full only. The document may only be updated by MiCOM Labs personnel. All changes will be noted in the Document History section of the report.



**Title:** Hewlett Packard Enterprise APINR203, APINP203  
**To:** FCC CFR 47 Part 15 Subpart C 15.247 (DTS)  
**Serial #:** HPEN96-U5\_Rev A (1x1)  
**Issue Date:** 23rd March 2017  
**Page:** 71 of 135

6 dB & 99% BANDWIDTH



Variant: 802.11g, Channel: 2412.00 MHz, Chain a, Temp: 20, Voltage: 110 Vac

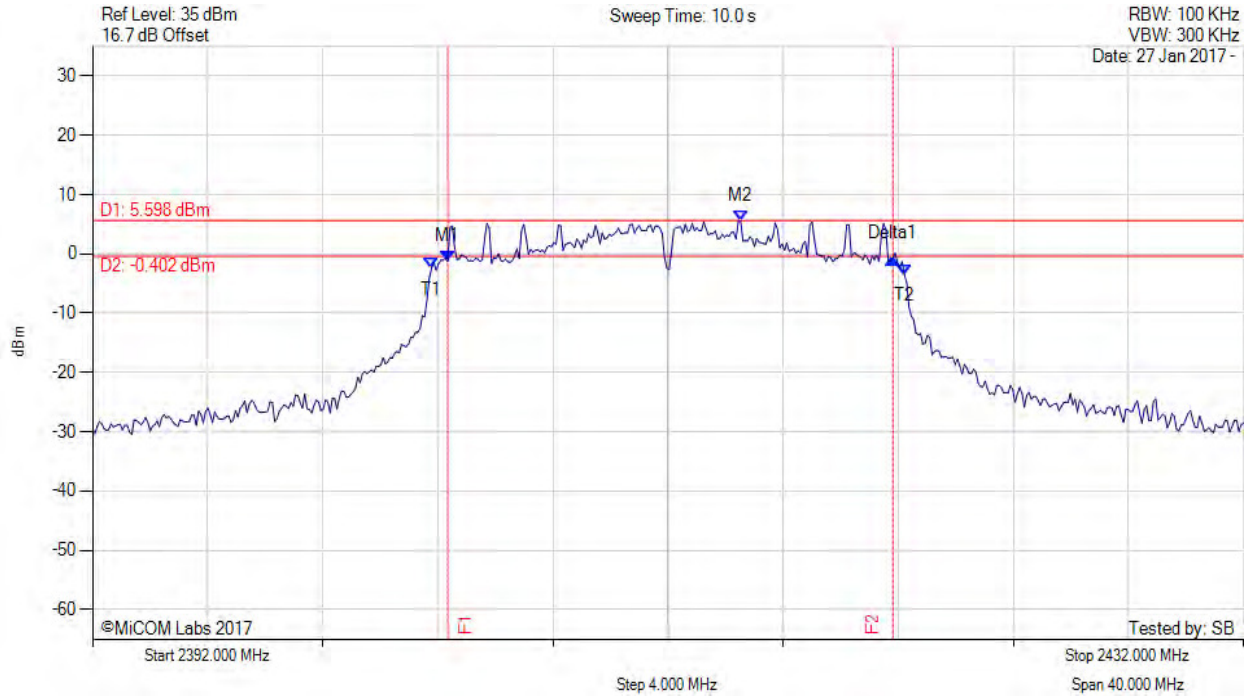

Analyzer Setup	Marker:Frequency:Amplitude	Test Results
Detector = MAX PEAK Sweep Count = 0 RF Atten (dB) = 30 Trace Mode = MAX HOLD	M1 : 2404.345 MHz : -1.280 dBm M2 : 2414.525 MHz : 5.598 dBm Delta1 : 15.471 MHz : 0.519 dB T1 : 2403.784 MHz : -2.415 dBm T2 : 2420.216 MHz : -3.542 dBm OBW : 16.433 MHz	Measured 6 dB Bandwidth: 15.471 MHz Limit: $\geq 500.0$ kHz Margin: -14.97 MHz

[back to matrix](#)

This test report may be reproduced in full only. The document may only be updated by MiCOM Labs personnel. All changes will be noted in the Document History section of the report.



**Title:** Hewlett Packard Enterprise APINR203, APINP203  
**To:** FCC CFR 47 Part 15 Subpart C 15.247 (DTS)  
**Serial #:** HPEN96-U5\_Rev A (1x1)  
**Issue Date:** 23rd March 2017  
**Page:** 72 of 135



6 dB & 99% BANDWIDTH

Variant: 802.11g, Channel: 2437.00 MHz, Chain a, Temp: 20, Voltage: 110 Vac

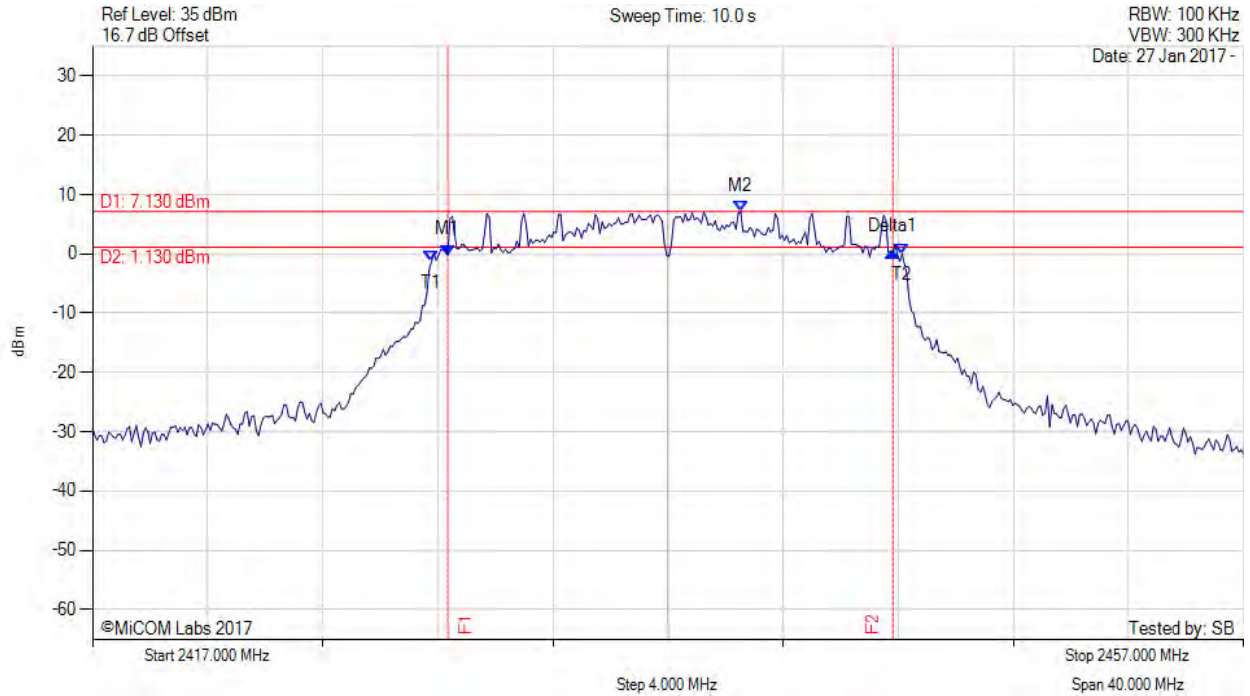

Analyzer Setup	Marker:Frequency:Amplitude	Test Results
Detector = MAX PEAK Sweep Count = 0 RF Atten (dB) = 30 Trace Mode = MAX HOLD	M1 : 2429.345 MHz : -0.208 dBm M2 : 2439.525 MHz : 7.130 dBm Delta1 : 15.471 MHz : 0.515 dB T1 : 2428.784 MHz : -1.229 dBm T2 : 2445.136 MHz : -0.019 dBm OBW : 16.353 MHz	Measured 6 dB Bandwidth: 15.471 MHz Limit: ≥500.0 kHz Margin: -14.97 MHz

[back to matrix](#)

This test report may be reproduced in full only. The document may only be updated by MiCOM Labs personnel. All changes will be noted in the Document History section of the report.





**Title:** Hewlett Packard Enterprise APINR203, APINP203  
**To:** FCC CFR 47 Part 15 Subpart C 15.247 (DTS)  
**Serial #:** HPEN96-U5\_Rev A (1x1)  
**Issue Date:** 23rd March 2017  
**Page:** 73 of 135



6 dB & 99% BANDWIDTH

Variant: 802.11g, Channel: 2462.00 MHz, Chain a, Temp: 20, Voltage: 110 Vac

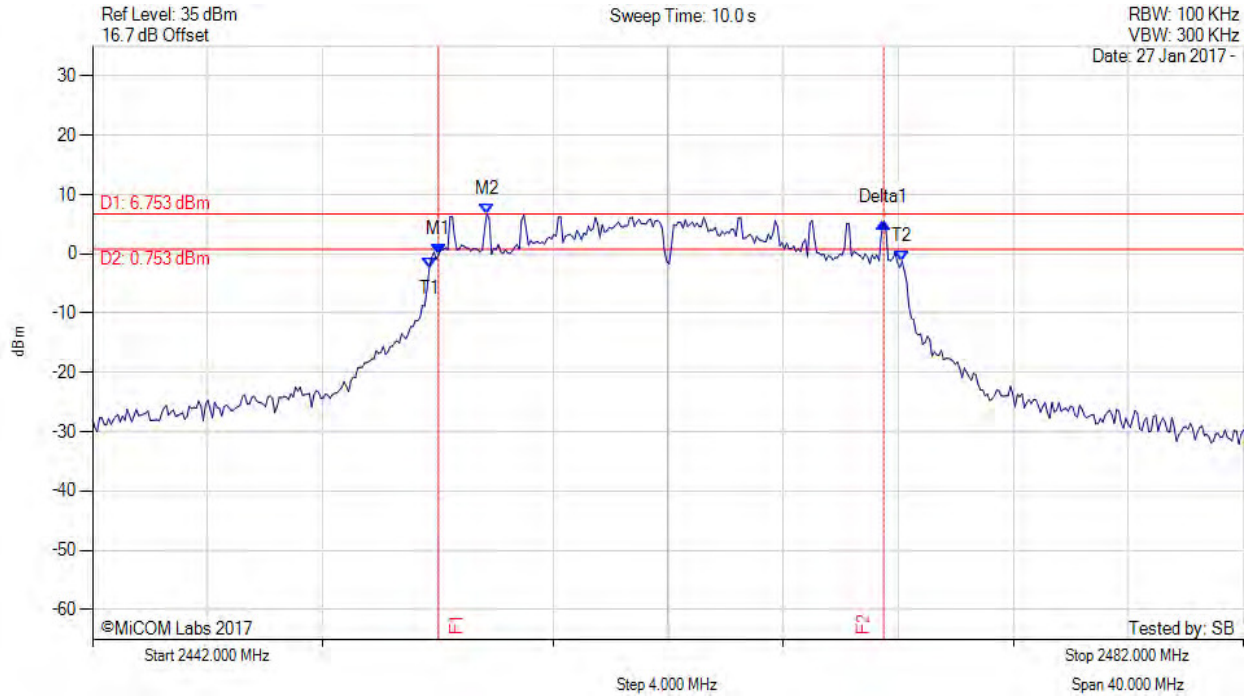

Analyzer Setup	Marker: Frequency: Amplitude	Test Results
Detector = MAX PEAK Sweep Count = 0 RF Atten (dB) = 30 Trace Mode = MAX HOLD	M1 : 2454.024 MHz : -0.003 dBm M2 : 2455.707 MHz : 6.753 dBm Delta1 : 15.471 MHz : 5.276 dB T1 : 2453.703 MHz : -2.368 dBm T2 : 2470.136 MHz : -1.252 dBm OBW : 16.433 MHz	Measured 6 dB Bandwidth: 15.471 MHz Limit: ≥500.0 kHz Margin: -14.97 MHz

[back to matrix](#)

This test report may be reproduced in full only. The document may only be updated by MiCOM Labs personnel. All changes will be noted in the Document History section of the report.



**Title:** Hewlett Packard Enterprise APINR203, APINP203  
**To:** FCC CFR 47 Part 15 Subpart C 15.247 (DTS)  
**Serial #:** HPEN96-U5\_Rev A (1x1)  
**Issue Date:** 23<sup>rd</sup> March 2017  
**Page:** 74 of 135



6 dB & 99% BANDWIDTH

Variant: 802.11n HT-20, Channel: 2412.00 MHz, Chain a, Temp: 20, Voltage: 110 Vac

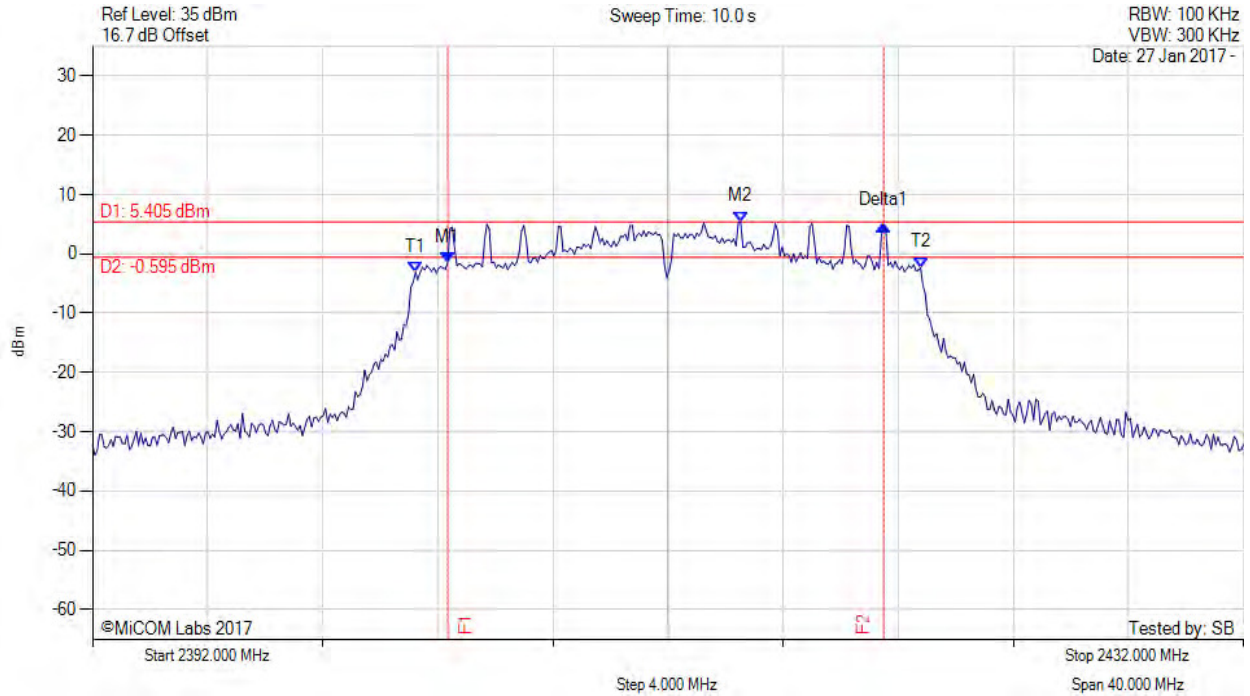

Analyzer Setup	Marker:Frequency:Amplitude	Test Results
Detector = MAX PEAK Sweep Count = 0 RF Atten (dB) = 30 Trace Mode = MAX HOLD	M1 : 2404.345 MHz : -1.420 dBm M2 : 2414.525 MHz : 5.405 dBm Delta1 : 15.150 MHz : 6.313 dB T1 : 2403.222 MHz : -3.131 dBm T2 : 2420.778 MHz : -2.311 dBm OBW : 17.555 MHz	Measured 6 dB Bandwidth: 15.150 MHz Limit: ≥500.0 kHz Margin: -14.65 MHz

[back to matrix](#)

This test report may be reproduced in full only. The document may only be updated by MiCOM Labs personnel. All changes will be noted in the Document History section of the report.



**Title:** Hewlett Packard Enterprise APINR203, APINP203  
**To:** FCC CFR 47 Part 15 Subpart C 15.247 (DTS)  
**Serial #:** HPEN96-U5\_Rev A (1x1)  
**Issue Date:** 23rd March 2017  
**Page:** 75 of 135

6 dB & 99% BANDWIDTH



Variant: 802.11n HT-20, Channel: 2437.00 MHz, Chain a, Temp: 20, Voltage: 110 Vac

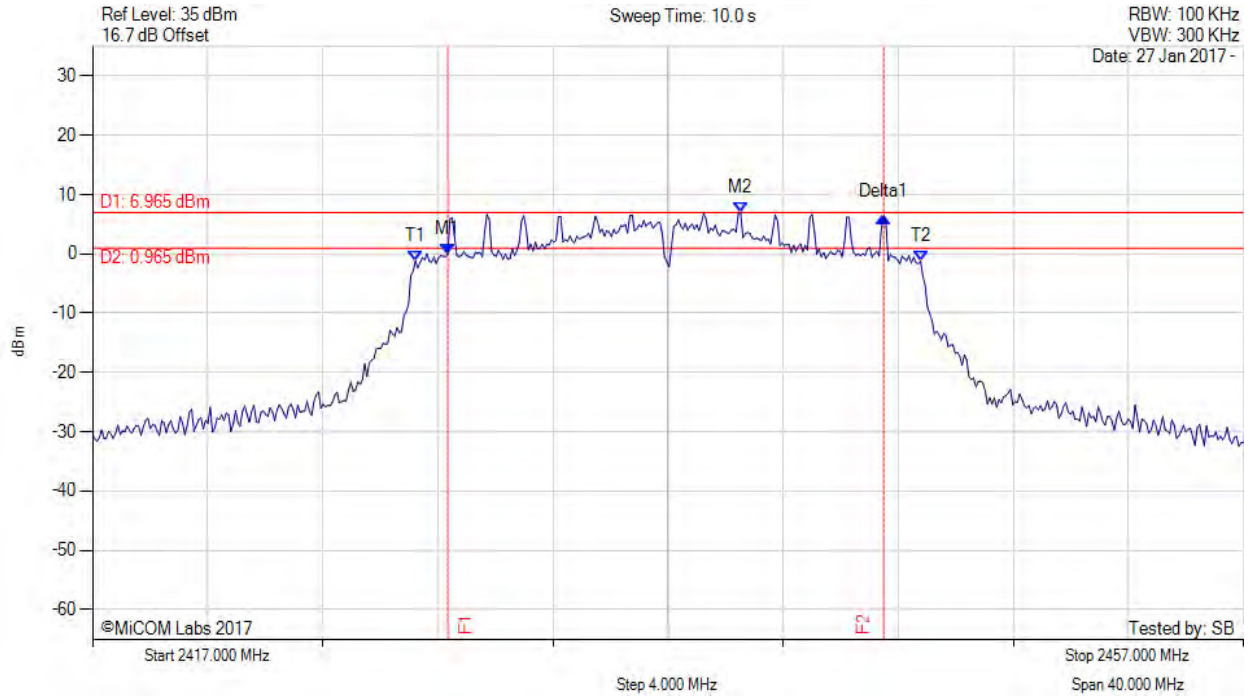

Analyzer Setup	Marker:Frequency:Amplitude	Test Results
Detector = MAX PEAK Sweep Count = 0 RF Atten (dB) = 30 Trace Mode = MAX HOLD	M1 : 2429.345 MHz : -0.058 dBm M2 : 2439.525 MHz : 6.965 dBm Delta1 : 15.150 MHz : 6.299 dB T1 : 2428.222 MHz : -1.168 dBm T2 : 2445.778 MHz : -1.243 dBm OBW : 17.555 MHz	Measured 6 dB Bandwidth: 15.150 MHz Limit: ≥500.0 kHz Margin: -14.65 MHz

[back to matrix](#)

This test report may be reproduced in full only. The document may only be updated by MiCOM Labs personnel. All changes will be noted in the Document History section of the report.



**Title:** Hewlett Packard Enterprise APINR203, APINP203  
**To:** FCC CFR 47 Part 15 Subpart C 15.247 (DTS)  
**Serial #:** HPEN96-U5\_Rev A (1x1)  
**Issue Date:** 23rd March 2017  
**Page:** 76 of 135

6 dB & 99% BANDWIDTH



Variant: 802.11n HT-20, Channel: 2462.00 MHz, Chain a, Temp: 20, Voltage: 110 Vac

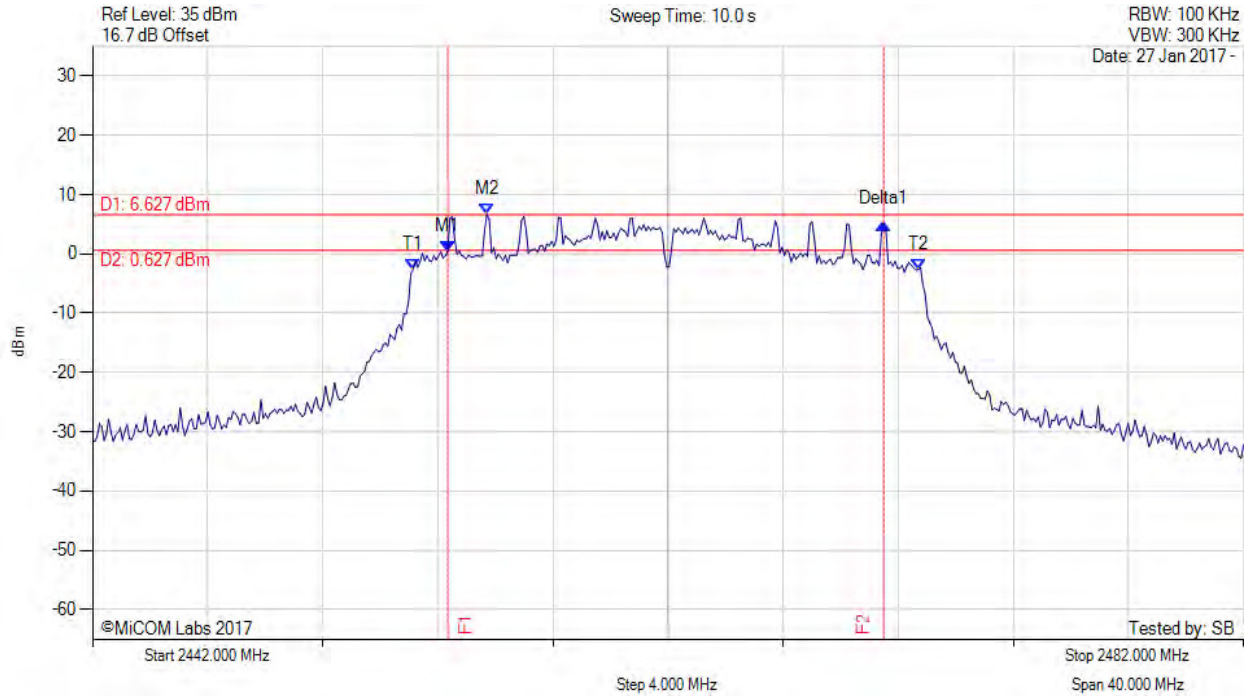

Analyzer Setup	Marker:Frequency:Amplitude	Test Results
Detector = MAX PEAK Sweep Count = 0 RF Atten (dB) = 30 Trace Mode = MAX HOLD	M1 : 2454.345 MHz : 0.361 dBm M2 : 2455.707 MHz : 6.627 dBm Delta1 : 15.150 MHz : 4.743 dB T1 : 2453.142 MHz : -2.571 dBm T2 : 2470.697 MHz : -2.671 dBm OBW : 17.555 MHz	Measured 6 dB Bandwidth: 15.150 MHz Limit: ≥500.0 kHz Margin: -14.65 MHz

[back to matrix](#)

This test report may be reproduced in full only. The document may only be updated by MiCOM Labs personnel. All changes will be noted in the Document History section of the report.



**Title:** Hewlett Packard Enterprise APINR203, APINP203  
**To:** FCC CFR 47 Part 15 Subpart C 15.247 (DTS)  
**Serial #:** HPEN96-U5\_Rev A (1x1)  
**Issue Date:** 23rd March 2017  
**Page:** 77 of 135

6 dB & 99% BANDWIDTH



Variant: 802.11n HT-40, Channel: 2422.00 MHz, Chain a, Temp: 20, Voltage: 110 Vac

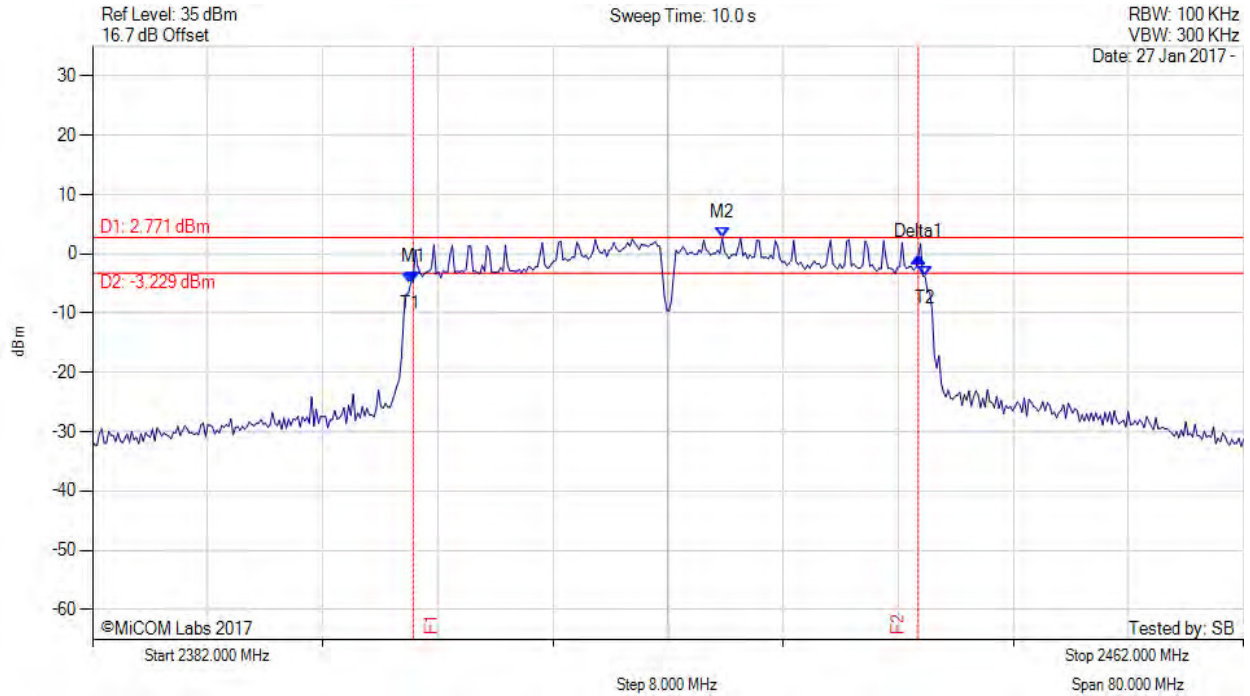

Analyzer Setup	Marker:Frequency:Amplitude	Test Results
Detector = MAX PEAK Sweep Count = 0 RF Atten (dB) = 30 Trace Mode = MAX HOLD	M1 : 2404.285 MHz : -4.693 dBm M2 : 2425.768 MHz : 2.771 dBm Delta1 : 35.110 MHz : 4.218 dB T1 : 2404.124 MHz : -4.880 dBm T2 : 2439.876 MHz : -3.924 dBm OBW : 35.752 MHz	Measured 6 dB Bandwidth: 35.110 MHz Limit: ≥500.0 kHz Margin: -34.61 MHz

[back to matrix](#)

This test report may be reproduced in full only. The document may only be updated by MiCOM Labs personnel. All changes will be noted in the Document History section of the report.



**Title:** Hewlett Packard Enterprise APINR203, APINP203  
**To:** FCC CFR 47 Part 15 Subpart C 15.247 (DTS)  
**Serial #:** HPEN96-U5\_Rev A (1x1)  
**Issue Date:** 23<sup>rd</sup> March 2017  
**Page:** 78 of 135

6 dB & 99% BANDWIDTH



Variants: 802.11n HT-40, Channel: 2437.00 MHz, Chain a, Temp: 20, Voltage: 110 Vac

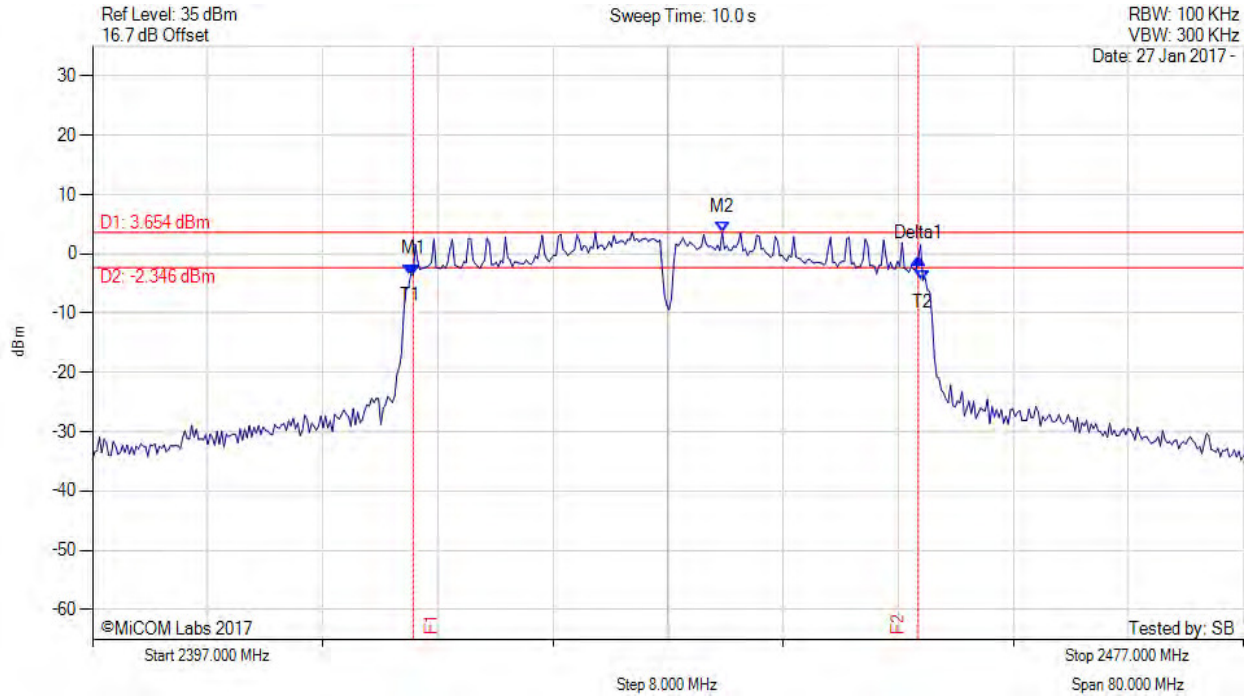

Analyzer Setup	Marker:Frequency:Amplitude	Test Results
Detector = MAX PEAK Sweep Count = 0 RF Atten (dB) = 30 Trace Mode = MAX HOLD	M1 : 2419.285 MHz : -3.478 dBm M2 : 2440.768 MHz : 3.654 dBm Delta1 : 35.110 MHz : 2.768 dB T1 : 2419.124 MHz : -3.491 dBm T2 : 2454.715 MHz : -4.516 dBm OBW : 35.591 MHz	Measured 6 dB Bandwidth: 35.110 MHz Limit: ≥500.0 kHz Margin: -34.61 MHz

[back to matrix](#)

This test report may be reproduced in full only. The document may only be updated by MiCOM Labs personnel. All changes will be noted in the Document History section of the report.



**Title:** Hewlett Packard Enterprise APINR203, APINP203  
**To:** FCC CFR 47 Part 15 Subpart C 15.247 (DTS)  
**Serial #:** HPEN96-U5\_Rev A (1x1)  
**Issue Date:** 23<sup>rd</sup> March 2017  
**Page:** 79 of 135

6 dB & 99% BANDWIDTH



Variants: 802.11n HT-40, Channel: 2452.00 MHz, Chain a, Temp: 20, Voltage: 110 Vac

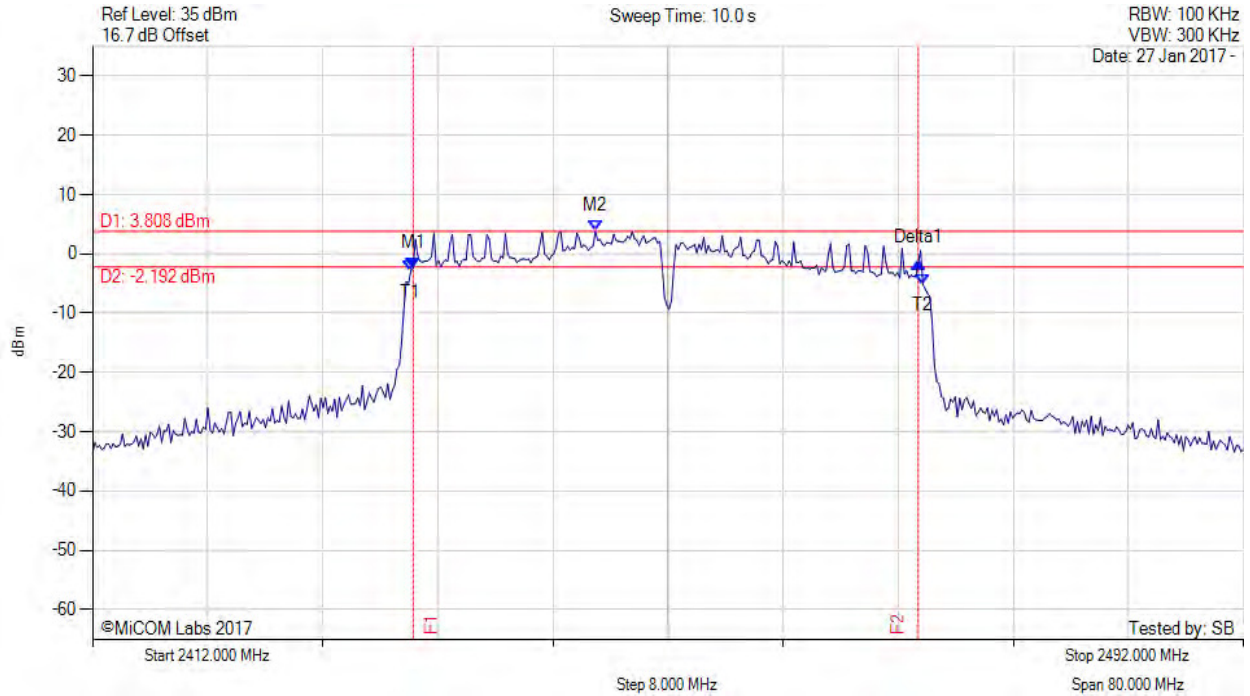

Analyzer Setup	Marker:Frequency:Amplitude	Test Results
Detector = MAX PEAK Sweep Count = 0 RF Atten (dB) = 30 Trace Mode = MAX HOLD	M1 : 2434.285 MHz : -2.360 dBm M2 : 2446.950 MHz : 3.808 dBm Delta1 : 35.110 MHz : 0.836 dB T1 : 2434.124 MHz : -2.915 dBm T2 : 2469.715 MHz : -5.114 dBm OBW : 35.591 MHz	Measured 6 dB Bandwidth: 35.110 MHz Limit: ≥500.0 kHz Margin: -34.61 MHz

[back to matrix](#)

This test report may be reproduced in full only. The document may only be updated by MiCOM Labs personnel. All changes will be noted in the Document History section of the report.



## A.2. Power Spectral Density



### POWER SPECTRAL DENSITY - AVERAGE

Variant: 802.11b, Channel: 2412.00 MHz, Chain a, Temp: 20, Voltage: 110 Vac

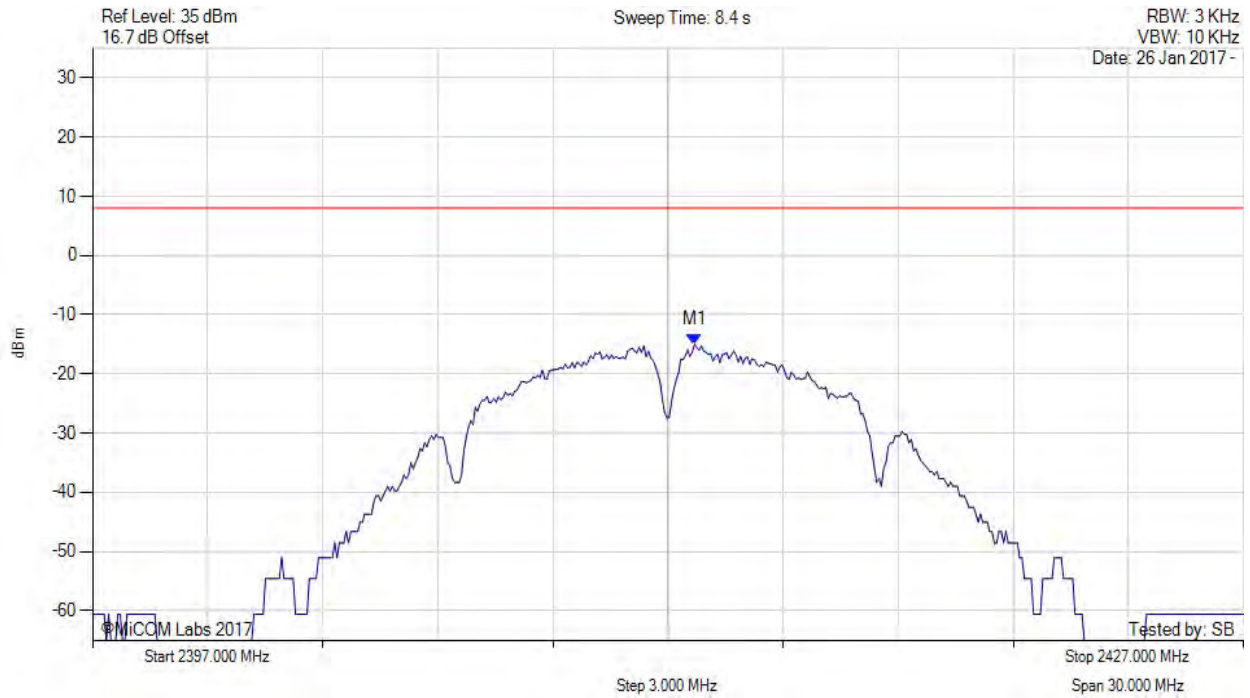

Analyzer Setup	Marker: Frequency: Amplitude	Test Results
Detector = AVERAGE Sweep Count = 0 RF Atten (dB) = 30 Trace Mode = VIEW	M1 : 2412.691 MHz : -14.990 dBm	Limit: $\leq 8.000$ dBm

[back to matrix](#)

This test report may be reproduced in full only. The document may only be updated by MiCOM Labs personnel. All changes will be noted in the Document History section of the report.





**Title:** Hewlett Packard Enterprise APINR203, APINP203  
**To:** FCC CFR 47 Part 15 Subpart C 15.247 (DTS)  
**Serial #:** HPEN96-U5\_Rev A (1x1)  
**Issue Date:** 23<sup>rd</sup> March 2017  
**Page:** 81 of 135

POWER SPECTRAL DENSITY - AVERAGE



Variant: 802.11b, Channel: 2412.00 MHz, SUM, Temp: 20, Voltage: 110 Vac

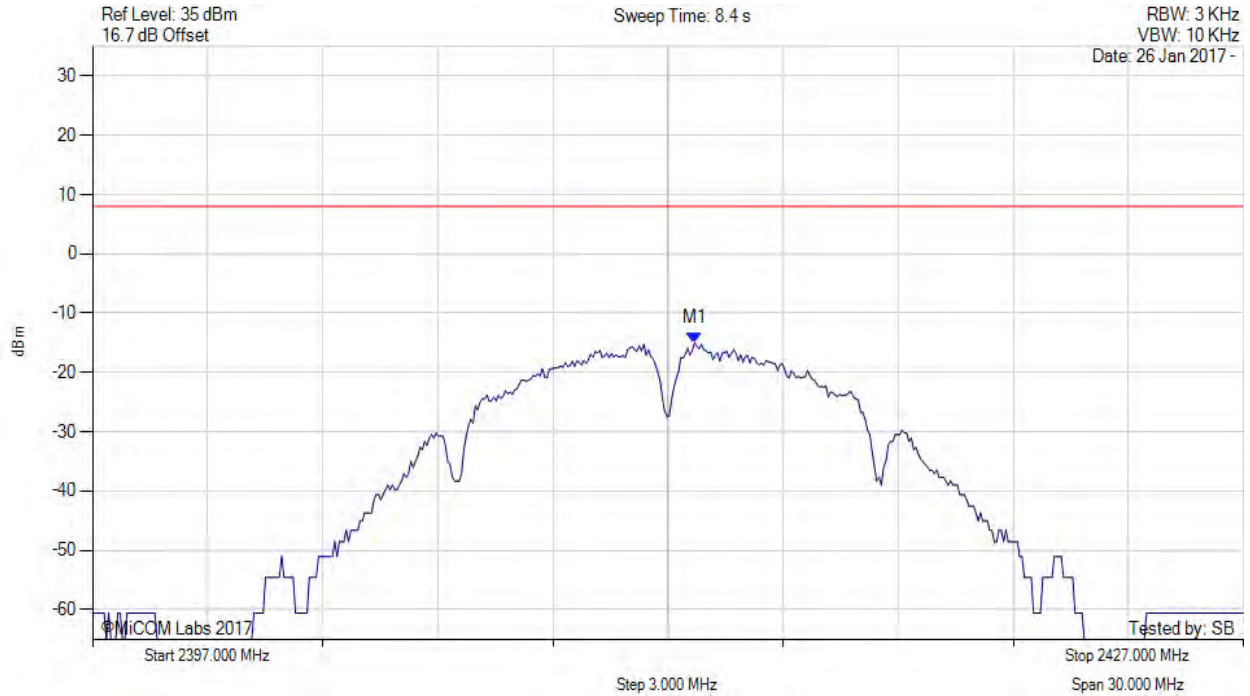

Analyzer Setup	Marker:Frequency:Amplitude	Test Results
Detector = AVERAGE Sweep Count = 0 RF Atten (dB) = 30 Trace Mode = VIEW	M1 : 2412.700 MHz : -14.990 dBm M1 + DCCF : 2412.700 MHz : -14.946 dBm Duty Cycle Correction Factor : +0.04 dB	Limit: $\leq 8.0$ dBm Margin: -22.9 dB

[back to matrix](#)

This test report may be reproduced in full only. The document may only be updated by MiCOM Labs personnel. All changes will be noted in the Document History section of the report.



**Title:** Hewlett Packard Enterprise APINR203, APINP203  
**To:** FCC CFR 47 Part 15 Subpart C 15.247 (DTS)  
**Serial #:** HPEN96-U5\_Rev A (1x1)  
**Issue Date:** 23<sup>rd</sup> March 2017  
**Page:** 82 of 135

POWER SPECTRAL DENSITY - AVERAGE



Variat: 802.11b, Channel: 2437.00 MHz, Chain a, Temp: 20, Voltage: 110 Vac

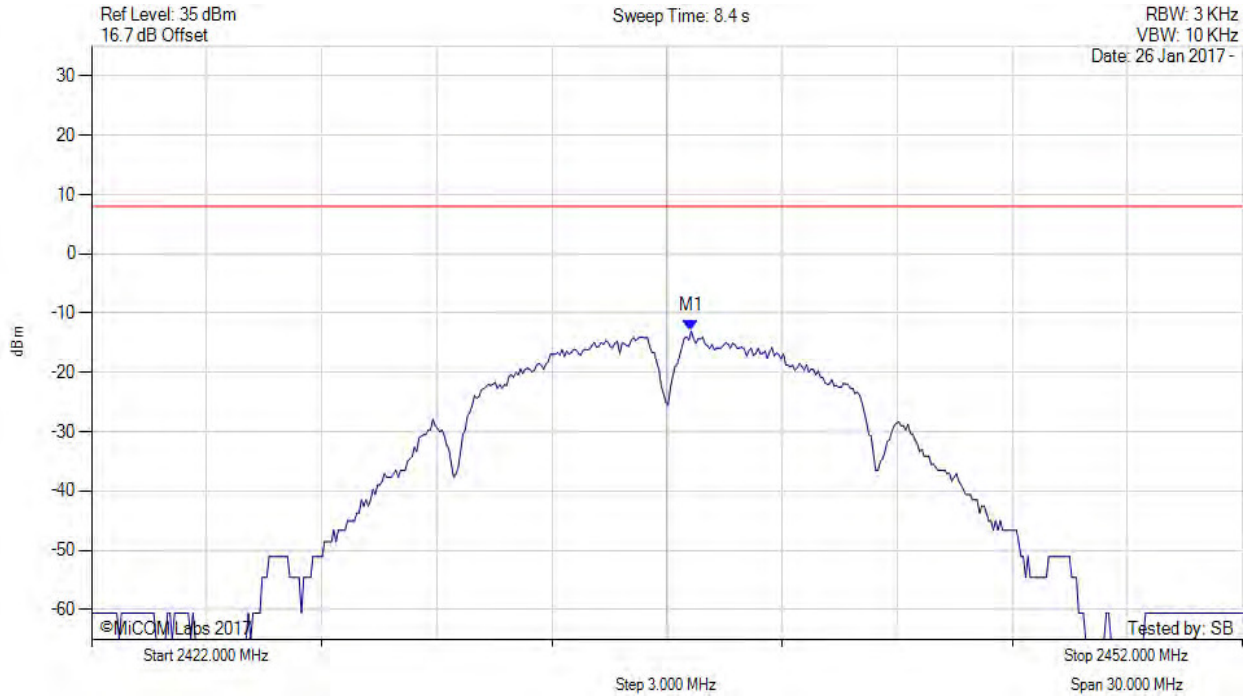

Analyzer Setup	Marker:Frequency:Amplitude	Test Results
Detector = AVERAGE Sweep Count = 0 RF Atten (dB) = 30 Trace Mode = VIEW	M1 : 2437.631 MHz : -13.034 dBm	Limit: $\leq 8.000$ dBm

[back to matrix](#)

This test report may be reproduced in full only. The document may only be updated by MiCOM Labs personnel. All changes will be noted in the Document History section of the report.



**Title:** Hewlett Packard Enterprise APINR203, APINP203  
**To:** FCC CFR 47 Part 15 Subpart C 15.247 (DTS)  
**Serial #:** HPEN96-U5\_Rev A (1x1)  
**Issue Date:** 23<sup>rd</sup> March 2017  
**Page:** 83 of 135

POWER SPECTRAL DENSITY - AVERAGE



Variant: 802.11b, Channel: 2437.00 MHz, SUM, Temp: 20, Voltage: 110 Vac

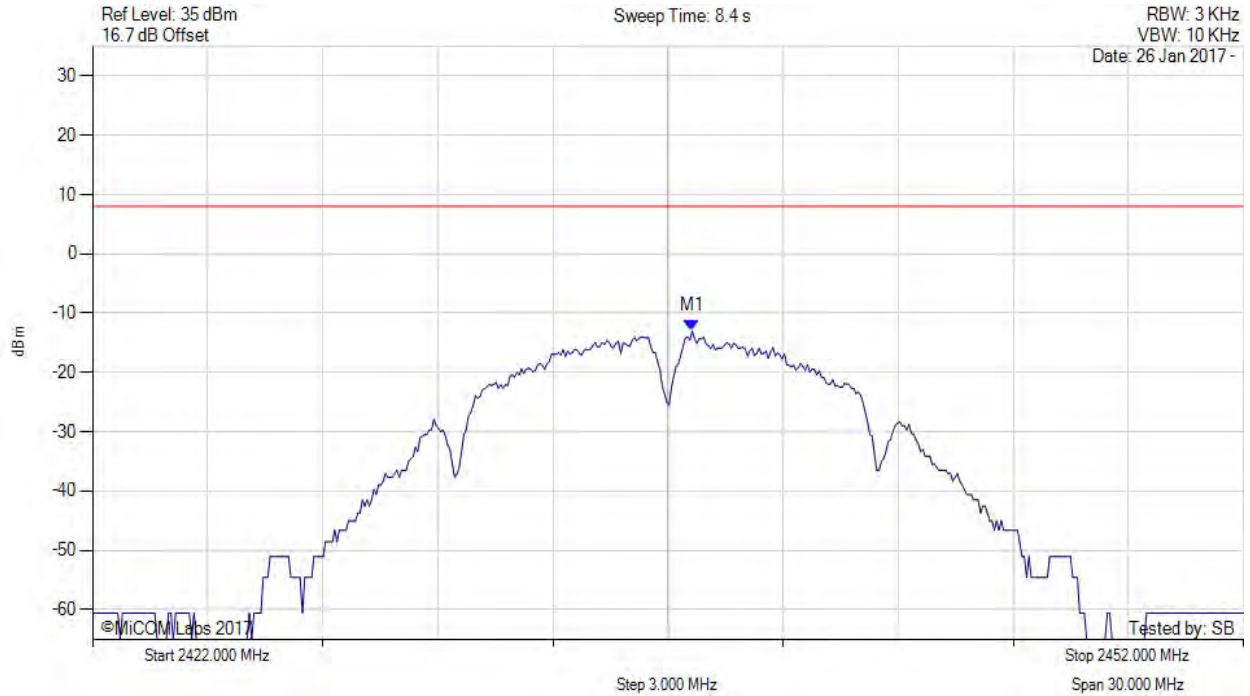

Analyzer Setup	Marker:Frequency:Amplitude	Test Results
Detector = AVERAGE Sweep Count = 0 RF Atten (dB) = 30 Trace Mode = VIEW	M1 : 2437.600 MHz : -13.034 dBm M1 + DCCF : 2437.600 MHz : -12.990 dBm Duty Cycle Correction Factor : +0.04 dB	Limit: $\leq 8.0$ dBm Margin: -21.0 dB

[back to matrix](#)

This test report may be reproduced in full only. The document may only be updated by MiCOM Labs personnel. All changes will be noted in the Document History section of the report.



**Title:** Hewlett Packard Enterprise APINR203, APINP203  
**To:** FCC CFR 47 Part 15 Subpart C 15.247 (DTS)  
**Serial #:** HPEN96-U5\_Rev A (1x1)  
**Issue Date:** 23rd March 2017  
**Page:** 84 of 135

POWER SPECTRAL DENSITY - AVERAGE



Variant: 802.11b, Channel: 2462.00 MHz, Chain a, Temp: 20, Voltage: 110 Vac

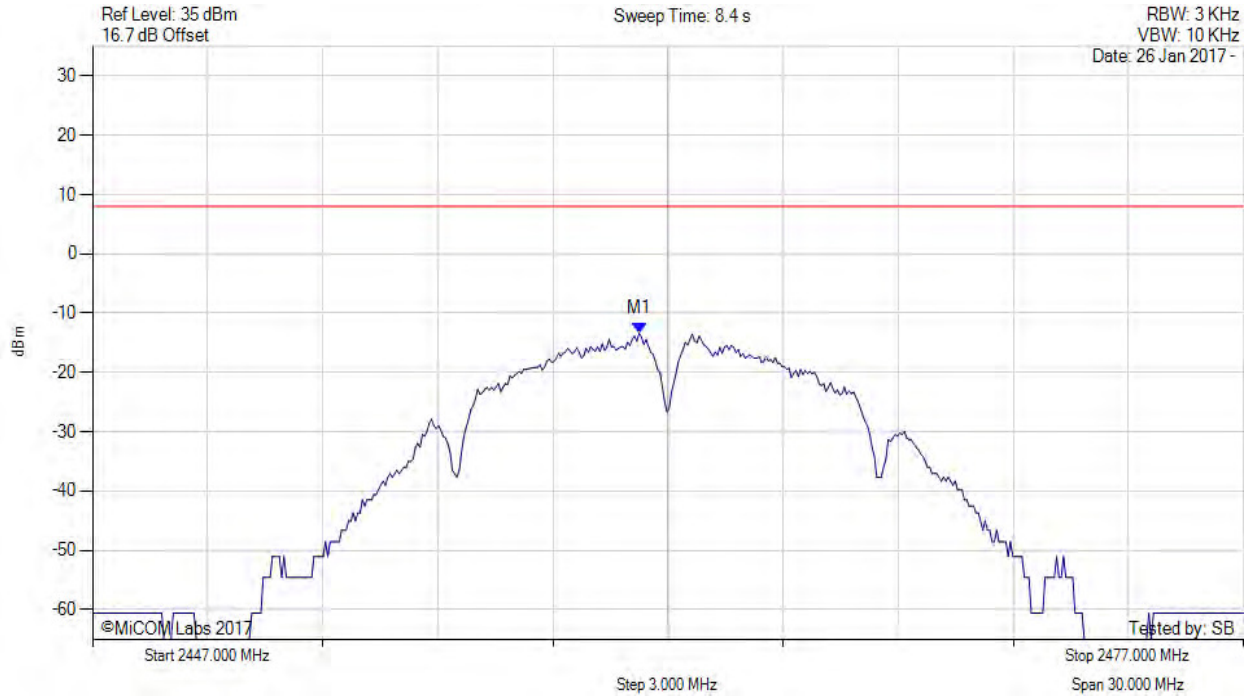

Analyzer Setup	Marker:Frequency:Amplitude	Test Results
Detector = AVERAGE Sweep Count = 0 RF Atten (dB) = 30 Trace Mode = VIEW	M1 : 2461.248 MHz : -13.407 dBm	Limit: $\leq 8.000$ dBm

[back to matrix](#)

This test report may be reproduced in full only. The document may only be updated by MiCOM Labs personnel. All changes will be noted in the Document History section of the report.



**Title:** Hewlett Packard Enterprise APINR203, APINP203  
**To:** FCC CFR 47 Part 15 Subpart C 15.247 (DTS)  
**Serial #:** HPEN96-U5\_Rev A (1x1)  
**Issue Date:** 23<sup>rd</sup> March 2017  
**Page:** 85 of 135

POWER SPECTRAL DENSITY - AVERAGE



Variant: 802.11b, Channel: 2462.00 MHz, SUM, Temp: 20, Voltage: 110 Vac

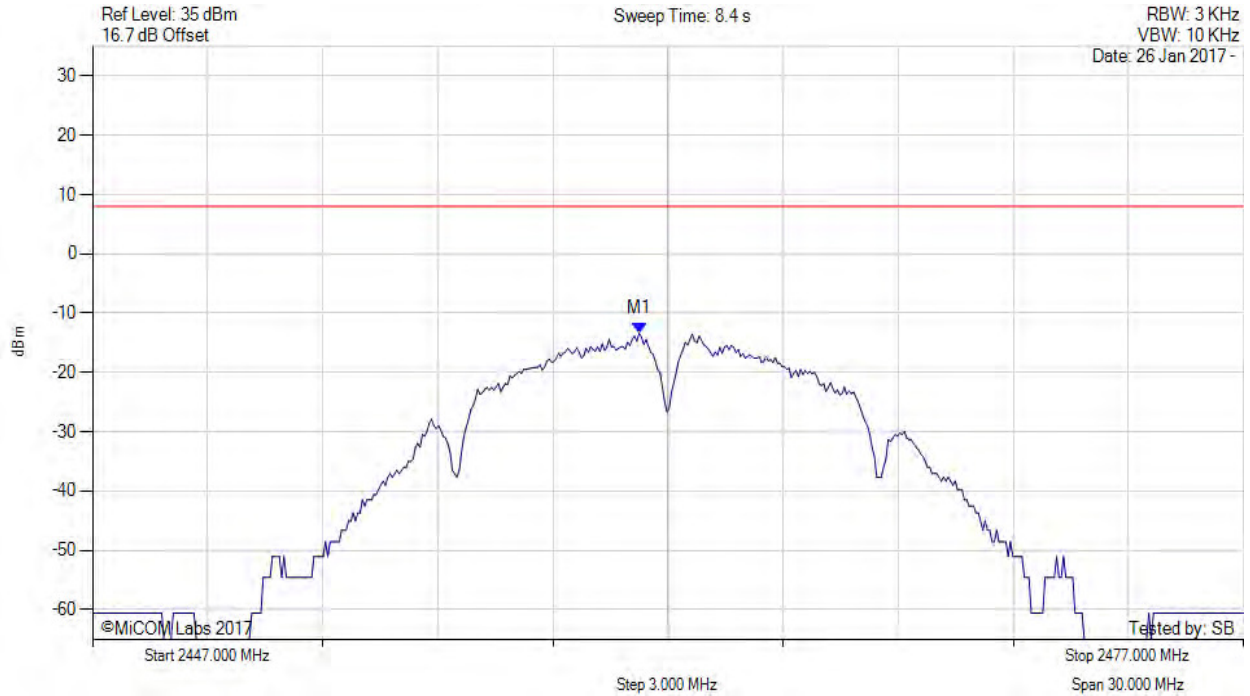

Analyzer Setup	Marker: Frequency: Amplitude	Test Results
Detector = AVERAGE Sweep Count = 0 RF Atten (dB) = 30 Trace Mode = VIEW	M1 : 2461.200 MHz : -13.407 dBm M1 + DCCF : 2461.200 MHz : -13.363 dBm Duty Cycle Correction Factor : +0.04 dB	Limit: $\leq 8.0$ dBm Margin: -21.4 dB

[back to matrix](#)

This test report may be reproduced in full only. The document may only be updated by MiCOM Labs personnel. All changes will be noted in the Document History section of the report.



**Title:** Hewlett Packard Enterprise APINR203, APINP203  
**To:** FCC CFR 47 Part 15 Subpart C 15.247 (DTS)  
**Serial #:** HPEN96-U5\_Rev A (1x1)  
**Issue Date:** 23<sup>rd</sup> March 2017  
**Page:** 86 of 135

POWER SPECTRAL DENSITY - AVERAGE



Variant: 802.11g, Channel: 2412.00 MHz, Chain a, Temp: 20, Voltage: 110 Vac

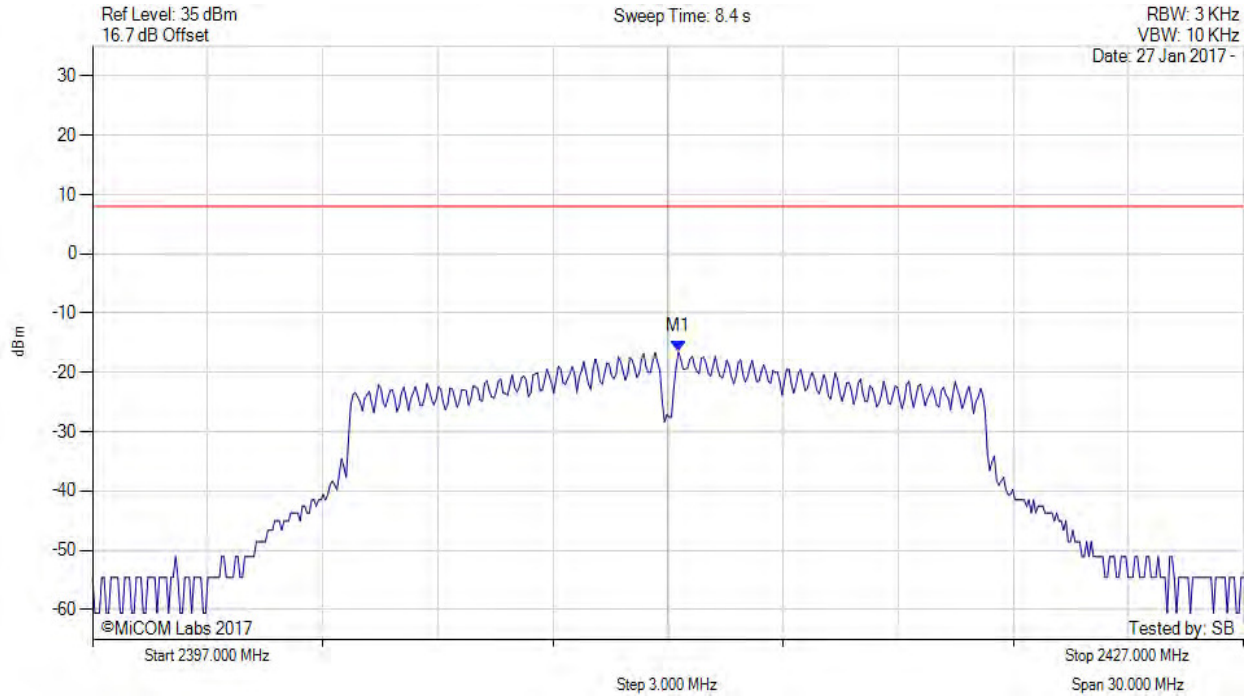

Analyzer Setup	Marker:Frequency:Amplitude	Test Results
Detector = AVERAGE Sweep Count = 0 RF Atten (dB) = 30 Trace Mode = VIEW	M1 : 2412.271 MHz : -16.483 dBm	Limit: $\leq 8.000$ dBm

[back to matrix](#)

This test report may be reproduced in full only. The document may only be updated by MiCOM Labs personnel. All changes will be noted in the Document History section of the report.



**Title:** Hewlett Packard Enterprise APINR203, APINP203  
**To:** FCC CFR 47 Part 15 Subpart C 15.247 (DTS)  
**Serial #:** HPEN96-U5\_Rev A (1x1)  
**Issue Date:** 23<sup>rd</sup> March 2017  
**Page:** 87 of 135

POWER SPECTRAL DENSITY - AVERAGE



Variant: 802.11g, Channel: 2412.00 MHz, SUM, Temp: 20, Voltage: 110 Vac

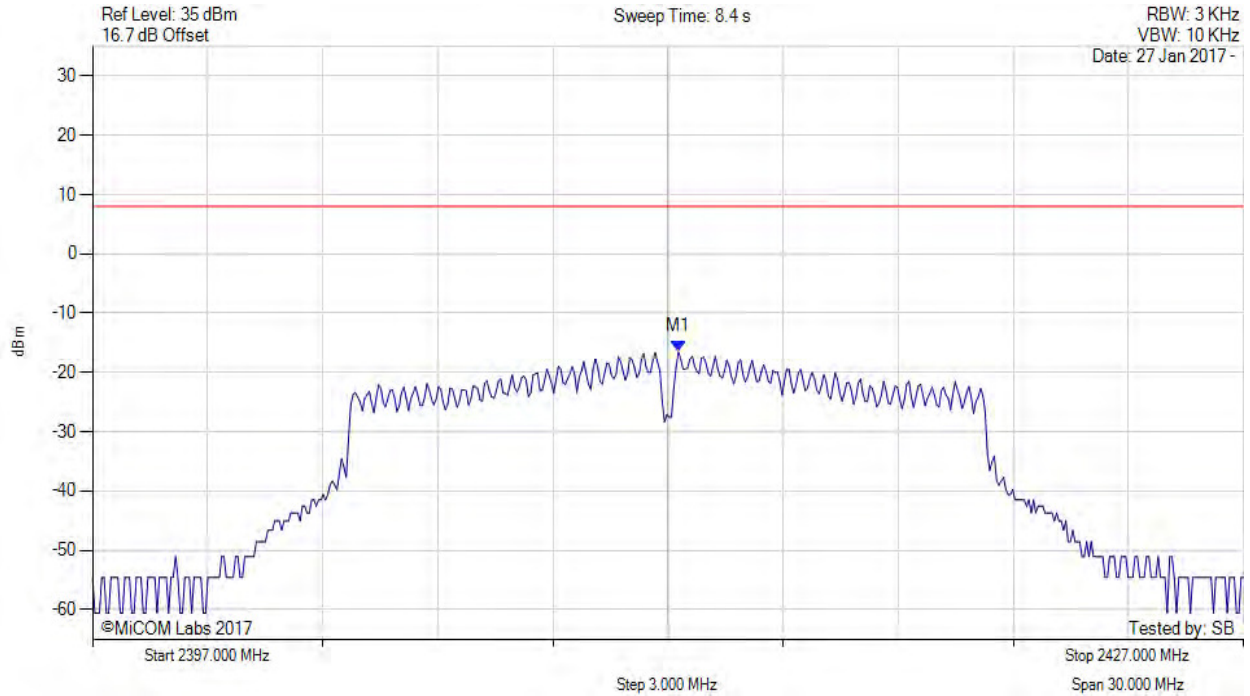

Analyzer Setup	Marker:Frequency:Amplitude	Test Results
Detector = AVERAGE Sweep Count = 0 RF Atten (dB) = 30 Trace Mode = VIEW	M1 : 2412.300 MHz : -16.483 dBm M1 + DCCF : 2412.300 MHz : -16.439 dBm Duty Cycle Correction Factor : +0.04 dB	Limit: $\leq 8.0$ dBm Margin: -24.4 dB

[back to matrix](#)

This test report may be reproduced in full only. The document may only be updated by MiCOM Labs personnel. All changes will be noted in the Document History section of the report.



**Title:** Hewlett Packard Enterprise APINR203, APINP203  
**To:** FCC CFR 47 Part 15 Subpart C 15.247 (DTS)  
**Serial #:** HPEN96-U5\_Rev A (1x1)  
**Issue Date:** 23<sup>rd</sup> March 2017  
**Page:** 88 of 135

POWER SPECTRAL DENSITY - AVERAGE



Variant: 802.11g, Channel: 2437.00 MHz, Chain a, Temp: 20, Voltage: 110 Vac

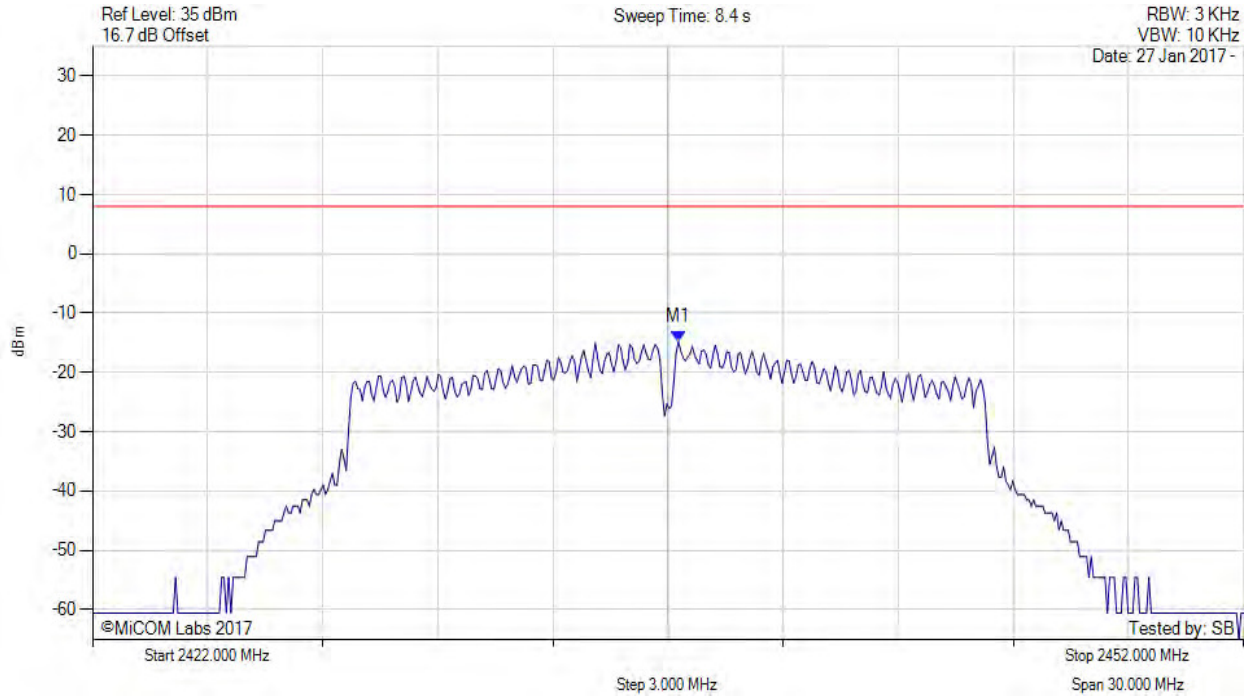

Analyzer Setup	Marker:Frequency:Amplitude	Test Results
Detector = AVERAGE Sweep Count = 0 RF Atten (dB) = 30 Trace Mode = VIEW	M1 : 2437.271 MHz : -14.809 dBm	Limit: $\leq 8.000$ dBm

[back to matrix](#)

This test report may be reproduced in full only. The document may only be updated by MiCOM Labs personnel. All changes will be noted in the Document History section of the report.





**Title:** Hewlett Packard Enterprise APINR203, APINP203  
**To:** FCC CFR 47 Part 15 Subpart C 15.247 (DTS)  
**Serial #:** HPEN96-U5\_Rev A (1x1)  
**Issue Date:** 23<sup>rd</sup> March 2017  
**Page:** 89 of 135

POWER SPECTRAL DENSITY - AVERAGE



Variant: 802.11g, Channel: 2437.00 MHz, SUM, Temp: 20, Voltage: 110 Vac

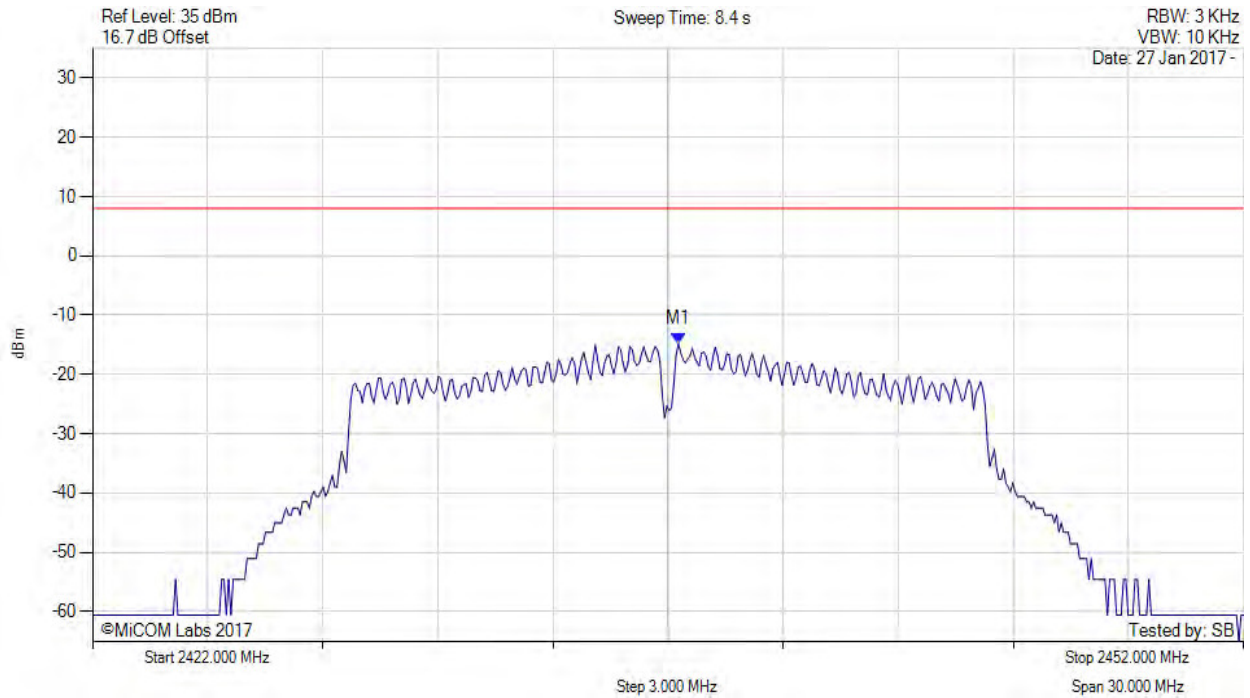

Analyzer Setup	Marker:Frequency:Amplitude	Test Results
Detector = AVERAGE Sweep Count = 0 RF Atten (dB) = 30 Trace Mode = VIEW	M1 : 2437.300 MHz : -14.809 dBm M1 + DCCF : 2437.300 MHz : -14.765 dBm Duty Cycle Correction Factor : +0.04 dB	Limit: $\leq 8.0$ dBm Margin: -22.8 dB

[back to matrix](#)

This test report may be reproduced in full only. The document may only be updated by MiCOM Labs personnel. All changes will be noted in the Document History section of the report.



**Title:** Hewlett Packard Enterprise APINR203, APINP203  
**To:** FCC CFR 47 Part 15 Subpart C 15.247 (DTS)  
**Serial #:** HPEN96-U5\_Rev A (1x1)  
**Issue Date:** 23<sup>rd</sup> March 2017  
**Page:** 90 of 135

POWER SPECTRAL DENSITY - AVERAGE



Variant: 802.11g, Channel: 2462.00 MHz, Chain a, Temp: 20, Voltage: 110 Vac

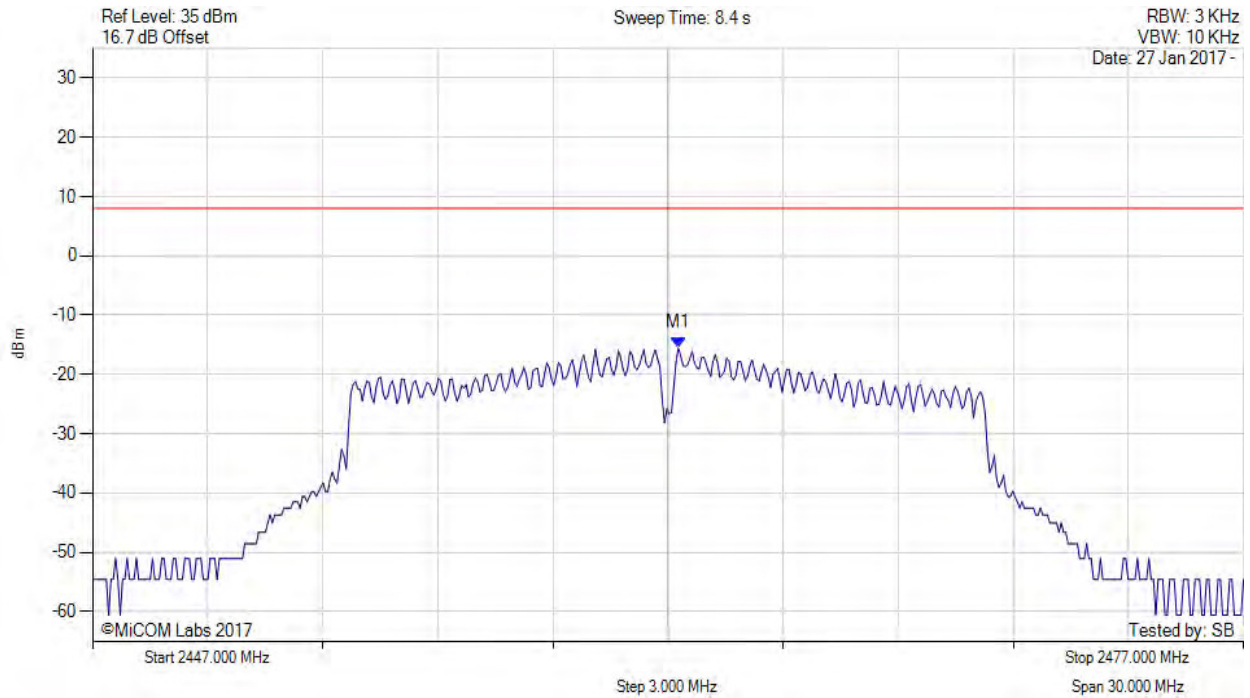

Analyzer Setup	Marker:Frequency:Amplitude	Test Results
Detector = AVERAGE Sweep Count = 0 RF Atten (dB) = 30 Trace Mode = VIEW	M1 : 2462.271 MHz : -15.557 dBm	Limit: $\leq 8.000$ dBm

[back to matrix](#)

This test report may be reproduced in full only. The document may only be updated by MiCOM Labs personnel. All changes will be noted in the Document History section of the report.



**Title:** Hewlett Packard Enterprise APINR203, APINP203  
**To:** FCC CFR 47 Part 15 Subpart C 15.247 (DTS)  
**Serial #:** HPEN96-U5\_Rev A (1x1)  
**Issue Date:** 23<sup>rd</sup> March 2017  
**Page:** 91 of 135

POWER SPECTRAL DENSITY - AVERAGE



Variant: 802.11g, Channel: 2462.00 MHz, SUM, Temp: 20, Voltage: 110 Vac

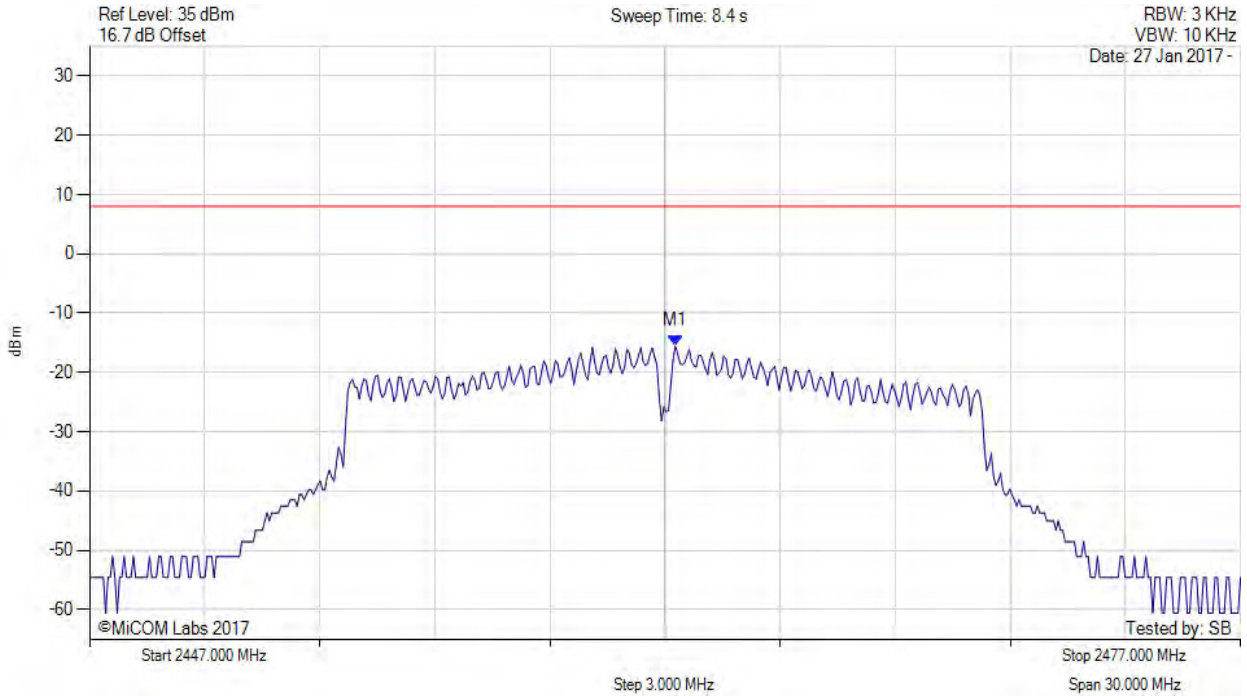

Analyzer Setup	Marker:Frequency:Amplitude	Test Results
Detector = AVERAGE Sweep Count = 0 RF Atten (dB) = 30 Trace Mode = VIEW	M1 : 2462.300 MHz : -15.557 dBm M1 + DCCF : 2462.300 MHz : -15.513 dBm Duty Cycle Correction Factor : +0.04 dB	Limit: $\leq 8.0$ dBm Margin: -23.5 dB

[back to matrix](#)

This test report may be reproduced in full only. The document may only be updated by MiCOM Labs personnel. All changes will be noted in the Document History section of the report.



**Title:** Hewlett Packard Enterprise APINR203, APINP203  
**To:** FCC CFR 47 Part 15 Subpart C 15.247 (DTS)  
**Serial #:** HPEN96-U5\_Rev A (1x1)  
**Issue Date:** 23<sup>rd</sup> March 2017  
**Page:** 92 of 135

POWER SPECTRAL DENSITY - AVERAGE



Variant: 802.11n HT-20, Channel: 2412.00 MHz, Chain a, Temp: 20, Voltage: 110 Vac

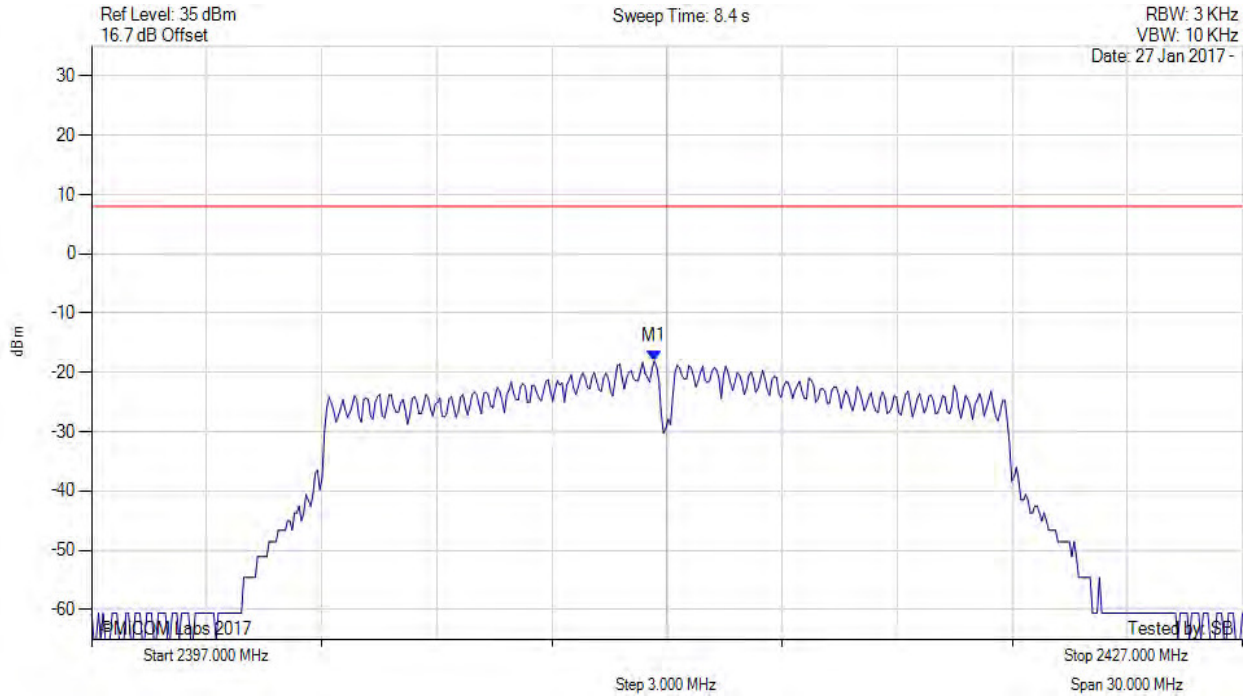

Analyzer Setup	Marker: Frequency: Amplitude	Test Results
Detector = AVERAGE Sweep Count = 0 RF Atten (dB) = 30 Trace Mode = VIEW	M1 : 2411.669 MHz : -18.088 dBm	Limit: $\leq 8.000$ dBm

[back to matrix](#)

This test report may be reproduced in full only. The document may only be updated by MiCOM Labs personnel. All changes will be noted in the Document History section of the report.



**Title:** Hewlett Packard Enterprise APINR203, APINP203  
**To:** FCC CFR 47 Part 15 Subpart C 15.247 (DTS)  
**Serial #:** HPEN96-U5\_Rev A (1x1)  
**Issue Date:** 23<sup>rd</sup> March 2017  
**Page:** 93 of 135

POWER SPECTRAL DENSITY - AVERAGE



Variant: 802.11n HT-20, Channel: 2412.00 MHz, SUM, Temp: 20, Voltage: 110 Vac

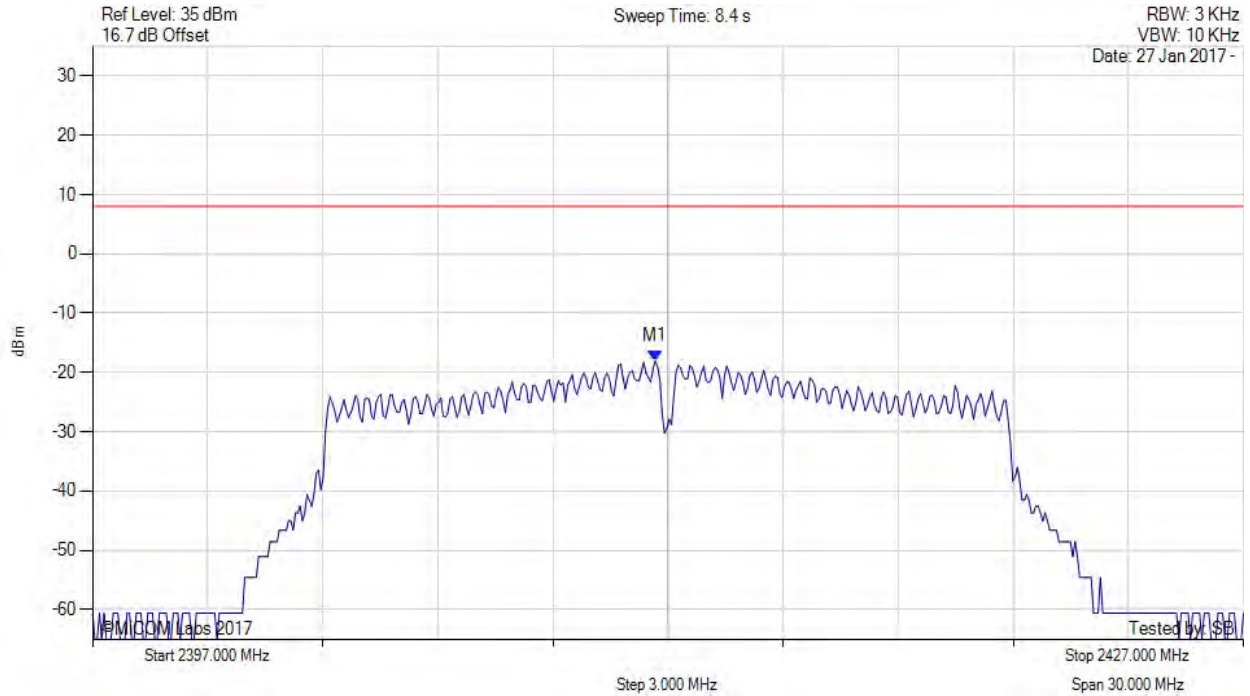

Analyzer Setup	Marker:Frequency:Amplitude	Test Results
Detector = AVERAGE Sweep Count = 0 RF Atten (dB) = 30 Trace Mode = VIEW	M1 : 2411.700 MHz : -18.088 dBm M1 + DCCF : 2411.700 MHz : -18.044 dBm Duty Cycle Correction Factor : +0.04 dB	Limit: $\leq 8.0$ dBm Margin: -26.0 dB

[back to matrix](#)

This test report may be reproduced in full only. The document may only be updated by MiCOM Labs personnel. All changes will be noted in the Document History section of the report.



**Title:** Hewlett Packard Enterprise APINR203, APINP203  
**To:** FCC CFR 47 Part 15 Subpart C 15.247 (DTS)  
**Serial #:** HPEN96-U5\_Rev A (1x1)  
**Issue Date:** 23<sup>rd</sup> March 2017  
**Page:** 94 of 135

POWER SPECTRAL DENSITY - AVERAGE



Variant: 802.11n HT-20, Channel: 2437.00 MHz, Chain a, Temp: 20, Voltage: 110 Vac

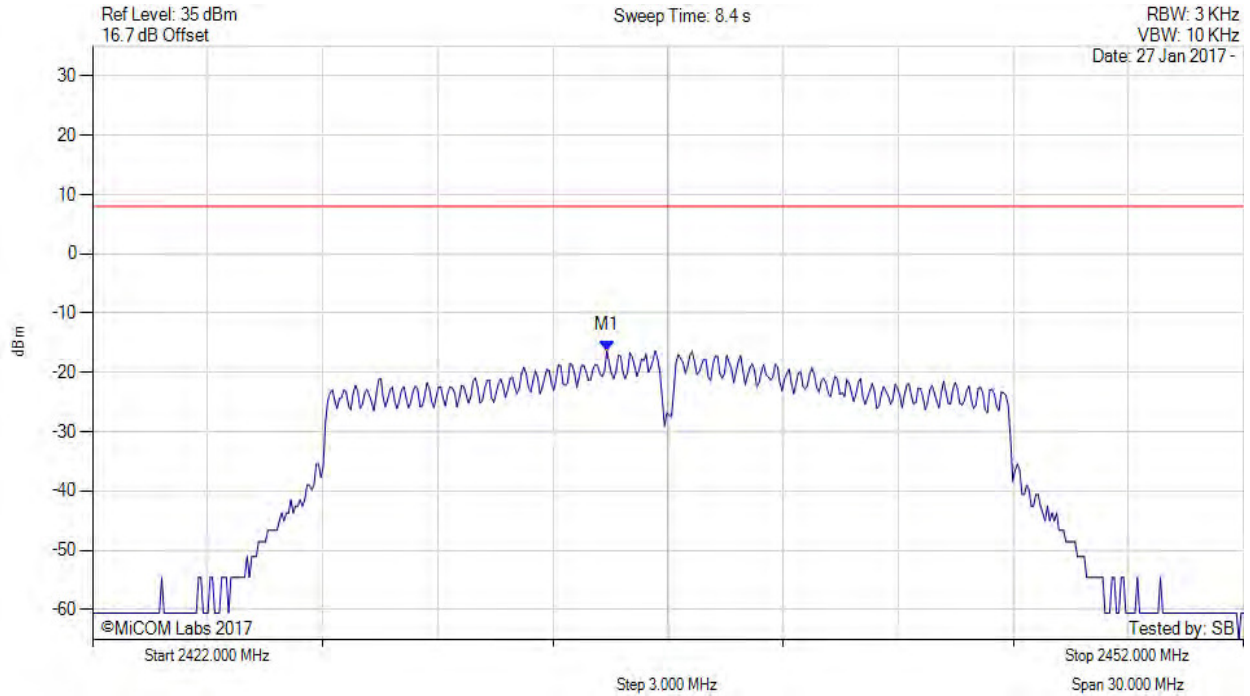

Analyzer Setup	Marker:Frequency:Amplitude	Test Results
Detector = AVERAGE Sweep Count = 0 RF Atten (dB) = 30 Trace Mode = VIEW	M1 : 2435.407 MHz : -16.322 dBm	Limit: $\leq 8.000$ dBm

[back to matrix](#)

This test report may be reproduced in full only. The document may only be updated by MiCOM Labs personnel. All changes will be noted in the Document History section of the report.



**Title:** Hewlett Packard Enterprise APINR203, APINP203  
**To:** FCC CFR 47 Part 15 Subpart C 15.247 (DTS)  
**Serial #:** HPEN96-U5\_Rev A (1x1)  
**Issue Date:** 23<sup>rd</sup> March 2017  
**Page:** 95 of 135

POWER SPECTRAL DENSITY - AVERAGE



Variant: 802.11n HT-20, Channel: 2437.00 MHz, SUM, Temp: 20, Voltage: 110 Vac

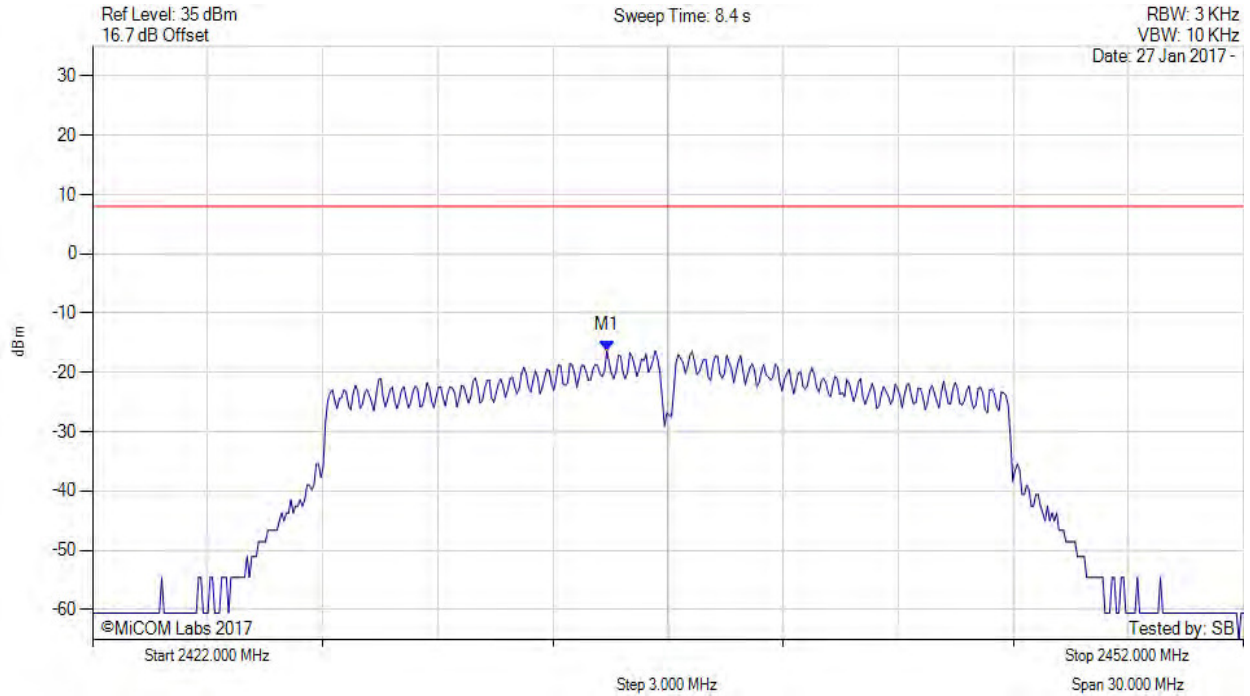

Analyzer Setup	Marker:Frequency:Amplitude	Test Results
Detector = AVERAGE Sweep Count = 0 RF Atten (dB) = 30 Trace Mode = VIEW	M1 : 2435.400 MHz : -16.322 dBm M1 + DCCF : 2435.400 MHz : -16.278 dBm Duty Cycle Correction Factor : +0.04 dB	Limit: $\leq 8.0$ dBm Margin: -24.3 dB

[back to matrix](#)

This test report may be reproduced in full only. The document may only be updated by MiCOM Labs personnel. All changes will be noted in the Document History section of the report.



**Title:** Hewlett Packard Enterprise APINR203, APINP203  
**To:** FCC CFR 47 Part 15 Subpart C 15.247 (DTS)  
**Serial #:** HPEN96-U5\_Rev A (1x1)  
**Issue Date:** 23rd March 2017  
**Page:** 96 of 135

POWER SPECTRAL DENSITY - AVERAGE



Variant: 802.11n HT-20, Channel: 2462.00 MHz, Chain a, Temp: 20, Voltage: 110 Vac

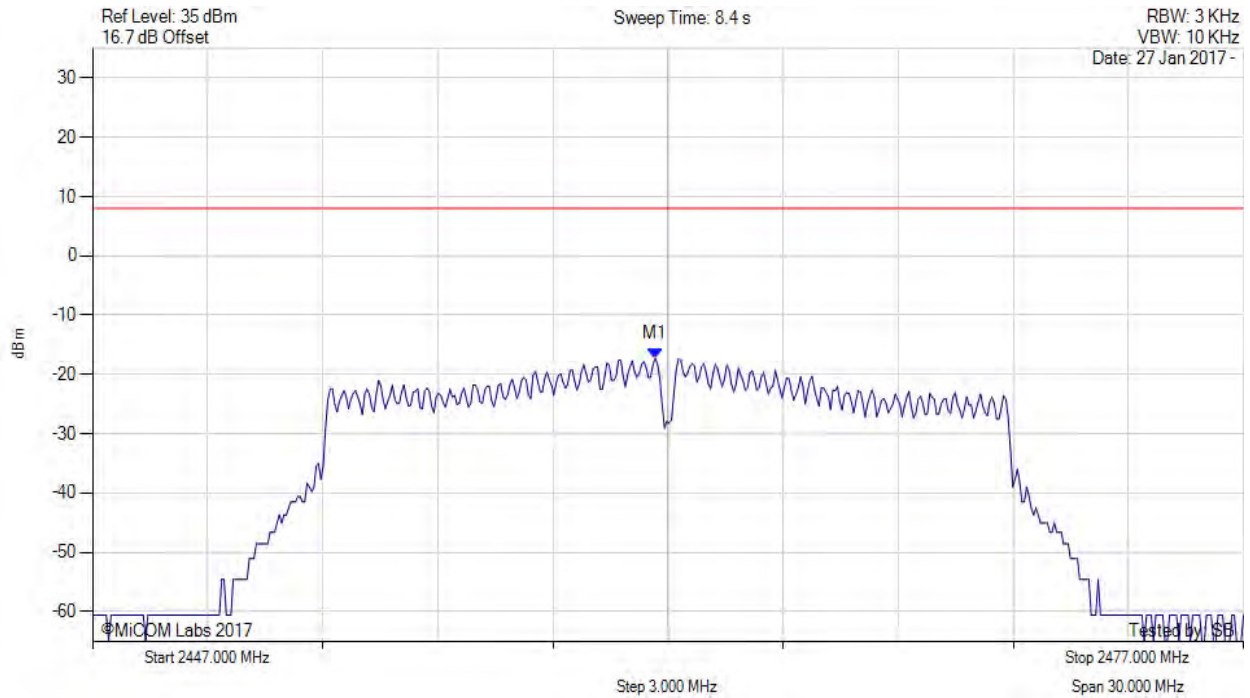

Analyzer Setup	Marker: Frequency: Amplitude	Test Results
Detector = AVERAGE Sweep Count = 0 RF Atten (dB) = 30 Trace Mode = VIEW	M1 : 2461.669 MHz : -17.278 dBm	Limit: $\leq 8.000$ dBm

[back to matrix](#)

This test report may be reproduced in full only. The document may only be updated by MiCOM Labs personnel. All changes will be noted in the Document History section of the report.





**Title:** Hewlett Packard Enterprise APINR203, APINP203  
**To:** FCC CFR 47 Part 15 Subpart C 15.247 (DTS)  
**Serial #:** HPEN96-U5\_Rev A (1x1)  
**Issue Date:** 23<sup>rd</sup> March 2017  
**Page:** 97 of 135

POWER SPECTRAL DENSITY - AVERAGE



Variant: 802.11n HT-20, Channel: 2462.00 MHz, SUM, Temp: 20, Voltage: 110 Vac

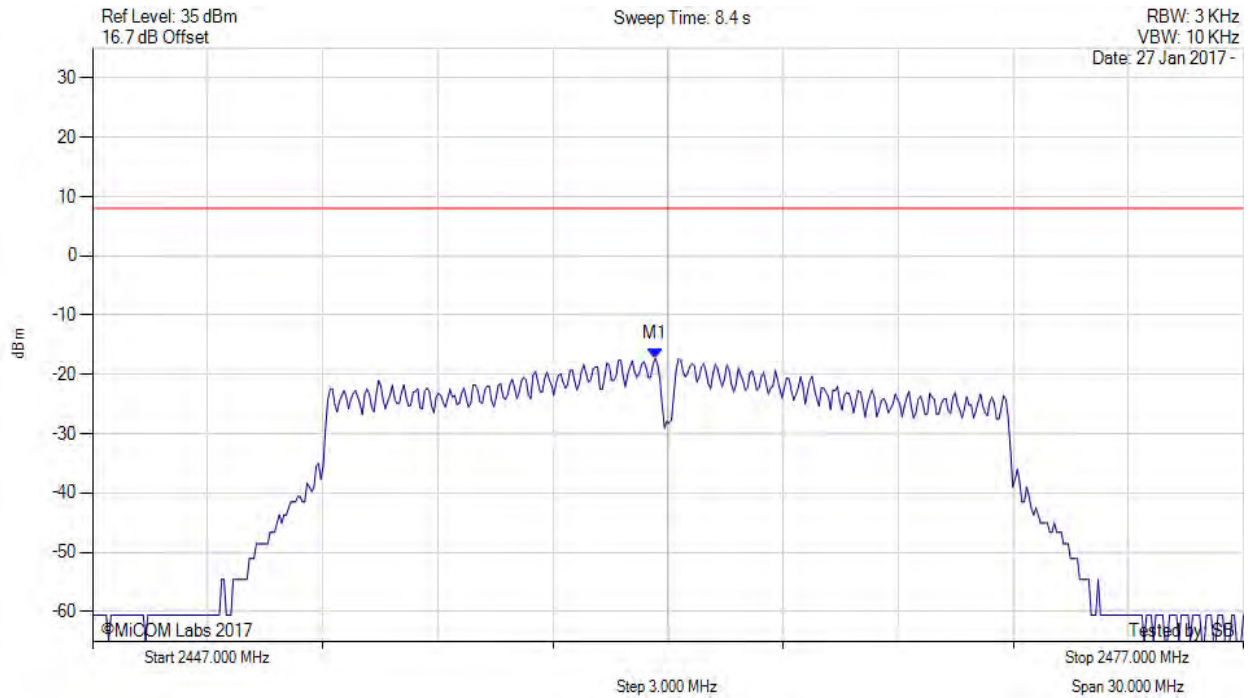

Analyzer Setup	Marker:Frequency:Amplitude	Test Results
Detector = AVERAGE Sweep Count = 0 RF Atten (dB) = 30 Trace Mode = VIEW	M1 : 2461.700 MHz : -17.278 dBm M1 + DCCF : 2461.700 MHz : -17.234 dBm Duty Cycle Correction Factor : +0.04 dB	Limit: $\leq 8.0$ dBm Margin: -25.2 dB

[back to matrix](#)

This test report may be reproduced in full only. The document may only be updated by MiCOM Labs personnel. All changes will be noted in the Document History section of the report.



**Title:** Hewlett Packard Enterprise APINR203, APINP203  
**To:** FCC CFR 47 Part 15 Subpart C 15.247 (DTS)  
**Serial #:** HPEN96-U5\_Rev A (1x1)  
**Issue Date:** 23<sup>rd</sup> March 2017  
**Page:** 98 of 135

POWER SPECTRAL DENSITY - AVERAGE



Variants: 802.11n HT-40, Channel: 2422.00 MHz, Chain a, Temp: 20, Voltage: 110 Vac

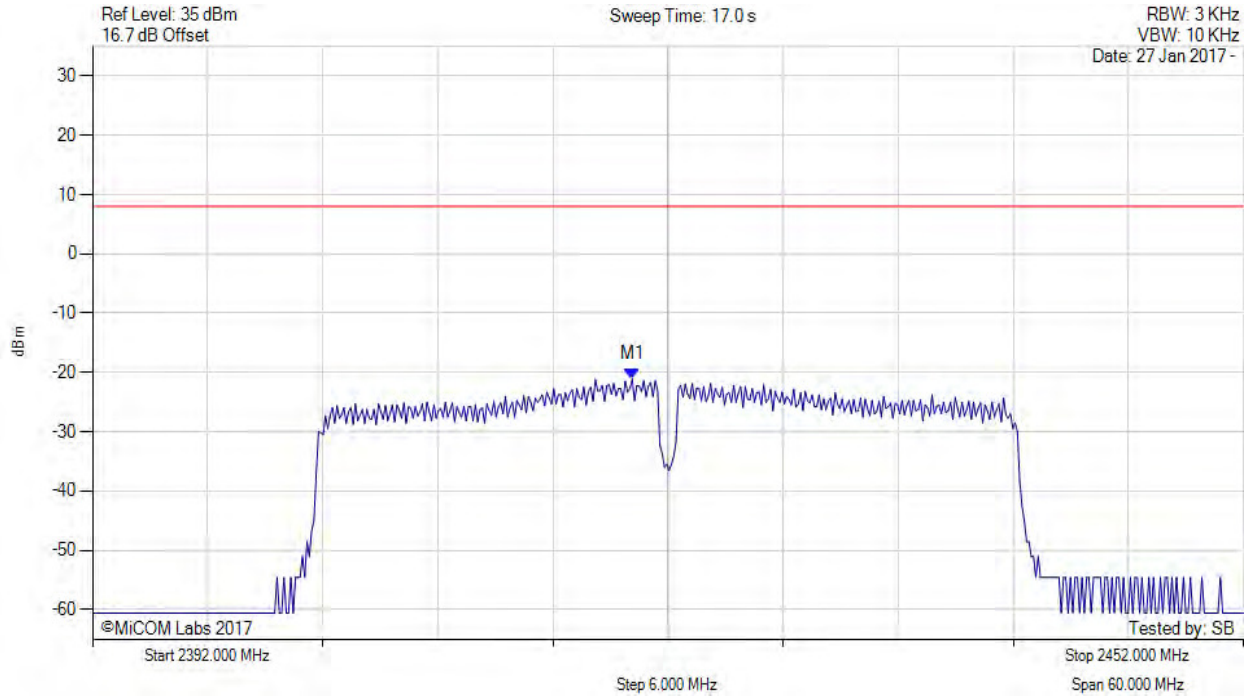

Analyzer Setup	Marker: Frequency: Amplitude	Test Results
Detector = AVERAGE Sweep Count = 0 RF Atten (dB) = 30 Trace Mode = VIEW	M1 : 2420.136 MHz : -21.103 dBm	Limit: $\leq 8.000$ dBm

[back to matrix](#)

This test report may be reproduced in full only. The document may only be updated by MiCOM Labs personnel. All changes will be noted in the Document History section of the report.



**Title:** Hewlett Packard Enterprise APINR203, APINP203  
**To:** FCC CFR 47 Part 15 Subpart C 15.247 (DTS)  
**Serial #:** HPEN96-U5\_Rev A (1x1)  
**Issue Date:** 23<sup>rd</sup> March 2017  
**Page:** 99 of 135

POWER SPECTRAL DENSITY - AVERAGE



Variant: 802.11n HT-40, Channel: 2422.00 MHz, SUM, Temp: 20, Voltage: 110 Vac

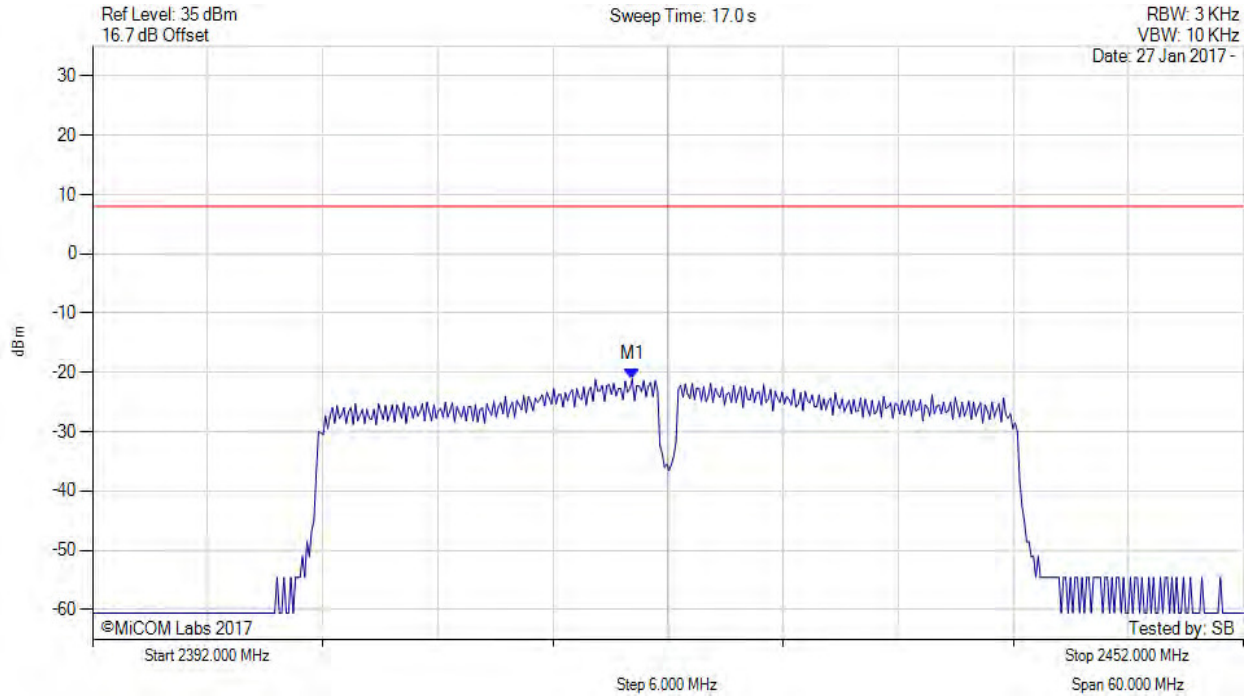

Analyzer Setup	Marker:Frequency:Amplitude	Test Results
Detector = AVERAGE Sweep Count = 0 RF Atten (dB) = 30 Trace Mode = VIEW	M1 : 2420.100 MHz : -21.103 dBm M1 + DCCF : 2420.100 MHz : -21.059 dBm Duty Cycle Correction Factor : +0.04 dB	Limit: $\leq 8.0$ dBm Margin: -29.1 dB

[back to matrix](#)

This test report may be reproduced in full only. The document may only be updated by MiCOM Labs personnel. All changes will be noted in the Document History section of the report.



**Title:** Hewlett Packard Enterprise APINR203, APINP203  
**To:** FCC CFR 47 Part 15 Subpart C 15.247 (DTS)  
**Serial #:** HPEN96-U5\_Rev A (1x1)  
**Issue Date:** 23<sup>rd</sup> March 2017  
**Page:** 100 of 135

POWER SPECTRAL DENSITY - AVERAGE



Variat: 802.11n HT-40, Channel: 2437.00 MHz, Chain a, Temp: 20, Voltage: 110 Vac

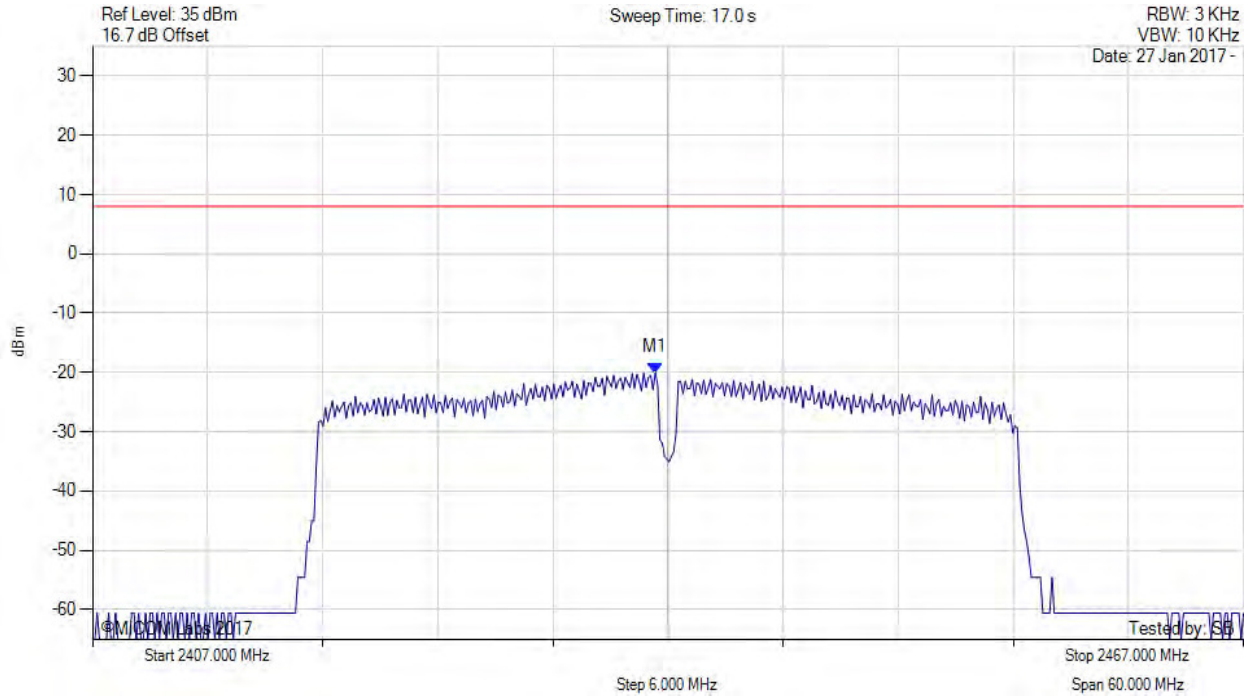

Analyzer Setup	Marker: Frequency: Amplitude	Test Results
Detector = AVERAGE Sweep Count = 0 RF Atten (dB) = 30 Trace Mode = VIEW	M1 : 2436.339 MHz : -20.059 dBm	Limit: $\leq 8.000$ dBm

[back to matrix](#)

This test report may be reproduced in full only. The document may only be updated by MiCOM Labs personnel. All changes will be noted in the Document History section of the report.



**Title:** Hewlett Packard Enterprise APINR203, APINP203  
**To:** FCC CFR 47 Part 15 Subpart C 15.247 (DTS)  
**Serial #:** HPEN96-U5\_Rev A (1x1)  
**Issue Date:** 23<sup>rd</sup> March 2017  
**Page:** 101 of 135

POWER SPECTRAL DENSITY - AVERAGE



Variant: 802.11n HT-40, Channel: 2437.00 MHz, SUM, Temp: 20, Voltage: 110 Vac

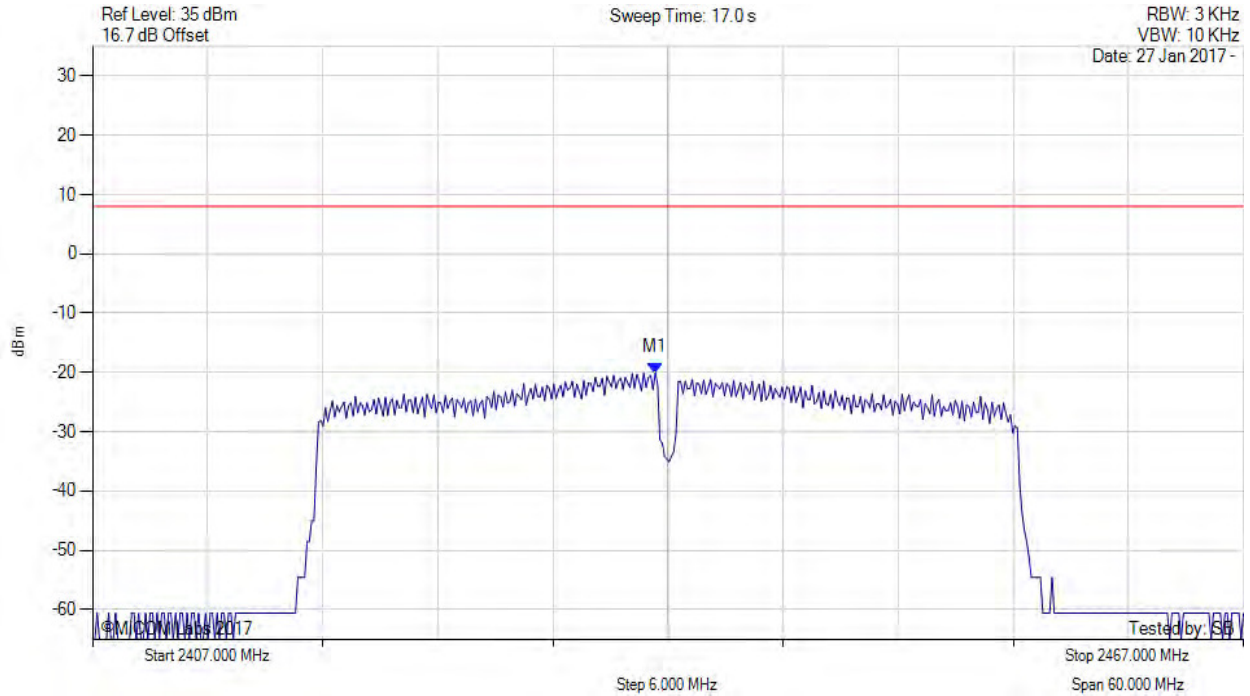

Analyzer Setup	Marker:Frequency:Amplitude	Test Results
Detector = AVERAGE Sweep Count = 0 RF Atten (dB) = 30 Trace Mode = VIEW	M1 : 2436.300 MHz : -20.059 dBm M1 + DCCF : 2436.300 MHz : -19.836 dBm Duty Cycle Correction Factor : +0.04 dB	Limit: $\leq 8.0$ dBm Margin: -27.8 dB

[back to matrix](#)

This test report may be reproduced in full only. The document may only be updated by MiCOM Labs personnel. All changes will be noted in the Document History section of the report.



**Title:** Hewlett Packard Enterprise APINR203, APINP203  
**To:** FCC CFR 47 Part 15 Subpart C 15.247 (DTS)  
**Serial #:** HPEN96-U5\_Rev A (1x1)  
**Issue Date:** 23<sup>rd</sup> March 2017  
**Page:** 102 of 135

POWER SPECTRAL DENSITY - AVERAGE



Variant: 802.11n HT-40, Channel: 2452.00 MHz, Chain a, Temp: 20, Voltage: 110 Vac

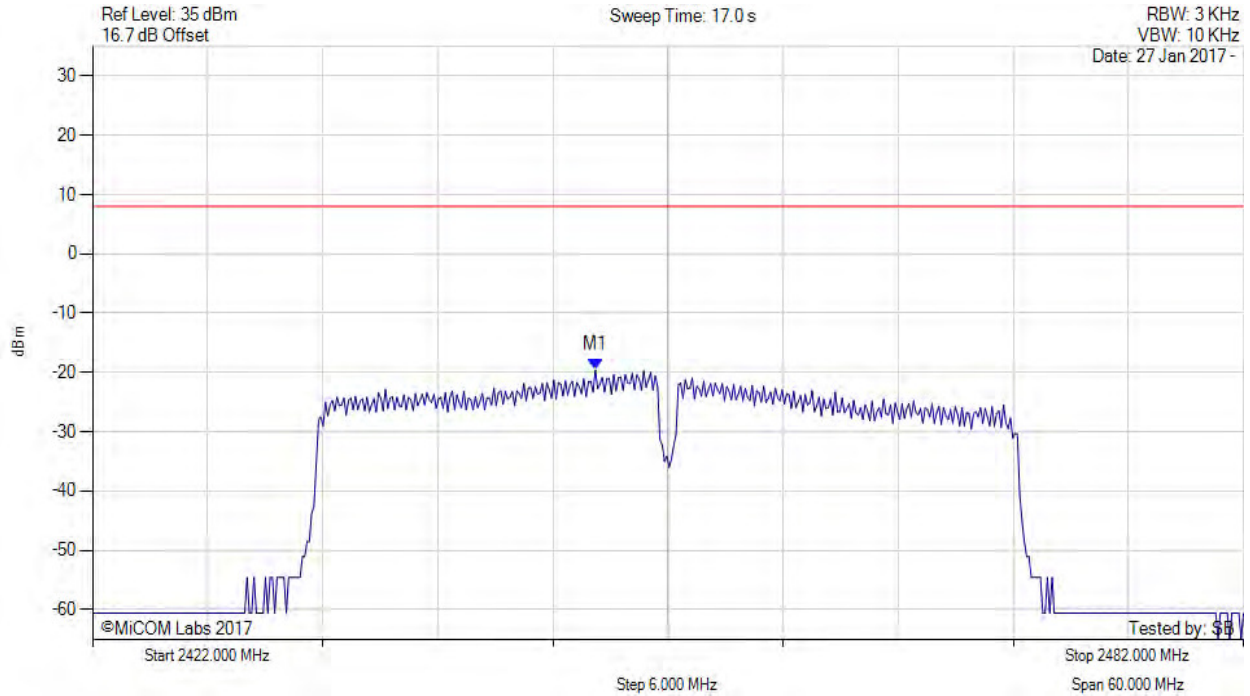

Analyzer Setup	Marker: Frequency: Amplitude	Test Results
Detector = AVERAGE Sweep Count = 0 RF Atten (dB) = 30 Trace Mode = VIEW	M1 : 2448.212 MHz : -19.581 dBm	Limit: $\leq 8.000$ dBm

[back to matrix](#)

This test report may be reproduced in full only. The document may only be updated by MiCOM Labs personnel. All changes will be noted in the Document History section of the report.



**Title:** Hewlett Packard Enterprise APINR203, APINP203  
**To:** FCC CFR 47 Part 15 Subpart C 15.247 (DTS)  
**Serial #:** HPEN96-U5\_Rev A (1x1)  
**Issue Date:** 23<sup>rd</sup> March 2017  
**Page:** 103 of 135

POWER SPECTRAL DENSITY - AVERAGE



Variant: 802.11n HT-40, Channel: 2452.00 MHz, SUM, Temp: 20, Voltage: 110 Vac

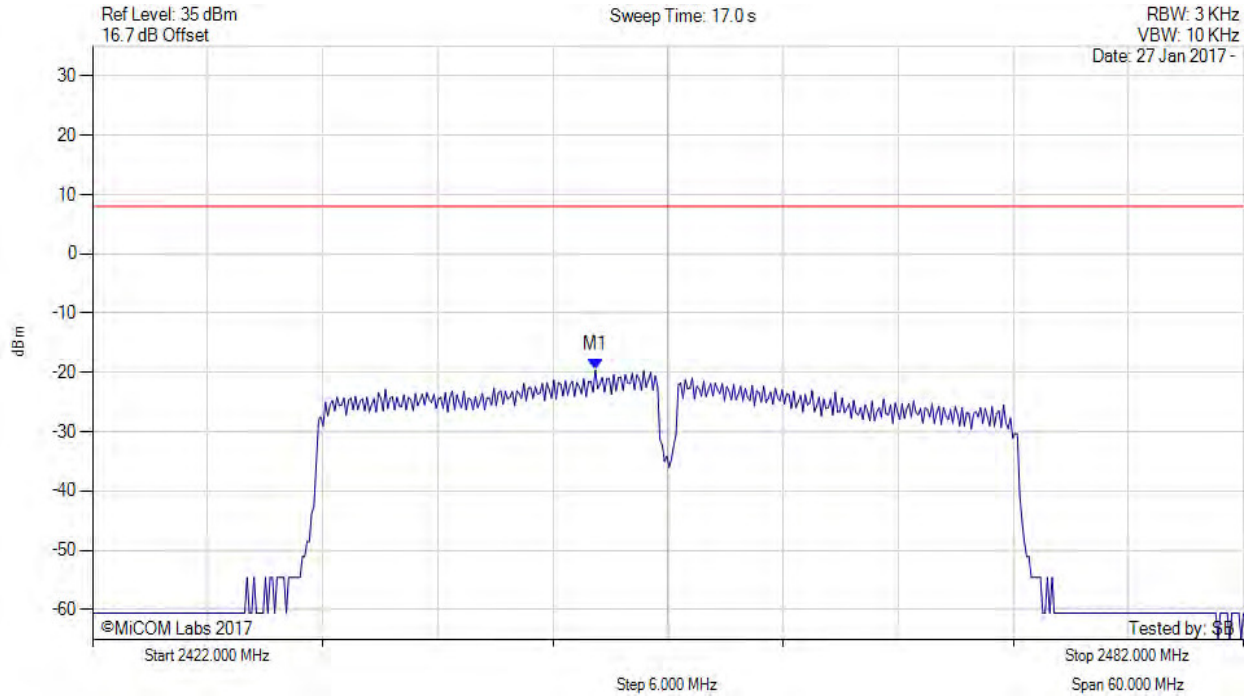

Analyzer Setup	Marker:Frequency:Amplitude	Test Results
Detector = AVERAGE Sweep Count = 0 RF Atten (dB) = 30 Trace Mode = VIEW	M1 : 2448.200 MHz : -19.581 dBm M1 + DCCF : 2448.200 MHz : -19.358 dBm Duty Cycle Correction Factor : +0.04 dB	Limit: $\leq 8.0$ dBm Margin: -27.4 dB

[back to matrix](#)

This test report may be reproduced in full only. The document may only be updated by MiCOM Labs personnel. All changes will be noted in the Document History section of the report.



**Title:** Hewlett Packard Enterprise APINR203, APINP203  
**To:** FCC CFR 47 Part 15 Subpart C 15.247 (DTS)  
**Serial #:** HPEN96-U5\_Rev A (1x1)  
**Issue Date:** 23<sup>rd</sup> March 2017  
**Page:** 104 of 135

### A.3. Emissions

#### A.3.1. Conducted Emissions

##### A.3.1.1. Conducted Spurious Emissions

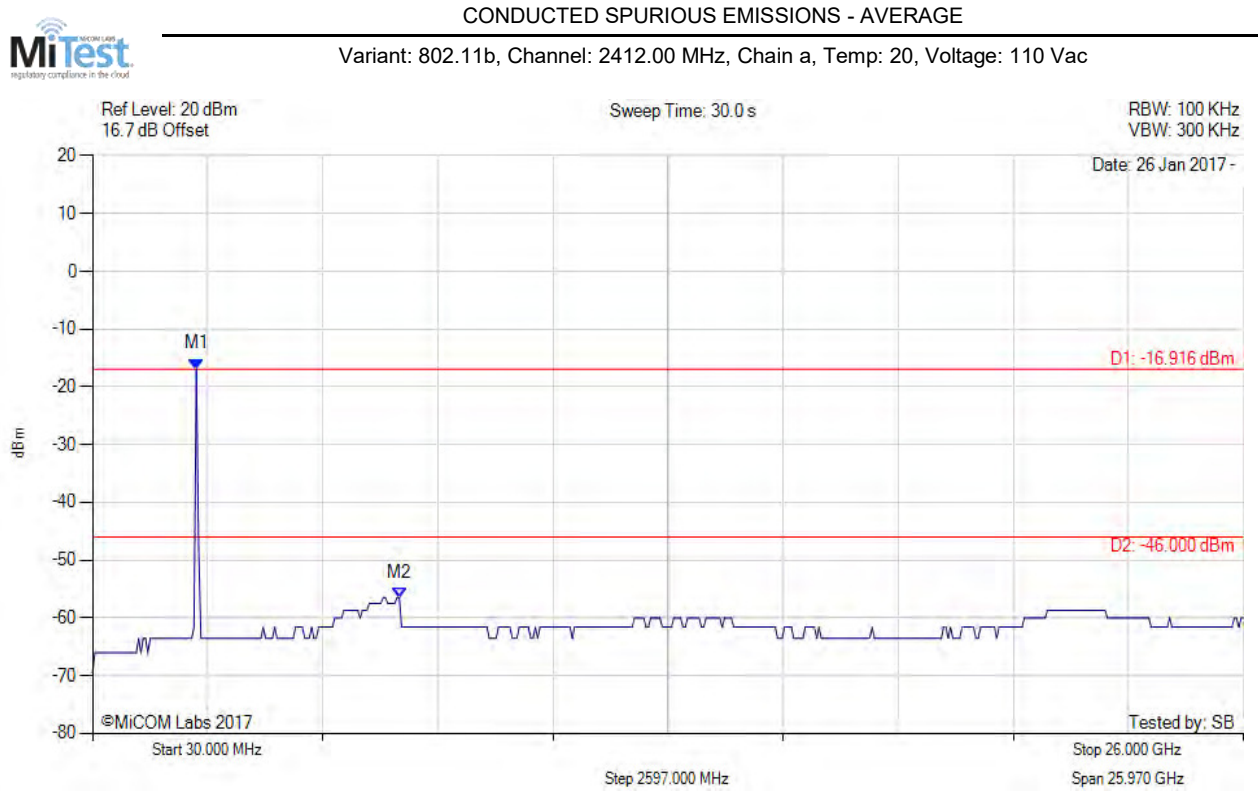

Analyzer Setup	Marker:Frequency:Amplitude	Test Results
Detector = AVERAGE Sweep Count = 0 RF Atten (dB) = 20 Trace Mode = VIEW	M1 : 2371.984 MHz : -16.916 dBm M2 : 6951.864 MHz : -56.480 dBm	Limit: -46.00 dBm Margin: -10.48 dB

[back to matrix](#)

This test report may be reproduced in full only. The document may only be updated by MiCOM Labs personnel. All changes will be noted in the Document History section of the report.





**Title:** Hewlett Packard Enterprise APINR203, APINP203  
**To:** FCC CFR 47 Part 15 Subpart C 15.247 (DTS)  
**Serial #:** HPEN96-U5\_Rev A (1x1)  
**Issue Date:** 23<sup>rd</sup> March 2017  
**Page:** 105 of 135

CONDUCTED SPURIOUS EMISSIONS - AVERAGE



Variant: 802.11b, Channel: 2437.00 MHz, Chain a, Temp: 20, Voltage: 110 Vac

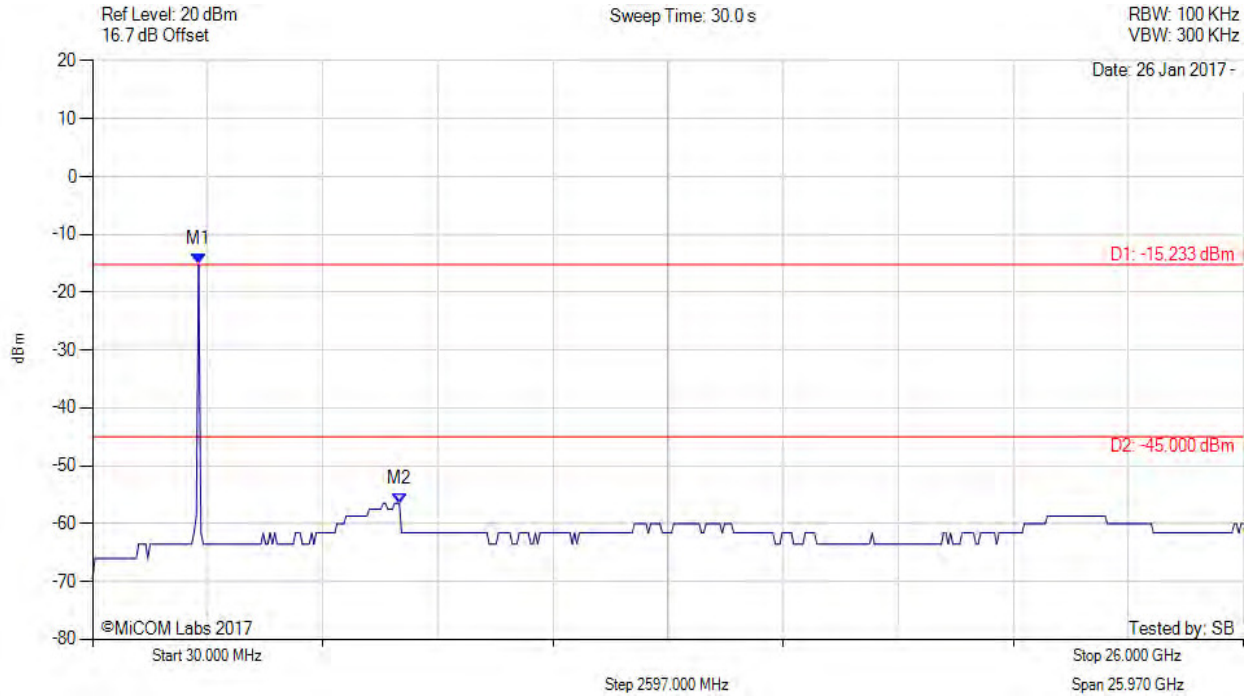

Analyzer Setup	Marker:Frequency:Amplitude	Test Results
Detector = AVERAGE Sweep Count = 0 RF Atten (dB) = 20 Trace Mode = VIEW	M1 : 2424.028 MHz : -15.233 dBm M2 : 6951.864 MHz : -56.480 dBm	Limit: -45.00 dBm Margin: -11.48 dB

[back to matrix](#)

This test report may be reproduced in full only. The document may only be updated by MiCOM Labs personnel. All changes will be noted in the Document History section of the report.



**Title:** Hewlett Packard Enterprise APINR203, APINP203  
**To:** FCC CFR 47 Part 15 Subpart C 15.247 (DTS)  
**Serial #:** HPEN96-U5\_Rev A (1x1)  
**Issue Date:** 23<sup>rd</sup> March 2017  
**Page:** 106 of 135

CONDUCTED SPURIOUS EMISSIONS - AVERAGE



Variant: 802.11b, Channel: 2462.00 MHz, Chain a, Temp: 20, Voltage: 110 Vac

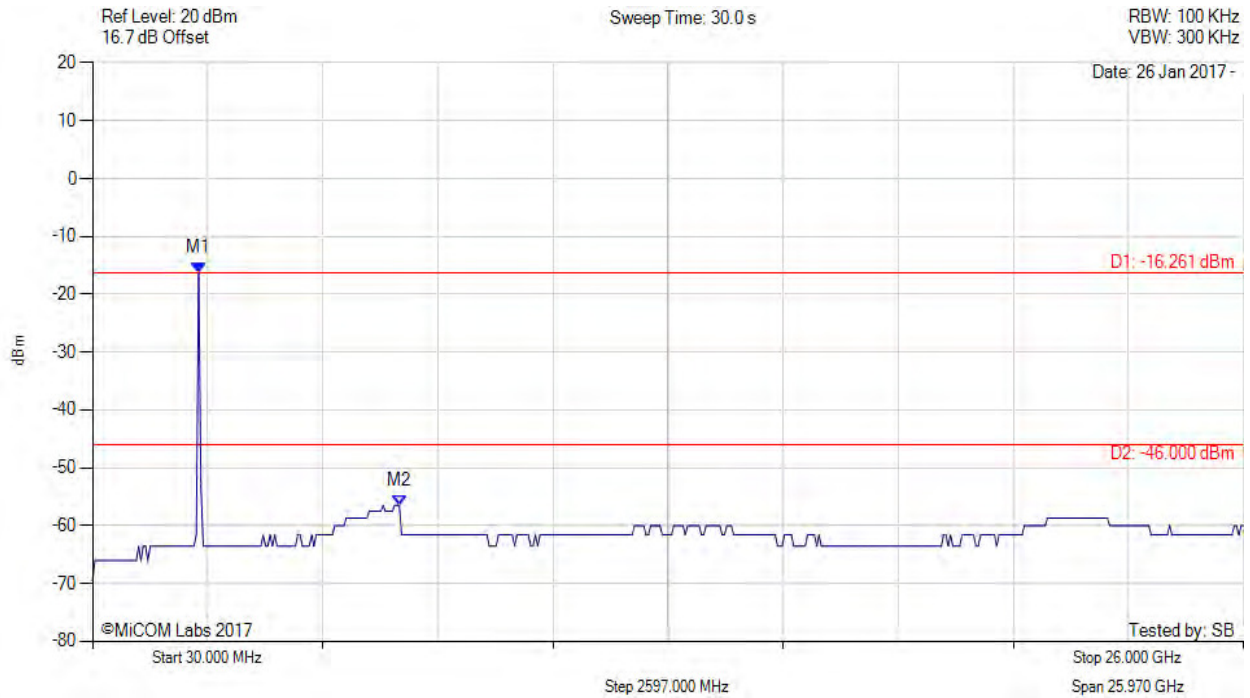

Analyzer Setup	Marker:Frequency:Amplitude	Test Results
Detector = AVERAGE Sweep Count = 0 RF Atten (dB) = 20 Trace Mode = VIEW	M1 : 2424.028 MHz : -16.261 dBm M2 : 6951.864 MHz : -56.480 dBm	Limit: -46.00 dBm Margin: -10.48 dB

[back to matrix](#)

This test report may be reproduced in full only. The document may only be updated by MiCOM Labs personnel. All changes will be noted in the Document History section of the report.



**Title:** Hewlett Packard Enterprise APINR203, APINP203  
**To:** FCC CFR 47 Part 15 Subpart C 15.247 (DTS)  
**Serial #:** HPEN96-U5\_Rev A (1x1)  
**Issue Date:** 23<sup>rd</sup> March 2017  
**Page:** 107 of 135

CONDUCTED SPURIOUS EMISSIONS - AVERAGE



Variant: 802.11g, Channel: 2412.00 MHz, Chain a, Temp: 20, Voltage: 110 Vac

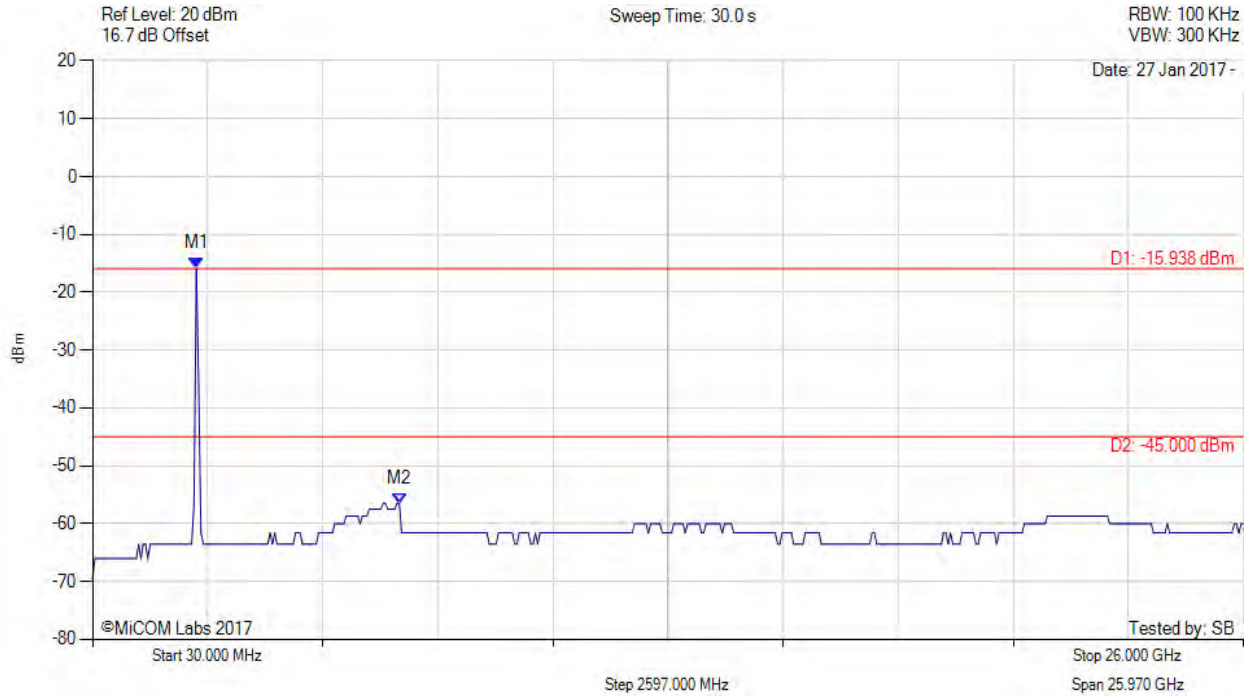

Analyzer Setup	Marker:Frequency:Amplitude	Test Results
Detector = AVERAGE Sweep Count = 0 RF Atten (dB) = 20 Trace Mode = VIEW	M1 : 2371.984 MHz : -15.938 dBm M2 : 6951.864 MHz : -56.480 dBm	Limit: -45.00 dBm Margin: -11.48 dB

[back to matrix](#)

This test report may be reproduced in full only. The document may only be updated by MiCOM Labs personnel. All changes will be noted in the Document History section of the report.



**Title:** Hewlett Packard Enterprise APINR203, APINP203  
**To:** FCC CFR 47 Part 15 Subpart C 15.247 (DTS)  
**Serial #:** HPEN96-U5\_Rev A (1x1)  
**Issue Date:** 23<sup>rd</sup> March 2017  
**Page:** 108 of 135

CONDUCTED SPURIOUS EMISSIONS - AVERAGE



Variant: 802.11g, Channel: 2437.00 MHz, Chain a, Temp: 20, Voltage: 110 Vac

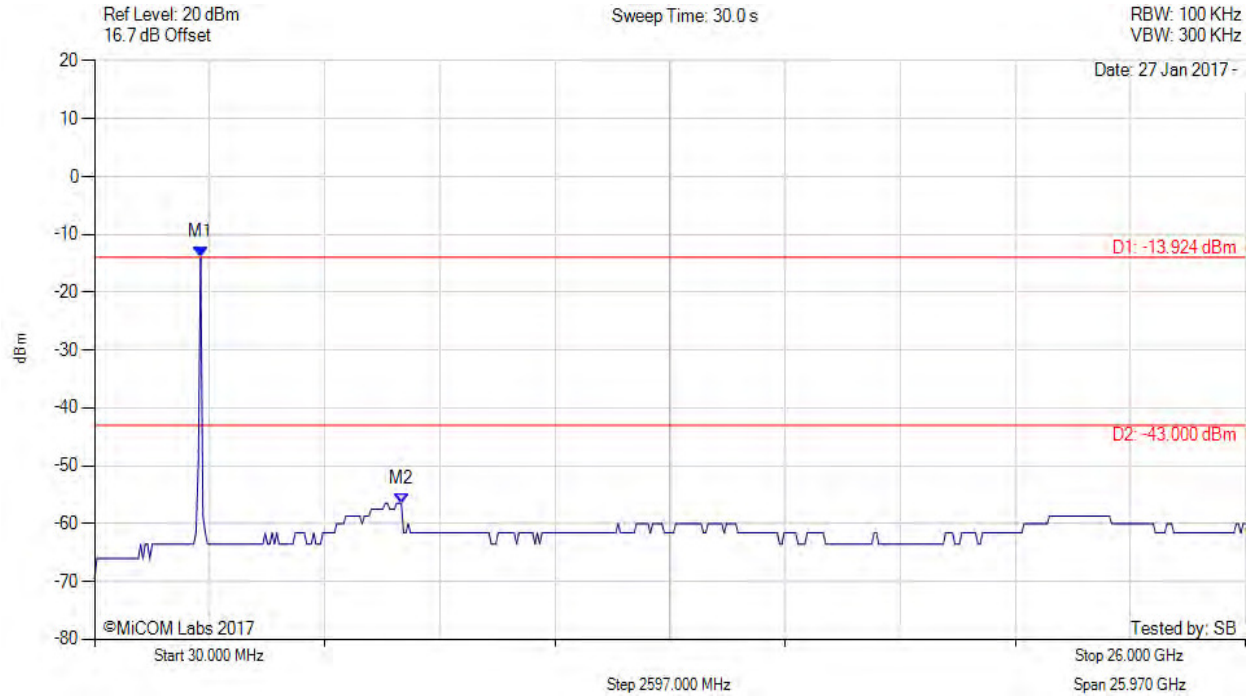

Analyzer Setup	Marker:Frequency:Amplitude	Test Results
Detector = AVERAGE Sweep Count = 0 RF Atten (dB) = 20 Trace Mode = VIEW	M1 : 2424.028 MHz : -13.924 dBm M2 : 6951.864 MHz : -56.480 dBm	Limit: -43.00 dBm Margin: -13.48 dB

[back to matrix](#)

This test report may be reproduced in full only. The document may only be updated by MiCOM Labs personnel. All changes will be noted in the Document History section of the report.



**Title:** Hewlett Packard Enterprise APINR203, APINP203  
**To:** FCC CFR 47 Part 15 Subpart C 15.247 (DTS)  
**Serial #:** HPEN96-U5\_Rev A (1x1)  
**Issue Date:** 23<sup>rd</sup> March 2017  
**Page:** 109 of 135

CONDUCTED SPURIOUS EMISSIONS - AVERAGE



Variant: 802.11g, Channel: 2462.00 MHz, Chain a, Temp: 20, Voltage: 110 Vac

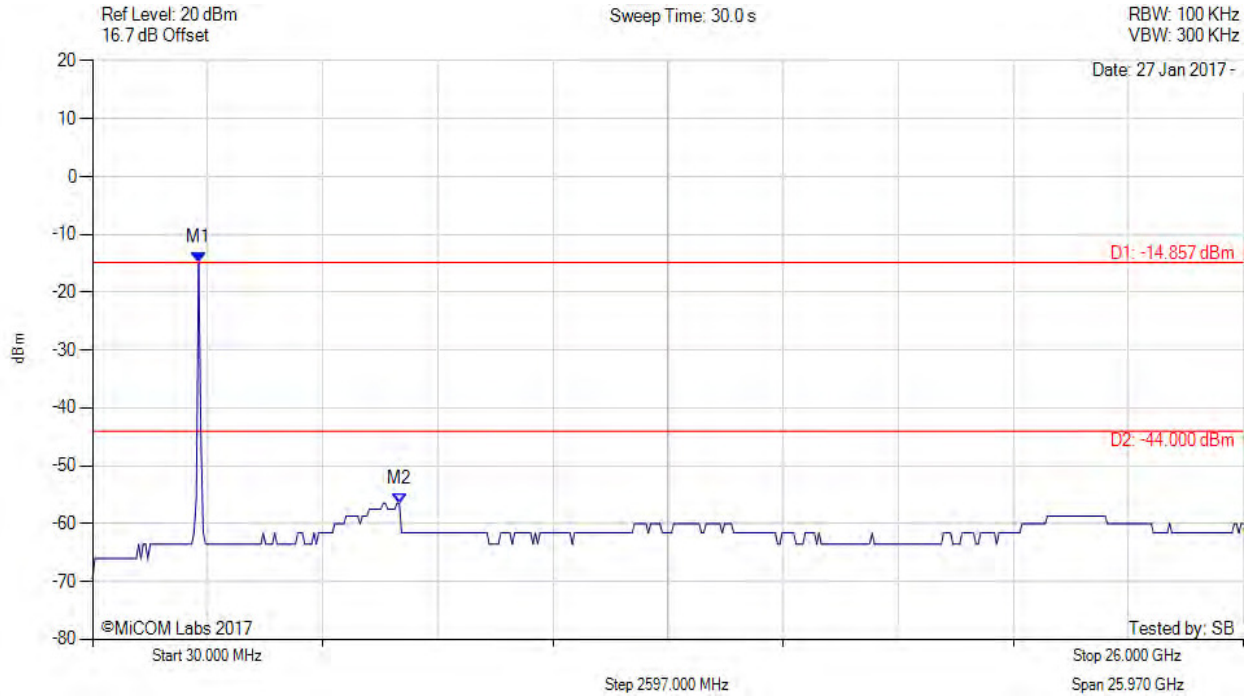

Analyzer Setup	Marker:Frequency:Amplitude	Test Results
Detector = AVERAGE Sweep Count = 0 RF Atten (dB) = 20 Trace Mode = VIEW	M1 : 2424.028 MHz : -14.857 dBm M2 : 6951.864 MHz : -56.480 dBm	Limit: -44.00 dBm Margin: -12.48 dB

[back to matrix](#)

This test report may be reproduced in full only. The document may only be updated by MiCOM Labs personnel. All changes will be noted in the Document History section of the report.



**Title:** Hewlett Packard Enterprise APINR203, APINP203  
**To:** FCC CFR 47 Part 15 Subpart C 15.247 (DTS)  
**Serial #:** HPEN96-U5\_Rev A (1x1)  
**Issue Date:** 23<sup>rd</sup> March 2017  
**Page:** 110 of 135

CONDUCTED SPURIOUS EMISSIONS - AVERAGE



Variant: 802.11n HT-20, Channel: 2412.00 MHz, Chain a, Temp: 20, Voltage: 110 Vac

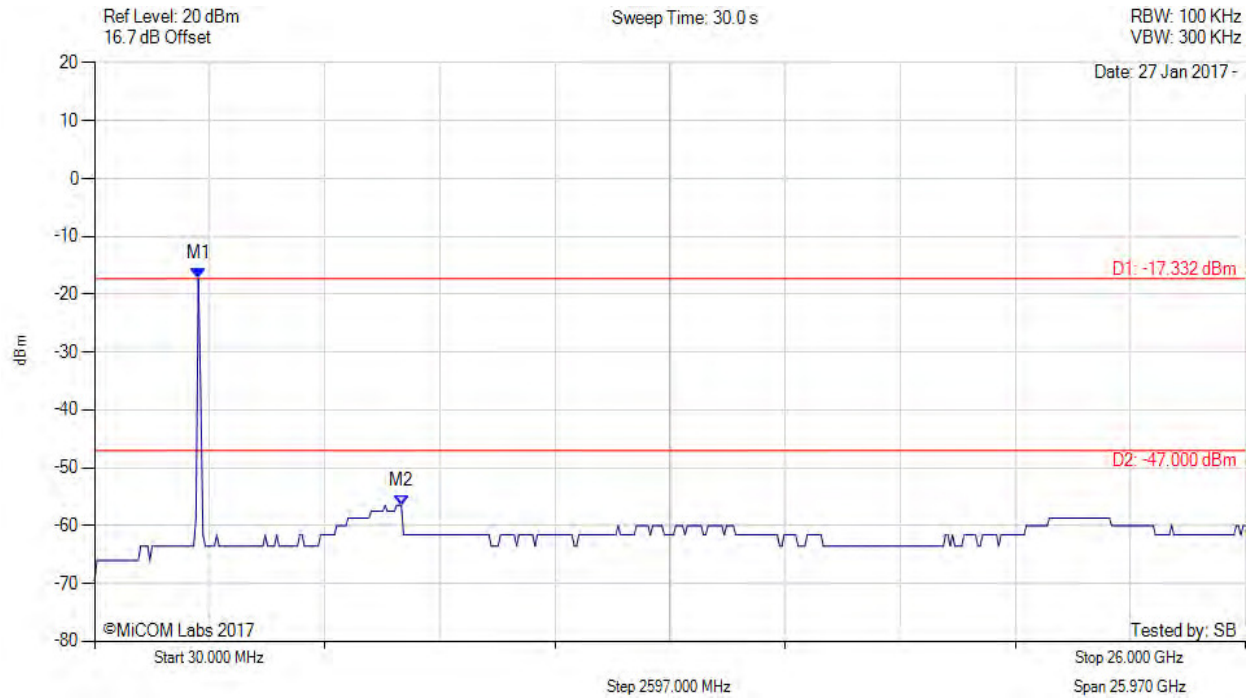

Analyzer Setup	Marker:Frequency:Amplitude	Test Results
Detector = AVERAGE Sweep Count = 0 RF Atten (dB) = 20 Trace Mode = VIEW	M1 : 2371.984 MHz : -17.332 dBm M2 : 6951.864 MHz : -56.480 dBm	Limit: -47.00 dBm Margin: -9.48 dB

[back to matrix](#)

This test report may be reproduced in full only. The document may only be updated by MiCOM Labs personnel. All changes will be noted in the Document History section of the report.



**Title:** Hewlett Packard Enterprise APINR203, APINP203  
**To:** FCC CFR 47 Part 15 Subpart C 15.247 (DTS)  
**Serial #:** HPEN96-U5\_Rev A (1x1)  
**Issue Date:** 23<sup>rd</sup> March 2017  
**Page:** 111 of 135

CONDUCTED SPURIOUS EMISSIONS - AVERAGE



Variant: 802.11n HT-20, Channel: 2437.00 MHz, Chain a, Temp: 20, Voltage: 110 Vac

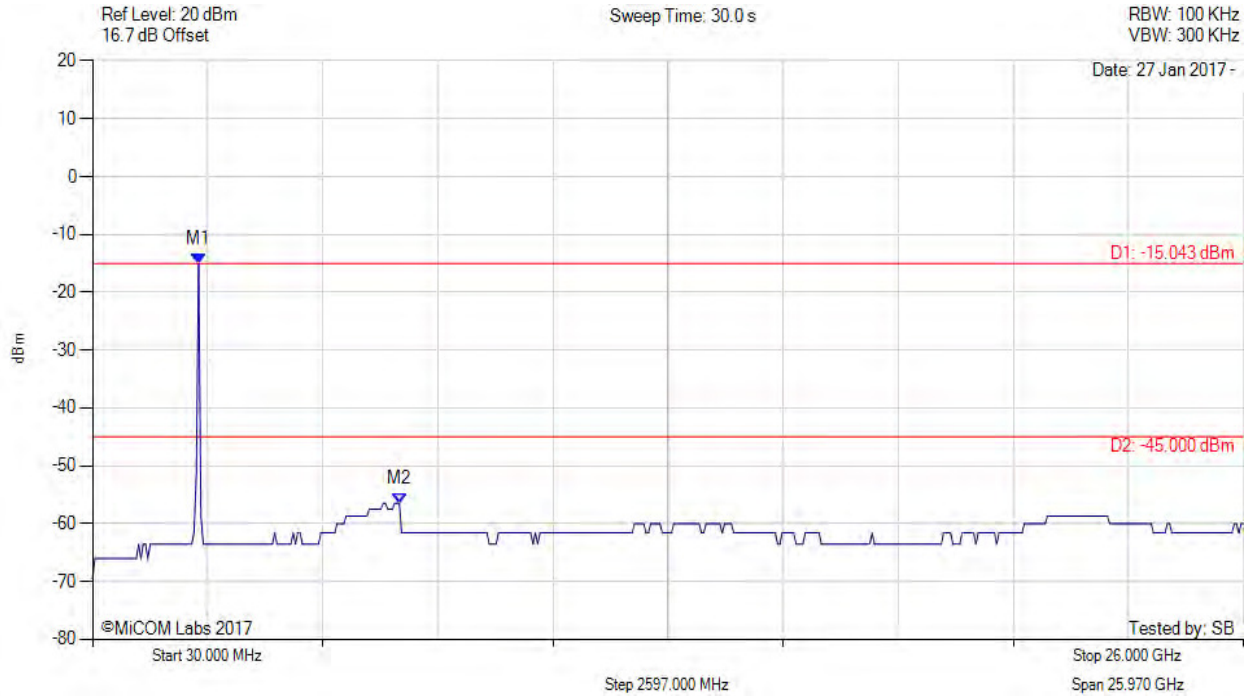

Analyzer Setup	Marker:Frequency:Amplitude	Test Results
Detector = AVERAGE Sweep Count = 0 RF Atten (dB) = 20 Trace Mode = VIEW	M1 : 2424.028 MHz : -15.043 dBm M2 : 6951.864 MHz : -56.480 dBm	Limit: -45.00 dBm Margin: -11.48 dB

[back to matrix](#)

This test report may be reproduced in full only. The document may only be updated by MiCOM Labs personnel. All changes will be noted in the Document History section of the report.



**Title:** Hewlett Packard Enterprise APINR203, APINP203  
**To:** FCC CFR 47 Part 15 Subpart C 15.247 (DTS)  
**Serial #:** HPEN96-U5\_Rev A (1x1)  
**Issue Date:** 23<sup>rd</sup> March 2017  
**Page:** 112 of 135

CONDUCTED SPURIOUS EMISSIONS - AVERAGE



Variant: 802.11n HT-20, Channel: 2462.00 MHz, Chain a, Temp: 20, Voltage: 110 Vac

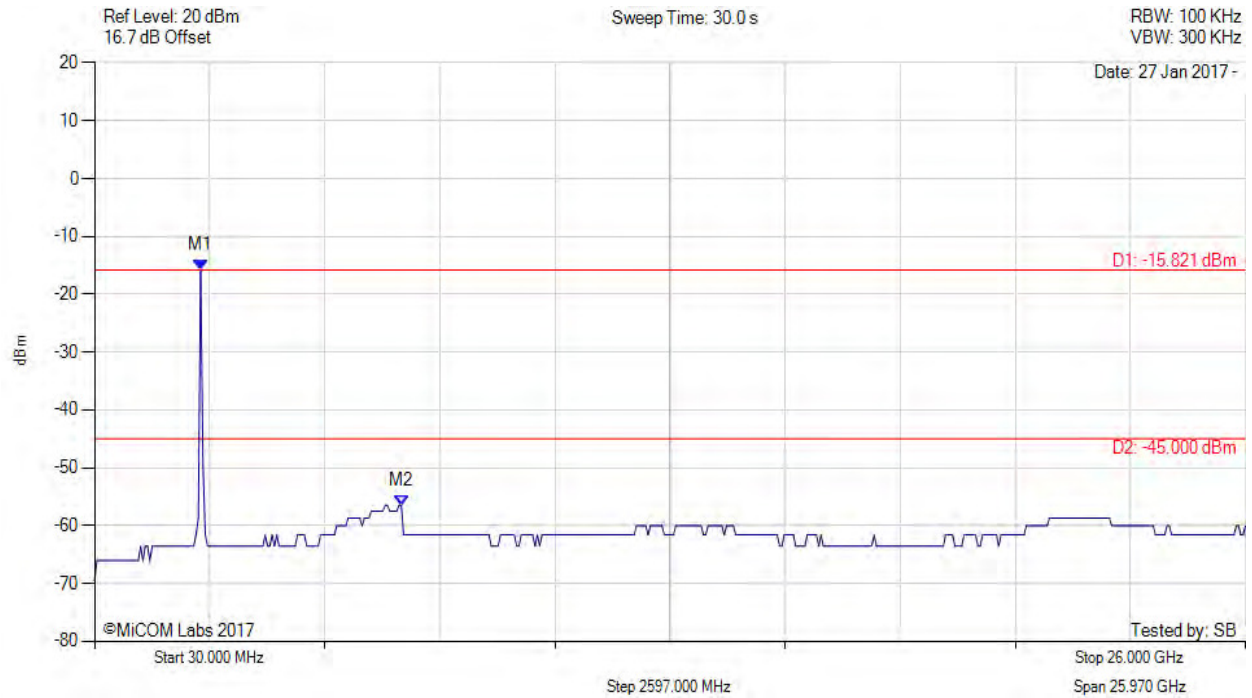

Analyzer Setup	Marker:Frequency:Amplitude	Test Results
Detector = AVERAGE Sweep Count = 0 RF Atten (dB) = 20 Trace Mode = VIEW	M1 : 2424.028 MHz : -15.821 dBm M2 : 6951.864 MHz : -56.480 dBm	Limit: -45.00 dBm Margin: -11.48 dB

[back to matrix](#)

This test report may be reproduced in full only. The document may only be updated by MiCOM Labs personnel. All changes will be noted in the Document History section of the report.





**Title:** Hewlett Packard Enterprise APINR203, APINP203  
**To:** FCC CFR 47 Part 15 Subpart C 15.247 (DTS)  
**Serial #:** HPEN96-U5\_Rev A (1x1)  
**Issue Date:** 23<sup>rd</sup> March 2017  
**Page:** 113 of 135

CONDUCTED SPURIOUS EMISSIONS - AVERAGE



Variant: 802.11n HT-40, Channel: 2422.00 MHz, Chain a, Temp: 20, Voltage: 110 Vac

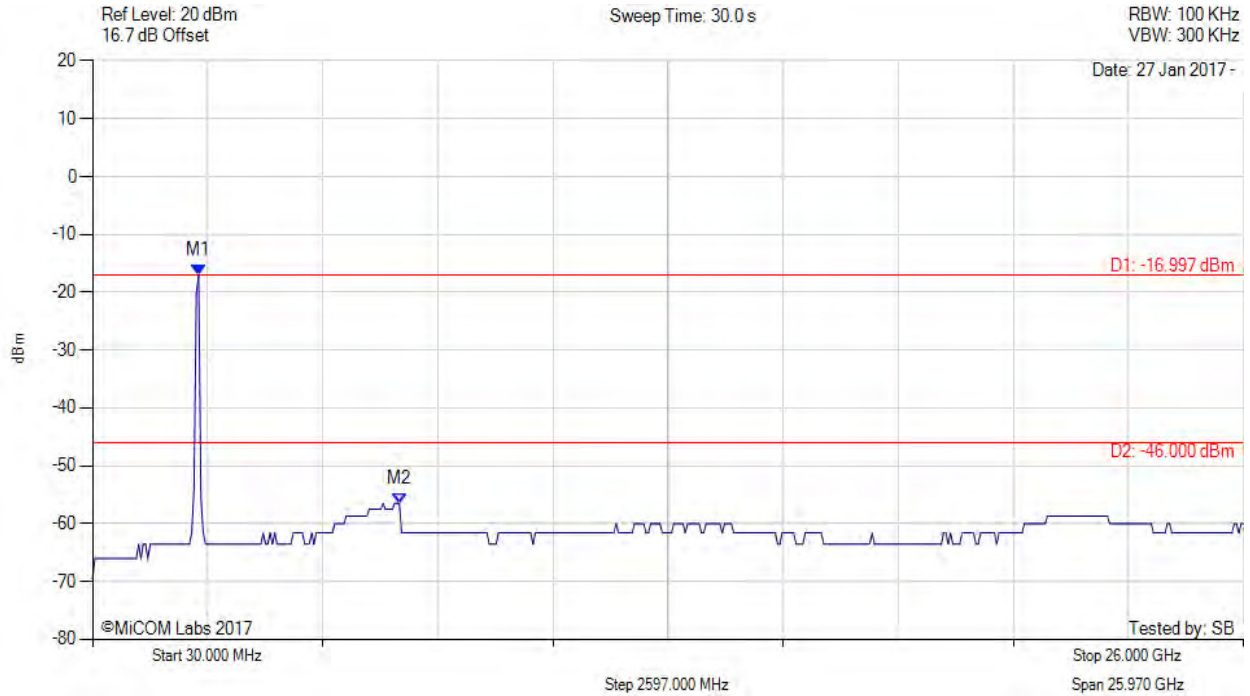

Analyzer Setup	Marker:Frequency:Amplitude	Test Results
Detector = AVERAGE Sweep Count = 0 RF Atten (dB) = 20 Trace Mode = VIEW	M1 : 2424.028 MHz : -16.997 dBm M2 : 6951.864 MHz : -56.480 dBm	Limit: -46.00 dBm Margin: -10.48 dB

[back to matrix](#)

This test report may be reproduced in full only. The document may only be updated by MiCOM Labs personnel. All changes will be noted in the Document History section of the report.



**Title:** Hewlett Packard Enterprise APINR203, APINP203  
**To:** FCC CFR 47 Part 15 Subpart C 15.247 (DTS)  
**Serial #:** HPEN96-U5\_Rev A (1x1)  
**Issue Date:** 23<sup>rd</sup> March 2017  
**Page:** 114 of 135

CONDUCTED SPURIOUS EMISSIONS - AVERAGE



Variant: 802.11n HT-40, Channel: 2437.00 MHz, Chain a, Temp: 20, Voltage: 110 Vac

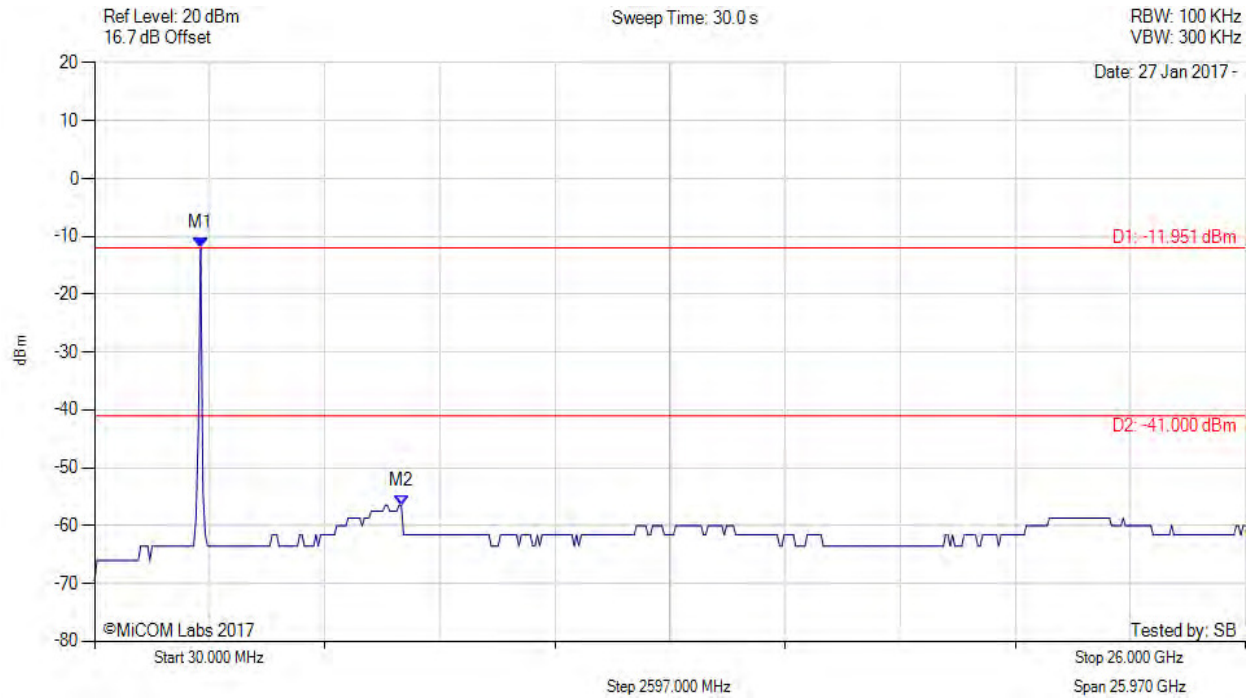

Analyzer Setup	Marker:Frequency:Amplitude	Test Results
Detector = AVERAGE Sweep Count = 0 RF Atten (dB) = 20 Trace Mode = VIEW	M1 : 2424.028 MHz : -11.951 dBm M2 : 6951.864 MHz : -56.480 dBm	Limit: -41.00 dBm Margin: -15.48 dB

[back to matrix](#)

This test report may be reproduced in full only. The document may only be updated by MiCOM Labs personnel. All changes will be noted in the Document History section of the report.



**Title:** Hewlett Packard Enterprise APINR203, APINP203  
**To:** FCC CFR 47 Part 15 Subpart C 15.247 (DTS)  
**Serial #:** HPEN96-U5\_Rev A (1x1)  
**Issue Date:** 23<sup>rd</sup> March 2017  
**Page:** 115 of 135

CONDUCTED SPURIOUS EMISSIONS - AVERAGE



Variation: 802.11n HT-40, Channel: 2452.00 MHz, Chain a, Temp: 20, Voltage: 110 Vac

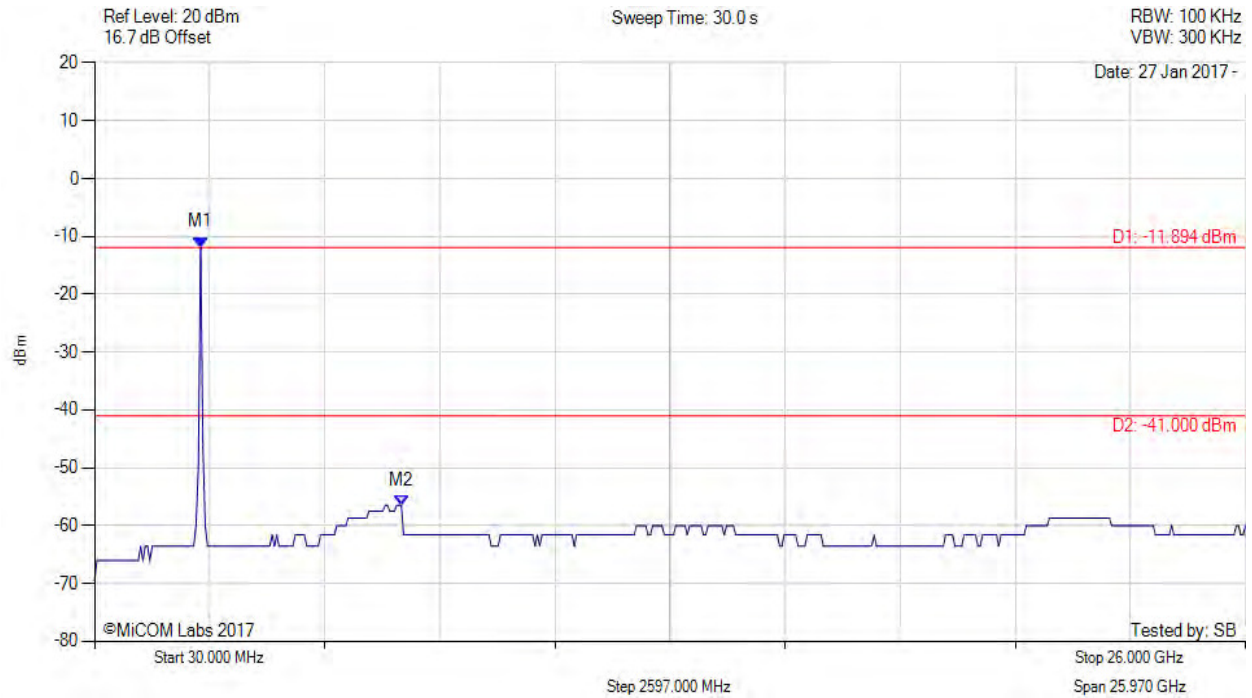

Analyzer Setup	Marker:Frequency:Amplitude	Test Results
Detector = AVERAGE Sweep Count = 0 RF Atten (dB) = 20 Trace Mode = VIEW	M1 : 2424.028 MHz : -11.894 dBm M2 : 6951.864 MHz : -56.480 dBm	Limit: -41.00 dBm Margin: -15.48 dB

[back to matrix](#)

This test report may be reproduced in full only. The document may only be updated by MiCOM Labs personnel. All changes will be noted in the Document History section of the report.



### A.3.1.2. Conducted Band-Edge Emissions



#### CONDUCTED LOW BAND-EDGE EMISSIONS - AVERAGE

Variant: 802.11b, Channel: 2412.00 MHz, Chain a, Temp: 20, Voltage: 110 Vac

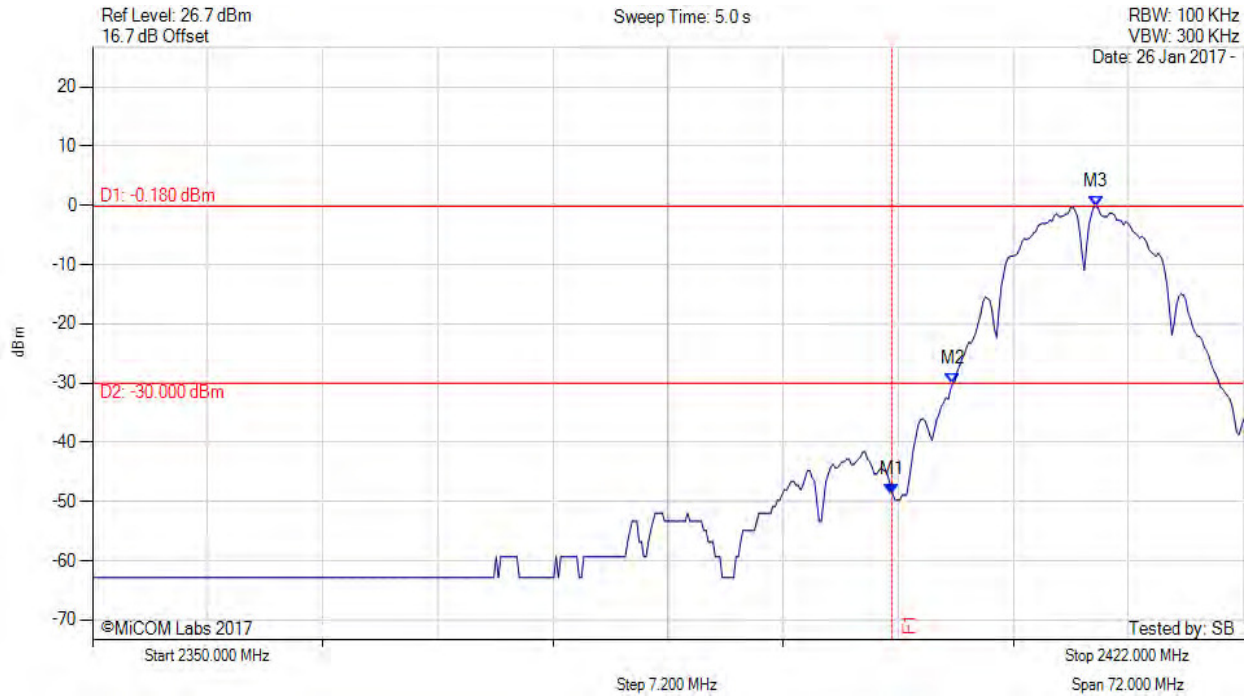

Analyzer Setup	Marker:Frequency:Amplitude	Test Results
Detector = AVERAGE Sweep Count = 0 RF Atten (dB) = 20 Trace Mode = VIEW	M1 : 2400.000 MHz : -48.865 dBm M2 : 2403.820 MHz : -30.075 dBm M3 : 2412.766 MHz : -0.180 dBm	Channel Frequency: 2412.00 MHz

[back to matrix](#)

This test report may be reproduced in full only. The document may only be updated by MiCOM Labs personnel. All changes will be noted in the Document History section of the report.



**Title:** Hewlett Packard Enterprise APINR203, APINP203  
**To:** FCC CFR 47 Part 15 Subpart C 15.247 (DTS)  
**Serial #:** HPEN96-U5\_Rev A (1x1)  
**Issue Date:** 23<sup>rd</sup> March 2017  
**Page:** 117 of 135



CONDUCTED LOW BAND-EDGE EMISSIONS - AVERAGE

Variant: 802.11g, Channel: 2412.00 MHz, Chain a, Temp: 20, Voltage: 110 Vac

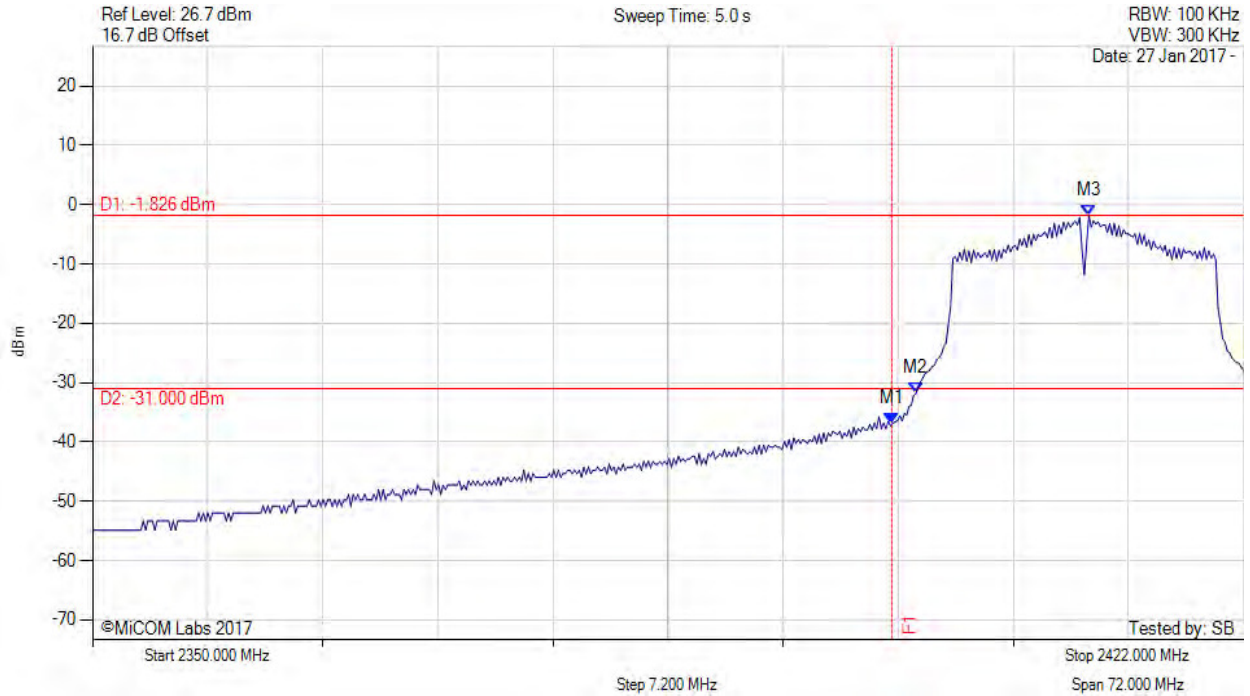

Analyzer Setup	Marker:Frequency:Amplitude	Test Results
Detector = AVERAGE Sweep Count = 0 RF Atten (dB) = 20 Trace Mode = VIEW	M1 : 2400.000 MHz : -36.824 dBm M2 : 2401.511 MHz : -31.840 dBm M3 : 2412.333 MHz : -1.826 dBm	Channel Frequency: 2412.00 MHz

[back to matrix](#)

This test report may be reproduced in full only. The document may only be updated by MiCOM Labs personnel. All changes will be noted in the Document History section of the report.



**Title:** Hewlett Packard Enterprise APINR203, APINP203  
**To:** FCC CFR 47 Part 15 Subpart C 15.247 (DTS)  
**Serial #:** HPEN96-U5\_Rev A (1x1)  
**Issue Date:** 23<sup>rd</sup> March 2017  
**Page:** 118 of 135



CONDUCTED LOW BAND-EDGE EMISSIONS - AVERAGE

Variant: 802.11n HT-20, Channel: 2412.00 MHz, Chain a, Temp: 20, Voltage: 110 Vac

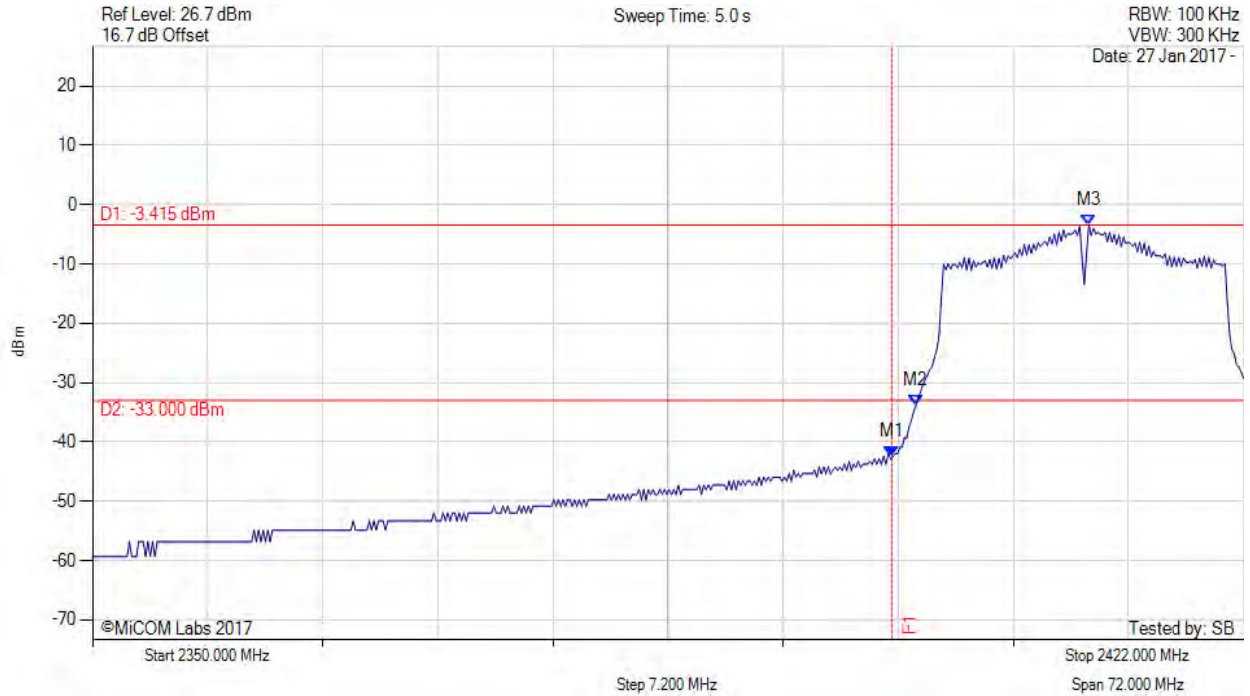

Analyzer Setup	Marker:Frequency:Amplitude	Test Results
Detector = AVERAGE Sweep Count = 0 RF Atten (dB) = 20 Trace Mode = VIEW	M1 : 2400.000 MHz : -42.421 dBm M2 : 2401.511 MHz : -33.902 dBm M3 : 2412.333 MHz : -3.415 dBm	Channel Frequency: 2412.00 MHz

[back to matrix](#)

This test report may be reproduced in full only. The document may only be updated by MiCOM Labs personnel. All changes will be noted in the Document History section of the report.



**Title:** Hewlett Packard Enterprise APINR203, APINP203  
**To:** FCC CFR 47 Part 15 Subpart C 15.247 (DTS)  
**Serial #:** HPEN96-U5\_Rev A (1x1)  
**Issue Date:** 23rd March 2017  
**Page:** 119 of 135

CONDUCTED LOW BAND-EDGE EMISSIONS - AVERAGE



Variant: 802.11n HT-40, Channel: 2422.00 MHz, Chain a, Temp: 20, Voltage: 110 Vac

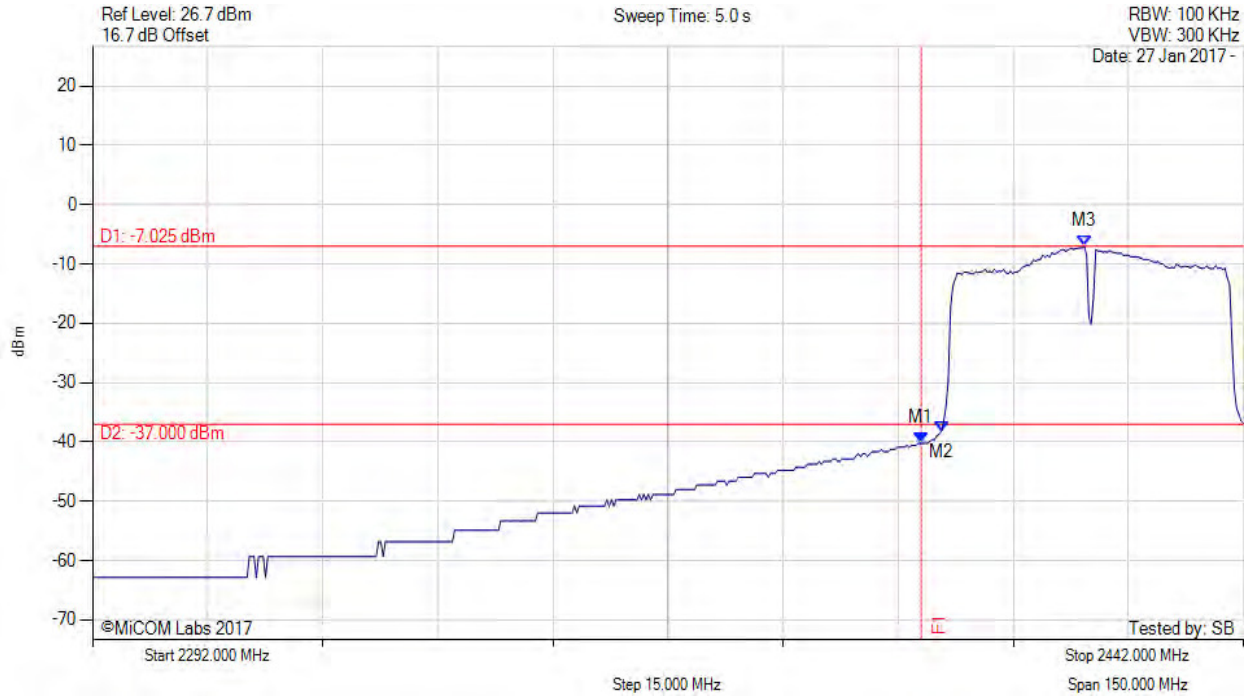

Analyzer Setup	Marker:Frequency:Amplitude	Test Results
Detector = AVERAGE Sweep Count = 0 RF Atten (dB) = 20 Trace Mode = VIEW	M1 : 2400.000 MHz : -40.238 dBm M2 : 2402.621 MHz : -38.236 dBm M3 : 2421.259 MHz : -7.025 dBm	Channel Frequency: 2422.00 MHz

[back to matrix](#)

This test report may be reproduced in full only. The document may only be updated by MiCOM Labs personnel. All changes will be noted in the Document History section of the report.



**Title:** Hewlett Packard Enterprise APINR203, APINP203  
**To:** FCC CFR 47 Part 15 Subpart C 15.247 (DTS)  
**Serial #:** HPEN96-U5\_Rev A (1x1)  
**Issue Date:** 23<sup>rd</sup> March 2017  
**Page:** 120 of 135

CONDUCTED HIGH BAND-EDGE EMISSIONS - AVERAGE



Variant: 802.11b, Channel: 2462.00 MHz, Chain a, Temp: 20, Voltage: 110 Vac

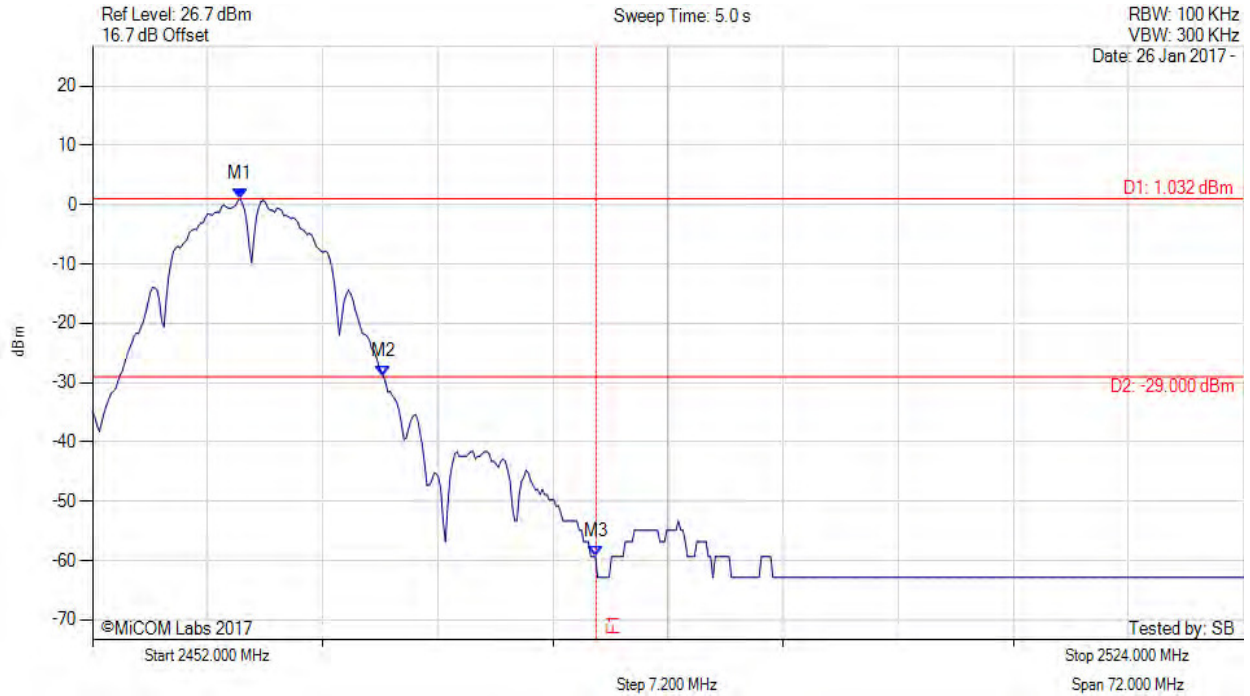

Analyzer Setup	Marker:Frequency:Amplitude	Test Results
Detector = AVERAGE Sweep Count = 0 RF Atten (dB) = 20 Trace Mode = VIEW	M1 : 2461.234 MHz : 1.032 dBm M2 : 2470.180 MHz : -28.865 dBm M3 : 2483.500 MHz : -59.323 dBm	Channel Frequency: 2462.00 MHz

[back to matrix](#)

This test report may be reproduced in full only. The document may only be updated by MiCOM Labs personnel. All changes will be noted in the Document History section of the report.





**Title:** Hewlett Packard Enterprise APINR203, APINP203  
**To:** FCC CFR 47 Part 15 Subpart C 15.247 (DTS)  
**Serial #:** HPEN96-U5\_Rev A (1x1)  
**Issue Date:** 23<sup>rd</sup> March 2017  
**Page:** 121 of 135

CONDUCTED HIGH BAND-EDGE EMISSIONS - AVERAGE



Variant: 802.11g, Channel: 2462.00 MHz, Chain a, Temp: 20, Voltage: 110 Vac

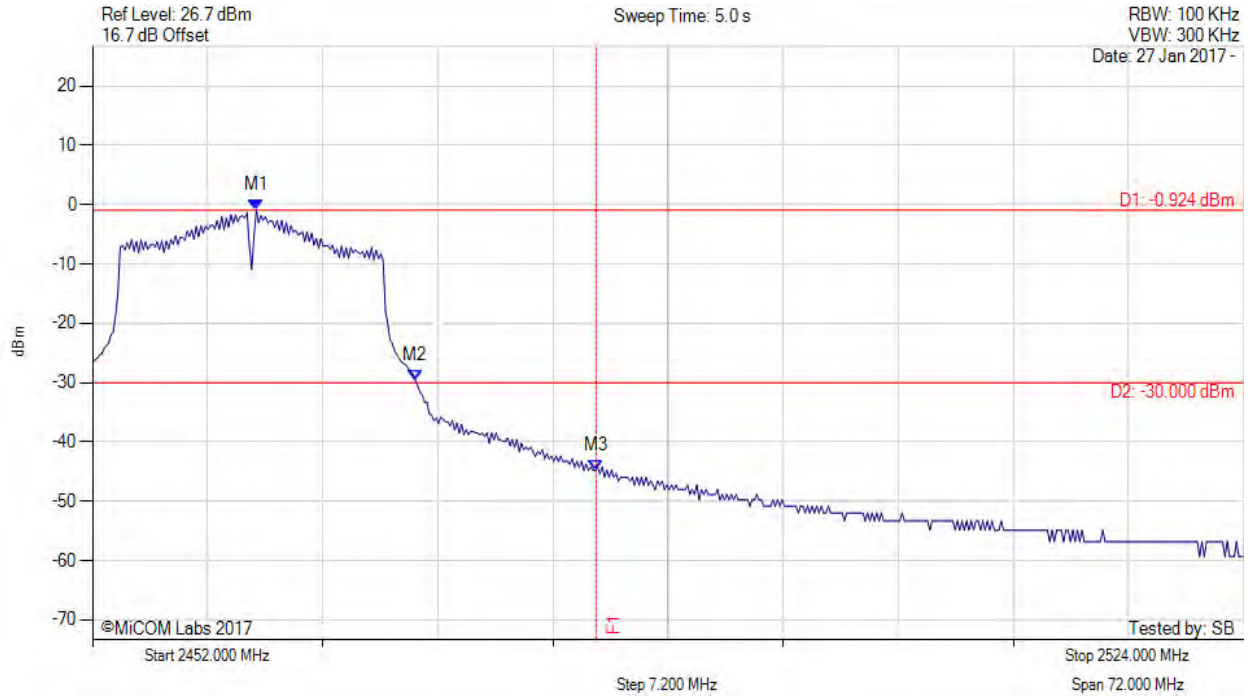

Analyzer Setup	Marker:Frequency:Amplitude	Test Results
Detector = AVERAGE Sweep Count = 0 RF Atten (dB) = 20 Trace Mode = VIEW	M1 : 2462.244 MHz : -0.924 dBm M2 : 2472.200 MHz : -29.590 dBm M3 : 2483.500 MHz : -44.783 dBm	Channel Frequency: 2462.00 MHz

[back to matrix](#)

This test report may be reproduced in full only. The document may only be updated by MiCOM Labs personnel. All changes will be noted in the Document History section of the report.



**Title:** Hewlett Packard Enterprise APINR203, APINP203  
**To:** FCC CFR 47 Part 15 Subpart C 15.247 (DTS)  
**Serial #:** HPEN96-U5\_Rev A (1x1)  
**Issue Date:** 23<sup>rd</sup> March 2017  
**Page:** 122 of 135

CONDUCTED HIGH BAND-EDGE EMISSIONS - AVERAGE



Variant: 802.11n HT-20, Channel: 2462.00 MHz, Chain a, Temp: 20, Voltage: 110 Vac

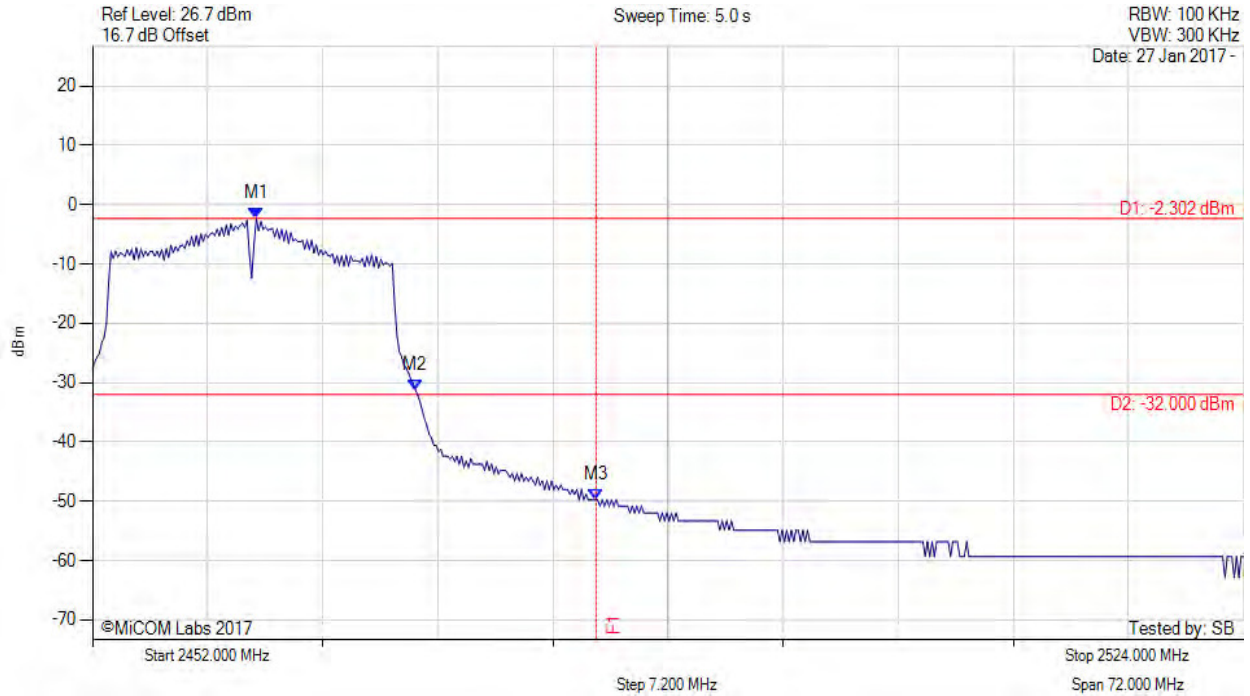

Analyzer Setup	Marker:Frequency:Amplitude	Test Results
Detector = AVERAGE Sweep Count = 0 RF Atten (dB) = 20 Trace Mode = VIEW	M1 : 2462.244 MHz : -2.302 dBm M2 : 2472.200 MHz : -31.249 dBm M3 : 2483.500 MHz : -49.780 dBm	Channel Frequency: 2462.00 MHz

[back to matrix](#)

This test report may be reproduced in full only. The document may only be updated by MiCOM Labs personnel. All changes will be noted in the Document History section of the report.



**Title:** Hewlett Packard Enterprise APINR203, APINP203  
**To:** FCC CFR 47 Part 15 Subpart C 15.247 (DTS)  
**Serial #:** HPEN96-U5\_Rev A (1x1)  
**Issue Date:** 23<sup>rd</sup> March 2017  
**Page:** 123 of 135

CONDUCTED HIGH BAND-EDGE EMISSIONS - AVERAGE



Variant: 802.11n HT-40, Channel: 2452.00 MHz, Chain a, Temp: 20, Voltage: 110 Vac

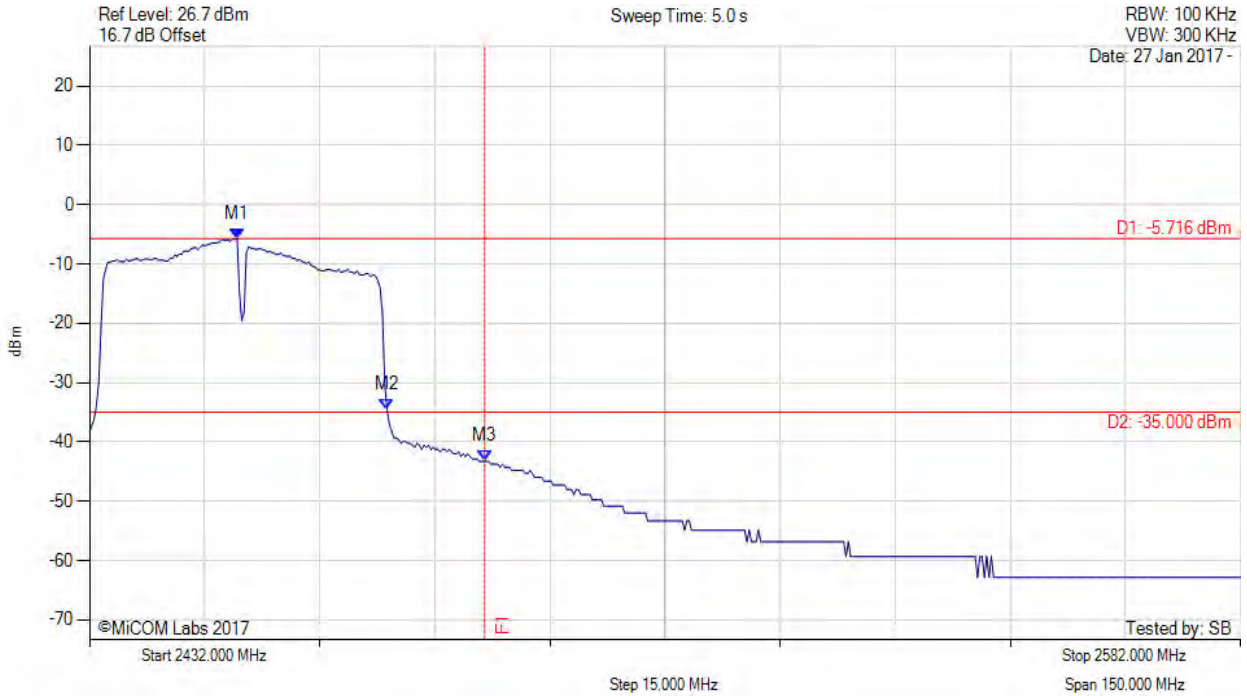

Analyzer Setup	Marker:Frequency:Amplitude	Test Results
Detector = AVERAGE Sweep Count = 0 RF Atten (dB) = 20 Trace Mode = VIEW	M1 : 2451.238 MHz : -5.716 dBm M2 : 2470.778 MHz : -34.545 dBm M3 : 2483.500 MHz : -43.290 dBm	Channel Frequency: 2452.00 MHz

[back to matrix](#)

This test report may be reproduced in full only. The document may only be updated by MiCOM Labs personnel. All changes will be noted in the Document History section of the report.



**Title:** Hewlett Packard Enterprise APINR203, APINP203  
**To:** FCC CFR 47 Part 15 Subpart C 15.247 (DTS)  
**Serial #:** HPEN96-U5\_Rev A (1x1)  
**Issue Date:** 23<sup>rd</sup> March 2017  
**Page:** 124 of 135

### A.3.2. Radiated Emissions

#### A.3.2.1. TX Spurious & Restricted Band Emissions

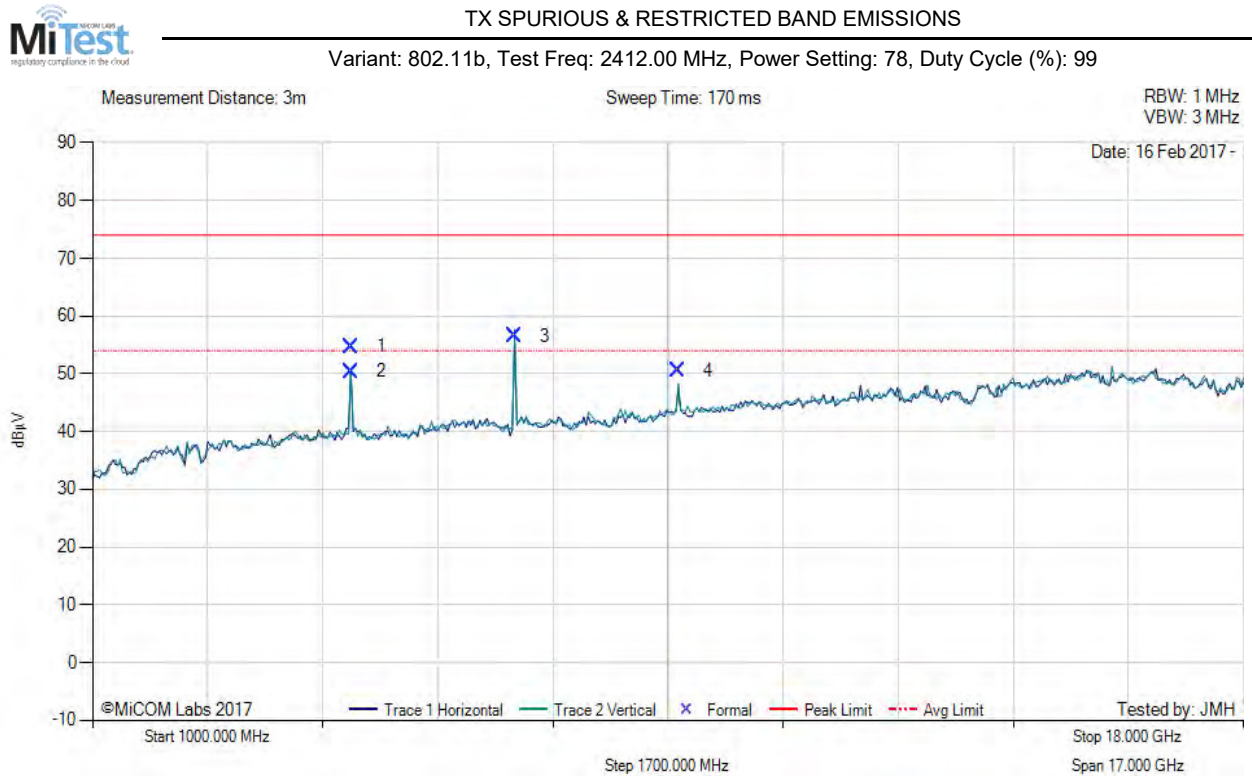

1000.00 - 18000.00 MHz												
Num	Frequency MHz	Raw dBµV	Cable Loss dB	AF dB	Level dBµV/m	Measurement Type	Pol	Hgt cm	Azt Deg	Limit dBµV/m	Margin dB	Pass /Fail
1	4823.95	62.34	3.54	-11.15	54.73	Max Peak	Vertical	179	92	74.0	-19.3	Pass
2	4823.95	57.99	3.54	-11.15	50.38	Max Avg	Vertical	179	92	54.0	-3.6	Pass
3	7234.96	59.59	4.26	-7.34	56.51	Peak (NRB)	Vertical	100	0	--	--	Pass
4	9647.94	51.31	5.29	-6.08	50.52	Peak (NRB)	Vertical	100	0	--	--	Pass

**Test Notes:** AP203RP SN# CNCPK2T00L on 150cm table powered by AC.

[back to matrix](#)

This test report may be reproduced in full only. The document may only be updated by MiCOM Labs personnel. All changes will be noted in the Document History section of the report.



**Title:** Hewlett Packard Enterprise APINR203, APINP203  
**To:** FCC CFR 47 Part 15 Subpart C 15.247 (DTS)  
**Serial #:** HPEN96-U5\_Rev A (1x1)  
**Issue Date:** 23<sup>rd</sup> March 2017  
**Page:** 125 of 135



**TX SPURIOUS & RESTRICTED BAND EMISSIONS**

Variant: 802.11b, Test Freq: 2437.00 MHz, Power Setting: 78, Duty Cycle (%): 99

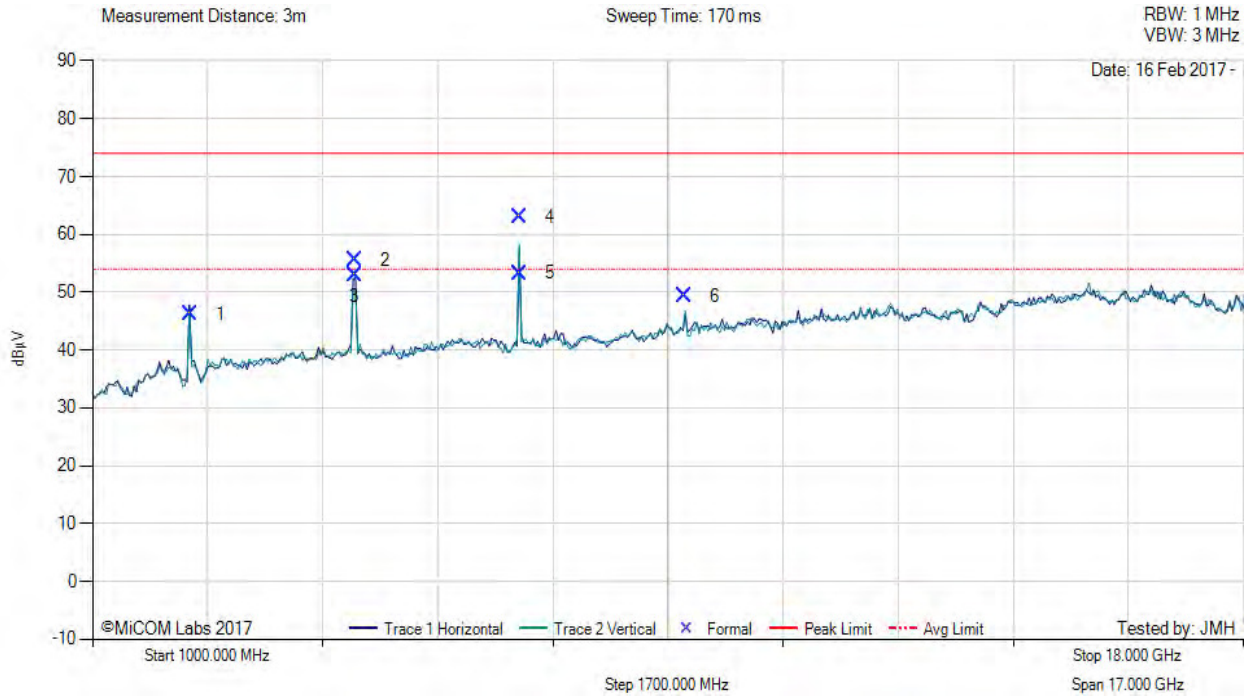

1000.00 - 18000.00 MHz												
Num	Frequency MHz	Raw dBµV	Cable Loss dB	AF dB	Level dBµV/m	Measurement Type	Pol	Hgt cm	Azt Deg	Limit dBµV/m	Margin dB	Pass /Fail
1	2437.98	55.19	2.72	-11.73	46.18	Fundamental	Horizontal	100	0	--	--	
2	4874.00	63.27	3.53	-11.24	55.56	Max Peak	Horizontal	102	338	74.0	-18.4	Pass
3	4874.00	60.65	3.53	-11.24	52.94	Max Avg	Horizontal	102	338	54.0	-1.1	Pass
4	7310.04	66.00	4.24	-7.29	62.95	Max Peak	Vertical	115	313	74.0	-11.1	Pass
5	7310.04	56.30	4.24	-7.29	53.25	Max Avg	Vertical	115	313	54.0	-0.8	Pass
6	9747.94	50.32	5.29	-6.23	49.38	Peak (NRB)	Vertical	100	0	--	--	Pass

**Test Notes:** AP203RP SN# CNCPK2T00L on 150cm table powered by AC.

[back to matrix](#)

This test report may be reproduced in full only. The document may only be updated by MiCOM Labs personnel. All changes will be noted in the Document History section of the report.



**Title:** Hewlett Packard Enterprise APINR203, APINP203  
**To:** FCC CFR 47 Part 15 Subpart C 15.247 (DTS)  
**Serial #:** HPEN96-U5\_Rev A (1x1)  
**Issue Date:** 23<sup>rd</sup> March 2017  
**Page:** 126 of 135



**TX SPURIOUS & RESTRICTED BAND EMISSIONS**

Variant: 802.11b, Test Freq: 2462.00 MHz, Power Setting: 78, Duty Cycle (%): 99

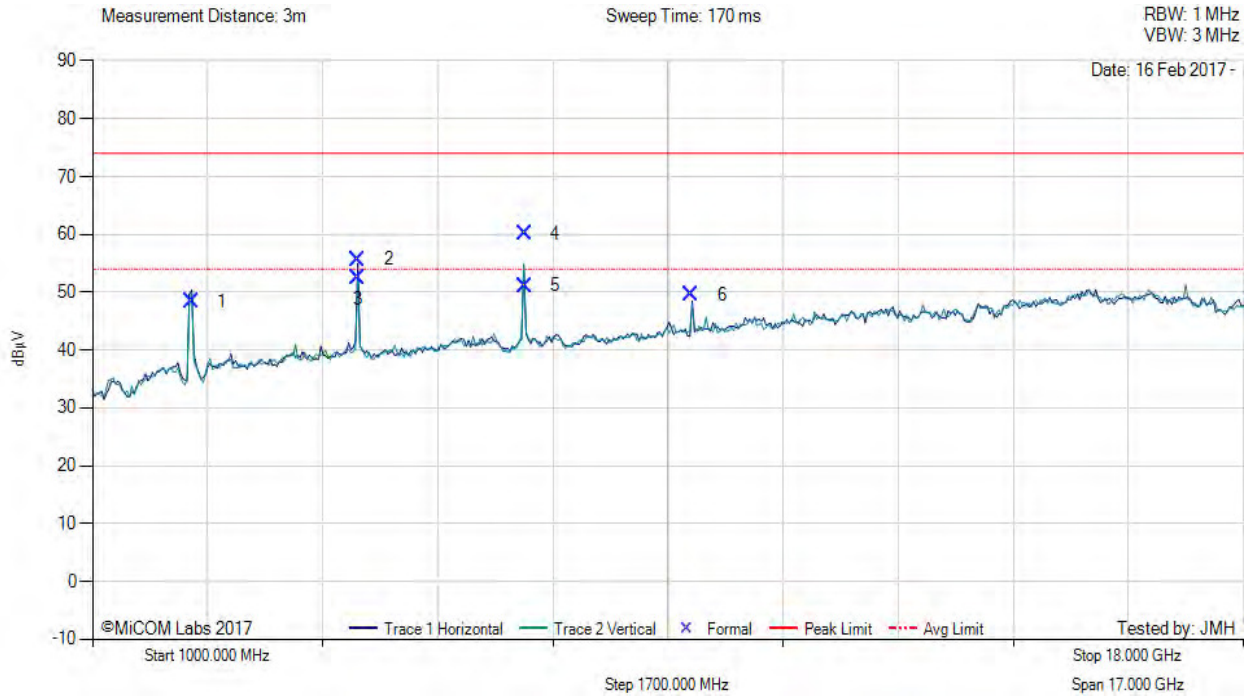

1000.00 - 18000.00 MHz												
Num	Frequency MHz	Raw dBµV	Cable Loss dB	AF dB	Level dBµV/m	Measurement Type	Pol	Hgt cm	Azt Deg	Limit dBµV/m	Margin dB	Pass /Fail
1	2462.89	57.31	2.74	-11.67	48.38	Fundamental	Horizontal	100	0	--	--	
2	4923.95	63.51	3.58	-11.38	55.71	Max Peak	Horizontal	98	70	74.0	-18.3	Pass
3	4923.95	60.31	3.58	-11.38	52.51	Max Avg	Horizontal	98	70	54.0	-1.5	Pass
4	7384.95	63.02	4.29	-7.17	60.14	Max Peak	Vertical	98	319	74.0	-13.9	Pass
5	7384.95	54.04	4.29	-7.17	51.16	Max Avg	Vertical	98	319	54.0	-2.8	Pass
6	9847.92	50.14	5.39	-5.94	49.59	Peak (NRB)	Horizontal	100	0	--	--	Pass

**Test Notes:** AP203RP SN# CNCPK2T00L on 150cm table powered by AC.

[back to matrix](#)

This test report may be reproduced in full only. The document may only be updated by MiCOM Labs personnel. All changes will be noted in the Document History section of the report.



**Title:** Hewlett Packard Enterprise APINR203, APINP203  
**To:** FCC CFR 47 Part 15 Subpart C 15.247 (DTS)  
**Serial #:** HPEN96-U5\_Rev A (1x1)  
**Issue Date:** 23<sup>rd</sup> March 2017  
**Page:** 127 of 135

### A.3.2.2. Restricted Edge & Band-Edge Emissions



#### RADIATED - LOWER RESTRICTED BAND-EDGE EMISSIONS

Variant: 802.11b, Test Freq: 2412.00 MHz, Antenna: HPE Metal Sheet, Power Setting: 78, Duty Cycle (%): 99

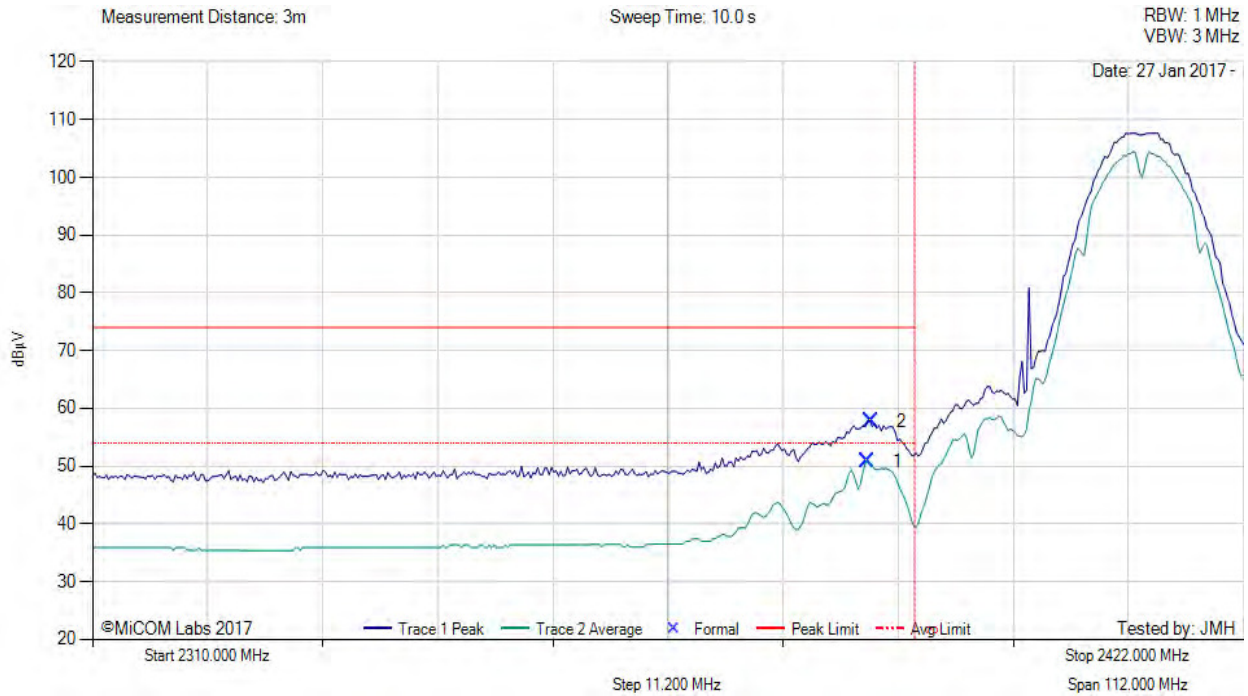

2310.00 - 2422.00 MHz												
Num	Frequency MHz	Raw dBµV	Cable Loss dB	AF dB	Level dBµV/m	Measurement Type	Pol	Hgt cm	Azt Deg	Limit dBµV/m	Margin dB	Pass /Fail
1	2385.41	16.18	2.68	32.00	50.86	Max Avg	Horizontal	190	334	54.0	-3.1	Pass
2	2385.74	23.12	2.68	32.01	57.81	Max Peak	Horizontal	190	334	74.0	-16.2	Pass
3	2390.00	--	--	--	--	Restricted-Band	--	--	--	--	--	--

**Test Notes:** EUT on 150cm table powered by AC.

[back to matrix](#)

This test report may be reproduced in full only. The document may only be updated by MiCOM Labs personnel. All changes will be noted in the Document History section of the report.



**Title:** Hewlett Packard Enterprise APINR203, APINP203  
**To:** FCC CFR 47 Part 15 Subpart C 15.247 (DTS)  
**Serial #:** HPEN96-U5\_Rev A (1x1)  
**Issue Date:** 23<sup>rd</sup> March 2017  
**Page:** 128 of 135



RADIATED - LOWER RESTRICTED BAND-EDGE EMISSIONS

Variant: 802.11g, Test Freq: 2412.00 MHz, Antenna: HPE Metal Sheet, Power Setting: 77, Duty Cycle (%): 99

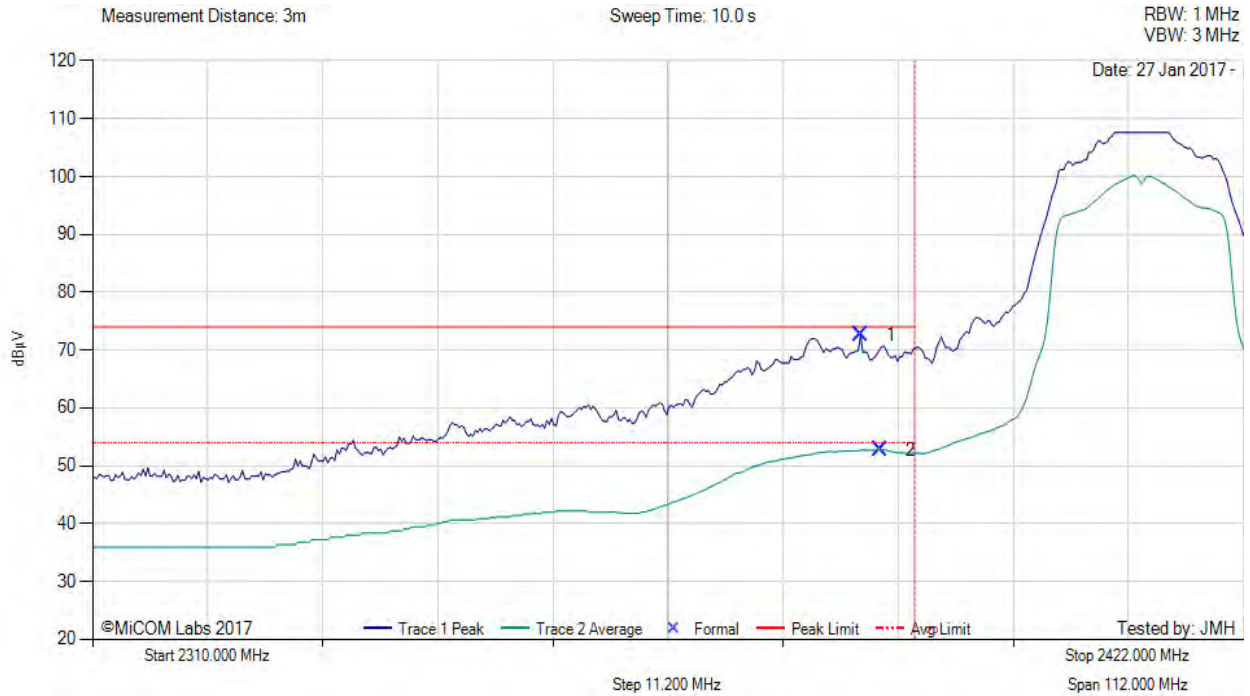

2310.00 - 2422.00 MHz												
Num	Frequency MHz	Raw dBµV	Cable Loss dB	AF dB	Level dBµV/m	Measurement Type	Pol	Hgt cm	Azt Deg	Limit dBµV/m	Margin dB	Pass /Fail
1	2384.74	37.87	2.68	32.00	72.55	Max Peak	Horizontal	190	334	74.0	-1.5	Pass
2	2386.63	18.09	2.68	32.02	52.79	Max Avg	Horizontal	190	334	54.0	-1.2	Pass
3	2390.00	--	--	--	--	Restricted-Band	--	--	--	--	--	--

**Test Notes:** EUT on 150cm table powered by AC. Power reduced to 77 to meet band edge limit.

[back to matrix](#)

This test report may be reproduced in full only. The document may only be updated by MiCOM Labs personnel. All changes will be noted in the Document History section of the report.





**Title:** Hewlett Packard Enterprise APINR203, APINP203  
**To:** FCC CFR 47 Part 15 Subpart C 15.247 (DTS)  
**Serial #:** HPEN96-U5\_Rev A (1x1)  
**Issue Date:** 23<sup>rd</sup> March 2017  
**Page:** 129 of 135



RADIATED - LOWER RESTRICTED BAND-EDGE EMISSIONS

Variant: 802.11n HT-20, Test Freq: 2412.00 MHz, Antenna: HPE Metal Sheet, Power Setting: 78, Duty Cycle (%): 99

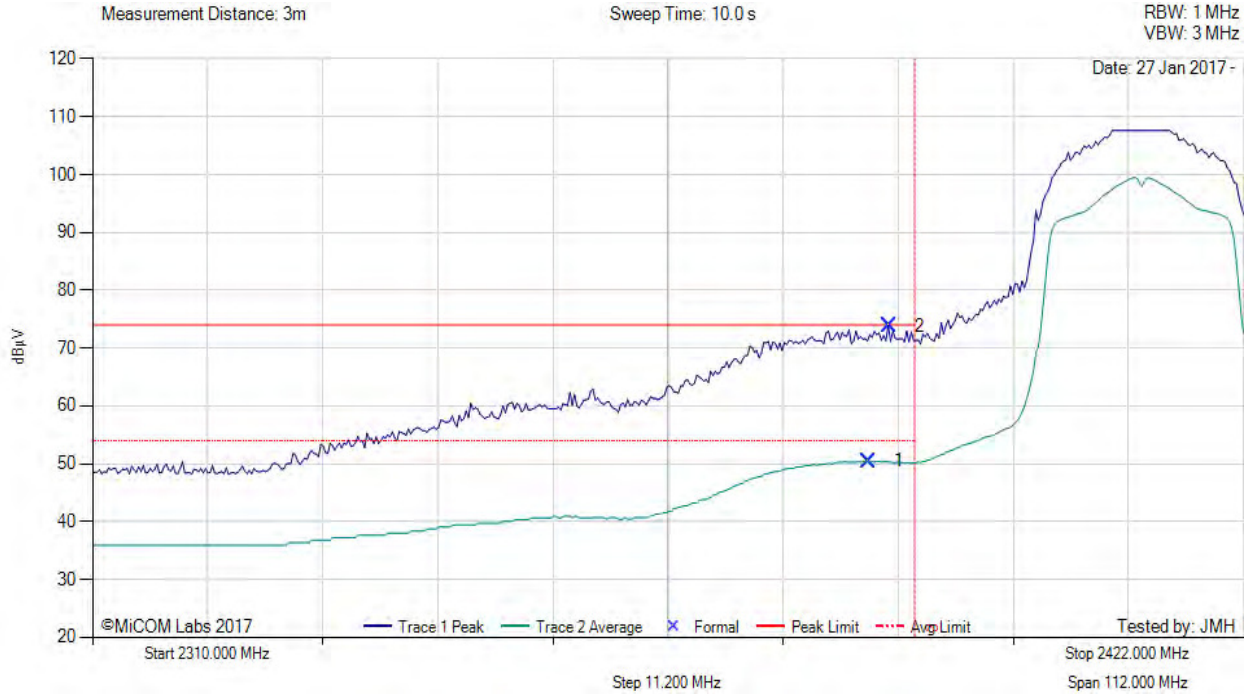

2310.00 - 2422.00 MHz												
Num	Frequency MHz	Raw dBµV	Cable Loss dB	AF dB	Level dBµV/m	Measurement Type	Pol	Hgt cm	Azt Deg	Limit dBµV/m	Margin dB	Pass /Fail
1	2385.51	15.80	2.68	32.01	50.49	Max Avg	Horizontal	190	334	54.0	-3.5	Pass
2	2387.53	39.18	2.68	32.03	73.89	Max Peak	Horizontal	190	334	74.0	-0.1	Pass
3	2390.00	--	--	--	--	Restricted-Band	--	--	--	--	--	--

**Test Notes:** EUT on 150cm table powered by AC.

[back to matrix](#)

This test report may be reproduced in full only. The document may only be updated by MiCOM Labs personnel. All changes will be noted in the Document History section of the report.



**Title:** Hewlett Packard Enterprise APINR203, APINP203  
**To:** FCC CFR 47 Part 15 Subpart C 15.247 (DTS)  
**Serial #:** HPEN96-U5\_Rev A (1x1)  
**Issue Date:** 23<sup>rd</sup> March 2017  
**Page:** 130 of 135



RADIATED - LOWER RESTRICTED BAND-EDGE EMISSIONS

Variant: 802.11n HT-40, Test Freq: 2422.00 MHz, Antenna: HPE Metal Sheet, Power Setting: 74, Duty Cycle (%): 99

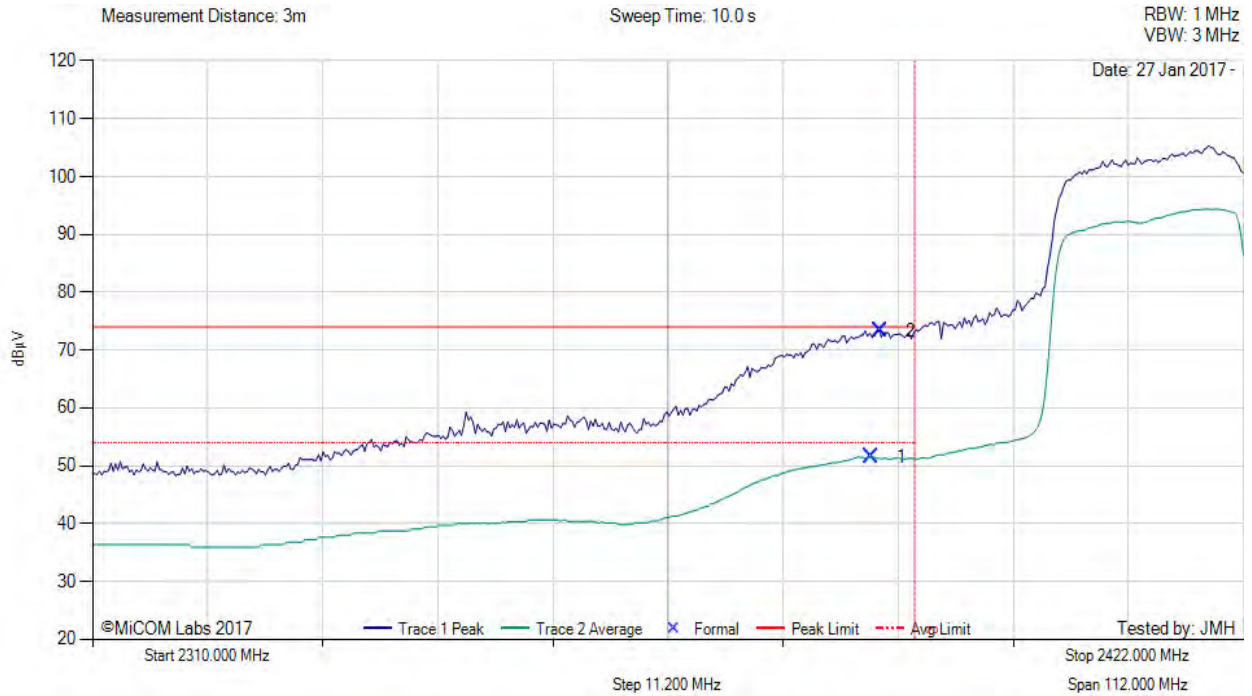

2310.00 - 2422.00 MHz												
Num	Frequency MHz	Raw dBµV	Cable Loss dB	AF dB	Level dBµV/m	Measurement Type	Pol	Hgt cm	Azt Deg	Limit dBµV/m	Margin dB	Pass /Fail
1	2385.74	16.86	2.68	32.01	51.55	Max Avg	Horizontal	190	334	54.0	-2.5	Pass
2	2386.63	38.71	2.68	32.02	73.41	Max Peak	Horizontal	190	334	74.0	-0.6	Pass
3	2390.00	--	--	--	--	Restricted-Band	--	--	--	--	--	--

**Test Notes:** EUT on 150cm table powered by AC. Power reduced to 74 to meet band edge limit

[back to matrix](#)

This test report may be reproduced in full only. The document may only be updated by MiCOM Labs personnel. All changes will be noted in the Document History section of the report.



**Title:** Hewlett Packard Enterprise APINR203, APINP203  
**To:** FCC CFR 47 Part 15 Subpart C 15.247 (DTS)  
**Serial #:** HPEN96-U5\_Rev A (1x1)  
**Issue Date:** 23<sup>rd</sup> March 2017  
**Page:** 131 of 135



**RADIATED - UPPER RESTRICTED BAND-EDGE EMISSIONS**

Variant: 802.11b, Test Freq: 2462.00 MHz, Antenna: HPE Metal Sheet, Power Setting: 78, Duty Cycle (%): 99

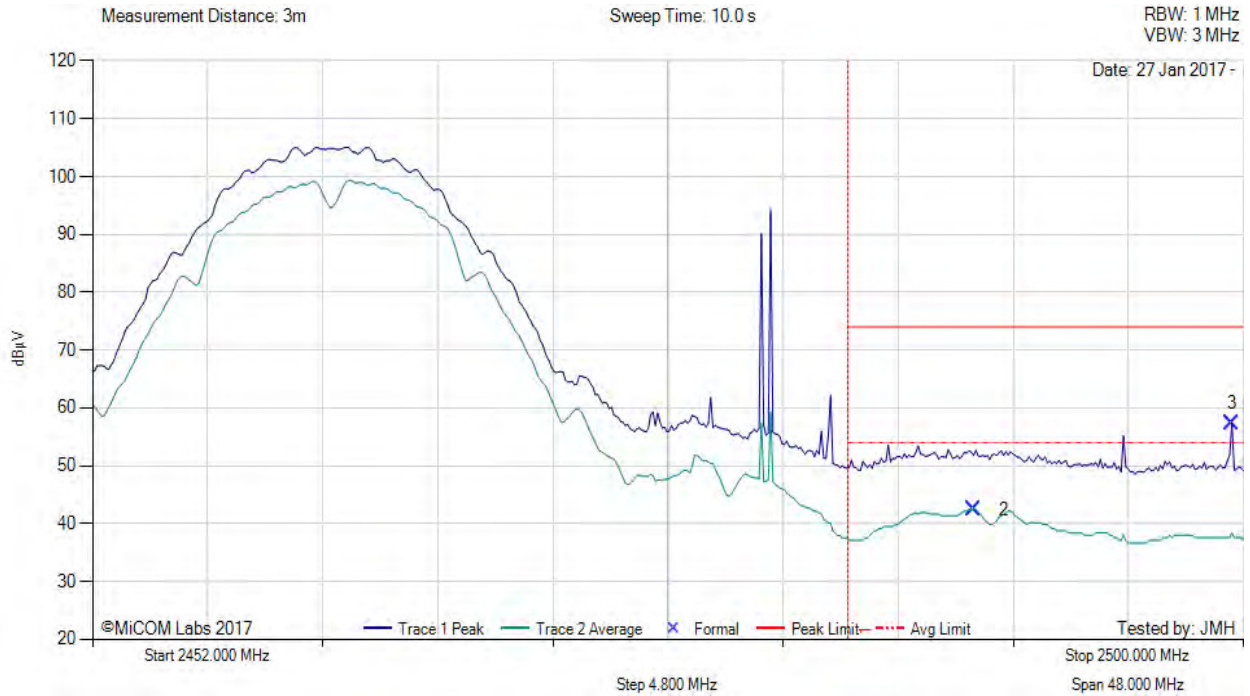

2452.00 - 2500.00 MHz												
Num	Frequency MHz	Raw dBµV	Cable Loss dB	AF dB	Level dBµV/m	Measurement Type	Pol	Hgt cm	Azt Deg	Limit dBµV/m	Margin dB	Pass /Fail
2	2488.75	7.32	2.73	32.38	42.43	Max Avg	Horizontal	190	334	54.0	-11.6	Pass
3	2499.52	22.19	2.73	32.40	57.32	Max Peak	Horizontal	190	334	74.0	-16.7	Pass
1	2483.50	--	--	--	--	Restricted-Band	--	--	--	--	--	--

**Test Notes:** EUT on 150cm table powered by AC.

[back to matrix](#)

This test report may be reproduced in full only. The document may only be updated by MiCOM Labs personnel. All changes will be noted in the Document History section of the report.



**Title:** Hewlett Packard Enterprise APINR203, APINP203  
**To:** FCC CFR 47 Part 15 Subpart C 15.247 (DTS)  
**Serial #:** HPEN96-U5\_Rev A (1x1)  
**Issue Date:** 23<sup>rd</sup> March 2017  
**Page:** 132 of 135



**RADIATED - UPPER RESTRICTED BAND-EDGE EMISSIONS**

Variant: 802.11g, Test Freq: 2462.00 MHz, Antenna: HPE Metal Sheet, Power Setting: 78, Duty Cycle (%): 99

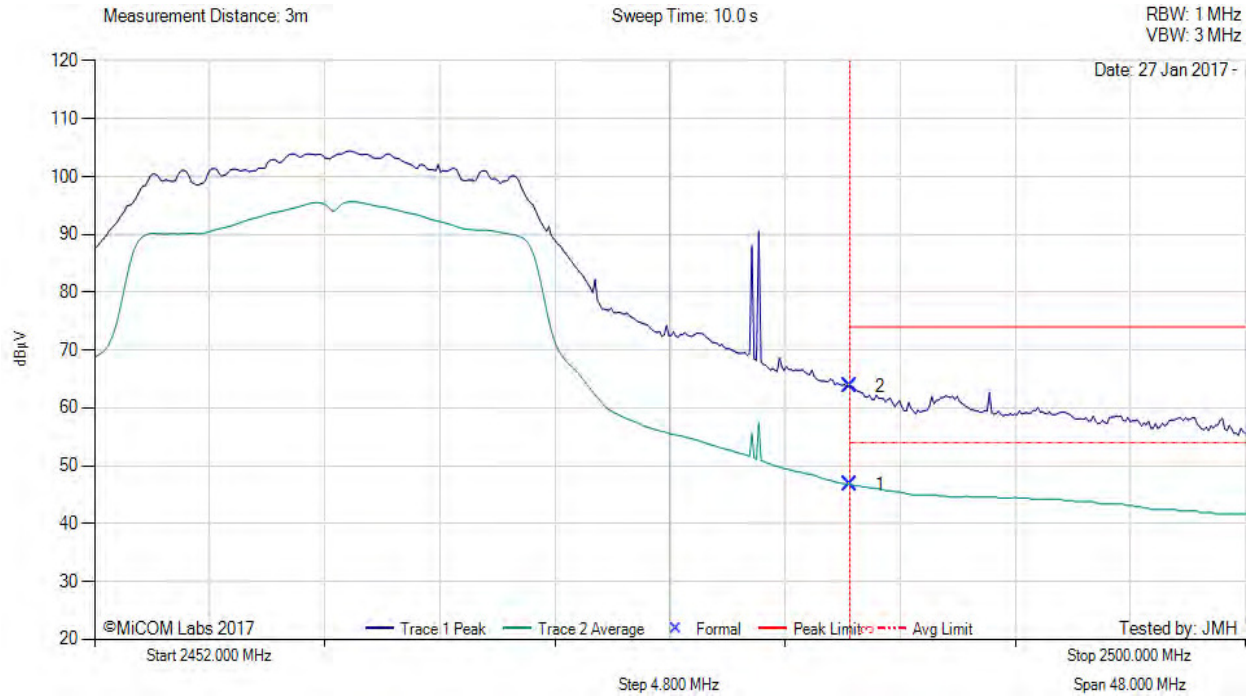

2452.00 - 2500.00 MHz												
Num	Frequency MHz	Raw dBµV	Cable Loss dB	AF dB	Level dBµV/m	Measurement Type	Pol	Hgt cm	Azt Deg	Limit dBµV/m	Margin dB	Pass /Fail
1	2483.50	11.71	2.73	32.37	46.81	Max Avg	Horizontal	190	334	54.0	-7.2	Pass
2	2483.50	28.63	2.73	32.37	63.73	Max Peak	Horizontal	190	334	74.0	-10.3	Pass
3	2483.50	--	--	--	--	Restricted-Band	--	--	--	--	--	--

**Test Notes:** EUT on 150cm table powered by AC.

[back to matrix](#)

This test report may be reproduced in full only. The document may only be updated by MiCOM Labs personnel. All changes will be noted in the Document History section of the report.



**Title:** Hewlett Packard Enterprise APINR203, APINP203  
**To:** FCC CFR 47 Part 15 Subpart C 15.247 (DTS)  
**Serial #:** HPEN96-U5\_Rev A (1x1)  
**Issue Date:** 23<sup>rd</sup> March 2017  
**Page:** 133 of 135



RADIATED - UPPER RESTRICTED BAND-EDGE EMISSIONS

Variant: 802.11n HT-20, Test Freq: 2462.00 MHz, Antenna: HPE Metal Sheet, Power Setting: 78, Duty Cycle (%): 99

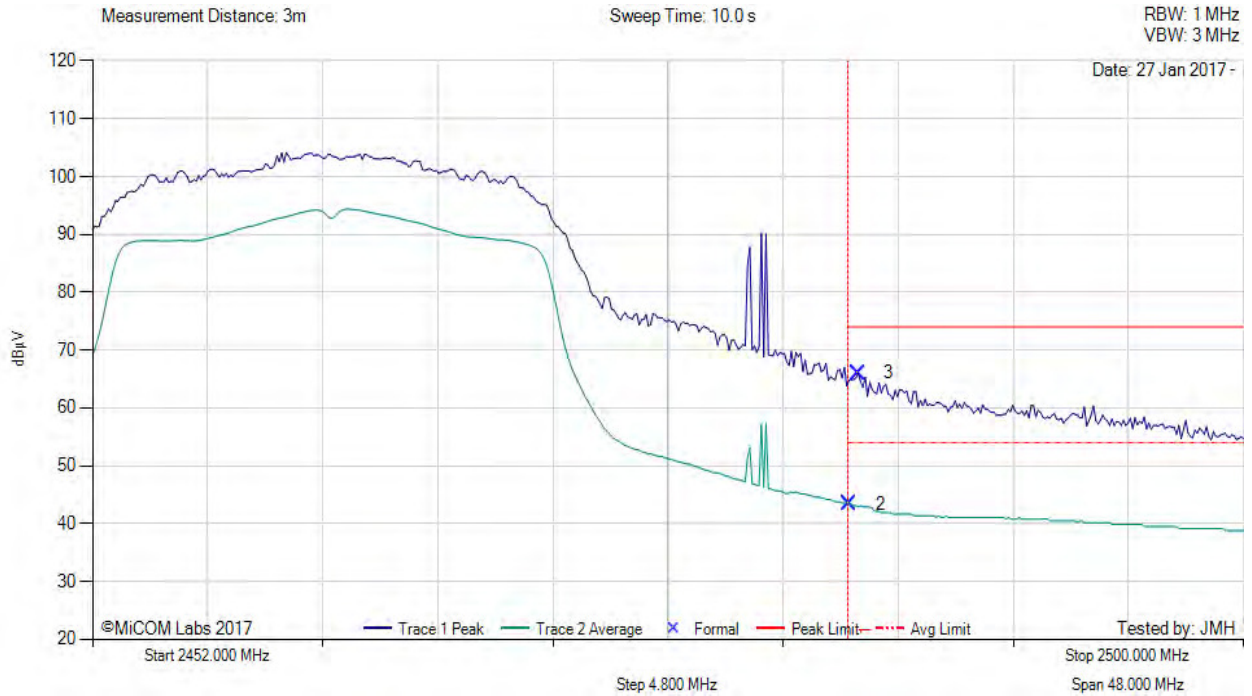

2452.00 - 2500.00 MHz												
Num	Frequency MHz	Raw dBµV	Cable Loss dB	AF dB	Level dBµV/m	Measurement Type	Pol	Hgt cm	Azt Deg	Limit dBµV/m	Margin dB	Pass /Fail
2	2483.58	8.26	2.73	32.37	43.36	Max Avg	Horizontal	190	334	54.0	-10.6	Pass
3	2483.94	30.89	2.73	32.37	65.99	Max Peak	Horizontal	190	334	74.0	-8.0	Pass
1	2483.50	--	--	--	--	Restricted-Band	--	--	--	--	--	--

**Test Notes:** EUT on 150cm table powered by AC.

[back to matrix](#)

This test report may be reproduced in full only. The document may only be updated by MiCOM Labs personnel. All changes will be noted in the Document History section of the report.



**Title:** Hewlett Packard Enterprise APINR203, APINP203  
**To:** FCC CFR 47 Part 15 Subpart C 15.247 (DTS)  
**Serial #:** HPEN96-U5\_Rev A (1x1)  
**Issue Date:** 23<sup>rd</sup> March 2017  
**Page:** 134 of 135



RADIATED - UPPER RESTRICTED BAND-EDGE EMISSIONS

Variant: 802.11n HT-40, Test Freq: 2452.00 MHz, Antenna: HPE Metal Sheet, Power Setting: 78, Duty Cycle (%): 99

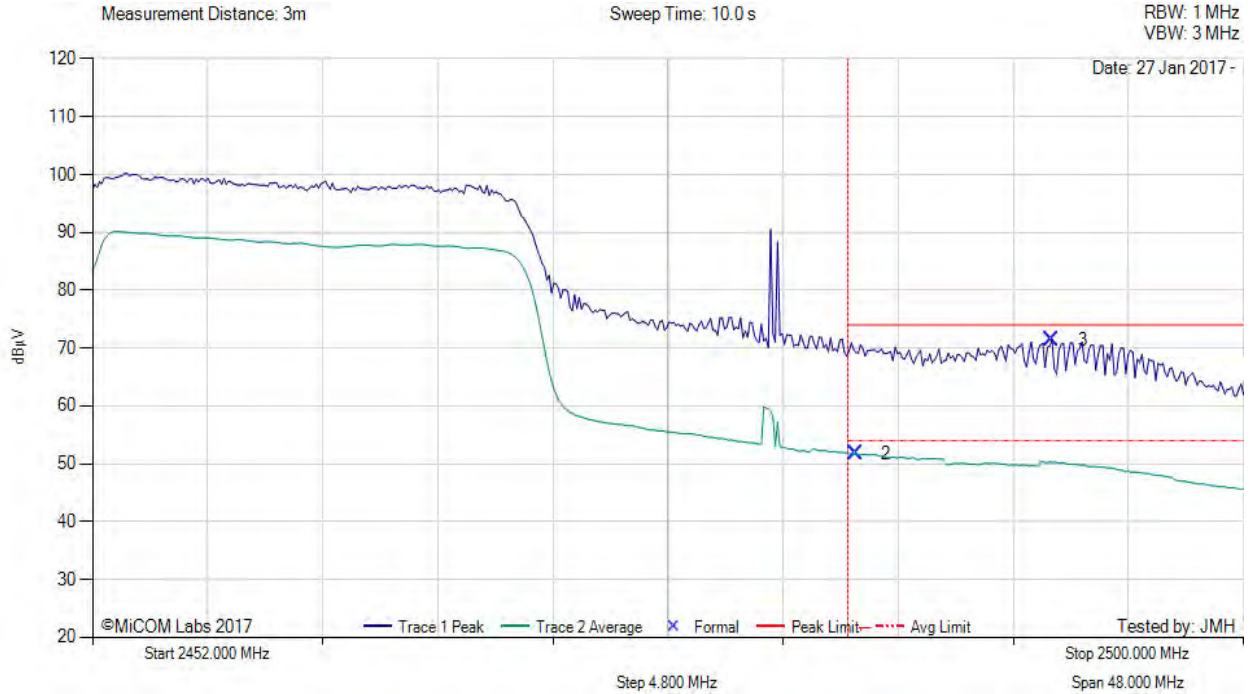

2452.00 - 2500.00 MHz												
Num	Frequency MHz	Raw dBµV	Cable Loss dB	AF dB	Level dBµV/m	Measurement Type	Pol	Hgt cm	Azt Deg	Limit dBµV/m	Margin dB	Pass /Fail
2	2483.84	16.70	2.73	32.37	51.80	Max Avg	Horizontal	190	334	54.0	-2.2	Pass
3	2492.02	36.33	2.74	32.38	71.45	Max Peak	Horizontal	190	334	74.0	-2.6	Pass
1	2483.50	--	--	--	--	Restricted-Band	--	--	--	--	--	--

**Test Notes:** EUT on 150cm table powered by AC.

[back to matrix](#)

This test report may be reproduced in full only. The document may only be updated by MiCOM Labs personnel. All changes will be noted in the Document History section of the report.

DRAFT



575 Boulder Court  
Pleasanton, California 94566, USA  
Tel: +1 (925) 462 0304  
Fax: +1 (925) 462 0306  
[www.micomlabs.com](http://www.micomlabs.com)