

Company: Hewlett Packard Enterprise

Test of: APINR203, APINP203

To: FCC Part 15.247 (DTS) & IC RSS-247

Report No.: HPEN96-U2 Rev A Bluetooth BLE

TEST REPORT





Test of: Hewlett Packard Enterprise APINR203, APINP203

To: FCC Part 15.247 (DTS) & IC RSS-247

Test Report Serial No.: HPEN96-U2 Rev A Bluetooth BLE

This report supersedes: NONE

Applicant: Hewlett Packard Enterprise
3000 Hanover St.
Palo Alto, California 94034
USA

Product Function Wireless Access Point

Issue Date: 23rd March 2017

This Test Report is Issued Under the Authority of:

MiCOM Labs, Inc.
575 Boulder Court
Pleasanton California 94566
USA
Phone: +1 (925) 462-0304
Fax: +1 (925) 462-0306
www.micomlabs.com



MiCOM Labs is an ISO 17025 Accredited Testing Laboratory



Table of Contents

1. ACCREDITATION, LISTINGS & RECOGNITION	4
1.1. TESTING ACCREDITATION.....	4
1.2. RECOGNITION	5
1.3. PRODUCT CERTIFICATION	6
2. DOCUMENT HISTORY	7
3. TEST RESULT CERTIFICATE	8
4. REFERENCES AND MEASUREMENT UNCERTAINTY	9
4.1. Normative References	9
4.2. Test and Uncertainty Procedure	10
5. PRODUCT DETAILS AND TEST CONFIGURATIONS	11
5.1. Technical Details	11
5.2. Scope of Test Program.....	12
5.3. Equipment Model(s) and Serial Number(s).....	13
5.4. Antenna Details	13
5.5. Cabling and I/O Ports	13
5.6. Test Configurations.....	14
5.7. Equipment Modifications	14
5.8. Deviations from the Test Standard	14
6. TEST SUMMARY	15
7. TEST EQUIPMENT CONFIGURATION(S)	16
7.1. Conducted RF Emissions Test Set-up(s).....	16
7.2. Radiated Spurious Emissions Test Set-up(s).....	18
8. MEASUREMENT AND PRESENTATION OF TEST DATA	21
9. TEST RESULTS	22
9.1. 6 dB & 99% Bandwidth	22
9.2. Conducted Output Power	24
9.3. Power Spectral Density	27
9.4. Conducted Spurious Emissions.....	29
9.4.1. <i>Conducted Emissions</i>	29
9.4.1.1. Conducted Spurious Emissions	29
9.4.1.2. Conducted Band-Edge Emissions	31
9.5. Radiated Emissions.....	33
9.5.1. <i>TX Spurious & Restricted Band Emissions</i>	33
9.5.2. <i>Restricted Band Spurious Emissions</i>	36
9.5.3. <i>Restricted Edge & Band-Edge Emissions</i>	39
9.5.4. <i>TX Spurious & Restricted Band Emissions (0.03 - 1 GHz)</i>	43
A. APPENDIX - GRAPHICAL IMAGES	46
A.1. 6 dB & 99% Bandwidth	47
A.2. Power Spectral Density	50
A.3. Conducted Emissions.....	53
A.3.1. <i>Conducted Spurious Emissions</i>	53
A.3.2. <i>Conducted Band-Edge Emissions</i>	56
A.4. Radiated Emissions.....	58
A.4.1. <i>Radiated TX Spurious & Restricted Band Emissions</i>	58
A.4.2. <i>Restricted Edge & Band-Edge Emissions</i>	62

This test report may be reproduced in full only. The document may only be updated by MiCOM Labs personnel. All changes will be noted in the Document History section of the report.



Title: Hewlett Packard Enterprise APINR203, APINP203
To: FCC Part 15.247 (DTS) & IC RSS-247
Serial #: HPEN96-U2 Rev A Bluetooth BLE
Issue Date: 23rd March 2017
Page: 4 of 64

1. ACCREDITATION, LISTINGS & RECOGNITION

1.1. TESTING ACCREDITATION

MiCOM Labs, Inc. is an accredited Electrical testing laboratory per the international standard ISO/IEC 17025:2005. The company is accredited by the American Association for Laboratory Accreditation (A2LA) www.a2la.org test laboratory number 2381.01. MiCOM Labs test schedule is available at the following URL; <http://www.a2la.org/scopepdf/2381-01.pdf>



Accredited Laboratory

A2LA has accredited

MICOM LABS

Pleasanton, CA

for technical competence in the field of

Electrical Testing

This laboratory is accredited in accordance with the recognized International Standard ISO/IEC 17025:2005 General requirements for the competence of testing and calibration laboratories. This accreditation demonstrates technical competence for a defined scope and the operation of a laboratory quality management system (refer to joint ISO-ILAC-IAF Communiqué dated 8 January 2009).



Presented this 4th day of February 2016.

Senior Director of Quality & Communications
For the Accreditation Council
Certificate Number 2381.01
Valid to November 30, 2017

For the tests or types of tests to which this accreditation applies, please refer to the laboratory's Electrical Scope of Accreditation.

This test report may be reproduced in full only. The document may only be updated by MiCOM Labs personnel. All changes will be noted in the Document History section of the report.



1.2. RECOGNITION

MiCOM Labs, Inc has widely recognized wireless testing capabilities. Our international recognition includes Conformity Assessment Body designation by APEC MRA countries. MiCOM Labs test reports are accepted globally.

Country	Recognition Body	Status	Phase	Identification No.
USA	Federal Communications Commission (FCC)	TCB	-	US0159 Listing #: 102167
Canada	Industry Canada (IC)	FCB	APEC MRA 2	US0159 Listing #: 4143A-2 4143A-3
Japan	MIC (Ministry of Internal Affairs and Communication)	CAB	APEC MRA 2	RCB 210
	VCCI	--	--	A-0012
Europe	European Commission	NB	EU MRA	NB 2280
Australia	Australian Communications and Media Authority (ACMA)	CAB	APEC MRA 1	US0159
Hong Kong	Office of the Telecommunication Authority (OFTA)	CAB	APEC MRA 1	
Korea	Ministry of Information and Communication Radio Research Laboratory (RRL)	CAB	APEC MRA 1	
Singapore	Infocomm Development Authority (IDA)	CAB	APEC MRA 1	
Taiwan	National Communications Commission (NCC) Bureau of Standards, Metrology and Inspection (BSMI)	CAB	APEC MRA 1	
Vietnam	Ministry of Communication (MIC)	CAB	APEC MRA 1	

EU MRA – European Union Mutual Recognition Agreement.

NB – Notified Body

APEC MRA – Asia Pacific Economic Community Mutual Recognition Agreement. Recognition agreement under which test lab is accredited to regulatory standards of the APEC member countries.

Phase I - recognition for product testing

Phase II – recognition for both product testing and certification



Title: Hewlett Packard Enterprise APINR203, APINP203
To: FCC Part 15.247 (DTS) & IC RSS-247
Serial #: HPEN96-U2 Rev A Bluetooth BLE
Issue Date: 23rd March 2017
Page: 6 of 64

1.3. PRODUCT CERTIFICATION

MiCOM Labs, Inc. is an accredited Product Certification Body per the international standard ISO/IEC 17065:2012. The company is accredited by the American Association for Laboratory Accreditation (A2LA) www.a2la.org test laboratory number 2381.02. MiCOM Labs test schedule is available at the following URL; <http://www.a2la.org/scopepdf/2381-02.pdf>



Accredited Product Certification Body

A2LA has accredited
MICOM LABS
Pleasanton, CA

This product certification body is accredited in accordance with the recognized International Standard ISO/IEC 17065:2012 *Requirements for bodies certifying products, processes and services*. This accreditation demonstrates technical competence for a defined scope and the operation of a management system.



Presented this 4th day of February 2016.



Senior Director of Quality & Communications
For the Accreditation Council
Certificate Number 2381.02
Valid to November 30, 2017

For the product certification schemes to which this accreditation applies, please refer to the organization's Product Certification Scope of Accreditation.

United States of America – Telecommunication Certification Body (TCB)
Industry Canada – Certification Body, CAB Identifier – US0159
Europe – Notified Body (NB), NB Identifier - 2280
Japan – Recognized Certification Body (RCB), RCB Identifier - 210

This test report may be reproduced in full only. The document may only be updated by MiCOM Labs personnel. All changes will be noted in the Document History section of the report.



Title: Hewlett Packard Enterprise APINR203, APINP203
To: FCC Part 15.247 (DTS) & IC RSS-247
Serial #: HPEN96-U2 Rev A Bluetooth BLE
Issue Date: 23rd March 2017
Page: 7 of 64

2. DOCUMENT HISTORY

Document History		
Revision	Date	Comments
Draft	3 rd March 2017	
Rev A	23 rd March 2017	Initial release

In the above table the latest report revision will replace all earlier versions.

This test report may be reproduced in full only. The document may only be updated by MiCOM Labs personnel. All changes will be noted in the Document History section of the report.



Title: Hewlett Packard Enterprise APINR203, APINP203
To: FCC Part 15.247 (DTS) & IC RSS-247
Serial #: HPEN96-U2 Rev A Bluetooth BLE
Issue Date: 23rd March 2017
Page: 8 of 64

3. TEST RESULT CERTIFICATE

Manufacturer: Hewlett Packard Enterprise 3000 Hanover St. Palo Alto California 94034 USA	Tested By: MiCOM Labs, Inc. 575 Boulder Court Pleasanton California 94566 USA
Model: APINR203, APINP203	Telephone: +1 925 462 0304
Type Of Equipment: Wireless Access point with Bluetooth BLE	Fax: +1 925 462 0306
S/N's: CNCQK2T0RH, CNCQK2T07K	
Test Date(s): 24 - 27 February 2017	Website: www.micomlabs.com

STANDARD(S)	TEST RESULTS
FCC CFR 47 Part 15 Subpart C 15.247 (DTS) & Industry Canada RSS-247	EQUIPMENT COMPLIES

MiCOM Labs, Inc. tested the equipment mentioned in accordance with the requirements set forth in the above standards. Test results indicate that the equipment tested is capable of demonstrating compliance with the requirements as documented within this report.

Notes:

1. This document reports conditions under which testing was conducted and the results of testing performed.
2. Details of test methods used have been recorded and kept on file by the laboratory.
3. Test results apply only to the item(s) tested.

Approved & Released for MiCOM Labs, Inc. by:

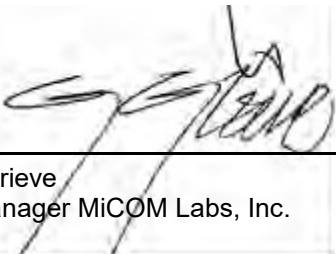

 Graeme Grieve
 Quality Manager MiCOM Labs, Inc.

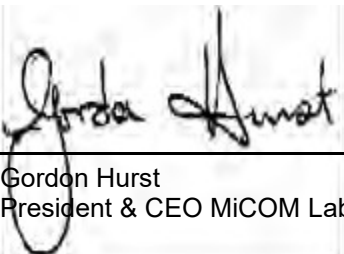
 Gordon Hurst
 President & CEO MiCOM Labs, Inc.

This test report may be reproduced in full only. The document may only be updated by MiCOM Labs personnel. All changes will be noted in the Document History section of the report.

4. REFERENCES AND MEASUREMENT UNCERTAINTY

4.1. Normative References

REF.	PUBLICATION	YEAR	TITLE
I	KDB 662911 D01 & D02	Oct 31 2013	Guidance for measurement of output emission of devices that employ single transmitter with multiple outputs or systems with multiple transmitters operating simultaneously in the same frequency band
II	KDB 558074 D01 v03r05	8th April 2016	Guidance for performing compliance measurements on Digital Transmission Systems (DTS) operating under section 15.247.
III	A2LA	June 2015	R105 - Requirement's When Making Reference to A2LA Accreditation Status
IV	ANSI C63.10	2013	American National Standard for Testing Unlicensed Wireless Devices
V	ANSI C63.4	2014	American National Standards for Methods of Measurement of Radio-Noise Emissions from Low-Voltage Electrical and Electronic Equipment in the Range of 9 kHz to 40 GHz
VI	CISPR 22	2008	Information technology equipment - Radio disturbance characteristics - Limits and methods of measurement
VII	ETSI TR 100 028	2001-12	Parts 1 and 2 Electromagnetic compatibility and Radio Spectrum Matters (ERM); Uncertainties in the measurement of mobile radio equipment characteristics
VIII	FCC 47 CFR Part 15.247	2016	Radio Frequency Devices; Subpart C – Intentional Radiators
IX	ICES-003	Issue 6 Jan 2016	Spectrum Management and Telecommunications; Interference-Causing Equipment Standard. Information Technology Equipment (Including Digital Apparatus) – Limits and methods of measurement.
X	M 3003	Edition 3 Nov.2012	Expression of Uncertainty and Confidence in Measurements
XI	RSS-247 Issue 2	2 Feb 2017	Digital Transmission Systems (DTSs), Frequency Hopping System (FHSs) and Licence-Exempt Local Area Network (LE-LEN) Devices
XII	RSS-Gen Issue 4	November 2014	General Requirements and Information for the Certification of Radiocommunication Equipment
XIII	KDB 644545 D03 v01	August 14th 2014	Guidance for IEEE 802.11ac New Rules
XIV	FCC 47 CFR Part 2.1033	2016	FCC requirements and rules regarding photographs and test setup diagrams.

This test report may be reproduced in full only. The document may only be updated by MiCOM Labs personnel. All changes will be noted in the Document History section of the report.



Title: Hewlett Packard Enterprise APINR203, APINP203
To: FCC Part 15.247 (DTS) & IC RSS-247
Serial #: HPEN96-U2 Rev A Bluetooth BLE
Issue Date: 23rd March 2017
Page: 10 of 64

4.2. Test and Uncertainty Procedure

Conducted and radiated emission measurements were conducted in accordance with American National Standards Institute ANSI C63.4, listed in the Normative References section of this report.

Measurement uncertainty figures are calculated in accordance with ETSI TR 100 028 Parts 1 and 2.

Measurement uncertainties stated are based on a standard uncertainty multiplied by a coverage factor $k = 2$, providing a level of confidence of approximately 95 % in accordance with UKAS document M 3003 listed in the Normative References section of this report.

This test report may be reproduced in full only. The document may only be updated by MiCOM Labs personnel. All changes will be noted in the Document History section of the report.



Title: Hewlett Packard Enterprise APINR203, APINP203
To: FCC Part 15.247 (DTS) & IC RSS-247
Serial #: HPEN96-U2 Rev A Bluetooth BLE
Issue Date: 23rd March 2017
Page: 11 of 64

5. PRODUCT DETAILS AND TEST CONFIGURATIONS

5.1. Technical Details

Details	Description
Purpose:	Test of the Hewlett Packard Enterprise APINR203, APINP203 Bluetooth radio to FCC CFR 47 Part 15 Subpart C 15.247 (DTS) and Industry Canada RSS-247.
Applicant:	Hewlett Packard Enterprise 3000 Hanover St. Palo Alto California 94034 USA
Manufacturer:	Hewlett Packard Enterprise
Laboratory performing the tests:	MiCOM Labs, Inc. 575 Boulder Court Pleasanton California 94566 USA
Test report reference number:	HPEN96 – U2 Draft
Date EUT received:	23 rd February, 2017
Standard(s) applied:	FCC CFR 47 Part 15 Subpart C 15.247 (DTS) and Industry Canada RSS-247.
Dates of test (from - to):	24 - 27 February 2017
No of Units Tested:	2
Product Family Name:	802.11 Wireless Access point with Bluetooth BLE
Model(s):	APINR203 / APINP203
Location for use:	Indoor
Declared Frequency Range(s):	2400 - 2483.5 MHz
Type of Modulation:	GFSK
EUT Modes of Operation:	Bluetooth BLE
Declared Nominal Output Power:	3 dBm
Transmit/Receive Operation:	Transceiver – Half Duplex
Rated Input Voltage and Current:	AC 100-240V, APINR203: 0.3A, APINP203: 0.6A
Operating Temperature Range:	Nominal: 20 °C Max: 40 °C Min: 0 °C
ITU Emission Designator:	1M1G1D
Equipment Dimensions:	155mm x 50mm x 95mm
Weight:	0.320 kg (AP-203R) & 0.340 kg (AP-203RP)
Hardware Rev:	1
Software Rev:	Smart RF Studio 7.2.2.1 (Rev. 0025)

This test report may be reproduced in full only. The document may only be updated by MiCOM Labs personnel. All changes will be noted in the Document History section of the report.

5.2. Scope of Test Program

Hewlett Packard Enterprise APINR203, APINP203

The scope of the test program was to test the Hewlett Packard Enterprise APINR203, APINP203, 802.11 wireless access point with Bluetooth radio in the frequency ranges 2400 - 2483.5 MHz; for compliance against the following Bluetooth BLE specifications:

FCC CFR 47 Part 15 Subpart C 15.247 (DTS)

Radio Frequency Devices; Subpart C – Intentional Radiators

Industry Canada RSS-247

Digital Transmission Systems (DTSs), Frequency Hopping System (FHSs) and Licence-Exempt Local Area Network (LE-LEN) Devices

Hewlett Packard Enterprise APINR203 / APINP203 EUT



This test report may be reproduced in full only. The document may only be updated by MiCOM Labs personnel. All changes will be noted in the Document History section of the report.



Title: Hewlett Packard Enterprise APINR203, APINP203
To: FCC Part 15.247 (DTS) & IC RSS-247
Serial #: HPEN96-U2 Rev A Bluetooth BLE
Issue Date: 23rd March 2017
Page: 13 of 64

5.3. Equipment Model(s) and Serial Number(s)

Type	Description	Manufacturer	Model	Serial no.	Delivery Date
EUT	WLAN Access Point 802.11 & Bluetooth	Hewlett Packard Enterprise	APINP203	CNCQK2T0RH	23 rd February, 2017
EUT	WLAN Access Point 802.11 & Bluetooth	Hewlett Packard Enterprise	APINP203	CNCQK2T07K	23 rd February, 2017

5.4. Antenna Details

Type	Manufacturer	Model	Family	Gain (dBi)	BF Gain	Dir BW	X-Pol	Frequency Band (MHz)
integral	HPE	Metal Sheet	5	1.0	-	360	-	2400 - 2483.5

BF Gain - Beamforming Gain
Dir BW - Directional BeamWidth
X-Pol - Cross Polarization

5.5. Cabling and I/O Ports

Port Type	Max Cable Length	# Of Ports	Screened	Conn Type	Data Type
Ethernet	100	3	N	RJ45	Packet Data
AC Input	N/A	1	N	AC Wire	--
USB	Configuration	1	No	Micro USB	Data
USB	Mgmt only	1	No	USB	Data

This test report may be reproduced in full only. The document may only be updated by MiCOM Labs personnel. All changes will be noted in the Document History section of the report.



Title: Hewlett Packard Enterprise APINR203, APINP203
To: FCC Part 15.247 (DTS) & IC RSS-247
Serial #: HPEN96-U2 Rev A Bluetooth BLE
Issue Date: 23rd March 2017
Page: 14 of 64

5.6. Test Configurations

Results for the following configurations are provided in this report:

Operational Mode(s) (802.11a/b/g/n/ac)	Data Rate with Highest Power MBit/s	Channel Frequency (MHz)		
		Low	Mid	High
2400 - 2483.5 MHz				
BLE	1	2,402.00	2,440.00	2,480.00

5.7. Equipment Modifications

The following modifications were required to bring the equipment into compliance:

1. NONE

5.8. Deviations from the Test Standard

The following deviations from the test standard were required in order to complete the test program:

1. NONE

This test report may be reproduced in full only. The document may only be updated by MiCOM Labs personnel. All changes will be noted in the Document History section of the report.



Title: Hewlett Packard Enterprise APINR203, APINP203
To: FCC Part 15.247 (DTS) & IC RSS-247
Serial #: HPEN96-U2 Rev A Bluetooth BLE
Issue Date: 23rd March 2017
Page: 15 of 64

6. TEST SUMMARY

List of Measurements

Test Header	Result	Data Link
Conducted Testing		
6 dB & 99% Bandwidth	Complies	View Data
Conducted Output Power	Complies	View Data
Power Spectral Density	Complies	View Data
Conducted Emissions	Complies	-
(i) Conducted Spurious Emissions	Complies	View Data
(ii) Conducted Band-Edge Emissions	Complies	View Data
Radiated Testing		
Radiated Emissions	Complies	-
(i) TX Spurious & Restricted Band Emissions	Complies	View Data
(ii) Restricted Edge & Band-Edge Emissions	Complies	View Data
(iii) TX Spurious & Restricted Band Emissions (0.03 - 1 GHz)	Complies	View Data
Digital Emissions		
(i) Digital Emissions (0.03 - 1 GHz)	Complies	View Data
AC Wireline Emissions	Reference report HPEN96-G4 Part 15 Subpart B & ICES-003	
(3) AC Wireline Emissions	Complies	-

This test report may be reproduced in full only. The document may only be updated by MiCOM Labs personnel. All changes will be noted in the Document History section of the report.

7. TEST EQUIPMENT CONFIGURATION(S)

7.1. Conducted RF Emissions Test Set-up(s)

Conducted RF Emission Test Set-up(s).

The following tests were performed using the conducted test set-up shown in the diagram below.

1. 6 dB & 99% Bandwidth
2. Conducted Output Power
3. Power Spectral Density
4. Conducted Emissions (including Band-Edge)

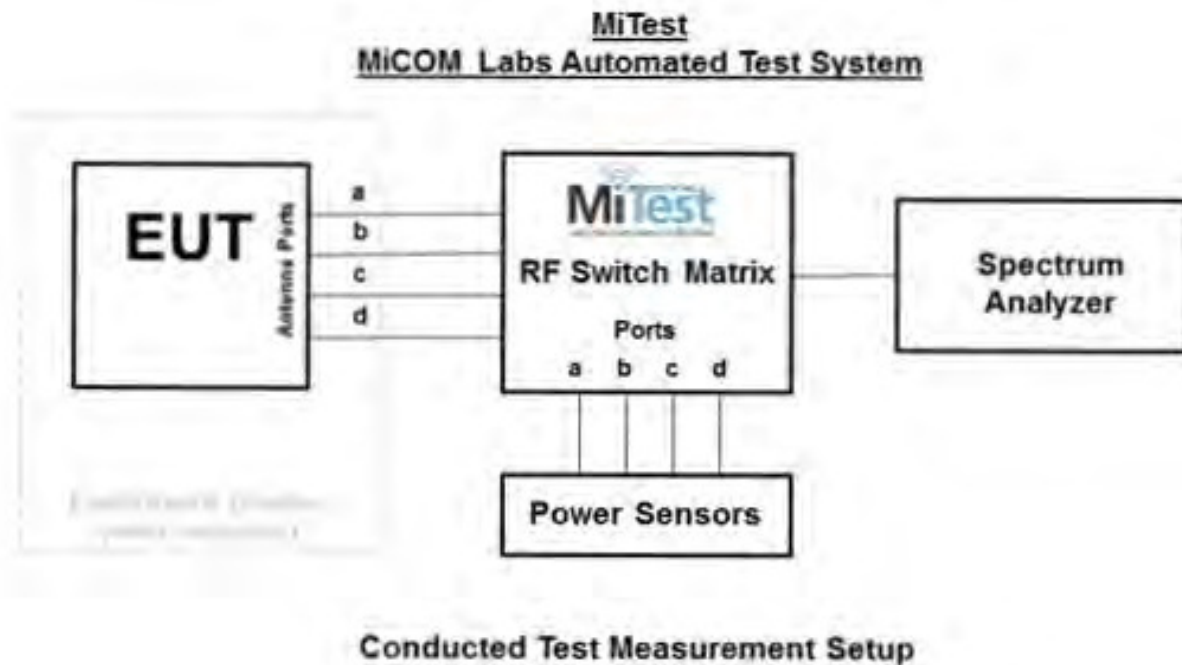

A full system calibration was performed on the test station and any resulting system losses (or gains) were taken into account in the production of all final measurement data.



Title: Hewlett Packard Enterprise APINR203, APINP203
To: FCC Part 15.247 (DTS) & IC RSS-247
Serial #: HPEN96-U2 Rev A Bluetooth BLE
Issue Date: 23rd March 2017
Page: 17 of 64

Asset#	Description	Manufacturer	Model#	Serial#	Calibration Due Date
127	Power Supply	HP	6674A	US36370530	Cal when used
158	Barometer/Thermometer	Control Company	4196	E2846	30 Nov 2017
248	Resistance Thermometer	Thermotronics	GR2105-02	9340 #1	21 Oct 2017
376	USB 10MHz - 18GHz Average Power Sensor	Agilent	U2000A	MY51440005	23 Oct 2017
378	Rohde & Schwarz 40 GHz Receiver with Generator	Rhode & Schwarz	ESIB40	100107/040	4 Aug 2017
381	4x4 RF Switch Box	MiCOM Labs	MiTest RF Switch Box	MIC002	2 Jun 2017
398	Test Software	MiCOM	MiTest ATS	Version 4.1.0.76	Not Required
419	Laptop with Labview Software	Lenova	W520	TS02	Not Required
420	USB to GPIB Interface	National Instruments	GPIB-USB HS	1346738	Not Required
440	USB Wideband Power Sensor	Boonton	55006	9178	25 Sep 2017
442	USB Wideband Power Sensor	Boonton	55006	9181	6 Oct 2017
460	Dell Computer with installation of MiTest executable.	Dell	Optiplex330	BC944G1	Not Required
493	USB Wideband Power Sensor	Boonton	55006	9634	10 Mar 2017
494	USB Wideband Power Sensor	Boonton	55006	9726	10 Mar 2017
74	Environmental Chamber Chamber 3	Tenney	TTC	12808-1	29 Sep 2017
RF#2 GPIB#1	GPIB cable to Power Supply	HP	GPIB	None	Not Required
RF#2 SMA#1	EUT to Mitest box port 1	Flexco	SMA Cable port1	None	2 Jun 2017
RF#2 SMA#2	EUT to Mitest box port 2	Flexco	SMA Cable port2	None	2 Jun 2017
RF#2 SMA#3	EUT to Mitest box port 3	Flexco	SMA Cable port3	None	2 Jun 2017
RF#2 SMA#4	EUT to Mitest box port 4	Flexco	SMA Cable port4	None	2 Jun 2017
RF#2 SMA#SA	Mitest box to SA	Flexco	SMA Cable SA	None	2 Jun 2017
RF#2 USB#1	USB Cable to Mitest Box	Dynex	USB Cable	None	Not Required

This test report may be reproduced in full only. The document may only be updated by MiCOM Labs personnel. All changes will be noted in the Document History section of the report.

7.2. Radiated Spurious Emissions Test Set-up(s)

The following tests were performed using the radiated test set-up shown in the diagram below.

Radiated Spurious and Band-edge Emissions

Radiated Emission Measurement Setup

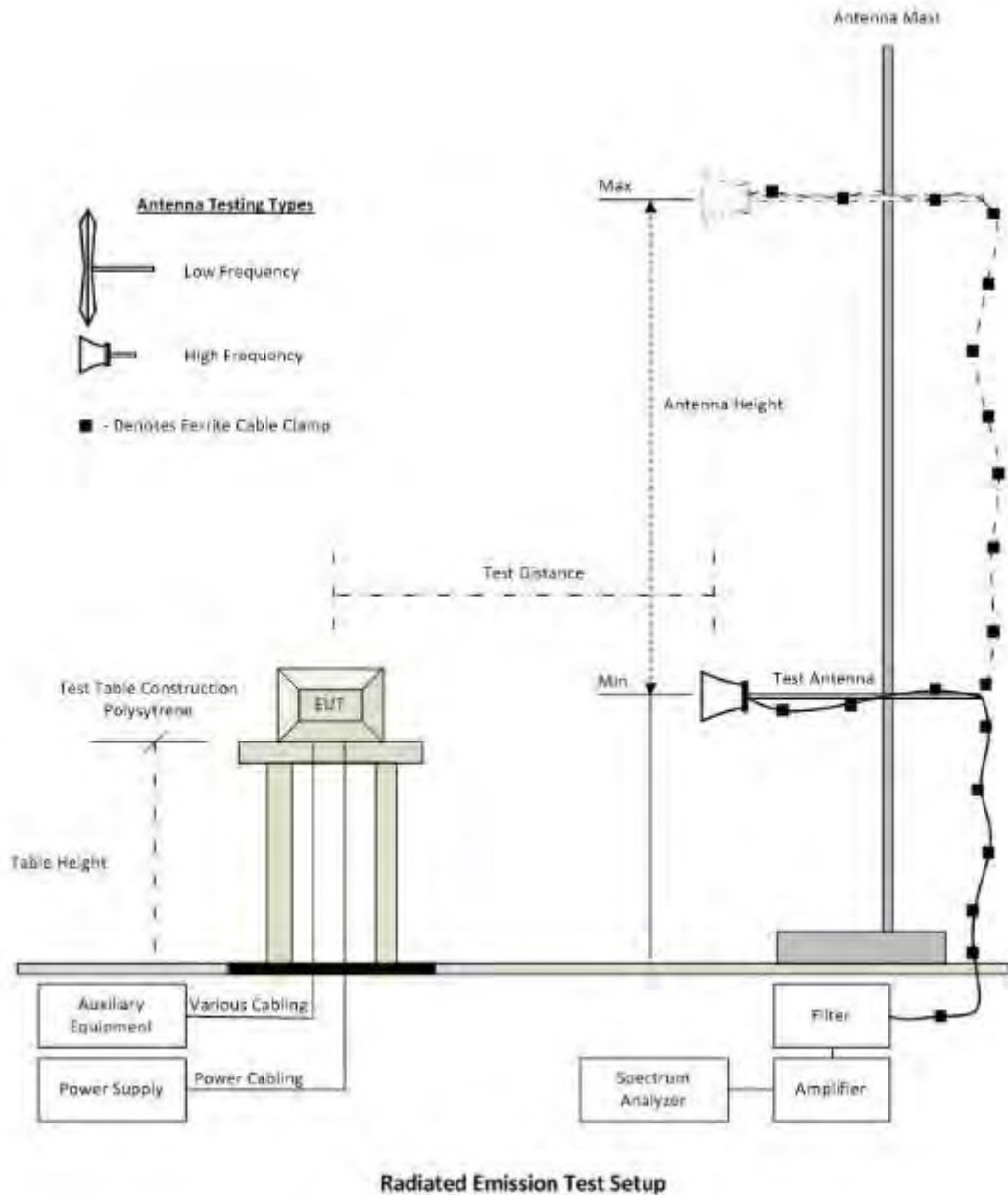

This test report may be reproduced in full only. The document may only be updated by MiCOM Labs personnel. All changes will be noted in the Document History section of the report.



Title: Hewlett Packard Enterprise APINR203, APINP203
To: FCC Part 15.247 (DTS) & IC RSS-247
Serial #: HPEN96-U2 Rev A Bluetooth BLE
Issue Date: 23rd March 2017
Page: 19 of 64

Asset#	Description	Manufacturer	Model#	Serial#	Calibration Due Date
158	Barometer/Thermometer	Control Company	4196	E2846	30 Nov 2017
170	Video System Controller for Semi Anechoic Chamber	Panasonic	WV-CU101	04R08507	Not Required
330	Variac 0-280 Vac	Staco Energy Co	3PN1020B	0546	Cal when used
336	Active loop Ant 10kHz to 30 MHz	EMCO	EMCO 6502	00060498	26 Sep 2017
338	Sunol 30 to 3000 MHz Antenna	Sunol	JB3	A052907	15 Aug 2017
373	26III RMS Multimeter	Fluke	Fluke 26 series III	76080720	26 Oct 2017
378	Rohde & Schwarz 40 GHz Receiver with Generator	Rhode & Schwarz	ESIB40	100107/040	4 Aug 2017
393	DC - 1050 MHz Low Pass Filter	Microcircuits	VLFX-1050	N/A	16 Aug 2017
396	2.4 GHz Notch Filter	Microtronics	BRM50701	001	16 Aug 2017
397	Amp 10 - 2500MHz	MiCOM Labs	Amp 10 - 2500 MHz	NA	9 Jun 2017
399	ETS 1-18 GHz Horn Antenna	ETS	3117	00154575	10 Apr 2017
406	Amplifier for Radiated Emissions	MiCOM Labs	40dB 1 to 18GHz Amp	0406	9 Jun 2017
410	Desktop Computer	Dell	Inspiron 620	WS38	Not Required
411	Mast/Turntable Controller	Sunol Sciences	SC98V	060199-1D	Not Required
412	USB to GPIB Interface	National Instruments	GPIB-USB HS	11B8DC2	Not Required
413	Mast Controller	Sunol Science	TWR95-4	030801-3	Not Required
415	Turntable Controller	Sunol Sciences	Turntable Controller	None	Not Required
416	Gigabit ethernet filter	ETS-Lingren	Gigafoil 260366	None	Not Required
447	Rad Emissions Test Software	MiCOM	Rad Emissions Test Software Version 1.0.109	447	Not Required
462	Schwarzbeck cable from Antenna to Amplifier.	Schwarzbeck	AK 9513	462	31 May 2017
463	Schwarzbeck cable from Amplifier to Bulkhead.	Schwarzbeck	AK 9513	463	31 May 2017

This test report may be reproduced in full only. The document may only be updated by MiCOM Labs personnel. All changes will be noted in the Document History section of the report.



Title: Hewlett Packard Enterprise APINR203, APINP203
To: FCC Part 15.247 (DTS) & IC RSS-247
Serial #: HPEN96-U2 Rev A Bluetooth BLE
Issue Date: 23rd March 2017
Page: 20 of 64

464	Schwarzbeck cable from Bulkhead to Receiver	Schwarzbeck	AK 9513	464	31 May 2017
465	Low Pass Filter DC-1000 MHz	Mini-Circuits	NLP-1200+	VUU01901402	2 Jun 2017
480	Cable - Bulkhead to Amp	SRC Haverhill	157-157-3050360	480	2 Jun 2017
481	Cable - Bulkhead to Receiver	SRC Haverhill	151-151-3050787	481	2 Jun 2017
482	Cable - Amp to Antenna	SRC Haverhill	157-157-3051574	482	2 Jun 2017
502	Test Software for Radiated Emissions	EMISoft	Vasona	Version 5 Build 59	Not Required
87	Uninterruptible Power Supply	Falcon Electric	ED2000-1/2LC	F3471 02/01	Cal when used

This test report may be reproduced in full only. The document may only be updated by MiCOM Labs personnel. All changes will be noted in the Document History section of the report.

8. MEASUREMENT AND PRESENTATION OF TEST DATA

The measurement and graphical data presented in this test report was generated automatically using state-of-the-art technology creating an easy to read report structure. Numerical measurement data is separated from supporting graphical data (plots) through hyperlinks. Numerical measurement data can be reviewed without scrolling through numerous graphical pages to arrive at the next data matrix.

Plots have been relegated into the Appendix 'Graphical Data'.

Test and report automation was performed by [MiTest](#). [MiTest](#) is an automated test system developed by MiCOM Labs. [MiTest](#) is the first cloud based modular test system enabling end-to-end automation of regulatory compliance testing for conducted RF testing.



The MiCOM Labs "[MiTest](#)" Automated Test System" (Patent Pending)

This test report may be reproduced in full only. The document may only be updated by MiCOM Labs personnel. All changes will be noted in the Document History section of the report.



Title: Hewlett Packard Enterprise APINR203, APINP203
To: FCC Part 15.247 (DTS) & IC RSS-247
Serial #: HPEN96-U2 Rev A Bluetooth BLE
Issue Date: 23rd March 2017
Page: 22 of 64

9. TEST RESULTS

9.1. 6 dB & 99% Bandwidth

Conducted Test Conditions for 6 dB and 99% Bandwidth			
Standard:	FCC CFR 47:15.247	Ambient Temp. (°C):	24.0 - 27.5
Test Heading:	6 dB and 99 % Bandwidth	Rel. Humidity (%):	32 - 45
Standard Section(s):	15.247 (a)(2)	Pressure (mBars):	999 - 1001
Reference Document(s):	See Normative References		

Test Procedure for 6 dB and 99% Bandwidth Measurement
The bandwidth at 6 dB and 99 % was measured with a spectrum analyzer connected to the antenna terminal, while EUT is operating in transmission mode at the appropriate center frequency.

Testing was performed under ambient conditions at nominal voltage. Where the device operated with multiple antenna ports i.e. MIMO device, each port was measured and reported.

Test configuration and setup used for the measurement was per the Conducted Test Set-up specified in this document.

Limits for 6 dB and 99% Bandwidth

(a) Operation under the provisions of this Section is limited to frequency hopping and digitally modulated intentional radiators that comply with the following provisions:

(2) Systems using digital modulation techniques may operate in the 902-928 MHz and 2400-2483.5 MHz bands. The minimum 6 dB bandwidth shall be at least 500 kHz.

This test report may be reproduced in full only. The document may only be updated by MiCOM Labs personnel. All changes will be noted in the Document History section of the report.



Title: Hewlett Packard Enterprise APINR203, APINP203
To: FCC Part 15.247 (DTS) & IC RSS-247
Serial #: HPEN96-U2 Rev A Bluetooth BLE
Issue Date: 23rd March 2017
Page: 23 of 64

Equipment Configuration for 6 dB & 99% Bandwidth

Variant:	DTS	Duty Cycle (%):	100
Data Rate:	1.00 MBit/s	Antenna Gain (dBi):	Not Applicable
Modulation:	GFSK	Beam Forming Gain (Y)(dB):	Not Applicable
TPC:	Not Applicable	Tested By:	OC
Engineering Test Notes:			

Test Measurement Results

Test Frequency	Measured 6 dB Bandwidth (MHz)				6 dB Bandwidth (MHz)		Limit	Lowest Margin
	Port(s)				Highest	Lowest		
MHz	a	b	c	d	KHz	MHz		
2402.0	0.713				0.713	0.713	≥500.0	-0.21
2440.0	0.709				0.709	0.709	≥500.0	-0.21
2480.0	0.713				0.713	0.713	≥500.0	-0.21

Test Frequency	Measured 99% Bandwidth (MHz)				Maximum 99% Bandwidth (MHz)		
	Port(s)						
MHz	a	b	c	d			
2402.0	1.082				1.082		
2440.0	1.082				1.082		
2480.0	1.078				1.078		

Traceability to Industry Recognized Test Methodologies

Work Instruction:	WI-03 MEASURING RF SPECTRUM MASK
Measurement Uncertainty:	±2.81 dB

Note: click the links in the above matrix to view the graphical image (plot).

This test report may be reproduced in full only. The document may only be updated by MiCOM Labs personnel. All changes will be noted in the Document History section of the report.



9.2. Conducted Output Power

Conducted Test Conditions for Fundamental Emission Output Power			
Standard:	FCC CFR 47:15.247	Ambient Temp. (°C):	24.0 - 27.5
Test Heading:	Output Power	Rel. Humidity (%):	32 - 45
Standard Section(s):	15.247 (b) & (c)	Pressure (mBars):	999 - 1001
Reference Document(s):	See Normative References		

Test Procedure for Fundamental Emission Output Power Measurement
In the case of average power measurements an average power sensor was utilized.

For peak power measurements the spectrum analyzer built-in power function was used to integrate peak power over the 20 dB bandwidth.

Testing was performed under ambient conditions at nominal voltage only. Where the device operated with multiple antenna ports i.e. MIMO device, each port was measured, summed (Σ) and reported.

Test configuration and setup used for the measurement was per the Conducted Test Set-up specified in this document.

Supporting Information

Calculated Power = $A + G + Y + 10 \log (1/x)$ dBm

A = Total Power [$10^A \text{Log}_{10} (10^{a/10} + 10^{b/10} + 10^{c/10} + 10^{d/10})$]

G = Antenna Gain

Y = Beamforming Gain

x = Duty Cycle (average power measurements only)

Limits for Fundamental Emission Output Power

(b) The maximum peak conducted output power of the intentional radiator shall not exceed the following for non-frequency hopping systems:

(3) For systems using digital modulation in the 902-928 MHz and 2400-2483.5 MHz bands: 1 Watt. As an alternative to a peak power measurement, compliance with the one Watt limit can be based on a measurement of the maximum conducted output power. Maximum Conducted Output Power is defined as the total transmit power delivered to all antennas and antenna elements averaged across all symbols in the signaling alphabet when the transmitter is operating at its maximum power control level. Power must be summed across all antennas and antenna elements. The average must not include any time intervals during which the transmitter is off or is transmitting at a reduced power level. If multiple modes of operation are possible (e.g., alternative modulation methods), the maximum conducted output power is the highest total transmit power occurring in any mode.

(4) The conducted output power limit specified in paragraph (b) of this section is based on the use of antennas with directional gains that do not exceed 6 dBi. Except as shown in paragraph (c) of this section, if transmitting antennas of directional gain greater than 6 dBi are used, the conducted output power from the intentional radiator shall be reduced below the stated values in paragraphs (b)(3) of this section, as appropriate, by the amount in dB that the directional gain of the antenna exceeds 6 dBi.

(c) Operation with directional antenna gains greater than 6 dBi.

(1) Fixed point-to-point operation:

(i) Systems operating in the 2400-2483.5 MHz band that are used exclusively for fixed, point-to-point operations may employ transmitting antennas with directional gain greater than 6 dBi provided the maximum conducted output power of the intentional radiator is reduced by 1 dB for every 3 dB that the directional gain of the antenna exceeds 6 dBi.

(iii) Fixed, point-to-point operation, as used in paragraphs (c)(1)(i) and (c)(1)(ii) of this section, excludes the use of point-to-multipoint systems, omnidirectional applications, and multiple co-located intentional radiators transmitting the same information. The operator of the spread spectrum or digitally modulated intentional radiator or, if the equipment is professionally installed, the installer is responsible for ensuring that the system is used exclusively for fixed, point-to-point operations. The instruction manual furnished with the intentional radiator shall contain language in the installation

This test report may be reproduced in full only. The document may only be updated by MiCOM Labs personnel. All changes will be noted in the Document History section of the report.



Title: Hewlett Packard Enterprise APINR203, APINP203
To: FCC Part 15.247 (DTS) & IC RSS-247
Serial #: HPEN96-U2 Rev A Bluetooth BLE
Issue Date: 23rd March 2017
Page: 25 of 64

instructions informing the operator and the installer of this responsibility.

(2) In addition to the provisions in paragraphs (b)(3), (b)(4) and (c)(1)(i) of this section, transmitters operating in the 2400-2483.5 MHz band that emit multiple directional beams, simultaneously or sequentially, for the purpose of directing signals to individual receivers or to groups of receivers provided the emissions comply with the following:

(i) Different information must be transmitted to each receiver.

(ii) If the transmitter employs an antenna system that emits multiple directional beams but does not do emit multiple directional beams simultaneously, the total output power conducted to the array or arrays that comprise the device, i.e., the sum of the power supplied to all antennas, antenna elements, staves, etc. and summed across all carriers or frequency channels, shall not exceed the limit specified in paragraph (b)(1) or (b)(3) of this section, as applicable. However, the total conducted output power shall be reduced by 1 dB below the specified limits for each 3 dB that the directional gain of the antenna/antenna array exceeds 6 dBi. The directional antenna gain shall be computed as follows:

(A) The directional gain shall be calculated as the sum of 10 log (number of array elements or staves) plus the directional gain of the element or stave having the highest gain.

(B) A lower value for the directional gain than that calculated in paragraph (c)(2)(ii)(A) of this section will be accepted if sufficient evidence is presented, e.g., due to shading of the array or coherence loss in the beamforming.

(iii) If a transmitter employs an antenna that operates simultaneously on multiple directional beams using the same or different frequency channels, the power supplied to each emission beam is subject to the power limit specified in paragraph (c)(2)(ii) of this section. If transmitted beams overlap, the power shall be reduced to ensure that their aggregate power does not exceed the limit specified in paragraph (c)(2)(ii) of this section. In addition, the aggregate power transmitted simultaneously on all beams shall not exceed the limit specified in paragraph (c)(2)(ii) of this section by more than 8 dB.

(iv) Transmitters that emit a single directional beam shall operate under the provisions of paragraph (c)(1) of this section.

This test report may be reproduced in full only. The document may only be updated by MiCOM Labs personnel. All changes will be noted in the Document History section of the report.



Title: Hewlett Packard Enterprise APINR203, APINP203
To: FCC Part 15.247 (DTS) & IC RSS-247
Serial #: HPEN96-U2 Rev A Bluetooth BLE
Issue Date: 23rd March 2017
Page: 26 of 64

Equipment Configuration for Peak Output Power

Variant:	DTS	Duty Cycle (%):	100.0
Data Rate:	1.00 MBit/s	Antenna Gain (dBi):	1.00
Modulation:	GFSK	Beam Forming Gain (Y)(dB):	Not Applicable
TPC:	Not Applicable	Tested By:	OC
Engineering Test Notes:			

Test Measurement Results

Test Frequency	Measured Output Power (dBm)				Calculated Total Power Σ Port(s)	Limit	Margin	EUT Power Setting
	Port(s)							
MHz	a	b	c	d	dBm	dBm	dB	
2402.0	3.01				3.01	30.00	-26.99	4.00
2440.0	3.66				3.66	30.00	-26.34	4.00
2480.0	4.11				4.11	30.00	-25.89	4.00

Traceability to Industry Recognized Test Methodologies

Work Instruction:	WI-01 MEASURING RF OUTPUT POWER
Measurement Uncertainty:	±1.33 dB

The above measurements are true pulse readings and therefore a Duty Cycling correction factor is not required.

This test report may be reproduced in full only. The document may only be updated by MiCOM Labs personnel. All changes will be noted in the Document History section of the report.



9.3. Power Spectral Density

Conducted Test Conditions for Power Spectral Density			
Standard:	FCC CFR 47:15.247	Ambient Temp. (°C):	24.0 - 27.5
Test Heading:	Power Spectral Density	Rel. Humidity (%):	32 - 45
Standard Section(s):	15.247 (e)	Pressure (mBars):	999 - 1001
Reference Document(s):	See Normative References		

Test Procedure for Power Spectral Density

The transmitter output was connected to a spectrum analyzer and the measured made in a 3 kHz resolution bandwidth using the analyzer auto-coupled sweep-time. A peak value was found over the full emission bandwidth and the spectrum downloaded for post processing purposes.

Where the device operated with multiple antenna ports i.e. MIMO device, each port was measured separately. The Peak Power Spectral Density is the highest level found across the emission bandwidth. With multiple antenna port measurements the numerical analyzer data from each port is summed (â) and a link to this additional graphic is provided.

Testing was performed under ambient conditions at nominal voltage only.

Test configuration and setup used for the measurement was per the Conducted Test Set-up specified in this document.

Measure and sum the spectra across the outputs. With this technique, spectra are measured at each output of the device at the required resolution bandwidth. The individual spectra are then summed mathematically in linear power units. Unlike in-band power measurements, in which the sum involves a single measured value (output power) from each output, measurements for compliance with PSD limits involve summing entire spectra across corresponding frequency bins on the various outputs. Consistency is maintained for any device with multiple transmitter outputs to be certain the individual outputs are all aligned with the same span and same number of points. In this instance, the linear power spectrum value within the first spectral bin of output 0 is summed with that in the first spectral bin of output 1, and the first spectral bin of output 2, and so on up to the Nth output to obtain the true value for the first frequency bin of the summed spectrum. The summed spectrum value for each frequency bin is computed in this fashion. These summed spectral values were post processed and the resulting numerical and graphical data presented.

NOTE:

It may be observed that the spectrum in some antenna port plots break the limit line however this in itself does NOT constitute a failure. In all cases a spectrum summation plot is provided in order to prove compliance. A failure occurs only after the summation of all spectrum plots have been summed and are found to be greater than the limit line.

Supporting Information

Calculated Power = $A + 10 \log (1/x)$ dBm

A = Total Power Spectral Density $[10 \log_{10} (10^{a/10} + 10^{b/10} + 10^{c/10} + 10^{d/10})]$

x = Duty Cycle

Limits Power Spectral Density

For digitally modulated systems, the power spectral density conducted from the intentional radiator to the antenna shall not be greater than +8 dBm in any 3 kHz band during any time interval of continuous transmission. This power spectral density shall be determined in accordance with the provisions of paragraph (b) of this section. The same method of determining the conducted output power shall be used to determine the power spectral density.



Title: Hewlett Packard Enterprise APINR203, APINP203
To: FCC Part 15.247 (DTS) & IC RSS-247
Serial #: HPEN96-U2 Rev A Bluetooth BLE
Issue Date: 23rd March 2017
Page: 28 of 64

Equipment Configuration for Power Spectral Density - Peak

Variant:	DTS	Duty Cycle (%):	100.0
Data Rate:	1.00 MBit/s	Antenna Gain (dBi):	1.00
Modulation:	GFSK	Beam Forming Gain (Y)(dB):	Not Applicable
TPC:	Not Applicable	Tested By:	OC
Engineering Test Notes:			

Test Measurement Results							
Test Frequency	Measured Power Spectral Density				Amplitude Summation	Limit	Margin
	Port(s) (dBm/3KHz)						
MHz	a	b	c	d	dBm/3KHz	dBm/3KHz	dB
2402.0	-10.174				Not Applicable	8.0	-18.2
2440.0	-9.984				Not Applicable	8.0	-18.0
2480.0	-11.146				Not Applicable	8.0	-19.2

Traceability to Industry Recognized Test Methodologies	
Work Instruction:	WI-03 MEASURING RF SPECTRUM MASK
Measurement Uncertainty:	±2.81 dB

Note: click the links in the above matrix to view the graphical image (plot).

This test report may be reproduced in full only. The document may only be updated by MiCOM Labs personnel. All changes will be noted in the Document History section of the report.



Title: Hewlett Packard Enterprise APINR203, APINP203
To: FCC Part 15.247 (DTS) & IC RSS-247
Serial #: HPEN96-U2 Rev A Bluetooth BLE
Issue Date: 23rd March 2017
Page: 29 of 64

9.4. Conducted Spurious Emissions

9.4.1. Conducted Emissions

9.4.1.1. Conducted Spurious Emissions

Conducted Test Conditions for Transmitter Conducted Spurious and Band-Edge Emissions			
Standard:	FCC CFR 47:15.247	Ambient Temp. (°C):	24.0 - 27.5
Test Heading:	Max Unwanted Emission Levels	Rel. Humidity (%):	32 - 45
Standard Section(s):	15.247 (d)	Pressure (mBars):	999 - 1001
Reference Document(s):	See Normative References		

Test Procedure for Transmitter Conducted Spurious and Band-Edge Emissions Measurement

Transmitter Conducted Spurious and Band-Edge emissions were measured at a limit of 30 dBc (average detector) or 20 dBc (peak detector) below the highest in-band spectral density measured with a spectrum analyzer connected to the antenna terminal. Measurements were made while EUT was operating in transmit mode of operation at the appropriate centre frequency closest to the band-edge. Emissions were maximized during the measurement and limits derived from the peak spectral power and drawn on each plot.

Where the device operated with multiple antenna ports i.e. MIMO device, each port was measured separately. Testing was performed under ambient conditions at nominal voltage only.

Test configuration and setup used for the measurement was per the Conducted Test Set-up specified in this document.

Limits Transmitter Conducted Spurious and Band-Edge Emissions

(d) In any 100 kHz bandwidth outside the frequency band in which the spread spectrum or digitally modulated intentional radiator is operating, the radio frequency power that is produced by the intentional radiator shall be at least 20 dB below that in the 100 kHz bandwidth within the band that contains the highest level of the desired power, based on either an RF conducted or a radiated measurement, provided the transmitter demonstrates compliance with the peak conducted power limits. If the transmitter complies with the conducted power limits based on the use of RMS averaging over a time interval, as permitted under paragraph (b)(3) of this section, the attenuation required under this paragraph shall be 30 dB instead of 20 dB. Attenuation below the general limits specified in §15.209(a) is not required. In addition, radiated emissions which fall in the restricted bands, as defined in §15.205(a), must also comply with the radiated emission limits specified in §15.209(a) (see §15.205(c)).

This test report may be reproduced in full only. The document may only be updated by MiCOM Labs personnel. All changes will be noted in the Document History section of the report.



Title: Hewlett Packard Enterprise APINR203, APINP203
To: FCC Part 15.247 (DTS) & IC RSS-247
Serial #: HPEN96-U2 Rev A Bluetooth BLE
Issue Date: 23rd March 2017
Page: 30 of 64

Equipment Configuration for Conducted Spurious Emissions - Peak

Variant:	DTS	Duty Cycle (%):	100
Data Rate:	1.00 MBit/s	Antenna Gain (dBi):	Not Applicable
Modulation:	GFSK	Beam Forming Gain (Y):	Not Applicable
TPC:	Not Applicable	Tested By:	OC
Engineering Test Notes:			

Test Measurement Results

Test Frequency	Frequency Range	Conducted Spurious Emissions - Peak (dBm)							
		Port a		Port b		Port c		Port d	
MHz	MHz	SE	Limit	SE	Limit	SE	Limit	SE	Limit
2402.0	30.0 - 26000.0	-39.771	-17.37						
2440.0	30.0 - 26000.0	-40.375	-17.91						
2480.0	30.0 - 26000.0	-39.620	-18.48						

Traceability to Industry Recognized Test Methodologies

Work Instruction:	WI-05 MEASUREMENT OF SPURIOUS EMISSIONS
Measurement Uncertainty:	<=40 GHz ±2.37 dB, > 40 GHz ±4.6 dB

Note: click the links in the above matrix to view the graphical image (plot).

This test report may be reproduced in full only. The document may only be updated by MiCOM Labs personnel. All changes will be noted in the Document History section of the report.



Title: Hewlett Packard Enterprise APINR203, APINP203
To: FCC Part 15.247 (DTS) & IC RSS-247
Serial #: HPEN96-U2 Rev A Bluetooth BLE
Issue Date: 23rd March 2017
Page: 31 of 64

9.4.1.2. Conducted Band-Edge Emissions

Equipment Configuration for Conducted Low Band-Edge Emissions - Peak

Variant:	DTS	Duty Cycle (%):	100.0
Data Rate:	1.00 MBit/s	Antenna Gain (dBi):	Not Applicable
Modulation:	GFSK	Beam Forming Gain (Y)(dB):	Not Applicable
TPC:	Not Applicable	Tested By:	OC
Engineering Test Notes:			

Test Measurement Results

Channel Frequency:	2402.0 MHz					
Band-Edge Frequency:	2400.0 MHz					
Test Frequency Range:	2350.0 - 2405.0 MHz					
Port(s)	Band-Edge Markers and Limit			Revised Limit		Margin
	M1 Amplitude (dBm)	Plot Limit (dBm)	M2 Frequency (MHz)	Amplitude (dBm)	M2A Frequency (MHz)	(MHz)
a	-33.43	-15.94	2401.40			-1.400

Traceability to Industry Recognized Test Methodologies	
Work Instruction:	WI-05 MEASUREMENT OF SPURIOUS EMISSIONS
Measurement Uncertainty:	<=40 GHz ±2.37 dB, > 40 GHz ±4.6 dB

Note: click the links in the above matrix to view the graphical image (plot).

This test report may be reproduced in full only. The document may only be updated by MiCOM Labs personnel. All changes will be noted in the Document History section of the report.



Title: Hewlett Packard Enterprise APINR203, APINP203
To: FCC Part 15.247 (DTS) & IC RSS-247
Serial #: HPEN96-U2 Rev A Bluetooth BLE
Issue Date: 23rd March 2017
Page: 32 of 64

Equipment Configuration for Conducted High Band-Edge Emissions - Peak

Variant:	DTS	Duty Cycle (%):	100.0
Data Rate:	1.00 MBit/s	Antenna Gain (dBi):	Not Applicable
Modulation:	GFSK	Beam Forming Gain (Y)(dB):	Not Applicable
TPC:	Not Applicable	Tested By:	OC
Engineering Test Notes:			

Test Measurement Results

Channel Frequency:	2480.0 MHz					
Band-Edge Frequency:	2483.5 MHz					
Test Frequency Range:	2475.0 - 2524.0 MHz					
Port(s)	Band-Edge Markers and Limit			Revised Limit		Margin
	M3 Amplitude (dBm)	Plot Limit (dBm)	M2 Frequency (MHz)	Amplitude (dBm)	M2A Frequency (MHz)	(MHz)
a	-46.50	-17.10	2480.60			-2.900

Traceability to Industry Recognized Test Methodologies

Work Instruction:	WI-05 MEASUREMENT OF SPURIOUS EMISSIONS
Measurement Uncertainty:	<=40 GHz ±2.37 dB, > 40 GHz ±4.6 dB

Note: click the links in the above matrix to view the graphical image (plot).

This test report may be reproduced in full only. The document may only be updated by MiCOM Labs personnel. All changes will be noted in the Document History section of the report.



9.5. Radiated Emissions

9.5.1. TX Spurious & Restricted Band Emissions

Radiated Test Conditions for Radiated Spurious and Band-Edge Emissions (Restricted Bands)			
Standard:	FCC CFR 47 Part 15 Subpart C 15.247 (DTS)	Ambient Temp. (°C):	20.0 - 24.5
Test Heading:	Radiated Spurious and Band-Edge Emissions	Rel. Humidity (%):	32 - 45
Standard Section(s):	15.205, 15.209	Pressure (mBars):	999 - 1001
Reference Document(s):	See Normative References		

Test Procedure for Radiated Spurious and Band-Edge Emissions (Restricted Bands)

Radiated emissions for restricted bands above 1 GHz are measured in the anechoic chamber at a 3-meter distance on every azimuth in both horizontal and vertical polarities. The emissions are recorded and maximized as a function of azimuth by rotation through 360° with a spectrum analyzer in peak hold mode. Depending on the frequency band spanned a notch filter and waveguide filter was used to remove the fundamental frequency. The highest emissions relative to the limit are listed for each frequency spanned. Measurements on any restricted band frequency or frequencies above 1 GHz are based on the use of measurement instrumentation employing peak and average detectors. All measurements were performed using a resolution bandwidth of 1 MHz.

Test configuration and setup for Radiated Spurious and Band-Edge Measurement were per the Radiated Test Set-up specified in this document.

Limits for Restricted Bands

Peak emission: 74 dBuV/m
Average emission: 54 dBuV/m

Field Strength Calculation

The field strength is calculated by adding the Antenna Factor and Cable Loss, and subtracting Amplifier Gain from the measured reading. All factors are included in the reported data.
 $FS = R + AF + CORR - FO$

where:

FS = Field Strength
R = Measured Spectrum analyzer Input Amplitude
AF = Antenna Factor
CORR = Correction Factor = CL – AG + NFL
CL = Cable Loss
AG = Amplifier Gain
FO = Distance Falloff Factor
NFL = Notch Filter Loss or Waveguide Loss

Example:

Given receiver input reading of 51.5 dBmV; Antenna Factor of 8.5 dB; Cable Loss of 1.3 dB; Falloff Factor of 0 dB, an Amplifier Gain of 26 dB and Notch Filter Loss of 1 dB. The Field Strength (FS) of the measured emission is:

$$FS = 51.5 + 8.5 + 1.3 - 26.0 + 1 = 36.3 \text{ dBmV/m}$$

Conversion between dBmV/m (or dBmV) and mV/m (or mV) are as follows:

$$\text{Level (dBmV/m)} = 20 * \text{Log (level (mV/m))}$$

$$40 \text{ dBmV/m} = 100 \text{ mV/m}$$

$$48 \text{ dBmV/m} = 250 \text{ mV/m}$$

Restricted Bands of Operation (15.205)

(a) Except as shown in paragraph (d) of this section, only spurious emissions are permitted in any of the frequency bands listed below:



Title: Hewlett Packard Enterprise APINR203, APINP203
To: FCC Part 15.247 (DTS) & IC RSS-247
Serial #: HPEN96-U2 Rev A Bluetooth BLE
Issue Date: 23rd March 2017
Page: 34 of 64

Frequency Band			
MHz	MHz	MHz	GHz
0.090-0.110	16.42-16.423	399.9-410	4.5-5.15
0.495-0.505	16.69475-16.69525	608-614	5.35-5.46
2.1735-2.1905	16.80425-16.80475	960-1240	7.25-7.75
4.125-4.128	25.5-25.67	1300-1427	8.025-8.5
4.17725-4.17775	37.5-38.25	1435-1626.5	9.0-9.2
4.20725-4.20775	73-74.6	1645.5-1646.5	9.3-9.5
6.215-6.218	74.8-75.2	1660-1710	10.6-12.7
6.26775-6.26825	108-121.94	1718.8-1722.2	13.25-13.4
6.31175-6.31225	123-138	2200-2300	14.47-14.5
8.291-8.294	149.9-150.05	2310-2390	15.35-16.2
8.362-8.366	156.52475-156.52525	2483.5-2500	17.7-21.4
8.37625-8.38675	156.7-156.9	2690-2900	22.01-23.12
8.41425-8.41475	162.0125-167.17	3260-3267	23.6-24.0
12.29-12.293	167.72-173.2	3332-3339	31.2-31.8
12.51975-12.52025	240-285	3345.8-3358	36.43-36.5
12.57675-12.57725	322-335.4	3600-4400	Above 38.6
13.36-13.41			

(b) Except as provided in paragraphs (d) and (e) of this section, the field strength of emissions appearing within these frequency bands shall not exceed the limits shown in §15.209. At frequencies equal to or less than 1000 MHz, compliance with the limits in §15.209 shall be demonstrated using measurement instrumentation employing a CISPR quasi-peak detector. Above 1000 MHz, compliance with the emission limits in §15.209 shall be demonstrated based on the average value of the measured emissions. The provisions in §15.35 apply to these measurements.

(c) Except as provided in paragraphs (d) and (e) of this section, regardless of the field strength limits specified elsewhere in this subpart, the provisions of this section apply to emissions from any intentional radiator.

(d) The following devices are exempt from the requirements of this section:

(1) Swept frequency field disturbance sensors operating between 1.705 and 37 MHz provided their emissions only sweep through the bands listed in paragraph (a) of this section, the sweep is never stopped with the fundamental emission within the bands listed in paragraph (a) of this section, and the fundamental emission is outside of the bands listed in paragraph (a) of this section more than 99% of the time the device is actively transmitting, without compensation for duty cycle.

(2) Transmitters used to detect buried electronic markers at 101.4 kHz which are employed by telephone companies.

(3) Cable locating equipment operated pursuant to §15.213.

(4) Any equipment operated under the provisions of §15.253, 15.255, and 15.256 in the frequency band 75-85 GHz, or §15.257 of this part.

(5) Biomedical telemetry devices operating under the provisions of §15.242 of this part are not subject to the restricted band 608-614 MHz but are subject to compliance within the other restricted bands.

(6) Transmitters operating under the provisions of subparts D or F of this part.

(7) Devices operated pursuant to §15.225 are exempt from complying with this section for the 13.36-13.41 MHz band only.

(8) Devices operated in the 24.075-24.175 GHz band under §15.245 are exempt from complying with the requirements of this section for the 48.15-48.35 GHz and 72.225-72.525 GHz bands only, and shall not exceed the limits specified in §15.245(b).

This test report may be reproduced in full only. The document may only be updated by MiCOM Labs personnel. All changes will be noted in the Document History section of the report.



Title: Hewlett Packard Enterprise APINR203, APINP203
To: FCC Part 15.247 (DTS) & IC RSS-247
Serial #: HPEN96-U2 Rev A Bluetooth BLE
Issue Date: 23rd March 2017
Page: 35 of 64

(9) Devices operated in the 24.0-24.25 GHz band under §15.249 are exempt from complying with the requirements of this section for the 48.0-48.5 GHz and 72.0-72.75 GHz bands only, and shall not exceed the limits specified in §15.249(a).

(e) Harmonic emissions appearing in the restricted bands above 17.7 GHz from field disturbance sensors operating under the provisions of §15.245 shall not exceed the limits specified in §15.245(b).

This test report may be reproduced in full only. The document may only be updated by MiCOM Labs personnel. All changes will be noted in the Document History section of the report.



Title: Hewlett Packard Enterprise APINR203, APINP203
To: FCC Part 15.247 (DTS) & IC RSS-247
Serial #: HPEN96-U2 Rev A Bluetooth BLE
Issue Date: 23rd March 2017
Page: 36 of 64

9.5.2. Restricted Band Spurious Emissions

Equipment Configuration for TX Spurious & Restricted Band Emissions

Antenna:	HPE Metal Sheet	Variant:	DTS
Antenna Gain (dBi):	1.00	Modulation:	GFSK
Beam Forming Gain (Y):	Not Applicable	Duty Cycle (%):	99
Channel Frequency (MHz):	2402.00	Data Rate:	1.00 MBit/s
Power Setting:	4	Tested By:	OC

Test Measurement Results

There are no emissions found within 6dB of the limit line.

[Click here to view measurement data...](#)

Test Notes: EUT on non-conductive 150cm table powered by laptop, connected to laptop inside chamber.

This test report may be reproduced in full only. The document may only be updated by MiCOM Labs personnel. All changes will be noted in the Document History section of the report.



Title: Hewlett Packard Enterprise APINR203, APINP203
To: FCC Part 15.247 (DTS) & IC RSS-247
Serial #: HPEN96-U2 Rev A Bluetooth BLE
Issue Date: 23rd March 2017
Page: 37 of 64

Equipment Configuration for TX Spurious & Restricted Band Emissions

Antenna:	HPE Metal Sheet	Variant:	DTS
Antenna Gain (dBi):	1.00	Modulation:	GFSK
Beam Forming Gain (Y):	Not Applicable	Duty Cycle (%):	99
Channel Frequency (MHz):	2440.00	Data Rate:	1.00 MBit/s
Power Setting:	4	Tested By:	OC

Test Measurement Results

1000.00 - 18000.00 MHz

Num	Frequency MHz	Raw dBµV	Cable Loss dB	AF dB	Level dBµV/m	Measurement Type	Pol	Hgt cm	Azt Deg	Limit dBµV/m	Margin dB	Pass /Fail
#1	1394.49	58.17	2.25	-15.53	44.89	Max Peak	Vertical	106	283	74.0	-29.1	Pass
#2	1394.49	37.15	2.25	-15.53	23.87	Max Avg	Vertical	106	283	54.0	-30.1	Pass

Test Notes: EUT on non-conductive 150cm table powered by laptop, connected to laptop inside chamber.

This test report may be reproduced in full only. The document may only be updated by MiCOM Labs personnel. All changes will be noted in the Document History section of the report.



Title: Hewlett Packard Enterprise APINR203, APINP203
To: FCC Part 15.247 (DTS) & IC RSS-247
Serial #: HPEN96-U2 Rev A Bluetooth BLE
Issue Date: 23rd March 2017
Page: 38 of 64

Equipment Configuration for TX Spurious & Restricted Band Emissions

Antenna:	HPE Metal Sheet	Variant:	DTS
Antenna Gain (dBi):	1.00	Modulation:	GFSK
Beam Forming Gain (Y):	Not Applicable	Duty Cycle (%):	99
Channel Frequency (MHz):	2480.00	Data Rate:	1.00 MBit/s
Power Setting:	4	Tested By:	OC

Test Measurement Results

There are no emissions found within 6dB of the limit line.

[Click here to view measurement data...](#)

Test Notes: EUT on non-conductive 150cm table powered by laptop, connected to laptop inside chamber.

This test report may be reproduced in full only. The document may only be updated by MiCOM Labs personnel. All changes will be noted in the Document History section of the report.



Title: Hewlett Packard Enterprise APINR203, APINP203
To: FCC Part 15.247 (DTS) & IC RSS-247
Serial #: HPEN96-U2 Rev A Bluetooth BLE
Issue Date: 23rd March 2017
Page: 39 of 64

9.5.3. Restricted Edge & Band-Edge Emissions

HPE Metal Sheet		Band-Edge Freq	Limit 74.0dB μ V/m	Limit 54.0dB μ V/m	Power Setting
Operational Mode	Operating Frequency (MHz)	MHz	dB μ V/m	dB μ V/m	
BLE	2402.00	2390.00	60.97	46.99	4

This test report may be reproduced in full only. The document may only be updated by MiCOM Labs personnel. All changes will be noted in the Document History section of the report.



Title: Hewlett Packard Enterprise APINR203, APINP203
To: FCC Part 15.247 (DTS) & IC RSS-247
Serial #: HPEN96-U2 Rev A Bluetooth BLE
Issue Date: 23rd March 2017
Page: 40 of 64

Equipment Configuration for Radiated - Lower Restricted Band-Edge Emissions

Antenna:	HPE Metal Sheet	Variant:	DTS
Antenna Gain (dBi):	1.00	Modulation:	GFSK
Beam Forming Gain (Y):	Not Applicable	Duty Cycle (%):	99
Channel Frequency (MHz):	2402.00	Data Rate:	1.00 MBit/s
Power Setting:	4	Tested By:	OC

Test Measurement Results

2310.00 - 2422.00 MHz

Num	Frequency MHz	Raw dBµV	Cable Loss dB	AF dB	Level dBµV/m	Measurement Type	Pol	Hgt cm	Azt Deg	Limit dBµV/m	Margin dB	Pass /Fail
#1	2373.29	26.37	2.71	31.89	60.97	Max Peak	Horizontal	140	352	74.0	-13.0	Pass
#2	2390.00	12.26	2.69	32.04	46.99	Max Avg	Horizontal	140	352	54.0	-7.0	Pass
#3	2390.00	--	--	--	--	Restricted-Band	--	--	--	--	--	--

Test Notes: EUT on non-conductive 150cm table powered by laptop, connected to laptop inside chamber.

This test report may be reproduced in full only. The document may only be updated by MiCOM Labs personnel. All changes will be noted in the Document History section of the report.



Title: Hewlett Packard Enterprise APINR203, APINP203
To: FCC Part 15.247 (DTS) & IC RSS-247
Serial #: HPEN96-U2 Rev A Bluetooth BLE
Issue Date: 23rd March 2017
Page: 41 of 64

HPE Metal Sheet		Band-Edge Freq	Limit 74.0dB μ V/m	Limit 54.0dB μ V/m	Power Setting
Operational Mode	Operating Frequency (MHz)	MHz	dB μ V/m	dB μ V/m	
BLE	2480.00	2483.50	65.13	52.98	4

This test report may be reproduced in full only. The document may only be updated by MiCOM Labs personnel. All changes will be noted in the Document History section of the report.



Title: Hewlett Packard Enterprise APINR203, APINP203
To: FCC Part 15.247 (DTS) & IC RSS-247
Serial #: HPEN96-U2 Rev A Bluetooth BLE
Issue Date: 23rd March 2017
Page: 42 of 64

Equipment Configuration for Radiated - Upper Restricted Band-Edge Emissions

Antenna:	HPE Metal Sheet	Variant:	DTS
Antenna Gain (dBi):	1.00	Modulation:	GFSK
Beam Forming Gain (Y):	Not Applicable	Duty Cycle (%):	99
Channel Frequency (MHz):	2480.00	Data Rate:	1.00 MBit/s
Power Setting:	4	Tested By:	OC

Test Measurement Results

2470.46380450864.00 - 2520.00 MHz

Num	Frequency MHz	Raw dBµV	Cable Loss dB	AF dB	Level dBµV/m	Measurement Type	Pol	Hgt cm	Azt Deg	Limit dBµV/m	Margin dB	Pass /Fail
#1	2483.50	17.88	2.73	32.37	52.98	Max Avg	Horizontal	140	352	54.0	-1.0	Pass
#2	2483.50	30.03	2.73	32.37	65.13	Max Peak	Horizontal	140	352	74.0	-8.9	Pass
#3	2483.50	--	--	--	--	Restricted-Band	--	--	--	--	--	--

Test Notes: EUT on non-conductive 150cm table powered by laptop, connected to laptop inside chamber.

This test report may be reproduced in full only. The document may only be updated by MiCOM Labs personnel. All changes will be noted in the Document History section of the report.



9.5.4. TX Spurious & Restricted Band Emissions (0.03 - 1 GHz)

Radiated Test Conditions for Radiated Digital Emissions (0.03 – 1 GHz)			
Standard:	FCC CFR 47:15.247	Ambient Temp. (°C):	20.0 - 24.5
Test Heading:	Digital Emissions	Rel. Humidity (%):	32 - 45
Standard Section(s):	15.209	Pressure (mBars):	999 - 1001
Reference Document(s):	See Normative References		

Test Procedure for Radiated Digital Emissions (0.03 – 1 GHz)

Testing 30M-1 GHz was performed in a 3-meter anechoic chamber using a CISPR compliant receiver. Preliminary radiated emissions were measured on every azimuth and with the receiving antenna in both horizontal and vertical polarizations. To further maximize emissions the receive antenna was varied between 1 and 4 meters. The emissions are recorded with receiver in peak hold mode. Emissions closest to the limits are measured in the quasi-peak mode with the tuned receiver using a bandwidth of 120 kHz. Only the highest emissions relative to the limit are listed.

Test configuration and setup for Radiated Spurious and Band-Edge Measurement were per the Radiated Test Set-up specified in this document.

Field Strength Calculation

The field strength is calculated by adding the Antenna Factor and Cable Loss, and subtracting Amplifier Gain from the measured reading. In this test facility, the Antenna Factor, Cable Loss, and Amplifier Gains are loaded into the Rohde & Schwarz Receiver and the corrected field strength can be read directly on the receiver.

$$FS = R + AF + CORR$$

where:

- FS = Field Strength
- R = Measured Receiver Input Amplitude
- AF = Antenna Factor
- CORR = Correction Factor = CL – AG + NFL
- CL = Cable Loss
- AG = Amplifier Gain

For example:

Given a Receiver input reading of 51.5dBmV; Antenna Factor of 8.5dB; Cable Loss of 1.3dB; Falloff Factor of 0dB, an Amplifier Gain of 26dB and Notch Filter Loss of 1dB. The Field Strength of the measured emission is:

$$FS = 51.5 + 8.5 + 1.3 - 26.0 + 1 = 36.3\text{dBmV/m}$$

Conversion between dBmV/m (or dBmV) and mV/m (or mV) are done as:

$$\text{Level (dBmV/m)} = 20 * \text{Log (level (mV/m))}$$

- 40 dBmV/m = 100mV/m
- 48 dBmV/m = 250mV/m

Limits for Radiated Digital Emissions (0.03 – 1 GHz)

(a) Except as provided elsewhere in this subpart, the emissions from an intentional radiator shall not exceed the field strength levels specified in the following table:

Frequency (MHz)	Field Strength		Measurement Distance (m)
	µV/m (microvolts/meter)	dBµV/m (dB microvolts/meter)	
0.009-0.490	2400/F(kHz)	--	300

This test report may be reproduced in full only. The document may only be updated by MiCOM Labs personnel. All changes will be noted in the Document History section of the report.



Title: Hewlett Packard Enterprise APINR203, APINP203
To: FCC Part 15.247 (DTS) & IC RSS-247
Serial #: HPEN96-U2 Rev A Bluetooth BLE
Issue Date: 23rd March 2017
Page: 44 of 64

0.490-1.705	24000/F(kHz)	--	30
1.705-30.0	30	29.5	30
30-88	100**	40	3
88-216	150**	43.5	3
216-960	200**	46.0	3
Above 960	500	54.0	3

**Except as provided in paragraph (g), fundamental emissions from intentional radiators operating under this section shall not be located in the frequency bands 54-72 MHz, 76-88 MHz, 174-216 MHz or 470-806 MHz. However, operation within these frequency bands is permitted under other sections of this part, e.g., §§15.231 and 15.241. (b) In the emission table above, the tighter limit applies at the band edges. (c) The level of any unwanted emissions from an intentional radiator operating under these general provisions shall not exceed the level of the fundamental emission. For intentional radiators which operate under the provisions of other sections within this part and which are required to reduce their unwanted emissions to the limits specified in this table, the limits in this table are based on the frequency of the unwanted emission and not the fundamental frequency. However, the level of any unwanted emissions shall not exceed the level of the fundamental frequency. (d) The emission limits shown in the above table are based on measurements employing a CISPR quasi-peak detector except for the frequency bands 9-90 kHz, 110-490 kHz and above 1000 MHz. Radiated emission limits in these three bands are based on measurements employing an average detector. (e) The provisions in §§15.31, 15.33, and 15.35 for measuring emissions at distances other than the distances specified in the above table, determining the frequency range over which radiated emissions are to be measured, and limiting peak emissions apply to all devices operated under this part. (f) In accordance with §15.33(a), in some cases the emissions from an intentional radiator must be measured to beyond the tenth harmonic of the highest fundamental frequency designed to be emitted by the intentional radiator because of the incorporation of a digital device. If measurements above the tenth harmonic are so required, the radiated emissions above the tenth harmonic shall comply with the general radiated emission limits applicable to the incorporated digital device, as shown in §15.109 and as based on the frequency of the emission being measured, or, except for emissions contained in the restricted frequency bands shown in §15.205, the limit on spurious emissions specified for the intentional radiator, whichever is the higher limit. Emissions which must be measured above the tenth harmonic of the highest fundamental frequency designed to be emitted by the intentional radiator and which fall within the restricted bands shall comply with the general radiated emission limits in §15.109 that are applicable to the incorporated digital device. (g) Perimeter protection systems may operate in the 54-72 MHz and 76-88 MHz bands under the provisions of this section. The use of such perimeter protection systems is limited to industrial, business and commercial applications.

This test report may be reproduced in full only. The document may only be updated by MiCOM Labs personnel. All changes will be noted in the Document History section of the report.



Title: Hewlett Packard Enterprise APINR203, APINP203
To: FCC Part 15.247 (DTS) & IC RSS-247
Serial #: HPEN96-U2 Rev A Bluetooth BLE
Issue Date: 23rd March 2017
Page: 45 of 64

Equipment Configuration for TX Spurious & Restricted Band Emissions (0.03 - 1 GHz)

Antenna:	HPE Metal Sheet	Variant:	DTS
Antenna Gain (dBi):	1.00	Modulation:	GFSK
Beam Forming Gain (Y):	Not Applicable	Duty Cycle (%):	99
Channel Frequency (MHz):	2480.00	Data Rate:	1.00 MBit/s
Power Setting:	4	Tested By:	OC

Test Measurement Results

30.00 - 1000.00 MHz												
Num	Frequency MHz	Raw dBµV	Cable Loss dB	AF dB	Level dBµV/m	Measurement Type	Pol	Hgt cm	Azt Deg	Limit dBµV/m	Margin dB	Pass /Fail
#1	46.73	54.77	3.55	-21.85	36.47	MaxQP (NRB)	Horizontal	373	178	40.0	-3.5	Pass
#2	108.92	56.39	3.93	-19.02	41.30	MaxQP	Horizontal	174	195	43.0	-1.7	Pass
#3	124.43	53.76	4.00	-17.27	40.49	MaxQP	Horizontal	246	37	43.0	-2.5	Pass
#4	489.86	47.14	5.32	-12.88	39.58	MaxQP (NRB)	Horizontal	142	116	46.0	-6.4	Pass

Test Notes: EUT on non-conductive 80cm table powered by laptop, connected to laptop inside chamber.

This test report may be reproduced in full only. The document may only be updated by MiCOM Labs personnel. All changes will be noted in the Document History section of the report.



Title: Hewlett Packard Enterprise APINR203, APINP203
To: FCC Part 15.247 (DTS) & IC RSS-247
Serial #: HPEN96-U2 Rev A Bluetooth BLE
Issue Date: 23rd March 2017
Page: 46 of 64

A. APPENDIX - GRAPHICAL IMAGES

This test report may be reproduced in full only. The document may only be updated by MiCOM Labs personnel. All changes will be noted in the Document History section of the report.



Title: Hewlett Packard Enterprise APINR203, APINP203
To: FCC Part 15.247 (DTS) & IC RSS-247
Serial #: HPEN96-U2 Rev A Bluetooth BLE
Issue Date: 23rd March 2017
Page: 47 of 64

A.1. 6 dB & 99% Bandwidth

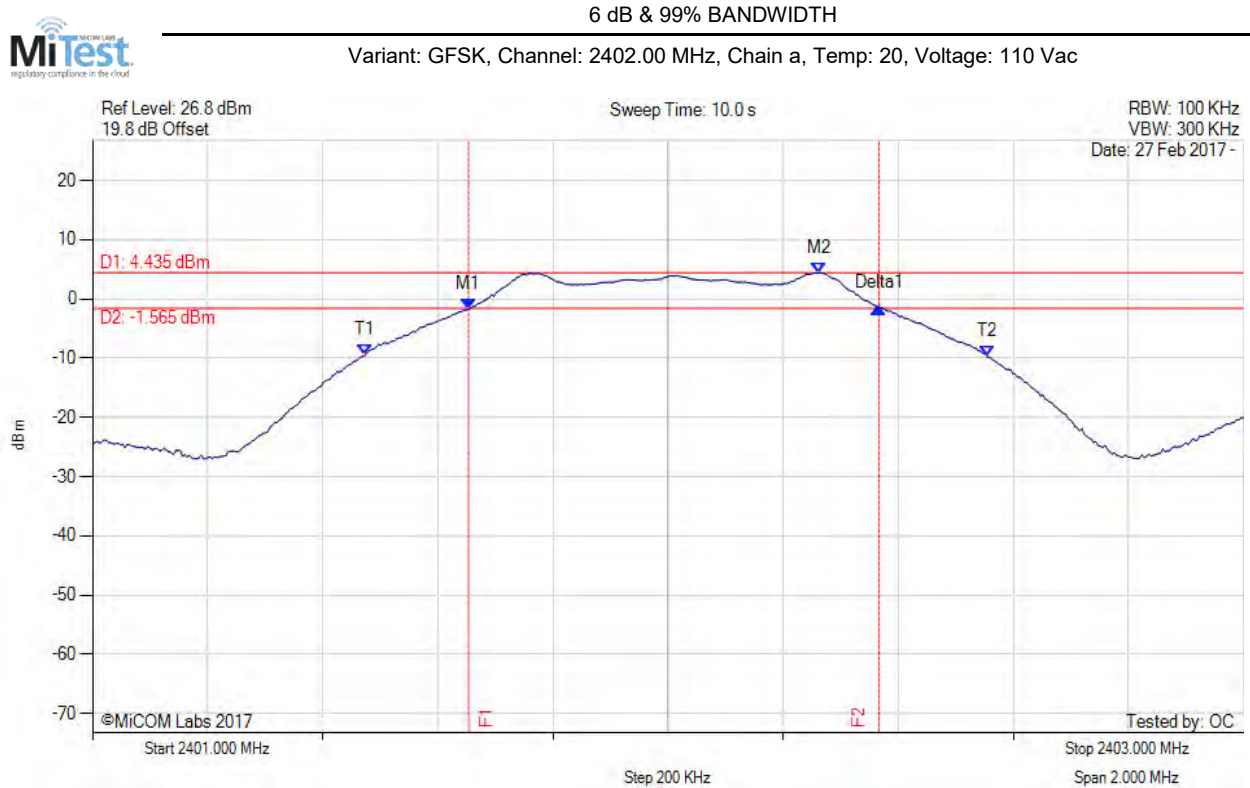

Analyzer Setup	Marker:Frequency:Amplitude	Test Results
Detector = MAX PEAK Sweep Count = 0 RF Atten (dB) = 20 Trace Mode = MAX HOLD	M1 : 2401.653 MHz : -1.695 dBm M2 : 2402.263 MHz : 4.435 dBm Delta1 : 713 KHz : 0.244 dB T1 : 2401.473 MHz : -9.555 dBm T2 : 2402.555 MHz : -9.757 dBm OBW : 1.082 MHz	Measured 6 dB Bandwidth: 0.713 MHz Limit: ≥500.0 kHz Margin: -0.21 MHz

[back to matrix](#)

This test report may be reproduced in full only. The document may only be updated by MiCOM Labs personnel. All changes will be noted in the Document History section of the report.



Title: Hewlett Packard Enterprise APINR203, APINP203
To: FCC Part 15.247 (DTS) & IC RSS-247
Serial #: HPEN96-U2 Rev A Bluetooth BLE
Issue Date: 23rd March 2017
Page: 48 of 64



6 dB & 99% BANDWIDTH

Variant: GFSK, Channel: 2440.00 MHz, Chain a, Temp: 20, Voltage: 110 Vac

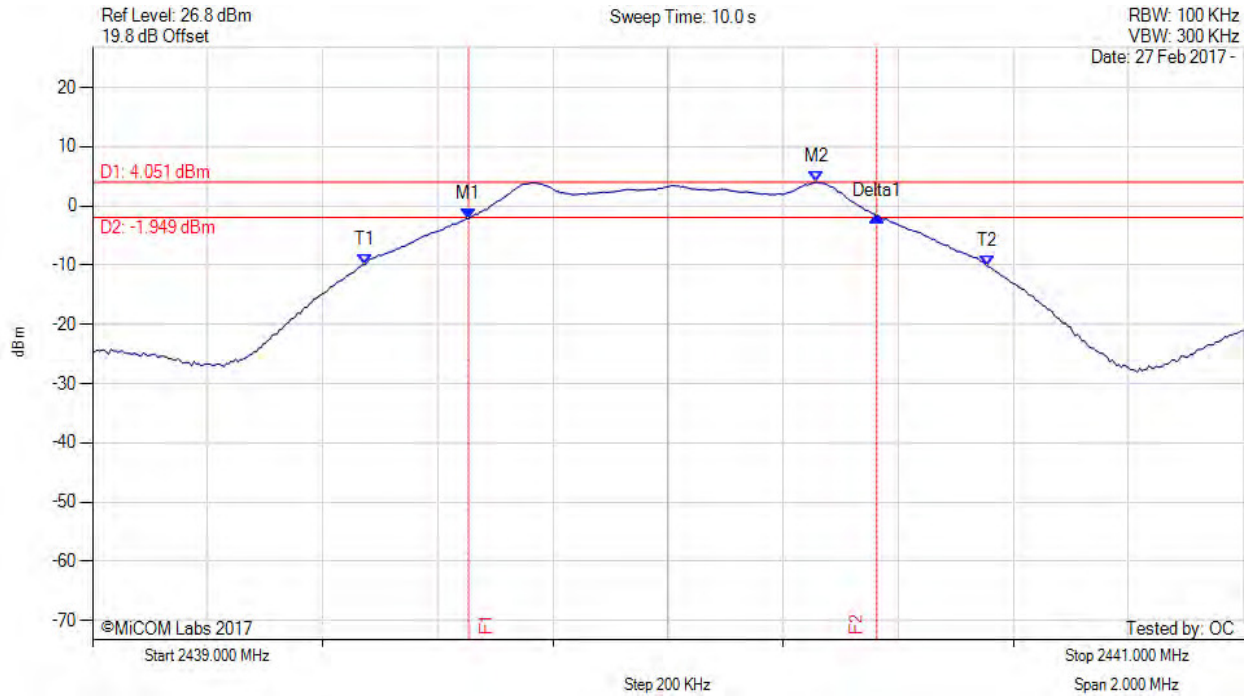

Analyzer Setup	Marker:Frequency:Amplitude	Test Results
Detector = MAX PEAK Sweep Count = 0 RF Atten (dB) = 20 Trace Mode = MAX HOLD	M1 : 2439.653 MHz : -2.181 dBm M2 : 2440.259 MHz : 4.051 dBm Delta1 : 709 KHz : 0.386 dB T1 : 2439.473 MHz : -9.944 dBm T2 : 2440.555 MHz : -10.198 dBm OBW : 1.082 MHz	Measured 6 dB Bandwidth: 0.709 MHz Limit: ≥500.0 kHz Margin: -0.21 MHz

[back to matrix](#)

This test report may be reproduced in full only. The document may only be updated by MiCOM Labs personnel. All changes will be noted in the Document History section of the report.



Title: Hewlett Packard Enterprise APINR203, APINP203
To: FCC Part 15.247 (DTS) & IC RSS-247
Serial #: HPEN96-U2 Rev A Bluetooth BLE
Issue Date: 23rd March 2017
Page: 49 of 64



6 dB & 99% BANDWIDTH

Variant: GFSK, Channel: 2480.00 MHz, Chain a, Temp: 20, Voltage: 110 Vac

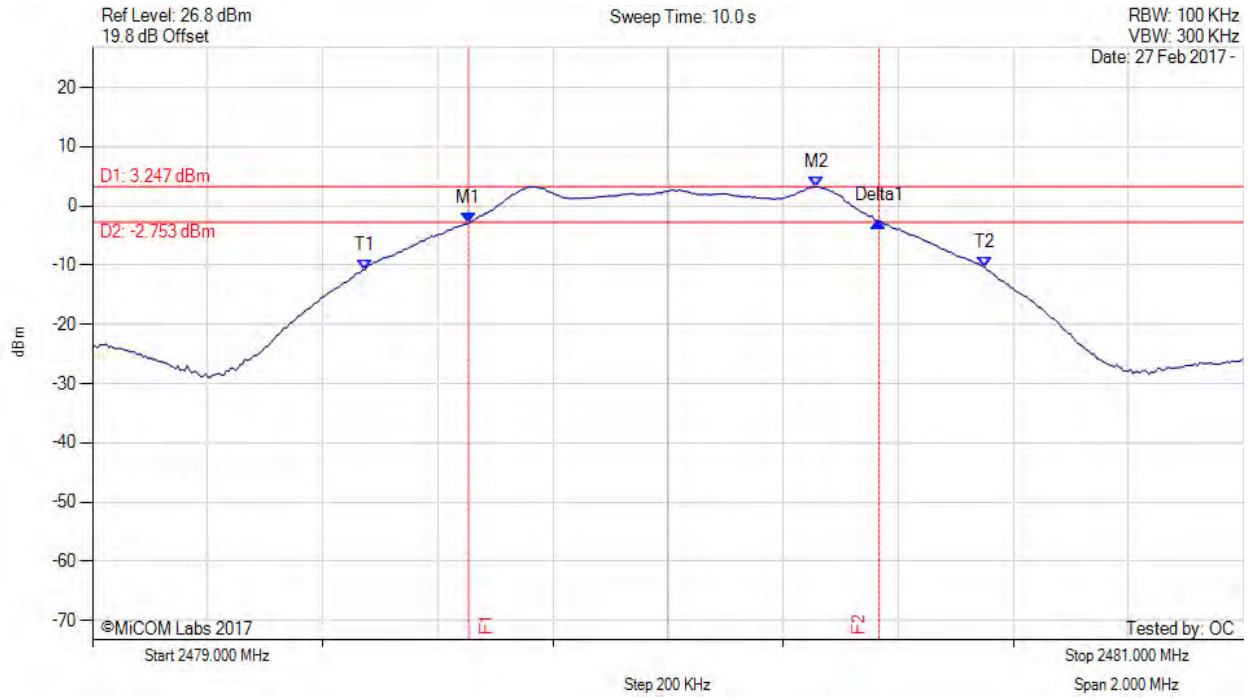

Analyzer Setup	Marker:Frequency:Amplitude	Test Results
Detector = MAX PEAK Sweep Count = 0 RF Atten (dB) = 20 Trace Mode = MAX HOLD	M1 : 2479.653 MHz : -2.939 dBm M2 : 2480.259 MHz : 3.247 dBm Delta1 : 713 KHz : 0.374 dB T1 : 2479.473 MHz : -10.814 dBm T2 : 2480.551 MHz : -10.393 dBm OBW : 1.078 MHz	Measured 6 dB Bandwidth: 0.713 MHz Limit: ≥500.0 kHz Margin: -0.21 MHz

[back to matrix](#)

This test report may be reproduced in full only. The document may only be updated by MiCOM Labs personnel. All changes will be noted in the Document History section of the report.



Title: Hewlett Packard Enterprise APINR203, APINP203
To: FCC Part 15.247 (DTS) & IC RSS-247
Serial #: HPEN96-U2 Rev A Bluetooth BLE
Issue Date: 23rd March 2017
Page: 50 of 64

A.2. Power Spectral Density

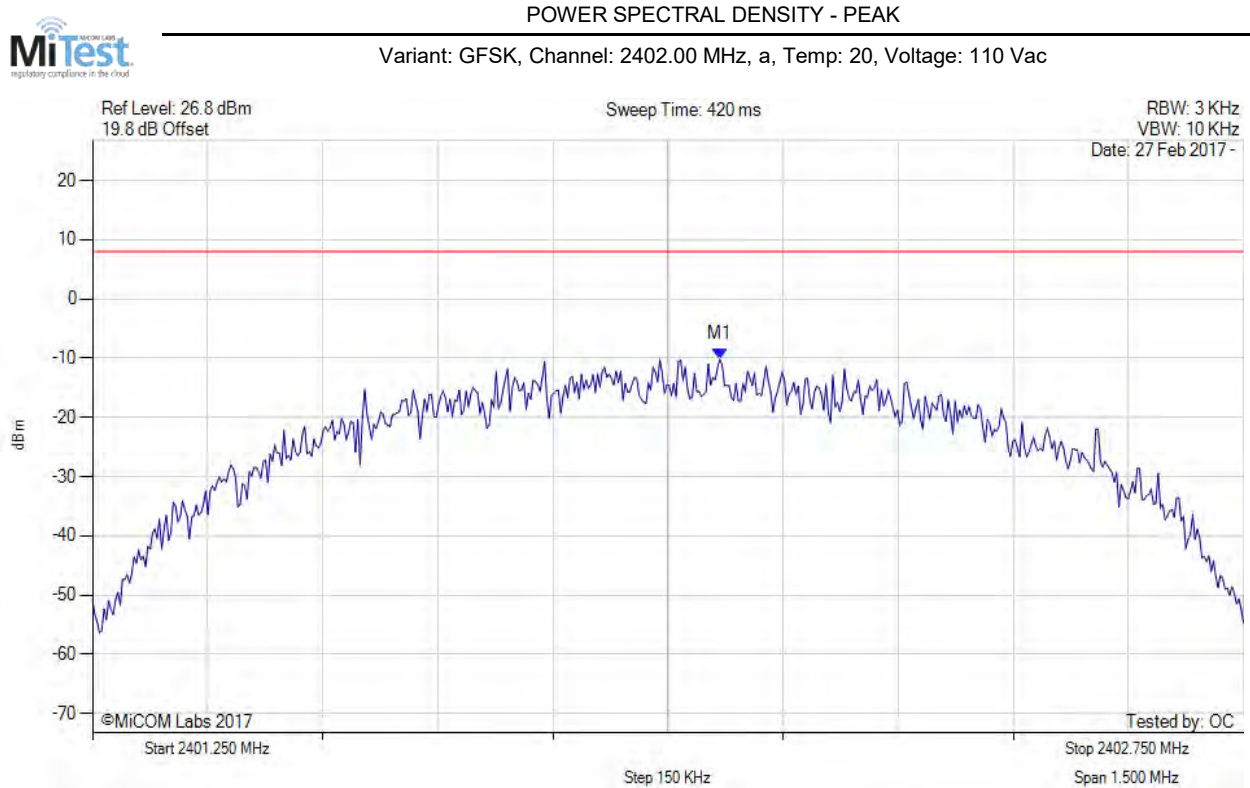

Analyzer Setup	Marker:Frequency:Amplitude	Test Results
Detector = MAX PEAK Sweep Count = 0 RF Atten (dB) = 20 Trace Mode = VIEW	M1 : 2402.068 MHz : -10.174 dBm	Limit: ≤ 8.0 dBm Margin: -18.2 dB

[back to matrix](#)

This test report may be reproduced in full only. The document may only be updated by MiCOM Labs personnel. All changes will be noted in the Document History section of the report.



Title: Hewlett Packard Enterprise APINR203, APINP203
To: FCC Part 15.247 (DTS) & IC RSS-247
Serial #: HPEN96-U2 Rev A Bluetooth BLE
Issue Date: 23rd March 2017
Page: 51 of 64

POWER SPECTRAL DENSITY - PEAK



Variant: GFSK, Channel: 2440.00 MHz, a, Temp: 20, Voltage: 110 Vac

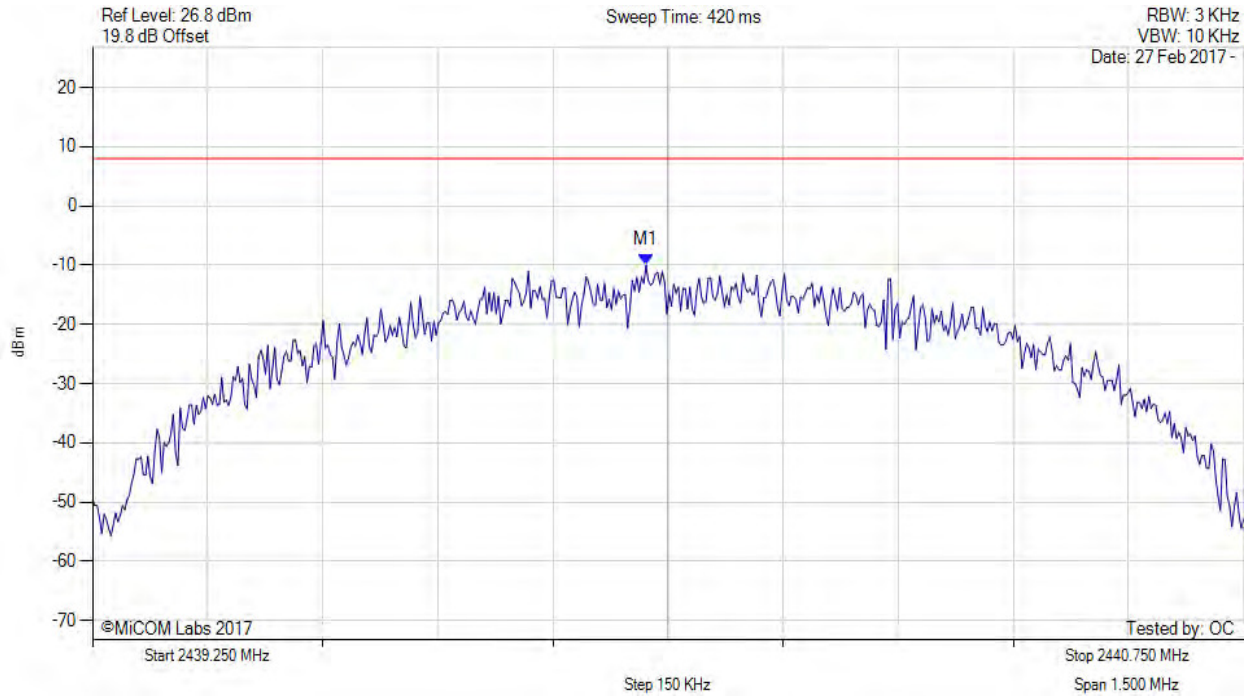

Analyzer Setup	Marker:Frequency:Amplitude	Test Results
Detector = MAX PEAK Sweep Count = 0 RF Atten (dB) = 20 Trace Mode = VIEW	M1 : 2439.971 MHz : -9.984 dBm	Limit: ≤ 8.0 dBm Margin: -18.0 dB

[back to matrix](#)

This test report may be reproduced in full only. The document may only be updated by MiCOM Labs personnel. All changes will be noted in the Document History section of the report.



Title: Hewlett Packard Enterprise APINR203, APINP203
To: FCC Part 15.247 (DTS) & IC RSS-247
Serial #: HPEN96-U2 Rev A Bluetooth BLE
Issue Date: 23rd March 2017
Page: 52 of 64

POWER SPECTRAL DENSITY - PEAK



Variant: GFSK, Channel: 2480.00 MHz, a, Temp: 20, Voltage: 110 Vac

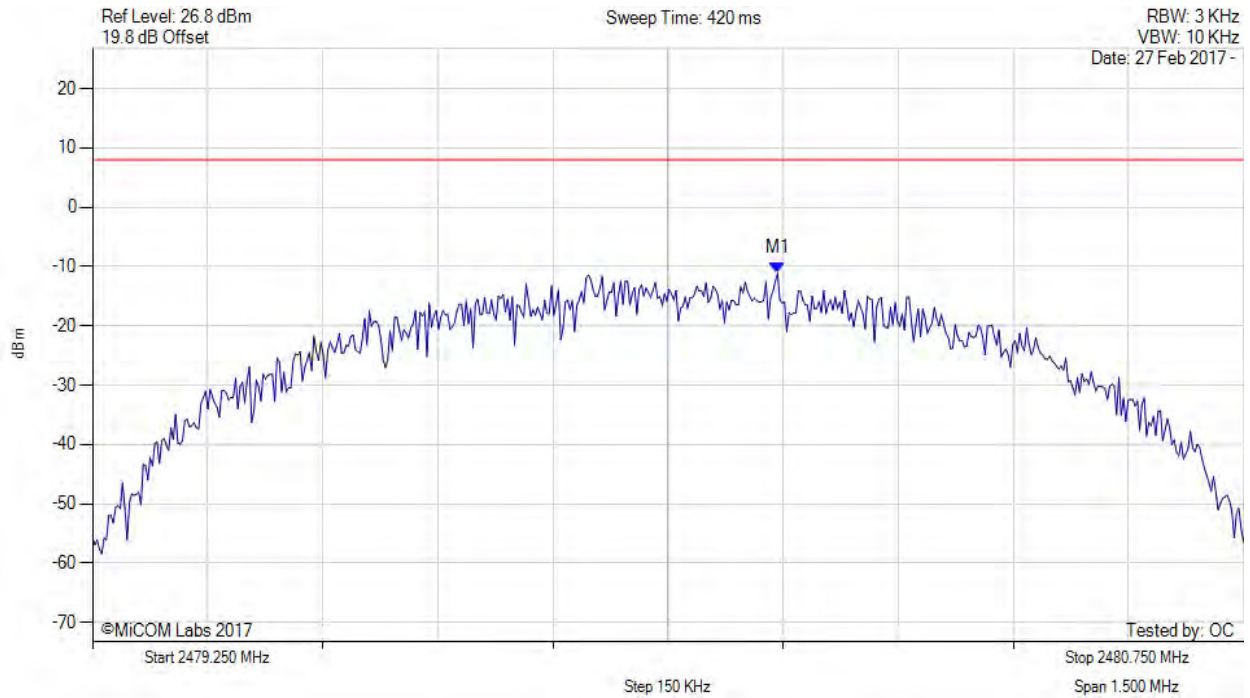

Analyzer Setup	Marker:Frequency:Amplitude	Test Results
Detector = MAX PEAK Sweep Count = 0 RF Atten (dB) = 20 Trace Mode = VIEW	M1 : 2480.143 MHz : -11.146 dBm	Limit: ≤ 8.0 dBm Margin: -19.2 dB

[back to matrix](#)

This test report may be reproduced in full only. The document may only be updated by MiCOM Labs personnel. All changes will be noted in the Document History section of the report.



Title: Hewlett Packard Enterprise APINR203, APINP203
To: FCC Part 15.247 (DTS) & IC RSS-247
Serial #: HPEN96-U2 Rev A Bluetooth BLE
Issue Date: 23rd March 2017
Page: 53 of 64

A.3. Conducted Emissions

A.3.1. Conducted Spurious Emissions



CONDUCTED SPURIOUS EMISSIONS - PEAK

Variant: GFSK, Channel: 2402.00 MHz, Chain a, Temp: 20, Voltage: 110 Vac

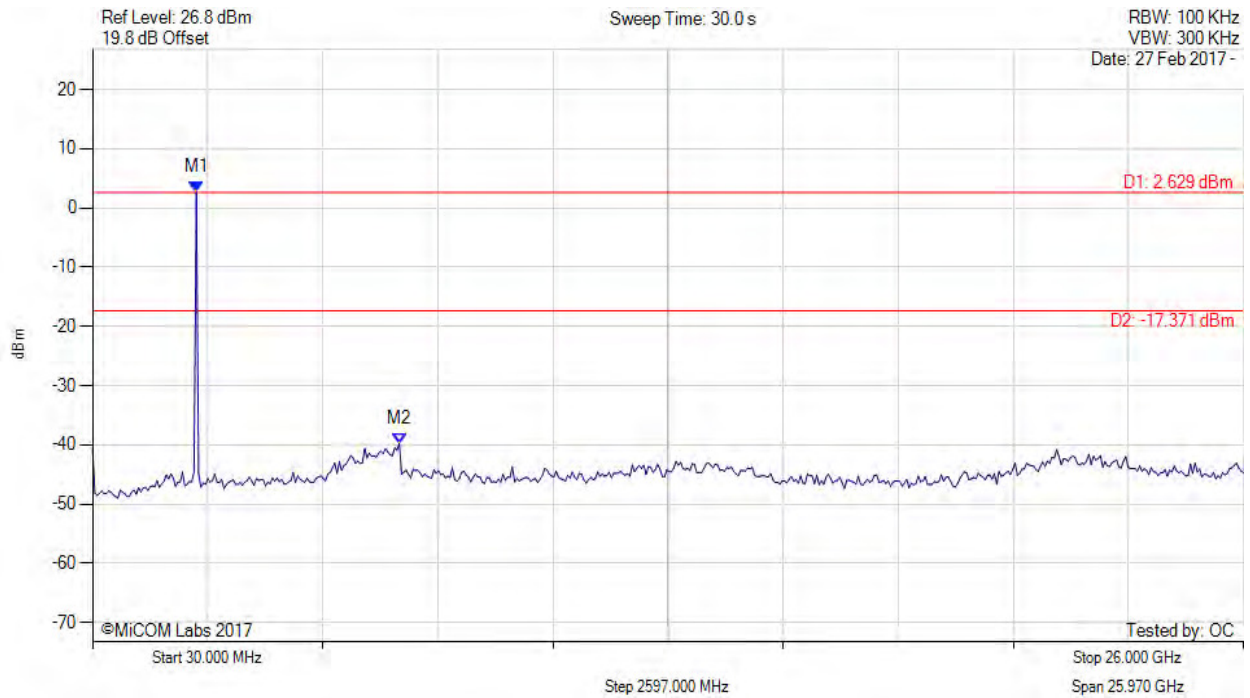

Analyzer Setup	Marker:Frequency:Amplitude	Test Results
Detector = MAX PEAK Sweep Count = 0 RF Atten (dB) = 20 Trace Mode = VIEW	M1 : 2371.984 MHz : 2.629 dBm M2 : 6951.864 MHz : -39.771 dBm	Limit: -17.37 dBm Margin: -22.40 dB

[back to matrix](#)

This test report may be reproduced in full only. The document may only be updated by MiCOM Labs personnel. All changes will be noted in the Document History section of the report.



Title: Hewlett Packard Enterprise APINR203, APINP203
To: FCC Part 15.247 (DTS) & IC RSS-247
Serial #: HPEN96-U2 Rev A Bluetooth BLE
Issue Date: 23rd March 2017
Page: 54 of 64

CONDUCTED SPURIOUS EMISSIONS - PEAK



Variant: GFSK, Channel: 2440.00 MHz, Chain a, Temp: 20, Voltage: 110 Vac

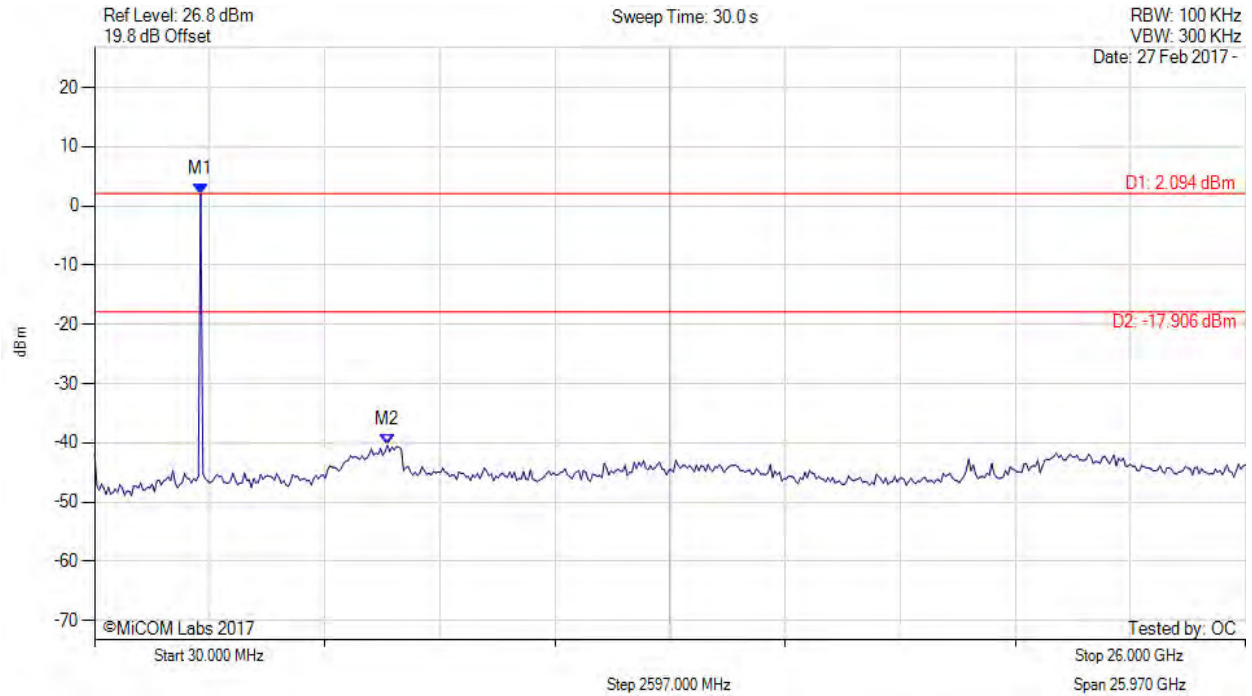

Analyzer Setup	Marker:Frequency:Amplitude	Test Results
Detector = MAX PEAK Sweep Count = 0 RF Atten (dB) = 20 Trace Mode = VIEWS	M1 : 2424.028 MHz : 2.094 dBm M2 : 6639.599 MHz : -40.375 dBm	Limit: -17.91 dBm Margin: -22.47 dB

[back to matrix](#)

This test report may be reproduced in full only. The document may only be updated by MiCOM Labs personnel. All changes will be noted in the Document History section of the report.



Title: Hewlett Packard Enterprise APINR203, APINP203
To: FCC Part 15.247 (DTS) & IC RSS-247
Serial #: HPEN96-U2 Rev A Bluetooth BLE
Issue Date: 23rd March 2017
Page: 55 of 64

CONDUCTED SPURIOUS EMISSIONS - PEAK



Variant: GFSK, Channel: 2480.00 MHz, Chain a, Temp: 20, Voltage: 110 Vac

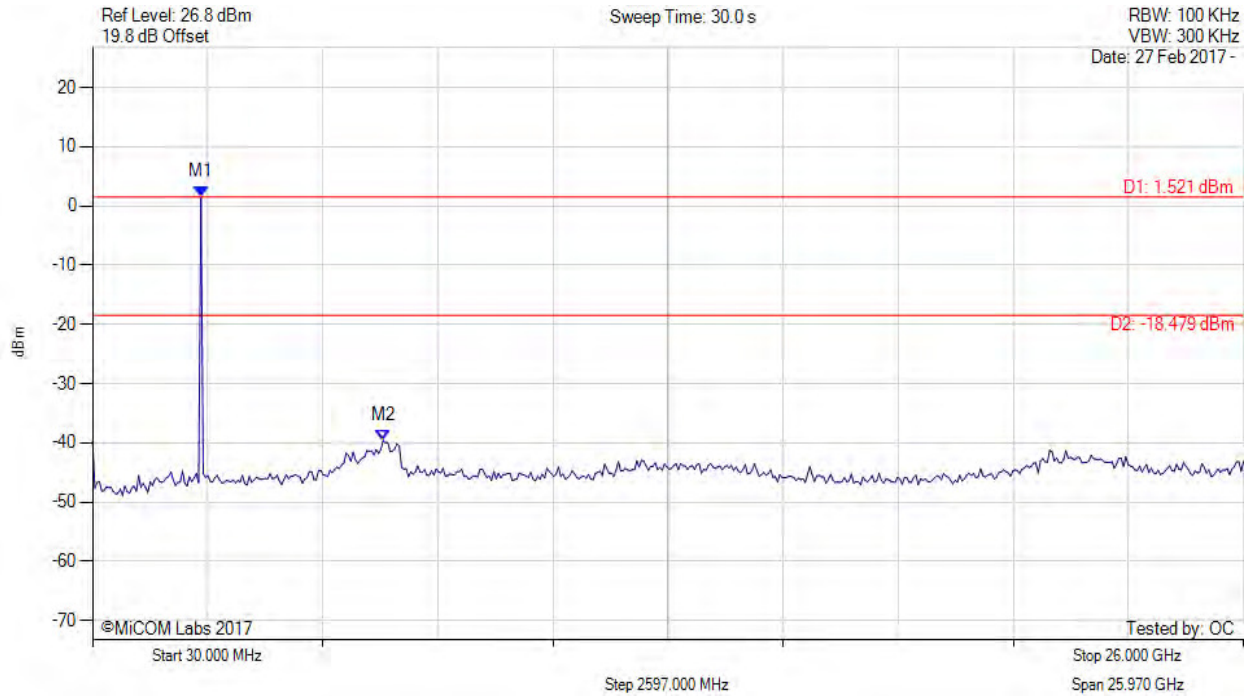

Analyzer Setup	Marker:Frequency:Amplitude	Test Results
Detector = MAX PEAK Sweep Count = 0 RF Atten (dB) = 20 Trace Mode = VIEW	M1 : 2476.072 MHz : 1.521 dBm M2 : 6587.555 MHz : -39.620 dBm	Limit: -18.48 dBm Margin: -21.14 dB

[back to matrix](#)

This test report may be reproduced in full only. The document may only be updated by MiCOM Labs personnel. All changes will be noted in the Document History section of the report.



A.3.2. Conducted Band-Edge Emissions



CONDUCTED LOW BAND-EDGE EMISSION - PEAK

Variant: GFSK, Channel: 2402.00 MHz, Chain a, Temp: 20, Voltage: 110 Vac

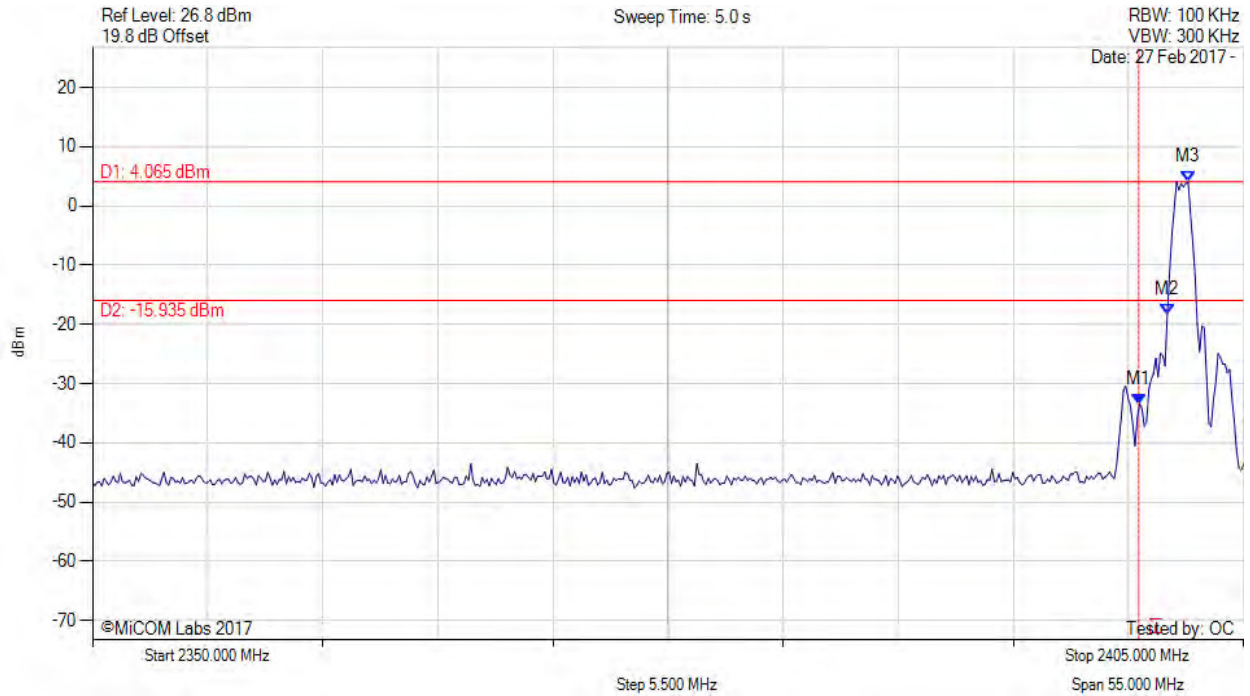

Analyzer Setup	Marker:Frequency:Amplitude	Test Results
Detector = MAX PEAK Sweep Count = 0 RF Atten (dB) = 20 Trace Mode = VIEW	M1 : 2400.000 MHz : -33.431 dBm M2 : 2401.363 MHz : -18.351 dBm M3 : 2402.355 MHz : 4.065 dBm	Channel Frequency: 2402.00 MHz

[back to matrix](#)

This test report may be reproduced in full only. The document may only be updated by MiCOM Labs personnel. All changes will be noted in the Document History section of the report.



Title: Hewlett Packard Enterprise APINR203, APINP203
To: FCC Part 15.247 (DTS) & IC RSS-247
Serial #: HPEN96-U2 Rev A Bluetooth BLE
Issue Date: 23rd March 2017
Page: 57 of 64

CONDUCTED HIGH BAND-EDGE EMISSION - PEAK



Variant: GFSK, Channel: 2480.00 MHz, Chain a, Temp: 20, Voltage: 110 Vac

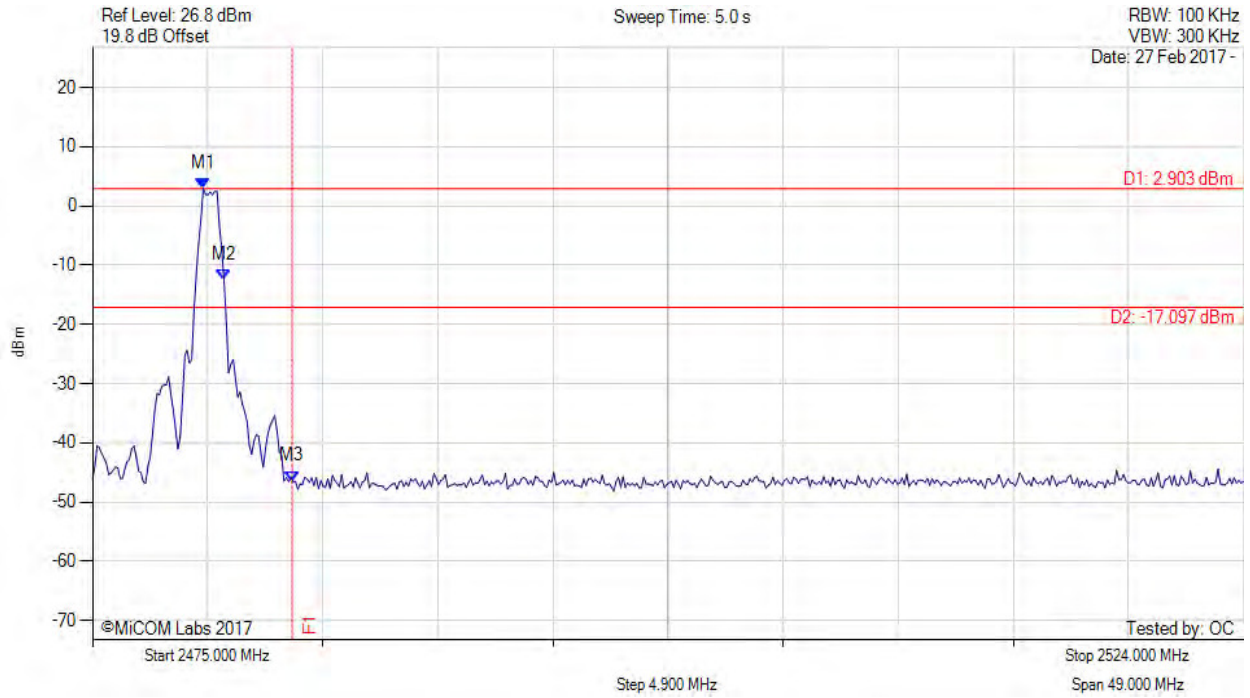

Analyzer Setup	Marker:Frequency:Amplitude	Test Results
Detector = MAX PEAK Sweep Count = 0 RF Atten (dB) = 20 Trace Mode = VIEW	M1 : 2479.713 MHz : 2.903 dBm M2 : 2480.597 MHz : -12.490 dBm M3 : 2483.500 MHz : -46.502 dBm	Channel Frequency: 2480.00 MHz

[back to matrix](#)

This test report may be reproduced in full only. The document may only be updated by MiCOM Labs personnel. All changes will be noted in the Document History section of the report.



Title: Hewlett Packard Enterprise APINR203, APINP203
To: FCC Part 15.247 (DTS) & IC RSS-247
Serial #: HPEN96-U2 Rev A Bluetooth BLE
Issue Date: 23rd March 2017
Page: 58 of 64

A.4. Radiated Emissions

A.4.1. Radiated TX Spurious & Restricted Band Emissions



TX SPURIOUS & RESTRICTED BAND EMISSIONS

Variant: GFSK, Test Freq: 2402.00 MHz, Antenna: HPE Metal Sheet, Power Setting: 4, Duty Cycle (%): 99

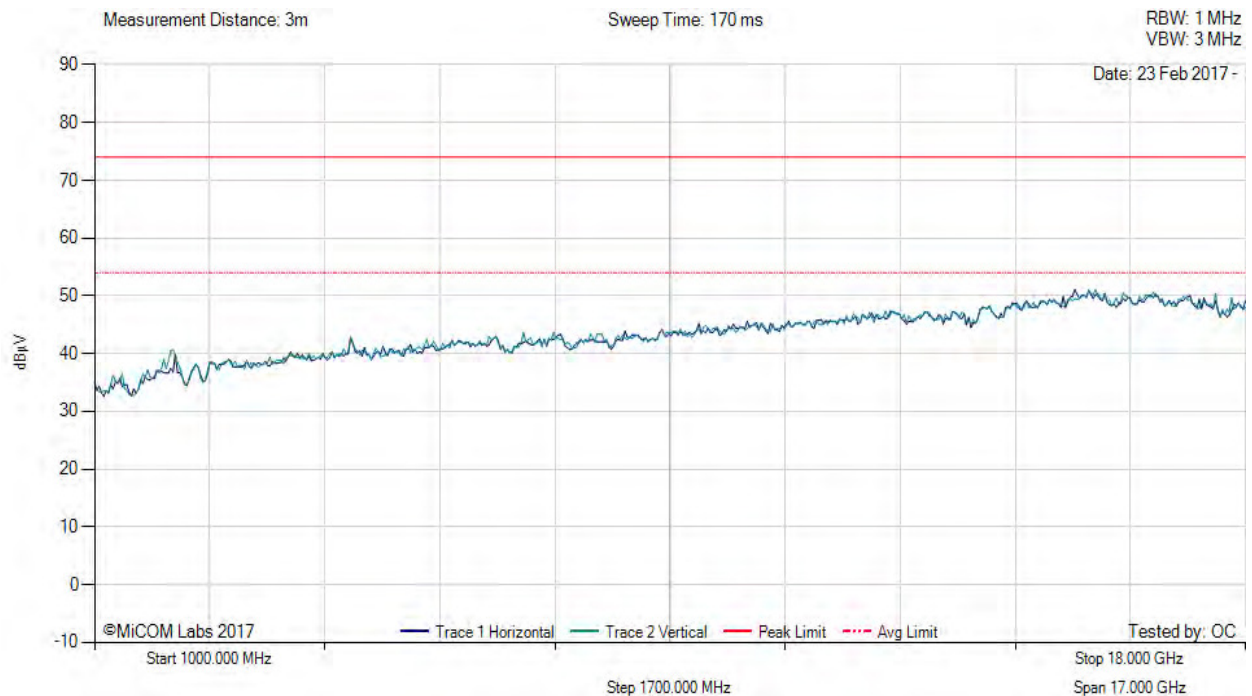

There are no emissions found within 6dB of the limit line.

Test Notes: EUT on non-conductive 150cm table powered by laptop, connected to laptop inside chamber.

[back to matrix](#)

This test report may be reproduced in full only. The document may only be updated by MiCOM Labs personnel. All changes will be noted in the Document History section of the report.



Title: Hewlett Packard Enterprise APINR203, APINP203
To: FCC Part 15.247 (DTS) & IC RSS-247
Serial #: HPEN96-U2 Rev A Bluetooth BLE
Issue Date: 23rd March 2017
Page: 59 of 64



TX SPURIOUS & RESTRICTED BAND EMISSIONS

Variant: GFSK, Test Freq: 2440.00 MHz, Antenna: HPE Metal Sheet, Power Setting: 4, Duty Cycle (%): 99

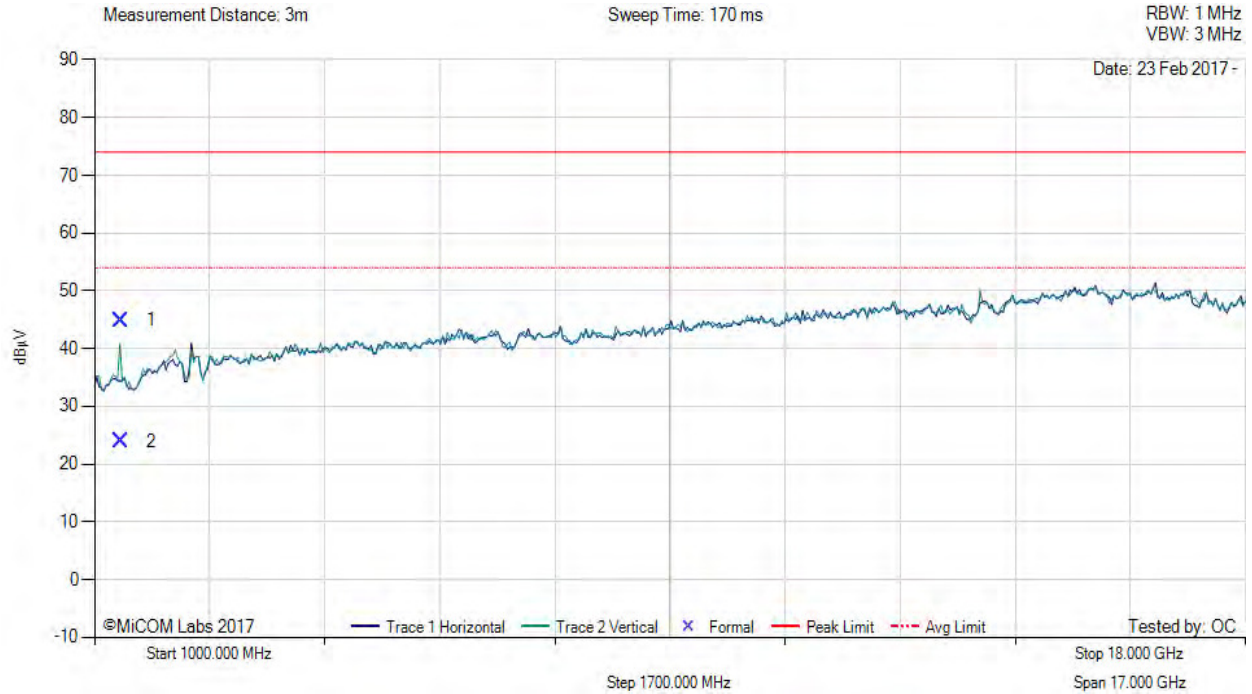

1000.00 - 18000.00 MHz												
Num	Frequency MHz	Raw dBµV	Cable Loss dB	AF dB	Level dBµV/m	Measurement Type	Pol	Hgt cm	Azt Deg	Limit dBµV/m	Margin dB	Pass /Fail
1	1394.49	58.17	2.25	-15.53	44.89	Max Peak	Vertical	106	283	74.0	-29.1	Pass
2	1394.49	37.15	2.25	-15.53	23.87	Max Avg	Vertical	106	283	54.0	-30.1	Pass

Test Notes: EUT on non-conductive 150cm table powered by laptop, connected to laptop inside chamber.

[back to matrix](#)

This test report may be reproduced in full only. The document may only be updated by MiCOM Labs personnel. All changes will be noted in the Document History section of the report.



Title: Hewlett Packard Enterprise APINR203, APINP203
To: FCC Part 15.247 (DTS) & IC RSS-247
Serial #: HPEN96-U2 Rev A Bluetooth BLE
Issue Date: 23rd March 2017
Page: 60 of 64



TX SPURIOUS & RESTRICTED BAND EMISSIONS

Variant: GFSK, Test Freq: 2480.00 MHz, Antenna: HPE Metal Sheet, Power Setting: 4, Duty Cycle (%): 99

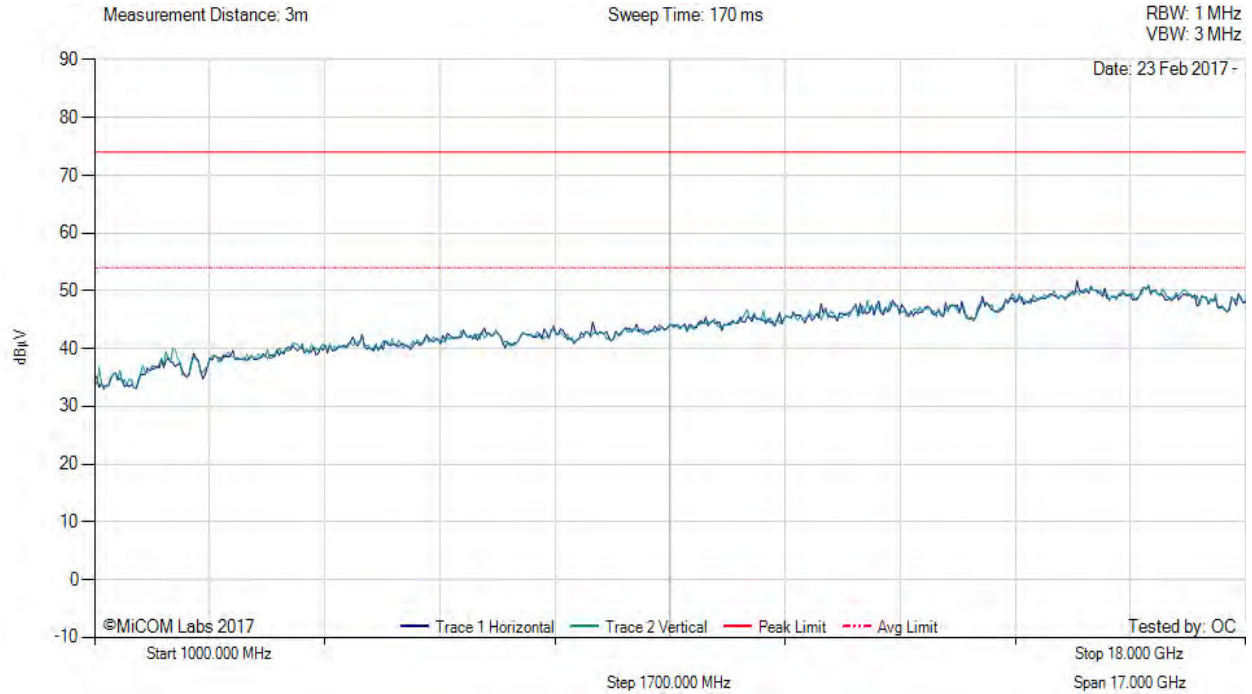

There are no emissions found within 6dB of the limit line.

Test Notes: EUT on non-conductive 150cm table powered by laptop, connected to laptop inside chamber.

[back to matrix](#)

This test report may be reproduced in full only. The document may only be updated by MiCOM Labs personnel. All changes will be noted in the Document History section of the report.



Title: Hewlett Packard Enterprise APINR203, APINP203
To: FCC Part 15.247 (DTS) & IC RSS-247
Serial #: HPEN96-U2 Rev A Bluetooth BLE
Issue Date: 23rd March 2017
Page: 61 of 64



TX Spurious & Restricted Band Emissions (0.03 - 1 GHz)

Variant: GFSK, Test Freq: 2480.00 MHz, Antenna: HPE Metal Sheet, Power Setting: 4, Duty Cycle (%): 99

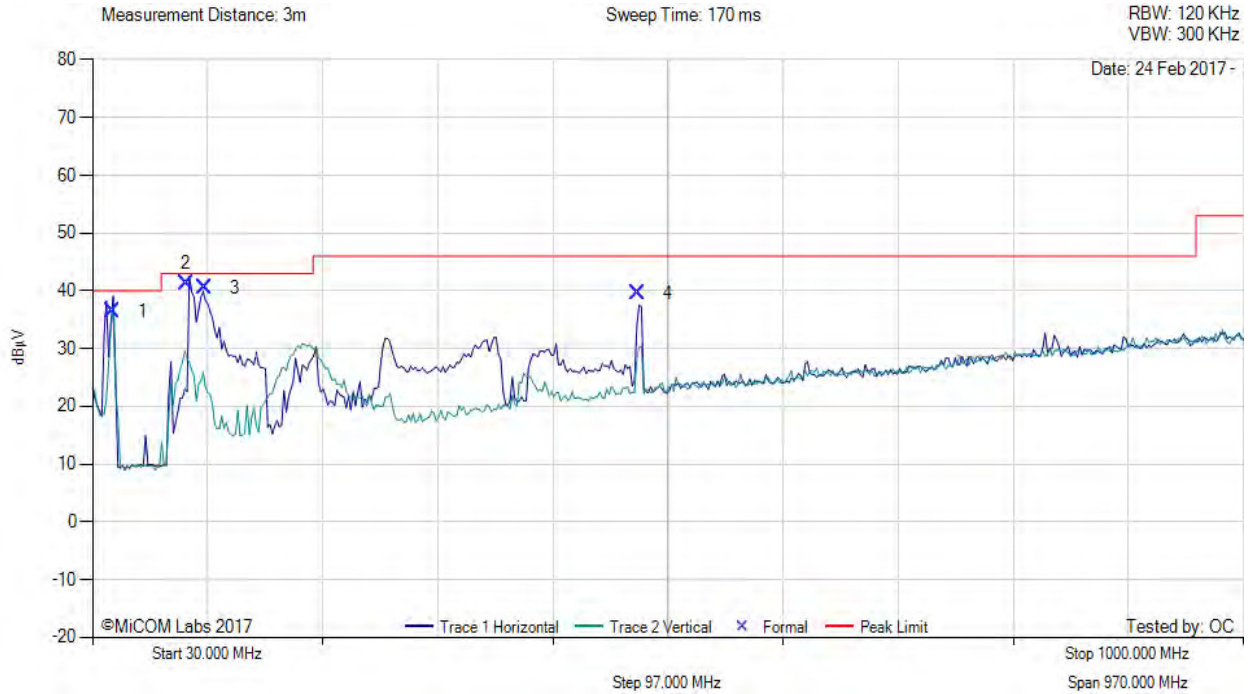

30.00 - 1000.00 MHz												
Num	Frequency MHz	Raw dBµV	Cable Loss dB	AF dB	Level dBµV/m	Measurement Type	Pol	Hgt cm	Azt Deg	Limit dBµV/m	Margin dB	Pass /Fail
1	46.73	54.77	3.55	-21.85	36.47	MaxQP(NRB)	Horizontal	373	178	40.0	-3.5	Pass
2	108.92	56.39	3.93	-19.02	41.30	MaxQP	Horizontal	174	195	43.0	-1.7	Pass
3	124.43	53.76	4.00	-17.27	40.49	MaxQP	Horizontal	246	37	43.0	-2.5	Pass
4	489.86	47.14	5.32	-12.88	39.58	MaxQP(NRB)	Horizontal	142	116	46.0	-6.4	Pass

Test Notes: EUT on non-conductive 80cm table powered by laptop, connected to laptop inside chamber.

[back to matrix](#)

This test report may be reproduced in full only. The document may only be updated by MiCOM Labs personnel. All changes will be noted in the Document History section of the report.



Title: Hewlett Packard Enterprise APINR203, APINP203
To: FCC Part 15.247 (DTS) & IC RSS-247
Serial #: HPEN96-U2 Rev A Bluetooth BLE
Issue Date: 23rd March 2017
Page: 62 of 64

A.4.2. Restricted Edge & Band-Edge Emissions

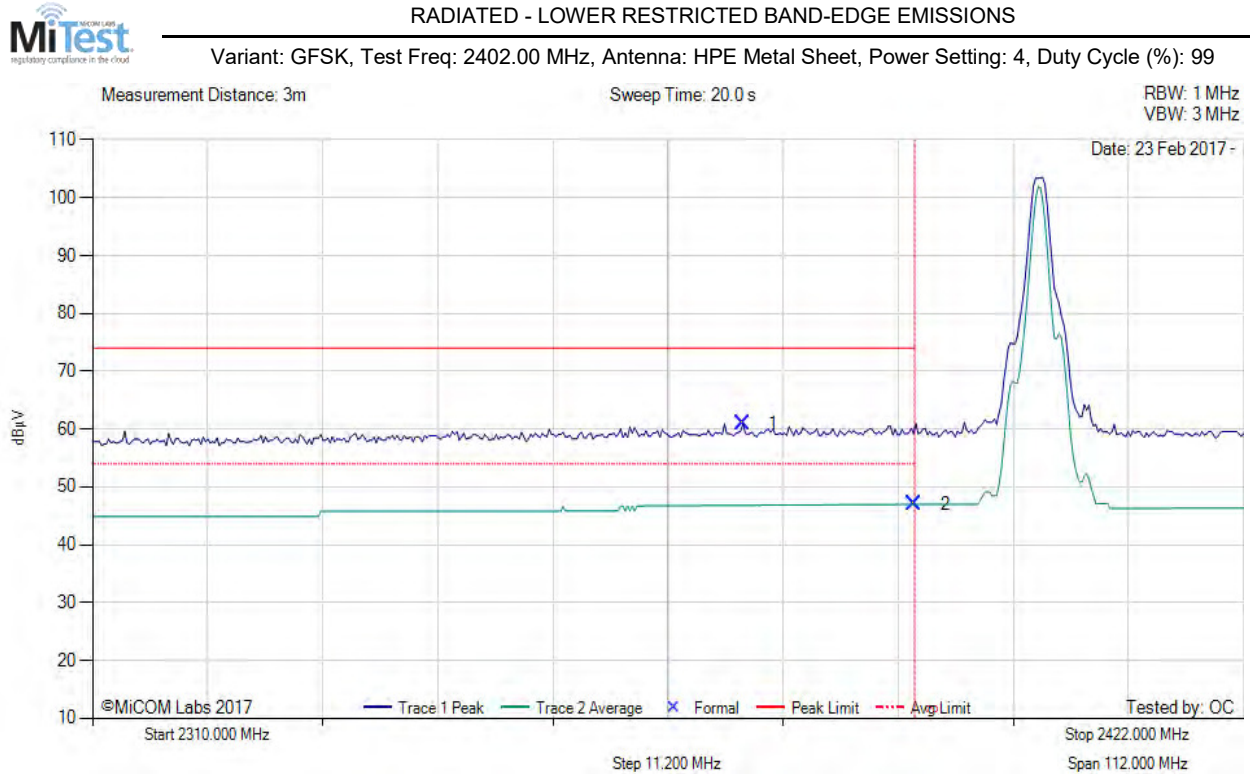

2310.00 - 2422.00 MHz												
Num	Frequency MHz	Raw dBµV	Cable Loss dB	AF dB	Level dBµV/m	Measurement Type	Pol	Hgt cm	Azt Deg	Limit dBµV/m	Margin dB	Pass /Fail
1	2373.29	26.37	2.71	31.89	60.97	Max Peak	Horizontal	140	352	74.0	-13.0	Pass
2	2390.00	12.26	2.69	32.04	46.99	Max Avg	Horizontal	140	352	54.0	-7.0	Pass
3	2390.00	--	--	--	--	Restricted-Band	--	--	--	--	--	--

Test Notes: EUT on non-conductive 150cm table powered by laptop, connected to laptop inside chamber.

[back to matrix](#)

This test report may be reproduced in full only. The document may only be updated by MiCOM Labs personnel. All changes will be noted in the Document History section of the report.



RADIATED - UPPER RESTRICTED BAND-EDGE EMISSIONS

Variant: GFSK, Test Freq: 2480.00 MHz, Antenna: HPE Metal Sheet, Power Setting: 4, Duty Cycle (%): 99

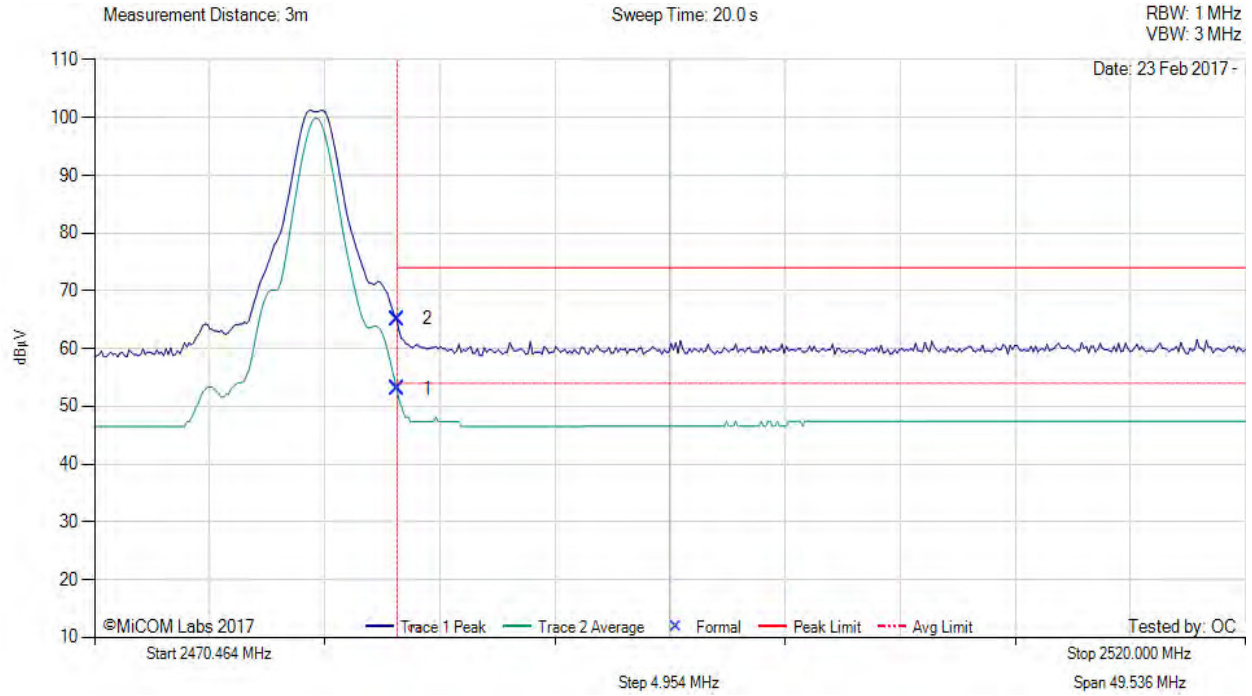

2470.46380450864.00 - 2520.00 MHz												
Num	Frequency MHz	Raw dBµV	Cable Loss dB	AF dB	Level dBµV/m	Measurement Type	PoI	Hgt cm	Azt Deg	Limit dBµV/m	Margin dB	Pass /Fail
1	2483.50	17.88	2.73	32.37	52.98	Max Avg	Horizontal	140	352	54.0	-1.0	Pass
2	2483.50	30.03	2.73	32.37	65.13	Max Peak	Horizontal	140	352	74.0	-8.9	Pass
3	2483.50	--	--	--	--	Restricted-Band	--	--	--	--	--	--

Test Notes: EUT on non-conductive 150cm table powered by laptop, connected to laptop inside chamber.

[back to matrix](#)

This test report may be reproduced in full only. The document may only be updated by MiCOM Labs personnel. All changes will be noted in the Document History section of the report.

DRAFT



575 Boulder Court
Pleasanton, California 94566, USA
Tel: +1 (925) 462 0304
Fax: +1 (925) 462 0306
www.micomlabs.com