

MEASUREMENT REPORT

FCC PART 15C / WLAN 802.11b/g/n/ax



FCC ID: Q9DAPINH503

Applicant: Hewlett Packard Enterprise Company

Application Type: Certification

Product: ACCESS POINT

Model No.: APINH503

Brand Name:  

FCC Classification: Digital Transmission System (DTS)

FCC Rule Part(s): Part 15 Subpart C (Section 15.247)

Test Procedure(s): ANSI C63.10-2013

Test Date: July 13 ~ August 06, 2020

Reviewed By:

Paddy Chen

(Paddy Chen)

Approved By:

Chenz Ker

(Chenz Ker)



Testing Laboratory
3261

The test results relate only to the samples tested.

This equipment has been shown to be capable of compliance with the applicable technical standards as indicated in the measurement report and was tested in accordance with the measurement procedures specified in ANSI C63.10-2013. Test results reported herein relate only to the item(s) tested.

The test report shall not be reproduced except in full without the written approval of MRT Technology (Taiwan) Co., Ltd.

Revision History

Report No.	Version	Description	Issue Date	Note
2007TW0002-U3	Rev. 01	Initial Report	08-06-2020	Valid

CONTENTS

Description	Page
General Information.....	5
1. INTRODUCTION.....	6
1.1. Scope.....	6
1.2. MRT Test Location	6
2. PRODUCT INFORMATION.....	7
2.1. Equipment Description	7
2.2. Product Specification Subjective to this Report	7
2.3. Working Frequencies for this report.....	8
2.4. Description of Available Antennas	8
2.5. Test Mode	9
2.6. Description of Antenna RF Port.....	9
2.7. Duty Cycle.....	9
2.8. EMI Suppression Device(s)/Modifications.....	11
2.9. Labeling Requirements.....	11
2.10. Description of Test Configuration and Software.....	11
2.11. Test Environment Condition.....	11
3. DESCRIPTION of TEST.....	12
3.1. Evaluation Procedure	12
3.2. AC Line Conducted Emissions	12
3.3. Radiated Emissions.....	13
4. ANTENNA REQUIREMENTS.....	14
5. TEST EQUIPMENT CALIBRATION DATE.....	15
6. MEASUREMENT UNCERTAINTY	16
7. TEST RESULT	17
7.1. Summary.....	17
7.2. 6dB Bandwidth Measurement.....	18
7.2.1. Test Limit	18
7.2.2. Test Procedure used.....	18
7.2.3. Test Setting.....	18
7.2.4. Test Setup	18
7.2.5. Test Result.....	19
7.3. Output Power Measurement.....	26
7.3.1. Test Limit	26

7.3.2.	Test Procedure Used	26
7.3.3.	Test Setting.....	26
7.3.4.	Test Setup	26
7.3.5.	Test Result.....	27
7.4.	Power Spectral Density Measurement.....	29
7.4.1.	Test Limit	29
7.4.2.	Test Procedure Used	29
7.4.3.	Test Setting.....	29
7.4.4.	Test Setup	30
7.4.5.	Test Result.....	31
7.5.	Conducted Band Edge and Out-of-Band Emissions	44
7.5.1.	Test Limit	44
7.5.2.	Test Procedure Used	44
7.5.3.	Test Setting.....	44
7.5.4.	Test Setup	45
7.5.5.	Test Result.....	46
7.6.	Radiated Spurious Emission Measurement	71
7.6.1.	Test Limit	71
7.6.2.	Test Procedure Used	71
7.6.3.	Test Setting.....	71
7.6.4.	Test Setup	73
7.6.5.	Test Result.....	74
7.7.	Radiated Restricted Band Edge Measurement.....	96
7.7.1.	Test Limit	96
7.7.2.	Test Procedure Used	97
7.7.3.	Test Setting.....	97
7.7.4.	Test Setup	98
7.7.5.	Test Result.....	99
7.8.	AC Conducted Emissions Measurement	211
7.8.1.	Test Limit	211
7.8.2.	Test Setup	211
7.8.3.	Test Result.....	212
8.	CONCLUSION	214
	Appendix A - Test Setup Photograph	215
	Appendix B - EUT Photograph.....	216

General Information

Applicant:	Hewlett Packard Enterprise Company
Applicant Address:	3333 Scott Blvd, Santa Clara, CA 95054, USA
Manufacturer:	Hewlett Packard Enterprise Company
Manufacturer Address:	3333 Scott Blvd, Santa Clara, CA 95054, USA
Test Site:	MRT Technology (Taiwan) Co., Ltd
Test Site Address:	No. 38, Fuxing Second Rd., Guishan Dist., Taoyuan City 333, Taiwan (R.O.C)

Test Facility / Accreditations

Measurements were performed at MRT Laboratory located in Fuxing Rd., Taoyuan, Taiwan (R.O.C)

- MRT facility is a FCC registered (Reg. No. 291082 and 153292) test facility with the site description report on file and is designated by the FCC as an Accredited Test Film.
- MRT facility is an IC registered (MRT Reg. No. 21723-1) test laboratory with the site description on file at Industry Canada.
- MRT Lab is accredited to ISO 17025 by the American Association for Laboratory Accreditation (TAF) under the American Association for Laboratory Accreditation Program (TAF Cert. No. 3261) in EMC, Telecommunications and Radio testing for FCC, Industry Canada, Taiwan, EU and TELEC Rules.

TAF certificate here



1. INTRODUCTION

1.1. Scope

Measurement and determination of electromagnetic emissions (EMC) of radio frequency devices including intentional and/or unintentional radiators for compliance with the technical rules and regulations of the Federal Communications Commission and the Innovation, Science and Economic Development Canada and Certification and Engineering Bureau.

1.2. MRT Test Location

The map below shows the location of the MRT LABORATORY, its proximity to the Taoyuan City. These measurement tests were conducted at the MRT Technology (Taiwan) Co., Ltd. Facility located at No.38, Fuxing 2nd Rd., Guishan Dist., Taoyuan City 33377, Taiwan (R.O.C).

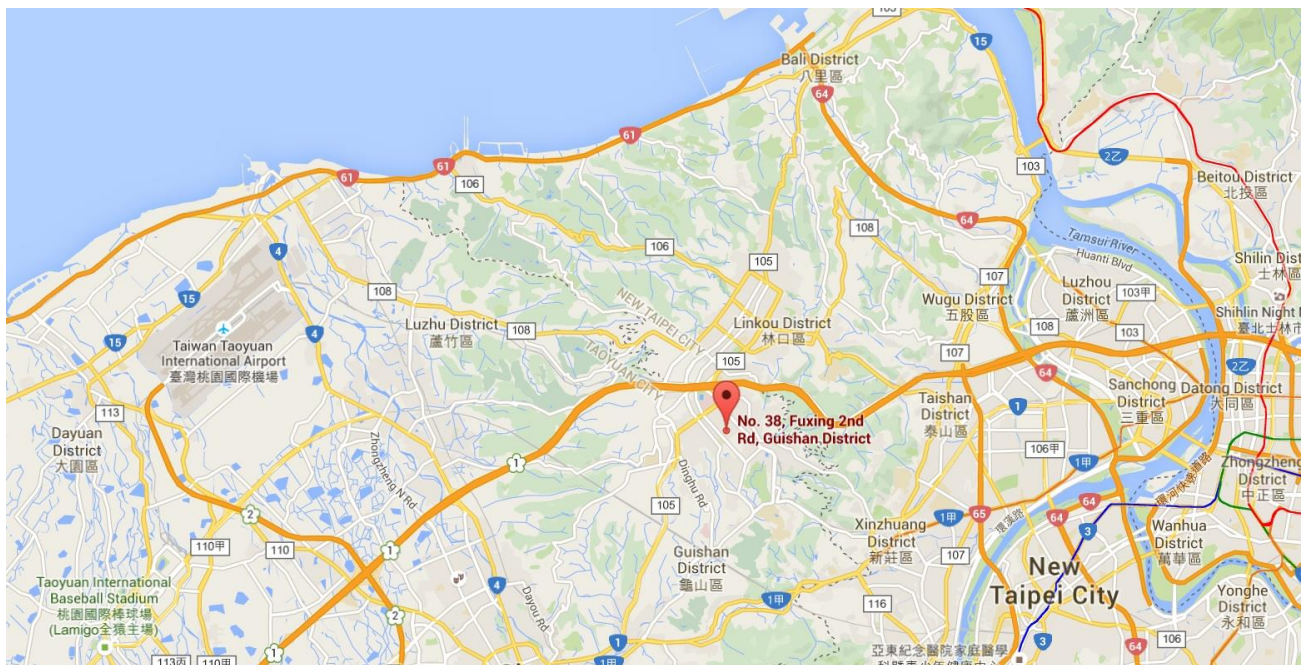

2. PRODUCT INFORMATION

2.1. Equipment Description

Product Name	ACCESS POINT
Model No.	APINH503
Serial No.	CNKHKSL02B
Wi-Fi Specification	802.11a/b/g/n/ac/ax
Bluetooth Specification	v5.0 single mode, BLE only
Zigbee Specification	802.15.4
Software Version	V1.84
Operating Temperature	0 ~ 40 °C
Power Type	AC Adapter or PoE input
Operating Environment	Indoor Use

2.2. Product Specification Subjective to this Report

Frequency Range	802.11b/g/n-HT20/ax-HE20: 2412 ~ 2462MHz 802.11n-HT40/ax-HE40: 2422 ~ 2452MHz
Channel Number	802.11b/g/n-HT20/ax-HE20: 11 802.11n-HT40/ax-HE40: 7
Type of Modulation	802.11b: DSSS 802.11g/n: OFDM 802.11ax: OFDMA
Data Rate	802.11b: 1/2/5.5/11Mbps 802.11g: 6/9/12/18/24/36/48/54Mbps 802.11n: up to 300Mbps 802.11ax: up to 574Mbps

Note: For other features of this EUT, test report will be issued separately.

2.3. Working Frequencies for this report

802.11b/g/n-HT20/ax-HE20

Channel	Frequency	Channel	Frequency	Channel	Frequency
01	2412 MHz	02	2417 MHz	03	2422 MHz
04	2427 MHz	05	2432 MHz	06	2437 MHz
07	2442 MHz	08	2447 MHz	09	2452 MHz
10	2457 MHz	11	2462 MHz	--	--

802.11n-HT40/ax-HE40

Channel	Frequency	Channel	Frequency	Channel	Frequency
03	2422 MHz	04	2427 MHz	05	2432 MHz
06	2437 MHz	07	2442 MHz	08	2447 MHz
09	2452 MHz	--	--	--	--

2.4. Description of Available Antennas

Antenna Type	Frequency Band (GHz)	Max Peak Gain (dBi)	BF Directional Gain (dBi)	CDD Directional Gain (dBi)	
				For Power	For PSD
Wi-Fi Internal Antenna (2.4GHz 2*2 MIMO, 5GHz 2*2 MIMO)					
PIFA	2.4	1.73	4.71	1.73	4.71
	5	5.04	8.05	5.04	8.05
Bluetooth / ZigBee Internal Antenna					
Monopole	2.4		2.49		

Note:

- The EUT supports Cyclic Delay Diversity (CDD) mode, and CDD signals are correlated. For CDD transmissions, directional gain is calculated as follows, $N_{ANT} = 2$, $N_{SS} = 1$. If all antennas have the same gain, G_{ANT} , Directional gain = $G_{ANT} + \text{Array Gain}$, where Array Gain is as follows.
 - For power spectral density (PSD) measurements on all devices,

$$\text{Array Gain} = 10 \log (N_{ANT} / N_{SS}) \text{ dB} = 3.01;$$
 - For power measurements on IEEE 802.11 devices,

$$\text{Array Gain} = 0 \text{ dB for } N_{ANT} \leq 4;$$
- The EUT also supports Beam Forming mode, and the Beam Forming support 802.11n/ac/ax, not include 802.11a/b/g. Directional gain = $G_{ANT} + \text{BF Gain}$, BF Gain was declared by the applicant.
- Antenna type and antenna gain are provided by the manufacturer.

2.5. Test Mode

Test Mode	Mode 1: Transmit by 802.11b (1Mbps)
	Mode 2: Transmit by 802.11g (6Mbps)
	Mode 3: Transmit by 802.11n-HT20 (MCS0)
	Mode 4: Transmit by 802.11n-HT40 (MCS0)
	Mode 5: Transmit by 802.11ax-HE20 (MCS0)
	Mode 6: Transmit by 802.11ax-HE40 (MCS0)

Note: 802.11n and 802.11ac have same modulation type and same power parameter, so we only show 802.11ac test data in report.

2.6. Description of Antenna RF Port

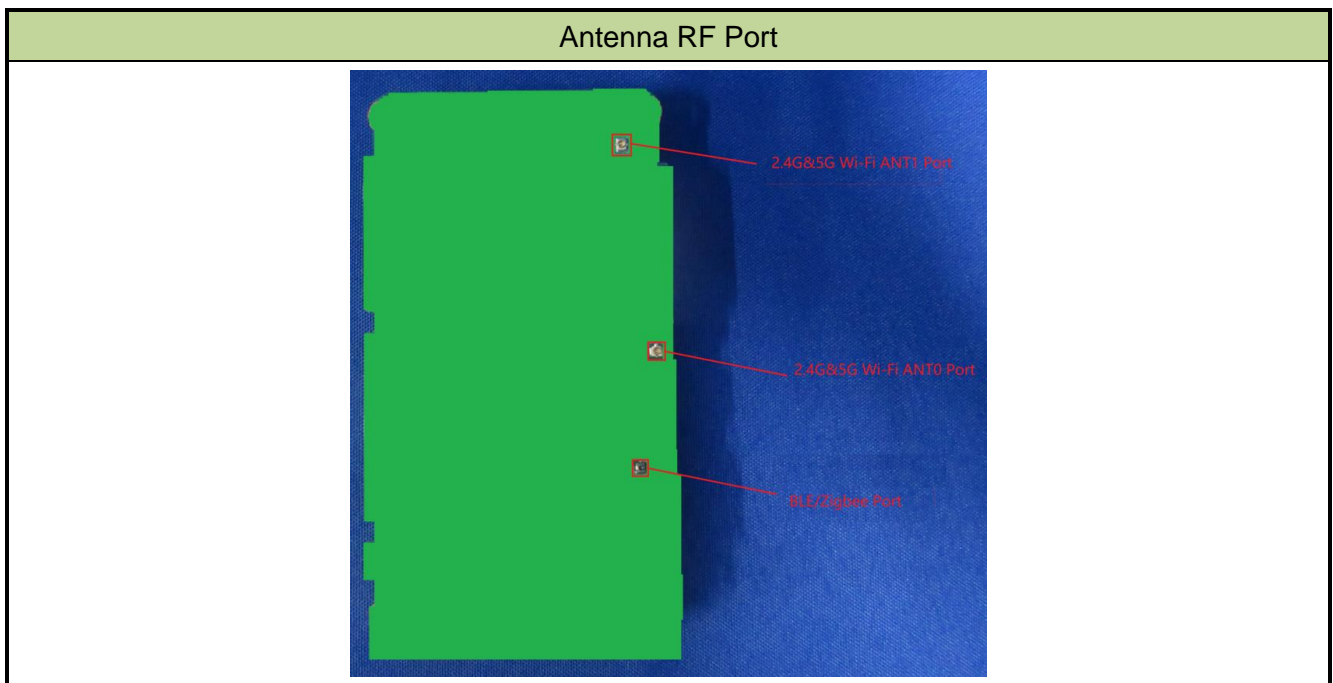

2.7. Duty Cycle

2.4GHz WLAN (DTS) operation is possible in 20MHz channel bandwidths. The maximum achievable duty cycles for all modes were determined based on measurements performed on a spectrum analyzer in zero-span mode with RBW = 8MHz, VBW = 50MHz. The RBW and VBW were both greater than 50/T, where T is the minimum transmission duration, and the number of sweep points across T was greater than 100. The duty cycles are as follows:

Test Mode	Duty Cycle	Test Mode	Duty Cycle
802.11b	94.87%	802.11n-HT40	90.03%
802.11g	94.48%	802.11ax-HE20	97.50%
802.11n-HT20	94.55%	802.11ax-HE40	95.85%

Duty Cycle (T = Transmission Duration)

802.11b (T = 12.39ms)

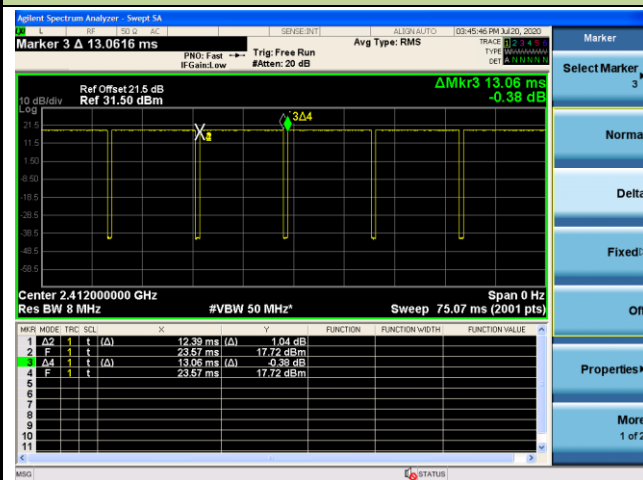

802.11g (T = 2.055ms)

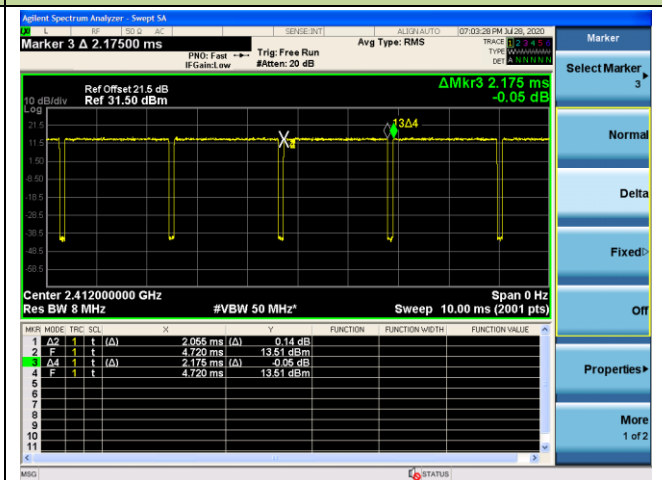

802.11n-HT20 (T = 1.910ms)

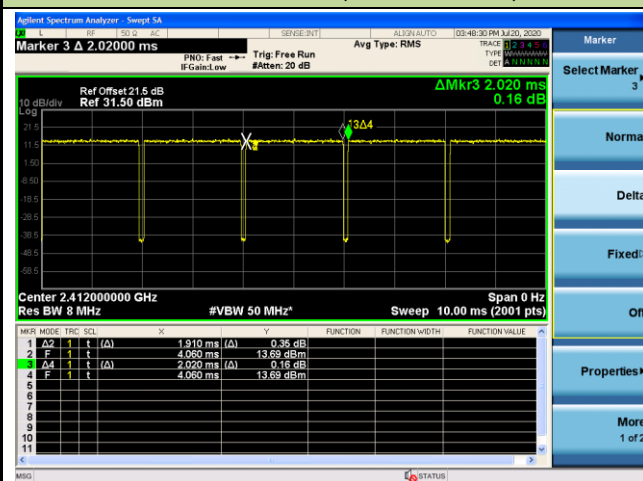

802.11n-HT40 (T = 939.9us)

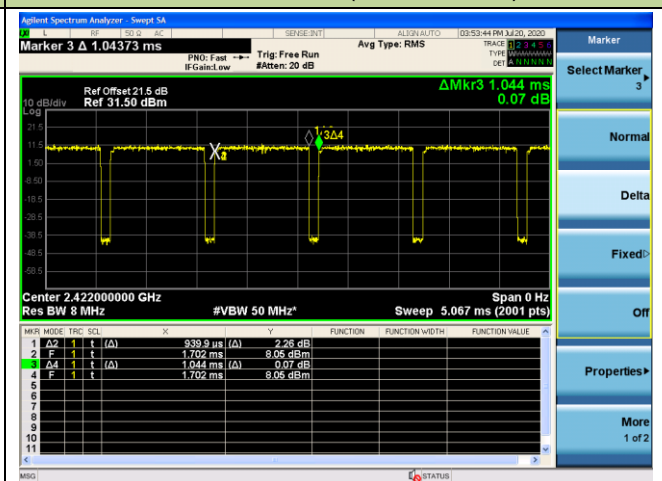

802.11ax-HE20 (T = 1.482ms)

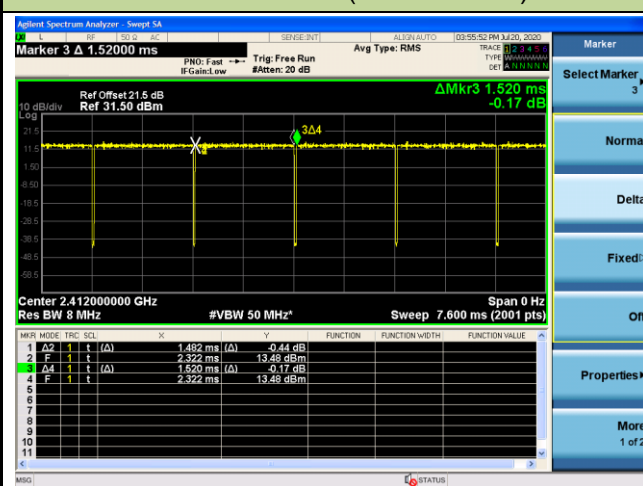

802.11ax-HE40 (T = 777.4us)

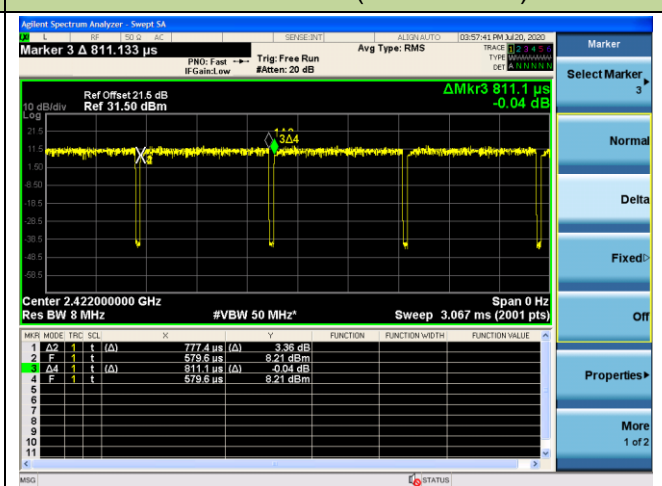

2.8. EMI Suppression Device(s)/Modifications

No EMI suppression device(s) were added and/or no modifications were made during testing.

2.9. Labeling Requirements

Per 2.1074 & 15.19; Docket 95-19

The label shall be permanently affixed at a conspicuous location on the device; instruction manual or pamphlet supplied to the user and be readily visible to the purchaser at the time of purchase. However, when the device is so small wherein placement of the label with specified statement is not practical, only the FCC ID must be displayed on the device per Section 15.19(a)(5). Please see attachment for FCC ID label and label location.

2.10. Description of Test Configuration and Software

The device was tested per the guidance ANSI C63.10: 2013 was used to reference the appropriate EUT setup for radiated emissions testing and AC line conducted testing.

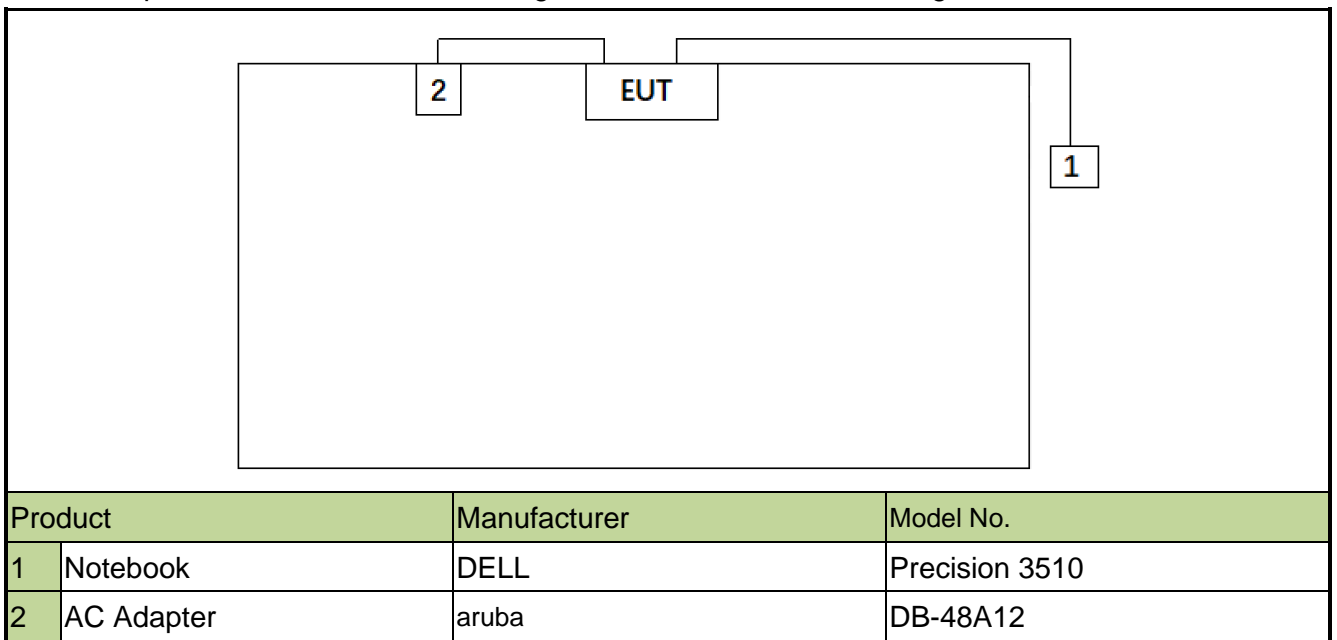

Note 1: The test utility software used during testing was “accessMTool”, and the version was “v3.1.0.5”.

Note 2: Detail power setting refer to operation description.

2.11. Test Environment Condition

Ambient Temperature	15°C~35°C
Relative Humidity	20%RH ~75%RH

3. DESCRIPTION of TEST

3.1. Evaluation Procedure

The measurement procedure described in the document titled “American National Standard of Procedures for Compliance Testing of Unlicensed Wireless Devices” (ANSI C63.10-2013) was used in the measurement.

3.2. AC Line Conducted Emissions

The line-conducted facility is located inside an 8'x4'x4' shielded enclosure. A 1m x 2m wooden table 80cm high is placed 40cm away from the vertical wall and 80cm away from the sidewall of the shielded room. Two 10kHz-30MHz, 50Ω/50uH Line-Impedance Stabilization Networks (LISNs) are bonded to the shielded room floor. Power to the LISNs is filtered by external high-current high-insertion loss power line filters. These filters attenuate ambient signal noise from entering the measurement lines. These filters are also bonded to the shielded enclosure.

The EUT is powered from one LISN and the support equipment is powered from the second LISN. All interconnecting cables more than 1 meter were shortened to a 1 meter length by non-inductive bundling (serpentine fashion) and draped over the back edge of the test table. All cables were at least 40cm above the horizontal reference ground-plane. Power cables for support equipment were routed down to the second LISN while ensuring that that cables were not draped over the second LISN.

Sufficient time for the EUT, support equipment, and test equipment was allowed in order for them to warm up to their normal operating condition. The RF output of the LISN was connected to the receiver and exploratory measurements were made to determine the frequencies producing the maximum emission from the EUT. The receiver was scanned from 150kHz to 30MHz. The detector function was set to peak mode for exploratory measurements while the bandwidth of the analyzer was set to 9kHz. The EUT, support equipment, and interconnecting cables were arranged and manipulated to maximize each emission. Each emission was also maximized by varying: power lines, the mode of operation or data exchange speed, or support equipment which determined the worst-case emission. Once the worst case emissions have been identified, the one EUT cable configuration/arrangement and mode of operation that produced these emissions are used for final measurements on the same test site. The analyzer is set to CISPR quasi-peak and average detectors with a 9kHz resolution bandwidth for final measurements.

An extension cord was used to connect to a single LISN which powered by EUT. The extension cord was calibrated with LISN, the impedance and insertion loss are compliance with the requirements as stated in ANSI C63.10-2013.

3.3. Radiated Emissions

The radiated test facilities consisted of an indoor 3 meter semi-anechoic chamber used for final measurements and exploratory measurements, when necessary. The measurement area is contained within the semi-anechoic chamber which is shielded from any ambient interference. For measurements above 1GHz absorbers are arranged on the floor between the turn table and the antenna mast in such a way so as to maximize the reduction of reflections. For measurements below 1GHz, the absorbers are removed. A MF Model 210SS turntable is used for radiated measurement. It is a continuously rotatable, remote controlled, metallic turntable and 2 meters (6.56 ft.) in diameter. The turn table is flush with the raised floor of the chamber in order to maintain its function as a ground plane. An 80cm high PVC support structure is placed on top of the turntable.

For all measurements, the spectrum was scanned through all EUT azimuths and from 1 to 4 meter receive antenna height using a broadband antenna from 30MHz up to the upper frequency shown in 15.33(b)(1) depending on the highest frequency generated or used in the device or on which the device operates or tunes. For frequencies above 1GHz, linearly polarized double ridge horn antennas were used. For frequencies below 30MHz, a calibrated loop antenna was used. When exploratory measurements were necessary, they were performed at 1 meter test distance inside the semi-anechoic chamber using broadband antennas, broadband amplifiers, and spectrum analyzers to determine the frequencies and modes producing the maximum emissions. Sufficient time for the EUT, support equipment, and test equipment was allowed in order for them to warm up to their normal operating condition. The test set-up for frequencies below 1GHz was placed on top of the 0.8 meter high, 1 x 1.5 meter table; and test set-up for frequencies 1-40GHz was placed on top of the 1.5 meter high, 1 x 1.5 meter table. The EUT, support equipment, and interconnecting cables were arranged and manipulated to maximize each emission. Appropriate precaution was taken to ensure that all emissions from the EUT were maximized and investigated. The system configuration, clock speed, mode of operation or video resolution, if applicable, turntable azimuth, and receive antenna height was noted for each frequency found.

Final measurements were made in the semi-anechoic chamber using calibrated, linearly polarized broadband and horn antennas. The test setup was configured to the setup that produced the worst case emissions. The spectrum analyzer was set to investigate all frequencies required for testing to compare the highest radiated disturbances with respect to the specified limits. The turntable containing the EUT was rotated through 360 degrees and the height of the receive antenna was varied 1 to 4 meters and stopped at the azimuth and height producing the maximum emission. Each emission was maximized by changing the orientation of the EUT through three orthogonal planes and changing the polarity of the receive antenna, which produced the worst-case emissions. According to 3dB Beam-Width of horn antenna, the horn antenna should be always directed to the EUT when rising height.

4. ANTENNA REQUIREMENTS

Excerpt from §15.203 of the FCC Rules/Regulations:

“An intentional radiator antenna shall be designed to ensure that no antenna other than that furnished by the responsible party can be used with the device. The use of a permanently attached antenna or of an antenna that uses a unique coupling to the intentional radiator shall be considered sufficient to comply with the provisions of this section.”

- The antenna of the device is **permanently attached**.
- There are no provisions for connection to an external antenna.

Conclusion:

The unit complies with the requirement of §15.203.

5. TEST EQUIPMENT CALIBRATION DATE

Conducted Emissions

Instrument	Manufacturer	Type No.	Asset No.	Cali. Interval	Cali. Due Date
Two-Line V-Network	R&S	ENV 216	MRTTWA00019	1 year	2021/3/26
Two-Line V-Network	R&S	ENV 216	MRTTWA00020	1 year	2021/4/24
8-Wire ISN (T8)	R&S	ENY81	MRTTWA00018	1 year	2021/5/25
EMI Test Receiver	R&S	ESR3	MRTTWA00045	1 year	2021/5/26
Temperature/Humidity Meter	TFA	35.1078.10.IT	MRTTWA00033	1 year	2021/5/28

Radiated Emissions

Instrument	Manufacturer	Type No.	Asset No.	Cali. Interval	Cali. Due Date
Active Loop Antenna	SCHWARZBECK	FMZB 1519B	MRTTWA00002	1 year	2021/4/27
Broadband TRILOG Antenna	SCHWARZBECK	VULB 9162	MRTTWA00001	1 year	2020/9/4
Broadband Horn antenna	SCHWARZBECK	BBHA 9120D	MRTTWA00003	1 year	2021/4/24
Breitband Horn antenna	SCHWARZBECK	BBHA 9170	MRTTWA00004	1 year	2021/4/24
Broadband Preamplifier	SCHWARZBECK	BBV 9718	MRTTWA00005	1 year	2021/4/24
Broadband Amplifier	SCHWARZBECK	BBV 9721	MRTTWA00006	1 year	2021/4/24
Signal Analyzer	R&S	FSV40	MRTTWA00007	1 year	2021/3/24
EMI Test Receiver	R&S	ESR3	MRTTWA00009	1 year	2021/3/25
EXA Signal Analyzer	KEYSIGHT	N9010A	MRTTWA00012	1 year	2020/10/2
Antenna Cable	HUBERSUHNER	SF106	MRTTWE00010	1 year	2021/6/16
Temperature/Humidity Meter	TFA	35.1078.10.IT	MRTTWA00032	1 year	2021/5/28

Conducted Test Equipment

Instrument	Manufacturer	Type No.	Asset No.	Cali. Interval	Cali. Due Date
X-Series USB Peak and Average Power Sensor	KEYSIGHT	U2021XA	MRTTWA00014	1 year	2021/4/24
EXA Signal Analyzer	KEYSIGHT	N9010A	MRTTWA00012	1 year	2020/10/2
EXA Signal Analyzer	KEYSIGHT	N9010B	MRTTWA00074	1 year	2021/7/11
Attenuator	WTI	218FS-20	MRTTWE00026	1 year	2021/05/30
Attenuator	WTI	218FS-10	MRTTWE00027	1 year	2021/05/30
Attenuator	WTI	218FS-06	MRTTWE00028	1 year	2021/05/30
Temperature/Humidity Meter	TFA	35.1078.10.IT	MRTTWA00033	1 year	2021/5/28

Software	Version	Function
v3	9.160520a	EMI Test Software

6. MEASUREMENT UNCERTAINTY

Where relevant, the following test uncertainty levels have been estimated for tests performed on the EUT as specified in CISPR 16-4-2. This uncertainty represents an expanded uncertainty expressed at approximately the 95% confidence level using a coverage factor of $k = 2$.

AC Conducted Emission Measurement
Measuring Uncertainty for a Level of Confidence of 95% ($U=2Uc(y)$): 150kHz~30MHz: 2.53dB
Radiated Emission Measurement
Measuring Uncertainty for a Level of Confidence of 95% ($U=2Uc(y)$): 9kHz ~ 1GHz: 4.25dB 1GHz ~ 40GHz: 4.45dB
Conducted Power
Measuring Uncertainty for a Level of Confidence of 95% ($U=2Uc(y)$): ± 0.84 dB
Conducted Spurious Emission
Measuring Uncertainty for a Level of Confidence of 95% ($U=2Uc(y)$): ± 2.65 dB
Occupied Bandwidth
Measuring Uncertainty for a Level of Confidence of 95% ($U=2Uc(y)$): 3.3%
Temp. / Humidity
Measuring Uncertainty for a Level of Confidence of 95% ($U=2Uc(y)$): $\pm 0.82^{\circ}\text{C} / \pm 3\%$

7. TEST RESULT

7.1. Summary

FCC Part Section(s)	Test Description	Test Limit	Test Condition	Test Result	Reference
15.247(a)(2)	6dB Bandwidth	$\geq 500\text{kHz}$	Conducted	Pass	Section 7.2
15.247(b)(3)	Output Power	$\leq 1\text{Watt}$		Pass	Section 7.3
15.247(e)	Power Spectral Density	$\leq 8\text{dBm} / 3\text{kHz}$		Pass	Section 7.4
15.247(d)	Band Edge / Out-of-Band Emissions	$\geq 30\text{dBc}$ (Average)		Pass	Section 7.5
15.205 15.209	General Field Strength Limits (Restricted Bands and Radiated Emission Limits)	Emissions in restricted bands must meet the radiated limits detailed in 15.209	Radiated	Pass	Section 7.6 & 7.7
15.207	AC Conducted Emissions 150kHz - 30MHz	$< \text{FCC } 15.207$ limits	Line Conducted	Pass	Section 7.8

Notes:

- 1) The analyzer plots shown in this section were all taken with a correction table loaded into the analyzer. The correction table was used to account for the losses of the cables and attenuators used as part of the system to connect the EUT to the analyzer at all frequencies of interest.
- 2) All modes of operation and data rates were investigated. For radiated emission test, every axis (X, Y, Z) was also verified. The test results shown in the following sections represent the worst case emissions.

7.2. 6dB Bandwidth Measurement

7.2.1. Test Limit

The minimum 6dB bandwidth shall be at least 500 kHz.

7.2.2. Test Procedure used

ANSI C63.10-2013 - Section 11.8

7.2.3. Test Setting

1. The Spectrum's automatic bandwidth measurement capability was used to perform the 6dB bandwidth measurement. The "X" dB bandwidth parameter was set to $X = 6$. The bandwidth measurement was not influenced by any intermediate power nulls in the fundamental emission.
2. Set RBW = 100 kHz
3. VBW $\geq 3 \times$ RBW
4. Detector = Peak
5. Trace mode = Max hold
6. Sweep = Auto couple
7. Allow the trace was allowed to stabilize

7.2.4. Test Setup

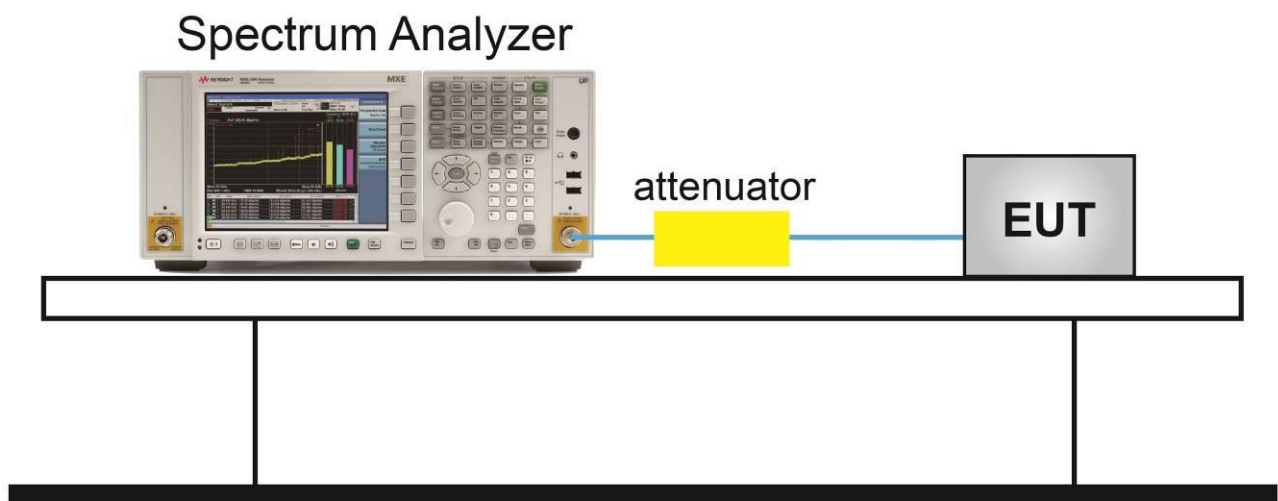

7.2.5. Test Result

Product	ACCESS POINT	Test Date	2020/07/20
Test Engineer	Eric Lin	Test Site	SR2
Test Item	6dB Bandwidth		

Test Mode	Data Rate / MCS	Channel No.	Frequency (MHz)	6dB Bandwidth (MHz)	Limit (MHz)	Result
Ant 0 / Ant 0 + 1						
802.11b	1Mbps	01	2412	7.09	≥ 0.5	Pass
802.11b	1Mbps	06	2437	7.08	≥ 0.5	Pass
802.11b	1Mbps	11	2462	7.07	≥ 0.5	Pass
802.11g	6Mbps	01	2412	16.38	≥ 0.5	Pass
802.11g	6Mbps	06	2437	16.42	≥ 0.5	Pass
802.11g	6Mbps	11	2462	16.38	≥ 0.5	Pass
802.11n-HT20	MCS0	01	2412	17.63	≥ 0.5	Pass
802.11n-HT20	MCS0	06	2437	17.63	≥ 0.5	Pass
802.11n-HT20	MCS0	11	2462	17.61	≥ 0.5	Pass
802.11n-HT40	MCS0	03	2422	36.36	≥ 0.5	Pass
802.11n-HT40	MCS0	06	2437	36.39	≥ 0.5	Pass
802.11n-HT40	MCS0	09	2452	36.11	≥ 0.5	Pass
802.11ax-HE20	MCS0	01	2412	18.99	≥ 0.5	Pass
802.11ax-HE20	MCS0	06	2437	19.01	≥ 0.5	Pass
802.11ax-HE20	MCS0	11	2462	18.98	≥ 0.5	Pass
802.11ax-HE40	MCS0	03	2422	37.11	≥ 0.5	Pass
802.11ax-HE40	MCS0	06	2437	37.54	≥ 0.5	Pass
802.11ax-HE40	MCS0	09	2452	37.10	≥ 0.5	Pass

802.11b 6dB Bandwidth - Ant 0 / Ant 0 + 1

Channel 01 (2412MHz)

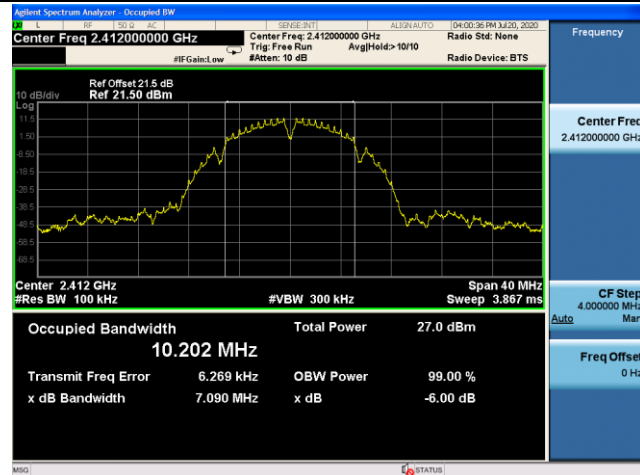

Channel 06 (2437MHz)

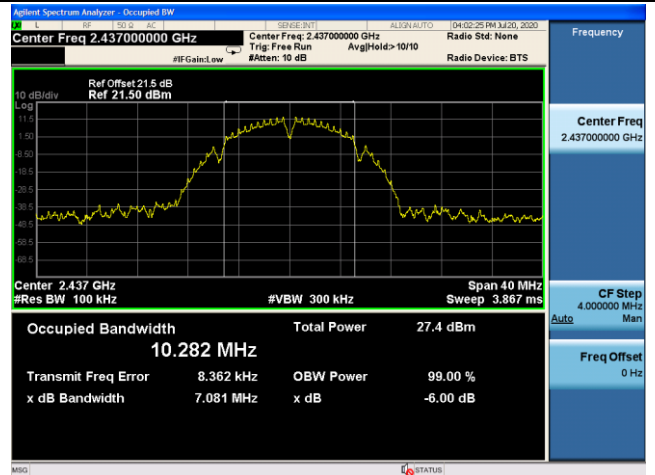

Channel 11 (2462MHz)

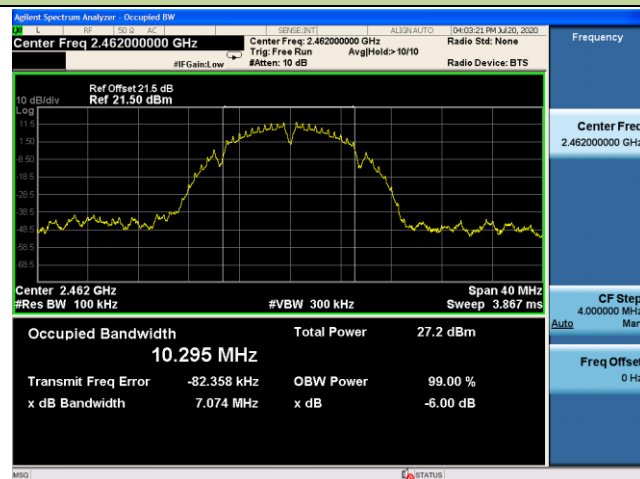

802.11g 6dB Bandwidth - Ant 0 / Ant 0 + 1

Channel 01 (2412MHz)

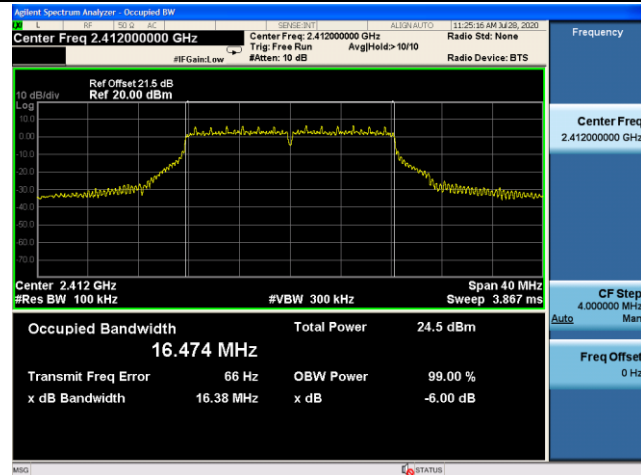

Channel 06 (2437MHz)

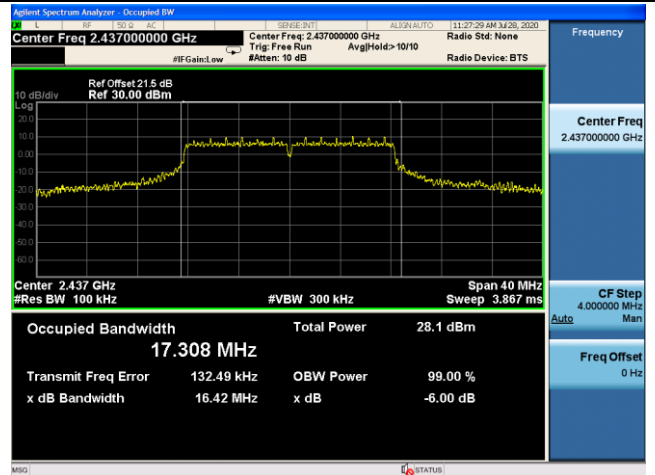

Channel 11 (2462MHz)

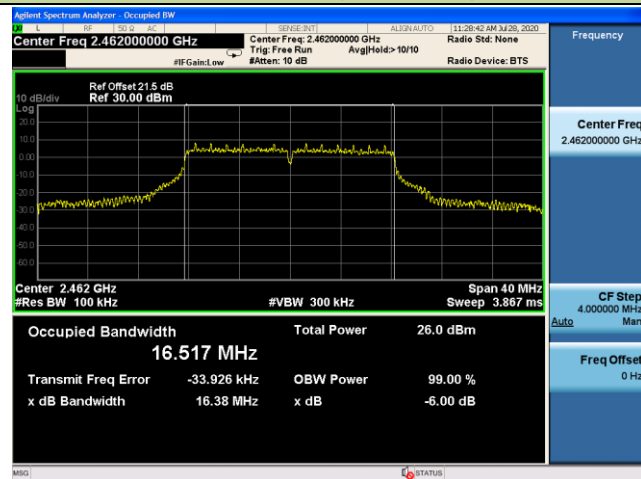

802.11n-HT20 6dB Bandwidth - Ant 0 / Ant 0 + 1

Channel 01 (2412MHz)

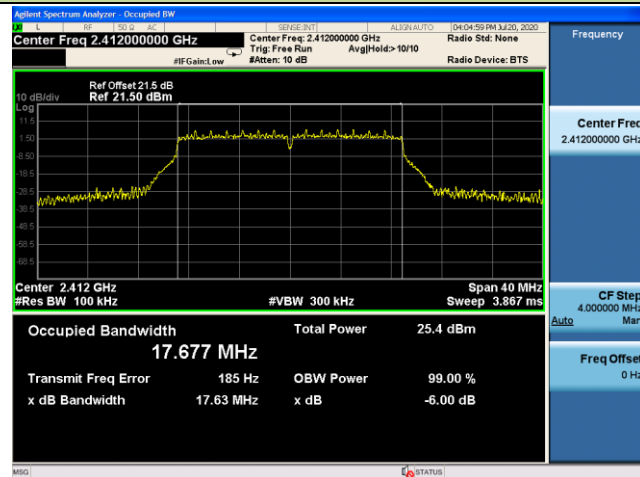

Channel 06 (2437MHz)

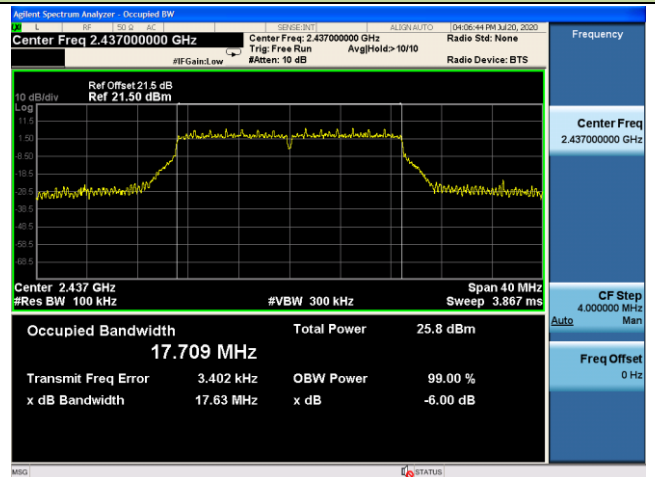

Channel 11 (2462MHz)

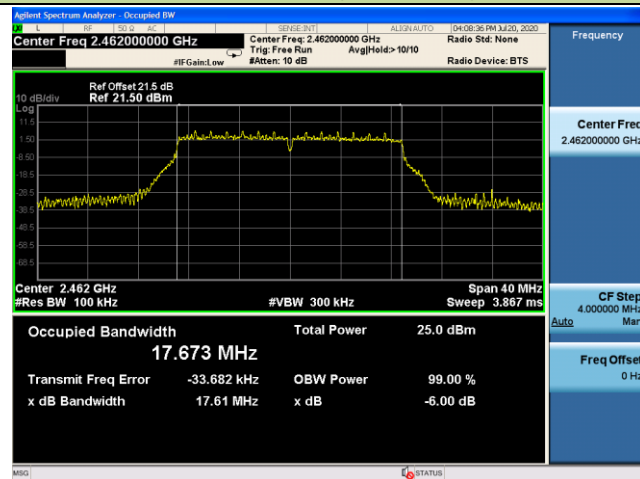

802.11n-HT40 6dB Bandwidth - Ant 0 / Ant 0 + 1

Channel 03 (2422MHz)

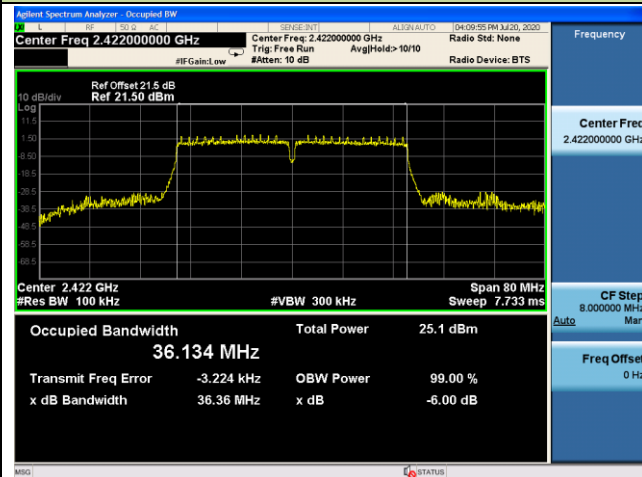

Channel 06 (2437MHz)

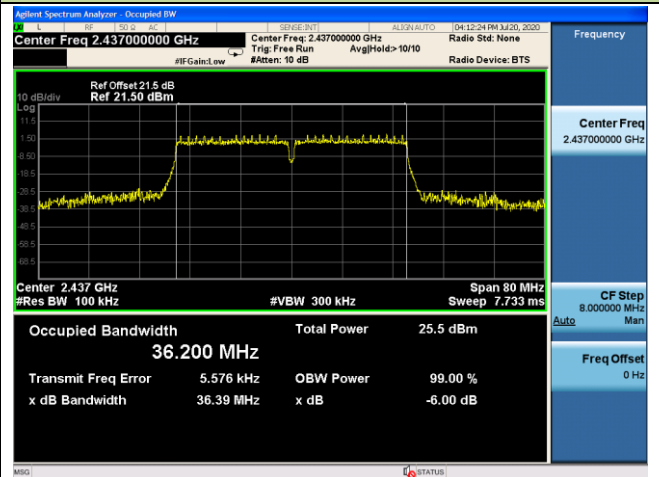

Channel 09 (2452MHz)

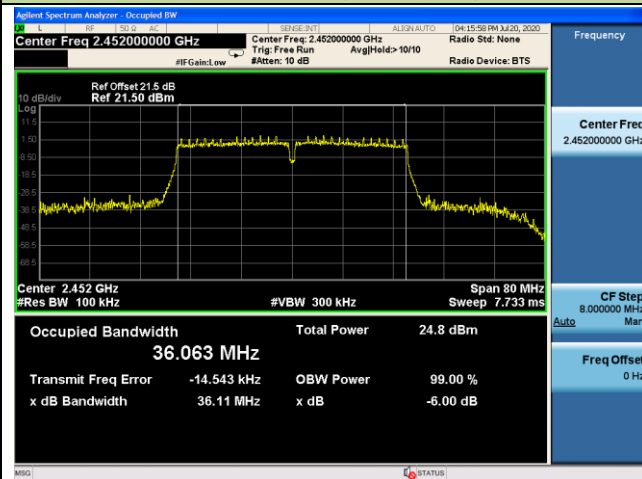

802.11ax-HE20 6dB Bandwidth - Ant 0 / Ant 0 + 1

Channel 01 (2412MHz)

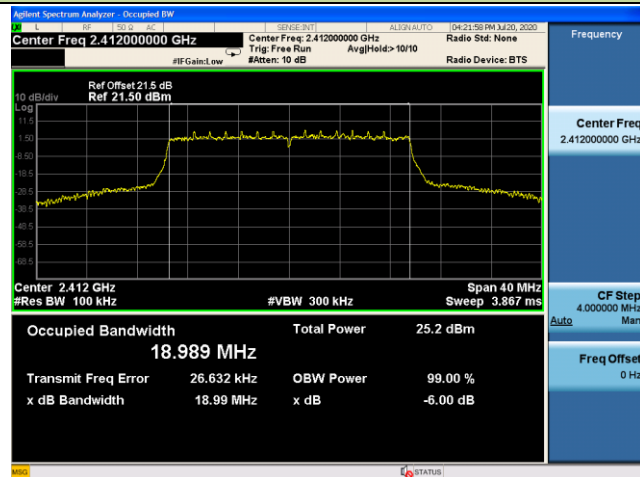

Channel 06 (2437MHz)

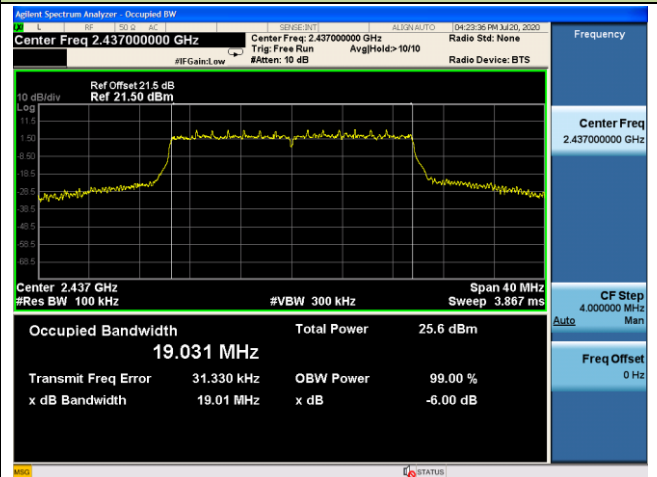

Channel 11 (2462MHz)

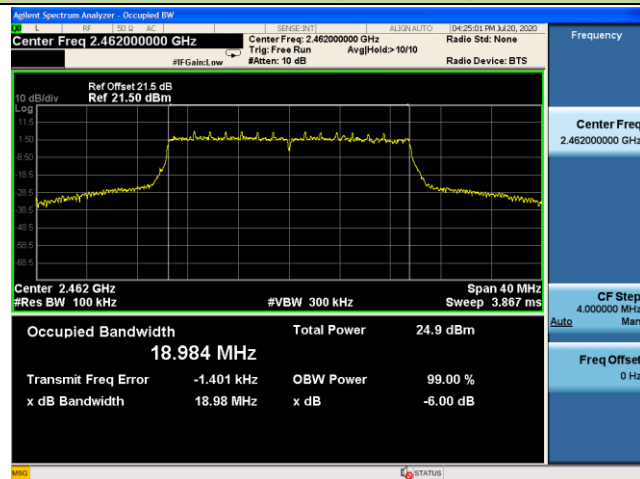

802.11ax-HE40 6dB Bandwidth - Ant 0 / Ant 0 + 1

Channel 03 (2422MHz)

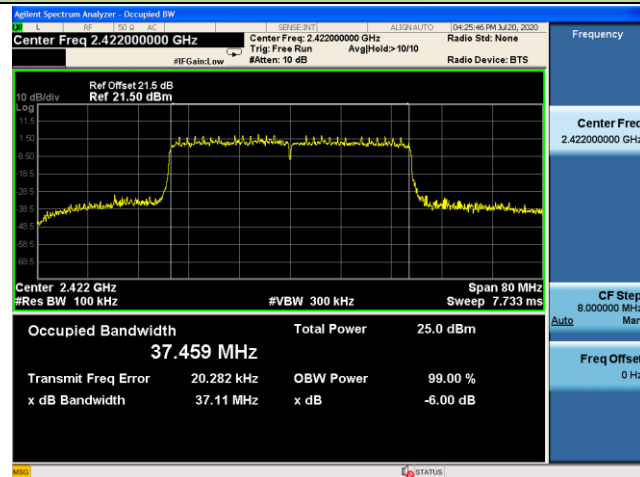

Channel 06 (2437MHz)

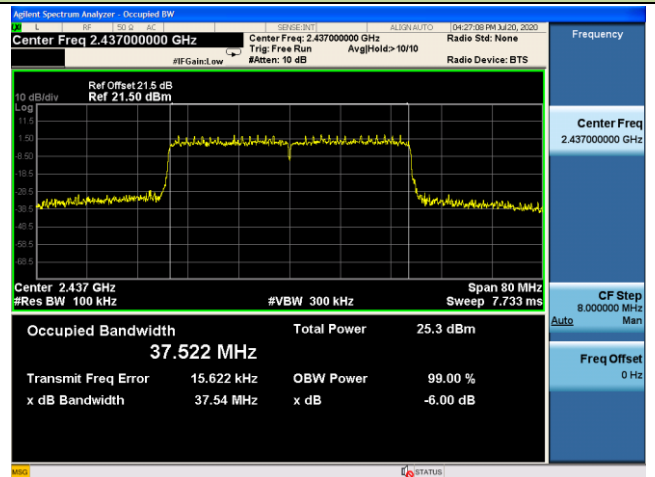

Channel 09 (2452MHz)

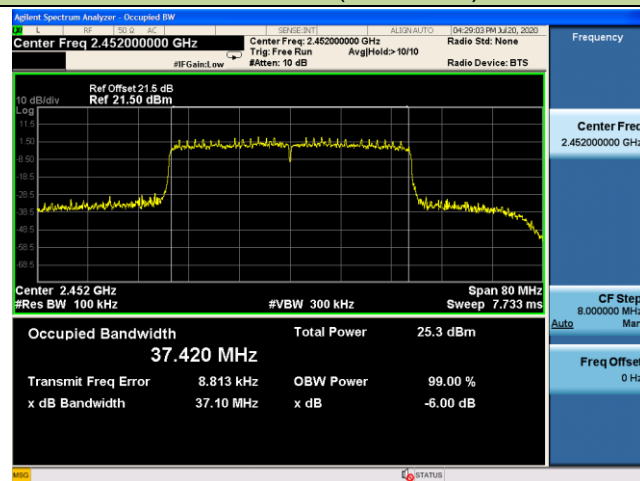

7.3. Output Power Measurement

7.3.1. Test Limit

The maximum conducted output power shall not exceed 1 Watt (30dBm).

7.3.2. Test Procedure Used

ANSI C63.10-2013 - Section 11.9.2.3.2

7.3.3. Test Setting

Method AVGPM-G (Measurement using a gated RF average-reading power meter)

Measurements may be performed using a wideband gated RF power meter provided that the gate parameters are adjusted such that the power is measured only when the EUT is transmitting at its maximum power control level. Since this measurement is made only during the ON time of the transmitter, no duty cycle correction is required.

7.3.4. Test Setup

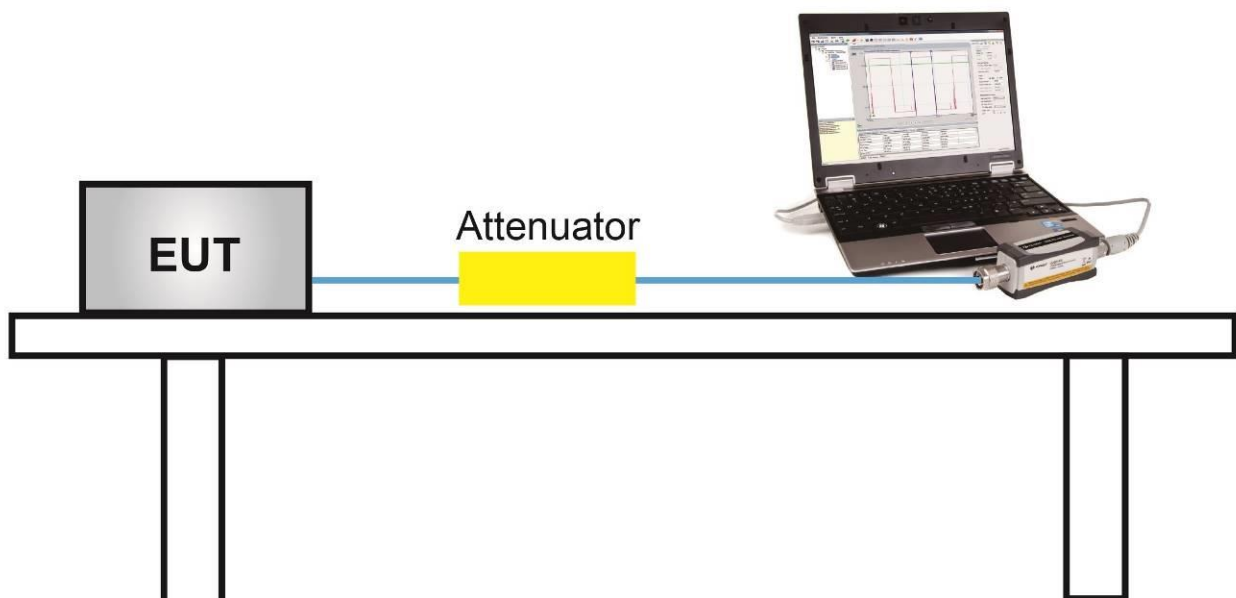

7.3.5. Test Result

Power output test was verified over all data rates of each mode shown as below table, and then choose the maximum power output (gray marker) for final test of each channel.

For Ant 0 / Ant 0 + 1 port:

Test Mode	Bandwidth (MHz)	Channel No.	Frequency (MHz)	Data Rate/ MCS	Average Power (dBm)
802.11b	20	06	2437	1Mbps	21.23
				5.5Mbps	21.15
				11Mbps	21.04
802.11g	20	06	2437	6Mbps	20.89
				24Mbps	20.81
				54Mbps	20.74
802.11n	20	06	2437	MCS0	21.47
				MCS3	21.35
				MCS7	21.26
802.11n	40	06	2437	MCS0	18.55
				MCS3	18.46
				MCS7	18.40
802.11ax-HE	20	06	2437	MCS0	21.37
				MCS5	21.30
				MCS11	21.20
802.11ax-HE	40	06	2437	MCS0	17.84
				MCS5	17.74
				MCS11	17.69

Product	ACCESS POINT	Test Engineer	Eric Lin
Test Site	SR2	Test Date	2020/07/20
Test Item	Output Power		

Test Mode	Data Rate/ MCS	Channel No.	Freq. (MHz)	Ant 0 Average Power (dBm)	Ant 1 Average Power (dBm)	Total Average Power (dBm)	Limit (dBm)	Result
11b	1Mbps	01	2412	21.16	21.30	24.24	≤ 30.00	Pass
11b	1Mbps	06	2437	21.23	21.45	24.35	≤ 30.00	Pass
11b	1Mbps	11	2462	21.15	21.42	24.30	≤ 30.00	Pass
11g	6Mbps	01	2412	17.06	17.55	20.32	≤ 30.00	Pass
11g	6Mbps	02	2417	19.41	19.65	22.54	≤ 30.00	Pass
11g	6Mbps	06	2437	20.89	21.28	24.10	≤ 30.00	Pass
11g	6Mbps	10	2457	19.28	19.78	22.55	≤ 30.00	Pass
11g	6Mbps	11	2462	18.98	19.09	22.05	≤ 30.00	Pass
11n-HT20	MCS0	01	2412	18.04	17.82	20.94	≤ 30.00	Pass
11n-HT20	MCS0	02	2417	19.02	19.11	22.08	≤ 30.00	Pass
11n-HT20	MCS0	06	2437	21.47	20.79	24.15	≤ 30.00	Pass
11n-HT20	MCS0	10	2457	19.14	19.20	22.18	≤ 30.00	Pass
11n-HT20	MCS0	11	2462	19.33	18.56	21.97	≤ 30.00	Pass
11n-HT40	MCS0	03	2422	18.27	17.77	21.04	≤ 30.00	Pass
11n-HT40	MCS0	04	2427	17.61	17.40	20.52	≤ 30.00	Pass
11n-HT40	MCS0	06	2437	18.55	18.70	21.64	≤ 30.00	Pass
11n-HT40	MCS0	08	2447	17.57	17.48	20.54	≤ 30.00	Pass
11n-HT40	MCS0	09	2452	17.12	17.18	20.16	≤ 30.00	Pass
11ax-HE20	MCS0	01	2412	17.31	17.67	20.50	≤ 30.00	Pass
11ax-HE20	MCS0	02	2417	18.11	18.81	21.48	≤ 30.00	Pass
11ax-HE20	MCS0	06	2437	21.37	21.06	24.23	≤ 30.00	Pass
11ax-HE20	MCS0	10	2457	18.95	19.48	22.23	≤ 30.00	Pass
11ax-HE20	MCS0	11	2462	17.09	17.76	20.45	≤ 30.00	Pass
11ax-HE40	MCS0	03	2422	17.92	17.70	20.82	≤ 30.00	Pass
11ax-HE40	MCS0	04	2427	16.70	17.38	20.06	≤ 30.00	Pass
11ax-HE40	MCS0	06	2437	17.84	18.00	20.93	≤ 30.00	Pass
11ax-HE40	MCS0	08	2447	18.06	18.32	21.20	≤ 30.00	Pass
11ax-HE40	MCS0	09	2452	17.38	17.87	20.64	≤ 30.00	Pass

Note: Total Average Power (dBm) = $10 \cdot \log\{10^{(\text{Ant 0 Average Power}/10)} + 10^{(\text{Ant 1 Average Power}/10)}\}$ (dBm).

7.4. Power Spectral Density Measurement

7.4.1. Test Limit

The maximum permissible power spectral density is 8dBm in any 3 kHz band.

The same method of determining the conducted output power shall be used to determine the power spectral density.

7.4.2. Test Procedure Used

ANSI C63.10-2013 - Section 11.10.3 & 11.10.5

7.4.3. Test Setting

1. Measure the duty cycle (x) of the transmitter output signal.
2. Set instrument center frequency to DTS channel center frequency.
3. Set span to at least 1.5 times the OBW.
4. RBW = 10 kHz.
5. VBW = 30 kHz.
6. Detector = RMS.
7. Ensure that the number of measurement points in the sweep $\geq 2 \times \text{span}/\text{RBW}$.
8. Sweep time = auto couple.
9. Don't use sweep triggering. Allow sweep to "free run".
10. Employ trace averaging (RMS) mode over a minimum of 100 traces.
11. Use the peak marker function to determine the maximum amplitude level.

7.4.4. Test Setup

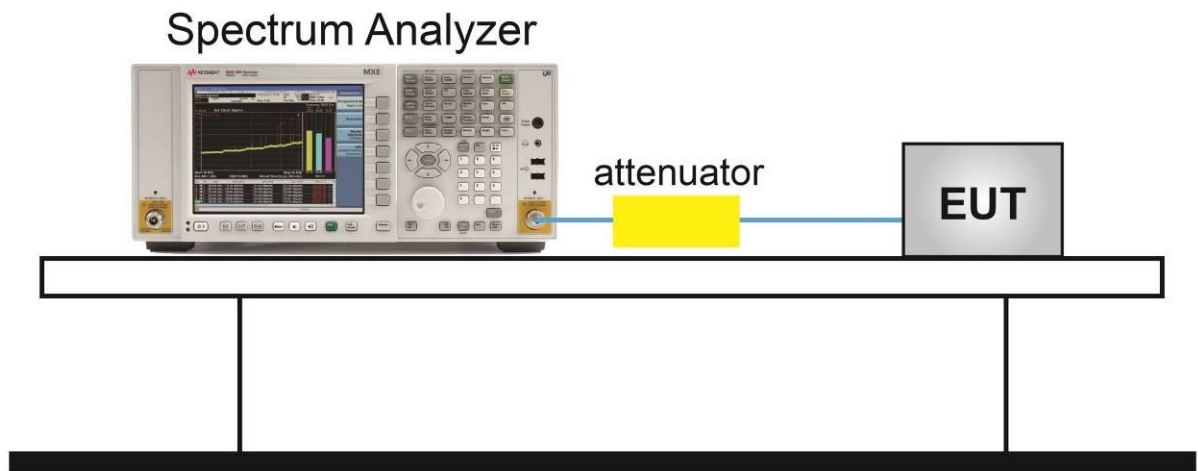

7.4.5. Test Result

Product	ACCESS POINT	Test Engineer	Eric Lin
Test Site	SR2	Test Date	2020/07/28

Test Mode	Data Rate/MCS	Channel No.	Freq. (MHz)	Ant 0 AVGPSD (dBm / 10kHz)	Ant 1 AVGPSD (dBm / 10kHz)	Duty Cycle (%)	Total AVGPSD (dBm / 10kHz)	Limit (dBm / 3kHz)	Result
11b	1Mbps	01	2412	-4.73	-4.42	94.87	-1.33	≤ 8.00	Pass
11b	1Mbps	06	2437	-4.63	-3.97	94.87	-1.05	≤ 8.00	Pass
11b	1Mbps	11	2462	-4.85	-3.80	94.87	-1.06	≤ 8.00	Pass
11g	6Mbps	01	2412	-11.63	-10.68	94.48	-7.88	≤ 8.00	Pass
11g	6Mbps	06	2437	-7.61	-6.65	94.48	-3.85	≤ 8.00	Pass
11g	6Mbps	11	2462	-9.31	-9.03	94.48	-5.91	≤ 8.00	Pass
11n-HT20	MCS0	01	2412	-10.91	-10.76	94.55	-7.58	≤ 8.00	Pass
11n-HT20	MCS0	06	2437	-8.12	-7.10	94.55	-4.32	≤ 8.00	Pass
11n-HT20	MCS0	11	2462	-9.53	-9.19	94.55	-6.10	≤ 8.00	Pass
11n-HT40	MCS0	03	2422	-12.69	-12.39	90.03	-9.07	≤ 8.00	Pass
11n-HT40	MCS0	06	2437	-11.90	-12.32	90.03	-8.64	≤ 8.00	Pass
11n-HT40	MCS0	09	2452	-12.54	-11.94	90.03	-8.76	≤ 8.00	Pass
11ax-HE20	MCS0	01	2412	-11.64	-11.66	97.50	-8.53	≤ 8.00	Pass
11ax-HE20	MCS0	06	2437	-8.66	-7.94	97.50	-5.16	≤ 8.00	Pass
11ax-HE20	MCS0	11	2462	-11.41	-10.44	97.50	-7.78	≤ 8.00	Pass
11ax-HE40	MCS0	03	2422	-13.86	-12.98	95.85	-10.20	≤ 8.00	Pass
11ax-HE40	MCS0	06	2437	-13.74	-14.14	95.85	-10.74	≤ 8.00	Pass
11ax-HE40	MCS0	09	2452	-13.46	-13.18	95.85	-10.07	≤ 8.00	Pass

Note 1: The total AVGPSD = $10 \cdot \log\{10^{(\text{Ant 0 AVGPSD}/10)} + 10^{(\text{Ant 1 AVGPSD}/10)}\} + 10 \cdot \log(1/\text{Duty cycle})$.

Note 2: Total AVGPSD (dBm / 10kHz) << Limit (dBm / 3kHz), so there is no necessary to conversion unit.

802.11b AVGPDS - Ant 0 / Ant 0 + 1

Channel 01 (2412MHz)

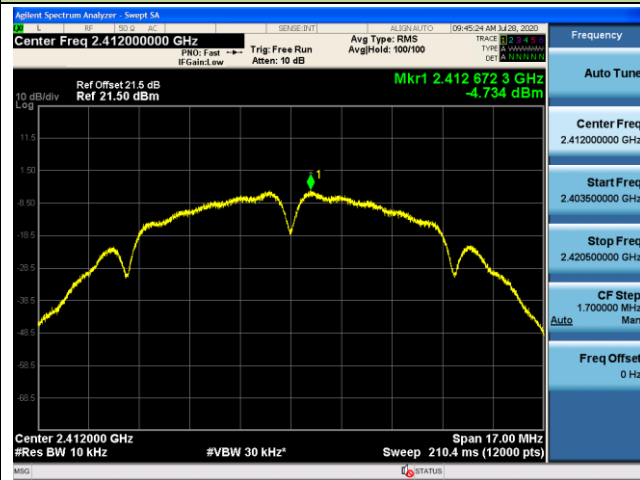

Channel 06 (2437MHz)

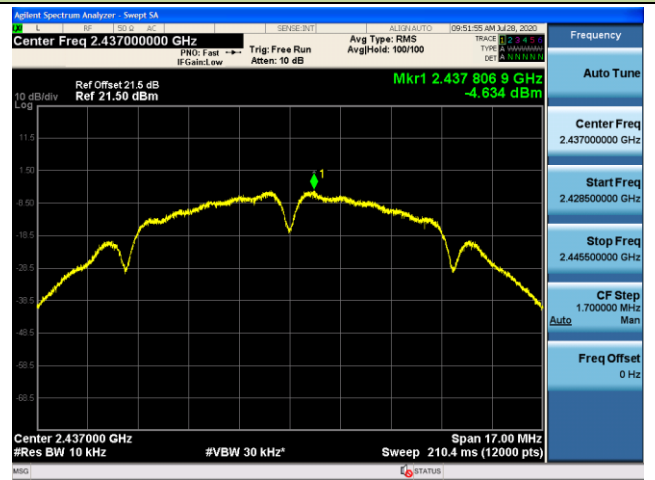

Channel 11 (2462MHz)



802.11g AVGPDS - Ant 0 / Ant 0 + 1

Channel 01 (2412MHz)

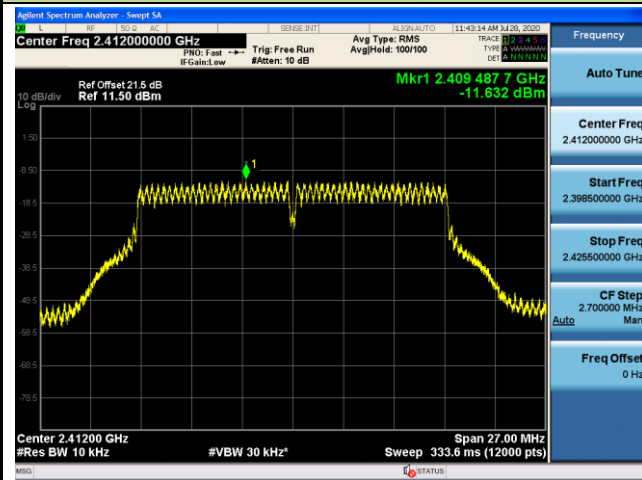

Channel 06 (2437MHz)

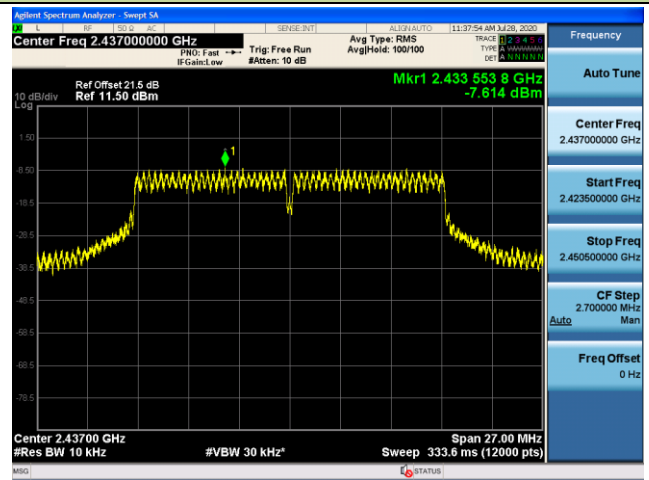

Channel 11 (2462MHz)

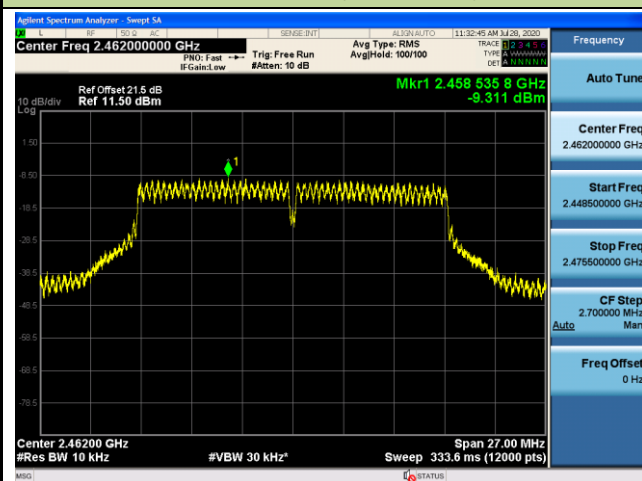

802.11n-HT20 AVGPSD - Ant 0 / Ant 0 + 1

Channel 01 (2412MHz)

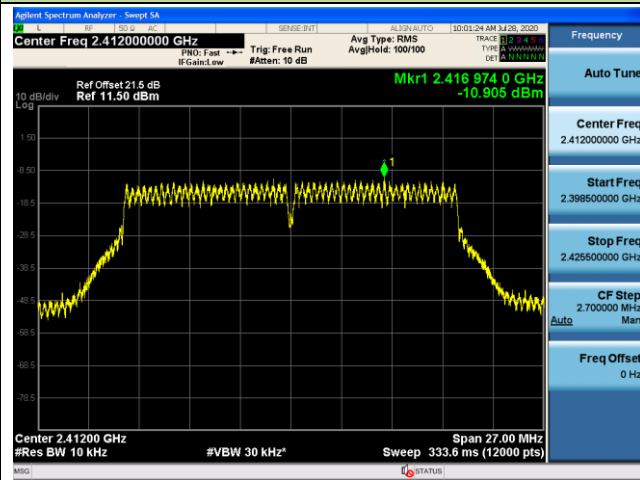

Channel 06 (2437MHz)

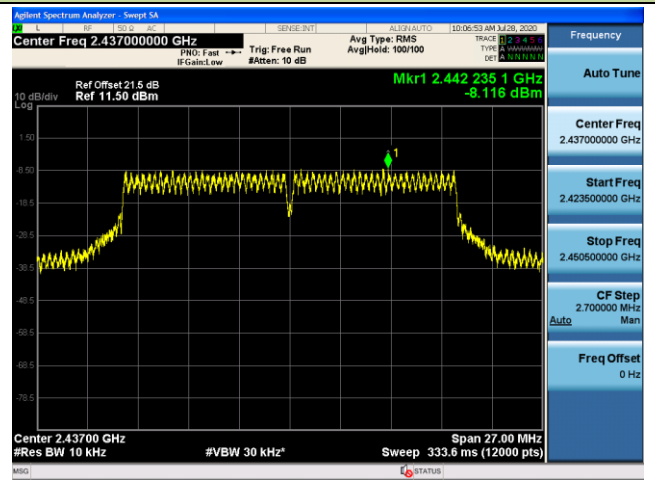

Channel 11 (2462MHz)

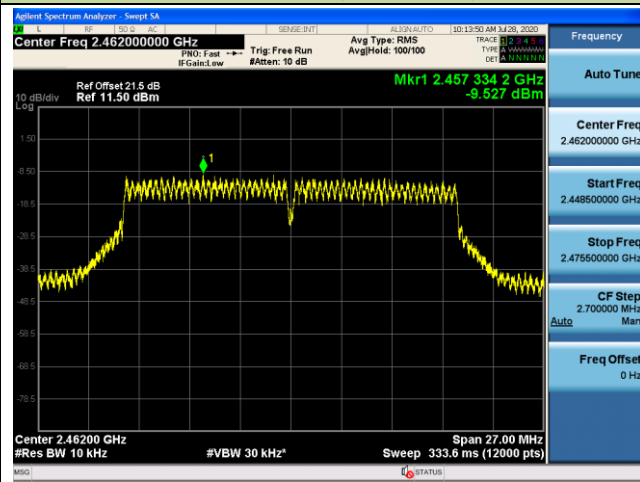

802.11n-HT40 AVGPSPD - Ant 0 / Ant 0 + 1

Channel 03 (2422MHz)

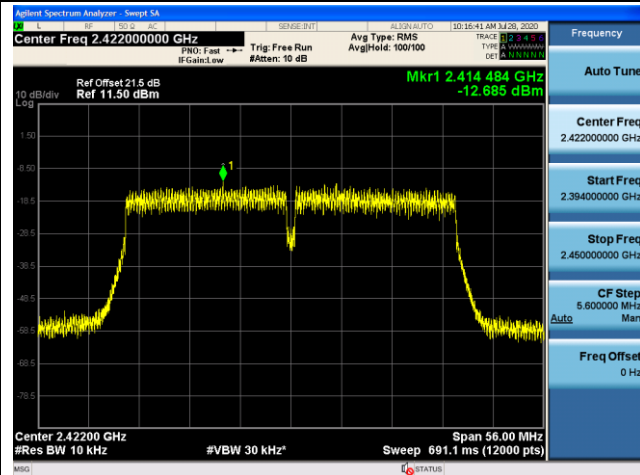

Channel 06 (2437MHz)

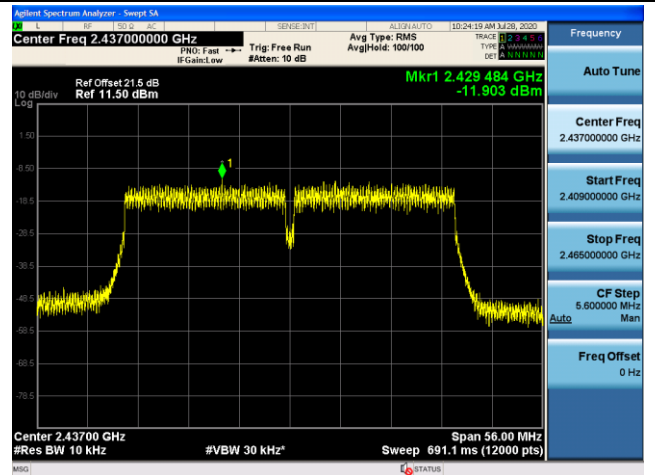

Channel 09 (2452MHz)

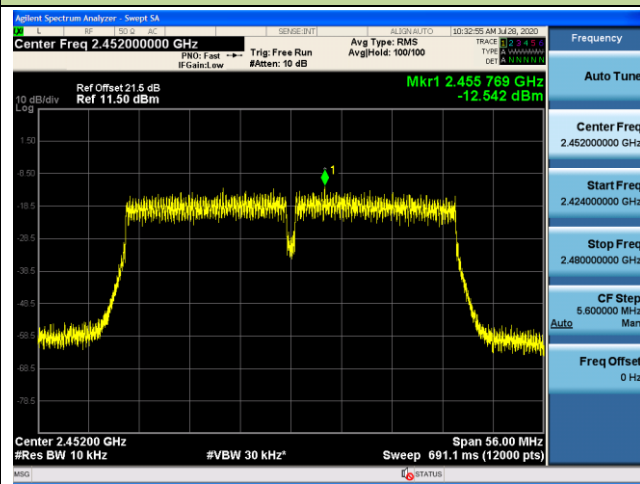

802.11ax-HE20 AVGPSPD - Ant 0 / Ant 0 + 1

Channel 01 (2412MHz)

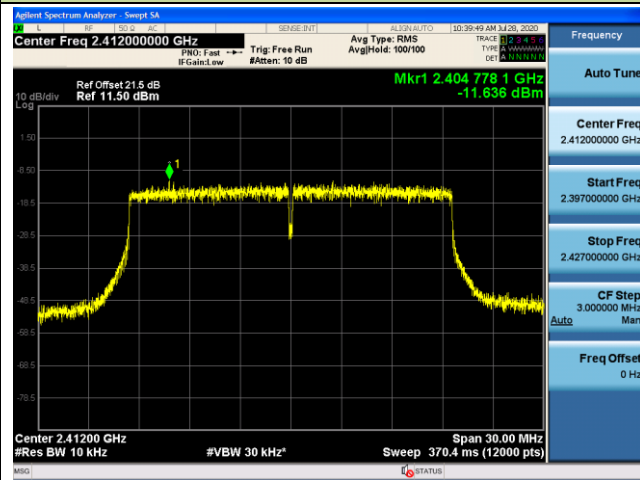

Channel 06 (2437MHz)

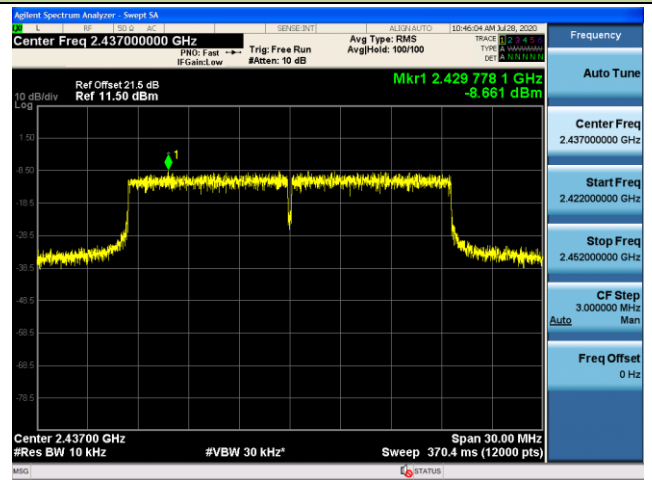

Channel 11 (2462MHz)

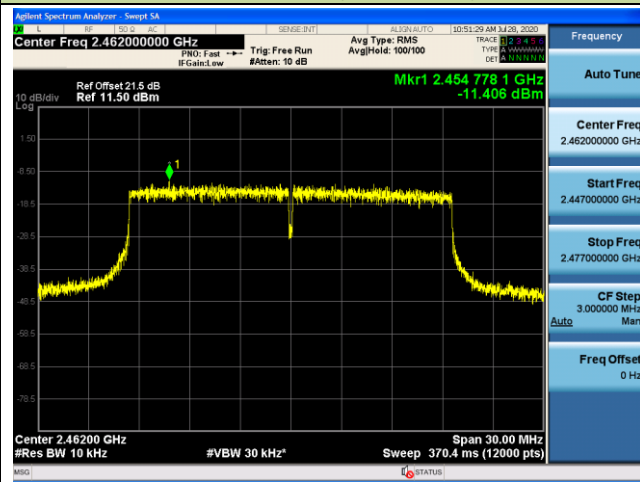

802.11ax-HE40 AVGPSPD - Ant 0 / Ant 0 + 1

Channel 03 (2422MHz)

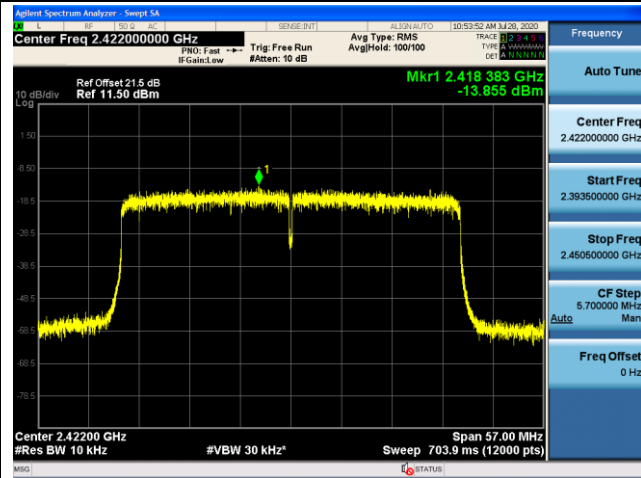

Channel 06 (2437MHz)

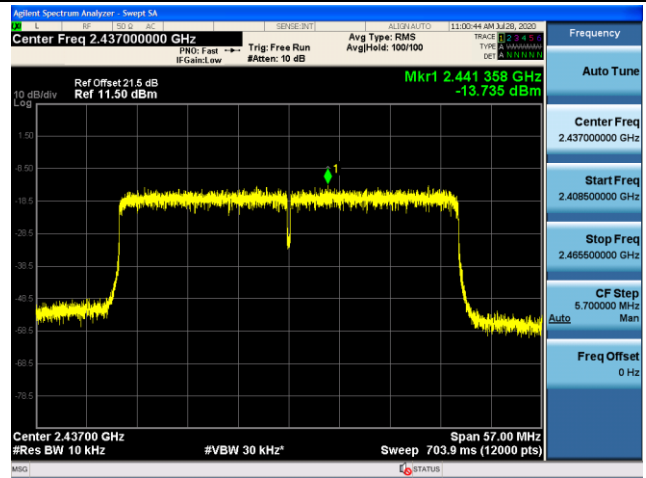

Channel 09 (2452MHz)

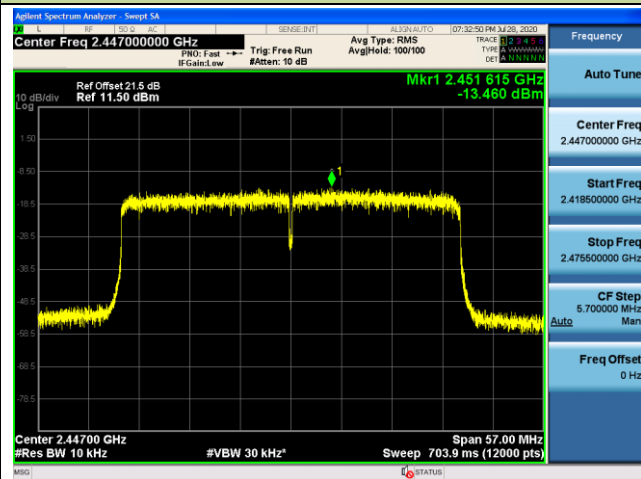

802.11b AVGPDS - Ant 1 / Ant 0 + 1

Channel 01 (2412MHz)



Channel 06 (2437MHz)

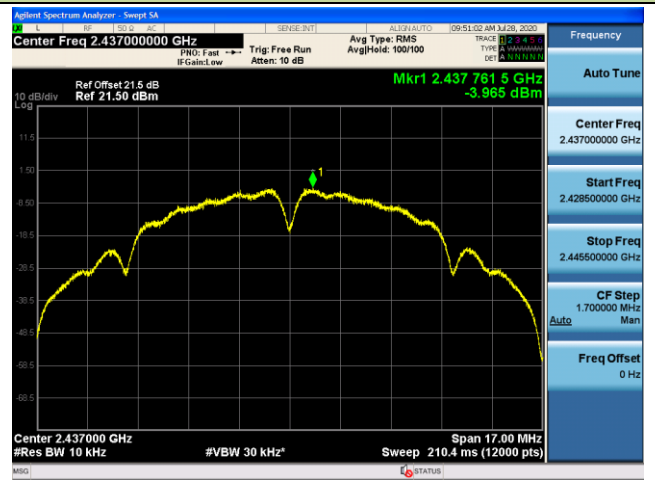

Channel 11 (2462MHz)

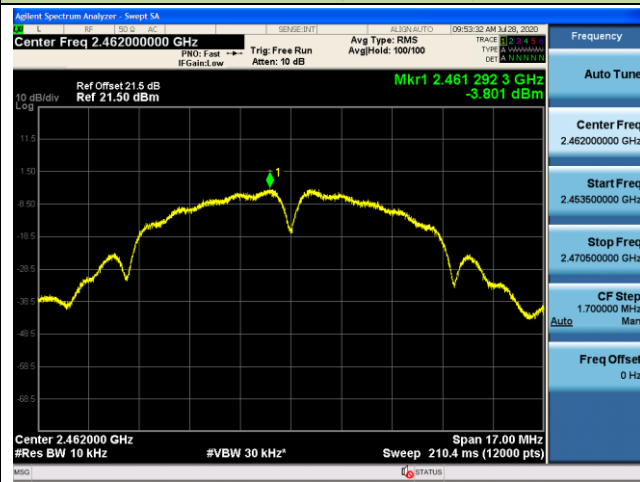

802.11g AVGPDS - Ant 1 / Ant 0 + 1

Channel 01 (2412MHz)

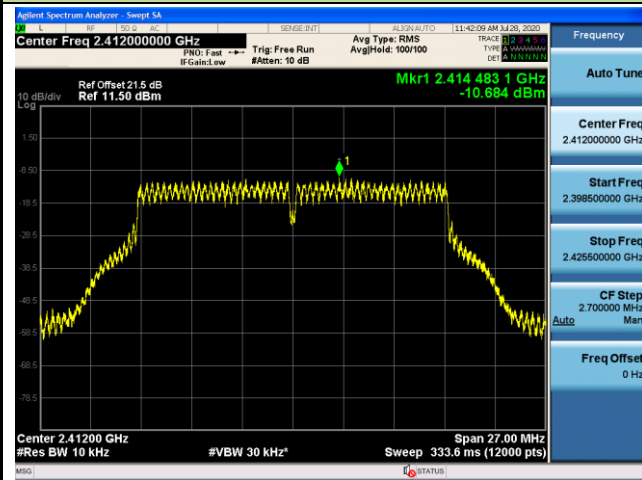

Channel 06 (2437MHz)

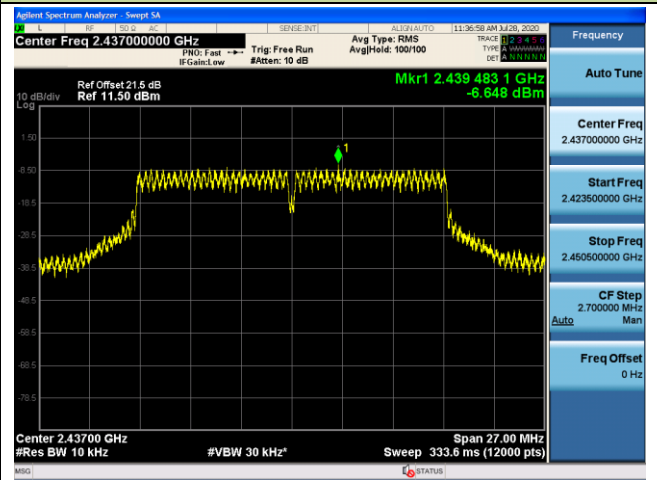

Channel 11 (2462MHz)

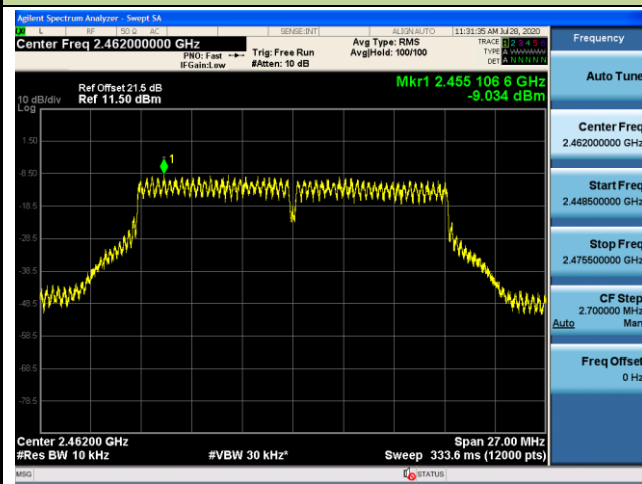

802.11n-HT20 AVGPDS - Ant 1 / Ant 0 + 1

Channel 01 (2412MHz)

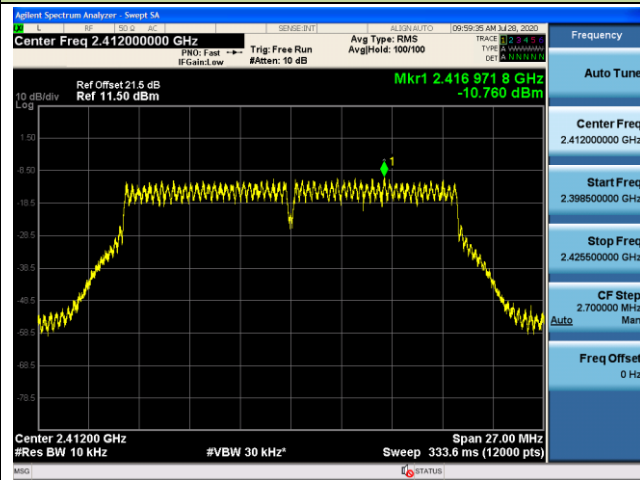

Channel 06 (2437MHz)

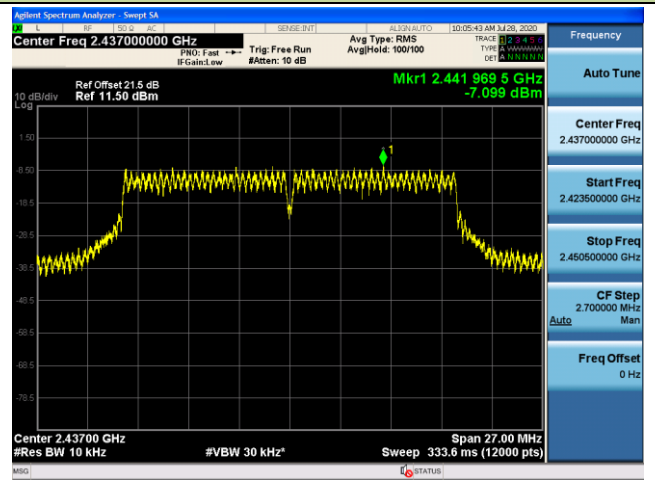

Channel 11 (2462MHz)

