

REVISIONS

REV	DESCRIPTION	DATE	APPROVE
F	RELEASE	06/18/24	SANDY CHEN

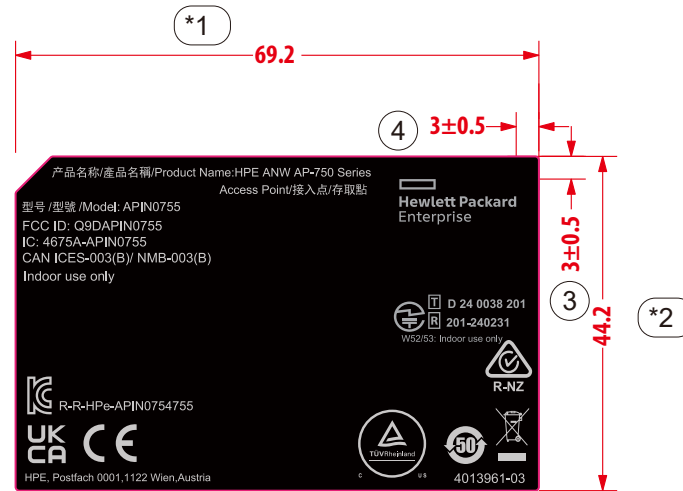

UNLESS OTHERWISE SPECIFIED ALL DIMENSIONS ARE IN mm AND TOLERANCES ARE: INTEGRAL DIMENSIONS ± 0.2 1 PLACE DECIMAL ± 0.2 ANGULAR DIMENSIONS ± 2° HOLES UNDER Ø5.00 ± 0.2		THIRD ANGLE PROJECTION 	WNC 啟碁科技股份有限公司 Wistron NeWeb Corp. 20 Park Avenue II, Hsinchu Science Park, Hsinchu 308, Taiwan, R.O.C. Tel: 886-3-6667799 Fax: 886-3-5788726	
DRAWN CATHY CHEN		06/18/24	DWG TITLE	
ENGR CATHY CHEN		06/18/24	LASER ENGRAVING,4013961-03,AGENCY , AP-755,R7PB-A2	
APVD SANDY CHEN		06/18/24	SIZE A4	REV F
SCALE 1/1			SHEET 1 OF 1	

WNC CONFIDENTIAL		REVISIONS		DATE	APPROVED
ZONE	REV	DESCRIPTION			
A		NEW RELEASE			

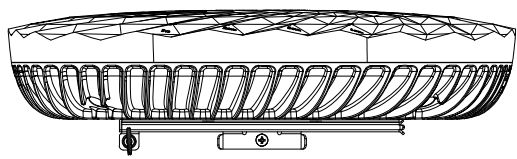
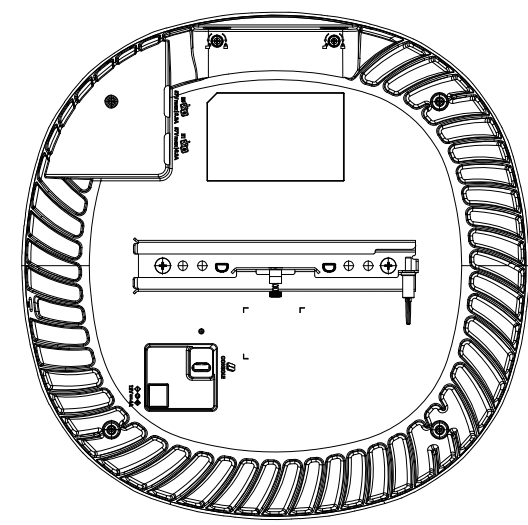
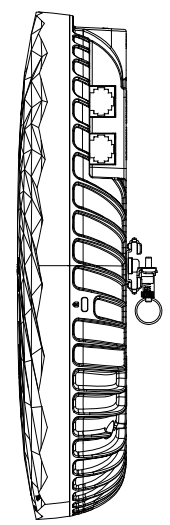
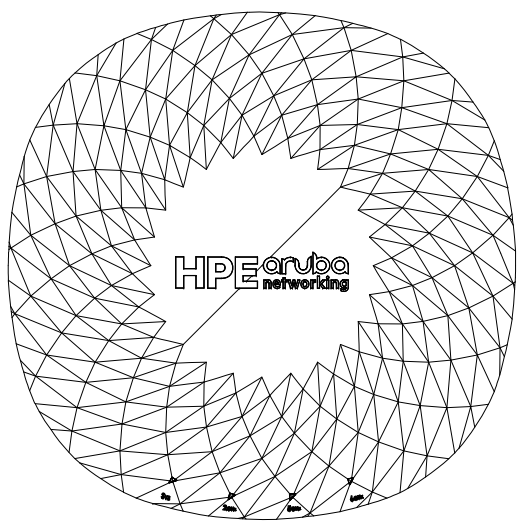
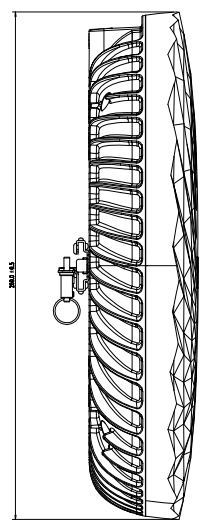
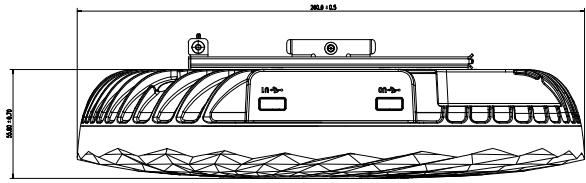

UNLESS OTHERWISE SPECIFIED ALL DIMENSIONS ARE IN MM AND TOLERANCES ARE:		THIRD ANGLE PROJECTION				WNC 睿基科技股份有限公司 WNC Information Network Corp. 4000 West 10th Street, Suite 100 Vancouver, BC, Canada V6P 3E9 Tel: 604-273-8878 Fax: 604-273-8888	
FINISH DIMENSIONS	+ 0.1	SIZE	AP755 DIMENSION DRAWING	REV	A		
1 PLACE DECIMAL	+ 0.1	DATE					
2 PLACE DECIMAL	+ 0.05	SCALE	1/1	SHEET	1 OF 1		
3 PLACE DECIMAL	+ 0.02						
4 PLACE DECIMAL	+ 0.01						
5 PLACE DECIMAL	+ 0.005						
6 PLACE DECIMAL	+ 0.002						
7 PLACE DECIMAL	+ 0.001						
8 PLACE DECIMAL	+ 0.0005						
9 PLACE DECIMAL	+ 0.0002						
10 PLACE DECIMAL	+ 0.0001						