

REVISIONS

REV	DESCRIPTION	DATE	APPROVE
F	RELEASE	06/18/24	SANDY CHEN

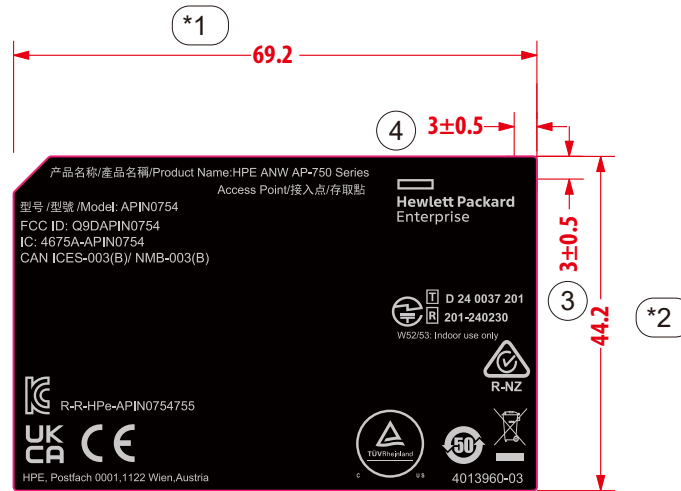

UNLESS OTHERWISE SPECIFIED ALL DIMENSIONS ARE IN mm AND TOLERANCES ARE: INTEGRAL DIMENSIONS ± 0.2 1 PLACE DECIMAL ± 0.2 ANGULAR DIMENSIONS ± 2° HOLES UNDER Ø5.00 ± 0.2		THIRD ANGLE PROJECTION 		<b>WNC 啟碁科技股份有限公司</b> Wistron NeWeb Corp. 20 Park Avenue II, Hsinchu Science Park, Hsinchu 308, Taiwan, R.O.C. Tel: 886-3-6667799 Fax: 886-3-5788726	
DRAWN CATHY CHEN		06/18/24		DWG TITLE	
ENGR CATHY CHEN		06/18/24		LASER ENGRAVING,4013960-03,AGENCY , AP-754,R7PB-A1	
APVD SANDY CHEN		06/18/24		SIZE A4	DWG NO.
				SCALE 1/1	SHEET 1 OF 1
				REV F	

ZONE		REV	DESCRIPTION	REVISIONS	DATE	APPROVED
A			NEW RELEASE			

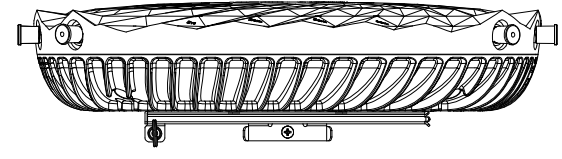
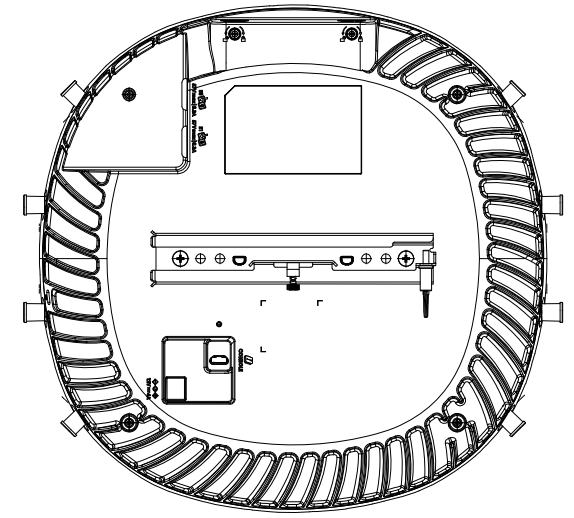
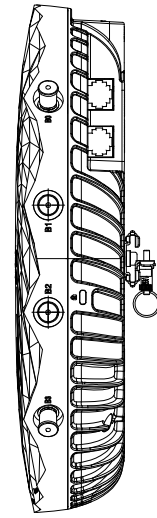
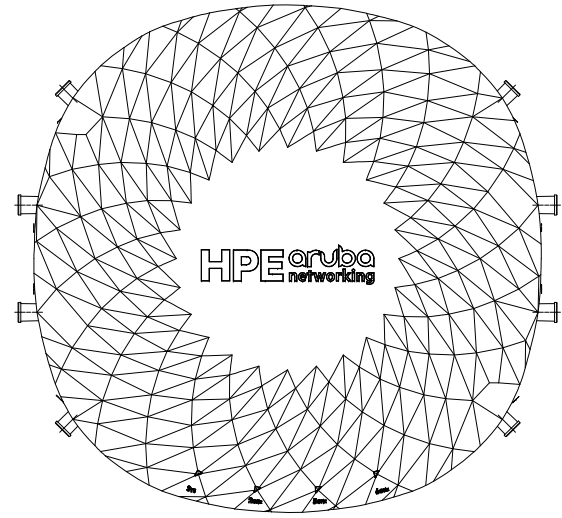
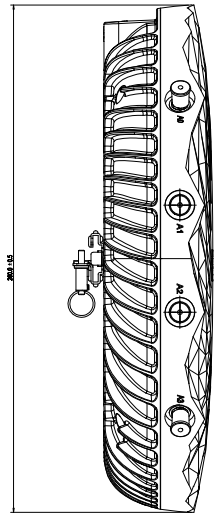
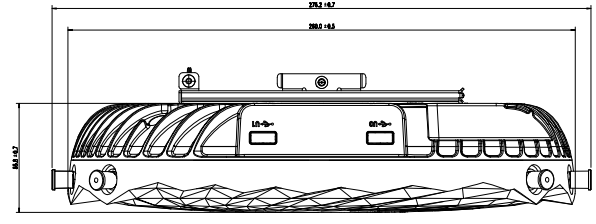

UNLESS OTHERWISE SPECIFIED ALL DIMENSIONS ARE IN MM AND TOLERANCES ARE:		THIRD ANGLE PROJECTION				<b>WNC</b> 睿基科技股份有限公司 WNC Information Hub Corp. No. 101, Sec. 2, Hsinchu Rd., Hsinchu City, Taiwan, R.O.C. Tel: 886-3-5727111 Fax: 886-3-5727115	
FITTED DIMENSIONS		± 0.2		SIZE		AP754 DIMENSION DRAWING	
1 PLACE DECIMALS		± 0.1		DWG NO.		REV	
2 PLACE DECIMALS		± 0.05		A.D		A	
3 PLACE DECIMALS		± 0.02		SCALE		1/1 SHEET 1 OF 1	
HOLE DIMENSIONS		± 0.08		AP/D		M/D/Y	
HOLE UNDER PROFILE		± 0.06		M/D/Y			