

### 802.11a Power Spectral Density – Ant 3

Channel 100 (5500MHz)



Channel 116 (5580MHz)



Channel 140 (5700MHz)



Channel 144 (5720MHz)



Channel 149 (5745MHz)



Channel 157 (5785MHz)

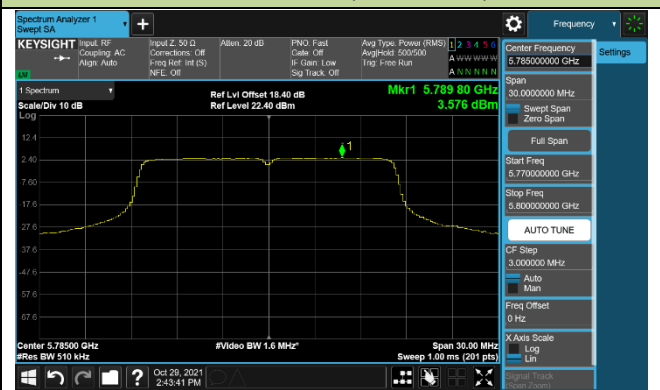

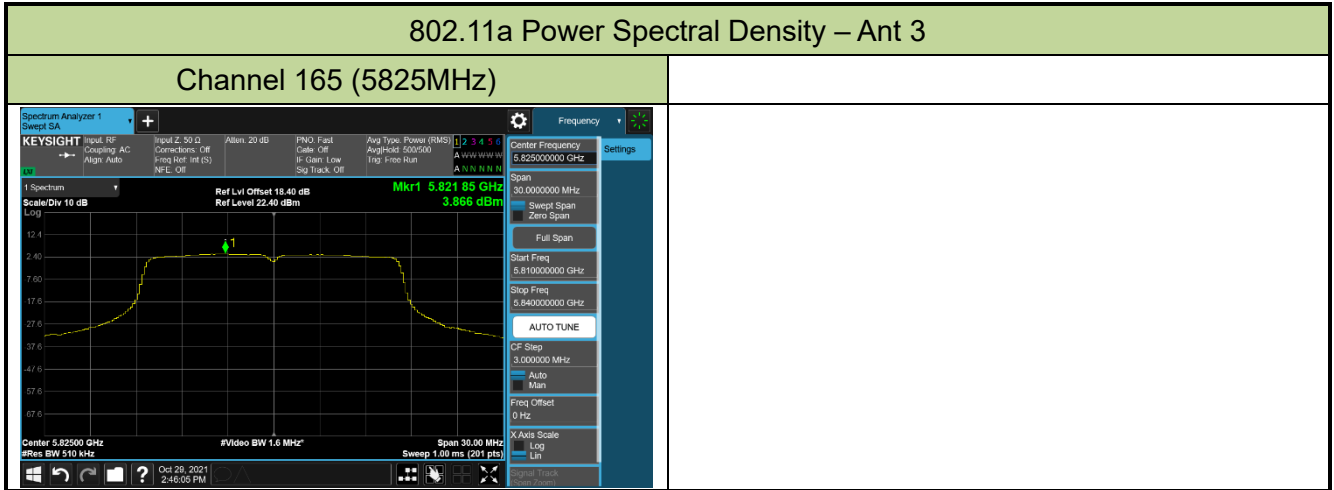

802.11ac-VHT20 Power Spectral Density – Ant 3

Channel 36 (5180MHz)

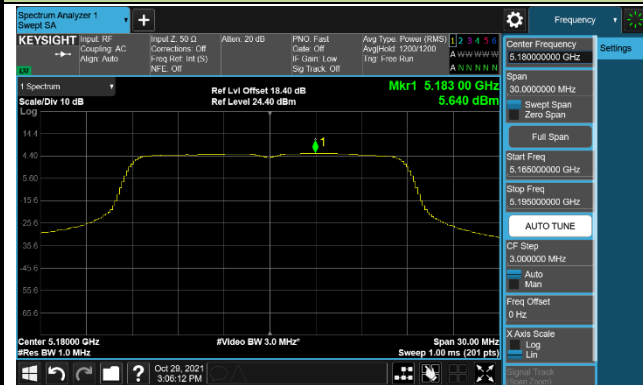

Channel 44 (5220MHz)



Channel 48 (5240MHz)



Channel 52 (5260MHz)



Channel 60 (5300MHz)

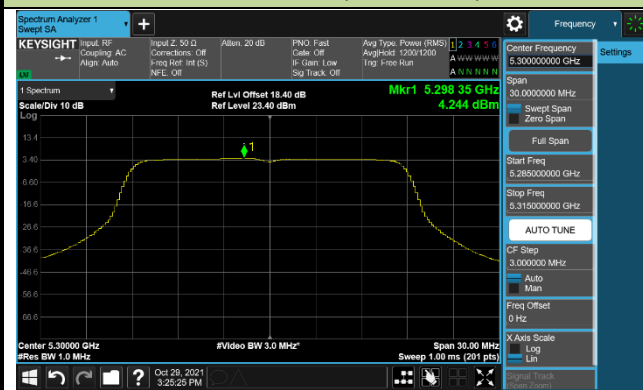

Channel 64 (5320MHz)

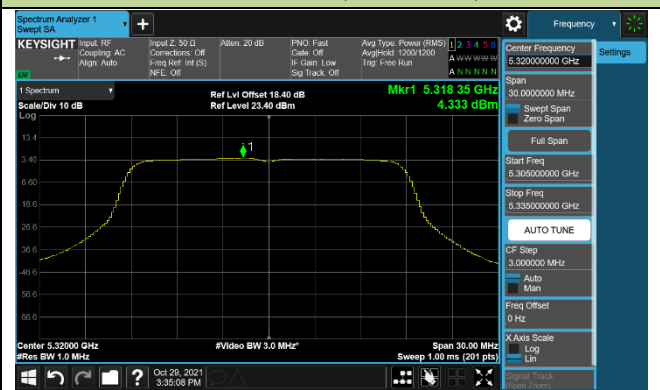

802.11ac-VHT20 Power Spectral Density – Ant 3

Channel 100 (5500MHz)

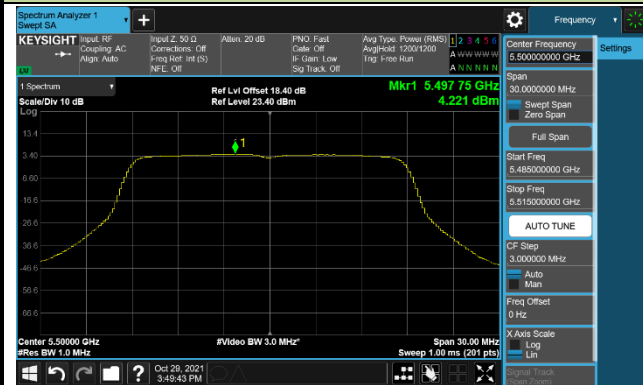

Channel 116 (5580MHz)



Channel 140 (5700MHz)

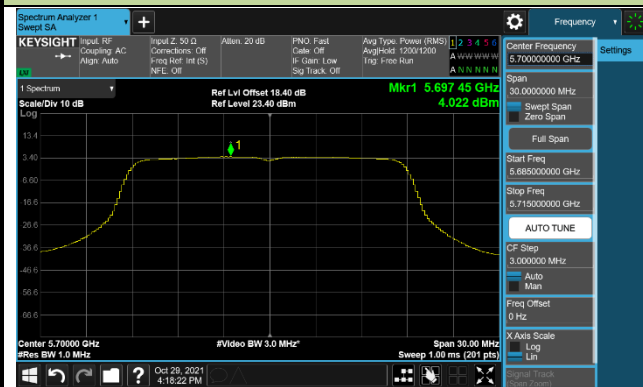

Channel 144 (5720MHz)



Channel 149 (5745MHz)

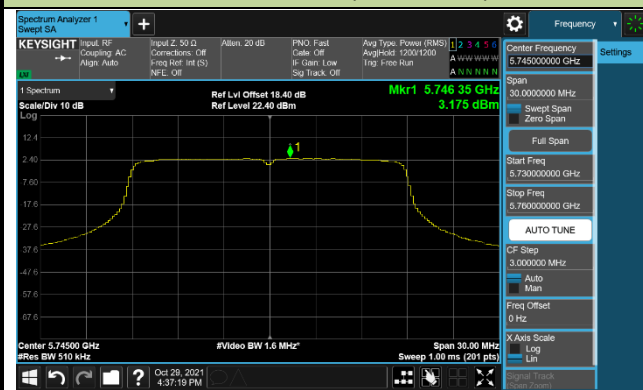

Channel 157 (5785MHz)

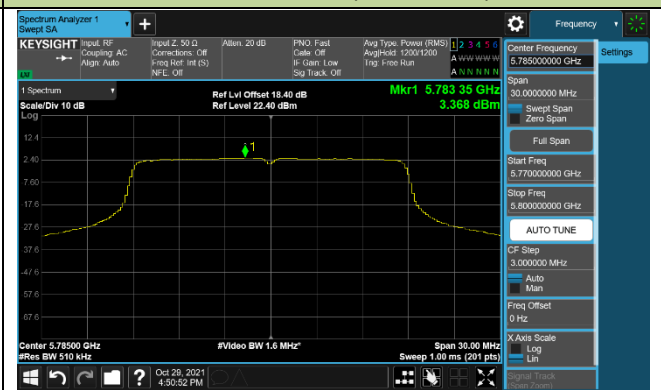

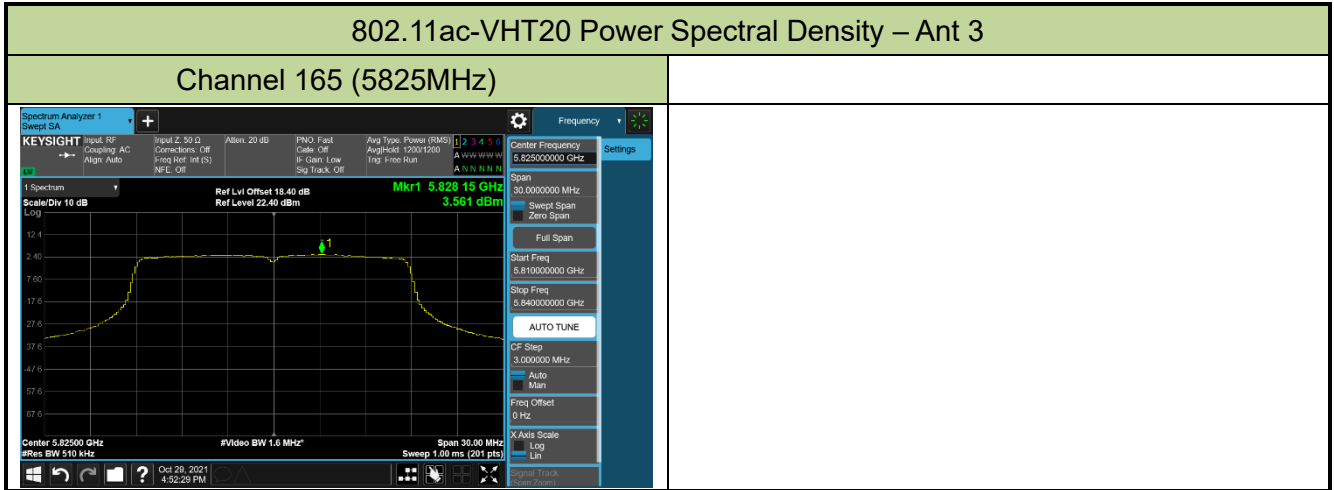

802.11ac-VHT40 Power Spectral Density – Ant 3

Channel 38 (5190MHz)

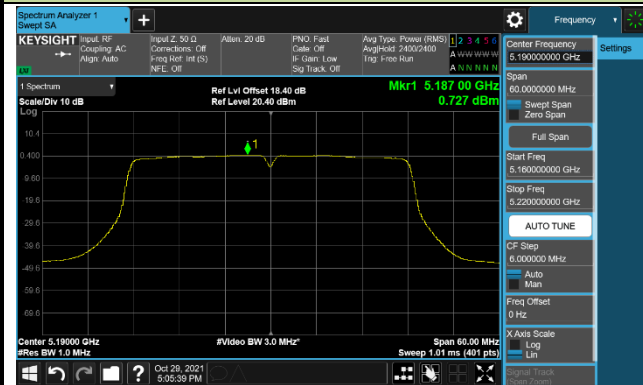

Channel 46 (5230MHz)



Channel 54 (5270MHz)

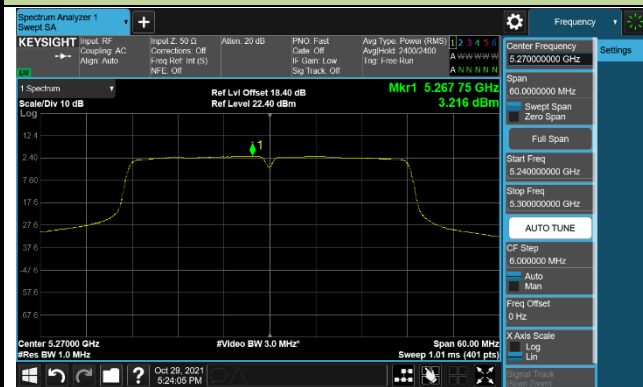

Channel 62 (5310MHz)

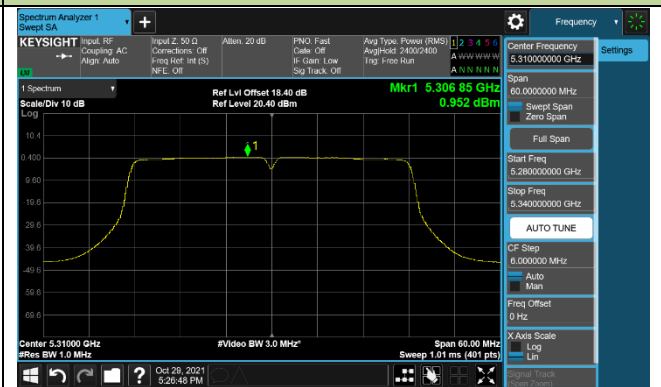

Channel 102 (5510MHz)



Channel 110 (5550MHz)



802.11ac-VHT40 Power Spectral Density – Ant 3

Channel 134 (5670MHz)

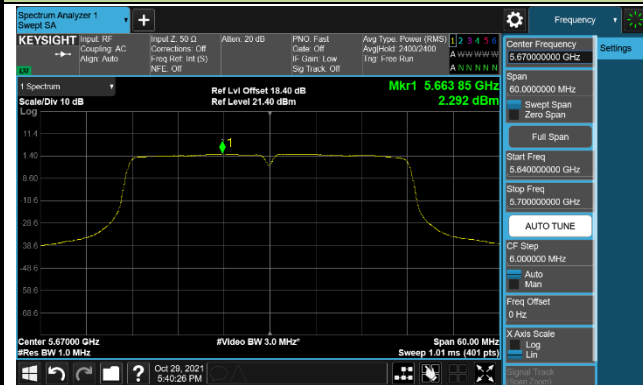

Channel 142 (5710MHz)



Channel 151 (5755MHz)

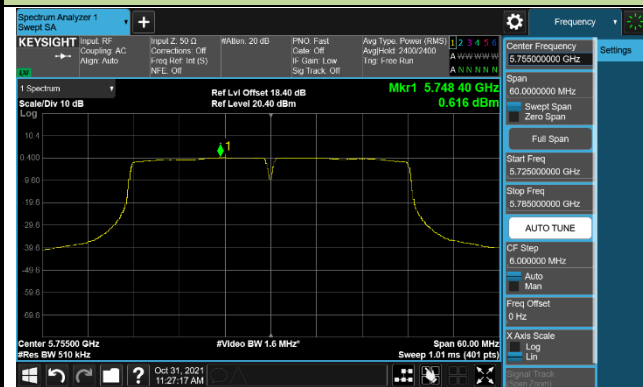

Channel 159 (5795MHz)

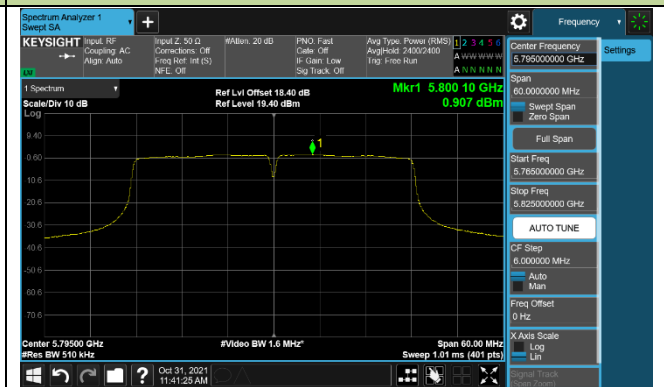

802.11ac-VHT80 Power Spectral Density – Ant 3

Channel 42 (5210MHz)

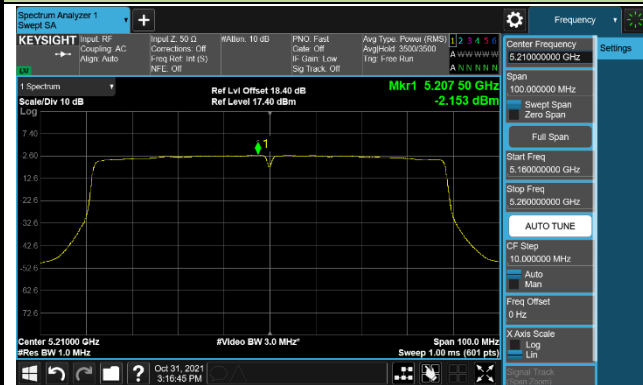

Channel 58 (5290MHz)



Channel 106 (5530MHz)



Channel 122 (5610MHz)

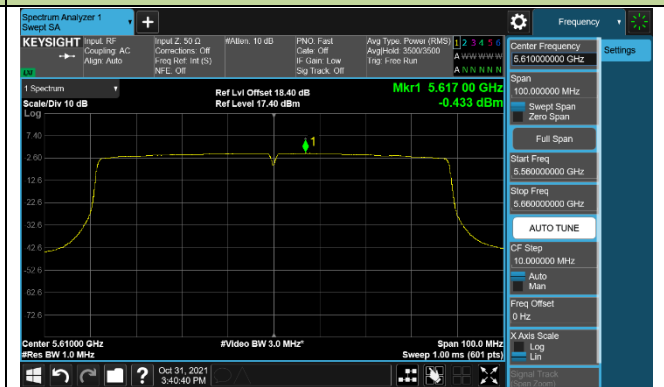

Channel 138 (5690MHz)

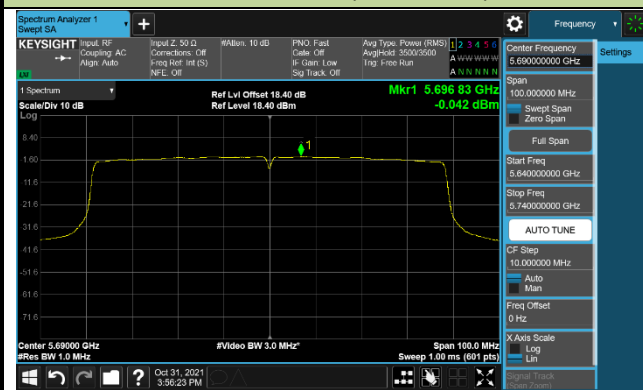

Channel 155 (5775MHz)

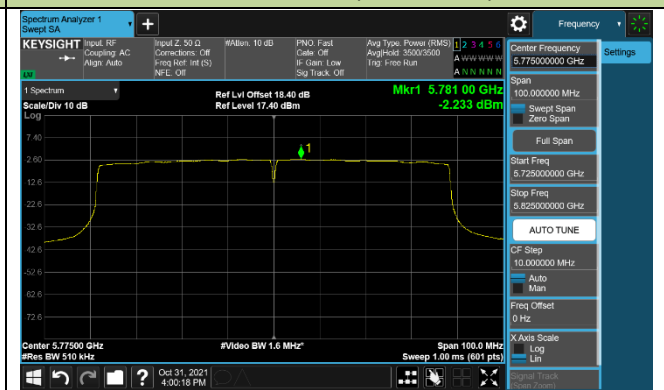



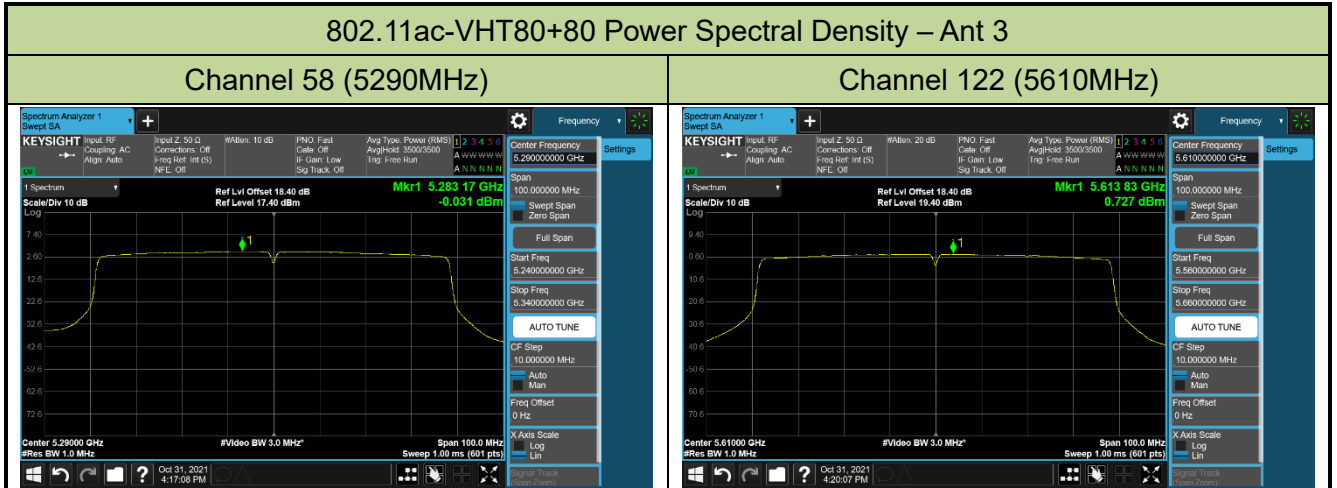

802.11ax-HE20 Power Spectral Density – Ant 3

Channel 36 (5180MHz)

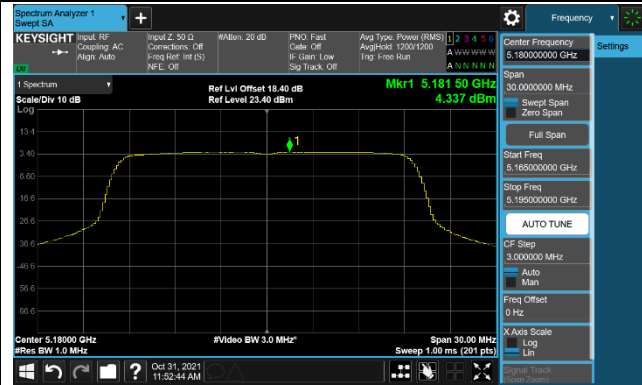

Channel 44 (5220MHz)



Channel 48 (5240MHz)



Channel 52 (5260MHz)



Channel 60 (5300MHz)



Channel 64 (5320MHz)



### 802.11ax-HE20 Power Spectral Density – Ant 3

**Channel 100 (5500MHz)**

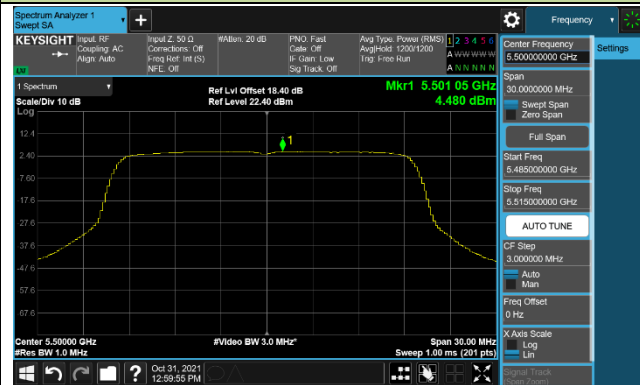

**Channel 116 (5580MHz)**



**Channel 140 (5700MHz)**

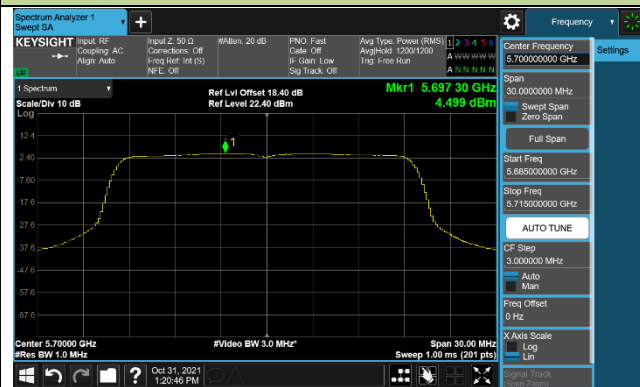

**Channel 144 (5720MHz)**



**Channel 149 (5745MHz)**



**Channel 157 (5785MHz)**



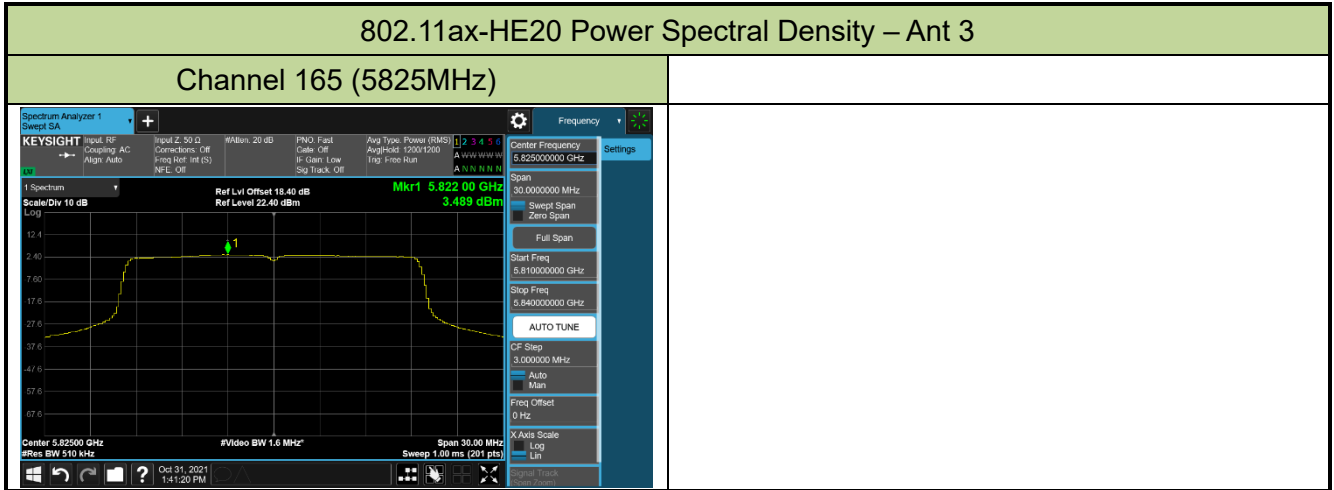

### 802.11ax-HE40 Power Spectral Density – Ant 3

#### Channel 38 (5190MHz)

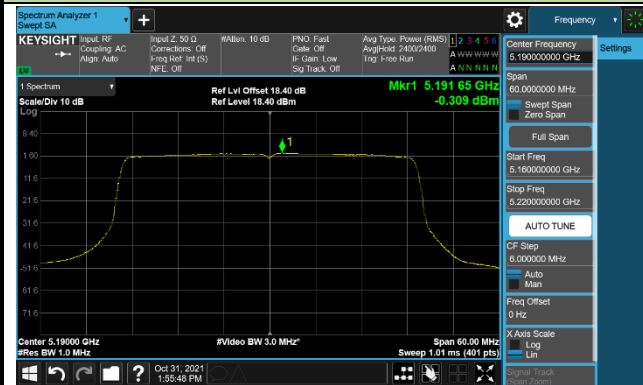

#### Channel 46 (5230MHz)



#### Channel 54 (5270MHz)



#### Channel 62 (5310MHz)



#### Channel 102 (5510MHz)

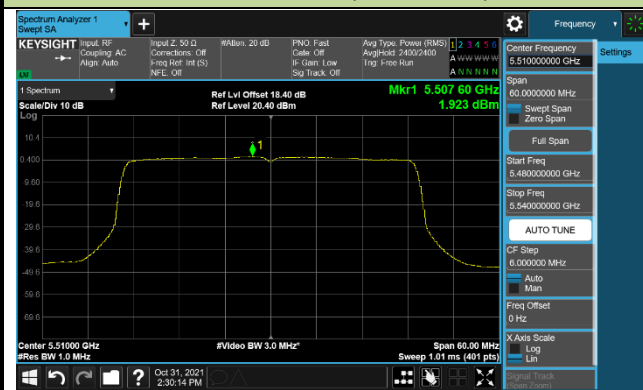

#### Channel 110 (5550MHz)

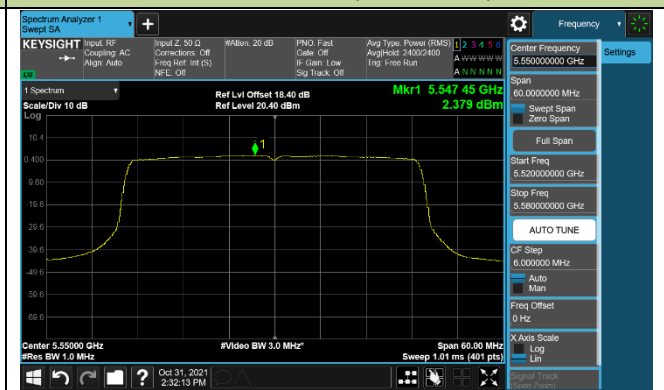

802.11ax-HE40 Power Spectral Density – Ant 3

Channel 134 (5670MHz)



Channel 142 (5710MHz)

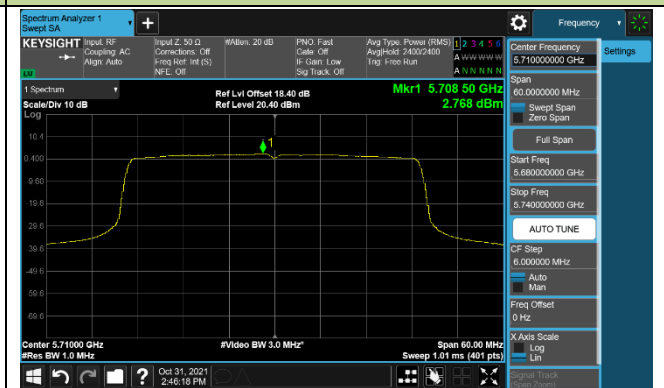

Channel 151 (5755MHz)

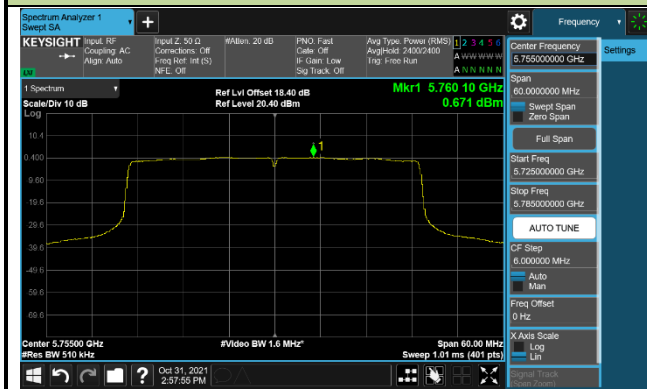

Channel 159 (5795MHz)

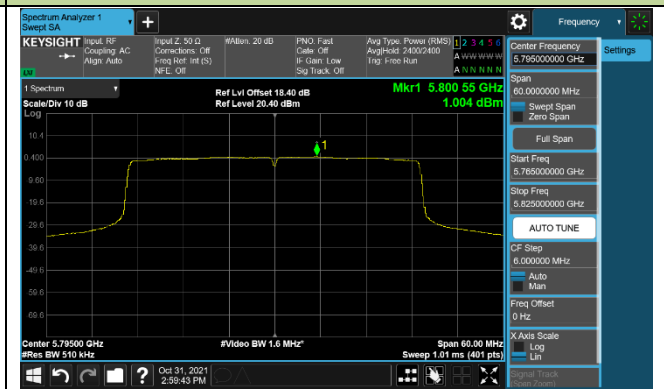

### 802.11ax-HE80 Power Spectral Density – Ant 3

#### Channel 42 (5210MHz)

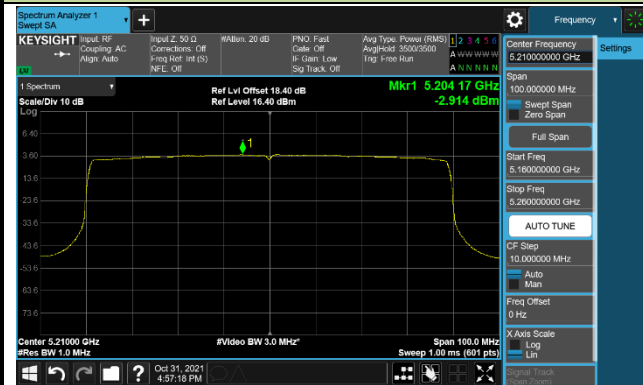

#### Channel 58 (5290MHz)



#### Channel 106 (5530MHz)



#### Channel 122 (5610MHz)



#### Channel 138 (5690MHz)

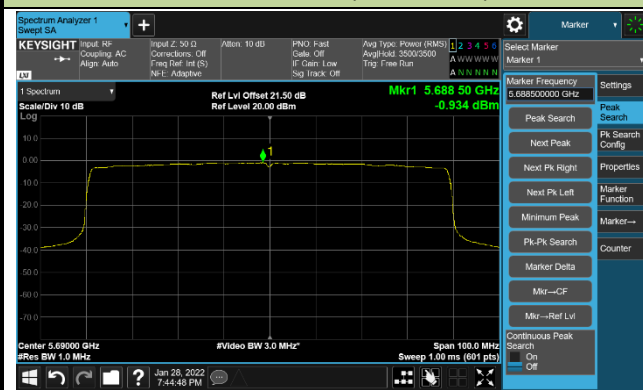

#### Channel 155 (5775MHz)



802.11ax-HE80+80 Power Spectral Density – Ant 3

Channel 58 (5290MHz)

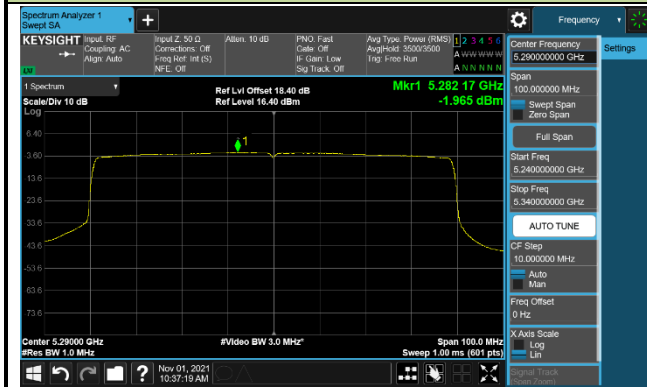

Channel 122 (5610MHz)





## **7.6. Frequency Stability Measurement**

### **7.6.1. Test Limit**

Manufactures of U-NII devices are responsible for ensuring frequency stability such that an emission is maintained within the band of operation under all conditions of normal operation as specified in the user's manual.

The transmitter center frequency tolerance shall be  $\pm 20$  ppm maximum for the 5GHz band (IEEE 802.11 specification).

### **7.6.2. Test Procedure Used**

#### **Frequency Stability Under Temperature Variations:**

The equipment under test was connected to an external AC or DC power supply and input rated voltage. RF output was connected to a frequency counter or spectrum analyzer via feed through attenuators. The EUT was placed inside the temperature chamber. Set the spectrum analyzer RBW low enough to obtain the desired frequency resolution and measure EUT 20°C operating frequency as reference frequency. Turn EUT off and set the chamber temperature to highest. After the temperature stabilized for approximately 30 minutes recorded the frequency. Repeat step measure with 10°C decreased per stage until the lowest temperature reached.

#### **Frequency Stability Under Voltage Variations:**

Set chamber temperature to 20°C. Use a variable AC power supply / DC power source to power the EUT and set the voltage to rated voltage. Set the spectrum analyzer RBW low enough to obtain the desired frequency resolution and recorded the frequency.

Reduce the input voltage to specify extreme voltage variation ( $\pm 15\%$ ) and endpoint, record the maximum frequency change.

### 7.6.3. Test Setup

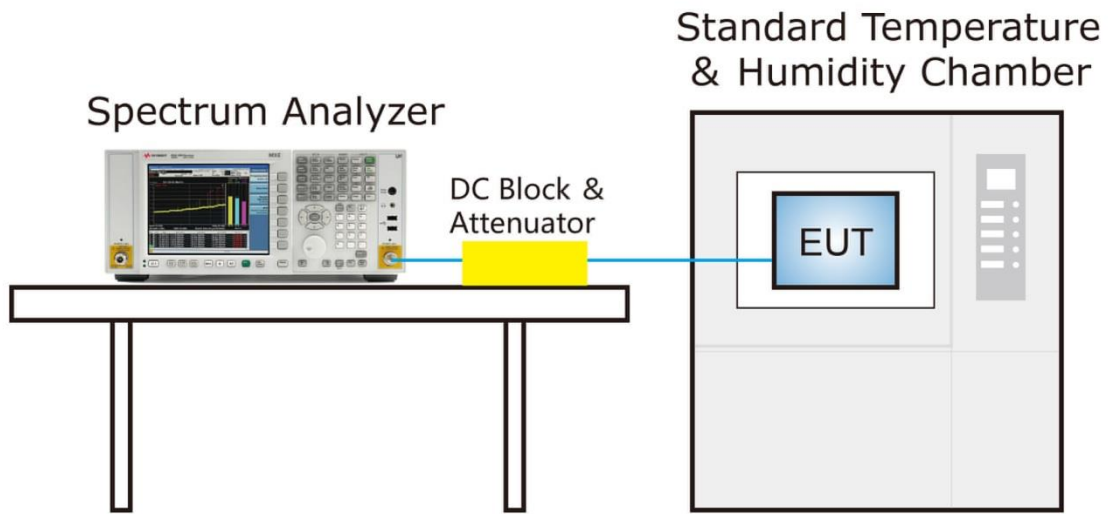

**7.6.4.Test Result**

Product	ACCESS POINT	Temperature	23°C
Test Engineer	Eric Lin	Relative Humidity	41%
Test Site	SR2	Test Date	2021/10/27
Test Mode	5180MHz (Carrier Mode)		

Voltage (%)	Power (VAC)	Temp (°C)	Frequency Tolerance (ppm)			
			0 minutes	2 minutes	5 minutes	10 minutes
100	120	- 30	-3.15	-5.03	-6.69	18.12
		- 20	-3.40	-5.15	-6.94	18.95
		- 10	-2.70	-5.32	-6.77	18.89
		0	-1.07	-5.44	-6.85	-6.92
		+ 10	-1.95	-5.61	-6.91	-6.83
		+ 20	-3.42	-5.73	-7.32	-7.17
		+ 30	-3.94	-5.90	-7.20	-7.09
		+ 40	-4.24	-6.06	-7.06	-6.82
		+ 50	-4.54	-6.31	-6.93	-6.72
115	138	+ 20	-4.69	-6.45	-7.22	-6.67
85	102	+ 20	-4.84	-6.57	18.21	-6.60

Note: Frequency Tolerance (ppm) = {[Measured Frequency (Hz) - Declared Frequency (Hz)] / Declared Frequency (Hz)} \*10<sup>6</sup>.

## 7.7. Radiated Spurious Emission Measurement

### 7.7.1. Test Limit

All out of band emissions appearing in a restricted band as specified in Section 15.205 of the Title 47CFR must not exceed the limits shown in Table per Section 15.209.

FCC Part 15 Subpart C Paragraph 15.209		
Frequency [MHz]	Field Strength [uV/m]	Measured Distance [Meters]
0.009 - 0.490	2400/F (kHz)	300
0.490 - 1.705	24000/F (kHz)	30
1.705 - 30	30	30
30 - 88	100	3
88 - 216	150	3
216 - 960	200	3
Above 960	500	3

### 7.7.2. Test Procedure Used

KDB 789033 D02v02r01 – Section G

### 7.7.3. Test Setting

**Table 1 - RBW as a function of frequency**

Frequency	RBW
9 ~ 150 kHz	200 ~ 300 Hz
0.15 ~ 30 MHz	9 ~ 10 kHz
30 ~ 1000 MHz	100 ~ 120 kHz
>1000 MHz	1 MHz

**Quasi-Peak Measurements below 1GHz**

1. Analyzer center frequency was set to the frequency of the radiated spurious emission of interest
2. Span was set greater than 1MHz
3. RBW = as specified in Table 1
4. Detector = CISPR quasi-peak
5. Sweep time = auto couple
6. Trace was allowed to stabilize

**Peak Measurements above 1GHz**

1. Analyzer center frequency was set to the frequency of the radiated spurious emission of interest
2. RBW = 1MHz
3. VBW = 3MHz
4. Detector = peak
5. Sweep time = auto couple
6. Trace mode = max hold
7. Trace was allowed to stabilize

**Average Measurements above 1GHz (Method VB)**

1. Analyzer center frequency was set to the frequency of the radiated spurious emission of interest
2. RBW = 1MHz
3. VBW; If the EUT is configured to transmit with duty cycle  $\geq 98\%$ , set VBW = 10 Hz.  
If the EUT duty cycle is  $< 98\%$ , set  $VBW \geq 1/T$ . T is the minimum transmission duration.

802.11a	VBW = 750Hz	802.11ax-HE20	VBW = 200Hz
802.11ac-VHT20	VBW = 100Hz	802.11ax-HE40	VBW = 200Hz
802.11ac-VHT40	VBW = 200Hz	802.11ax-HE80	VBW = 200Hz
802.11ac-VHT80	VBW = 200Hz	N/A	N/A

4. Detector = Peak
5. Sweep time = auto

6. Trace mode = max hold

7. Trace was allowed to stabilize

### 7.7.4. Test Setup

Below 1GHz Test Setup:

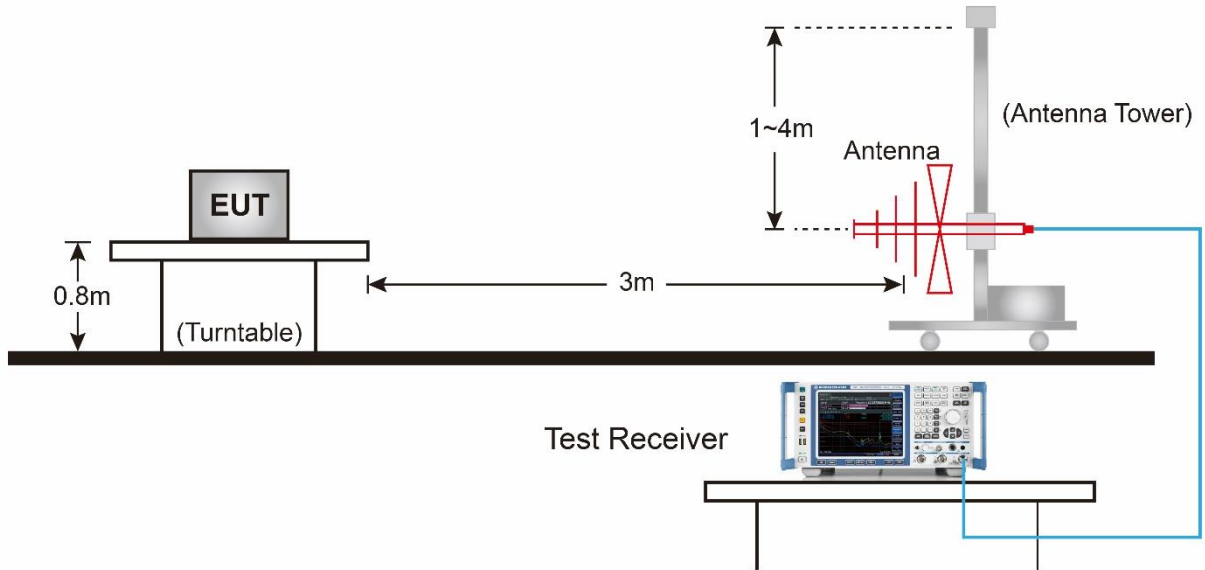

Above 1GHz Test Setup:

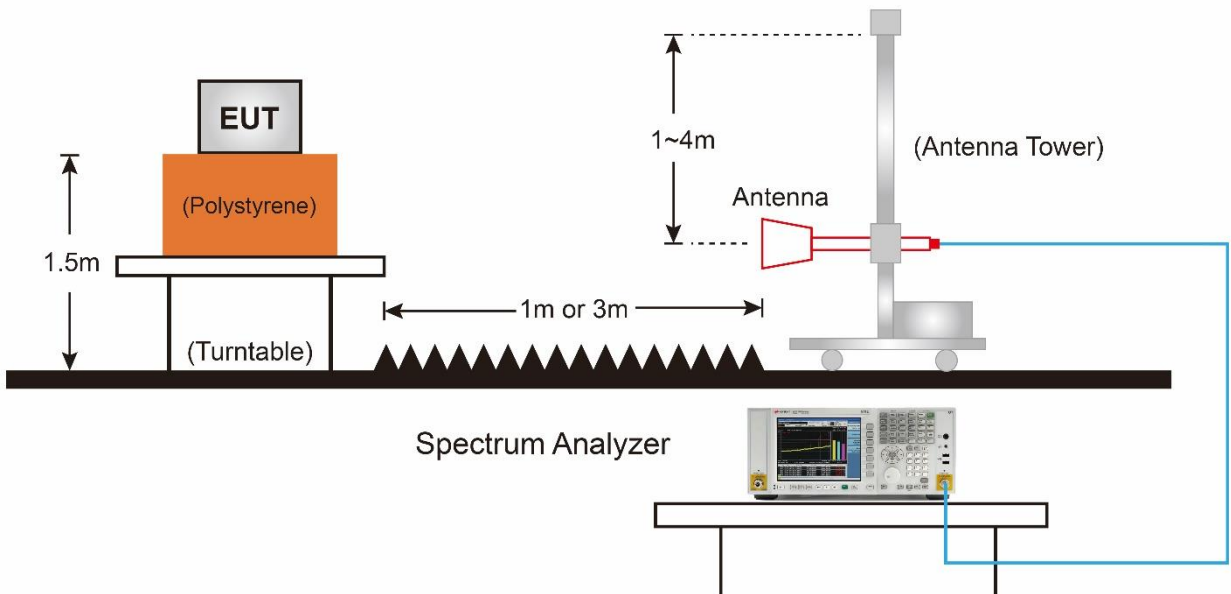

**7.7.5.Test Result**

EUT	ACCESS POINT	Date of Test	2022-01-06
Factor	BBHA 9120D (1GHz~18GHz)_2021	Temp. / Humidity	25.4°C/45.9%
Polarity	Horizontal	Site / Test Engineer	AC1 / Jay Chu
Test Mode	Transmit by 802.11a at Channel 5180MHz	Test Voltage	120V/60Hz

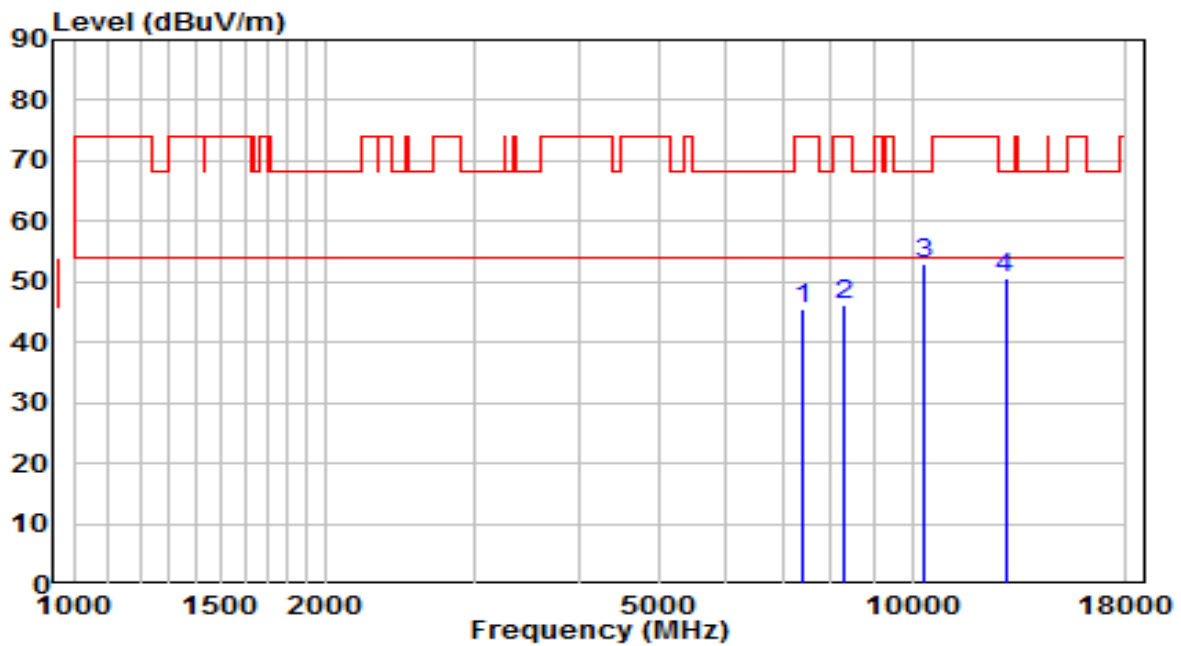

No	Frequency (MHz)	Reading (dBμV)	C.F (dB/m)	Measurement (dBμV/m)	Margin (dB)	Limit (dBμV/m)	Remark (QP/PK/AV)
1	7409.000	32.97	12.61	45.58	-28.42	74.00	Peak
2	8318.500	32.54	13.57	46.11	-27.89	74.00	Peak
3	* 10358.500	34.85	18.00	52.85	-15.35	68.20	Peak
4	12917.000	31.08	19.64	50.72	-17.48	68.20	Peak

Note:

- "\*" , means this data is the worst emission level.
- C.F (Correction Factor) = Antenna Factor (dB/m) + Cable Loss (dB) – Pre-amplifier(dB).
- Measurement(dBμV/m) = Reading(dBμV) + C.F (Correction Factor).

EUT	ACCESS POINT	Date of Test	2022-01-06
Factor	BBHA 9120D (1GHz~18GHz)_2021	Temp. / Humidity	25.4°C/45.9%
Polarity	Vertical	Site / Test Engineer	AC1 / Jay Chu
Test Mode	Transmit by 802.11a at Channel 5180MHz	Test Voltage	120V/60Hz

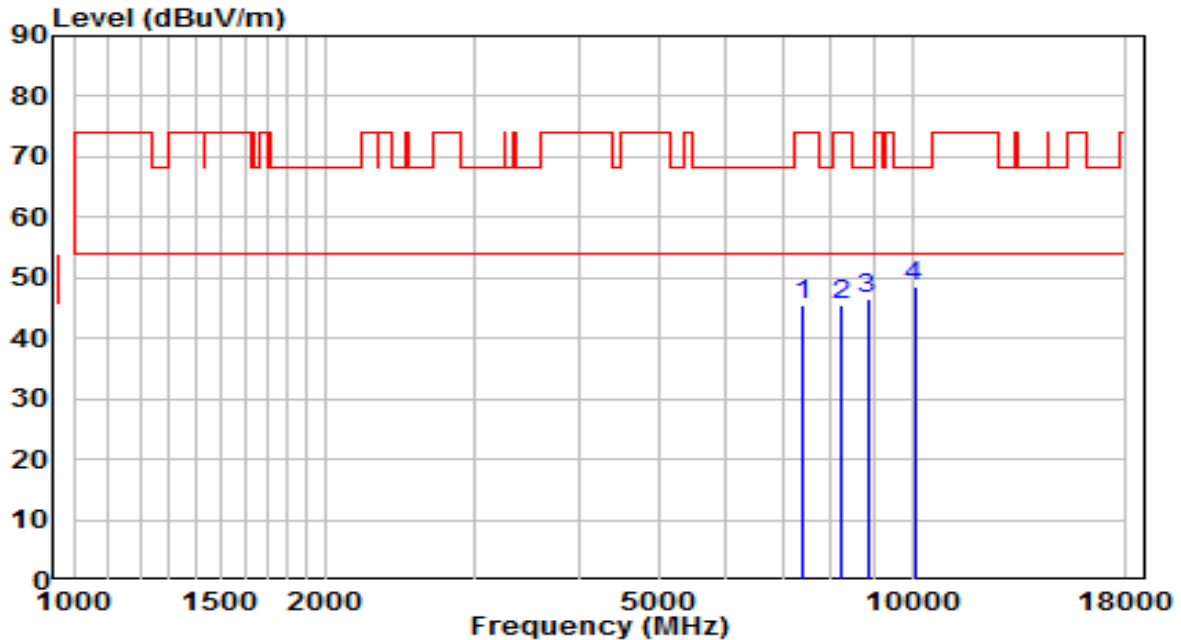

No	Frequency (MHz)	Reading (dBμV)	C.F (dB/m)	Measurement (dBμV/m)	Margin (dB)	Limit (dBμV/m)	Remark (QP/PK/AV)
1	7400.500	32.91	12.57	45.48	-28.52	74.00	Peak
2	8208.000	31.99	13.52	45.51	-28.49	74.00	Peak
3	8845.500	31.99	14.50	46.49	-21.71	68.20	Peak
4	* 10061.000	31.81	16.81	48.62	-19.58	68.20	Peak

Note:

1. " \*", means this data is the worst emission level.
2. C.F (Correction Factor) = Antenna Factor (dB/m) + Cable Loss (dB) – Preamplifier(dB).
3. Measurement(dBμV/m) = Reading(dBμV) + C.F (Correction Factor).



EUT	ACCESS POINT	Date of Test	2022-01-06
Factor	BBHA 9120D (1GHz~18GHz)_2021	Temp. / Humidity	25.4°C/45.9%
Polarity	Horizontal	Site / Test Engineer	AC1 / Jay Chu
Test Mode	Transmit by 802.11a at Channel 5220MHz	Test Voltage	120V/60Hz

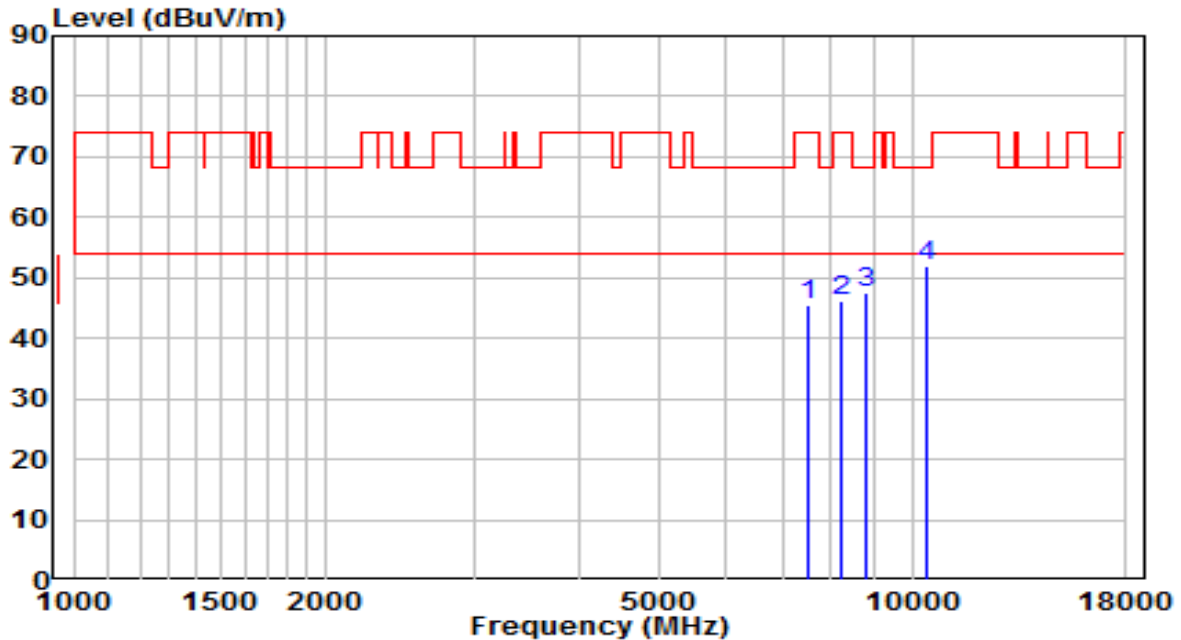

No	Frequency (MHz)	Reading (dB $\mu$ V)	C.F (dB/m)	Measurement (dB $\mu$ V/m)	Margin (dB)	Limit (dB $\mu$ V/m)	Remark (QP/PK/AV)
1	7502.500	32.51	13.02	45.53	-28.47	74.00	Peak
2	8225.000	32.61	13.53	46.14	-27.86	74.00	Peak
3	8820.000	33.12	14.44	47.56	-20.64	68.20	Peak
4	* 10443.500	33.47	18.34	51.81	-16.39	68.20	Peak

Note:

1. " \*", means this data is the worst emission level.
2. C.F (Correction Factor) = Antenna Factor (dB/m) + Cable Loss (dB) – Pre-amplifier(dB).
3. Measurement(dB $\mu$ V/m) = Reading(dB $\mu$ V) + C.F (Correction Factor).

EUT	ACCESS POINT	Date of Test	2022-01-06
Factor	BBHA 9120D (1GHz~18GHz)_2021	Temp. / Humidity	25.4°C/45.9%
Polarity	Vertical	Site / Test Engineer	AC1 / Jay Chu
Test Mode	Transmit by 802.11a at Channel 5220MHz	Test Voltage	120V/60Hz

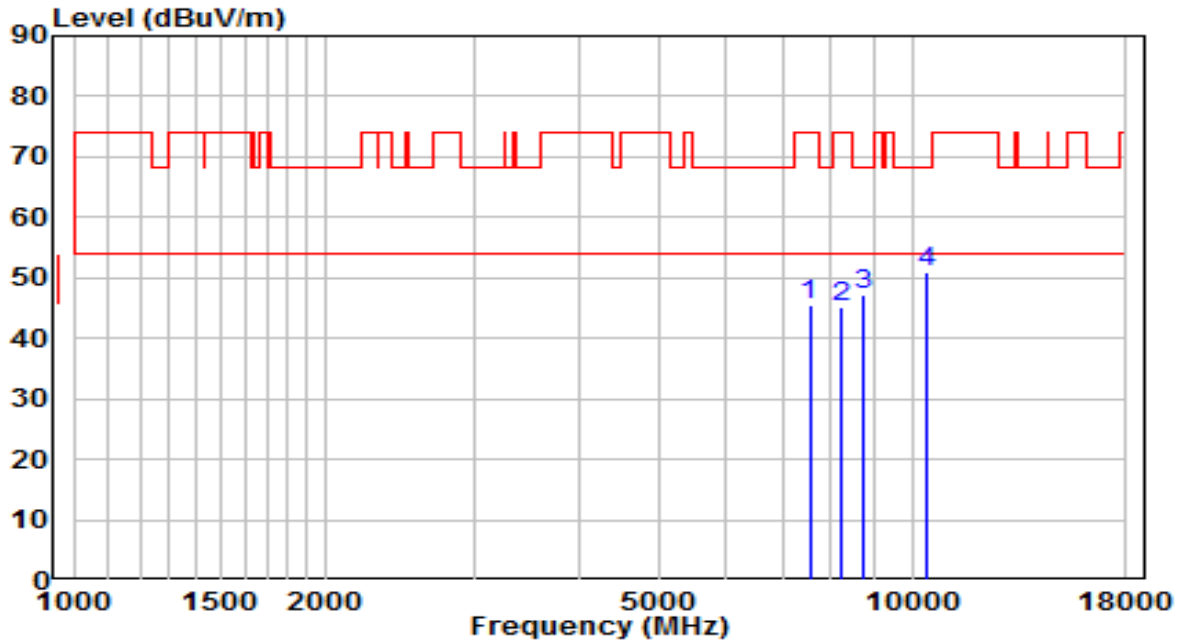

No	Frequency (MHz)	Reading (dBμV)	C.F (dB/m)	Measurement (dBμV/m)	Margin (dB)	Limit (dBμV/m)	Remark (QP/PK/AV)
1	7545.000	32.31	13.05	45.36	-28.64	74.00	Peak
2	8225.000	31.78	13.53	45.31	-28.69	74.00	Peak
3	8769.000	32.76	14.31	47.08	-21.12	68.20	Peak
4	* 10443.500	32.65	18.34	50.99	-17.21	68.20	Peak

Note:

1. " \*", means this data is the worst emission level.
2. C.F (Correction Factor) = Antenna Factor (dB/m) + Cable Loss (dB) – Preamplifier(dB).
3. Measurement(dBμV/m) = Reading(dBμV) + C.F (Correction Factor).

EUT	ACCESS POINT	Date of Test	2022-01-06
Factor	BBHA 9120D (1GHz~18GHz)_2021	Temp. / Humidity	25.4°C/45.9%
Polarity	Horizontal	Site / Test Engineer	AC1 / Jay Chu
Test Mode	Transmit by 802.11a at Channel 5240MHz	Test Voltage	120V/60Hz

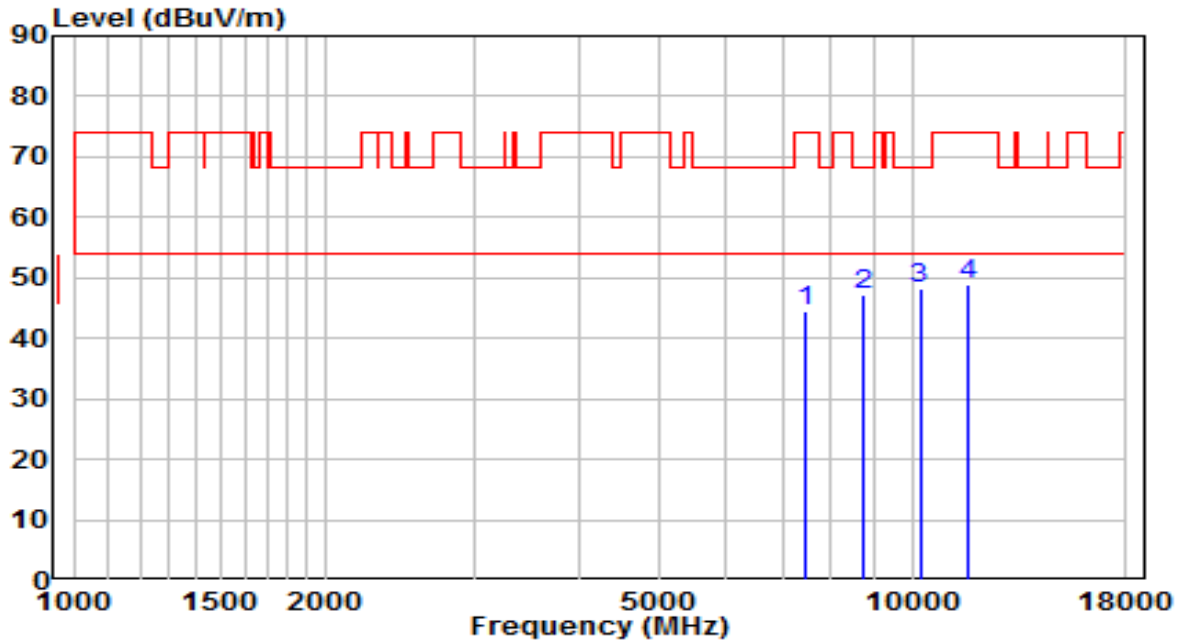

No	Frequency (MHz)	Reading (dB $\mu$ V)	C.F (dB/m)	Measurement (dB $\mu$ V/m)	Margin (dB)	Limit (dB $\mu$ V/m)	Remark (QP/PK/AV)
1	7451.500	31.67	12.80	44.47	-29.53	74.00	Peak
2	8760.500	32.92	14.29	47.22	-20.98	68.20	Peak
3	* 10214.000	30.65	17.42	48.07	-20.13	68.20	Peak
4	11684.500	29.22	19.63	48.85	-25.15	74.00	Peak

Note:

1. " \*", means this data is the worst emission level.
2. C.F (Correction Factor) = Antenna Factor (dB/m) + Cable Loss (dB) – Pre-amplifier(dB).
3. Measurement(dB $\mu$ V/m) = Reading(dB $\mu$ V) + C.F (Correction Factor).

EUT	ACCESS POINT	Date of Test	2022-01-06
Factor	BBHA 9120D (1GHz~18GHz)_2021	Temp. / Humidity	25.4°C/45.9%
Polarity	Vertical	Site / Test Engineer	AC1 / Jay Chu
Test Mode	Transmit by 802.11a at Channel 5240MHz	Test Voltage	120V/60Hz

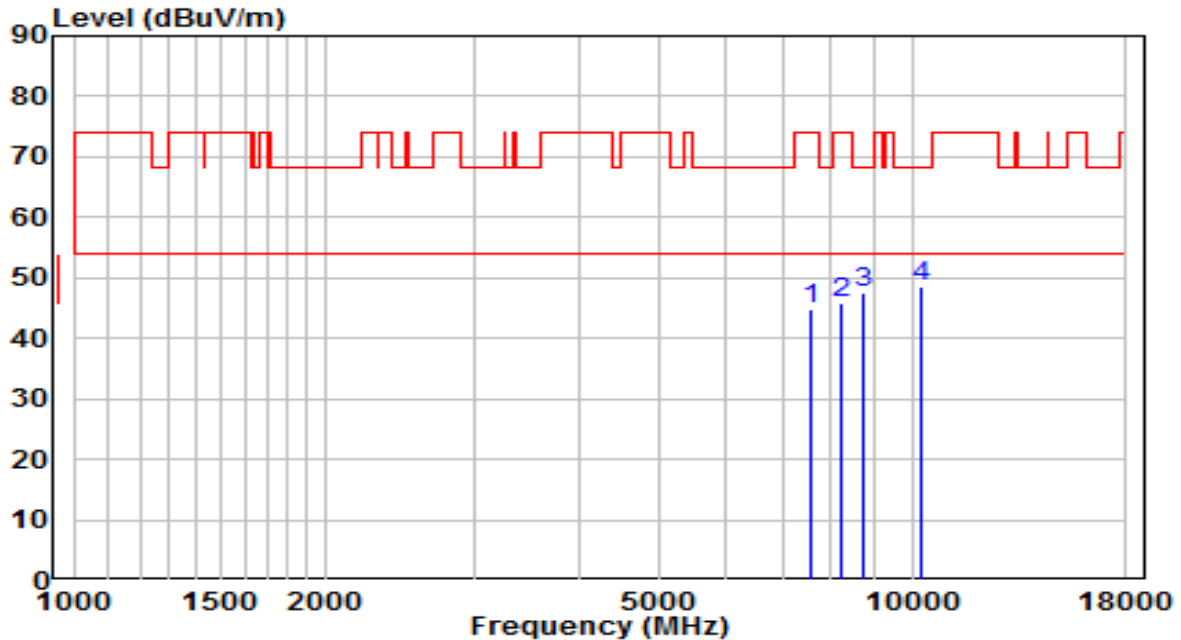

No	Frequency (MHz)	Reading (dB $\mu$ V)	C.F (dB/m)	Measurement (dB $\mu$ V/m)	Margin (dB)	Limit (dB $\mu$ V/m)	Remark (QP/PK/AV)
1	7579.000	31.87	13.08	44.95	-29.05	74.00	Peak
2	8225.000	32.34	13.53	45.87	-28.13	74.00	Peak
3	8718.000	33.25	14.19	47.44	-20.76	68.20	Peak
4	* 10222.500	31.00	17.45	48.45	-19.75	68.20	Peak

Note:

1. " \*", means this data is the worst emission level.
2. C.F (Correction Factor) = Antenna Factor (dB/m) + Cable Loss (dB) – Preamplifier(dB).
3. Measurement(dB $\mu$ V/m) = Reading(dB $\mu$ V) + C.F (Correction Factor).

EUT	ACCESS POINT	Date of Test	2022-01-06
Factor	BBHA 9120D (1GHz~18GHz)_2021	Temp. / Humidity	25.4°C/45.9%
Polarity	Horizontal	Site / Test Engineer	AC1 / Jay Chu
Test Mode	Transmit by 802.11a at Channel 5260MHz	Test Voltage	120V/60Hz

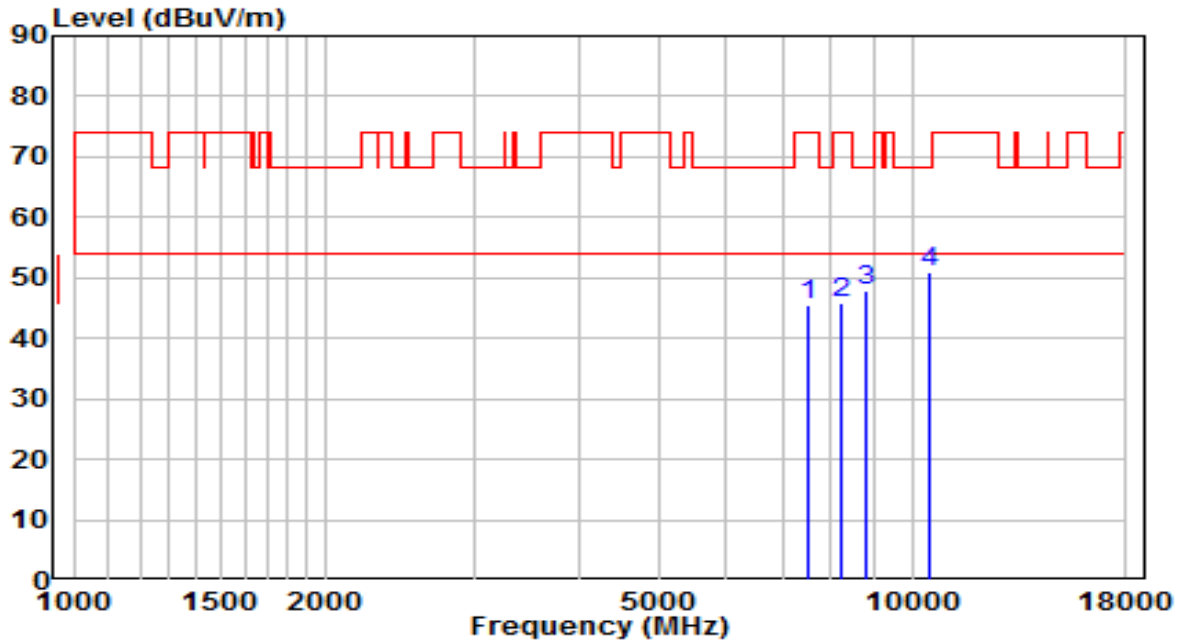

No	Frequency (MHz)	Reading (dBμV)	C.F (dB/m)	Measurement (dBμV/m)	Margin (dB)	Limit (dBμV/m)	Remark (QP/PK/AV)
1	7494.000	32.42	12.99	45.41	-28.59	74.00	Peak
2	8250.500	32.17	13.54	45.72	-28.28	74.00	Peak
3	8803.000	33.44	14.40	47.83	-20.37	68.20	Peak
4	* 10520.000	32.21	18.60	50.81	-17.39	68.20	Peak

Note:

1. " \*", means this data is the worst emission level.
2. C.F (Correction Factor) = Antenna Factor (dB/m) + Cable Loss (dB) – Preamplifier(dB).
3. Measurement(dBμV/m) = Reading(dBμV) + C.F (Correction Factor).

EUT	ACCESS POINT	Date of Test	2022-01-06
Factor	BBHA 9120D (1GHz~18GHz)_2021	Temp. / Humidity	25.4°C/45.9%
Polarity	Vertical	Site / Test Engineer	AC1 / Jay Chu
Test Mode	Transmit by 802.11a at Channel 5260MHz	Test Voltage	120V/60Hz

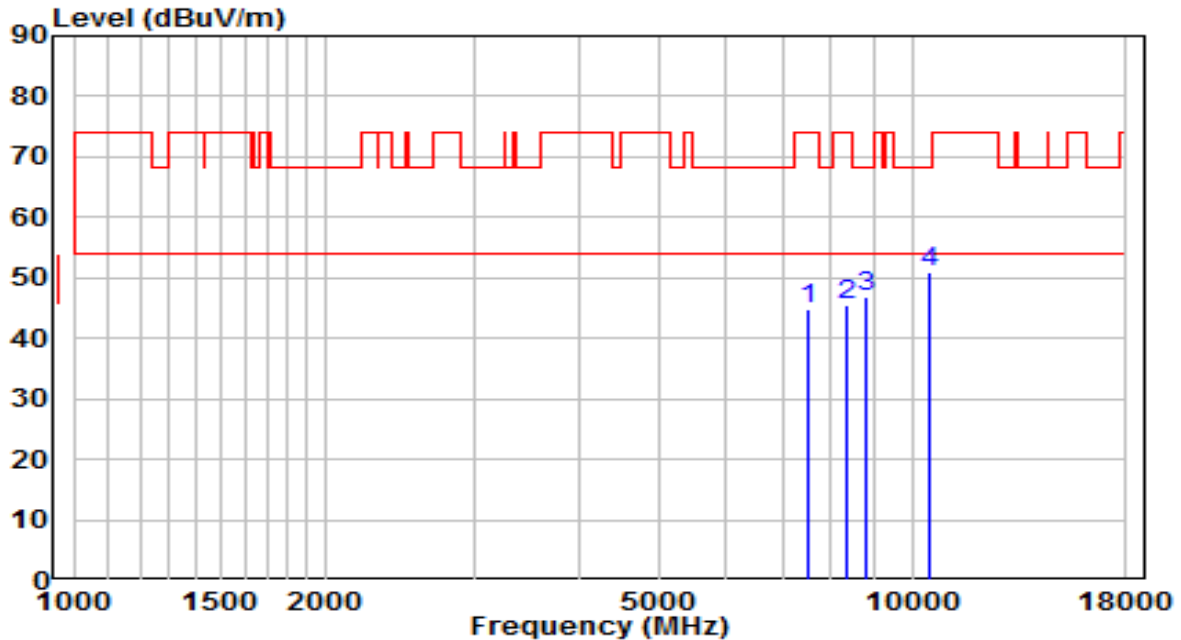

No	Frequency (MHz)	Reading (dB $\mu$ V)	C.F (dB/m)	Measurement (dB $\mu$ V/m)	Margin (dB)	Limit (dB $\mu$ V/m)	Remark (QP/PK/AV)
1	7519.500	31.73	13.03	44.77	-29.23	74.00	Peak
2	8335.500	32.05	13.58	45.63	-28.37	74.00	Peak
3	8803.000	32.30	14.40	46.70	-21.50	68.20	Peak
4	* 10520.000	32.38	18.60	50.97	-17.23	68.20	Peak

Note:

1. " \*", means this data is the worst emission level.
2. C.F (Correction Factor) = Antenna Factor (dB/m) + Cable Loss (dB) – Preamplifier(dB).
3. Measurement(dB $\mu$ V/m) = Reading(dB $\mu$ V) + C.F (Correction Factor).

EUT	ACCESS POINT	Date of Test	2022-01-06
Factor	BBHA 9120D (1GHz~18GHz)_2021	Temp. / Humidity	25.4°C/45.9%
Polarity	Horizontal	Site / Test Engineer	AC1 / Jay Chu
Test Mode	Transmit by 802.11a at Channel 5300MHz	Test Voltage	120V/60Hz

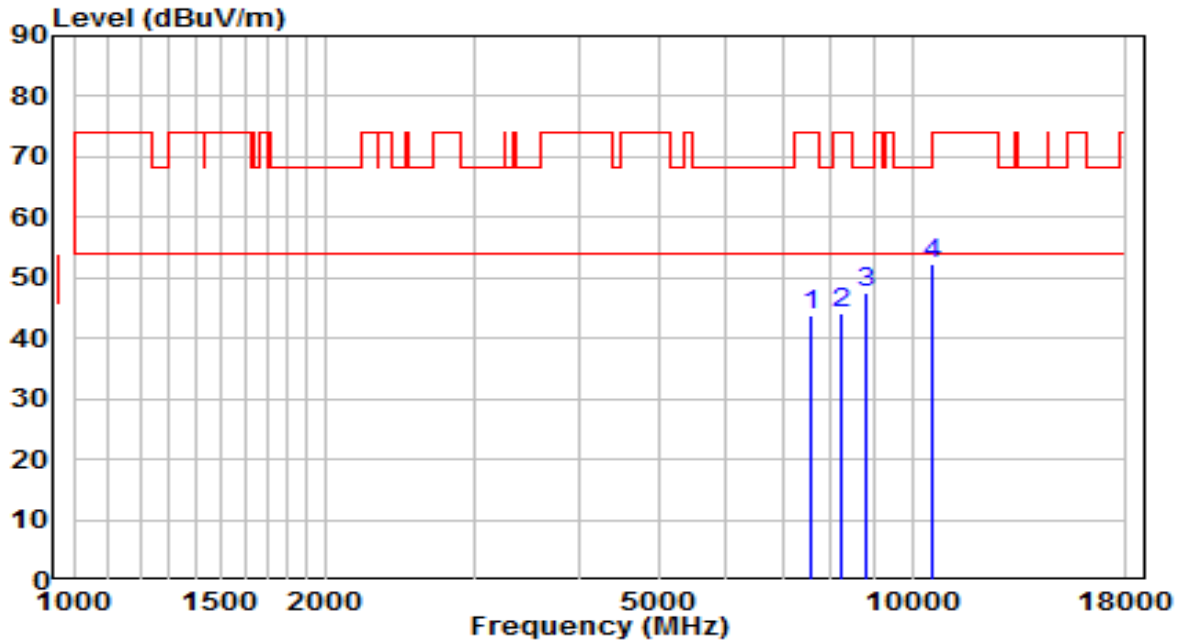

No	Frequency (MHz)	Reading (dB $\mu$ V)	C.F (dB/m)	Measurement (dB $\mu$ V/m)	Margin (dB)	Limit (dB $\mu$ V/m)	Remark (QP/PK/AV)
1	7553.500	30.76	13.06	43.82	-30.18	74.00	Peak
2	8208.000	30.72	13.52	44.24	-29.76	74.00	Peak
3	8837.000	32.91	14.48	47.39	-20.81	68.20	Peak
4	* 10596.500	33.70	18.71	52.41	-15.79	68.20	Peak

Note:

1. " \*", means this data is the worst emission level.
2. C.F (Correction Factor) = Antenna Factor (dB/m) + Cable Loss (dB) – Preamplifier(dB).
3. Measurement(dB $\mu$ V/m) = Reading(dB $\mu$ V) + C.F (Correction Factor).

EUT	ACCESS POINT	Date of Test	2022-01-06
Factor	BBHA 9120D (1GHz~18GHz)_2021	Temp. / Humidity	25.4°C/45.9%
Polarity	Vertical	Site / Test Engineer	AC1 / Jay Chu
Test Mode	Transmit by 802.11a at Channel 5300MHz	Test Voltage	120V/60Hz

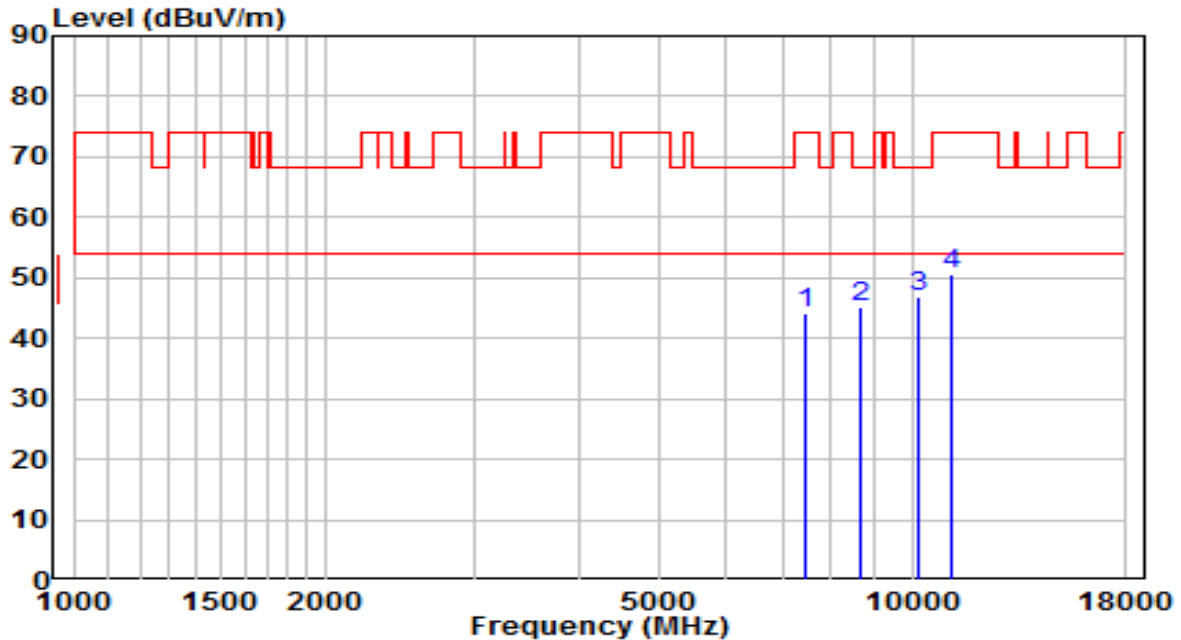

No	Frequency (MHz)	Reading (dB $\mu$ V)	C.F (dB/m)	Measurement (dB $\mu$ V/m)	Margin (dB)	Limit (dB $\mu$ V/m)	Remark (QP/PK/AV)
1	7477.000	31.38	12.91	44.29	-29.71	74.00	Peak
2	8701.000	31.19	14.15	45.33	-22.87	68.20	Peak
3	* 10163.000	29.67	17.22	46.88	-21.32	68.20	Peak
4	11157.500	31.00	19.52	50.53	-23.47	74.00	Peak

Note:

1. " \*", means this data is the worst emission level.
2. C.F (Correction Factor) = Antenna Factor (dB/m) + Cable Loss (dB) – Preamplifier(dB).
3. Measurement(dB $\mu$ V/m) = Reading(dB $\mu$ V) + C.F (Correction Factor).



EUT	ACCESS POINT	Date of Test	2022-01-06
Factor	BBHA 9120D (1GHz~18GHz)_2021	Temp. / Humidity	25.4°C/45.9%
Polarity	Horizontal	Site / Test Engineer	AC1 / Jay Chu
Test Mode	Transmit by 802.11a at Channel 5320MHz	Test Voltage	120V/60Hz

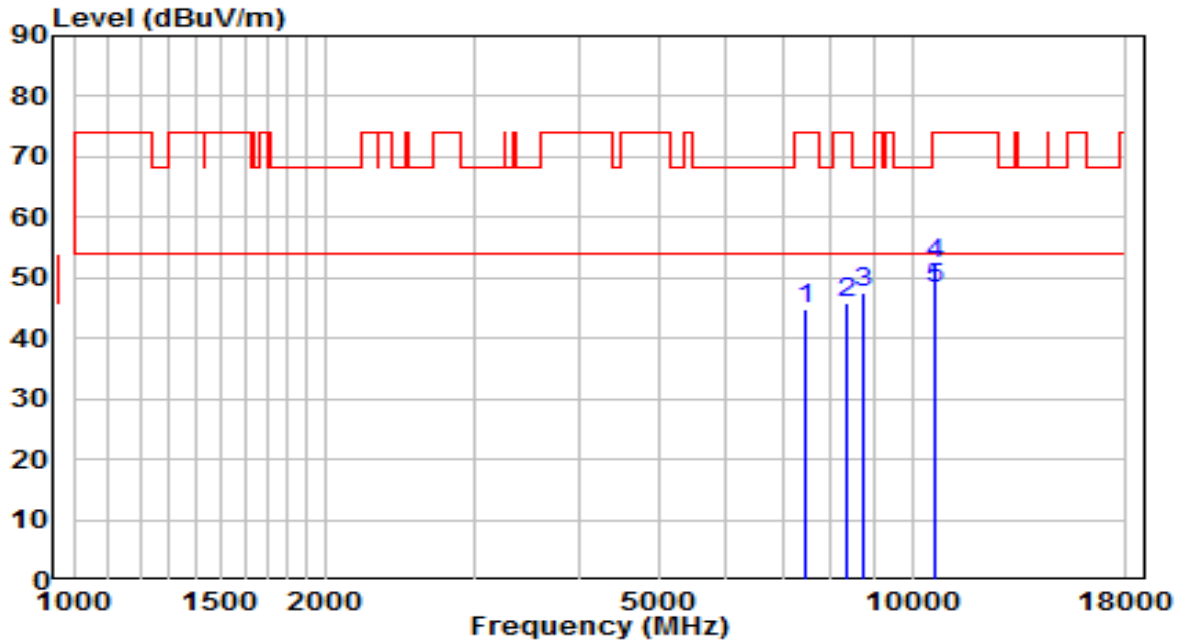

No	Frequency (MHz)	Reading (dBμV)	C.F (dB/m)	Measurement (dBμV/m)	Margin (dB)	Limit (dBμV/m)	Remark (QP/PK/AV)
1	7468.500	31.88	12.88	44.76	-29.24	74.00	Peak
2	8344.000	32.11	13.58	45.69	-28.31	74.00	Peak
3	8752.000	33.14	14.27	47.41	-20.79	68.20	Peak
4	10639.000	33.43	18.77	52.20	-21.80	74.00	Peak
5	* 10639.000	29.47	18.77	48.24	-5.76	54.00	Average

Note:

1. " \*", means this data is the worst emission level.
2. C.F (Correction Factor) = Antenna Factor (dB/m) + Cable Loss (dB) – Pre-amplifier(dB).
3. Measurement(dBμV/m) = Reading(dBμV) + C.F (Correction Factor).

EUT	ACCESS POINT	Date of Test	2022-01-06
Factor	BBHA 9120D (1GHz~18GHz)_2021	Temp. / Humidity	25.4°C/45.9%
Polarity	Vertical	Site / Test Engineer	AC1 / Jay Chu
Test Mode	Transmit by 802.11a at Channel 5320MHz	Test Voltage	120V/60Hz

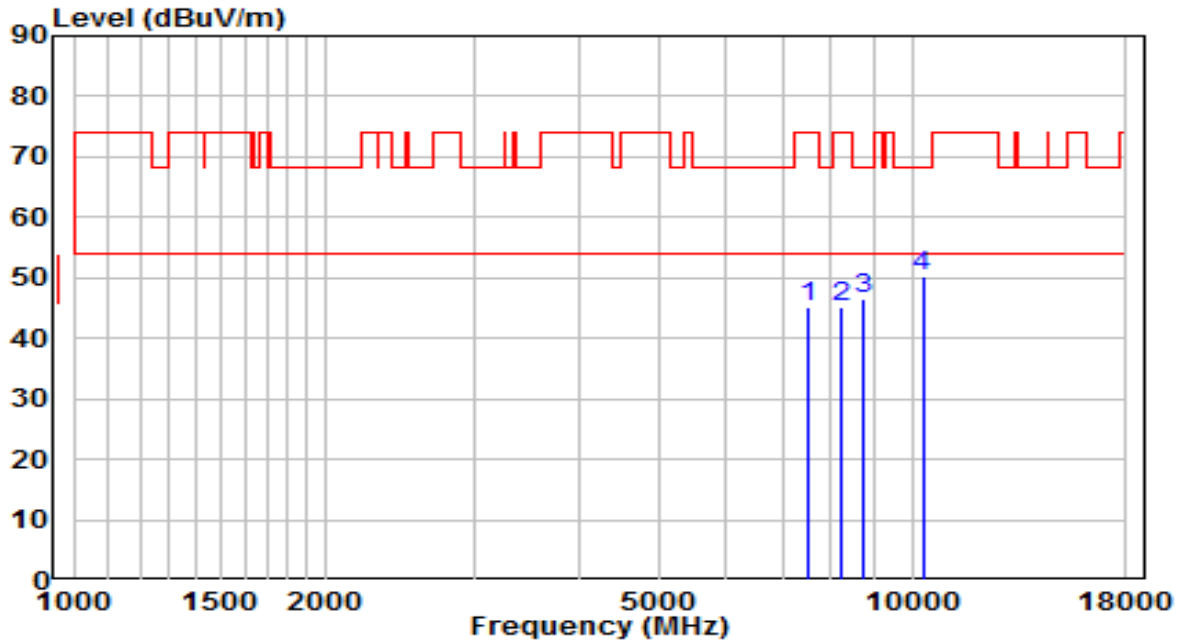

No	Frequency (MHz)	Reading (dB $\mu$ V)	C.F (dB/m)	Measurement (dB $\mu$ V/m)	Margin (dB)	Limit (dB $\mu$ V/m)	Remark (QP/PK/AV)
1	7502.500	32.31	13.02	45.33	-28.67	74.00	Peak
2	8242.000	31.67	13.54	45.21	-28.79	74.00	Peak
3	8743.500	32.31	14.25	46.56	-21.64	68.20	Peak
4	* 10290.500	32.38	17.73	50.11	-18.09	68.20	Peak

Note:

1. " \*", means this data is the worst emission level.
2. C.F (Correction Factor) = Antenna Factor (dB/m) + Cable Loss (dB) – Pre-amplifier(dB).
3. Measurement(dB $\mu$ V/m) = Reading(dB $\mu$ V) + C.F (Correction Factor).

EUT	ACCESS POINT	Date of Test	2022-01-06
Factor	BBHA 9120D (1GHz~18GHz)_2021	Temp. / Humidity	25.4°C/45.9%
Polarity	Horizontal	Site / Test Engineer	AC1 / Jay Chu
Test Mode	Transmit by 802.11a at Channel 5500MHz	Test Voltage	120V/60Hz

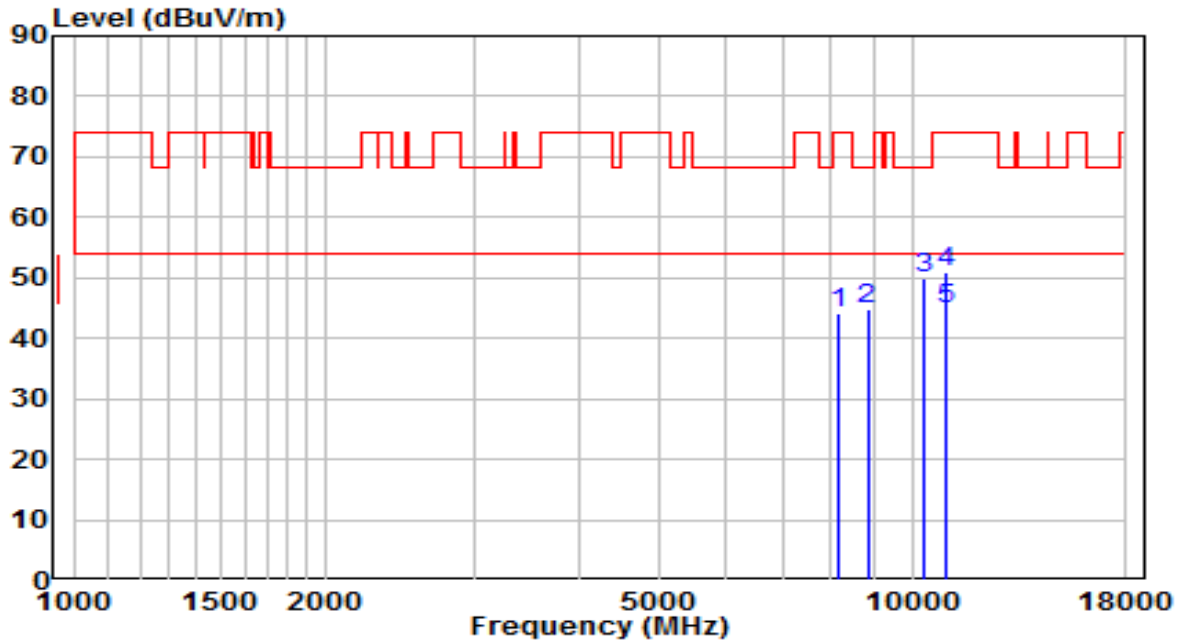

No	Frequency (MHz)	Reading (dB $\mu$ V)	C.F (dB/m)	Measurement (dB $\mu$ V/m)	Margin (dB)	Limit (dB $\mu$ V/m)	Remark (QP/PK/AV)
1	8174.000	30.68	13.51	44.19	-29.81	74.00	Peak
2	8845.500	30.49	14.50	44.99	-23.21	68.20	Peak
3	10350.000	31.80	17.97	49.76	-18.44	68.20	Peak
4	10996.000	31.77	19.27	51.04	-22.96	74.00	Peak
5	* 10996.000	25.49	19.27	44.77	-9.23	54.00	Average

Note:

1. " \*", means this data is the worst emission level.
2. C.F (Correction Factor) = Antenna Factor (dB/m) + Cable Loss (dB) – Pre-amplifier(dB).
3. Measurement(dB $\mu$ V/m) = Reading(dB $\mu$ V) + C.F (Correction Factor).

EUT	ACCESS POINT	Date of Test	2022-01-06
Factor	BBHA 9120D (1GHz~18GHz)_2021	Temp. / Humidity	25.4°C/45.9%
Polarity	Vertical	Site / Test Engineer	AC1 / Jay Chu
Test Mode	Transmit by 802.11a at Channel 5500MHz	Test Voltage	120V/60Hz

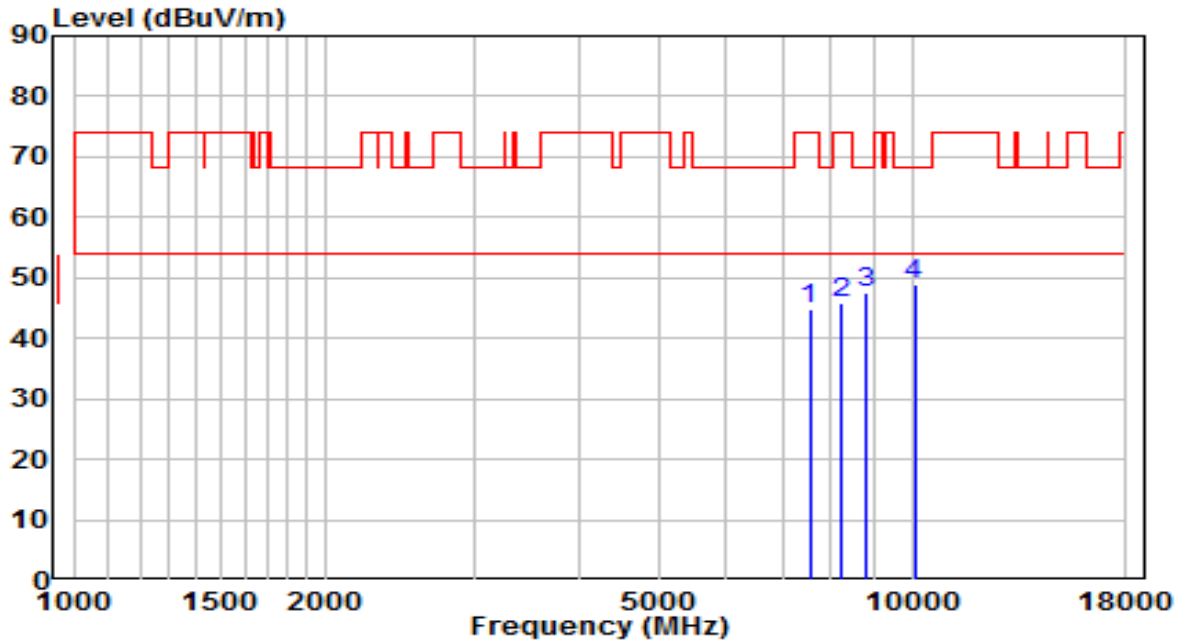

No	Frequency (MHz)	Reading (dB $\mu$ V)	C.F (dB/m)	Measurement (dB $\mu$ V/m)	Margin (dB)	Limit (dB $\mu$ V/m)	Remark (QP/PK/AV)
1	7545.000	31.93	13.05	44.98	-29.02	74.00	Peak
2	8259.000	32.44	13.55	45.98	-28.02	74.00	Peak
3	8803.000	33.22	14.40	47.61	-20.59	68.20	Peak
4	* 10061.000	32.14	16.81	48.95	-19.25	68.20	Peak

Note:

1. " \*", means this data is the worst emission level.
2. C.F (Correction Factor) = Antenna Factor (dB/m) + Cable Loss (dB) – Pre-amplifier(dB).
3. Measurement(dB $\mu$ V/m) = Reading(dB $\mu$ V) + C.F (Correction Factor).

EUT	ACCESS POINT	Date of Test	2022-01-06
Factor	BBHA 9120D (1GHz~18GHz)_2021	Temp. / Humidity	25.4°C/45.9%
Polarity	Horizontal	Site / Test Engineer	AC1 / Jay Chu
Test Mode	Transmit by 802.11a at Channel 5580MHz	Test Voltage	120V/60Hz

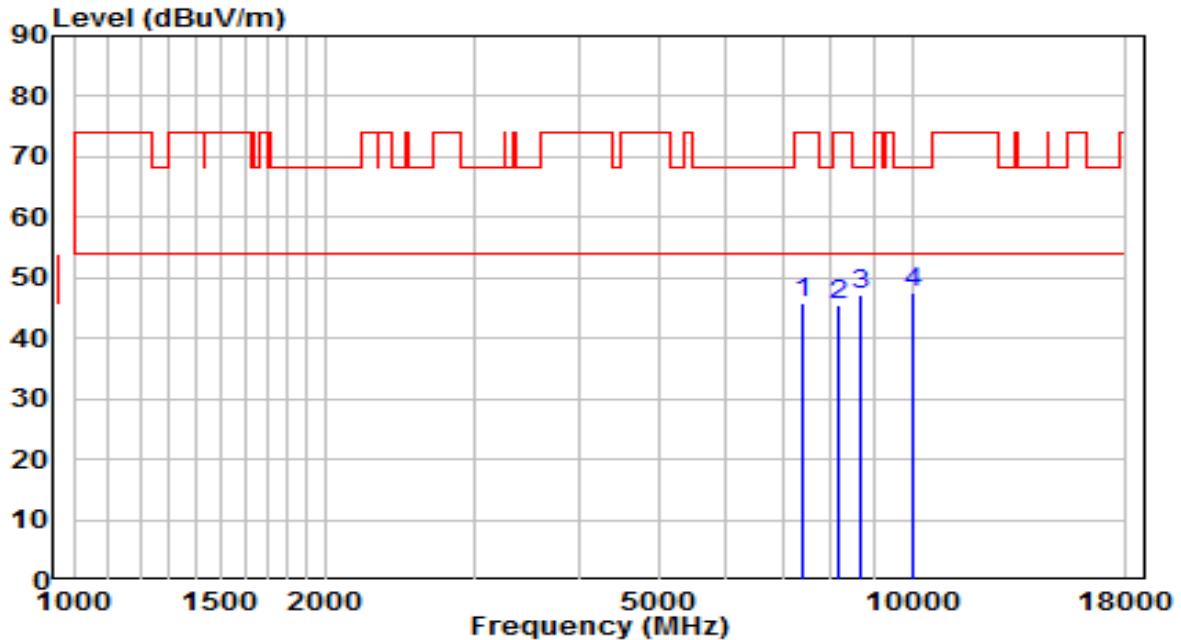

No	Frequency (MHz)	Reading (dB $\mu$ V)	C.F (dB/m)	Measurement (dB $\mu$ V/m)	Margin (dB)	Limit (dB $\mu$ V/m)	Remark (QP/PK/AV)
1	7392.000	33.17	12.54	45.71	-28.29	74.00	Peak
2	8148.500	32.15	13.50	45.65	-28.35	74.00	Peak
3	8658.500	33.00	14.04	47.04	-21.16	68.20	Peak
4	* 10044.000	30.98	16.74	47.71	-20.49	68.20	Peak

Note:

1. " \*", means this data is the worst emission level.
2. C.F (Correction Factor) = Antenna Factor (dB/m) + Cable Loss (dB) – Preamplifier(dB).
3. Measurement(dB $\mu$ V/m) = Reading(dB $\mu$ V) + C.F (Correction Factor).

EUT	ACCESS POINT	Date of Test	2022-01-06
Factor	BBHA 9120D (1GHz~18GHz)_2021	Temp. / Humidity	25.4°C/45.9%
Polarity	Vertical	Site / Test Engineer	AC1 / Jay Chu
Test Mode	Transmit by 802.11a at Channel 5580MHz	Test Voltage	120V/60Hz

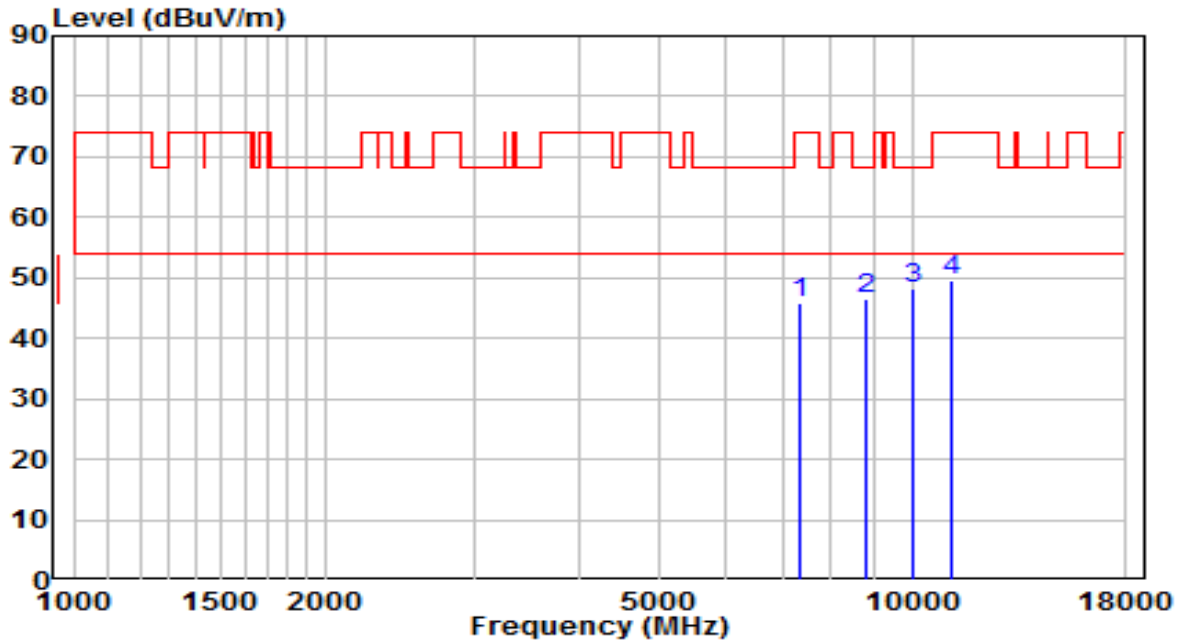

No	Frequency (MHz)	Reading (dB $\mu$ V)	C.F (dB/m)	Measurement (dB $\mu$ V/m)	Margin (dB)	Limit (dB $\mu$ V/m)	Remark (QP/PK/AV)
1	7349.500	33.66	12.35	46.01	-27.99	74.00	Peak
2	8786.000	32.27	14.36	46.63	-21.57	68.20	Peak
3	* 10010.000	31.77	16.60	48.37	-19.83	68.20	Peak
4	11157.500	30.08	19.52	49.60	-24.40	74.00	Peak

Note:

1. " \*", means this data is the worst emission level.
2. C.F (Correction Factor) = Antenna Factor (dB/m) + Cable Loss (dB) – Preamplifier(dB).
3. Measurement(dB $\mu$ V/m) = Reading(dB $\mu$ V) + C.F (Correction Factor).

EUT	ACCESS POINT	Date of Test	2022-01-06
Factor	BBHA 9120D (1GHz~18GHz)_2021	Temp. / Humidity	25.4°C/45.9%
Polarity	Horizontal	Site / Test Engineer	AC1 / Jay Chu
Test Mode	Transmit by 802.11a at Channel 5700MHz	Test Voltage	120V/60Hz

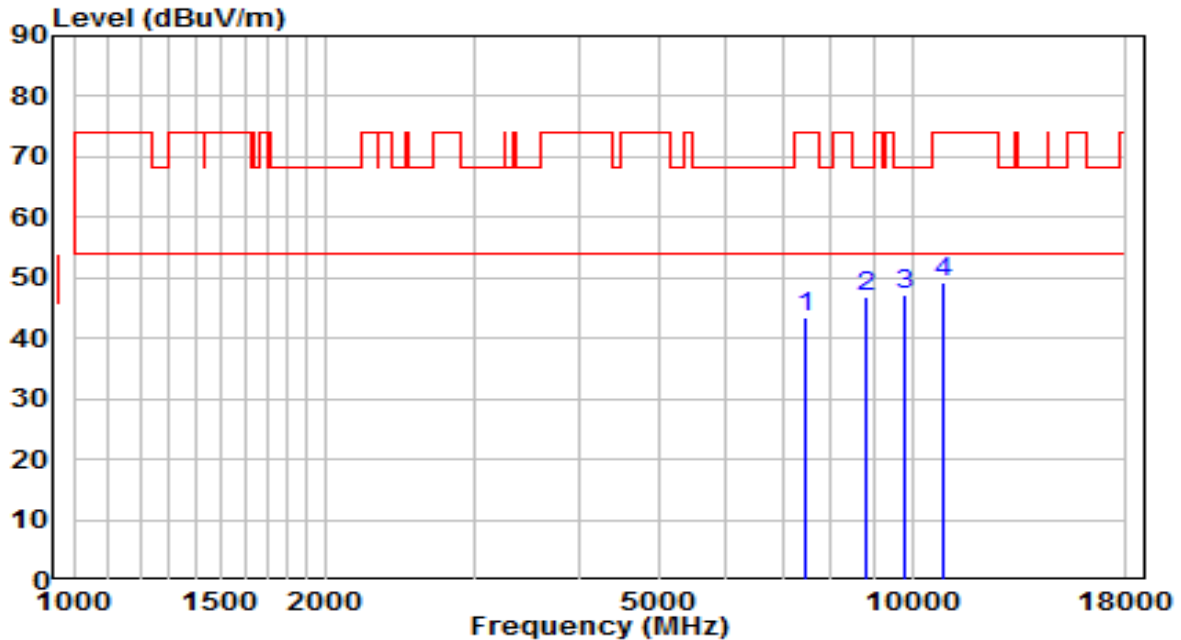

No	Frequency (MHz)	Reading (dB $\mu$ V)	C.F (dB/m)	Measurement (dB $\mu$ V/m)	Margin (dB)	Limit (dB $\mu$ V/m)	Remark (QP/PK/AV)
1	7468.500	30.71	12.88	43.58	-30.42	74.00	Peak
2	8820.000	32.31	14.44	46.75	-21.45	68.20	Peak
3	* 9780.500	30.96	16.19	47.15	-21.05	68.20	Peak
4	10902.500	30.05	19.14	49.19	-24.81	74.00	Peak

Note:

1. " \*", means this data is the worst emission level.
2. C.F (Correction Factor) = Antenna Factor (dB/m) + Cable Loss (dB) – Pre-amplifier(dB).
3. Measurement(dB $\mu$ V/m) = Reading(dB $\mu$ V) + C.F (Correction Factor).

EUT	ACCESS POINT	Date of Test	2022-01-06
Factor	BBHA 9120D (1GHz~18GHz)_2021	Temp. / Humidity	25.4°C/45.9%
Polarity	Vertical	Site / Test Engineer	AC1 / Jay Chu
Test Mode	Transmit by 802.11a at Channel 5700MHz	Test Voltage	120V/60Hz

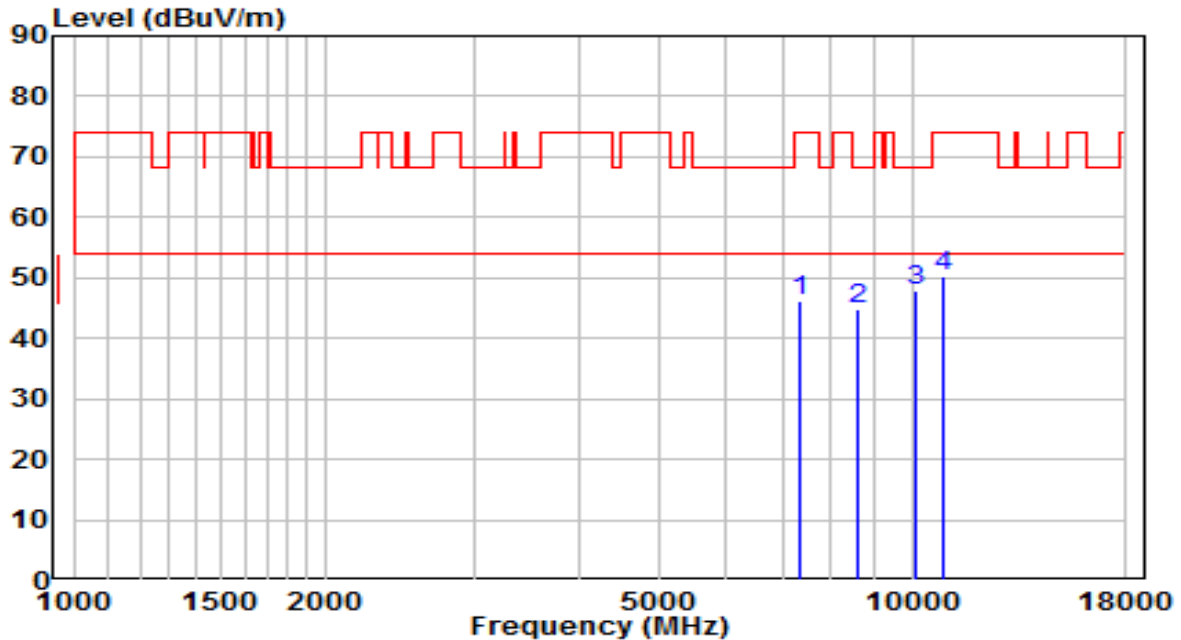

No	Frequency (MHz)	Reading (dBμV)	C.F (dB/m)	Measurement (dBμV/m)	Margin (dB)	Limit (dBμV/m)	Remark (QP/PK/AV)
1	7332.500	33.77	12.27	46.04	-27.96	74.00	Peak
2	8624.500	31.02	13.96	44.98	-23.22	68.20	Peak
3	* 10112.000	30.80	17.01	47.81	-20.39	68.20	Peak
4	10919.500	31.06	19.17	50.23	-23.77	74.00	Peak

Note:

1. " \*", means this data is the worst emission level.
2. C.F (Correction Factor) = Antenna Factor (dB/m) + Cable Loss (dB) – Preamplifier(dB).
3. Measurement(dBμV/m) = Reading(dBμV) + C.F (Correction Factor).



EUT	ACCESS POINT	Date of Test	2022-01-06
Factor	BBHA 9120D (1GHz~18GHz)_2021	Temp. / Humidity	25.4°C/45.9%
Polarity	Horizontal	Site / Test Engineer	AC1 / Jay Chu
Test Mode	Transmit by 802.11a at Channel 5720MHz	Test Voltage	120V/60Hz

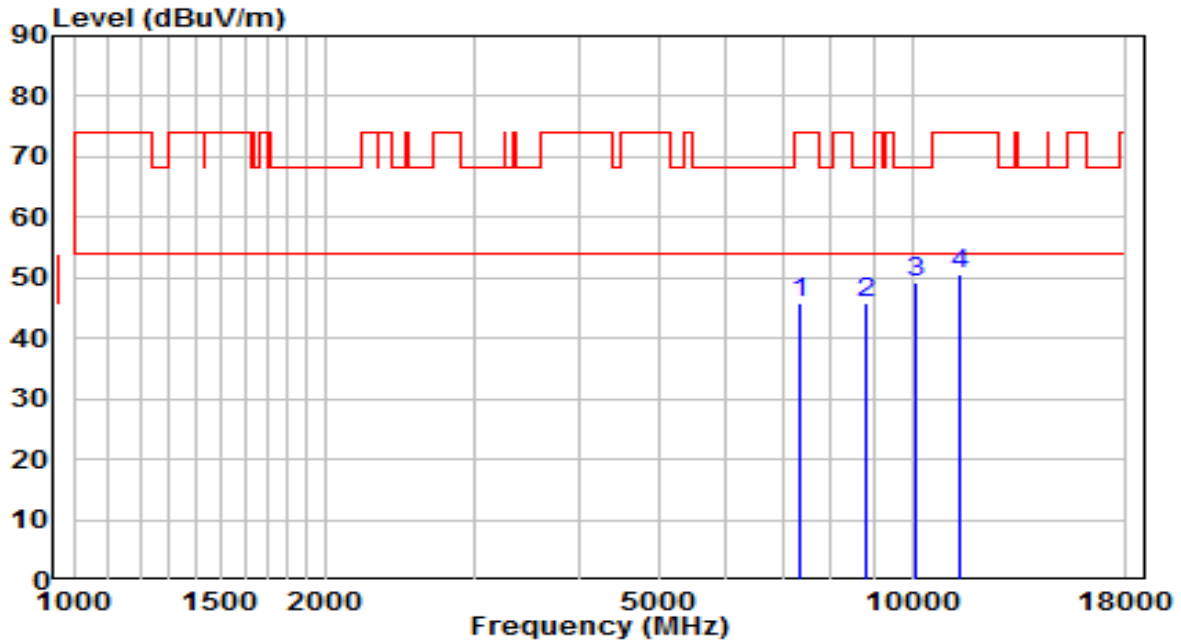

No	Frequency (MHz)	Reading (dB $\mu$ V)	C.F (dB/m)	Measurement (dB $\mu$ V/m)	Margin (dB)	Limit (dB $\mu$ V/m)	Remark (QP/PK/AV)
1	7349.500	33.35	12.35	45.69	-28.31	74.00	Peak
2	8811.500	31.58	14.42	46.00	-22.20	68.20	Peak
3	* 10103.500	32.13	16.98	49.10	-19.10	68.20	Peak
4	11438.000	30.55	19.95	50.50	-23.50	74.00	Peak

Note:

1. " \*", means this data is the worst emission level.
2. C.F (Correction Factor) = Antenna Factor (dB/m) + Cable Loss (dB) – Preamplifier(dB).
3. Measurement(dB $\mu$ V/m) = Reading(dB $\mu$ V) + C.F (Correction Factor).

EUT	ACCESS POINT	Date of Test	2022-01-06
Factor	BBHA 9120D (1GHz~18GHz)_2021	Temp. / Humidity	25.4°C/45.9%
Polarity	Vertical	Site / Test Engineer	AC1 / Jay Chu
Test Mode	Transmit by 802.11a at Channel 5720MHz	Test Voltage	120V/60Hz

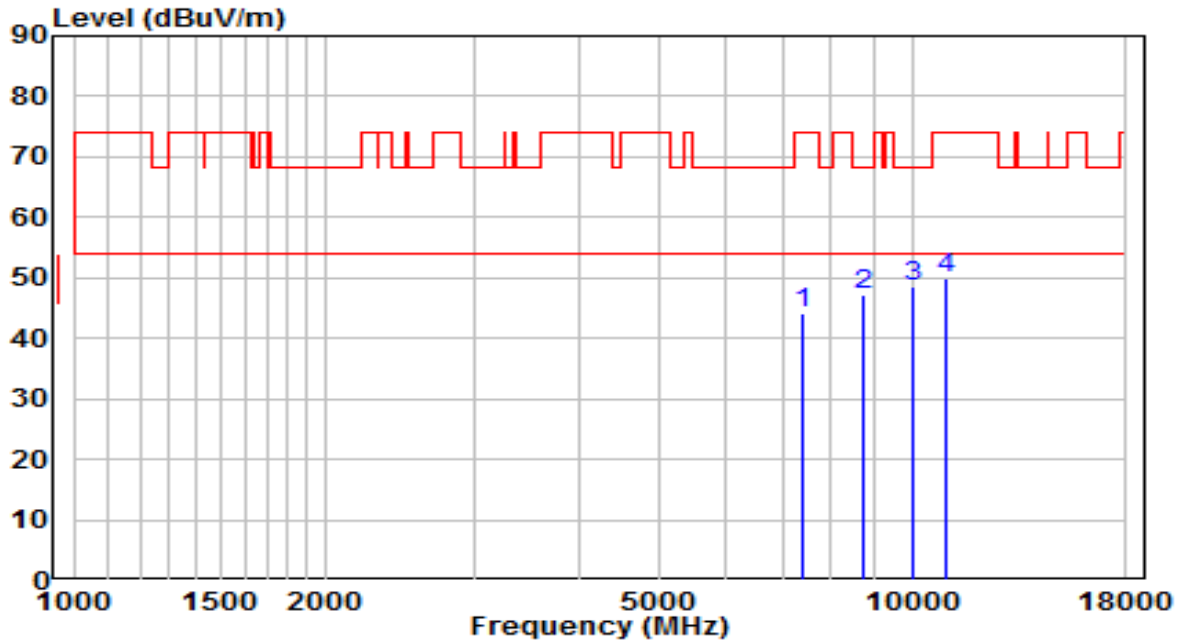

No	Frequency (MHz)	Reading (dB $\mu$ V)	C.F (dB/m)	Measurement (dB $\mu$ V/m)	Margin (dB)	Limit (dB $\mu$ V/m)	Remark (QP/PK/AV)
1	7426.000	31.49	12.69	44.18	-29.82	74.00	Peak
2	8735.000	32.87	14.23	47.10	-21.10	68.20	Peak
3	* 10052.500	31.91	16.77	48.68	-19.52	68.20	Peak
4	11004.500	30.80	19.29	50.09	-23.91	74.00	Peak

Note:

1. " \*", means this data is the worst emission level.
2. C.F (Correction Factor) = Antenna Factor (dB/m) + Cable Loss (dB) – Pre-amplifier(dB).
3. Measurement(dB $\mu$ V/m) = Reading(dB $\mu$ V) + C.F (Correction Factor).

EUT	ACCESS POINT	Date of Test	2022-01-06
Factor	BBHA 9120D (1GHz~18GHz)_2021	Temp. / Humidity	25.4°C/45.9%
Polarity	Horizontal	Site / Test Engineer	AC1 / Jay Chu
Test Mode	Transmit by 802.11a at Channel 5745MHz	Test Voltage	120V/60Hz

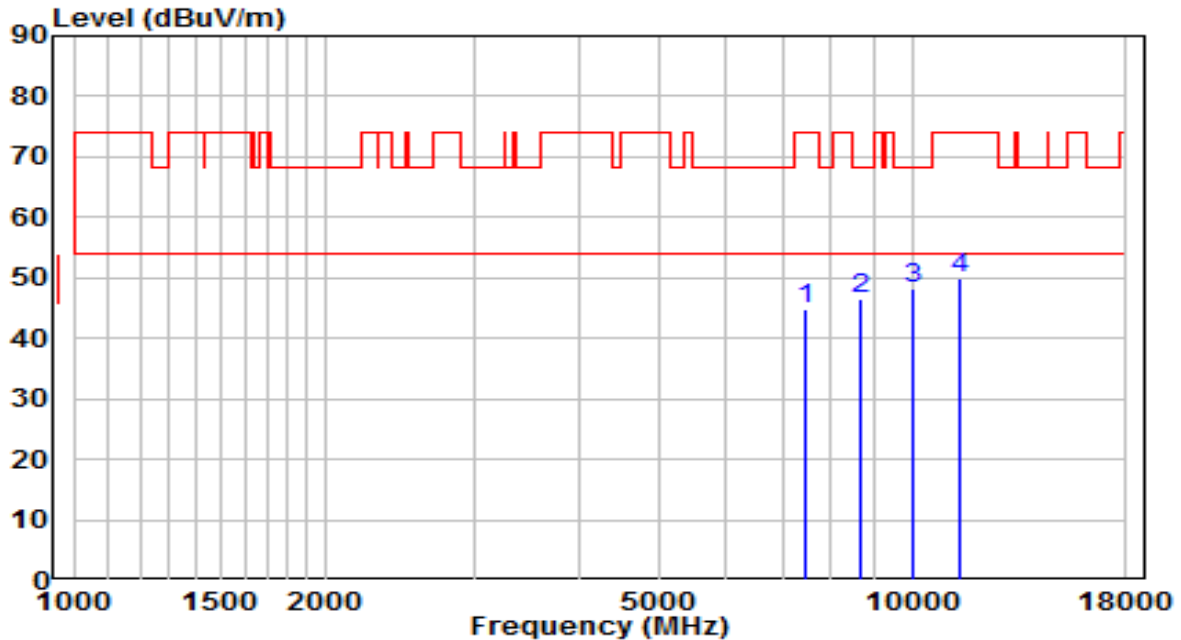

No	Frequency (MHz)	Reading (dBμV)	C.F (dB/m)	Measurement (dBμV/m)	Margin (dB)	Limit (dBμV/m)	Remark (QP/PK/AV)
1	7477.000	31.95	12.91	44.86	-29.14	74.00	Peak
2	8709.500	32.48	14.17	46.65	-21.55	68.20	Peak
3	* 10035.500	31.50	16.70	48.21	-19.99	68.20	Peak
4	11361.500	30.21	19.84	50.04	-23.96	74.00	Peak

Note:

1. " \*", means this data is the worst emission level.
2. C.F (Correction Factor) = Antenna Factor (dB/m) + Cable Loss (dB) – Preamplifier(dB).
3. Measurement(dBμV/m) = Reading(dBμV) + C.F (Correction Factor).

EUT	ACCESS POINT	Date of Test	2022-01-06
Factor	BBHA 9120D (1GHz~18GHz)_2021	Temp. / Humidity	25.4°C/45.9%
Polarity	Vertical	Site / Test Engineer	AC1 / Jay Chu
Test Mode	Transmit by 802.11a at Channel 5745MHz	Test Voltage	120V/60Hz

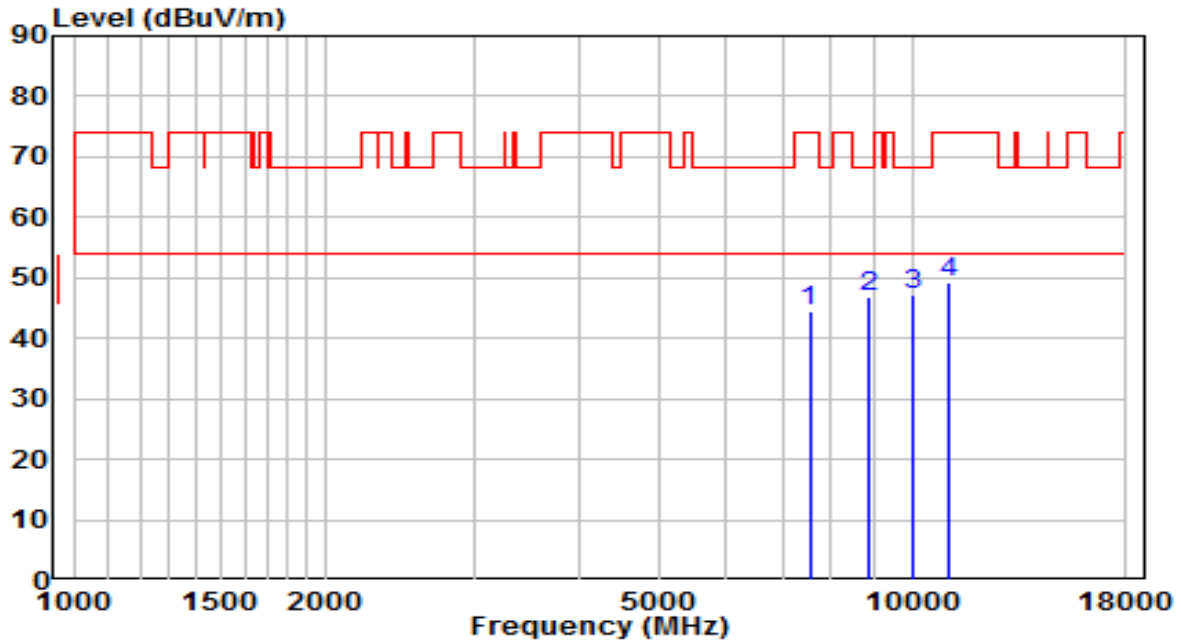

No	Frequency (MHz)	Reading (dB $\mu$ V)	C.F (dB/m)	Measurement (dB $\mu$ V/m)	Margin (dB)	Limit (dB $\mu$ V/m)	Remark (QP/PK/AV)
1	7545.000	31.53	13.05	44.59	-29.41	74.00	Peak
2	8871.000	32.45	14.56	47.01	-21.19	68.20	Peak
3	* 10018.500	30.66	16.63	47.30	-20.90	68.20	Peak
4	11047.000	29.89	19.35	49.24	-24.76	74.00	Peak

Note:

1. " \*", means this data is the worst emission level.
2. C.F (Correction Factor) = Antenna Factor (dB/m) + Cable Loss (dB) – Pre-amplifier(dB).
3. Measurement(dB $\mu$ V/m) = Reading(dB $\mu$ V) + C.F (Correction Factor).

EUT	ACCESS POINT	Date of Test	2022-01-06
Factor	BBHA 9120D (1GHz~18GHz)_2021	Temp. / Humidity	25.4°C/45.9%
Polarity	Horizontal	Site / Test Engineer	AC1 / Jay Chu
Test Mode	Transmit by 802.11a at Channel 5785MHz	Test Voltage	120V/60Hz

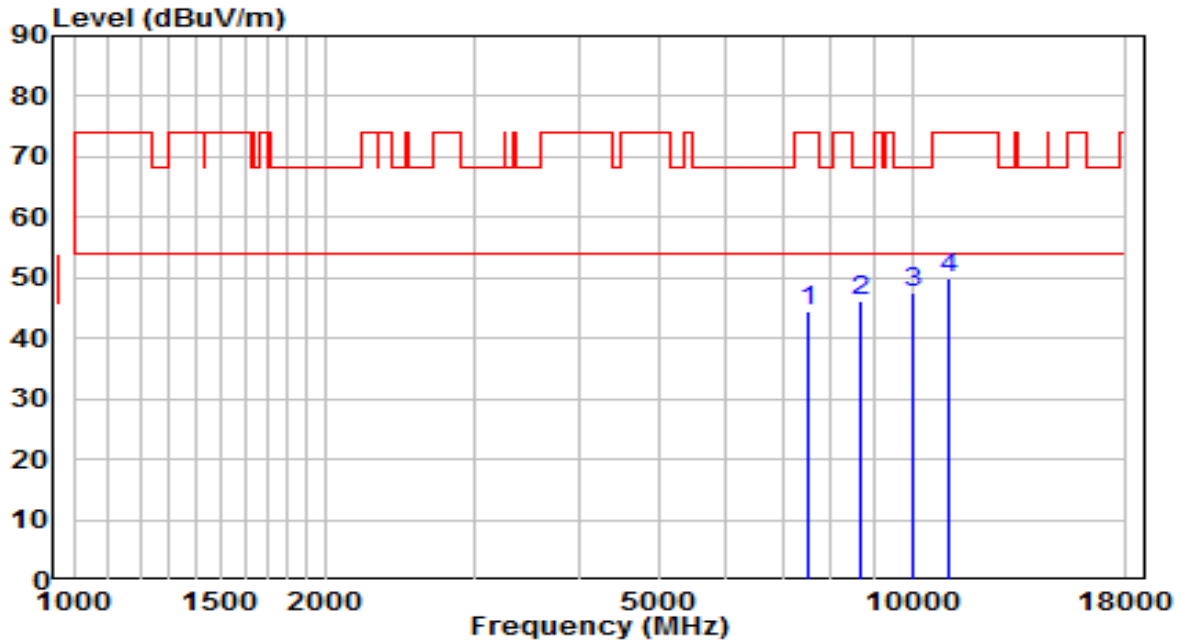

No	Frequency (MHz)	Reading (dB $\mu$ V)	C.F (dB/m)	Measurement (dB $\mu$ V/m)	Margin (dB)	Limit (dB $\mu$ V/m)	Remark (QP/PK/AV)
1	7536.500	31.47	13.05	44.52	-29.48	74.00	Peak
2	8675.500	32.10	14.08	46.19	-22.01	68.20	Peak
3	* 10018.500	31.01	16.63	47.64	-20.56	68.20	Peak
4	11081.000	30.59	19.40	49.99	-24.01	74.00	Peak

Note:

1. " \*", means this data is the worst emission level.
2. C.F (Correction Factor) = Antenna Factor (dB/m) + Cable Loss (dB) – Pre-amplifier(dB).
3. Measurement(dB $\mu$ V/m) = Reading(dB $\mu$ V) + C.F (Correction Factor).

EUT	ACCESS POINT	Date of Test	2022-01-06
Factor	BBHA 9120D (1GHz~18GHz)_2021	Temp. / Humidity	25.4°C/45.9%
Polarity	Vertical	Site / Test Engineer	AC1 / Jay Chu
Test Mode	Transmit by 802.11a at Channel 5785MHz	Test Voltage	120V/60Hz

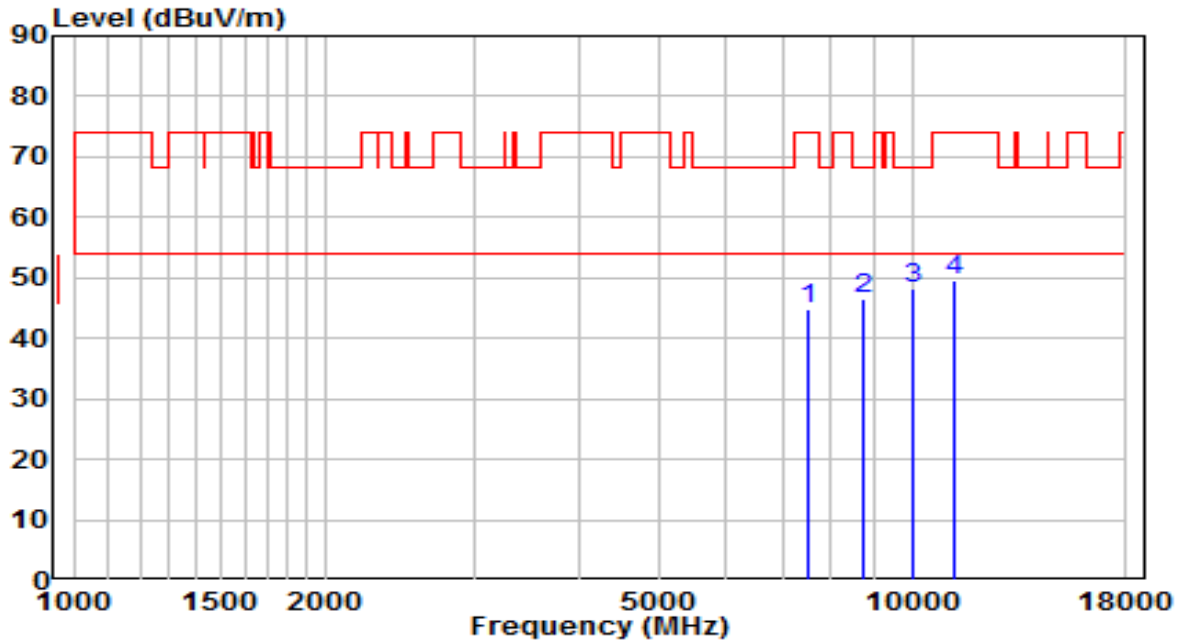

No	Frequency (MHz)	Reading (dB $\mu$ V)	C.F (dB/m)	Measurement (dB $\mu$ V/m)	Margin (dB)	Limit (dB $\mu$ V/m)	Remark (QP/PK/AV)
1	7528.000	31.82	13.04	44.85	-29.15	74.00	Peak
2	8726.500	32.37	14.21	46.58	-21.62	68.20	Peak
3	* 10035.500	31.63	16.70	48.34	-19.86	68.20	Peak
4	11259.500	30.05	19.68	49.73	-24.27	74.00	Peak

Note:

1. " \*", means this data is the worst emission level.
2. C.F (Correction Factor) = Antenna Factor (dB/m) + Cable Loss (dB) – Pre-amplifier(dB).
3. Measurement(dB $\mu$ V/m) = Reading(dB $\mu$ V) + C.F (Correction Factor).