

MEASUREMENT REPORT

FCC PART 15 Subpart C / ZigBee



FCC ID: Q9DAPIN0655

Applicant: Hewlett Packard Enterprise Company

Application Type: Certification

Product: ACCESS POINT

Model No.: APIN0655

Brand Name:  

FCC Classification: Digital Transmission System (DTS)

FCC Rule Part(s): Part15 Subpart C (Section 15.247)

Test Procedure(s): ANSI C63.10-2013

Test Date: September 28, 2021 ~ March 22, 2022

Reviewed By: 
(Paddy Chen)

Approved By: 
(Chenz Ker)



The test results relate only to the samples tested.

This equipment has been shown to be capable of compliance with the applicable technical standards as indicated in the measurement report and was tested in accordance with the measurement procedures specified in ANSI C63.10-2013. Test results reported herein relate only to the item(s) tested.

The test report shall not be reproduced except in full without the written approval of MRT Technology (Taiwan) Co., Ltd.

Revision History

Report No.	Version	Description	Issue Date	Note
2105TW0602-U2	V1.0	Initial Report	03-22-2022	Valid

CONTENTS

Description	Page
General Information	5
1. INTRODUCTION	6
1.1. Scope	6
1.2. MRT Test Location	6
2. PRODUCT INFORMATION	7
2.1. Equipment Description	7
2.2. Product Specification Subjective to this Report.....	7
2.3. Working Frequencies for this report	7
2.4. Description of Available Antennas	8
2.5. Description of EUT Filter	9
2.6. Duty Cycle	10
2.7. Description of Test Configuration and Software.....	11
2.8. EMI Suppression Device(s)/Modifications	11
2.9. Labeling Requirements.....	11
3. DESCRIPTION of TEST	12
3.1. Evaluation Procedure	12
3.2. AC Line Conducted Emissions	12
3.3. Radiated Emissions.....	13
4. ANTENNA REQUIREMENTS	14
5. TEST EQUIPMENT CALIBRATION DATE	15
6. MEASUREMENT UNCERTAINTY.....	17
7. TEST RESULT	18
7.1. Summary	18
7.2. 6dB Bandwidth Measurement	19
7.2.1. Test Limit.....	19
7.2.2. Test Procedure used	19
7.2.3. Test Setting	19
7.2.4. Test Setup	19
7.2.5. Test Result	20
7.3. Output Power Measurement.....	21
7.3.1. Test Limit.....	21
7.3.2. Test Procedure Used.....	21
7.3.3. Test Setting	21
7.3.4. Test Setup	22
7.3.5. Test Result	23
7.4. Power Spectral Density Measurement	25
7.4.1. Test Limit.....	25

7.4.2. Test Procedure Used.....	25
7.4.3. Test Setting	25
7.4.4. Test Setup	25
7.4.5. Test Result	26
7.5. Conducted Band Edge and Out-of-Band Emissions	27
7.5.1. Test Limit.....	27
7.5.2. Test Procedure Used.....	27
7.5.3. Test Setting	27
7.5.4. Test Setup	28
7.5.5. Test Result	29
7.6. Radiated Spurious Emission Measurement	34
7.6.1. Test Limit.....	34
7.6.2. Test Procedure Used.....	34
7.6.3. Test Setting	34
7.6.4. Test Setup	36
7.6.5. Test Result	37
7.7. Radiated Restricted Band Edge Measurement	55
7.7.1. Test Limit.....	55
7.7.2. Test Procedure Used.....	56
7.7.3. Test Setting	56
7.7.4. Test Setup	57
7.7.5. Test Result	58
7.8. AC Conducted Emissions Measurement.....	66
7.8.1. Test Limit.....	66
7.8.2. Test Setup	66
7.8.3. Test Result	67
8. CONCLUSION	69
Appendix A - Test Setup Photograph.....	70
Appendix B - EUT Photograph	71

General Information

Applicant	Hewlett Packard Enterprise Company
Applicant Address	3333 Scott Blvd, Santa Clara, CA 95054, USA
Manufacturer	Hewlett Packard Enterprise Company
Manufacturer Address	3333 Scott Blvd, Santa Clara, CA 95054, USA
Test Site	MRT Technology (Taiwan) Co., Ltd
Test Site Address	No. 38, Fuxing Second Rd., Guishan Dist., Taoyuan City 333, Taiwan (R.O.C)
MRT FCC Registration No.	291082
FCC Rule Part(s)	Part 15.247
Test Device Serial No.	CNMJKZ201P <input type="checkbox"/> Production <input checked="" type="checkbox"/> Pre-Production <input type="checkbox"/> Engineering

Test Facility / Accreditations

1. MRT facility is a FCC registered (Reg. No. 291082) test facility with the site description report on file and is designated by the FCC as an Accredited Test Firm.
2. MRT facility is an IC registered (MRT Reg. No. 21723) test laboratory with the site description on file at Industry Canada.
3. MRT Lab is accredited to ISO 17025 by the Taiwan Accreditation Foundation (TAF Cert. No. 3261) in EMC, Telecommunications and Radio testing for FCC (Designation Number: TW3261), Industry Taiwan, EU and TELEC Rules.

1. INTRODUCTION

1.1. Scope

Measurement and determination of electromagnetic emissions (EMC) of radio frequency devices including intentional and/or unintentional radiators for compliance with the technical rules and regulations of the Federal Communications Commission and the Innovation, Science and Economic Development Canada and Certification and Engineering Bureau.

1.2. MRT Test Location

The map below shows the location of the MRT LABORATORY, its proximity to the Taoyuan City. These measurement tests were conducted at the MRT Technology (Taiwan) Co., Ltd. Facility located at No.38, Fuxing 2nd Rd., Guishan Dist., Taoyuan City 33377, Taiwan (R.O.C).

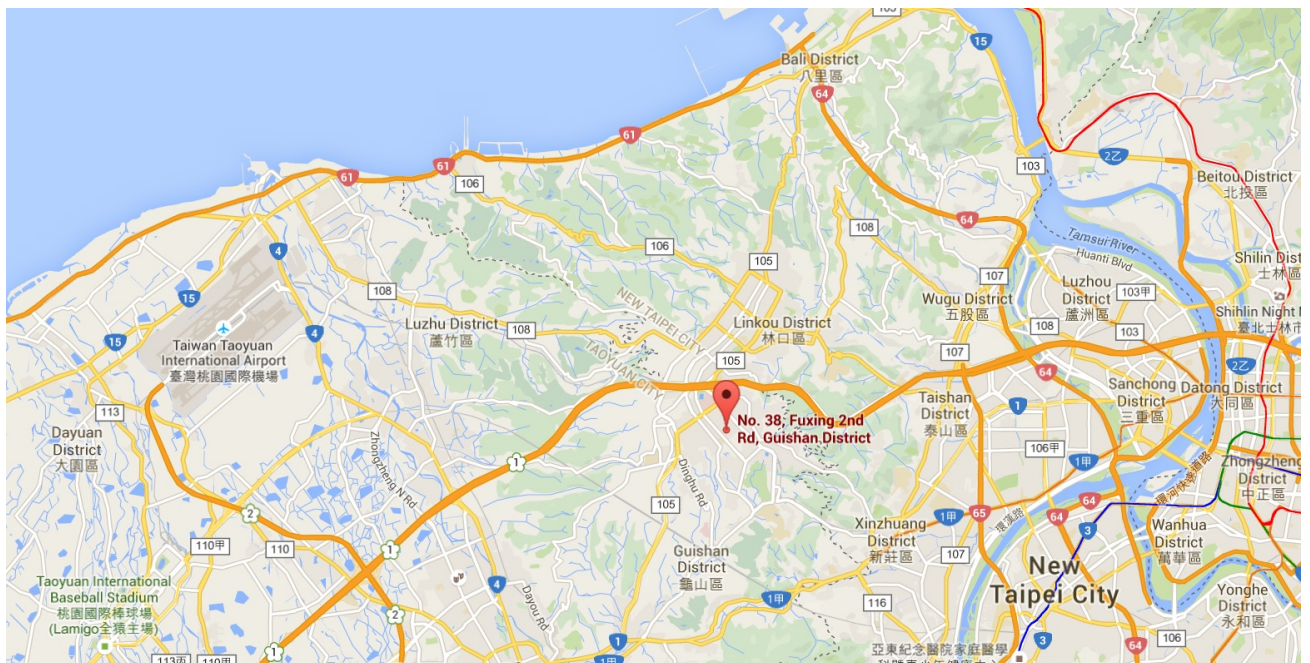

2. PRODUCT INFORMATION

2.1. Equipment Description

Product Name	ACCESS POINT
Model No.	APIN0655
Software Version	nrf52840_modulate.hex
Wi-Fi Specification	802.11a/b/g/n/ac/ax
Bluetooth Specification	v5.0 single mode, BLE only
Zigbee Specification	802.15.4
GNSS Specification	GPS, GLONASS, Galileo
Operating Temperature	0 ~ 50 °C
Antenna Information	Refer to Section 2.4
Filter Information	Refer to Section 2.5
Power Type	AC Adapter or PoE input
Operating Environment	Indoor Use
Remark: The information of EUT was provided by the manufacturer, and the accuracy of the information shall be the responsibility of the manufacturer.	

2.2. Product Specification Subjective to this Report

Zigbee Specification	802.15.4
Frequency Range	2405 ~ 2480 MHz
Channel Number	16
Type of Modulation	O-QPSK

Note: For other features of this EUT, test report will be issued separately.

2.3. Working Frequencies for this report

Channel	Frequency	Channel	Frequency	Channel	Frequency
11	2405 MHz	12	2410 MHz	13	2415 MHz
14	2420 MHz	15	2425 MHz	16	2430 MHz
17	2435 MHz	18	2440 MHz	19	2445 MHz
20	2450 MHz	21	2455 MHz	22	2460 MHz
23	2465 MHz	24	2470 MHz	25	2475 MHz
26	2480 MHz	--	--	--	--

2.4. Description of Available Antennas

Antenna Type	Frequency Band (GHz)	Max Peak Gain (dBi)	CDD Directional Gain (dBi)		BF Directional Gain (dBi)
			For Power	For PSD	
Wi-Fi Internal Antenna (4*4 MIMO)					
PIFA	2.4 ~ 2.5	3.26	3.26	6.23	6.23
	5.15 ~ 5.9	2.88	2.88	5.60	5.60
	5.9 ~ 7.2	3.97	3.97	6.97	6.97
Bluetooth / ZigBee Internal Antenna					
PIFA	2.4 ~ 2.5		3.60		

Note:

1. The EUT supports Cyclic Delay Diversity (CDD) mode, and CDD signals are correlated.
2. The EUT also supports Beam Forming mode, and the Beam Forming support 802.11n/ac/ax, not include 802.11a/b/g.
3. For beamforming operation, Aruba OS automatically backs power down based on a $10\log(N)$ factor based on CDD power.
4. All Wi-Fi antennas have cross polarized design, the detail information and calculation method refer to antenna specification.

2.5. Description of EUT Filter

Filter	Specification	Remark
Wi-Fi		
Filter 1#	Band Pass Filter (2412-2472)	Allowing any transmission on all channels
Filter 2#	Band Pass Filter (2402-2447)	Allowing any transmission on 20MHz channels 1 thru 6
Filter 3#	Band Pass Filter (2452-2472)	Allowing any transmission on 20MHz channel 11
Bluetooth & ZigBee		
Filter 4#	Band Pass Filter (2402-2480)	Allowing any transmission on all channels
Filter 5#	Band Pass Filter (2402-2426)	Allowing any transmission on channel 2402 ~ 2426 MHz (BLE) and channel 2405 ~ 2425 MHz (ZigBee)
Filter 6#	Band Pass Filter (2478-2482)	Allowing transmission on channel 2480 MHz (BLE) and 2480 MHz (ZigBee)

Working Group

Groups	Remark
Filter 1# or Filter 4#	Filter 1# or Filter 4# can work alone
Filter 2# and Filter 6#	Transmission simultaneously
Filter 3# and Filter 5#	Transmission simultaneously
Note: Filter groups on the 2.4GHz Wi-Fi and BLE/ZigBee outputs to prevent reverse IMD when both 2.4GHz Wi-Fi and BLE/ZigBee are transmitting simultaneously	

2.6. Duty Cycle

The maximum achievable duty cycles for all modes were determined based on measurements performed on a spectrum analyzer in zero-span mode with RBW = 8MHz, VBW = 50MHz. The RBW and VBW were both greater than 50/T, where T is the minimum transmission duration, and the number of sweep points across T was greater than 100. The duty cycles are as follows:

Test Mode	T (Transmission Duration)	Duty Cycle
802.15.4	3.405ms	96.57%

The screenshot shows a Keysight Spectrum Analyzer in zero-span mode. The center frequency is 2.405000000 GHz, Res BW is 8 MHz, and VBW is 50 MHz. A marker is placed on a pulse with a duration of 3.40507 ms. The marker table below the plot shows the following data:

MKR	MODE	TRC	SECL	X	Y	FUNCTION	FUNCTION WIDTH	FUNCTION VALUE
1	A2	1	t	(Δ)	3.526 ms	(Δ)		-0.02 dB
2	F	1	t	(Δ)	5.831 ms			7.08 dBm
3	Δ4	1	t	(Δ)	3.405 ms	(Δ)		0.01 dB
4	F	1	t	(Δ)	5.831 ms			7.08 dBm

Note 1: This duty cycle was only suitable for continuous transmission of signals via commands.

Note 2: The manufacturer, declared that the ZigBee operation, when implemented, will be limited to a max duty cycle of 10% or less in any 100ms period. So -20dB correction factor was used during peak and average band edge testing.

2.7. Description of Test Configuration and Software

The device was tested per the guidance ANSI C63.10: 2013 was used to reference the appropriate EUT setup for radiated emissions testing and AC line conducted testing.

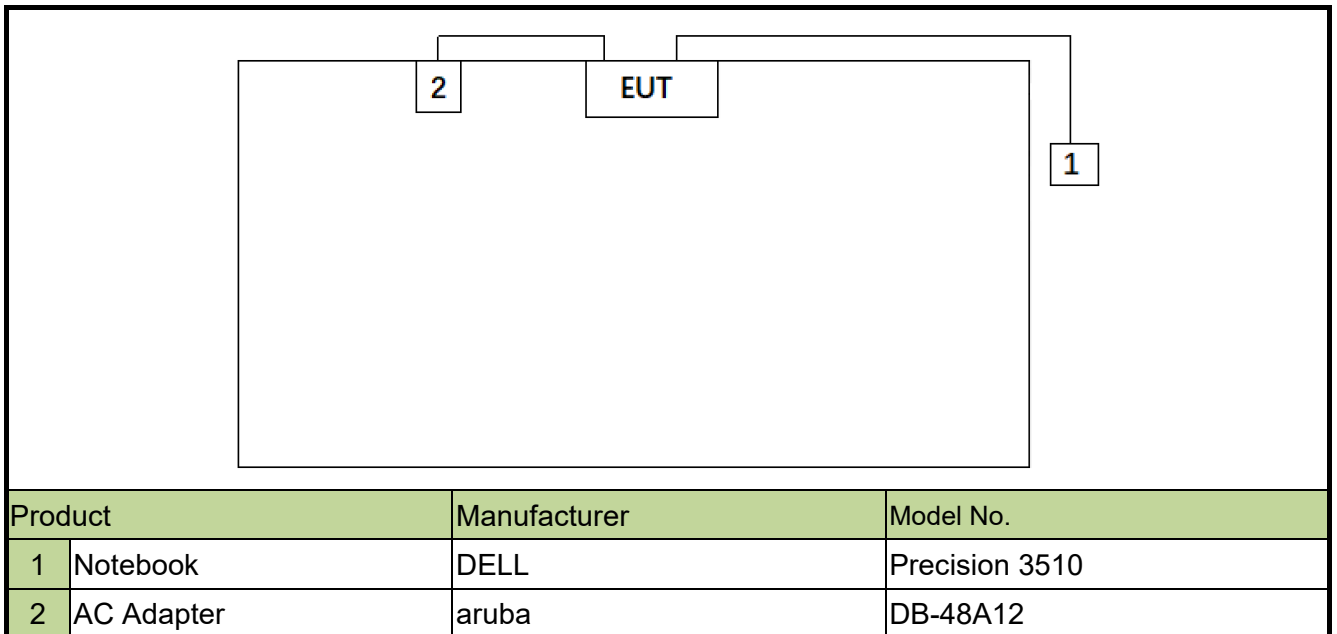

Note 1: The test utility software used during testing was “telnet.exe” and command was provided by the manufacturer.

Note 2: Detail power setting refer to operation description.

2.8. EMI Suppression Device(s)/Modifications

No EMI suppression device(s) were added and/or no modifications were made during testing.

2.9. Labeling Requirements

Per 2.1074 & 15.19; Docket 95-19

The label shall be permanently affixed at a conspicuous location on the device; instruction manual or pamphlet supplied to the user and be readily visible to the purchaser at the time of purchase.

However, when the device is so small wherein placement of the label with specified statement is not practical, only the FCC ID must be displayed on the device per Section 15.19(a)(5). Please see attachment for FCC ID label and label location.

3. DESCRIPTION of TEST

3.1. Evaluation Procedure

The measurement procedure described in the document titled “American National Standard of Procedures for Compliance Testing of Unlicensed Wireless Devices” (ANSI C63.10-2013) was used in the measurement.

3.2. AC Line Conducted Emissions

The line-conducted facility is located inside an 8'x4'x4' shielded enclosure. A 1m x 2m wooden table 80cm high is placed 40cm away from the vertical wall and 80cm away from the sidewall of the shielded room. Two 10kHz-30MHz, 50Ω/50uH Line-Impedance Stabilization Networks (LISNs) are bonded to the shielded room floor. Power to the LISNs is filtered by external high-current high-insertion loss power line filters. These filters attenuate ambient signal noise from entering the measurement lines. These filters are also bonded to the shielded enclosure.

The EUT is powered from one LISN and the support equipment is powered from the second LISN. All interconnecting cables more than 1 meter were shortened to a 1 meter length by non-inductive bundling (serpentine fashion) and draped over the back edge of the test table. All cables were at least 40cm above the horizontal reference ground-plane. Power cables for support equipment were routed down to the second LISN while ensuring that that cables were not draped over the second LISN.

Sufficient time for the EUT, support equipment, and test equipment was allowed in order for them to warm up to their normal operating condition. The RF output of the LISN was connected to the receiver and exploratory measurements were made to determine the frequencies producing the maximum emission from the EUT. The receiver was scanned from 150kHz to 30MHz. The detector function was set to peak mode for exploratory measurements while the bandwidth of the analyzer was set to 9kHz. The EUT, support equipment, and interconnecting cables were arranged and manipulated to maximize each emission. Each emission was also maximized by varying: power lines, the mode of operation or data exchange speed, or support equipment whichever determined the worst-case emission. Once the worst case emissions have been identified, the one EUT cable configuration/arrangement and mode of operation that produced these emissions are used for final measurements on the same test site. The analyzer is set to CISPR quasi-peak and average detectors with a 9kHz resolution bandwidth for final measurements.

An extension cord was used to connect to a single LISN which powered by EUT. The extension cord was calibrated with LISN, the impedance and insertion loss are compliance with the requirements as stated in ANSI C63.10-2013.

3.3. Radiated Emissions

The radiated test facilities consisted of an indoor 3 meter semi-anechoic chamber used for final measurements and exploratory measurements, when necessary. The measurement area is contained within the semi-anechoic chamber which is shielded from any ambient interference. For measurements above 1GHz absorbers are arranged on the floor between the turn table and the antenna mast in such a way so as to maximize the reduction of reflections. For measurements below 1GHz, the absorbers are removed. A MF Model 210SS turntable is used for radiated measurement. It is a continuously rotatable, remote controlled, metallic turntable and 2 meters (6.56 ft.) in diameter. The turn table is flush with the raised floor of the chamber in order to maintain its function as a ground plane. An 80cm high PVC support structure is placed on top of the turntable.

For all measurements, the spectrum was scanned through all EUT azimuths and from 1 to 4 meter receive antenna height using a broadband antenna from 30MHz up to the upper frequency shown in 15.33(b)(1) depending on the highest frequency generated or used in the device or on which the device operates or tunes. For frequencies above 1GHz, linearly polarized double ridge horn antennas were used. For frequencies below 30MHz, a calibrated loop antenna was used. When exploratory measurements were necessary, they were performed at 1 meter test distance inside the semi-anechoic chamber using broadband antennas, broadband amplifiers, and spectrum analyzers to determine the frequencies and modes producing the maximum emissions. Sufficient time for the EUT, support equipment, and test equipment was allowed in order for them to warm up to their normal operating condition. The test set-up for frequencies below 1GHz was placed on top of the 0.8 meter high, 1 x 1.5 meter table; and test set-up for frequencies 1-40GHz was placed on top of the 1.5 meter high, 1 x 1.5 meter table. The EUT, support equipment, and interconnecting cables were arranged and manipulated to maximize each emission. Appropriate precaution was taken to ensure that all emissions from the EUT were maximized and investigated. The system configuration, clock speed, mode of operation or video resolution, if applicable, turntable azimuth, and receive antenna height was noted for each frequency found.

Final measurements were made in the semi-anechoic chamber using calibrated, linearly polarized broadband and horn antennas. The test setup was configured to the setup that produced the worst case emissions. The spectrum analyzer was set to investigate all frequencies required for testing to compare the highest radiated disturbances with respect to the specified limits. The turntable containing the EUT was rotated through 360 degrees and the height of the receive antenna was varied 1 to 4 meters and stopped at the azimuth and height producing the maximum emission. Each emission was maximized by changing the orientation of the EUT through three orthogonal planes and changing the polarity of the receive antenna, whichever produced the worst-case emissions. According to 3dB Beam-Width of horn antenna, the horn antenna should be always directed to the EUT when rising height.

4. ANTENNA REQUIREMENTS

Excerpt from §15.203 of the FCC Rules/Regulations:

“An intentional radiator antenna shall be designed to ensure that no antenna other than that furnished by the responsible party can be used with the device. The use of a permanently attached antenna or of an antenna that uses a unique coupling to the intentional radiator shall be considered sufficient to comply with the provisions of this section.”

- The antenna of the device is **permanently attached**.
- There are no provisions for connection to an external antenna.

Conclusion:

The unit complies with the requirement of §15.203.

5. TEST EQUIPMENT CALIBRATION DATE

Conducted Emissions -SR2

Instrument	Manufacturer	Type No.	Asset No.	Cali. Interval	Cali. Due Date
Two-Line V-Network	R&S	ENV 216	MRTTWA00019	1 year	2022/3/23
Two-Line V-Network	R&S	ENV 216	MRTTWA00020	1 year	2022/4/24
8-Wire ISN (T8)	R&S	ENY81	MRTTWA00018	1 year	2022/5/30
EMI Test Receiver	R&S	ESR3	MRTTWA00045	1 year	2022/5/25
Temperature/Humidity Meter	TFA	35.1083	MRTTWA00050	1 year	2022/6/3

Radiated Emissions – AC1/AC2

Instrument	Manufacturer	Type No.	Asset No.	Cali. Interval	Cali. Due Date
Active Loop Antenna	SCHWARZBECK	FMZB 1519B	MRTTWA00002	1 year	2022/4/27
Broadband TRILOG Antenna	SCHWARZBECK	VULB 9162	MRTTWA00001	1 year	2022/10/4
Broadband Horn Antenna	SCHWARZBECK	BBHA 9120D	MRTTWA00003	1 year	2022/4/24
Broadband Horn Antenna	RFSPIN	DRH18-E	MRTTWA00087	1 year	2022/6/28
Broadband Horn Antenna	SCHWARZBECK	BBHA 9170	MRTTWA00004	1 year	2022/4/24
Broadband Preamplifier	SCHWARZBECK	BBV 9718	MRTTWA00005	1 year	2022/4/24
Broadband Preamplifier	EMC Instruments corporation	EMC118A45S E	MRTTWA00088	1 year	2022/6/28
Broadband Amplifier	SCHWARZBECK	BBV 9721	MRTTWA00006	1 year	2022/4/24
Signal Analyzer	R&S	FSV40	MRTTWA00007	1 year	2022/3/23
EMI Test Receiver	R&S	ESR3	MRTTWA00009	1 year	2022/3/24
EXA Signal Analyzer	KEYSIGHT	N9010A	MRTTWA00012	1 year	2022/10/18
Antenna Cable	HUBERSUHNER	SF106	MRTTWE00010	1 year	2022/6/28
Cable	Rosnol	K1K50-UP026 4-K1K50-4M	MRTTWE00012	1 year	2022/6/20
Antenna Cable	HUBERSUHNER	SF106	MRTTWE00034	1 year	2022/6/28
Cable	HUBERSUHNER	EMC105-NM- NM-3000	MRTTWE00035	1 year	2022/6/28
Temperature/Humidity Meter	TFA	35.1078.10.IT	MRTTWA00032	1 year	2022/6/6

Conducted Test Equipment – SR2

Instrument	Manufacturer	Type No.	Asset No.	Cali. Interval	Cali. Due Date
X-Series USB Peak and Average Power Sensor	KEYSIGHT	U2021XA	MRTTWA00014	1 year	2022/4/21
EXA Signal Analyzer	KEYSIGHT	N9010A	MRTTWA00012	1 year	2022/10/18
EXA Signal Analyzer	KEYSIGHT	N9010B	MRTTWA00074	1 year	2022/7/19
Attenuator	WTI	218FS-20	MRTTWE00027	1 year	2022/6/16
Attenuator	WTI	218FS-10	MRTTWE00028	1 year	2022/6/16
Attenuator	WTI	218FS-06	MRTTWE00029	1 year	2022/6/16
Temperature/Humidity Meter	TFA	35.1083	MRTTWA00050	1 year	2022/6/3

Test Software

Software	Version	Function
e3	9.160520a	EMI Test Software

6. MEASUREMENT UNCERTAINTY

Where relevant, the following test uncertainty levels have been estimated for tests performed on the EUT as specified in CISPR 16-4-2. This uncertainty represents an expanded uncertainty expressed at approximately the 95% confidence level using a coverage factor of $k = 2$.

AC Conducted Emission Measurement
Measuring Uncertainty for a Level of Confidence of 95% ($U=2Uc(y)$): 150kHz~30MHz: 2.53dB
Radiated Emission Measurement
Measuring Uncertainty for a Level of Confidence of 95% ($U=2Uc(y)$): 9kHz ~ 1GHz: 4.25dB 1GHz ~ 40GHz: 4.45dB
Conducted Power
Measuring Uncertainty for a Level of Confidence of 95% ($U=2Uc(y)$): ± 0.84 dB
Conducted Spurious Emission
Measuring Uncertainty for a Level of Confidence of 95% ($U=2Uc(y)$): ± 2.65 dB
Occupied Bandwidth
Measuring Uncertainty for a Level of Confidence of 95% ($U=2Uc(y)$): 3.3%
Temp. / Humidity
Measuring Uncertainty for a Level of Confidence of 95% ($U=2Uc(y)$): $\pm 0.82^{\circ}\text{C} / \pm 3\%$

7. TEST RESULT

7.1. Summary

FCC Section(s)	Test Description	Test Limit	Test Condition	Test Result	Reference
15.247(a)(2)	6dB Bandwidth	$\geq 500\text{kHz}$	Conducted	Pass	Section 7.2
15.247(b)(3)	Output Power	$\leq 30\text{dBm}$		Pass	Section 7.3
15.247(e)	Power Spectral Density	$\leq 8\text{dBm}/3\text{kHz}$		Pass	Section 7.4
15.247(d)	Band Edge / Out-of-Band Emissions	$\geq 20\text{dBc (Peak)}$		Pass	Section 7.5
15.205 15.209	General Field Strength (Restricted Bands and Radiated Emission)	Emissions in restricted bands must meet the radiated limits detailed in 15.209	Radiated	Pass	Section 7.6 & 7.7
15.207	AC Conducted Emissions 150kHz - 30MHz	< FCC 15.207 limits	Line Conducted	Pass	Section 7.8

Notes:

- 1) The analyzer plots shown in this section were all taken with a correction table loaded into the analyzer. The correction table was used to account for the losses of the cables and attenuators used as part of the system to connect the EUT to the analyzer at all frequencies of interest.
- 2) All modes of operation and data rates were investigated. For radiated emission test, every axis (X, Y, Z) was also verified. The test results shown in the following sections represent the worst case emissions.
- 3) Determining compliance is based on the test results met the regulation limits or requirements declared by clients, and the test results don't take into account the value of measurement uncertainty.

Test Items	Filter 4#	Filter 5#	Filter 6#
6dB Bandwidth	•		
Output Power	•	•	•
Power Spectral Density	•		
Band Edge / Out-of-Band Emissions	•	•	•
Radiated Spurious Emission	•	•	•
Radiated Band Edge	•	•	•
AC Conducted Emissions 150kHz - 30MHz	•		

7.2. 6dB Bandwidth Measurement

7.2.1. Test Limit

The minimum 6dB bandwidth shall be at least 500 kHz.

7.2.2. Test Procedure used

ANSI C63.10-2013 Section 11.8

7.2.3. Test Setting

1. The Spectrum's automatic bandwidth measurement capability was used to perform the 6dB bandwidth measurement. The "X" dB bandwidth parameter was set to $X = 6$. The bandwidth measurement was not influenced by any intermediate power nulls in the fundamental emission.
2. Set RBW = 100 kHz
3. $VBW \geq 3 \times RBW$
4. Detector = Peak
5. Trace mode = max hold
6. Sweep = auto couple
7. Allow the trace was allowed to stabilize

7.2.4. Test Setup

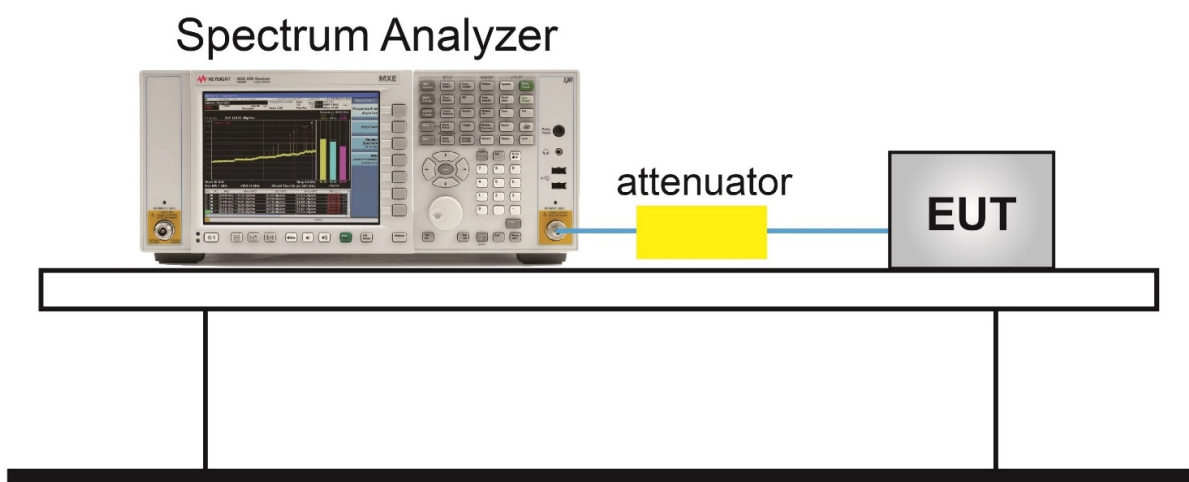

7.2.5. Test Result

Product	ACCESS POINT	Test Engineer	Eric Lin
Test Site	SR2	Test Date	2021/10/12

Test Mode	Modulation Mode	Channel No.	Frequency (MHz)	6dB Bandwidth (MHz)	Limit (MHz)	Result
802.15.4	O-QPSK	11	2405	1.136	≥ 0.5	Pass
802.15.4	O-QPSK	18	2440	1.128	≥ 0.5	Pass
802.15.4	O-QPSK	26	2480	1.124	≥ 0.5	Pass

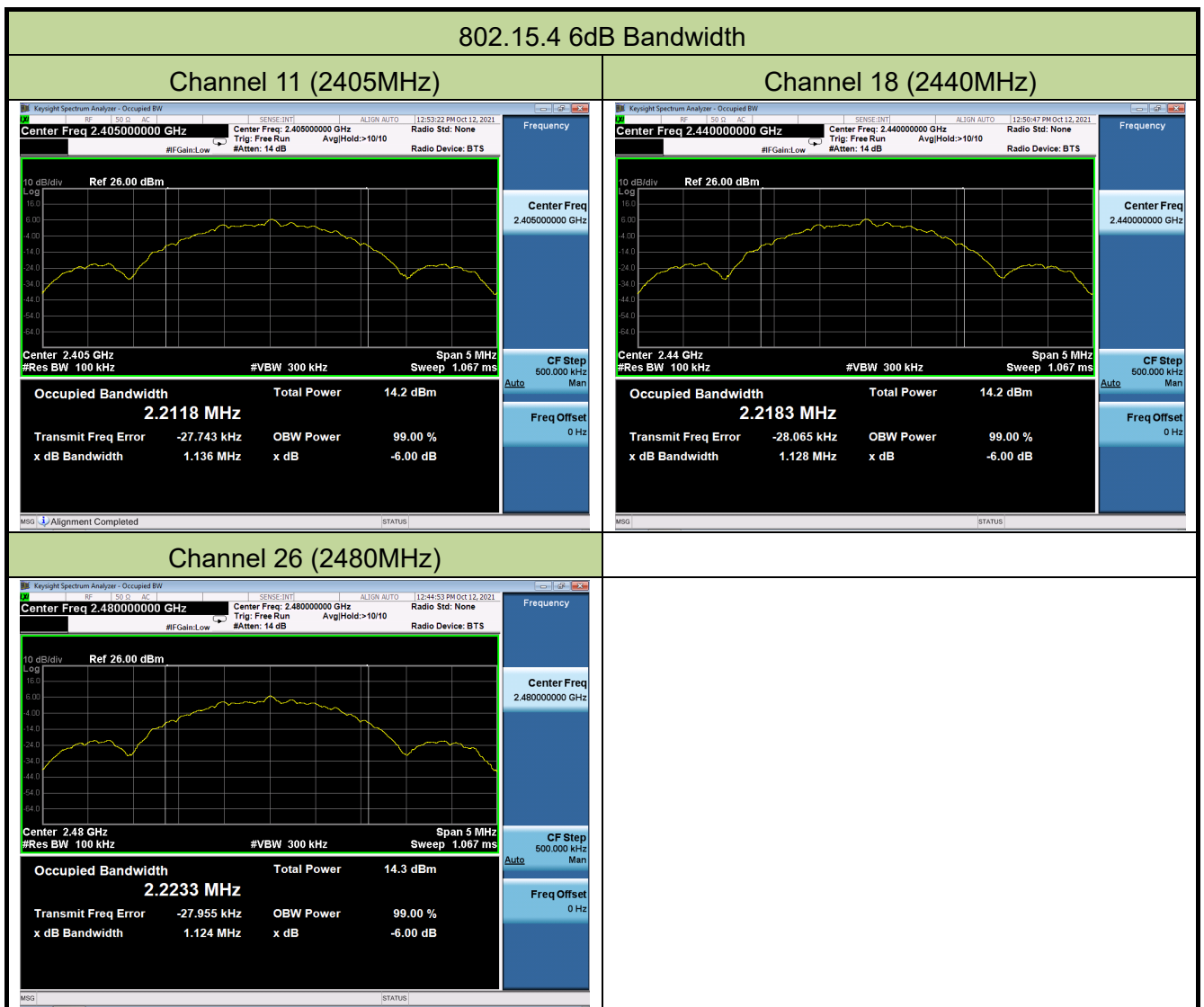

7.3. Output Power Measurement

7.3.1. Test Limit

The maximum output power shall be less 1 Watt (30dBm).

The conducted output power limit specified in paragraph FCC Part 15.247(b) of this section is based on the use of antennas with directional gains that do not exceed 6 dBi. If transmitting antennas of directional gain greater than 6 dBi are used, the conducted output power from the intentional radiator shall be reduced below the stated values in paragraphs FCC Part 15.247(b)(3) of this section, as appropriate, by the amount in dB that the directional gain of the antenna exceeds 6 dBi.

7.3.2. Test Procedure Used

ANSI C63.10-2013 Section 11.9.1.3

ANSI C63.10-2013 Section 11.9.2.3

7.3.3. Test Setting

Method PKPM1 (Peak Power Measurement)

Peak power measurements were performed only when the EUT was transmitting at its maximum power control level using a broadband power meter with a pulse sensor. The pulse sensor employs a VBW = 50MHz so this method was only used for signals whose DTS bandwidth was less than or equal to 50MHz.

Average Power Measurement

Average power measurements were performed only when the EUT was transmitting at its maximum power control level using a broadband power meter with a pulse sensor. The power meter implemented triggering and gating capabilities which were set up such that power measurements were recorded only during the ON time of the transmitter.

7.3.4. Test Setup

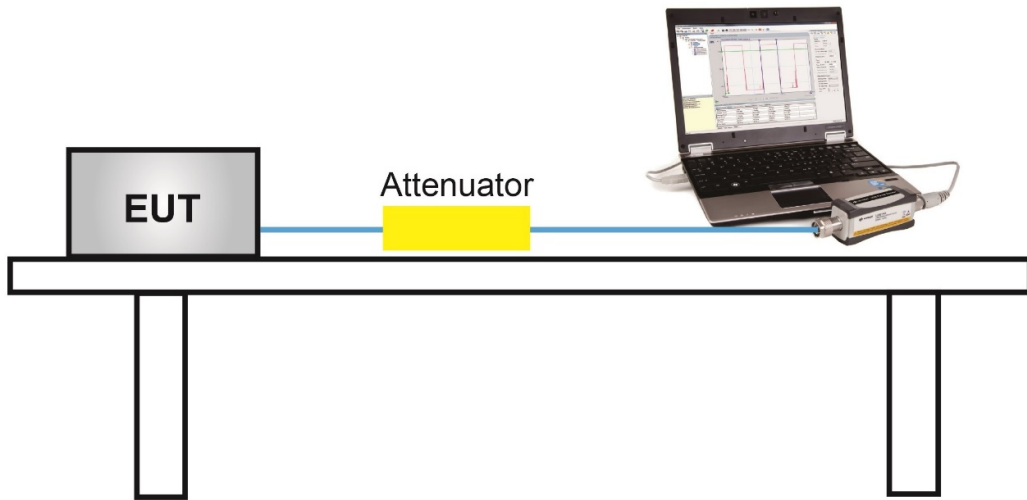

7.3.5. Test Result

Product	ACCESS POINT	Test Engineer	Eric Lin
Test Site	SR2	Test Date	2021/09/28
Filter Configuration	Filter 4#		

Test Result of Peak Output Power

Test Mode	Modulation Mode	Channel No.	Freq. (MHz)	Peak Power (dBm)	Limit (dBm)	Result
802.15.4	O-QPSK	11	2405	7.12	≤ 30.00	Pass
802.15.4	O-QPSK	18	2440	7.21	≤ 30.00	Pass
802.15.4	O-QPSK	26	2480	7.24	≤ 30.00	Pass

Test Result of Average Output Power (Reporting Only)

Test Mode	Modulation Mode	Channel No.	Freq. (MHz)	Average Power (dBm)	Limit (dBm)	Result
802.15.4	O-QPSK	11	2405	6.76	≤ 30.00	Pass
802.15.4	O-QPSK	18	2440	6.93	≤ 30.00	Pass
802.15.4	O-QPSK	26	2480	6.95	≤ 30.00	Pass

Product	ACCESS POINT	Test Engineer	Eric Lin
Test Site	SR2	Test Date	2021/09/28
Filter Configuration	Filter 5#		

Test Result of Peak Output Power

Test Mode	Data Rate (Mbps)	Channel No.	Frequency (MHz)	Peak Power (dBm)	Limit (dBm)	Result
802.15.4	O-QPSK	11	2405	6.27	≤ 30.00	Pass

Test Result of Average Output Power (Reporting Only)

Test Mode	Data Rate (Mbps)	Channel No.	Frequency (MHz)	Average Power (dBm)	Limit (dBm)	Result
802.15.4	O-QPSK	11	2405	6.03	≤ 30.00	Pass

Product	ACCESS POINT	Test Engineer	Eric Lin
Test Site	SR2	Test Date	2021/09/28
Filter Configuration	Filter 6#		

Test Result of Peak Output Power

Test Mode	Data Rate (Mbps)	Channel No.	Frequency (MHz)	Peak Power (dBm)	Limit (dBm)	Result
802.15.4	O-QPSK	26	2480	4.78	≤ 30.00	Pass

Test Result of Average Output Power (Reporting Only)

Test Mode	Data Rate (Mbps)	Channel No.	Frequency (MHz)	Average Power (dBm)	Limit (dBm)	Result
802.15.4	O-QPSK	26	2480	4.45	≤ 30.00	Pass

7.4. Power Spectral Density Measurement

7.4.1. Test Limit

The maximum permissible power spectral density is 8dBm in any 3 kHz band.

The same method of determining the conducted output power shall be used to determine the power spectral density.

7.4.2. Test Procedure Used

ANSI C63.10-2013 Section 11.10.2

7.4.3. Test Setting

1. Analyzer was set to the center frequency of the DTS channel under investigation
2. Span = 1.5 times the DTS channel bandwidth
3. RBW = 3kHz
4. VBW = 10kHz
5. Detector = peak
6. Sweep time = auto couple
7. Trace mode = max hold
8. Trace was allowed to stabilize

7.4.4. Test Setup

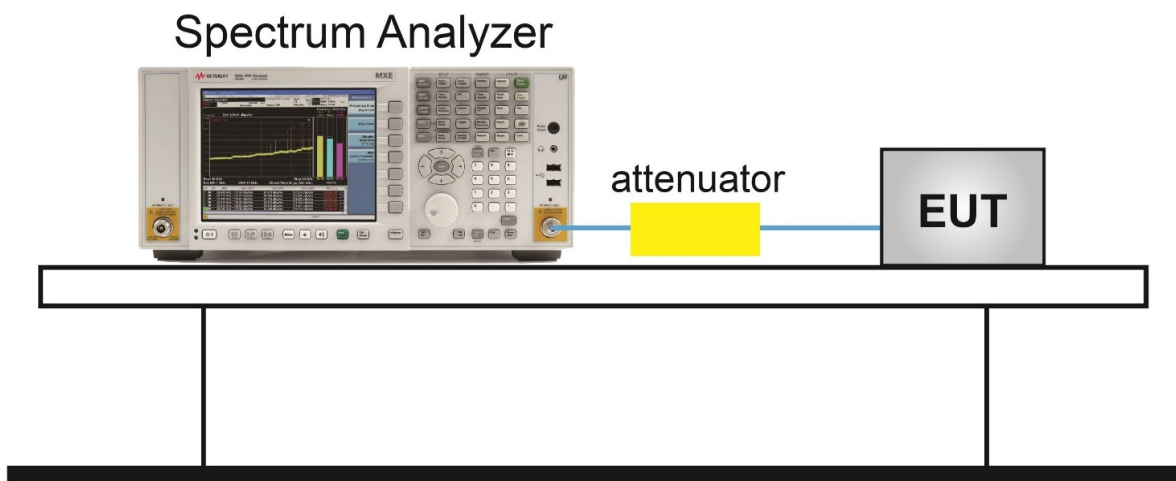

7.4.5. Test Result

Product	ACCESS POINT	Test Engineer	Eric Lin
Test Site	SR2	Test Date	2021/09/28

Test Mode	Modulation Mode	Channel No.	Frequency (MHz)	PK PSD (dBm / 3kHz)	Limit (dBm / 3kHz)	Result
802.15.4	O-QPSK	11	2405	-4.41	≤ 8.00	Pass
802.15.4	O-QPSK	18	2440	-4.36	≤ 8.00	Pass
802.15.4	O-QPSK	26	2480	-4.71	≤ 8.00	Pass

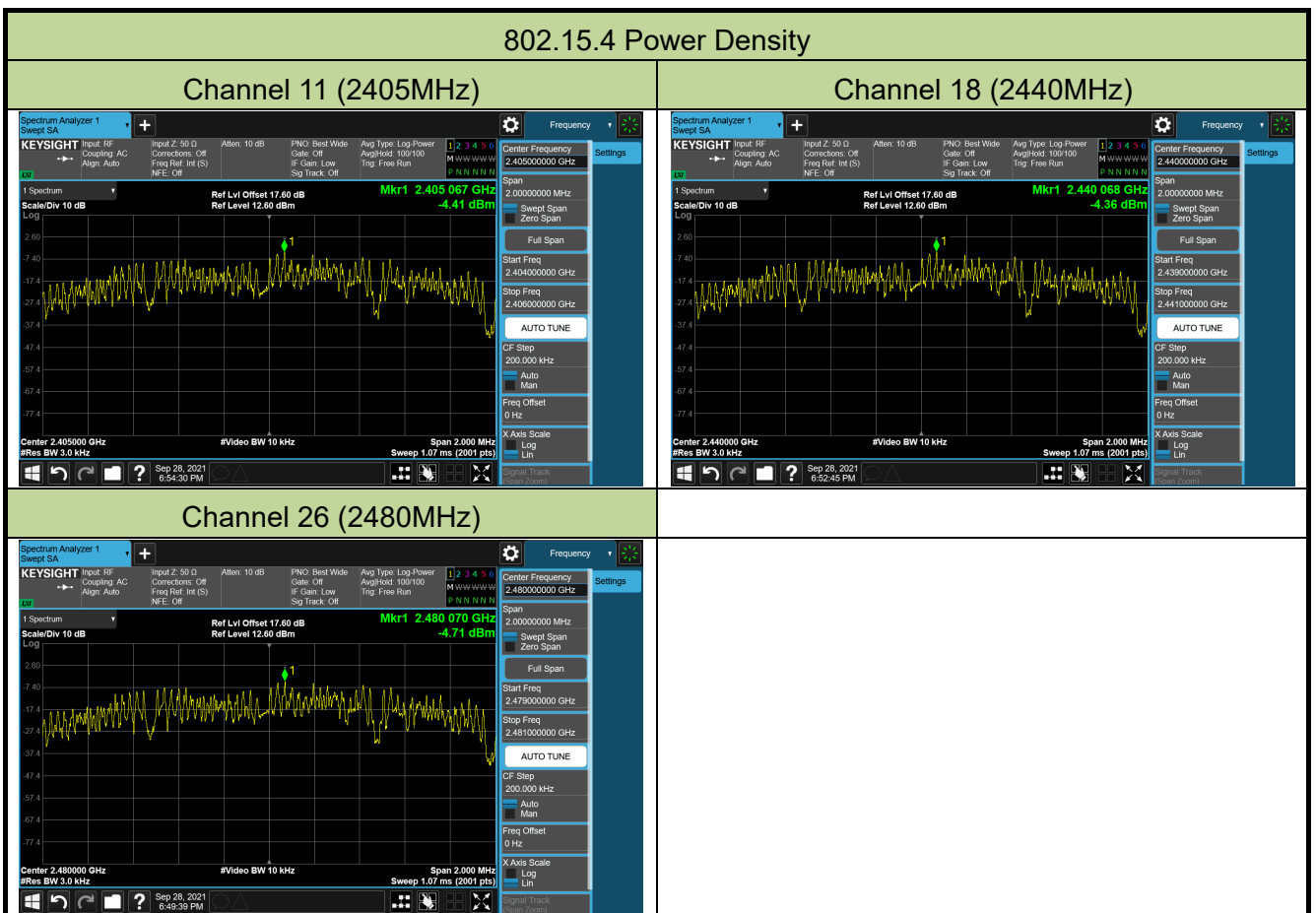

7.5. Conducted Band Edge and Out-of-Band Emissions

7.5.1. Test Limit

The limit for out-of-band spurious emissions at the band edge is 20dB below the fundamental emission level, as determined from the in-band power measurement of the DTS channel performed in a 100 kHz bandwidth per the PSD procedure.

7.5.2. Test Procedure Used

ANSI C63.10-2013 Section 11.11

7.5.3. Test Setting

Reference level measurement

1. Set instrument center frequency to DTS channel center frequency
2. Set the span to ≥ 1.5 times the DTS bandwidth
3. Set the RBW = 100 kHz
4. Set the VBW $\geq 3 \times$ RBW
5. Detector = peak
6. Sweep time = auto couple
7. Trace mode = max hold
8. Allow trace to fully stabilize

Emission level measurement

1. Start frequency was set to 30MHz and stop frequency was set to 25GHz (separated into two plots per channel)
2. RBW = 100kHz
3. VBW = 300kHz
4. Detector = Peak
5. Trace mode = max hold
6. Sweep time = auto couple
7. The trace was allowed to stabilize

7.5.4. Test Setup

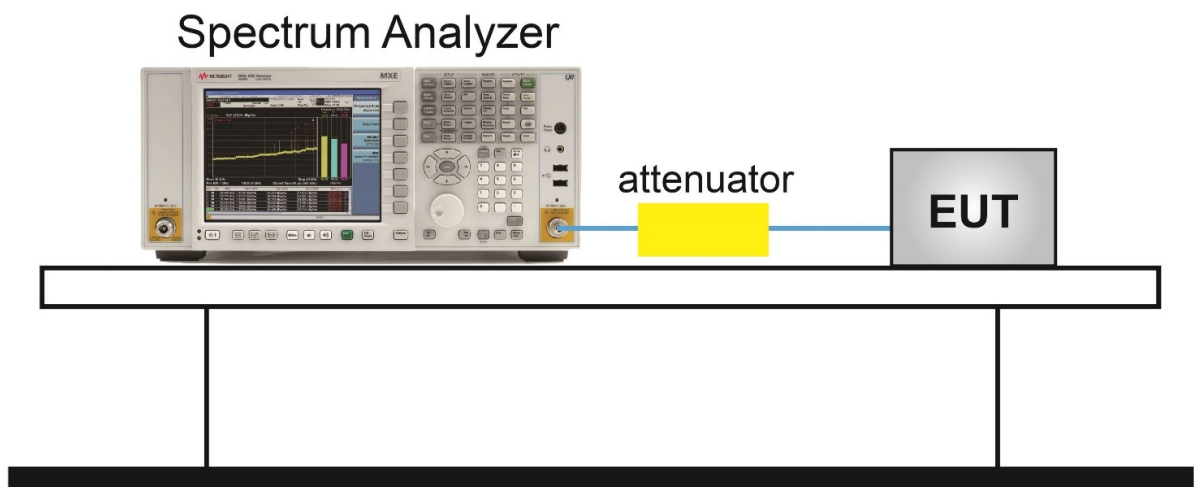

7.5.5. Test Result

Product	ACCESS POINT	Test Engineer	Eric Lin
Test Site	SR2	Test Date	2022/01/24
Filter Configuration	Filter 4#		

Test Mode	Data Rate / MCS	Channel No.	Frequency (MHz)	Limit (dBc)	Result
802.15.4	O-QPSK	11	2405	> 20	Pass
802.15.4	O-QPSK	18	2440	> 20	Pass
802.15.4	O-QPSK	26	2480	> 20	Pass

802.15.4 Out-of-Band Emissions

Channel 11 (2405MHz)

100kHz PSD Reference Level

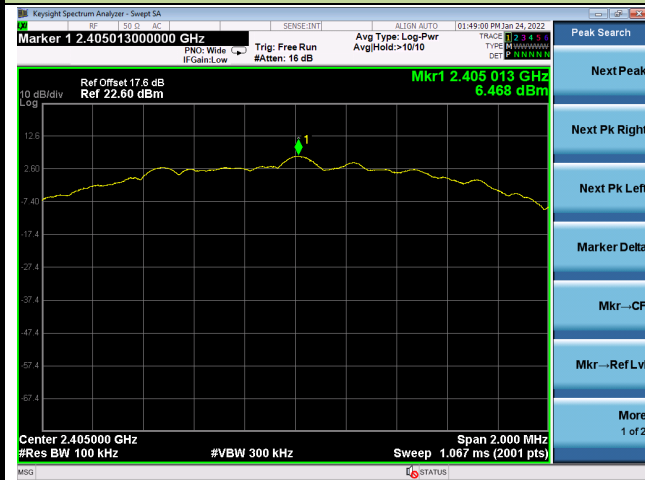

Low Band Edge

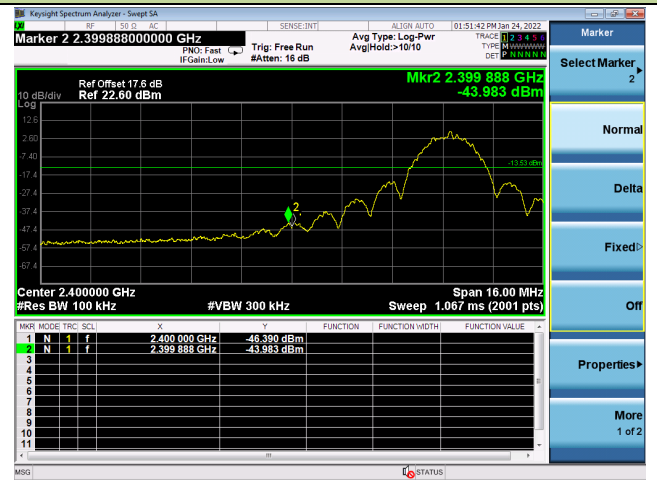

Spurious Emission

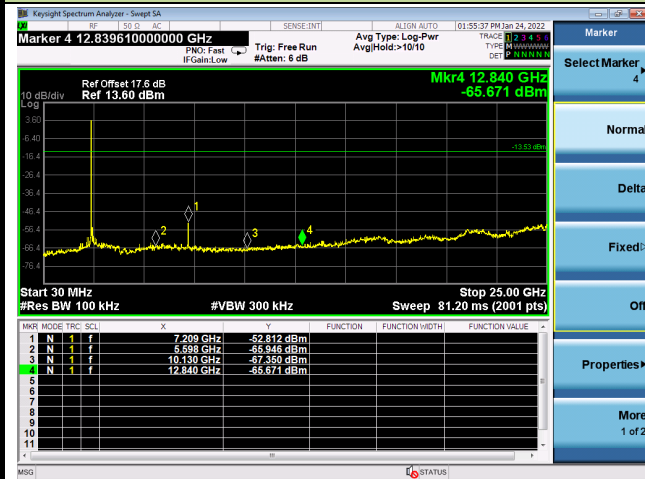

Channel 18 (2440MHz)

100kHz PSD Reference Level

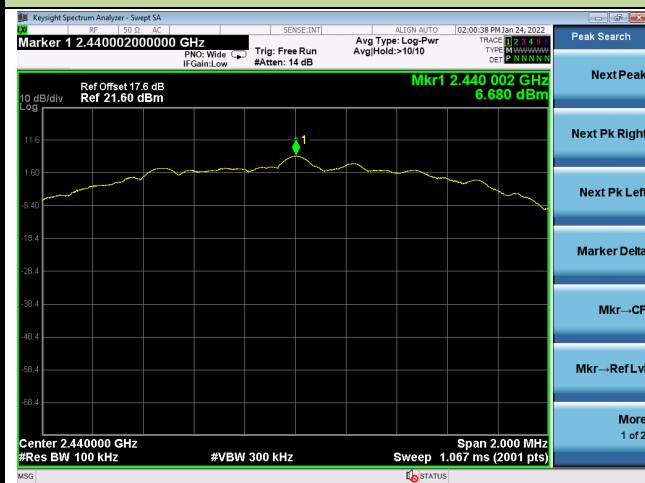

Spurious Emission

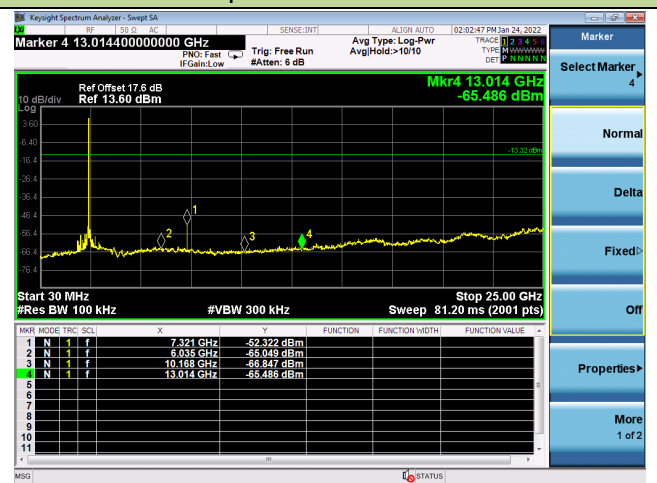



Product	ACCESS POINT	Test Engineer	Eric Lin
Test Site	SR2	Test Date	2022/01/24
Filter Configuration	Filter 5#		

Test Mode	Data Rate / MCS	Channel No.	Frequency (MHz)	Limit (dBc)	Result
802.15.4	O-QPSK	11	2405	> 20	Pass

802.15.4 Out-of-Band Emissions
Channel 11 (2405MHz)

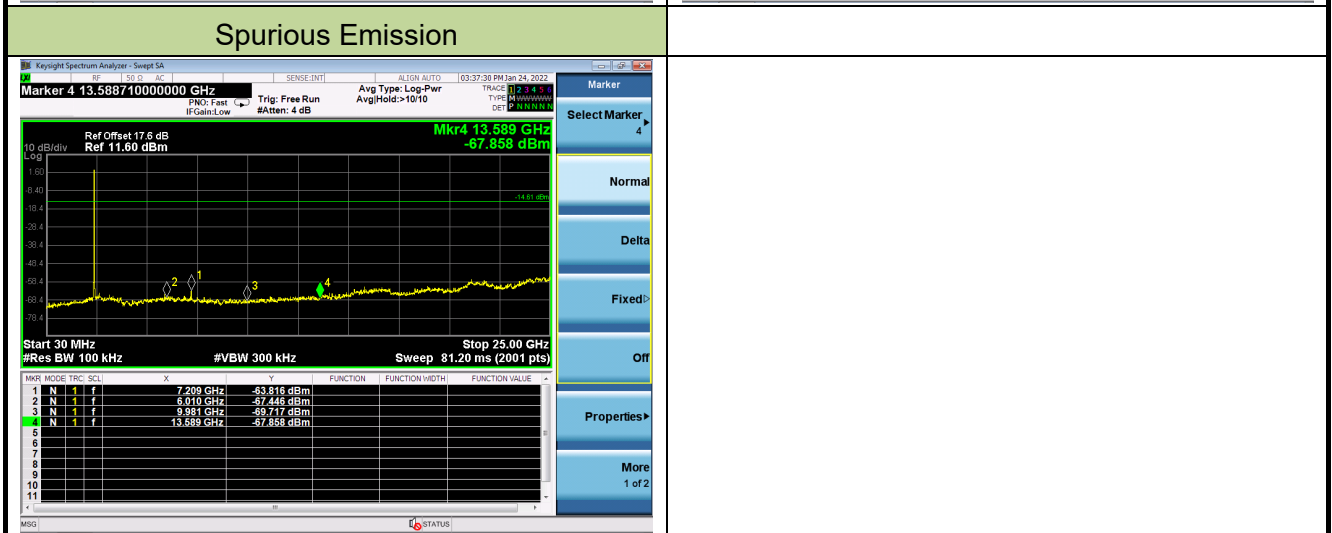
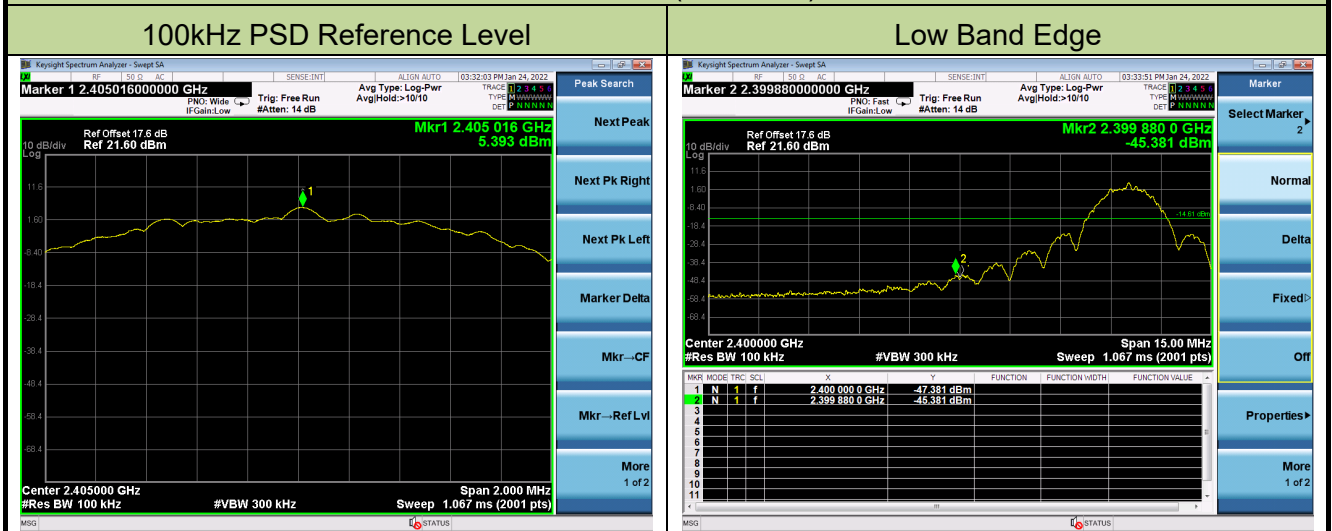

Product	ACCESS POINT	Test Engineer	Eric Lin
Test Site	SR2	Test Date	2022/01/24
Filter Configuration	Filter 6#		

Test Mode	Data Rate / MCS	Channel No.	Frequency (MHz)	Limit (dBc)	Result
802.15.4	O-QPSK	26	2480	> 20	Pass

802.15.4 Out-of-Band Emissions
Channel 11 (2480MHz)

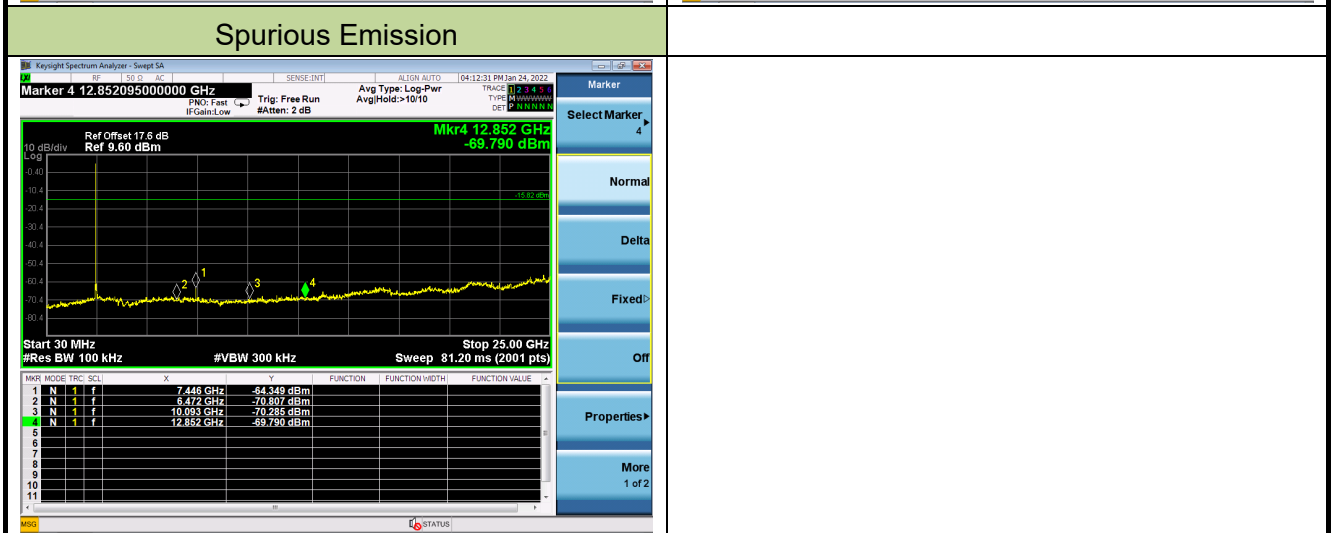
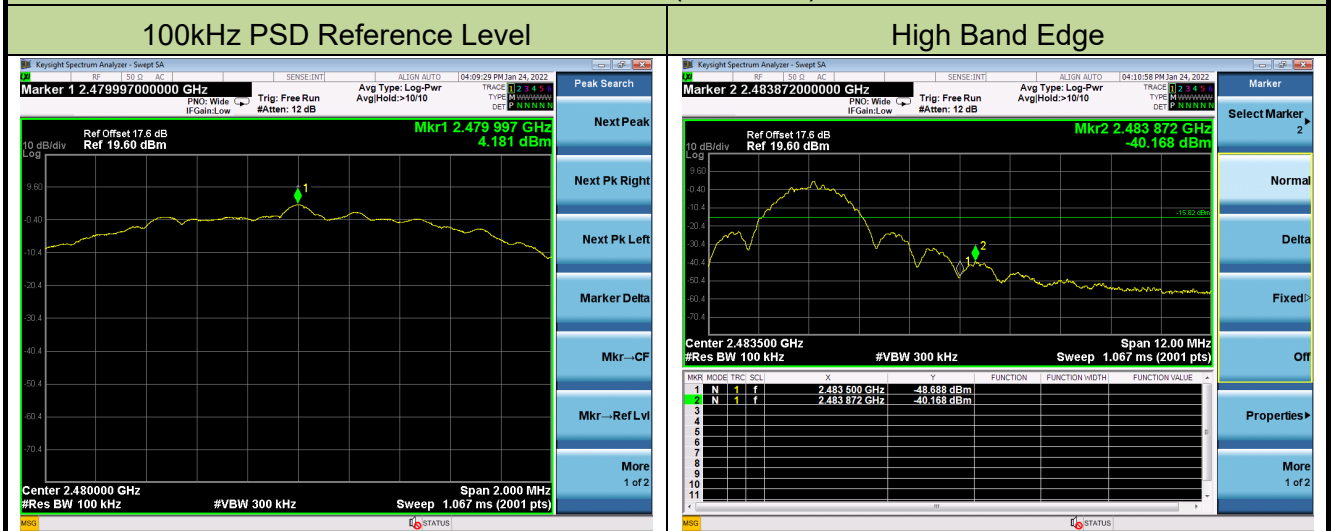

7.6. Radiated Spurious Emission Measurement

7.6.1. Test Limit

All out of band emissions appearing in a restricted band as specified in Section 15.205 of the Title 47 CFR must not exceed the limits shown in Table per Section 15.209.

FCC Part 15 Subpart C Paragraph 15.209		
Frequency [MHz]	Field Strength [$\mu\text{V}/\text{m}$]	Measured Distance [Meters]
0.009 - 0.490	2400/F (kHz)	300
0.490 - 1.705	24000/F (kHz)	30
1.705 - 30	30	30
30 - 88	100	3
88 - 216	150	3
216 - 960	200	3
Above 960	500	3

7.6.2. Test Procedure Used

ANSI C63.10-2013 Section 6.3 (General Requirements)

ANSI C63.10-2013 Section 6.4 (Standard test method below 30MHz)

ANSI C63.10-2013 Section 6.5 (Standard test method above 30MHz to 1GHz)

ANSI C63.10-2013 Section 6.6 (Standard test method above 1GHz)

ANSI C63.10-2013 Section 11.11 & 11.12

7.6.3. Test Setting

Table 1 - RBW as a function of frequency

Frequency	RBW
9 ~ 150 kHz	200 ~ 300 Hz
0.15 ~ 30 MHz	9 ~ 10 kHz
30 ~ 1000 MHz	100 ~ 120 kHz

Quasi-Peak Measurements below 1GHz

1. Analyzer center frequency was set to the frequency of the radiated spurious emission of interest
2. Span was set greater than 1MHz
3. RBW = as specified in Table 1
4. Detector = CISPR quasi-peak
5. Sweep time = auto couple
6. Trace was allowed to stabilize

Peak Measurements above 1GHz

1. Analyzer center frequency was set to the frequency of the radiated spurious emission of interest
2. RBW = 1MHz
3. VBW = 3MHz
4. Detector = peak
5. Sweep time = auto couple
6. Trace mode = max hold
7. Trace was allowed to stabilize

Average Measurements above 1GHz

1. Analyzer center frequency was set to the frequency of the radiated spurious emission of interest
2. RBW = 1MHz
3. VBW = $1 / T$, (VBW = 300Hz)
4. Average Type = Voltage
5. Detector = Peak
6. Sweep time = auto
7. Trace mode = max hold
8. Trace was allowed to stabilize

7.6.4. Test Setup

Below 1GHz Test Setup:

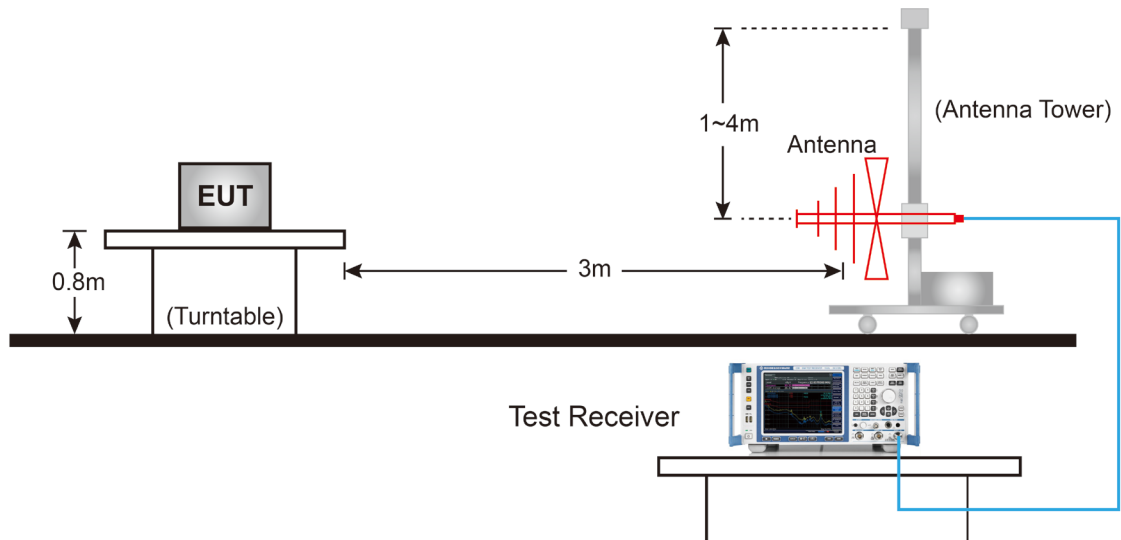

Above 1GHz Test Setup:

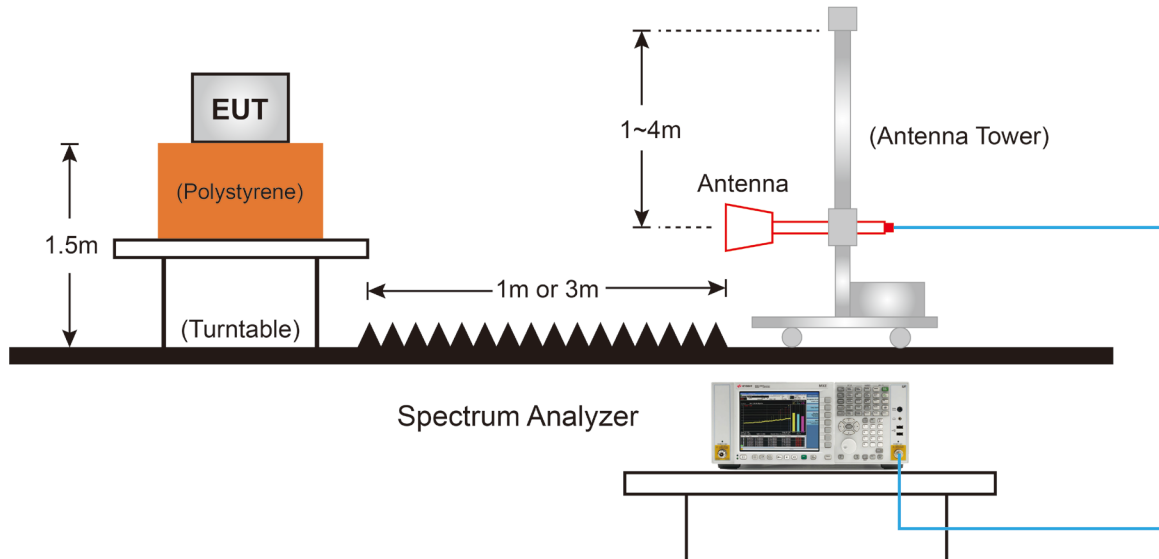

7.6.5. Test Result

Filter Configuration 4#

EUT	ACCESS POINT	Date of Test	2022-01-06
Factor	BBHA 9120D (1GHz~18GHz)_2021	Temp. / Humidity	26.6°C/50.8%
Polarity	Horizontal	Site / Test Engineer	AC1 / Jay Chu
Test Mode	Transmit by Zigbee at Channel 2405MHz	Test Voltage	120V/60Hz

(This area is reserved for test results, plots, or additional data.)			
--	--	--	--

No	Frequency (MHz)	Reading (dBμV)	C.F (dB/m)	Measurement (dBμV/m)	Margin (dB)	Limit (dBμV/m)	Remark (QP/PK/AV)
1	3856.000	37.54	0.74	38.28	-35.72	74.00	Peak
2	4706.000	36.07	3.42	39.49	-34.51	74.00	Peak
3	* 7341.000	31.88	12.31	44.19	-29.81	74.00	Peak

Note:

1. " *", means this data is the worst emission level.
2. C.F (Correction Factor) = Antenna Factor (dB/m) + Cable Loss (dB) – Pre-amplifier(dB).
3. Measurement(dBμV/m) = Reading(dBμV) + C.F (Correction Factor).

EUT	ACCESS POINT	Date of Test	2022-01-06
Factor	BBHA 9120D (1GHz~18GHz)_2021	Temp. / Humidity	26.6°C/50.8%
Polarity	Vertical	Site / Test Engineer	AC1 / Jay Chu
Test Mode	Transmit by Zigbee at Channel 2405MHz	Test Voltage	120V/60Hz

--	--	--	--	--	--	--	--

No	Frequency (MHz)	Reading (dBμV)	C.F (dB/m)	Measurement (dBμV/m)	Margin (dB)	Limit (dBμV/m)	Remark (QP/PK/AV)
1	4051.500	37.61	1.37	38.99	-35.01	74.00	Peak
2	4918.500	36.01	3.80	39.81	-34.19	74.00	Peak
3	* 7358.000	32.71	12.39	45.09	-28.91	74.00	Peak

Note:

1. " *", means this data is the worst emission level.
2. C.F (Correction Factor) = Antenna Factor (dB/m) + Cable Loss (dB) – Preamplifier(dB).
3. Measurement(dBμV/m) = Reading(dBμV) + C.F (Correction Factor).

EUT	ACCESS POINT	Date of Test	2022-01-06
Factor	BBHA 9120D (1GHz~18GHz)_2021	Temp. / Humidity	26.6°C/50.8%
Polarity	Horizontal	Site / Test Engineer	AC1 / Jay Chu
Test Mode	Transmit by Zigbee at Channel 2440MHz	Test Voltage	120V/60Hz

--	--	--	--	--	--	--	--

No	Frequency (MHz)	Reading (dBμV)	C.F (dB/m)	Measurement (dBμV/m)	Margin (dB)	Limit (dBμV/m)	Remark (QP/PK/AV)
1	4187.500	36.99	1.88	38.88	-35.12	74.00	Peak
2	5037.500	35.90	4.01	39.91	-34.09	74.00	Peak
3	* 7324.000	35.54	12.24	47.78	-26.22	74.00	Peak

Note:

1. " *", means this data is the worst emission level.
2. C.F (Correction Factor) = Antenna Factor (dB/m) + Cable Loss (dB) – Preamplifier(dB).
3. Measurement(dBμV/m) = Reading(dBμV) + C.F (Correction Factor).

EUT	ACCESS POINT	Date of Test	2022-01-06
Factor	BBHA 9120D (1GHz~18GHz)_2021	Temp. / Humidity	26.6°C/50.8%
Polarity	Vertical	Site / Test Engineer	AC1 / Jay Chu
Test Mode	Transmit by Zigbee at Channel 2440MHz	Test Voltage	120V/60Hz

--	--	--	--	--	--	--	--

No	Frequency (MHz)	Reading (dBμV)	C.F (dB/m)	Measurement (dBμV/m)	Margin (dB)	Limit (dBμV/m)	Remark (QP/PK/AV)
1	3898.500	37.81	0.87	38.68	-35.32	74.00	Peak
2	4808.000	36.32	3.60	39.92	-34.08	74.00	Peak
3	* 7324.000	37.80	12.24	50.03	-23.97	74.00	Peak

Note:

1. " *", means this data is the worst emission level.
2. C.F (Correction Factor) = Antenna Factor (dB/m) + Cable Loss (dB) – Preamplifier(dB).
3. Measurement(dBμV/m) = Reading(dBμV) + C.F (Correction Factor).

EUT	ACCESS POINT	Date of Test	2022-01-06
Factor	BBHA 9120D (1GHz~18GHz)_2021	Temp. / Humidity	26.6°C/50.8%
Polarity	Horizontal	Site / Test Engineer	AC1 / Jay Chu
Test Mode	Transmit by Zigbee at Channel 2480MHz	Test Voltage	120V/60Hz

--	--	--	--	--	--	--	--

No	Frequency (MHz)	Reading (dBμV)	C.F (dB/m)	Measurement (dBμV/m)	Margin (dB)	Limit (dBμV/m)	Remark (QP/PK/AV)
1	3966.500	37.72	1.08	38.80	-35.20	74.00	Peak
2	4748.500	35.96	3.50	39.46	-34.54	74.00	Peak
3	* 7434.500	32.09	12.72	44.81	-29.19	74.00	Peak

Note:

1. " *", means this data is the worst emission level.
2. C.F (Correction Factor) = Antenna Factor (dB/m) + Cable Loss (dB) – Preamplifier(dB).
3. Measurement(dBμV/m) = Reading(dBμV) + C.F (Correction Factor).

EUT	ACCESS POINT	Date of Test	2022-01-06
Factor	BBHA 9120D (1GHz~18GHz)_2021	Temp. / Humidity	26.6°C/50.8%
Polarity	Vertical	Site / Test Engineer	AC1 / Jay Chu
Test Mode	Transmit by Zigbee at Channel 2480MHz	Test Voltage	120V/60Hz

--	--	--	--	--	--	--	--

No	Frequency (MHz)	Reading (dBμV)	C.F (dB/m)	Measurement (dBμV/m)	Margin (dB)	Limit (dBμV/m)	Remark (QP/PK/AV)
1	3949.500	37.66	1.03	38.68	-35.32	74.00	Peak
2	5012.000	36.49	3.97	40.46	-33.54	74.00	Peak
3	* 7434.500	33.66	12.72	46.38	-27.62	74.00	Peak

Note:

1. " *", means this data is the worst emission level.
2. C.F (Correction Factor) = Antenna Factor (dB/m) + Cable Loss (dB) – Preamplifier(dB).
3. Measurement(dBμV/m) = Reading(dBμV) + C.F (Correction Factor).

Filter Configuration 5#

EUT	ACCESS POINT	Date of Test	2022-01-06
Factor	BBHA 9120D (1GHz~18GHz)_2021	Temp. / Humidity	26.6°C/50.8%
Polarity	Horizontal	Site / Test Engineer	AC1 / Jay Chu
Test Mode	Transmit by Zigbee at Channel 2405MHz	Test Voltage	120V/60Hz

--	--	--	--	--	--	--	--	--	--

No	Frequency (MHz)	Reading (dBμV)	C.F (dB/m)	Measurement (dBμV/m)	Margin (dB)	Limit (dBμV/m)	Remark (QP/PK/AV)
1	3949.500	37.97	1.03	38.99	-35.01	74.00	Peak
2	4833.500	37.57	3.65	41.22	-32.78	74.00	Peak
3	* 7451.500	33.70	12.80	46.50	-27.50	74.00	Peak

Note:

1. " *", means this data is the worst emission level.
2. C.F (Correction Factor) = Antenna Factor (dB/m) + Cable Loss (dB) – Preamplifier(dB).
3. Measurement(dBμV/m) = Reading(dBμV) + C.F (Correction Factor).

EUT	ACCESS POINT	Date of Test	2022-01-06
Factor	BBHA 9120D (1GHz~18GHz)_2021	Temp. / Humidity	26.6°C/50.8%
Polarity	Vertical	Site / Test Engineer	AC1 / Jay Chu
Test Mode	Transmit by Zigbee at Channel 2405MHz	Test Voltage	120V/60Hz

--	--	--	--	--	--	--	--

No	Frequency (MHz)	Reading (dBμV)	C.F (dB/m)	Measurement (dBμV/m)	Margin (dB)	Limit (dBμV/m)	Remark (QP/PK/AV)
1	3941.000	38.83	1.00	39.83	-34.17	74.00	Peak
2	5088.500	37.05	4.10	41.15	-32.85	74.00	Peak
3	* 7553.500	33.05	13.06	46.11	-27.89	74.00	Peak

Note:

1. " *", means this data is the worst emission level.
2. C.F (Correction Factor) = Antenna Factor (dB/m) + Cable Loss (dB) – Preamplifier(dB).
3. Measurement(dBμV/m) = Reading(dBμV) + C.F (Correction Factor).

Filter Configuration 6#

EUT	ACCESS POINT	Date of Test	2022-01-06
Factor	BBHA 9120D (1GHz~18GHz)_2021	Temp. / Humidity	26.6°C/50.8%
Polarity	Horizontal	Site / Test Engineer	AC1 / Jay Chu
Test Mode	Transmit by Zigbee at Channel 2480MHz	Test Voltage	120V/60Hz

--	--	--	--	--	--	--	--	--	--

No	Frequency (MHz)	Reading (dBμV)	C.F (dB/m)	Measurement (dBμV/m)	Margin (dB)	Limit (dBμV/m)	Remark (QP/PK/AV)
1	4230.000	37.25	2.04	39.29	-34.71	74.00	Peak
2	5046.000	36.76	4.03	40.78	-33.22	74.00	Peak
3	* 7681.000	32.67	13.17	45.84	-28.16	74.00	Peak

Note:

1. " *", means this data is the worst emission level.
2. C.F (Correction Factor) = Antenna Factor (dB/m) + Cable Loss (dB) – Preamplifier(dB).
3. Measurement(dBμV/m) = Reading(dBμV) + C.F (Correction Factor).

EUT	ACCESS POINT	Date of Test	2022-01-06
Factor	BBHA 9120D (1GHz~18GHz)_2021	Temp. / Humidity	26.6°C/50.8%
Polarity	Vertical	Site / Test Engineer	AC1 / Jay Chu
Test Mode	Transmit by Zigbee at Channel 2480MHz	Test Voltage	120V/60Hz

--	--	--	--	--	--	--	--

No	Frequency (MHz)	Reading (dBμV)	C.F (dB/m)	Measurement (dBμV/m)	Margin (dB)	Limit (dBμV/m)	Remark (QP/PK/AV)
1	4230.000	37.40	2.04	39.44	-34.56	74.00	Peak
2	5012.000	36.67	3.97	40.64	-33.36	74.00	Peak
3	* 7664.000	32.58	13.15	45.73	-28.27	74.00	Peak

Note:

1. " *", means this data is the worst emission level.
2. C.F (Correction Factor) = Antenna Factor (dB/m) + Cable Loss (dB) – Preamplifier(dB).
3. Measurement(dBμV/m) = Reading(dBμV) + C.F (Correction Factor).

The Result of Radiated Emission below 1GHz:

EUT	ACCESS POINT	Date of Test	2022-03-22
Factor	FMZB 1519B (9KHz~30MHz)_2021	Temp. / Humidity	24.3°C /44.5%
Polarity	face on	Site / Test Engineer	AC1 / Jay
Test Mode	Transmit by Zigbee at Channel 2440MHz	Test Voltage	120V/60Hz

--	--	--	--	--	--	--	--	--	--

No	Frequency (MHz)	Reading (dBμV)	C.F (dB/m)	Measurement (dBμV/m)	Margin (dB)	Limit (dBμV/m)	Remark (QP/PK/AV)	
1	0.025	37.47	19.02	56.49	-63.21	119.70	Peak	
2	*	0.049	32.71	19.42	52.13	-61.67	113.79	Peak
3	0.063	26.49	19.12	45.60	-65.96	111.56	Peak	
4	0.074	29.48	18.89	48.37	-61.88	110.24	Peak	
5	0.098	25.72	18.36	44.08	-63.71	107.79	Peak	
6	0.127	21.81	18.39	40.20	-65.34	105.54	Peak	

Note:

1. " *", means this data is the worst emission level.
2. C.F (Correction Factor) = Antenna Factor (dB/m) + Cable Loss (dB).
3. Measurement(dBμV/m) = Reading(dBμV) + C.F (Correction Factor).

EUT	ACCESS POINT	Date of Test	2022-03-22
Factor	FMZB 1519B (9KHz~30MHz)_2021	Temp. / Humidity	24.3°C /44.5%
Polarity	face off	Site / Test Engineer	AC1 / Jay
Test Mode	Transmit by Zigbee at Channel 2440MHz	Test Voltage	120V/60Hz

(This area is intentionally left blank for additional test results or observations.)			
--	--	--	--

No	Frequency (MHz)	Reading (dBμV)	C.F (dB/m)	Measurement (dBμV/m)	Margin (dB)	Limit (dBμV/m)	Remark (QP/PK/AV)
1	0.019	42.09	18.49	60.57	-61.34	121.91	Peak
2	* 0.024	41.82	18.95	60.77	-59.18	119.95	Peak
3	0.050	25.13	19.41	44.55	-69.15	113.69	Peak
4	0.062	23.46	19.14	42.60	-69.12	111.72	Peak
5	0.074	21.64	18.89	40.53	-69.74	110.27	Peak
6	0.098	19.12	18.36	37.48	-70.31	107.79	Peak

Note:

1. " *", means this data is the worst emission level.
2. C.F (Correction Factor) = Antenna Factor (dB/m) + Cable Loss (dB).
3. Measurement(dBμV/m) = Reading(dBμV) + C.F (Correction Factor).

EUT	ACCESS POINT	Date of Test	2022-03-22
Factor	FMZB 1519B (9KHz~30MHz)_2021	Temp. / Humidity	24.3°C /44.5%
Polarity	face on	Site / Test Engineer	AC1 / Jay
Test Mode	Transmit by Zigbee at Channel 2440MHz	Test Voltage	120V/60Hz

--	--	--	--	--	--	--	--	--	--

No	Frequency (MHz)	Reading (dBμV)	C.F (dB/m)	Measurement (dBμV/m)	Margin (dB)	Limit (dBμV/m)	Remark (QP/PK/AV)
1	0.180	29.22	18.55	47.77	-54.73	102.50	Peak
2	0.419	23.33	18.93	42.26	-52.90	95.17	Peak
3	* 1.284	18.07	19.04	37.11	-28.34	65.45	Peak
4	2.493	13.80	18.89	32.69	-36.81	69.50	Peak
5	5.926	11.09	19.73	30.82	-38.68	69.50	Peak
6	10.001	9.24	21.20	30.44	-39.06	69.50	Peak

Note:

1. " *", means this data is the worst emission level.
2. C.F (Correction Factor) = Antenna Factor (dB/m) + Cable Loss (dB).
3. Measurement(dBμV/m) = Reading(dBμV) + C.F (Correction Factor).

EUT	ACCESS POINT	Date of Test	2022-03-22
Factor	FMZB 1519B (9KHz~30MHz)_2021	Temp. / Humidity	24.3°C /44.5%
Polarity	face off	Site / Test Engineer	AC1 / Jay
Test Mode	Transmit by Zigbee at Channel 2440MHz	Test Voltage	120V/60Hz

--	--	--	--

No	Frequency (MHz)	Reading (dB μ V)	C.F (dB/m)	Measurement (dB μ V/m)	Margin (dB)	Limit (dB μ V/m)	Remark (QP/PK/AV)
1	0.165	24.28	18.51	42.79	-60.47	103.25	Peak
2	0.419	21.65	18.93	40.59	-54.58	95.17	Peak
3	* 0.822	16.65	19.02	35.67	-33.65	69.32	Peak
4	2.374	13.28	18.91	32.19	-37.31	69.50	Peak
5	4.374	12.63	19.21	31.84	-37.66	69.50	Peak
6	8.269	12.18	20.57	32.75	-36.75	69.50	Peak

Note:

1. " *", means this data is the worst emission level.
2. C.F (Correction Factor) = Antenna Factor (dB/m) + Cable Loss (dB).
3. Measurement(dB μ V/m) = Reading(dB μ V) + C.F (Correction Factor).

EUT	ACCESS POINT	Date of Test	2022-01-06
Factor	VULB 9162 (30MHz~8GHz) + 6dB Attenuator_2020	Temp. / Humidity	22.2°C /39.5%
Polarity	Horizontal	Site / Test Engineer	AC1 / Jay Chu
Test Mode	Transmit by Zigbee at Channel 2440MHz	Test Voltage	120V/60Hz

(This area is reserved for test results or additional data.)			
--	--	--	--

No	Frequency (MHz)	Reading (dB μ V)	C.F (dB/m)	Measurement (dB μ V/m)	Margin (dB)	Limit (dB μ V/m)	Remark (QP/PK/AV)
1	51.340	0.90	21.80	22.71	-17.29	40.00	Peak
2	219.635	11.27	19.21	30.48	-15.52	46.00	Peak
3	238.065	9.94	20.10	30.04	-15.96	46.00	Peak
4	313.725	6.02	21.97	27.99	-18.01	46.00	Peak
5	368.045	5.58	23.53	29.11	-16.89	46.00	Peak
6	* 903.485	1.95	31.80	33.75	-12.25	46.00	Peak

Note:

1. " *", means this data is the worst emission level.
2. C.F (Correction Factor) = Antenna Factor (dB/m) + Cable Loss (dB).
3. Measurement(dB μ V/m) = Reading(dB μ V) + C.F (Correction Factor).

EUT	ACCESS POINT	Date of Test	2022-01-06
Factor	VULB 9162 (30MHz~8GHz) + 6dB Attenuator_2020	Temp. / Humidity	22.2°C /39.5%
Polarity	Vertical	Site / Test Engineer	AC1 / Jay Chu
Test Mode	Transmit by Zigbee at Channel 2440MHz	Test Voltage	120V/60Hz

--	--	--	--

No	Frequency (MHz)	Reading (dB μ V)	C.F (dB/m)	Measurement (dB μ V/m)	Margin (dB)	Limit (dB μ V/m)	Remark (QP/PK/AV)	
1	*	52.310	8.69	21.62	30.32	-9.68	40.00	Peak
2		174.045	6.67	16.95	23.62	-19.88	43.50	Peak
3		219.635	8.23	19.21	27.44	-18.56	46.00	Peak
4		454.860	2.00	25.02	27.02	-18.98	46.00	Peak
5		711.910	2.33	29.51	31.84	-14.16	46.00	Peak
6		861.290	1.72	31.55	33.27	-12.73	46.00	Peak

Note:

- "*" means this data is the worst emission level.
- C.F (Correction Factor) = Antenna Factor (dB/m) + Cable Loss (dB).
- Measurement(dB μ V/m) = Reading(dB μ V) + C.F (Correction Factor).

The Result of Radiated Spurious Emission above 18GHz:

EUT	ACCESS POINT	Date of Test	2022-01-25
Factor	BBHA 9170 (15GHz~40GHz)_2021	Temp. / Humidity	19.5°C/37.2%
Polarity	Horizontal	Site / Test Engineer	AC1 / Jay Chu
Test Mode	Transmit by Zigbee at Channel 2440MHz	Test Voltage	120V / 60Hz

(This area is reserved for detailed test results, including graphs and additional data points.)							
---	--	--	--	--	--	--	--

No	Frequency (MHz)	Reading (dBμV)	C.F (dB/m)	Measurement (dBμV/m)	Margin (dB)	Limit (dBμV/m)	Remark (QP/PK/AV)	
1	*	20800.000	42.31	3.36	45.67	-28.33	74.00	Peak
2		22316.000	40.63	3.65	44.28	-29.72	74.00	Peak
3		22924.000	40.23	4.05	44.28	-29.72	74.00	Peak

Note:

1. " *", means this data is the worst emission level.
2. C.F (Correction Factor) = Antenna Factor (dB/m) + Cable Loss (dB) – Preamplifier(dB).
3. Measurement(dBμV/m) = Reading(dBμV) + C.F (Correction Factor).

EUT	ACCESS POINT	Date of Test	2022-01-25
Factor	BBHA 9170 (15GHz~40GHz)_2021	Temp. / Humidity	19.5°C/37.2%
Polarity	Vertical	Site / Test Engineer	AC1 / Jay Chu
Test Mode	Transmit by Zigbee at Channel 2440MHz	Test Voltage	120V / 60Hz

--	--	--	--	--	--	--	--

No	Frequency (MHz)	Reading (dBμV)	C.F (dB/m)	Measurement (dBμV/m)	Margin (dB)	Limit (dBμV/m)	Remark (QP/PK/AV)
1	20972.000	38.87	3.39	42.26	-31.74	74.00	Peak
2	22372.000	38.02	3.70	41.72	-32.28	74.00	Peak
3	* 22860.000	38.30	4.02	42.32	-31.68	74.00	Peak

Note:

1. " *", means this data is the worst emission level.
2. C.F (Correction Factor) = Antenna Factor (dB/m) + Cable Loss (dB) – Preamplifier(dB).
3. Measurement(dBμV/m) = Reading(dBμV) + C.F (Correction Factor).

7.7. Radiated Restricted Band Edge Measurement

7.7.1. Test Limit

For 15.205 requirement:

Radiated emissions which fall in the restricted bands, as defined in Section 15.205(a) of FCC part 15, must also comply with the radiated emission limits specified in Section 15.209(a).

Frequency (MHz)	Frequency (MHz)	Frequency (MHz)	Frequency (GHz)
0.090 - 0.110	16.42 - 16.423	399.9 - 410	4.5 - 5.15
¹ 0.495 - 0.505	16.69475 - 16.69525	608 - 614	5.35 - 5.46
2.1735 - 2.1905	16.80425 - 16.80475	960 - 1240	7.25 - 7.75
4.125 - 4.128	25.5 - 25.67	1300 - 1427	8.25 - 8.5
4.17725 - 4.17775	37.5 - 38.25	1435 - 1626.5	9.0 - 9.2
4.20725 - 4.20775	73 - 74.6	1645.5 - 1646.5	9.3 - 9.5
6.215 - 6.218	74.8 - 75.2	1660 - 1710	10.6 - 12.7
6.26775 - 6.26825	108 - 121.94	1718.8 - 1722.2	13.25 - 13.4
6.31175 - 6.31225	123 - 138	2200 - 2300	14.47 - 14.5
8.291 - 8.294	149.9 - 150.05	2310 - 2390	15.35 - 16.2
8.362 - 8.366	156.52475 - 156.525	2483.5 - 2500	17.7 - 21.4
8.37625 - 8.38675	156.7 - 156.9	2690 - 2900	22.01 - 23.12
8.41425 - 8.41475	162.0125 - 167.17	3260 - 3267	23.6 - 24.0
12.29 - 12.293	167.72 - 173.2	3332 - 3339	31.2 - 31.8
12.51975 - 12.52025	240 - 285	3345.8 - 3358	36.43 - 36.5
12.57675 - 12.57725	322 - 335.4	3600 - 4400	(²)
13.36 - 13.41	--	--	--

All out of band emissions appearing in a restricted band as specified in Section 15.205 of the Title 47CFR must not exceed the limits shown in Table per Section 15.209.

FCC Part 15 Subpart C Paragraph 15.209		
Frequency [MHz]	Field Strength [uV/m]	Measured Distance [Meters]
0.009 - 0.490	2400/F (kHz)	300
0.490 - 1.705	24000/F (kHz)	30
1.705 - 30	30	30
30 - 88	100	3
88 - 216	150	3
216 - 960	200	3
Above 960	500	3

7.7.2. Test Procedure Used

ANSI C63.10-2013 Section 6.3 (General Requirements)

ANSI C63.10-2013 Section 6.6 (Standard test method above 1GHz)

ANSI C63.10-2013 Section 11.13

7.7.3. Test Setting

Peak Field Strength Measurements

1. Analyzer center frequency was set to the frequency of the radiated spurious emission of interest
2. RBW = 1MHz
3. VBW = 3MHz
4. Detector = peak
5. Sweep time = auto couple
6. Trace mode = max hold
7. Trace was allowed to stabilize

Average Field Strength Measurements

1. Average Measurement Level = Peak Measurement Level - $20 * \text{Log}(\text{Duty Cycle}) = -20$
2. Duty Cycle = 10%

7.7.4. Test Setup

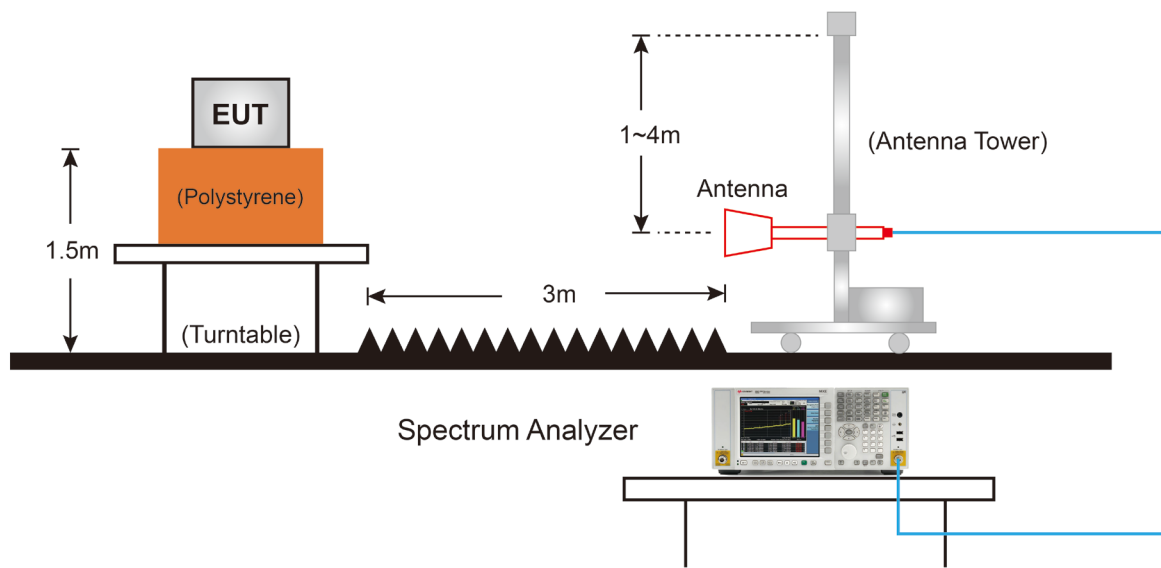

7.7.5. Test Result
Filter Configuration 4#

EUT	ACEESS POINT	Date of Test	2022-01-06
Factor	BBHA 9120D (1GHz~18GHz)_2021	Temp. / Humidity	26.2°C/52.4%
Polarity	Horizontal	Site / Test Engineer	AC1 / Jay Chu
Test Mode	Transmit by Zigbee at Channel 2405MHz	Test Voltage	120V/60Hz

(This area is reserved for test results or images.)			
---	--	--	--

No	Frequency (MHz)	Reading (dBμV)	C.F (dB/m)	Measurement (dBμV/m)	Margin (dB)	Limit (dBμV/m)	Remark (QP/PK/AV)
1	2378.600	25.58	32.17	57.75	-16.25	74.00	Peak
1	2378.600	25.58	32.17	37.75	-16.25	54.00	Average
2	2390.000	21.03	32.22	53.24	-20.76	74.00	Peak
2	2390.000	21.03	32.22	33.24	-20.76	54.00	Average
3	* 2405.500	72.30	32.28	104.58	N/A	N/A	Peak
3	* 2405.500	72.30	32.28	84.58	N/A	N/A	Average

Note:

1. " *", means this data is the worst emission level.
2. C.F (Correction Factor) = Antenna Factor (dB/m) + Cable Loss (dB).
3. Measurement(dBμV/m) = Reading(dBμV) + C.F (Correction Factor).
4. Average Measure Level = Peak Measure Level + Duty Cycle Factor.

EUT	ACEESS POINT	Date of Test	2022-01-06
Factor	BBHA 9120D (1GHz~18GHz)_2021	Temp. / Humidity	26.2°C/52.4%
Polarity	Vertical	Site / Test Engineer	AC1 / Jay Chu
Test Mode	Transmit by Zigbee at Channel 2405MHz	Test Voltage	120V/60Hz

--	--	--	--

No	Frequency (MHz)	Reading (dBμV)	C.F (dB/m)	Measurement (dBμV/m)	Margin (dB)	Limit (dBμV/m)	Remark (QP/PK/AV)
1	2372.300	25.37	32.14	57.51	-16.49	74.00	Peak
1	2372.300	25.37	32.14	37.51	-16.49	54.00	Average
2	2390.000	22.87	32.22	55.09	-18.91	74.00	Peak
2	2390.000	22.87	32.22	35.09	-18.91	54.00	Average
3	* 2405.450	70.13	32.28	102.41	N/A	N/A	Peak
3	* 2405.450	70.13	32.28	82.41	N/A	N/A	Average

Note:

1. " *", means this data is the worst emission level.
2. C.F (Correction Factor) = Antenna Factor (dB/m) + Cable Loss (dB).
3. Measurement(dBμV/m) = Reading(dBμV) + C.F (Correction Factor).
4. Average Measure Level = Peak Measure Level + Duty Cycle Factor.

EUT	ACEESS POINT	Date of Test	2022-01-06
Factor	BBHA 9120D (1GHz~18GHz)_2021	Temp. / Humidity	26.0°C/48.2%
Polarity	Horizontal	Site / Test Engineer	AC1 / Jay Chu
Test Mode	Transmit by Zigbee at Channel 2480MHz	Test Voltage	120V/60Hz

--	--	--	--	--	--	--	--	--	--

No		Frequency (MHz)	Reading (dBμV)	C.F (dB/m)	Measurement (dBμV/m)	Margin (dB)	Limit (dBμV/m)	Remark (QP/PK/AV)
1	*	2479.474	71.32	32.59	103.91	N/A	N/A	Peak
1	*	2479.474	71.32	32.59	83.91	N/A	N/A	Average
2		2483.500	36.46	32.61	69.07	-4.93	74.00	Peak
2		2483.500	36.46	32.61	49.07	-4.93	54.00	Average

Note:

1. " *", means this data is the worst emission level.
2. C.F (Correction Factor) = Antenna Factor (dB/m) + Cable Loss (dB).
3. Measurement(dBμV/m) = Reading(dBμV) + C.F (Correction Factor).
4. Average Measure Level = Peak Measure Level + Duty Cycle Factor.

EUT	ACEESS POINT	Date of Test	2022-01-06
Factor	BBHA 9120D (1GHz~18GHz)_2021	Temp. / Humidity	26.0°C/48.2%
Polarity	Vertical	Site / Test Engineer	AC1 / Jay Chu
Test Mode	Transmit by Zigbee at Channel 2480MHz	Test Voltage	120V/60Hz

			
---	--	--	--

No		Frequency (MHz)	Reading (dBμV)	C.F (dB/m)	Measurement (dBμV/m)	Margin (dB)	Limit (dBμV/m)	Remark (QP/PK/AV)
1	*	2479.496	69.61	32.59	102.20	N/A	N/A	Peak
1	*	2479.496	69.61	32.59	82.20	N/A	N/A	Average
2		2483.500	34.11	32.61	66.72	-7.28	74.00	Peak
2		2483.500	34.11	32.61	46.72	-7.28	54.00	Average
3		2483.511	34.24	32.61	66.85	-7.15	74.00	Peak
3		2483.511	34.24	32.61	46.85	-7.15	54.00	Average

Note:

1. " *", means this data is the worst emission level.
2. C.F (Correction Factor) = Antenna Factor (dB/m) + Cable Loss (dB).
3. Measurement(dBμV/m) = Reading(dBμV) + C.F (Correction Factor).
4. Average Measure Level = Peak Measure Level + Duty Cycle Factor.

Filter Configuration 5#

EUT	ACEESS POINT	Date of Test	2022-01-06
Factor	BBHA 9120D (1GHz~18GHz)_2021	Temp. / Humidity	26.2°C/52.4%
Polarity	Horizontal	Site / Test Engineer	AC1 / Jay Chu
Test Mode	Transmit by Zigbee at Channel 2405MHz	Test Voltage	120V/60Hz

(This area is intentionally left blank for test results or observations.)			
---	--	--	--

No	Frequency (MHz)	Reading (dBμV)	C.F (dB/m)	Measurement (dBμV/m)	Margin (dB)	Limit (dBμV/m)	Remark (QP/PK/AV)
1	2374.400	25.38	32.15	57.53	-16.47	74.00	Peak
1	2374.400	25.38	32.15	37.53	-16.47	54.00	Average
2	2390.000	23.42	32.22	55.64	-18.36	74.00	Peak
2	2390.000	23.42	32.22	35.64	-18.36	54.00	Average
3	* 2404.500	69.40	32.28	101.67	N/A	N/A	Peak
3	* 2404.500	69.40	32.28	81.67	N/A	N/A	Average

Note:

1. " *", means this data is the worst emission level.
2. C.F (Correction Factor) = Antenna Factor (dB/m) + Cable Loss (dB).
3. Measurement(dBμV/m) = Reading(dBμV) + C.F (Correction Factor).
4. Average Measure Level = Peak Measure Level + Duty Cycle Factor.

EUT	ACEESS POINT	Date of Test	2022-01-06
Factor	BBHA 9120D (1GHz~18GHz)_2021	Temp. / Humidity	26.2°C/52.4%
Polarity	Vertical	Site / Test Engineer	AC1 / Jay Chu
Test Mode	Transmit by Zigbee at Channel 2405MHz	Test Voltage	120V/60Hz

--	--	--	--

No	Frequency (MHz)	Reading (dBμV)	C.F (dB/m)	Measurement (dBμV/m)	Margin (dB)	Limit (dBμV/m)	Remark (QP/PK/AV)
1	2310.750	25.11	31.89	57.00	-17.00	74.00	Peak
1	2310.750	25.11	31.89	37.00	-17.00	54.00	Average
2	2390.000	21.88	32.22	54.10	-19.90	74.00	Peak
2	2390.000	21.88	32.22	34.10	-19.90	54.00	Average
3	* 2404.500	68.13	32.28	100.41	N/A	N/A	Peak
3	* 2404.500	68.13	32.28	80.41	N/A	N/A	Average

Note:

1. " *", means this data is the worst emission level.
2. C.F (Correction Factor) = Antenna Factor (dB/m) + Cable Loss (dB).
3. Measurement(dBμV/m) = Reading(dBμV) + C.F (Correction Factor).
4. Average Measure Level = Peak Measure Level + Duty Cycle Factor.

Filter Configuration 6#

EUT	ACEESS POINT	Date of Test	2022-01-06
Factor	BBHA 9120D (1GHz~18GHz)_2021	Temp. / Humidity	26.0°C/48.2%
Polarity	Horizontal	Site / Test Engineer	AC1 / Jay Chu
Test Mode	Transmit by Zigbee at Channel 2480MHz	Test Voltage	120V/60Hz

(This area is intentionally left blank for detailed test results or observations.)			
--	--	--	--

No		Frequency (MHz)	Reading (dBμV)	C.F (dB/m)	Measurement (dBμV/m)	Margin (dB)	Limit (dBμV/m)	Remark (QP/PK/AV)
1	*	2479.485	68.74	32.59	101.33	N/A	N/A	Peak
1	*	2479.485	68.74	32.59	81.33	N/A	N/A	Average
2		2483.500	33.07	32.61	65.68	-8.32	74.00	Peak
2		2483.500	33.07	32.61	45.68	-8.32	54.00	Average
3		2483.533	33.26	32.61	65.87	-8.13	74.00	Peak
3		2483.533	33.26	32.61	45.87	-8.13	54.00	Average

Note:

1. " *", means this data is the worst emission level.
2. C.F (Correction Factor) = Antenna Factor (dB/m) + Cable Loss (dB).
3. Measurement(dBμV/m) = Reading(dBμV) + C.F (Correction Factor).
4. Average Measure Level = Peak Measure Level + Duty Cycle Factor.

EUT	ACEESS POINT	Date of Test	2022-01-06
Factor	BBHA 9120D (1GHz~18GHz)_2021	Temp. / Humidity	26.0°C/48.2%
Polarity	Vertical	Site / Test Engineer	AC1 / Jay Chu
Test Mode	Transmit by Zigbee at Channel 2480MHz	Test Voltage	120V/60Hz

--	--	--	--

No		Frequency (MHz)	Reading (dBμV)	C.F (dB/m)	Measurement (dBμV/m)	Margin (dB)	Limit (dBμV/m)	Remark (QP/PK/AV)
1	*	2479.507	66.61	32.59	99.20	N/A	N/A	Peak
1	*	2479.507	66.61	32.59	79.20	N/A	N/A	Average
2		2483.500	31.73	32.61	64.34	-9.66	74.00	Peak
2		2483.500	31.73	32.61	44.34	-9.66	54.00	Average

Note:

1. " *", means this data is the worst emission level.
2. C.F (Correction Factor) = Antenna Factor (dB/m) + Cable Loss (dB).
3. Measurement(dBμV/m) = Reading(dBμV) + C.F (Correction Factor).
4. Average Measure Level = Peak Measure Level + Duty Cycle Factor.

7.8. AC Conducted Emissions Measurement

7.8.1. Test Limit

FCC Part 15 Subpart C Paragraph 15.207 Limits		
Frequency (MHz)	QP (dBuV)	AV (dBuV)
0.15 - 0.50	66 - 56	56 - 46
0.50 - 5.0	56	46
5.0 - 30	60	50

Note 1: The lower limit shall apply at the transition frequencies.

Note 2: The limit decreases linearly with the logarithm of the frequency in the range 0.15MHz to 0.5MHz.

7.8.2. Test Setup

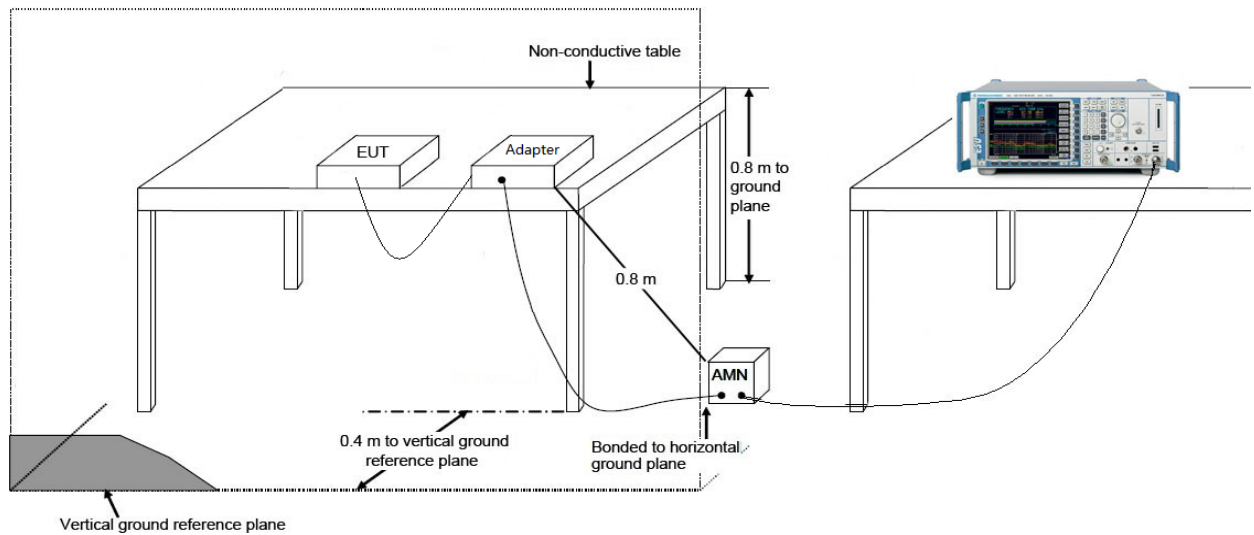

7.8.3. Test Result

EUT	ACCESS POINT	Date of Test	2022-01-06
Factor	CE_ENV216-L1 (Filter OFF)_2021	Temp. / Humidity	20.3°C /43.5%
Polarity	Line1	Site / Test Engineer	SR2 / Eric Lin
Test Mode	Transmit by Zigbee at channel 2440MHz	Test Voltage	120V/60Hz



No	Frequency (MHz)	Reading (dBμV)	C.F (dB)	Measurement (dBμV)	Margin (dB)	Limit (dBμV)	Remark (QP/PK/AV)
1	0.150	34.39	9.61	44.00	-22.00	66.00	QP
2	0.150	16.29	9.61	25.90	-30.10	56.00	Average
3	* 0.162	33.99	9.61	43.60	-21.76	65.36	QP
4	0.162	16.89	9.61	26.50	-28.86	55.36	Average
5	0.178	31.49	9.61	41.10	-23.48	64.58	QP
6	0.178	14.09	9.61	23.70	-30.88	54.58	Average
7	0.198	27.79	9.61	37.40	-26.29	63.69	QP
8	0.198	10.39	9.61	20.00	-33.69	53.69	Average
9	0.238	21.18	9.62	30.80	-31.37	62.17	QP
10	0.238	6.18	9.62	15.80	-36.37	52.17	Average
11	18.600	14.04	9.96	24.00	-36.00	60.00	QP
12	18.600	9.04	9.96	19.00	-31.00	50.00	Average

Note:

1. " *", means this data is the worst emission level.
2. C.F (Correction Factor) = LISN Factor (dB) + Cable Loss (dB).
3. Measurement(dBμV) = Reading(dBμV) + C.F (Correction Factor).

EUT	ACCESS POINT	Date of Test	2022-01-06
Factor	CE_ENV216-N (Filter OFF)_2021	Temp. / Humidity	20.3°C /43.5%
Polarity	Neutral	Site / Test Engineer	SR2 / Eric Lin
Test Mode	Transmit by Zigbee at channel 2440MHz	Test Voltage	120V/60Hz

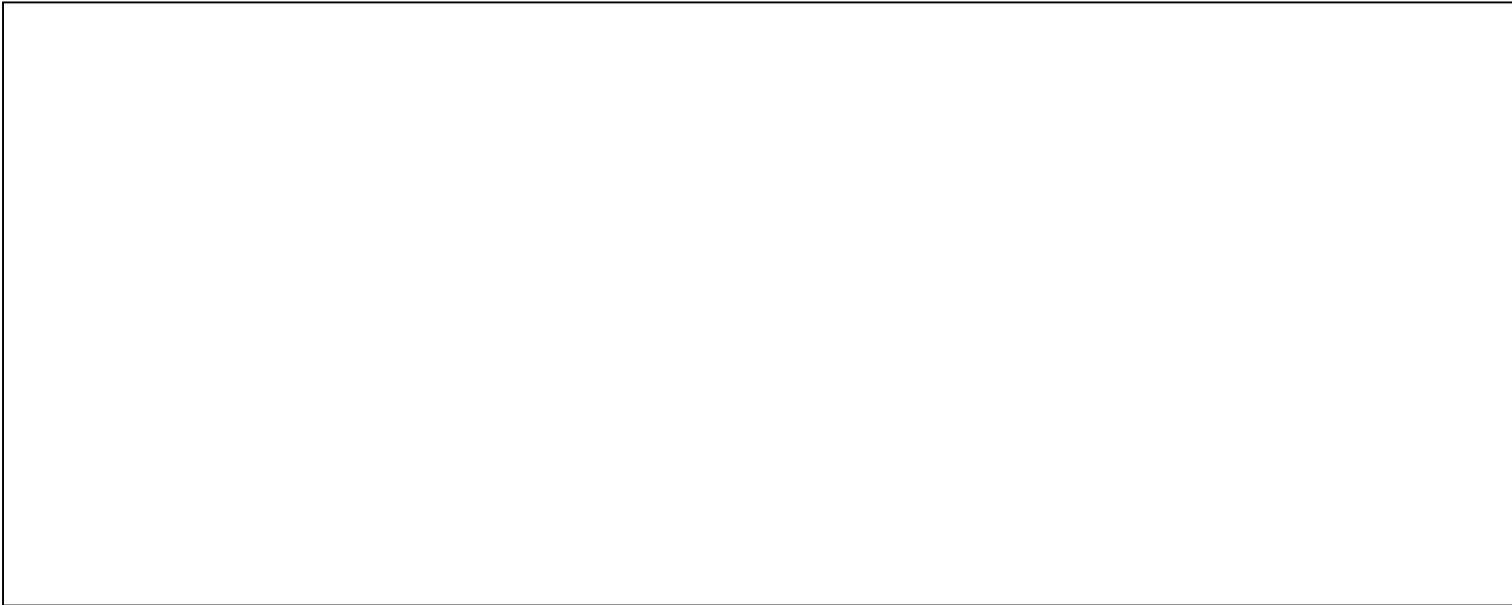

No	Frequency (MHz)	Reading (dBμV)	C.F (dB)	Measurement (dBμV)	Margin (dB)	Limit (dBμV)	Remark (QP/PK/AV)	
1	*	0.150	34.88	9.62	44.50	-21.50	66.00	QP
2		0.150	16.68	9.62	26.30	-29.70	56.00	Average
3		0.158	32.18	9.62	41.80	-23.77	65.57	QP
4		0.158	15.88	9.62	25.50	-30.07	55.57	Average
5		0.178	30.68	9.62	40.30	-24.28	64.58	QP
6		0.178	12.98	9.62	22.60	-31.98	54.58	Average
7		0.210	25.79	9.61	35.40	-27.81	63.21	QP
8		0.210	7.19	9.61	16.80	-36.41	53.21	Average
9		0.422	14.77	9.63	24.40	-33.01	57.41	QP
10		0.422	10.17	9.63	19.80	-27.61	47.41	Average
11		19.400	14.96	10.04	25.00	-35.00	60.00	QP
12		19.400	9.56	10.04	19.60	-30.40	50.00	Average

Note:

1. " *", means this data is the worst emission level.
2. C.F (Correction Factor) = LISN Factor (dB) + Cable Loss (dB).
3. Measurement(dBμV) = Reading(dBμV) + C.F (Correction Factor).

8. CONCLUSION

The data collected relate only the item(s) tested and show that the unit is compliance with Part 15C of the FCC Rules.

————— The End —————

Appendix A - Test Setup Photograph

Refer to "2105TW0602-Test setup photo" file.

Appendix B - EUT Photograph

Refer to "2105TW0602-EUT photo" file.