

MEASUREMENT REPORT

FCC PART 15.247 / Bluetooth-LE



FCC ID: Q9DAPIN0655

Applicant: Hewlett Packard Enterprise Company

Application Type: Certification

Product: ACCESS POINT

Model No.: APIN0655

Trademark:  

FCC Classification: Digital Transmission System (DTS)

FCC Rule Part(s): Part15 Subpart C (Section 15.247)

Test Procedure(s): ANSI C63.10-2013

Test Date: September 28, 2021 ~ March 22, 2022

Reviewed By: 
(Paddy Chen)

Approved By: 
(Chenz Ker)



The test results relate only to the samples tested.

This equipment has been shown to be capable of compliance with the applicable technical standards as indicated in the measurement report and was tested in accordance with the measurement procedures specified in ANSI C63.10-2013. Test results reported herein relate only to the item(s) tested.

The test report shall not be reproduced except in full without the written approval of MRT Technology (Taiwan) Co., Ltd.

Revision History

Report No.	Version	Description	Issue Date	Note
2105TW0602-U1	V1.0	Initial Report	03-22-2022	Valid

CONTENTS

Description	Page
1. INTRODUCTION.....	6
1.1. Scope.....	6
1.2. MRT Test Location	6
2. PRODUCT INFORMATION	7
2.1. Equipment Description.....	7
2.2. Product Specification Subjective to this Report	7
2.3. Working Frequencies for this Report	8
2.4. Description of Available Antennas	9
2.5. Description of EUT Filter.....	10
2.6. Duty Cycle	11
2.7. Description of Test Configuration and Software	12
2.8. EMI Suppression Device(s)/Modifications	12
2.9. Labeling Requirements	12
3. DESCRIPTION OF TEST	13
3.1. Measurement Procedure	13
3.2. AC Line Conducted Emissions	13
3.3. Radiated Emissions	14
4. ANTENNA REQUIREMENTS	15
5. TEST EQUIPMENT CALIBRATION DATE.....	16
6. MEASUREMENT UNCERTAINTY	18
7. TEST RESULT	19
7.1. Summary	19
7.2. 6dB Bandwidth Measurement.....	20
7.2.1. Test Limit	20
7.2.2. Test Procedure used	20
7.2.3. Test Setting.....	20
7.2.4. Test Setup	20
7.2.5. Test Result.....	21
7.3. Output Power Measurement.....	23
7.3.1. Test Limit	23
7.3.2. Test Procedure Used.....	23
7.3.3. Test Setting.....	23
7.3.4. Test Setup	24
7.3.5. Test Result.....	25
7.4. Power Spectral Density Measurement	27
7.4.1. Test Limit	27
7.4.2. Test Procedure Used.....	27

7.4.3. Test Setting.....	27
7.4.4. Test Setup	27
7.4.5. Test Result.....	28
7.5. Conducted Band Edge and Out-of-Band Emissions.....	30
7.5.1. Test Limit	30
7.5.2. Test Procedure Used.....	30
7.5.3. Test Settintg.....	30
7.5.4. Test Setup	31
7.5.5. Test Result.....	32
7.6. Radiated Spurious Emission Measurement.....	39
7.6.1. Test Limit	39
7.6.2. Test Procedure Used.....	39
7.6.3. Test Setting.....	39
7.6.4. Test Setup	41
7.6.5. Test Result.....	42
7.7. Radiated Restricted Band Edge Measurement	70
7.7.1. Test Limit	70
7.7.2. Test Procedure Used.....	71
7.7.3. Test Setting.....	71
7.7.4. Test Setup	72
7.7.5. Test Result.....	73
7.8. AC Conducted Emissions Measurement.....	105
7.8.1. Test Limit	105
7.8.2. Test Setup	105
7.8.3. Test Result.....	106
8. CONCLUSION	108
Appendix A - Test Setup Photograph	109
Appendix B - EUT Photograph.....	110

General Information

Applicant	Hewlett Packard Enterprise Company
Applicant Address	3333 Scott Blvd, Santa Clara, CA 95054, USA
Manufacturer	Hewlett Packard Enterprise Company
Manufacturer Address	3333 Scott Blvd, Santa Clara, CA 95054, USA
Test Site	MRT Technology (Taiwan) Co., Ltd
Test Site Address	No. 38, Fuxing Second Rd., Guishan Dist., Taoyuan City 333, Taiwan (R.O.C)
MRT FCC Registration No.	291082
FCC Rule Part(s)	Part 15.247
Test Device Serial No.	CNMJKZ2024 <input type="checkbox"/> Production <input checked="" type="checkbox"/> Pre-Production <input type="checkbox"/> Engineering

Test Facility / Accreditations

1. MRT facility is a FCC registered (Reg. No. 291082) test facility with the site description report on file and is designated by the FCC as an Accredited Test Firm.
2. MRT facility is an IC registered (MRT Reg. No. 21723) test laboratory with the site description on file at Industry Canada.
3. MRT Lab is accredited to ISO 17025 by the Taiwan Accreditation Foundation (TAF Cert. No. 3261) in EMC, Telecommunications and Radio testing for FCC (Designation Number: TW3261), Industry Taiwan, EU and TELEC Rules.

1. INTRODUCTION

1.1. Scope

Measurement and determination of electromagnetic emissions (EMC) of radio frequency devices including intentional and/or unintentional radiators for compliance with the technical rules and regulations of the Federal Communications Commission and the Innovation, Science and Economic Development Canada and Certification and Engineering Bureau.

1.2. MRT Test Location

The map below shows the location of the MRT LABORATORY, its proximity to the Taoyuan City. These measurement tests were conducted at the MRT Technology (Taiwan) Co., Ltd. Facility located at No.38, Fuxing 2nd Rd., Guishan Dist., Taoyuan City 33377, Taiwan (R.O.C).

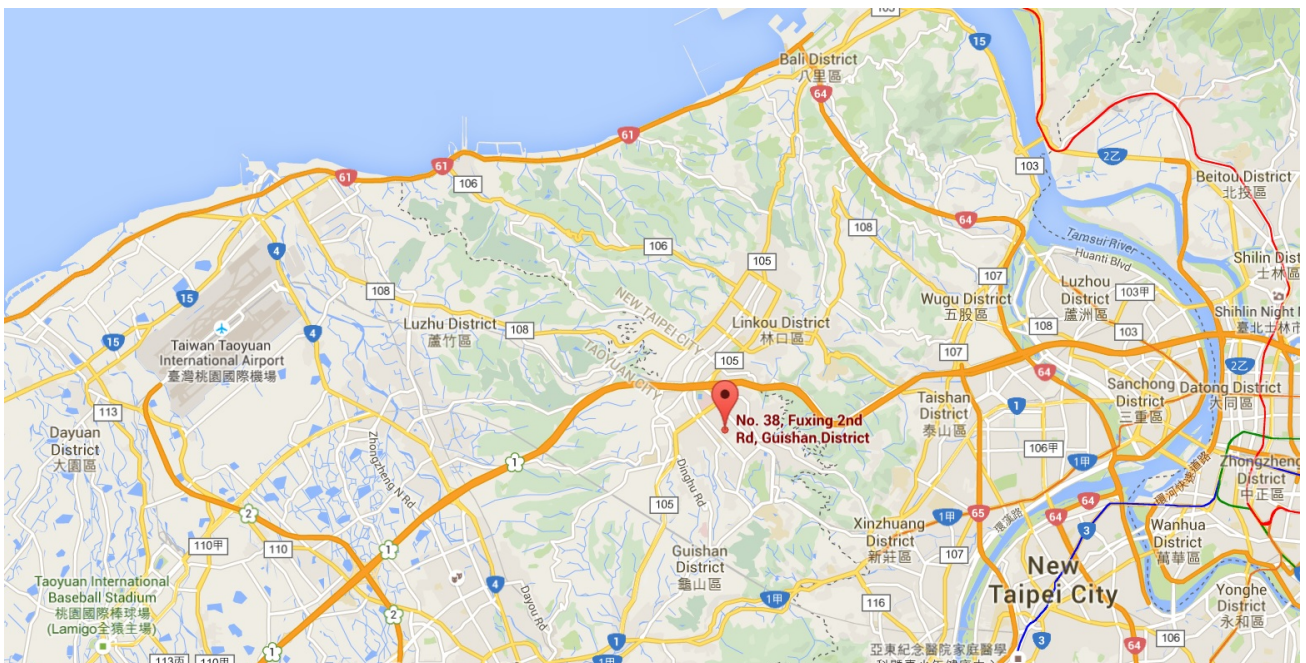

2. PRODUCT INFORMATION

2.1. Equipment Description

Product Name	ACCESS POINT
Model No.	APIN0655
Software Version	BLE_fw_v100.hex
Wi-Fi Specification	802.11a/b/g/n/ac/ax
Bluetooth Version	v5.0 single mode, BLE only
Zigbee Specification	802.15.4
GNSS Specification	GPS, GLONASS, Galileo
Operating Temperature	0 ~ 50 °C
Filter Information	Refer to Section 2.4
Antenna Information	Refer to Section 2.5
Power Type	AC Adapter or PoE input
Operating Environment	Indoor Use
Remark: The information of EUT was provided by the manufacturer, and the accuracy of the information shall be the responsibility of the manufacturer.	

2.2. Product Specification Subjective to this Report

Bluetooth Frequency	2402 ~ 2480MHz
Bluetooth Version	v5.0 single mode, BLE only
Type of modulation	GFSK
Data Rate	1Mbps & 2Mbps

Note: For other features of this EUT, test report will be issued separately.

2.3. Working Frequencies for this Report

Channel	Frequency	Channel	Frequency	Channel	Frequency
00	2402 MHz	01	2404 MHz	02	2406 MHz
03	2408 MHz	04	2410 MHz	05	2412 MHz
06	2414 MHz	07	2416 MHz	08	2418 MHz
09	2420 MHz	10	2422 MHz	11	2424 MHz
12	2426 MHz	13	2428 MHz	14	2430 MHz
15	2432 MHz	16	2434 MHz	17	2436 MHz
18	2438 MHz	19	2440 MHz	20	2442 MHz
21	2444 MHz	22	2446 MHz	23	2448 MHz
24	2450 MHz	25	2452 MHz	26	2454 MHz
27	2456 MHz	28	2458 MHz	29	2460 MHz
30	2462 MHz	31	2464 MHz	32	2466 MHz
33	2468 MHz	34	2470 MHz	35	2472 MHz
36	2474 MHz	37	2476 MHz	38	2478 MHz
39	2480 MHz	--	--	--	--

2.4. Description of Available Antennas

Antenna Type	Frequency Band (GHz)	Max Peak Gain (dBi)	CDD Directional Gain (dBi)		BF Directional Gain (dBi)
			For Power	For PSD	
Wi-Fi Internal Antenna (4*4 MIMO)					
PIFA	2.4 ~ 2.5	3.26	3.26	6.23	6.23
	5.15 ~ 5.9	2.88	2.88	5.60	5.60
	5.9 ~ 7.2	3.97	3.97	6.97	6.97
Bluetooth / ZigBee Internal Antenna					
PIFA	2.4 ~ 2.5		3.60		

Note:

1. The EUT supports Cyclic Delay Diversity (CDD) mode, and CDD signals are correlated.
2. The EUT also supports Beam Forming mode, and the Beam Forming support 802.11n/ac/ax, not include 802.11a/b/g.
3. For beamforming operation, Aruba OS automatically backs power down based on a $10\log(N)$ factor based on CDD power.
4. All Wi-Fi antennas have cross polarized design, the detail information and calculation method refer to antenna specification.

2.5. Description of EUT Filter

Filter	Specification	Remark
Wi-Fi		
Filter 1#	Band Pass Filter (2412-2472)	Allowing any transmission on all channels
Filter 2#	Band Pass Filter (2402-2447)	Allowing any transmission on 20MHz channels 1 thru 6.
Filter 3#	Band Pass Filter (2452-2472)	Allowing any transmission on 20MHz channel 11
Bluetooth & ZigBee		
Filter 4#	Band Pass Filter (2402-2480)	Allowing any transmission on all channels
Filter 5#	Band Pass Filter (2402-2426)	Allowing any transmission on channel 2402 ~ 2426 MHz (BLE) and channel 2405 ~ 2425 MHz (ZigBee)
Filter 6#	Band Pass Filter (2478-2482)	Allowing transmission on channel 2480 MHz (BLE) and 2480 MHz (ZigBee)

Working Group

Groups	Remark
Filter 1# or Filter 4#	Filter 1# or Filter 4# can work alone
Filter 2# and Filter 6#	Transmission simultaneously
Filter 3# and Filter 5#	Transmission simultaneously
Note: Filter groups on the 2.4GHz Wi-Fi and BLE/ZigBee outputs to prevent reverse IMD when both 2.4GHz Wi-Fi and BLE/ZigBee are transmitting simultaneously	

2.6. Duty Cycle

The maximum achievable duty cycles were determined based on measurements performed on a spectrum analyzer in zero-span mode with RBW = 8MHz, VBW = 50MHz. The RBW and VBW were both greater than 50/T, where T is the minimum transmission duration, and the number of sweep points across T was greater than 100. The duty cycles are as follows:

Test Mode	Duty Cycle
BLE - 1Mbps	62.41%
BLE - 2Mbps	32.67%

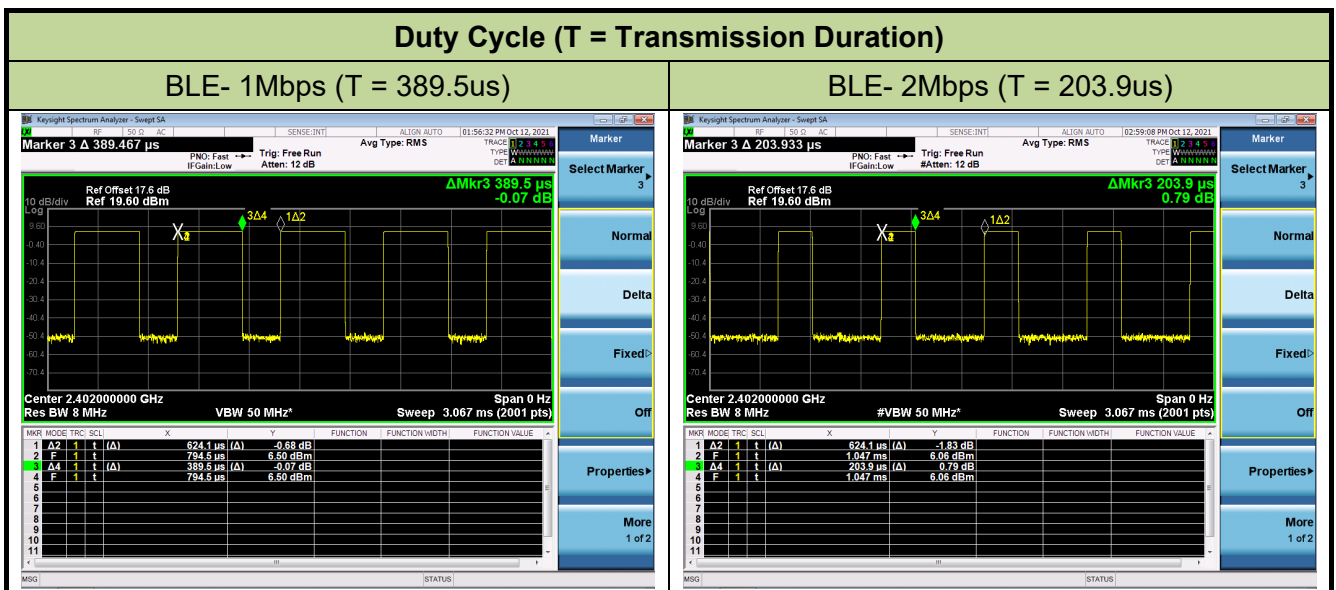

2.7. Description of Test Configuration and Software

The device was tested per the guidance ANSI C63.10-2013 was used to reference the appropriate EUT setup for radiated emissions testing and AC line conducted testing.

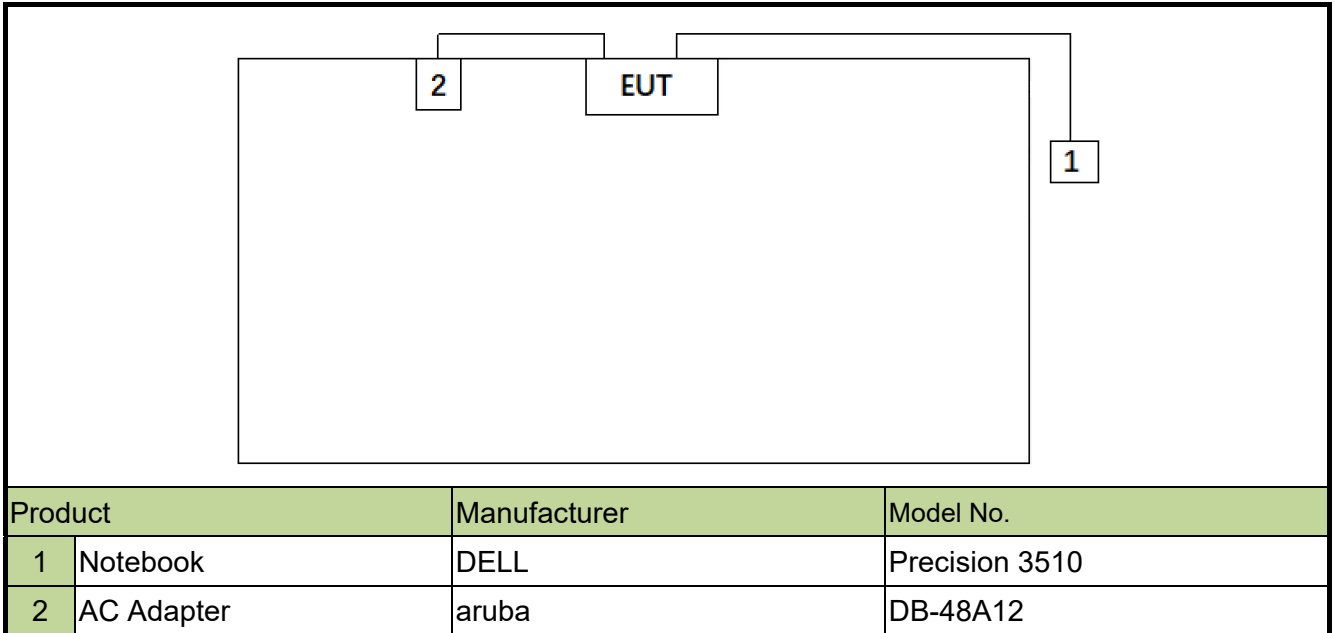

Note 1: The test utility software used during testing was “telnet.exe” and command was provided by the manufacturer.

Note 2: Detail power setting refer to operation description.

2.8. EMI Suppression Device(s)/Modifications

No EMI suppression device(s) were added and/or no modifications were made during testing.

2.9. Labeling Requirements

Per 2.1074 & 15.19; Docket 95-19

The label shall be permanently affixed at a conspicuous location on the device; instruction manual or pamphlet supplied to the user and be readily visible to the purchaser at the time of purchase.

However, when the device is so small wherein placement of the label with specified statement is not practical, only the FCC ID must be displayed on the device per Section 15.19(a)(5). Please see attachment for FCC ID label and label location.

3. DESCRIPTION OF TEST

3.1. Measurement Procedure

The measurement procedure described in the document titled “American National Standard of Procedures for Compliance Testing of Unlicensed Wireless Devices” (ANSI C63.10-2013) was used in the measurement.

3.2. AC Line Conducted Emissions

The line-conducted facility is located inside an 8'x4'x4' shielded enclosure. A 1m x 2m wooden table 80cm high is placed 40cm away from the vertical wall and 80cm away from the sidewall of the shielded room. Two 10kHz-30MHz, 50Ω/50uH Line-Impedance Stabilization Networks (LISNs) are bonded to the shielded room floor. Power to the LISNs is filtered by external high-current high-insertion loss power line filters. These filters attenuate ambient signal noise from entering the measurement lines. These filters are also bonded to the shielded enclosure.

The EUT is powered from one LISN and the support equipment is powered from the second LISN. All interconnecting cables more than 1 meter were shortened to a 1 meter length by non-inductive bundling (serpentine fashion) and draped over the back edge of the test table. All cables were at least 40cm above the horizontal reference ground-plane. Power cables for support equipment were routed down to the second LISN while ensuring that that cables were not draped over the second LISN.

Sufficient time for the EUT, support equipment, and test equipment was allowed in order for them to warm up to their normal operating condition. The RF output of the LISN was connected to the receiver and exploratory measurements were made to determine the frequencies producing the maximum emission from the EUT. The receiver was scanned from 150kHz to 30MHz. The detector function was set to peak mode for exploratory measurements while the bandwidth of the analyzer was set to 9kHz. The EUT, support equipment, and interconnecting cables were arranged and manipulated to maximize each emission. Each emission was also maximized by varying: power lines, the mode of operation or data exchange speed, or support equipment whichever determined the worst-case emission. Once the worst case emissions have been identified, the one EUT cable configuration/arrangement and mode of operation that produced these emissions were used for final measurements on the same test site. The analyzer is set to CISPR quasi-peak and average detectors with a 9kHz resolution bandwidth for final measurements.

An extension cord was used to connect to a single LISN which powered by EUT. The extension cord was calibrated with LISN, the impedance and insertion loss are compliance with the requirements as stated in ANSI C63.10-2013.

3.3. Radiated Emissions

The radiated test facilities consisted of an indoor 3 meter semi-anechoic chamber used for final measurements and exploratory measurements, when necessary. The measurement area is contained within the semi-anechoic chamber which is shielded from any ambient interference. For measurements above 1GHz absorbers are arranged on the floor between the turn table and the Antenna mast in such a way so as to maximize the reduction of reflections. For measurements below 1GHz, the absorbers are removed. A MF Model 210SS turntable is used for radiated measurement. It is a continuously rotatable, remote controlled, metallic turntable and 2 meters (6.56 ft.) in diameter. The turn table is flush with the raised floor of the chamber in order to maintain its function as a ground plane. An 80cm high PVC support structure is placed on top of the turntable. For all measurements, the spectrum was scanned through all EUT azimuths and from 1 to 4 meter receive Antenna height using a broadband Antenna from 30MHz up to the upper frequency shown in 15.33(b)(1) depending on the highest frequency generated or used in the device or on which the device operates or tunes. For frequencies above 1GHz, linearly polarized double ridge horn Antennas were used. For frequencies below 30MHz, a calibrated loop Antenna was used. When exploratory measurements were necessary, they were performed at 1 meter test distance inside the semi-anechoic chamber using broadband Antennas, broadband amplifiers, and spectrum analyzers to determine the frequencies and modes producing the maximum emissions. Sufficient time for the EUT, support equipment, and test equipment was allowed in order for them to warm up to their normal operating condition. The test set-up for frequencies below 1GHz was placed on top of the 0.8 meter high, 1 x 1.5 meter table; and test set-up for frequencies 1-40GHz was placed on top of the 1.5 meter high, 1 x 1.5 meter table. The EUT, support equipment, and interconnecting cables were arranged and manipulated to maximize each emission. Appropriate precaution was taken to ensure that all emissions from the EUT were maximized and investigated. The system configuration, clock speed, mode of operation or video resolution, if applicable, turntable azimuth, and receive Antenna height was noted for each frequency found.

Final measurements were made in the semi-anechoic chamber using calibrated, linearly polarized broadband and horn Antennas. The test setup was configured to the setup that produced the worst case emissions. The spectrum analyzer was set to investigate all frequencies required for testing to compare the highest radiated disturbances with respect to the specified limits. The turntable containing the EUT was rotated through 360 degrees and the height of the receive Antenna was varied 1 to 4 meters and stopped at the azimuth and height producing the maximum emission. Each emission was maximized by changing the orientation of the EUT through three orthogonal planes and changing the polarity of the receive Antenna, whichever produced the worst-case emissions. According to 3dB Beam-Width of horn Antenna, the horn Antenna should be always directed to the EUT when rising height.

4. ANTENNA REQUIREMENTS

Excerpt from §15.203 of the FCC Rules/Regulations:

“An intentional radiator antenna shall be designed to ensure that no antenna other than that furnished by the responsible party can be used with the device. The use of a permanently attached antenna or of an antenna that uses a unique coupling to the intentional radiator shall be considered sufficient to comply with the provisions of this section.”

- The antenna of the device is **permanently attached**.
- There are no provisions for connection to an external antenna.

Conclusion:

The unit complies with the requirement of §15.203.

5. TEST EQUIPMENT CALIBRATION DATE

Conducted Emissions -SR2

Instrument	Manufacturer	Type No.	Asset No.	Cali. Interval	Cali. Due Date
Two-Line V-Network	R&S	ENV 216	MRTTWA00019	1 year	2022/3/23
Two-Line V-Network	R&S	ENV 216	MRTTWA00020	1 year	2022/4/24
8-Wire ISN (T8)	R&S	ENY81	MRTTWA00018	1 year	2022/5/30
EMI Test Receiver	R&S	ESR3	MRTTWA00045	1 year	2022/5/25
Temperature/Humidity Meter	TFA	35.1083	MRTTWA00050	1 year	2022/6/3

Radiated Emissions – AC1/AC2

Instrument	Manufacturer	Type No.	Asset No.	Cali. Interval	Cali. Due Date
Active Loop Antenna	SCHWARZBECK	FMZB 1519B	MRTTWA00002	1 year	2022/4/27
Broadband TRILOG Antenna	SCHWARZBECK	VULB 9162	MRTTWA00001	1 year	2022/10/4
Broadband Horn Antenna	SCHWARZBECK	BBHA 9120D	MRTTWA00003	1 year	2022/4/24
Broadband Horn Antenna	RFSPIN	DRH18-E	MRTTWA00087	1 year	2022/6/28
Broadband Horn Antenna	SCHWARZBECK	BBHA 9170	MRTTWA00004	1 year	2022/4/24
Broadband Preamplifier	SCHWARZBECK	BBV 9718	MRTTWA00005	1 year	2022/4/24
Broadband Preamplifier	EMC Instruments corporation	EMC118A45S E	MRTTWA00088	1 year	2022/6/28
Broadband Amplifier	SCHWARZBECK	BBV 9721	MRTTWA00006	1 year	2022/4/24
Signal Analyzer	R&S	FSV40	MRTTWA00007	1 year	2022/3/23
EMI Test Receiver	R&S	ESR3	MRTTWA00009	1 year	2022/3/24
EXA Signal Analyzer	KEYSIGHT	N9010A	MRTTWA00012	1 year	2022/10/18
Antenna Cable	HUBERSUHNER	SF106	MRTTWE00010	1 year	2022/6/28
Cable	Rosnol	K1K50-UP026 4-K1K50-4M	MRTTWE00012	1 year	2022/6/20
Antenna Cable	HUBERSUHNER	SF106	MRTTWE00034	1 year	2022/6/28
Cable	HUBERSUHNER	EMC105-NM- NM-3000	MRTTWE00035	1 year	2022/6/28
Temperature/Humidity Meter	TFA	35.1078.10.IT	MRTTWA00032	1 year	2022/6/6

Conducted Test Equipment – SR2

Instrument	Manufacturer	Type No.	Asset No.	Cali. Interval	Cali. Due Date
X-Series USB Peak and Average Power Sensor	KEYSIGHT	U2021XA	MRTTWA00014	1 year	2022/4/21
EXA Signal Analyzer	KEYSIGHT	N9010A	MRTTWA00012	1 year	2022/10/18
EXA Signal Analyzer	KEYSIGHT	N9010B	MRTTWA00074	1 year	2022/7/19
Attenuator	WTI	218FS-20	MRTTWE00027	1 year	2022/6/16
Attenuator	WTI	218FS-10	MRTTWE00028	1 year	2022/6/16
Attenuator	WTI	218FS-06	MRTTWE00029	1 year	2022/6/16
Temperature/Humidity Meter	TFA	35.1083	MRTTWA00050	1 year	2022/6/3

Test Software

Software	Version	Function
e3	9.160520a	EMI Test Software

6. MEASUREMENT UNCERTAINTY

Where relevant, the following test uncertainty levels have been estimated for tests performed on the EUT as specified in CISPR 16-4-2. This uncertainty represents an expanded uncertainty expressed at approximately the 95% confidence level using a coverage factor of $k = 2$.

AC Conducted Emission Measurement
Measuring Uncertainty for a Level of Confidence of 95% ($U=2Uc(y)$): 150kHz~30MHz: 2.53dB
Radiated Emission Measurement
Measuring Uncertainty for a Level of Confidence of 95% ($U=2Uc(y)$): 9kHz ~ 1GHz: 4.25dB 1GHz ~ 40GHz: 4.45dB
Conducted Power
Measuring Uncertainty for a Level of Confidence of 95% ($U=2Uc(y)$): ± 0.84 dB
Conducted Spurious Emission
Measuring Uncertainty for a Level of Confidence of 95% ($U=2Uc(y)$): ± 2.65 dB
Occupied Bandwidth
Measuring Uncertainty for a Level of Confidence of 95% ($U=2Uc(y)$): 3.3%
Temp. / Humidity
Measuring Uncertainty for a Level of Confidence of 95% ($U=2Uc(y)$): $\pm 0.82^{\circ}\text{C} / \pm 3\%$

7. TEST RESULT

7.1. Summary

FCC Part Section(s)	Test Description	Test Limit	Test Condition	Test Result	Reference
15.247(a)(2)	6dB Bandwidth	$\geq 500\text{kHz}$	Conducted	Pass	Section 7.2
15.247(b)(3)	Output Power	$\leq 1\text{Watt}$		Pass	Section 7.3
15.247(e)	Power Spectral Density	$\leq 8\text{dBm} / 3\text{kHz}$		Pass	Section 7.4
15.247(d)	Band Edge / Out-of-Band Emissions	$\geq 20\text{dBc (Peak)}$		Pass	Section 7.5
15.205 15.209	General Field Strength (Restricted Bands and Radiated Emission)	Emissions in restricted bands must meet the radiated limits detailed in 15.209	Radiated	Pass	Section 7.6 & 7.7
15.207	AC Conducted Emissions 150kHz - 30MHz	< FCC 15.207 limits	Line Conducted	Pass	Section 7.8

Notes:

- The analyzer plots shown in this section were all taken with a correction table loaded into the analyzer. The correction table was used to account for the losses of the cables and attenuators used as part of the system to connect the EUT to the analyzer at all frequencies of interest.
- All modes of operation and data rates were investigated. For radiated emission test, every axis (X, Y, Z) was also verified. The test results shown in the following sections represent the worst case emissions.
- Determining compliance is based on the test results met the regulation limits or requirements declared by clients, and the test results don't take into account the value of measurement uncertainty.

Test Items	Filter 4#	Filter 5#	Filter 6#
6dB Bandwidth	•		
Output Power	•	•	•
Power Spectral Density	•		
Band Edge / Out-of-Band Emissions	•	•	•
Radiated Spurious Emission	•	•	•
Radiated Band Edge	•	•	•
AC Conducted Emissions 150kHz - 30MHz	•		

7.2. 6dB Bandwidth Measurement

7.2.1. Test Limit

The minimum 6dB bandwidth shall be at least 500 kHz.

7.2.2. Test Procedure used

ANSI C63.10-2013 Section 11.8

7.2.3. Test Setting

1. The Spectrum's automatic bandwidth measurement capability was used to perform the 6dB bandwidth measurement. The "X" dB bandwidth parameter was set to $X = 6$. The bandwidth measurement was not influenced by any intermediate power nulls in the fundamental emission.
2. Set RBW = 100 kHz
3. $VBW \geq 3 \times RBW$
4. Detector = Peak
5. Trace mode = max hold
6. Sweep = auto couple
7. Allow the trace was allowed to stabilize

7.2.4. Test Setup

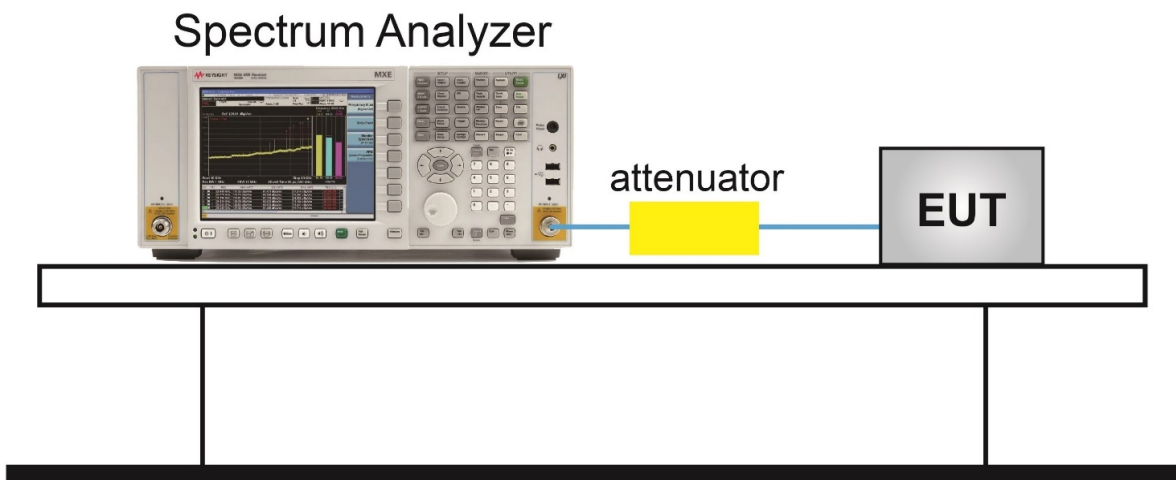

7.2.5. Test Result

Product	ACCESS POINT	Test Engineer	Eric Lin
Test Site	SR2	Test Date	2021/10/12

Test Mode	Data Rate (Mbps)	Channel No.	Frequency (MHz)	6dB Bandwidth (MHz)	Limit (MHz)	Result
BLE	1	00	2402	0.7237	≥ 0.5	Pass
BLE	1	19	2440	0.7207	≥ 0.5	Pass
BLE	1	39	2480	0.7266	≥ 0.5	Pass
BLE	2	00	2402	1.138	≥ 0.5	Pass
BLE	2	19	2440	1.141	≥ 0.5	Pass
BLE	2	39	2480	1.140	≥ 0.5	Pass

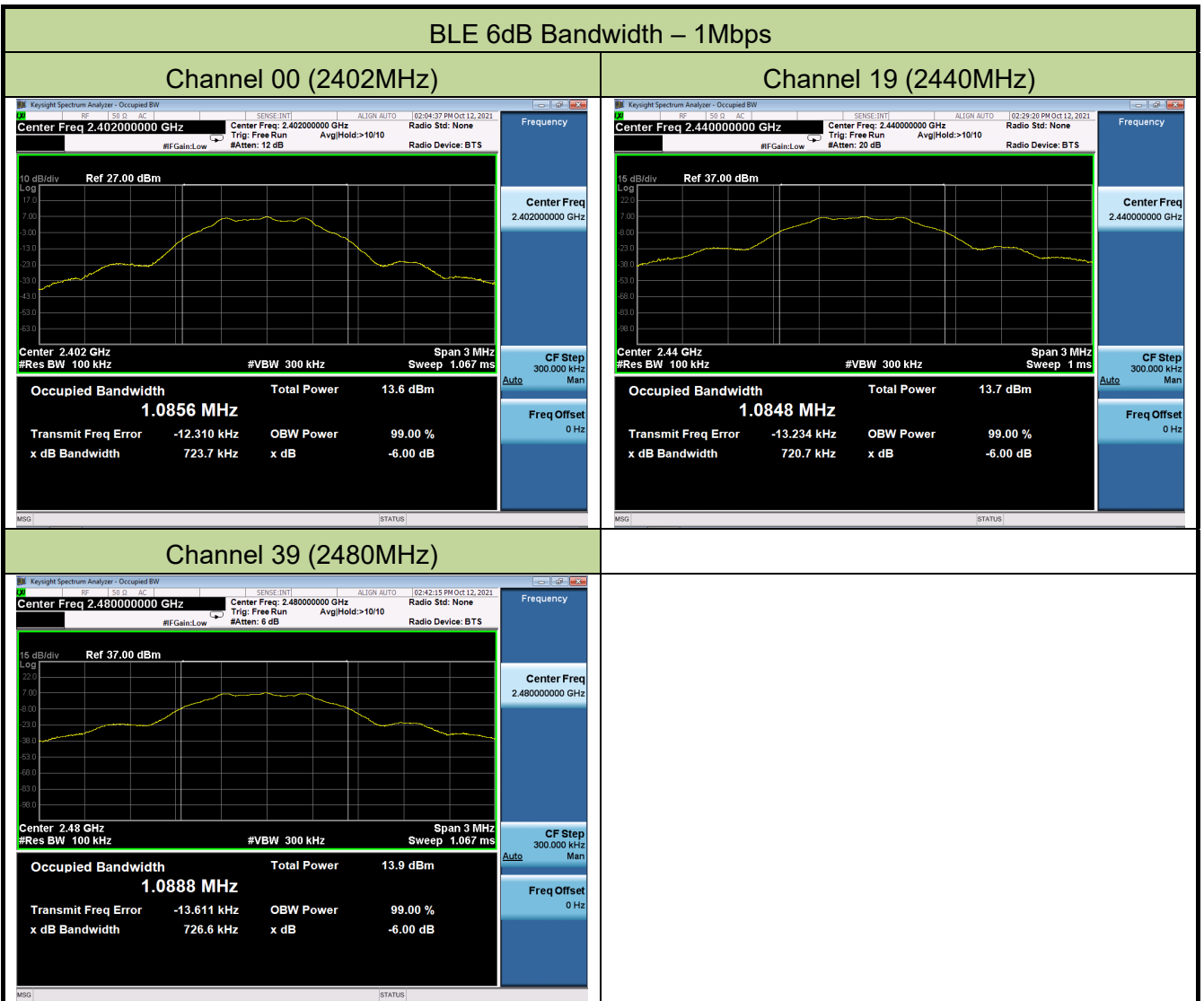

BLE 6dB Bandwidth – 2Mbps

Channel 00 (2402MHz)

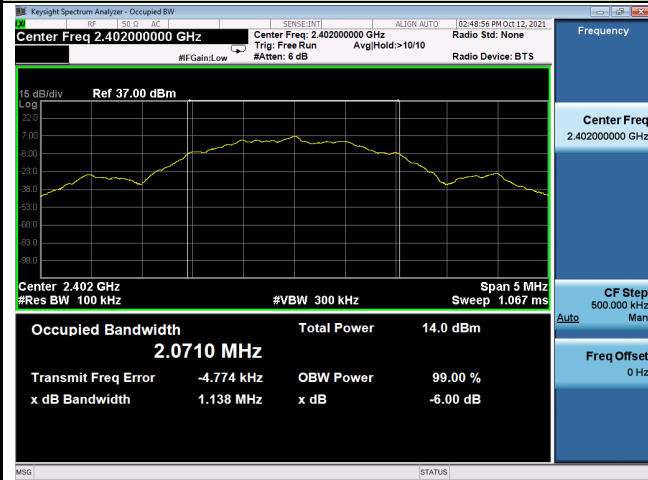

Channel 19 (2440MHz)

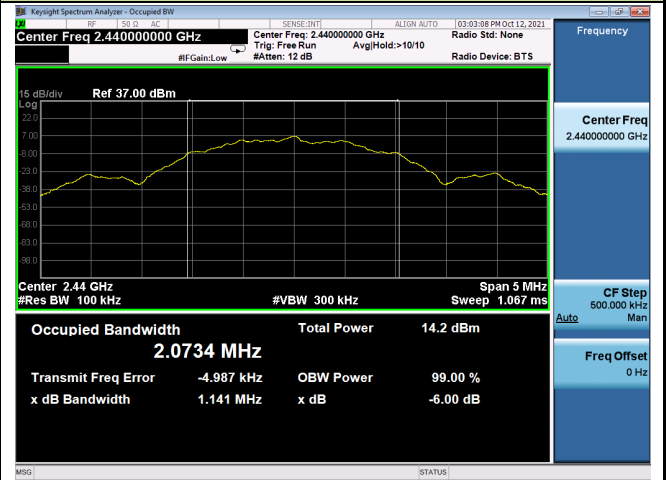

Channel 39 (2480MHz)



7.3. Output Power Measurement

7.3.1. Test Limit

The maximum out power shall be less 1 Watt (30dBm).

The conducted output power limit specified in paragraph FCC Part 15.247(b) of this section is based on the use of antennas with directional gains that do not exceed 6 dBi. If transmitting antennas of directional gain greater than 6 dBi are used, the conducted output power from the intentional radiator shall be reduced below the stated values in paragraphs FCC Part 15.247(b)(3) of this section, as appropriate, by the amount in dB that the directional gain of the antenna exceeds 6 dBi.

7.3.2. Test Procedure Used

ANSI C63.10-2013 Section 11.9.1.3

ANSI C63.10-2013 Section 11.9.2.3

7.3.3. Test Setting

Method PKPM1 (Peak Power Measurement of Signals with DTS BW \leq 50MHz)

Peak power measurements were performed only when the EUT was transmitting at its maximum power control level using a broadband power meter with a pulse sensor. The pulse sensor employs a VBW = 50MHz so this method was only used for signals whose DTS bandwidth was less than or equal to 50MHz.

Average Power Measurement

Average power measurements were performed only when the EUT was transmitting at its maximum power control level using a broadband power meter with a pulse sensor. The power meter implemented triggering and gating capabilities which were set up such that power measurements were recorded only during the ON time of the transmitter.

7.3.4. Test Setup

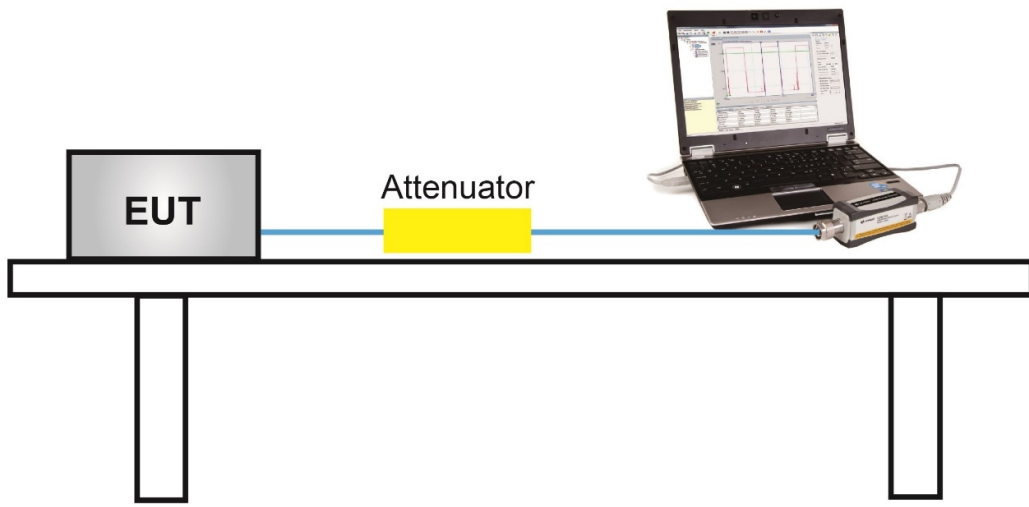

7.3.5. Test Result

Product	ACCESS POINT	Test Engineer	Eric Lin
Test Site	SR2	Test Date	2021/09/28
Filter Configuration	Filter 4#		

Test Result of Peak Output Power

Test Mode	Data Rate (Mbps)	Channel No.	Frequency (MHz)	Peak Power (dBm)	Limit (dBm)	Result
BLE	1	00	2402	7.05	≤ 30.00	Pass
BLE	1	19	2440	7.16	≤ 30.00	Pass
BLE	1	39	2480	7.27	≤ 30.00	Pass
BLE	2	00	2402	7.03	≤ 30.00	Pass
BLE	2	19	2440	7.13	≤ 30.00	Pass
BLE	2	39	2480	7.25	≤ 30.00	Pass

Test Result of Average Output Power (Reporting Only)

Test Mode	Data Rate (Mbps)	Channel No.	Frequency (MHz)	Average Power (dBm)	Limit (dBm)	Result
BLE	1	00	2402	6.76	≤ 30.00	Pass
BLE	1	19	2440	6.89	≤ 30.00	Pass
BLE	1	39	2480	6.94	≤ 30.00	Pass
BLE	2	00	2402	6.70	≤ 30.00	Pass
BLE	2	19	2440	6.83	≤ 30.00	Pass
BLE	2	39	2480	7.00	≤ 30.00	Pass

Product	ACCESS POINT	Test Engineer	Eric Lin
Test Site	SR2	Test Date	2021/09/28
Filter Configuration	Filter 5#		

Test Result of Peak Output Power

Test Mode	Data Rate (Mbps)	Channel No.	Frequency (MHz)	Peak Power (dBm)	Limit (dBm)	Result
BLE	1	00	2402	6.21	≤ 30.00	Pass
BLE	2	00	2402	6.17	≤ 30.00	Pass

Test Result of Average Output Power (Reporting Only)

Test Mode	Data Rate (Mbps)	Channel No.	Frequency (MHz)	Average Power (dBm)	Limit (dBm)	Result
BLE	1	00	2402	5.98	≤ 30.00	Pass
BLE	2	00	2402	5.92	≤ 30.00	Pass

Product	ACCESS POINT	Test Engineer	Eric Lin
Test Site	SR2	Test Date	2021/09/28
Filter Configuration	Filter 6#		

Test Result of Peak Output Power

Test Mode	Data Rate (Mbps)	Channel No.	Frequency (MHz)	Peak Power (dBm)	Limit (dBm)	Result
BLE	1	39	2480	4.82	≤ 30.00	Pass
BLE	2	39	2480	4.78	≤ 30.00	Pass

Test Result of Average Output Power (Reporting Only)

Test Mode	Data Rate (Mbps)	Channel No.	Frequency (MHz)	Average Power (dBm)	Limit (dBm)	Result
BLE	1	39	2480	4.48	≤ 30.00	Pass
BLE	2	39	2480	4.46	≤ 30.00	Pass

7.4. Power Spectral Density Measurement

7.4.1. Test Limit

The maximum permissible power spectral density is 8dBm in any 3 kHz band.

The same method of determining the conducted output power shall be used to determine the power spectral density.

7.4.2. Test Procedure Used

ANSI C63.10-2013 Section 11.10.2

7.4.3. Test Setting

1. Analyzer was set to the center frequency of the DTS channel under investigation
2. Span = 1.5 times the DTS channel bandwidth
3. RBW = 3kHz
4. VBW = 10kHz
5. Detector = peak
6. Sweep time = auto couple
7. Trace mode = max hold
8. Trace was allowed to stabilize

7.4.4. Test Setup

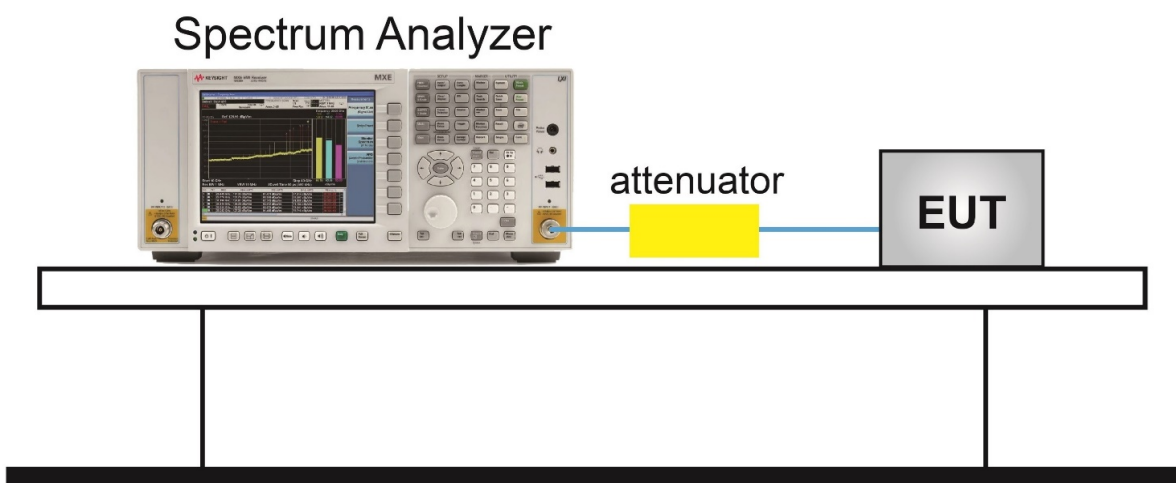

7.4.5. Test Result

Product	ACCESS POINT	Test Engineer	Eric Lin
Test Site	SR2	Test Date	2021/09/28 ~ 2021/10/12

Test Mode	Data Rate (Mbps)	Channel No.	Frequency (MHz)	PSD Result (dBm / 3kHz)	Limit (dBm / 3kHz)	Result
BLE	1	00	2402	-8.59	≤ 8.00	Pass
BLE	1	19	2440	-8.57	≤ 8.00	Pass
BLE	1	39	2480	-8.24	≤ 8.00	Pass
BLE	2	00	2402	-11.13	≤ 8.00	Pass
BLE	2	19	2440	-11.16	≤ 8.00	Pass
BLE	2	39	2480	-10.81	≤ 8.00	Pass

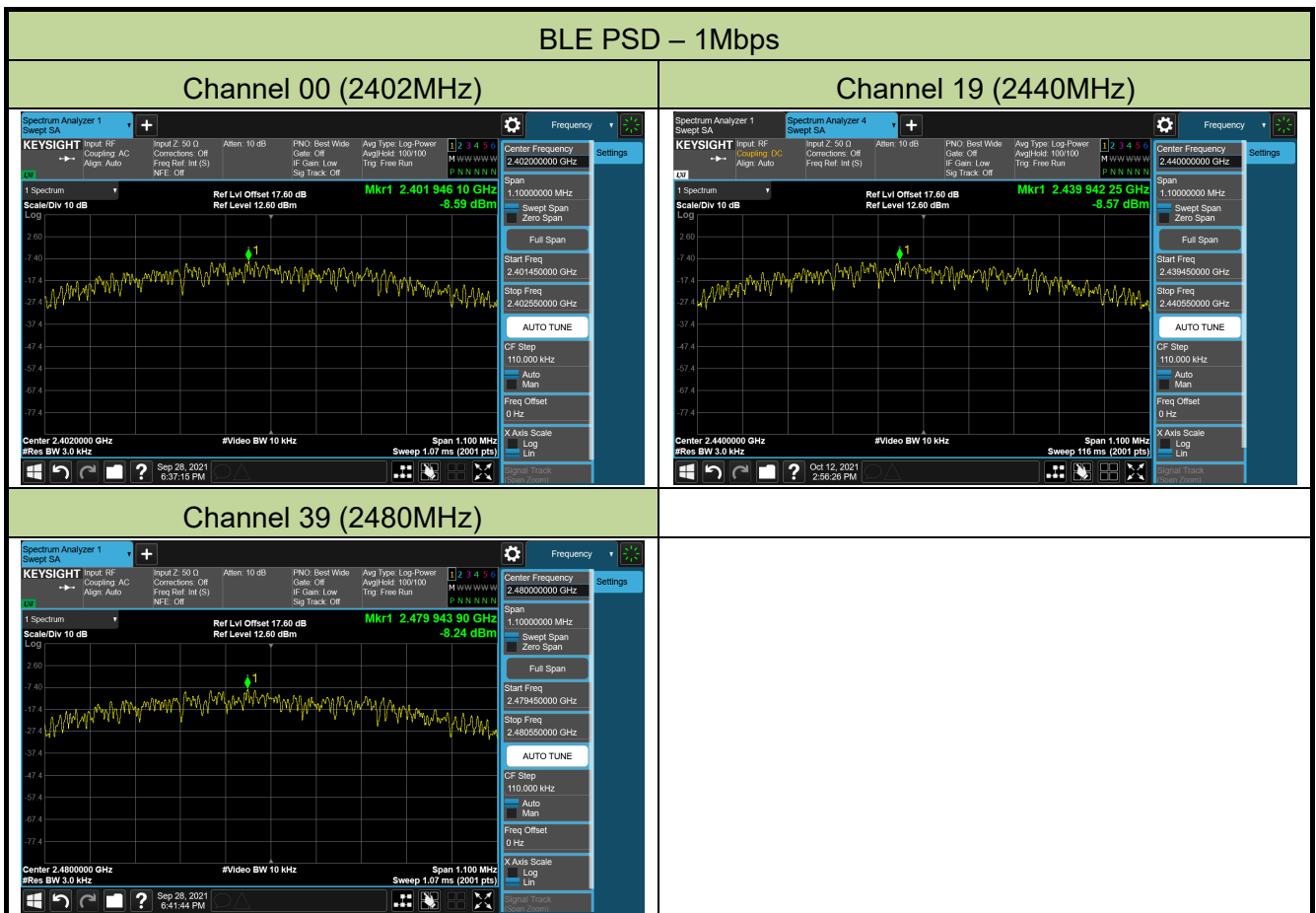

BLE PSD – 2Mbps

Channel 00 (2402MHz)

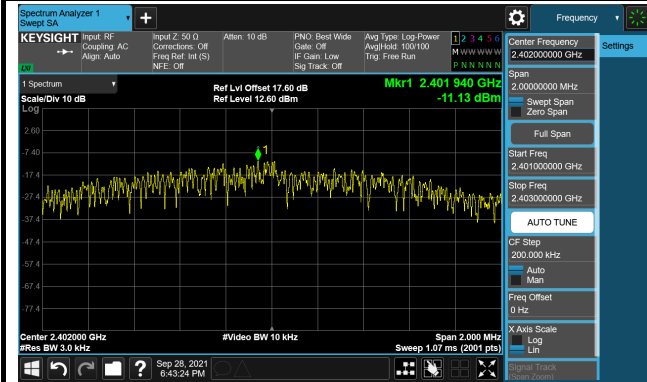

Channel 19 (2440MHz)

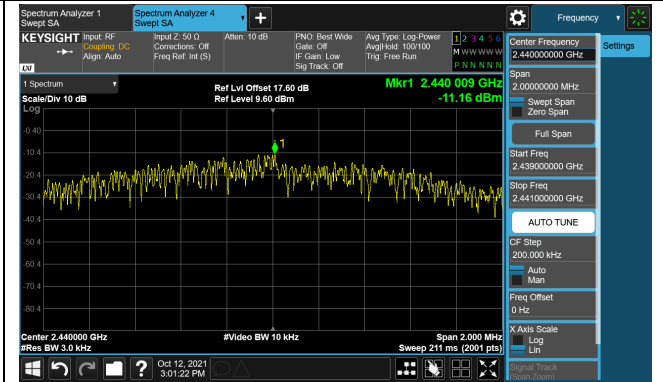

Channel 39 (2480MHz)

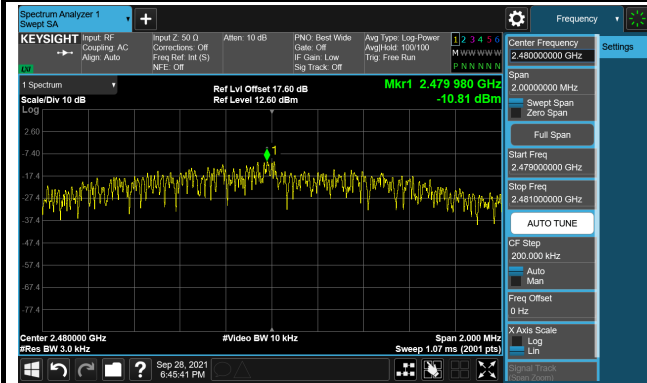

7.5. Conducted Band Edge and Out-of-Band Emissions

7.5.1. Test Limit

The limit for out-of-band spurious emissions at the band edge is 20dB below the fundamental emission level, as determined from the in-band power measurement of the DTS channel performed in a 100kHz bandwidth per the PSD procedure.

7.5.2. Test Procedure Used

ANSI C63.10-2013 Section 11.11

7.5.3. Test Setting

1. Reference level measurement

- a) Set instrument center frequency to DTS channel center frequency
- b) Set the span to ≥ 1.5 times the DTS bandwidth
- c) Set the RBW = 100 kHz
- d) Set the VBW $\geq 3 \times$ RBW
- e) Detector = peak
- f) Sweep time = auto couple
- g) Trace mode = max hold
- h) Allow trace to fully stabilize

2. Emission level measurement

- a) Start frequency was set to 30MHz and stop frequency was set to 25GHz (separated into two plots per channel)
- b) RBW = 100kHz
- c) VBW = 300kHz
- d) Detector = Peak
- e) Trace mode = max hold
- f) Sweep time = auto couple
- g) The trace was allowed to stabilize

7.5.4. Test Setup

Spectrum Analyzer

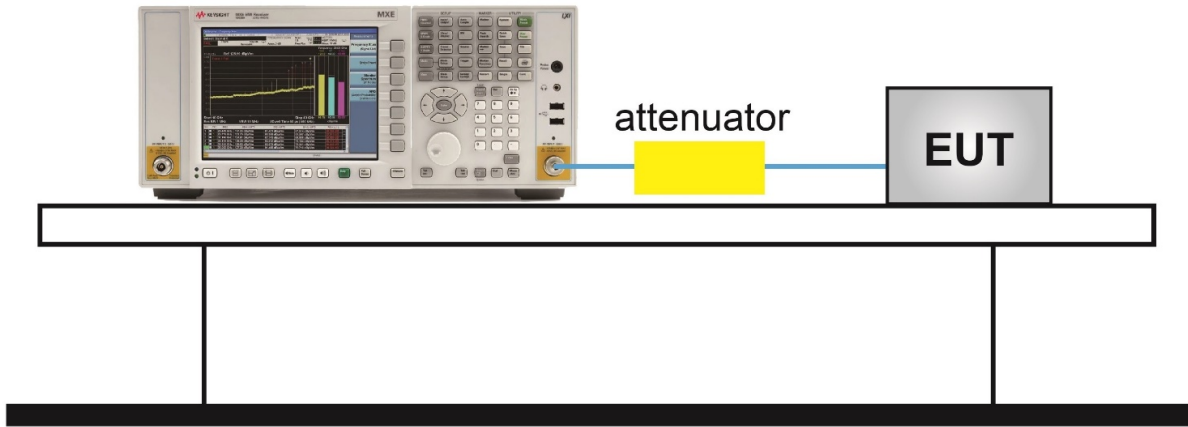

7.5.5. Test Result

Product	ACCESS POINT	Test Engineer	Eric Lin
Test Site	SR2	Test Date	2022/01/23
Filter Configuration	Filter 4#		

Test Mode	Data Rate (Mbps)	Channel No.	Frequency (MHz)	Limit	Result
BLE	1	00	2402	20dBc	Pass
BLE	1	19	2440	20dBc	Pass
BLE	1	39	2480	20dBc	Pass
BLE	2	00	2402	20dBc	Pass
BLE	2	19	2440	20dBc	Pass
BLE	2	39	2480	20dBc	Pass

BLE Out-of-Band Emissions – 1Mbps

Channel 00 (2402MHz)

100kHz PSD reference Level

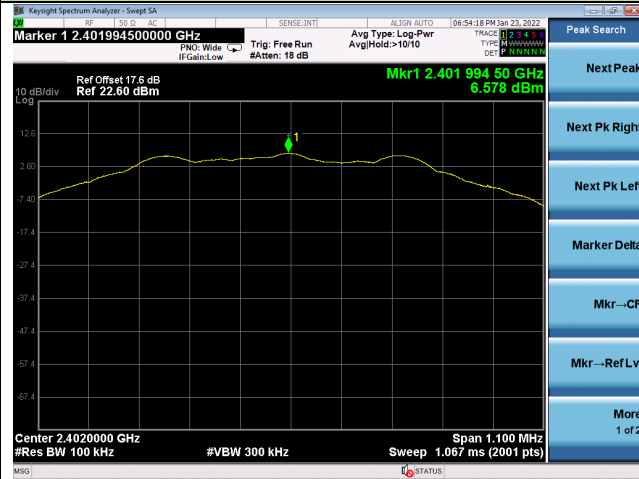

Low Band Edge

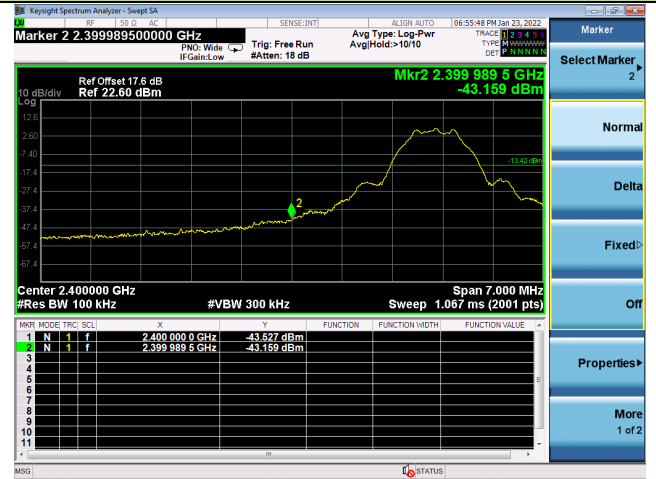

Spurious Emission 30MHz ~ 25GHz

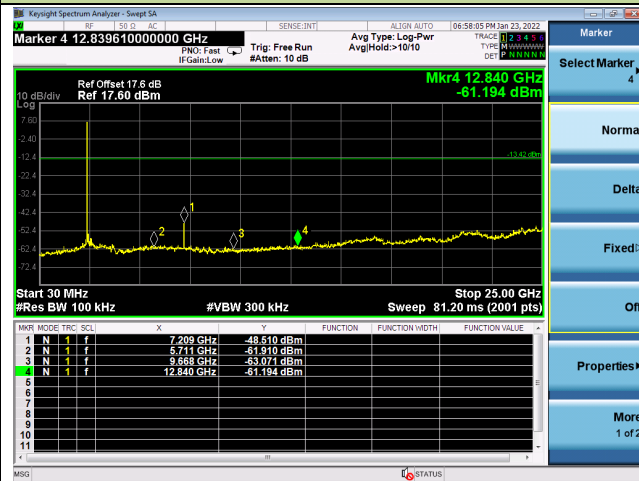

Channel 19 (2440MHz)

100kHz PSD reference Level

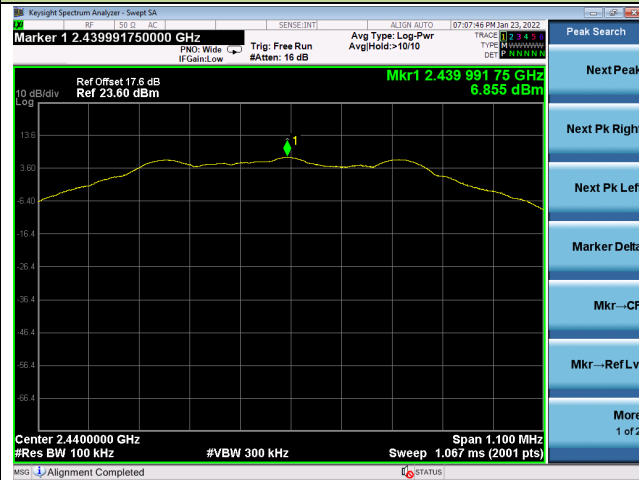

Spurious Emission 30MHz ~ 25GHz

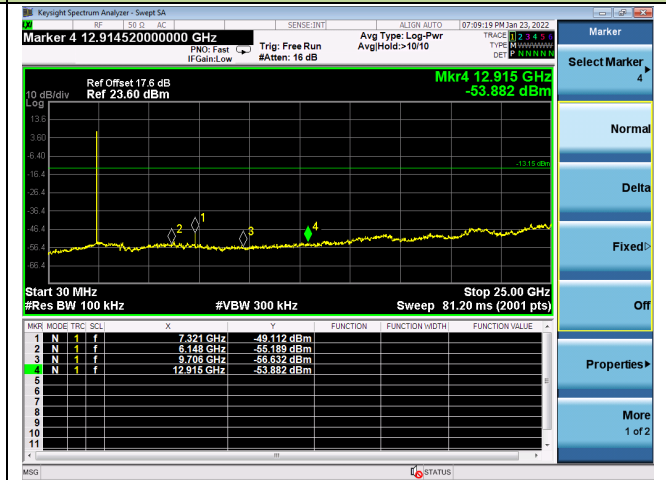

Channel 39 (2480MHz)

100kHz PSD reference Level

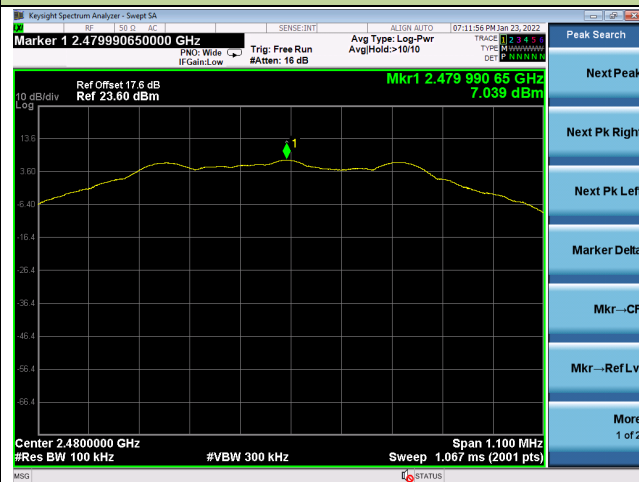

High Band Edge

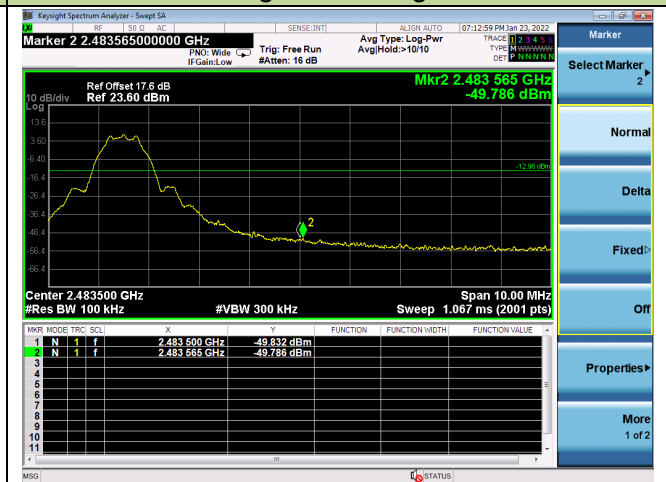

Spurious Emission 30MHz ~ 25GHz

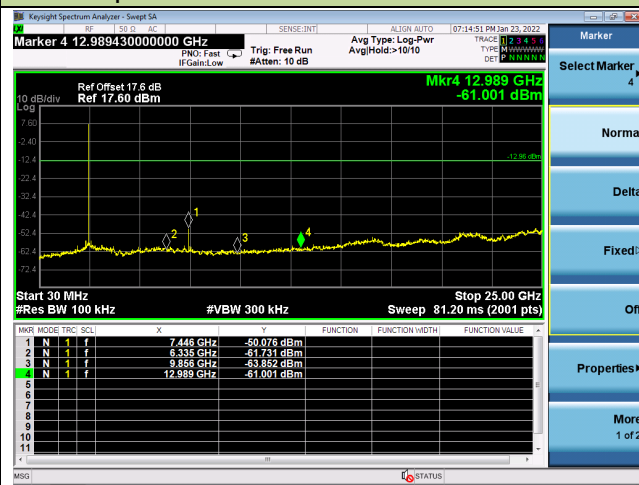

BLE Out-of-Band Emissions – 2Mbps

Channel 00 (2402MHz)

100kHz PSD reference Level

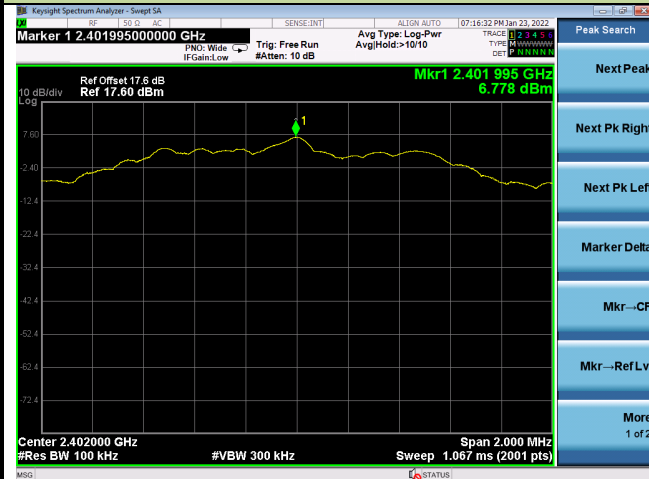

Low Band Edge

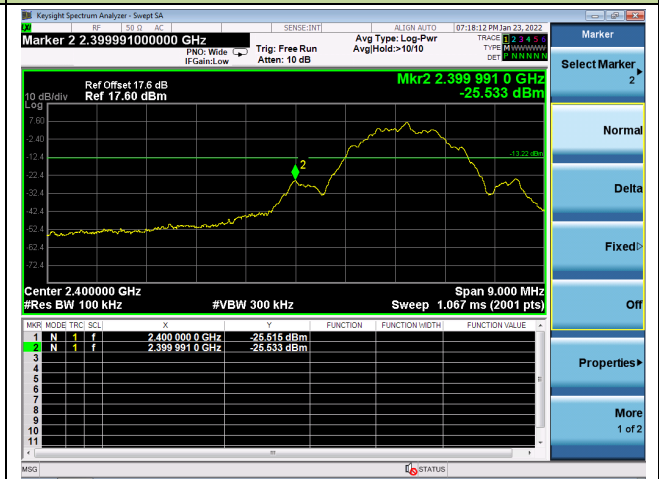

Spurious Emission 30MHz ~ 25GHz

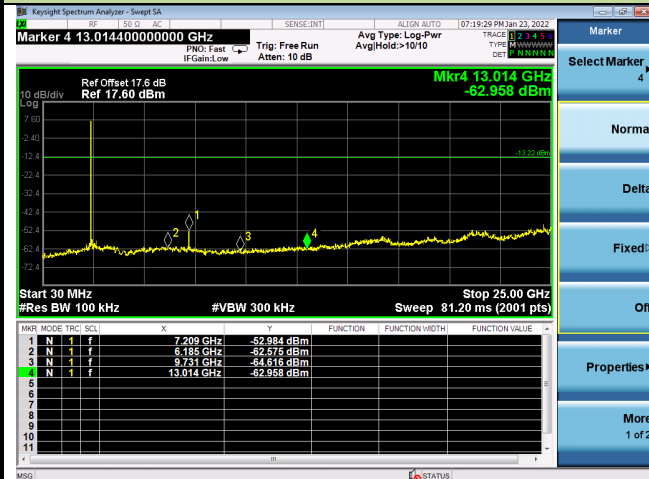

Channel 19 (2440MHz)

100kHz PSD reference Level

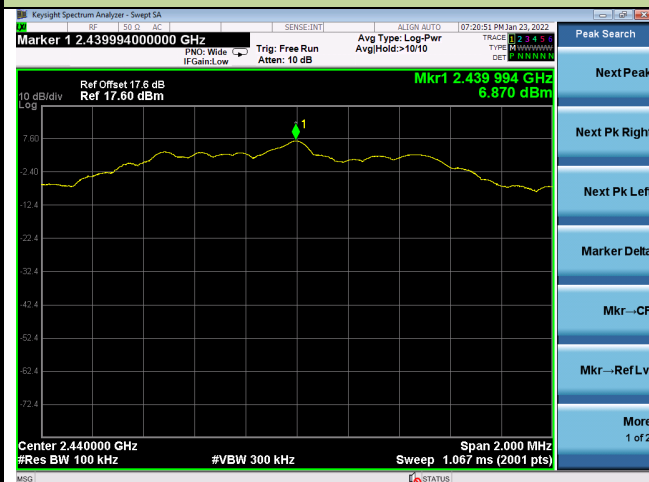

Spurious Emission 30MHz ~ 25GHz

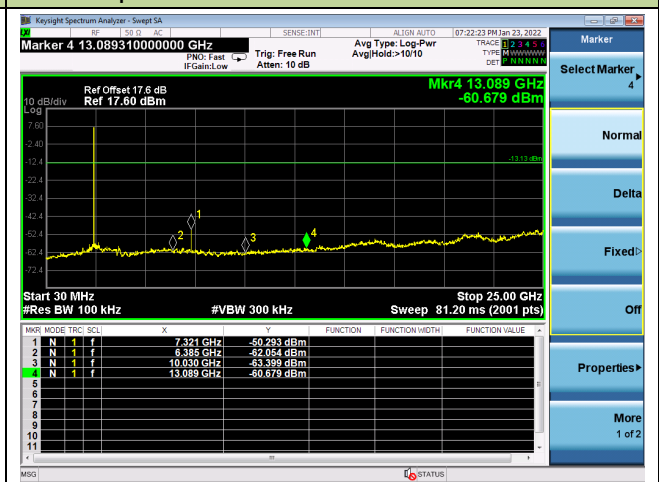

Channel 39 (2480MHz)

100kHz PSD reference Level

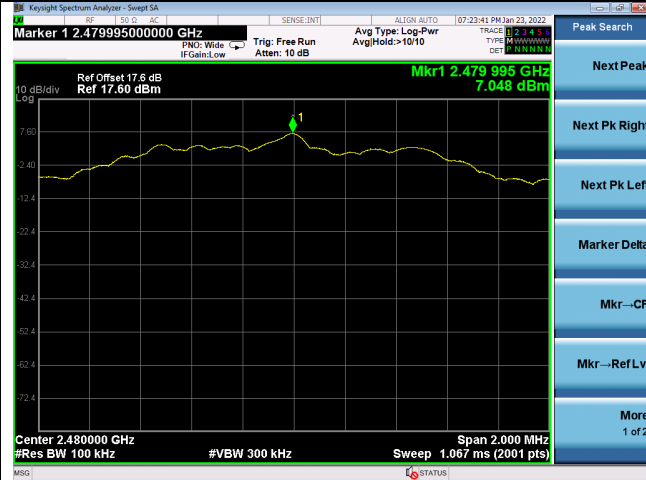

High Band Edge

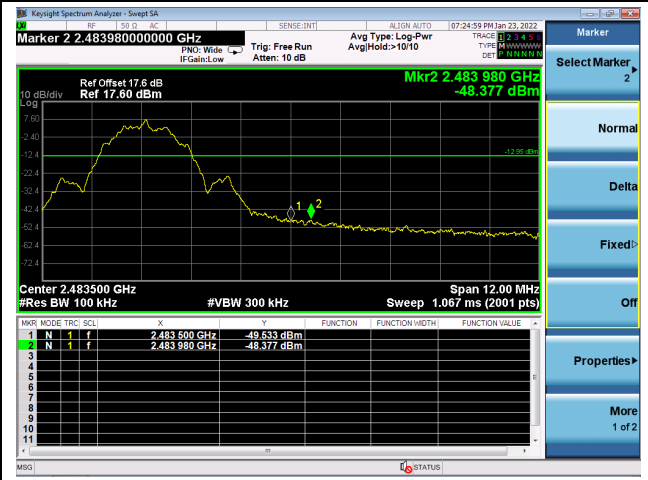

Spurious Emission 30MHz ~ 25GHz

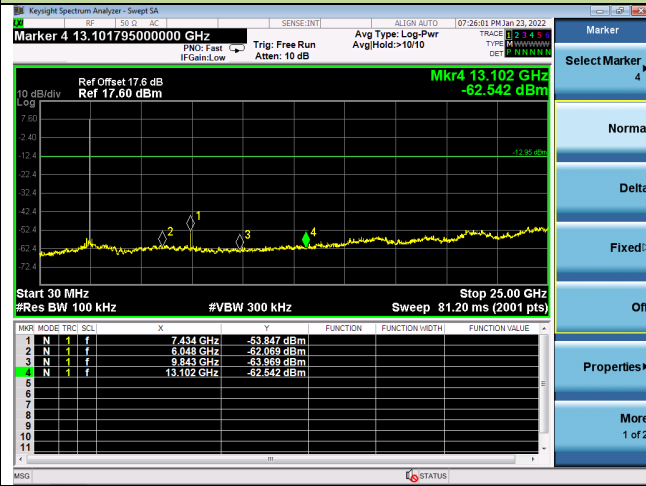

Product	ACCESS POINT	Test Engineer	Eric Lin
Test Site	SR2	Test Date	2022/01/24
Filter Configuration	Filter 5#		

Test Mode	Data Rate (Mbps)	Channel No.	Frequency (MHz)	Limit	Result
BLE	2	00	2402	20dBc	Pass

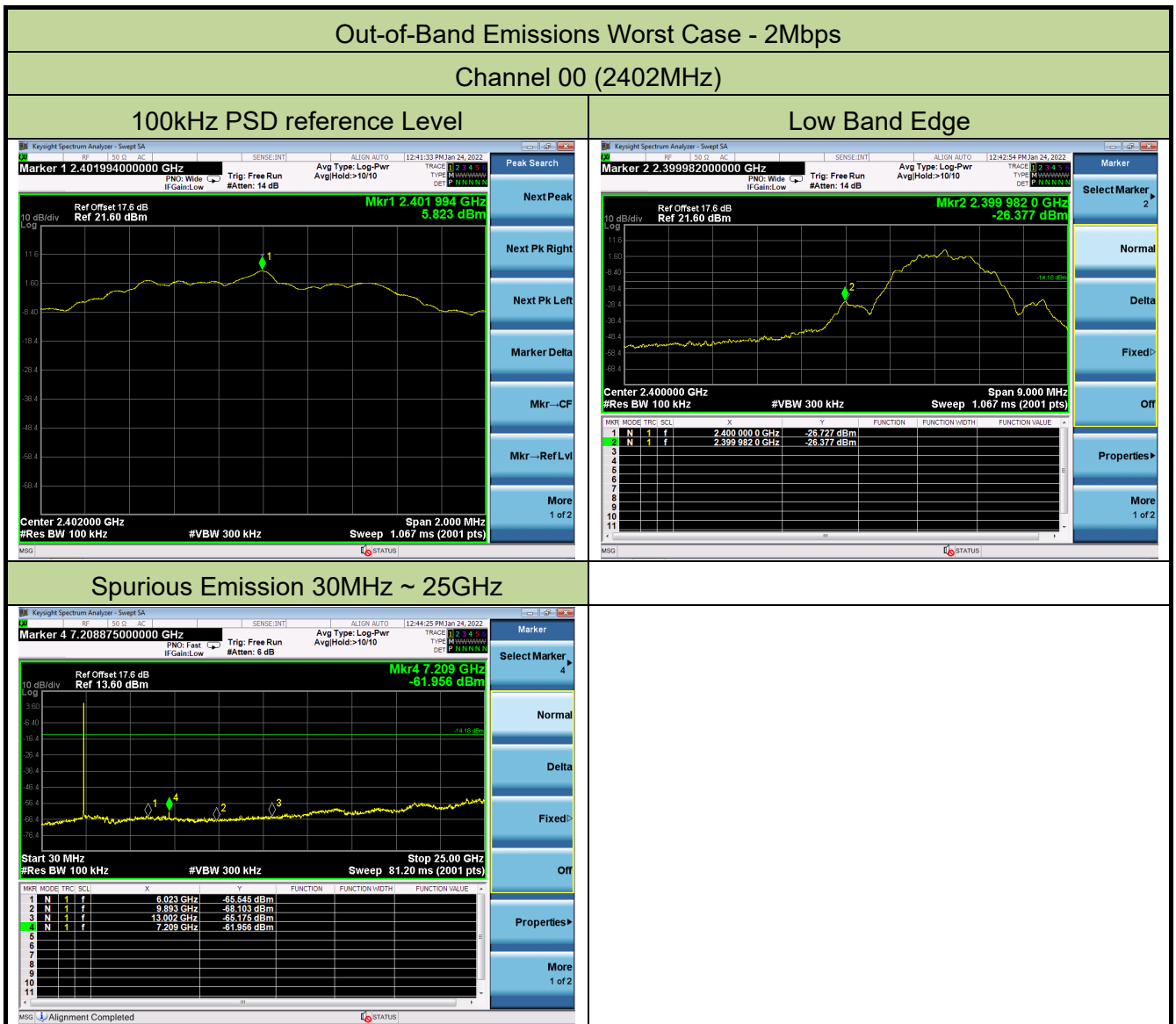

Product	ACCESS POINT	Test Engineer	Eric Lin
Test Site	SR2	Test Date	2022/01/24
Filter Configuration	Filter 6#		

Test Mode	Data Rate (Mbps)	Channel No.	Frequency (MHz)	Limit	Result
BLE	2	39	2480	20dBc	Pass

Out-of-Band Emissions Worst Case - 2Mbps

Channel 39 (2480MHz)

100kHz PSD reference Level

Center 2.480000 GHz
#Res BW 100 kHz #VBW 300 kHz Sweep 1.067 ms (2001 pts)

Low Band Edge

Center 2.483500 GHz
#Res BW 100 kHz #VBW 300 kHz Sweep 1.067 ms (2001 pts)

MKR	MODE	TRC	SCL	X	Y	FUNCTION	FUNCTION WIDTH	FUNCTION VALUE
1	N	1	f	2.483500 GHz	-51.249 dBm			
2	N	1	f	2.483698 GHz	-48.717 dBm			

Spurious Emission 30MHz ~ 25GHz

Start 30 MHz
#Res BW 100 kHz #VBW 300 kHz Sweep 81.20 ms (2001 pts)

MKR	MODE	TRC	SCL	X	Y	FUNCTION	FUNCTION WIDTH	FUNCTION VALUE
1	N	1	f	7.446 GHz	-52.914 dBm			
2	N	1	f	8.210 GHz	-58.872 dBm			
3	N	1	f	9.831 GHz	-57.267 dBm			
4	N	1	f	12.877 GHz	-66.376 dBm			

7.6. Radiated Spurious Emission Measurement

7.6.1. Test Limit

All out of band emissions appearing in a restricted band as specified in Section 15.205 of the Title 47 CFR must not exceed the limits shown in Table per Section 15.209.

FCC Part 15 Subpart C Paragraph 15.209		
Frequency [MHz]	Field Strength [uV/m]	Measured Distance [Meters]
0.009 - 0.490	2400/F (kHz)	300
0.490 - 1.705	24000/F (kHz)	30
1.705 - 30	30	30
30 - 88	100	3
88 - 216	150	3
216 - 960	200	3
Above 960	500	3

7.6.2. Test Procedure Used

ANSI C63.10-2013 Section 6.3 (General Requirements)

ANSI C63.10-2013 Section 6.4 (Standard test method below 30MHz)

ANSI C63.10-2013 Section 6.5 (Standard test method above 30MHz to 1GHz)

ANSI C63.10-2013 Section 6.6 (Standard test method above 1GHz)

ANSI C63.10-2013 Section 11.11 & 11.12

7.6.3. Test Setting

Table 1 - RBW as a function of frequency

Frequency	RBW
9 ~ 150 kHz	200 ~ 300 Hz
0.15 ~ 30 MHz	9 ~ 10 kHz
30 ~ 1000 MHz	100 ~ 120 kHz

Quasi-Peak Measurements below 1GHz

1. Analyzer center frequency was set to the frequency of the radiated spurious emission of interest
2. Span was set greater than 1MHz
3. RBW = as specified in Table 1
4. Detector = CISPR quasi-peak
5. Sweep time = auto couple
6. Trace was allowed to stabilize

Peak Measurements above 1GHz

1. Analyzer center frequency was set to the frequency of the radiated spurious emission of interest
2. RBW = 1MHz
3. VBW = 3MHz
4. Detector = peak
5. Sweep time = auto couple
6. Trace mode = max hold
7. Trace was allowed to stabilize

Average Measurements above 1GHz

1. Analyzer center frequency was set to the frequency of the radiated spurious emission of interest
2. RBW = 1MHz
3. VBW = $1 / T$, (For 1Mbps, VBW = 10kHz; For 2Mbps, VBW = 20kHz)
4. Average Type = Voltage
5. Detector = Peak
6. Sweep time = auto
7. Trace mode = max hold
8. Trace was allowed to stabilize

7.6.4. Test Setup

Below 1GHz Test Setup:

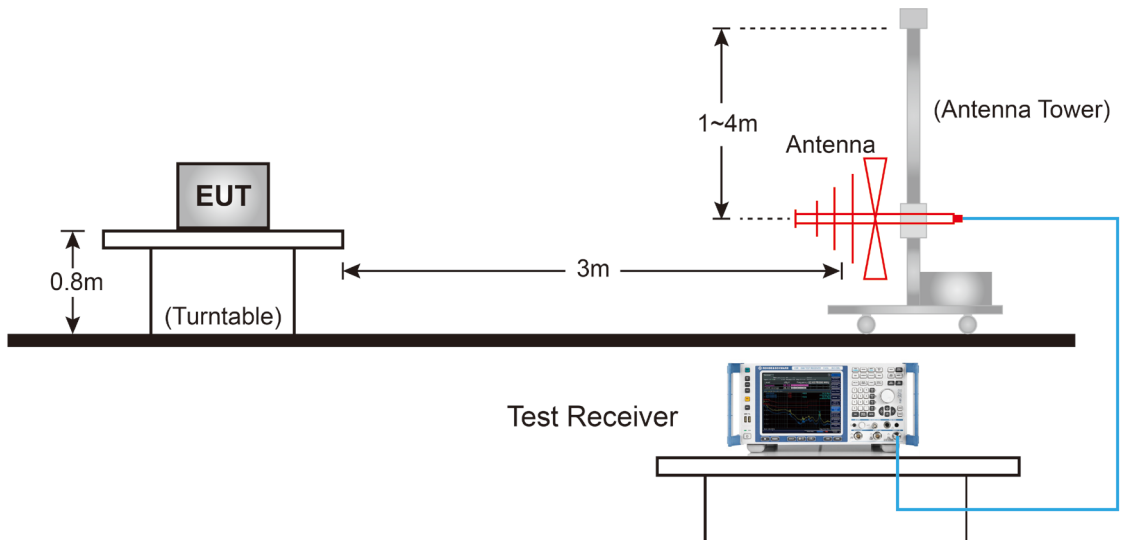

Above 1GHz Test Setup:

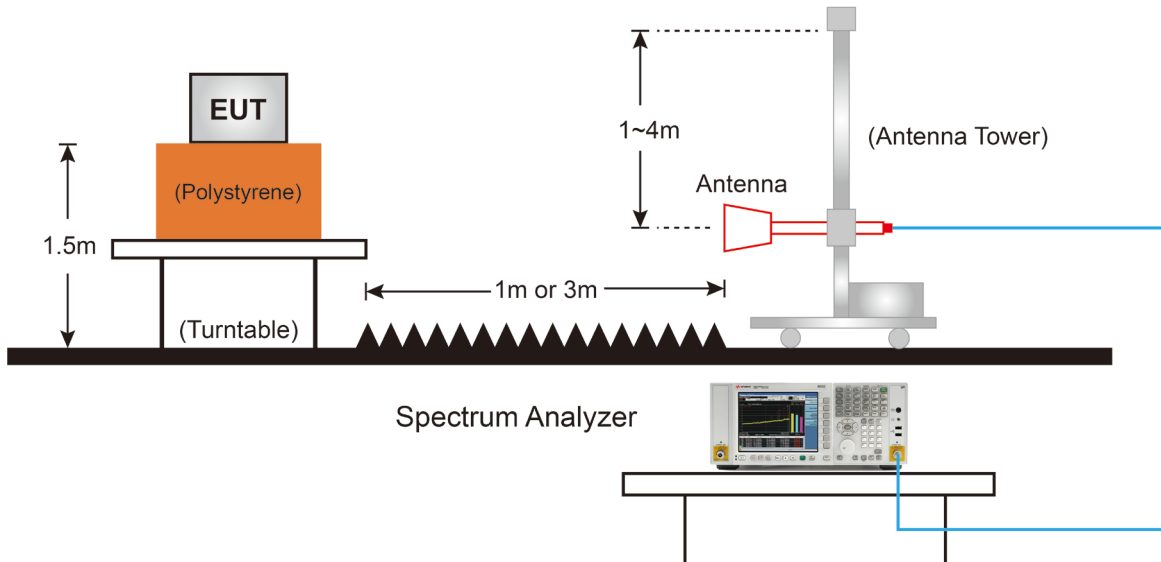

7.6.5. Test Result
Filter Configuration 4#

EUT	ACCESS POINT	Date of Test	2022-01-06
Factor	BBHA 9120D (1GHz~18GHz)_2021	Temp. / Humidity	25.1°C/44.6%
Polarity	Horizontal	Site / Test Engineer	AC1 / Jay Chu
Test Mode	Transmit by BLE 1M at Channel 2402MHz	Test Voltage	120V/60Hz

--

No	Frequency (MHz)	Reading (dBμV)	C.F (dB/m)	Measurement (dBμV/m)	Margin (dB)	Limit (dBμV/m)	Remark (QP/PK/AV)
1	7655.500	33.53	13.14	46.67	-27.33	74.00	Peak
2	9083.500	33.66	15.02	48.68	-25.32	74.00	Peak
3	* 10962.000	31.20	19.23	50.42	-23.58	74.00	Peak

Note:

1. " *", means this data is the worst emission level.
2. C.F (Correction Factor) = Antenna Factor (dB/m) + Cable Loss (dB) – Pre-amplifier(dB).
3. Measurement(dBμV/m) = Reading(dBμV) + C.F (Correction Factor).

EUT	ACCESS POINT	Date of Test	2022-01-06
Factor	BBHA 9120D (1GHz~18GHz)_2021	Temp. / Humidity	25.1°C/44.6%
Polarity	Vertical	Site / Test Engineer	AC1 / Jay Chu
Test Mode	Transmit by BLE 1M at Channel 2402MHz	Test Voltage	120V/60Hz

--	--	--	--	--	--	--	--

No	Frequency (MHz)	Reading (dBμV)	C.F (dB/m)	Measurement (dBμV/m)	Margin (dB)	Limit (dBμV/m)	Remark (QP/PK/AV)
1	7536.500	33.36	13.05	46.41	-27.59	74.00	Peak
2	9109.000	32.80	15.06	47.87	-26.13	74.00	Peak
3	* 12152.000	30.44	18.76	49.20	-24.80	74.00	Peak

Note:

1. " *", means this data is the worst emission level.
2. C.F (Correction Factor) = Antenna Factor (dB/m) + Cable Loss (dB) – Preamplifier(dB).
3. Measurement(dBμV/m) = Reading(dBμV) + C.F (Correction Factor).

EUT	ACCESS POINT	Date of Test	2022-01-06
Factor	BBHA 9120D (1GHz~18GHz)_2021	Temp. / Humidity	25.1°C/44.6%
Polarity	Horizontal	Site / Test Engineer	AC1 / Jay Chu
Test Mode	Transmit by BLE 1M at Channel 2440MHz	Test Voltage	120V/60Hz

(This area is intentionally left blank for test results or observations.)			
---	--	--	--

No	Frequency (MHz)	Reading (dBμV)	C.F (dB/m)	Measurement (dBμV/m)	Margin (dB)	Limit (dBμV/m)	Remark (QP/PK/AV)
1	4995.000	37.89	3.94	41.83	-32.17	74.00	Peak
2	7477.000	32.79	12.91	45.70	-28.30	74.00	Peak
3	* 10792.000	30.68	18.98	49.66	-24.34	74.00	Peak

Note:

1. " *", means this data is the worst emission level.
2. C.F (Correction Factor) = Antenna Factor (dB/m) + Cable Loss (dB) – Pre-amplifier(dB).
3. Measurement(dBμV/m) = Reading(dBμV) + C.F (Correction Factor).

EUT	ACCESS POINT	Date of Test	2022-01-06
Factor	BBHA 9120D (1GHz~18GHz)_2021	Temp. / Humidity	25.1°C/44.6%
Polarity	Vertical	Site / Test Engineer	AC1 / Jay Chu
Test Mode	Transmit by BLE 1M at Channel 2440MHz	Test Voltage	120V/60Hz

(This area is intentionally left blank for test results or observations.)			
---	--	--	--

No	Frequency (MHz)	Reading (dBμV)	C.F (dB/m)	Measurement (dBμV/m)	Margin (dB)	Limit (dBμV/m)	Remark (QP/PK/AV)
1	7417.500	33.08	12.65	45.73	-28.27	74.00	Peak
2	9083.500	32.41	15.02	47.43	-26.57	74.00	Peak
3	* 12560.000	30.77	18.58	49.35	-24.65	74.00	Peak

Note:

1. " *", means this data is the worst emission level.
2. C.F (Correction Factor) = Antenna Factor (dB/m) + Cable Loss (dB) – Preamplifier(dB).
3. Measurement(dBμV/m) = Reading(dBμV) + C.F (Correction Factor).

EUT	ACCESS POINT	Date of Test	2022-01-06
Factor	BBHA 9120D (1GHz~18GHz)_2021	Temp. / Humidity	25.1°C/44.6%
Polarity	Horizontal	Site / Test Engineer	AC1 / Jay Chu
Test Mode	Transmit by BLE 1M at Channel 2480MHz	Test Voltage	120V/60Hz

--	--	--	--

No	Frequency (MHz)	Reading (dBμV)	C.F (dB/m)	Measurement (dBμV/m)	Margin (dB)	Limit (dBμV/m)	Remark (QP/PK/AV)
1	5003.500	38.42	3.96	42.37	-31.63	74.00	Peak
2	7443.000	32.64	12.76	45.40	-28.60	74.00	Peak
3	* 11616.500	29.39	19.79	49.17	-24.83	74.00	Peak

Note:

1. " *", means this data is the worst emission level.
2. C.F (Correction Factor) = Antenna Factor (dB/m) + Cable Loss (dB) – Preamplifier(dB).
3. Measurement(dBμV/m) = Reading(dBμV) + C.F (Correction Factor).

EUT	ACCESS POINT	Date of Test	2022-01-06
Factor	BBHA 9120D (1GHz~18GHz)_2021	Temp. / Humidity	25.1°C/44.6%
Polarity	Vertical	Site / Test Engineer	AC1 / Jay Chu
Test Mode	Transmit by BLE 1M at Channel 2480MHz	Test Voltage	120V/60Hz

--	--	--	--	--	--	--	--

No	Frequency (MHz)	Reading (dBμV)	C.F (dB/m)	Measurement (dBμV/m)	Margin (dB)	Limit (dBμV/m)	Remark (QP/PK/AV)
1	5003.500	37.65	3.96	41.61	-32.39	74.00	Peak
2	7536.500	32.65	13.05	45.70	-28.30	74.00	Peak
3	* 10860.000	30.17	19.08	49.25	-24.75	74.00	Peak

Note:

1. " *", means this data is the worst emission level.
2. C.F (Correction Factor) = Antenna Factor (dB/m) + Cable Loss (dB) – Preamplifier(dB).
3. Measurement(dBμV/m) = Reading(dBμV) + C.F (Correction Factor).

EUT	ACCESS POINT	Date of Test	2022-01-06
Factor	BBHA 9120D (1GHz~18GHz)_2021	Temp. / Humidity	25.1°C/44.6%
Polarity	Horizontal	Site / Test Engineer	AC1 / Jay Chu
Test Mode	Transmit by BLE 2M at Channel 2402MHz	Test Voltage	120V/60Hz

							
---	--	--	--	--	--	--	--

No	Frequency (MHz)	Reading (dBμV)	C.F (dB/m)	Measurement (dBμV/m)	Margin (dB)	Limit (dBμV/m)	Remark (QP/PK/AV)
1	7502.500	32.48	13.02	45.50	-28.50	74.00	Peak
2	8488.500	32.61	13.65	46.26	-27.74	74.00	Peak
3	* 10877.000	30.45	19.11	49.55	-24.45	74.00	Peak

Note:

1. " *", means this data is the worst emission level.
2. C.F (Correction Factor) = Antenna Factor (dB/m) + Cable Loss (dB) – Preamplifier(dB).
3. Measurement(dBμV/m) = Reading(dBμV) + C.F (Correction Factor).

EUT	ACCESS POINT	Date of Test	2022-01-06
Factor	BBHA 9120D (1GHz~18GHz)_2021	Temp. / Humidity	25.1°C/44.6%
Polarity	Vertical	Site / Test Engineer	AC1 / Jay Chu
Test Mode	Transmit by BLE 2M at Channel 2402MHz	Test Voltage	120V/60Hz

--	--	--	--

No	Frequency (MHz)	Reading (dBμV)	C.F (dB/m)	Measurement (dBμV/m)	Margin (dB)	Limit (dBμV/m)	Remark (QP/PK/AV)
1	7468.500	32.71	12.88	45.58	-28.42	74.00	Peak
2	10817.500	30.58	19.02	49.60	-24.40	74.00	Peak
3	* 15866.500	29.37	20.44	49.81	-24.19	74.00	Peak

Note:

1. " *", means this data is the worst emission level.
2. C.F (Correction Factor) = Antenna Factor (dB/m) + Cable Loss (dB) – Preamplifier(dB).
3. Measurement(dBμV/m) = Reading(dBμV) + C.F (Correction Factor).

EUT	ACCESS POINT	Date of Test	2022-01-06
Factor	BBHA 9120D (1GHz~18GHz)_2021	Temp. / Humidity	25.1°C/44.6%
Polarity	Horizontal	Site / Test Engineer	AC1 / Jay Chu
Test Mode	Transmit by BLE 2M at Channel 2440MHz	Test Voltage	120V/60Hz

(This area is reserved for detailed test results or graphs.)							
--	--	--	--	--	--	--	--

No	Frequency (MHz)	Reading (dBμV)	C.F (dB/m)	Measurement (dBμV/m)	Margin (dB)	Limit (dBμV/m)	Remark (QP/PK/AV)
1	7451.500	32.04	12.80	44.84	-29.16	74.00	Peak
2	9134.500	31.75	15.11	46.86	-27.14	74.00	Peak
3	* 11361.500	30.01	19.84	49.84	-24.16	74.00	Peak

Note:

1. " *", means this data is the worst emission level.
2. C.F (Correction Factor) = Antenna Factor (dB/m) + Cable Loss (dB) – Pre-amplifier(dB).
3. Measurement(dBμV/m) = Reading(dBμV) + C.F (Correction Factor).

EUT	ACCESS POINT	Date of Test	2022-01-06
Factor	BBHA 9120D (1GHz~18GHz)_2021	Temp. / Humidity	25.1°C/44.6%
Polarity	Vertical	Site / Test Engineer	AC1 / Jay Chu
Test Mode	Transmit by BLE 2M at Channel 2440MHz	Test Voltage	120V/60Hz

(This area is reserved for test results, graphs, or additional data.)							
---	--	--	--	--	--	--	--

No	Frequency (MHz)	Reading (dBμV)	C.F (dB/m)	Measurement (dBμV/m)	Margin (dB)	Limit (dBμV/m)	Remark (QP/PK/AV)
1	7477.000	33.42	12.91	46.33	-27.67	74.00	Peak
2	8497.000	32.24	13.65	45.90	-28.10	74.00	Peak
3	* 10996.000	29.59	19.27	48.86	-25.14	74.00	Peak

Note:

1. " *", means this data is the worst emission level.
2. C.F (Correction Factor) = Antenna Factor (dB/m) + Cable Loss (dB) – Preamplifier(dB).
3. Measurement(dBμV/m) = Reading(dBμV) + C.F (Correction Factor).

EUT	ACCESS POINT	Date of Test	2022-01-06
Factor	BBHA 9120D (1GHz~18GHz)_2021	Temp. / Humidity	25.1°C/44.6%
Polarity	Horizontal	Site / Test Engineer	AC1 / Jay Chu
Test Mode	Transmit by BLE 2M at Channel 2480MHz	Test Voltage	120V/60Hz

--

No	Frequency (MHz)	Reading (dBμV)	C.F (dB/m)	Measurement (dBμV/m)	Margin (dB)	Limit (dBμV/m)	Remark (QP/PK/AV)
1	7511.000	33.00	13.02	46.02	-27.98	74.00	Peak
2	9100.500	32.18	15.05	47.22	-26.78	74.00	Peak
3	* 11106.500	29.45	19.44	48.89	-25.11	74.00	Peak

Note:

1. " *", means this data is the worst emission level.
2. C.F (Correction Factor) = Antenna Factor (dB/m) + Cable Loss (dB) – Preamplifier(dB).
3. Measurement(dBμV/m) = Reading(dBμV) + C.F (Correction Factor).

EUT	ACCESS POINT	Date of Test	2022-01-06
Factor	BBHA 9120D (1GHz~18GHz)_2021	Temp. / Humidity	25.1°C/44.6%
Polarity	Vertical	Site / Test Engineer	AC1 / Jay Chu
Test Mode	Transmit by BLE 2M at Channel 2480MHz	Test Voltage	120V/60Hz

--	--	--	--	--	--	--	--

No	Frequency (MHz)	Reading (dBμV)	C.F (dB/m)	Measurement (dBμV/m)	Margin (dB)	Limit (dBμV/m)	Remark (QP/PK/AV)
1	7502.500	33.75	13.02	46.76	-27.24	74.00	Peak
2	9100.500	32.11	15.05	47.16	-26.84	74.00	Peak
3	* 11047.000	29.53	19.35	48.88	-25.12	74.00	Peak

Note:

1. " *", means this data is the worst emission level.
2. C.F (Correction Factor) = Antenna Factor (dB/m) + Cable Loss (dB) – Preamplifier(dB).
3. Measurement(dBμV/m) = Reading(dBμV) + C.F (Correction Factor).

Filter Configuration 5#

EUT	ACCESS POINT	Date of Test	2022-01-06
Factor	BBHA 9120D (1GHz~18GHz)_2021	Temp. / Humidity	25.1°C/44.6%
Polarity	Horizontal	Site / Test Engineer	AC1 / Jay Chu
Test Mode	Transmit by BLE 1M at Channel 2402MHz	Test Voltage	120V/60Hz

--	--	--	--	--	--	--	--	--	--

No	Frequency (MHz)	Reading (dBμV)	C.F (dB/m)	Measurement (dBμV/m)	Margin (dB)	Limit (dBμV/m)	Remark (QP/PK/AV)
1	7409.000	32.88	12.61	45.49	-28.51	74.00	Peak
2	8386.500	32.59	13.60	46.19	-27.81	74.00	Peak
3	* 10868.500	29.87	19.09	48.96	-25.04	74.00	Peak

Note:

1. " *", means this data is the worst emission level.
2. C.F (Correction Factor) = Antenna Factor (dB/m) + Cable Loss (dB) – Preamplifier(dB).
3. Measurement(dBμV/m) = Reading(dBμV) + C.F (Correction Factor).

EUT	ACCESS POINT	Date of Test	2022-01-06
Factor	BBHA 9120D (1GHz~18GHz)_2021	Temp. / Humidity	25.1°C/44.6%
Polarity	Vertical	Site / Test Engineer	AC1 / Jay Chu
Test Mode	Transmit by BLE 1M at Channel 2402MHz	Test Voltage	120V/60Hz

--	--	--	--	--	--	--	--

No	Frequency (MHz)	Reading (dBμV)	C.F (dB/m)	Measurement (dBμV/m)	Margin (dB)	Limit (dBμV/m)	Remark (QP/PK/AV)
1	7596.000	31.82	13.09	44.91	-29.09	74.00	Peak
2	8233.500	30.94	13.54	44.47	-29.53	74.00	Peak
3	* 12636.500	31.06	18.81	49.87	-24.13	74.00	Peak

Note:

1. " *", means this data is the worst emission level.
2. C.F (Correction Factor) = Antenna Factor (dB/m) + Cable Loss (dB) – Preamplifier(dB).
3. Measurement(dBμV/m) = Reading(dBμV) + C.F (Correction Factor).

EUT	ACCESS POINT	Date of Test	2022-01-06
Factor	BBHA 9120D (1GHz~18GHz)_2021	Temp. / Humidity	25.1°C/44.6%
Polarity	Horizontal	Site / Test Engineer	AC1 / Jay Chu
Test Mode	Transmit by BLE 2M at Channel 2402MHz	Test Voltage	120V/60Hz

--

No	Frequency (MHz)	Reading (dBμV)	C.F (dB/m)	Measurement (dBμV/m)	Margin (dB)	Limit (dBμV/m)	Remark (QP/PK/AV)
1	5003.500	36.67	3.96	40.63	-33.37	74.00	Peak
2	7579.000	32.38	13.08	45.46	-28.54	74.00	Peak
3	* 11438.000	29.23	19.95	49.18	-24.82	74.00	Peak

Note:

1. " *", means this data is the worst emission level.
2. C.F (Correction Factor) = Antenna Factor (dB/m) + Cable Loss (dB) – Preamplifier(dB).
3. Measurement(dBμV/m) = Reading(dBμV) + C.F (Correction Factor).

EUT	ACCESS POINT	Date of Test	2022-01-06
Factor	BBHA 9120D (1GHz~18GHz)_2021	Temp. / Humidity	25.1°C/44.6%
Polarity	Vertical	Site / Test Engineer	AC1 / Jay Chu
Test Mode	Transmit by BLE 2M at Channel 2402MHz	Test Voltage	120V/60Hz

--	--	--	--	--	--	--	--

No	Frequency (MHz)	Reading (dBμV)	C.F (dB/m)	Measurement (dBμV/m)	Margin (dB)	Limit (dBμV/m)	Remark (QP/PK/AV)
1	7604.500	32.45	13.10	45.56	-28.44	74.00	Peak
2	8395.000	31.58	13.61	45.18	-28.82	74.00	Peak
3	* 12152.000	31.36	18.76	50.13	-23.87	74.00	Peak

Note:

1. " *", means this data is the worst emission level.
2. C.F (Correction Factor) = Antenna Factor (dB/m) + Cable Loss (dB) – Pre-amplifier(dB).
3. Measurement(dBμV/m) = Reading(dBμV) + C.F (Correction Factor).

Filter Configuration 6#

EUT	ACCESS POINT	Date of Test	2022-01-06
Factor	BBHA 9120D (1GHz~18GHz)_2021	Temp. / Humidity	25.1°C/44.6%
Polarity	Horizontal	Site / Test Engineer	AC1 / Jay Chu
Test Mode	Transmit by BLE 1M at Channel 2480MHz	Test Voltage	120V/60Hz

--	--	--	--	--	--	--	--	--	--

No	Frequency (MHz)	Reading (dBμV)	C.F (dB/m)	Measurement (dBμV/m)	Margin (dB)	Limit (dBμV/m)	Remark (QP/PK/AV)
1	4910.000	36.50	3.79	40.29	-33.71	74.00	Peak
2	7706.500	32.76	13.19	45.95	-28.05	74.00	Peak
3	* 11412.500	28.36	19.92	48.28	-25.72	74.00	Peak

Note:

1. " *", means this data is the worst emission level.
2. C.F (Correction Factor) = Antenna Factor (dB/m) + Cable Loss (dB) – Pre-amplifier(dB).
3. Measurement(dBμV/m) = Reading(dBμV) + C.F (Correction Factor).

EUT	ACCESS POINT	Date of Test	2022-01-06
Factor	BBHA 9120D (1GHz~18GHz)_2021	Temp. / Humidity	25.1°C/44.6%
Polarity	Vertical	Site / Test Engineer	AC1 / Jay Chu
Test Mode	Transmit by BLE 1M at Channel 2480MHz	Test Voltage	120V/60Hz

(This area is reserved for test results or graphs.)							
---	--	--	--	--	--	--	--

No	Frequency (MHz)	Reading (dBμV)	C.F (dB/m)	Measurement (dBμV/m)	Margin (dB)	Limit (dBμV/m)	Remark (QP/PK/AV)
1	4952.500	36.53	3.86	40.39	-33.61	74.00	Peak
2	7672.500	31.74	13.16	44.90	-29.10	74.00	Peak
3	* 12143.500	30.28	18.77	49.06	-24.94	74.00	Peak

Note:

1. " *", means this data is the worst emission level.
2. C.F (Correction Factor) = Antenna Factor (dB/m) + Cable Loss (dB) – Preamplifier(dB).
3. Measurement(dBμV/m) = Reading(dBμV) + C.F (Correction Factor).

EUT	ACCESS POINT	Date of Test	2022-01-06
Factor	BBHA 9120D (1GHz~18GHz)_2021	Temp. / Humidity	25.1°C/44.6%
Polarity	Horizontal	Site / Test Engineer	AC1 / Jay Chu
Test Mode	Transmit by BLE 2M at Channel 2480MHz	Test Voltage	120V/60Hz

--

No	Frequency (MHz)	Reading (dBμV)	C.F (dB/m)	Measurement (dBμV/m)	Margin (dB)	Limit (dBμV/m)	Remark (QP/PK/AV)
1	5003.500	37.29	3.96	41.24	-32.76	74.00	Peak
2	7545.000	32.12	13.05	45.17	-28.83	74.00	Peak
3	* 11446.500	28.75	19.97	48.72	-25.28	74.00	Peak

Note:

1. " *", means this data is the worst emission level.
2. C.F (Correction Factor) = Antenna Factor (dB/m) + Cable Loss (dB) – Pre-amplifier(dB).
3. Measurement(dBμV/m) = Reading(dBμV) + C.F (Correction Factor).

EUT	ACCESS POINT	Date of Test	2022-01-06
Factor	BBHA 9120D (1GHz~18GHz)_2021	Temp. / Humidity	25.1°C/44.6%
Polarity	Vertical	Site / Test Engineer	AC1 / Jay Chu
Test Mode	Transmit by BLE 2M at Channel 2480MHz	Test Voltage	120V/60Hz

--	--	--	--	--	--	--	--

No	Frequency (MHz)	Reading (dBμV)	C.F (dB/m)	Measurement (dBμV/m)	Margin (dB)	Limit (dBμV/m)	Remark (QP/PK/AV)
1	7630.000	31.87	13.12	44.99	-29.01	74.00	Peak
2	8471.500	31.79	13.64	45.43	-28.57	74.00	Peak
3	* 11242.500	29.09	19.65	48.74	-25.26	74.00	Peak

Note:

1. " *", means this data is the worst emission level.
2. C.F (Correction Factor) = Antenna Factor (dB/m) + Cable Loss (dB) – Preamplifier(dB).
3. Measurement(dBμV/m) = Reading(dBμV) + C.F (Correction Factor).

The Result of Radiated Spurious Emission below 1GHz:

EUT	ACCESS POINT	Date of Test	2022-03-22
Factor	FMZB 1519B (9KHz~30MHz)_2021	Temp. / Humidity	24.3°C /44.5%
Polarity	face on	Site / Test Engineer	AC1 / Jay
Test Mode	Transmit by BLE at channel 2440MHz – 1Mbps	Test Voltage	120V/60Hz

--

No	Frequency (MHz)	Reading (dBμV)	C.F (dB/m)	Measurement (dBμV/m)	Margin (dB)	Limit (dBμV/m)	Remark (QP/PK/AV)
1	0.019	33.22	18.49	51.71	-70.20	121.91	Peak
2	0.025	37.32	19.02	56.33	-63.37	119.70	Peak
3	* 0.049	32.39	19.42	51.80	-61.99	113.79	Peak
4	0.073	28.88	18.89	47.77	-62.50	110.28	Peak
5	0.098	25.76	18.36	44.12	-63.67	107.79	Peak
6	0.123	21.57	18.38	39.95	-65.88	105.83	Peak

Note:

1. " *", means this data is the worst emission level.
2. C.F (Correction Factor) = Antenna Factor (dB/m) + Cable Loss (dB).
3. Measurement(dBμV/m) = Reading(dBμV) + C.F (Correction Factor).

EUT	ACCESS POINT	Date of Test	2022-03-22
Factor	FMZB 1519B (9KHz~30MHz)_2021	Temp. / Humidity	24.3°C /44.5%
Polarity	face off	Site / Test Engineer	AC1 / Jay
Test Mode	Transmit by BLE at channel 2440MHz – 1Mbps	Test Voltage	120V/60Hz

--	--	--	--

No	Frequency (MHz)	Reading (dBμV)	C.F (dB/m)	Measurement (dBμV/m)	Margin (dB)	Limit (dBμV/m)	Remark (QP/PK/AV)
1	0.025	37.71	19.01	56.72	-63.01	119.73	Peak
2	*	0.049	33.23	19.42	52.65	113.83	Peak
3	0.074	29.34	18.89	48.23	-62.03	110.26	Peak
4	0.097	26.17	18.37	44.53	-63.28	107.82	Peak
5	0.121	21.74	18.37	40.11	-65.80	105.91	Peak
6	0.147	19.07	18.45	37.52	-66.76	104.27	Peak

Note:

1. " *", means this data is the worst emission level.
2. C.F (Correction Factor) = Antenna Factor (dB/m) + Cable Loss (dB).
3. Measurement(dBμV/m) = Reading(dBμV) + C.F (Correction Factor).

EUT	ACCESS POINT	Date of Test	2022-03-22
Factor	FMZB 1519B (9KHz~30MHz)_2021	Temp. / Humidity	24.3°C /44.5%
Polarity	face on	Site / Test Engineer	AC1 / Jay
Test Mode	Transmit by BLE at channel 2440MHz – 1Mbps	Test Voltage	120V/60Hz

--	--	--	--

No	Frequency (MHz)	Reading (dBμV)	C.F (dB/m)	Measurement (dBμV/m)	Margin (dB)	Limit (dBμV/m)	Remark (QP/PK/AV)
1	0.195	29.28	18.60	47.88	-53.93	101.81	Peak
2	0.419	24.41	18.93	43.34	-51.82	95.17	Peak
3	0.613	20.61	18.97	39.58	-32.28	71.86	Peak
4	* 0.822	19.29	19.02	38.32	-31.01	69.32	Peak
5	2.344	14.48	18.91	33.39	-36.11	69.50	Peak
6	6.299	12.30	19.86	32.16	-37.34	69.50	Peak

Note:

1. " *", means this data is the worst emission level.
2. C.F (Correction Factor) = Antenna Factor (dB/m) + Cable Loss (dB).
3. Measurement(dBμV/m) = Reading(dBμV) + C.F (Correction Factor).

EUT	ACCESS POINT	Date of Test	2022-03-22
Factor	FMZB 1519B (9KHz~30MHz)_2021	Temp. / Humidity	24.3°C /44.5%
Polarity	face off	Site / Test Engineer	AC1 / Jay
Test Mode	Transmit by BLE at channel 2440MHz – 1Mbps	Test Voltage	120V/60Hz

--	--	--	--	--	--	--	--	--	--

No	Frequency (MHz)	Reading (dBμV)	C.F (dB/m)	Measurement (dBμV/m)	Margin (dB)	Limit (dBμV/m)	Remark (QP/PK/AV)
1	0.150	25.67	18.46	44.13	-59.95	104.08	Peak
2	0.374	19.48	18.93	38.41	-57.74	96.15	Peak
3	0.553	17.50	18.95	36.46	-36.30	72.75	Peak
4	* 1.210	16.15	19.04	35.20	-30.77	65.97	Peak
5	2.329	14.25	18.91	33.16	-36.34	69.50	Peak
6	6.627	12.12	19.98	32.10	-37.40	69.50	Peak

Note:

1. " *", means this data is the worst emission level.
2. C.F (Correction Factor) = Antenna Factor (dB/m) + Cable Loss (dB).
3. Measurement(dBμV/m) = Reading(dBμV) + C.F (Correction Factor).

EUT	ACCESS POINT	Date of Test	2022-01-06
Factor	VULB 9162 (30MHz~8GHz) + 6dB Attenuator_2020	Temp. / Humidity	22.2°C /39.5%
Polarity	Horizontal	Site / Test Engineer	AC1 / Jay Chu
Test Mode	Transmit by BLE at channel 2440MHz – 1Mbps	Test Voltage	120V/60Hz

--

No	Frequency (MHz)	Reading (dBμV)	C.F (dB/m)	Measurement (dBμV/m)	Margin (dB)	Limit (dBμV/m)	Remark (QP/PK/AV)
1	50.855	1.78	21.89	23.67	-16.33	40.00	Peak
2	220.605	10.32	19.25	29.58	-16.42	46.00	Peak
3	237.095	9.51	20.05	29.55	-16.45	46.00	Peak
4	261.345	8.51	20.59	29.10	-16.90	46.00	Peak
5	374.350	5.46	23.63	29.09	-16.91	46.00	Peak
6	* 849.165	1.99	31.47	33.46	-12.54	46.00	Peak

Note:

1. " *", means this data is the worst emission level.
2. C.F (Correction Factor) = Antenna Factor (dB/m) + Cable Loss (dB).
3. Measurement(dBμV/m) = Reading(dBμV) + C.F (Correction Factor).

EUT	ACCESS POINT	Date of Test	2022-01-06
Factor	VULB 9162 (30MHz~8GHz) + 6dB Attenuator_2020	Temp. / Humidity	22.2°C /39.5%
Polarity	Vertical	Site / Test Engineer	AC1 / Jay Chu
Test Mode	Transmit by BLE at channel 2440MHz – 1Mbps	Test Voltage	120V/60Hz

--	--	--	--

No	Frequency (MHz)	Reading (dBμV)	C.F (dB/m)	Measurement (dBμV/m)	Margin (dB)	Limit (dBμV/m)	Remark (QP/PK/AV)	
1	*	52.795	8.92	21.54	30.46	-9.54	40.00	Peak
2		169.680	6.51	16.64	23.15	-20.35	43.50	Peak
3		221.575	8.80	19.29	28.10	-17.90	46.00	Peak
4		499.965	2.18	26.22	28.40	-17.60	46.00	Peak
5		703.665	1.46	29.38	30.84	-15.16	46.00	Peak
6		862.260	2.60	31.55	34.16	-11.84	46.00	Peak

Note:

1. " *", means this data is the worst emission level.
2. C.F (Correction Factor) = Antenna Factor (dB/m) + Cable Loss (dB).
3. Measurement(dBμV/m) = Reading(dBμV) + C.F (Correction Factor).

The Result of Radiated Spurious Emission above 18GHz:

EUT	ACCESS POINT	Date of Test	2022-01-25
Factor	BBHA 9170 (15GHz~40GHz)_2021	Temp. / Humidity	19.5°C/37.2%
Polarity	Horizontal	Site / Test Engineer	AC1 / Jay Chu
Test Mode	Transmit by BLE at channel 2440MHz – 1Mbps	Test Voltage	120V / 60Hz

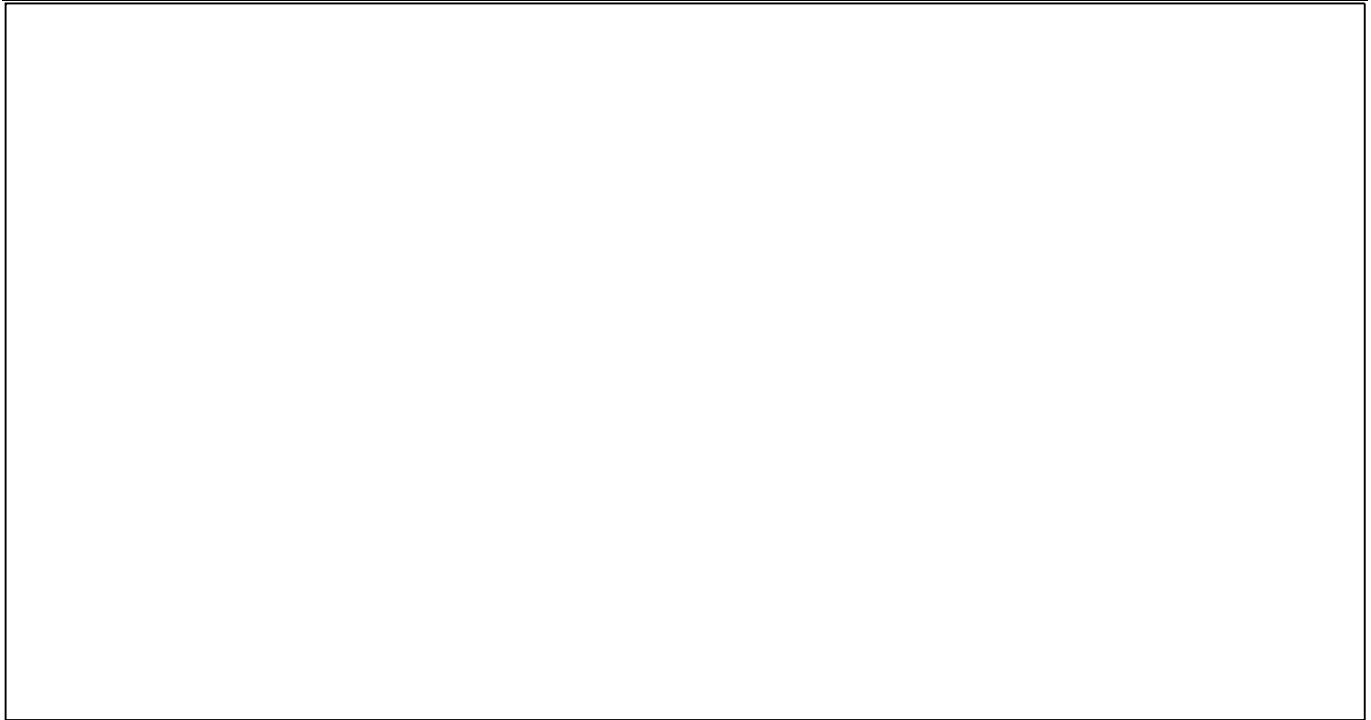
			
---	--	--	--

No	Frequency (MHz)	Reading (dBμV)	C.F (dB/m)	Measurement (dBμV/m)	Margin (dB)	Limit (dBμV/m)	Remark (QP/PK/AV)
1	20704.000	40.89	3.34	44.23	-29.77	74.00	Peak
2	22308.000	41.02	3.65	44.67	-29.33	74.00	Peak
3	* 22860.000	40.76	4.02	44.78	-29.22	74.00	Peak

Note:

1. " *", means this data is the worst emission level.
2. C.F (Correction Factor) = Antenna Factor (dB/m) + Cable Loss (dB) – Pre-amplifier(dB).
3. Measurement(dBμV/m) = Reading(dBμV) + C.F (Correction Factor).

EUT	ACCESS POINT	Date of Test	2022-01-25
Factor	BBHA 9170 (15GHz~40GHz)_2021	Temp. / Humidity	19.5°C/37.2%
Polarity	Vertical	Site / Test Engineer	AC1 / Jay Chu
Test Mode	Transmit by BLE at channel 2440MHz – 1Mbps	Test Voltage	120V / 60Hz

--	--	--	--

No	Frequency (MHz)	Reading (dBμV)	C.F (dB/m)	Measurement (dBμV/m)	Margin (dB)	Limit (dBμV/m)	Remark (QP/PK/AV)
1	20660.000	42.69	3.33	46.02	-27.98	74.00	Peak
2	* 22376.000	42.36	3.70	46.06	-27.94	74.00	Peak
3	22992.000	41.95	4.10	46.05	-27.95	74.00	Peak

Note:

- "*" means this data is the worst emission level.
- C.F (Correction Factor) = Antenna Factor (dB/m) + Cable Loss (dB) – Pre-amplifier(dB).
- Measurement(dBμV/m) = Reading(dBμV) + C.F (Correction Factor).

7.7. Radiated Restricted Band Edge Measurement

7.7.1. Test Limit

For 15.205 requirement:

Radiated emissions which fall in the restricted bands, as defined in Section 15.205(a) of FCC part 15, must also comply with the radiated emission limits specified in Section 15.209(a).

Frequency (MHz)	Frequency (MHz)	Frequency (MHz)	Frequency (GHz)
0.090 - 0.110	16.42 - 16.423	399.9 - 410	4.5 - 5.15
¹ 0.495 - 0.505	16.69475 - 16.69525	608 - 614	5.35 - 5.46
2.1735 - 2.1905	16.80425 - 16.80475	960 - 1240	7.25 - 7.75
4.125 - 4.128	25.5 - 25.67	1300 - 1427	8.025 - 8.5
4.17725 - 4.17775	37.5 - 38.25	1435 - 1626.5	9.0 - 9.2
4.20725 - 4.20775	73 - 74.6	1645.5 - 1646.5	9.3 - 9.5
6.215 - 6.218	74.8 - 75.2	1660 - 1710	10.6 - 12.7
6.26775 - 6.26825	108 - 121.94	1718.8 - 1722.2	13.25 - 13.4
6.31175 - 6.31225	123 - 138	2200 - 2300	14.47 - 14.5
8.291 - 8.294	149.9 - 150.05	2310 - 2390	15.35 - 16.2
8.362 - 8.366	156.52475 - 156.525	2483.5 - 2500	17.7 - 21.4
8.37625 - 8.38675	156.7 - 156.9	2690 - 2900	22.01 - 23.12
8.41425 - 8.41475	162.0125 - 167.17	3260 - 3267	23.6 - 24.0
12.29 - 12.293	167.72 - 173.2	3332 - 3339	31.2 - 31.8
12.51975 - 12.52025	240 - 285	3345.8 - 3358	36.43 - 36.5
12.57675 - 12.57725	322 - 335.4	3600 - 4400	(²)
13.36 - 13.41	--	--	--

All out of band emissions appearing in a restricted band as specified in Section 15.205 of the Title 47CFR must not exceed the limits shown in Table per Section 15.209.

FCC Part 15 Subpart C Paragraph 15.209		
Frequency [MHz]	Field Strength [uV/m]	Measured Distance [Meters]
0.009 - 0.490	2400/F (kHz)	300
0.490 - 1.705	24000/F (kHz)	30
1.705 - 30	30	30
30 - 88	100	3
88 - 216	150	3
216 - 960	200	3
Above 960	500	3

7.7.2. Test Procedure Used

ANSI C63.10-2013 Section 6.3 (General Requirements)

ANSI C63.10-2013 Section 6.6 (Standard test method above 1GHz)

ANSI C63.10-2013 Section 11.13

7.7.3. Test Setting

Peak Field Strength Measurements

1. Analyzer center frequency was set to the frequency of the radiated spurious emission of interest
2. RBW = 1MHz
3. VBW = 3MHz
4. Detector = peak
5. Sweep time = auto couple
6. Trace mode = max hold
7. Trace was allowed to stabilize

Average Field Strength Measurements

1. Analyzer center frequency was set to the frequency of the radiated spurious emission of interest
2. RBW = 1MHz
3. VBW $\geq 1/T$, (For 1Mbps, VBW = 10kHz; For 2Mbps, VBW = 20kHz)
4. Average Type = Voltage
5. Detector = Peak
6. Sweep time = auto
7. Trace mode = max hold
8. Trace was allowed to stabilize

7.7.4. Test Setup

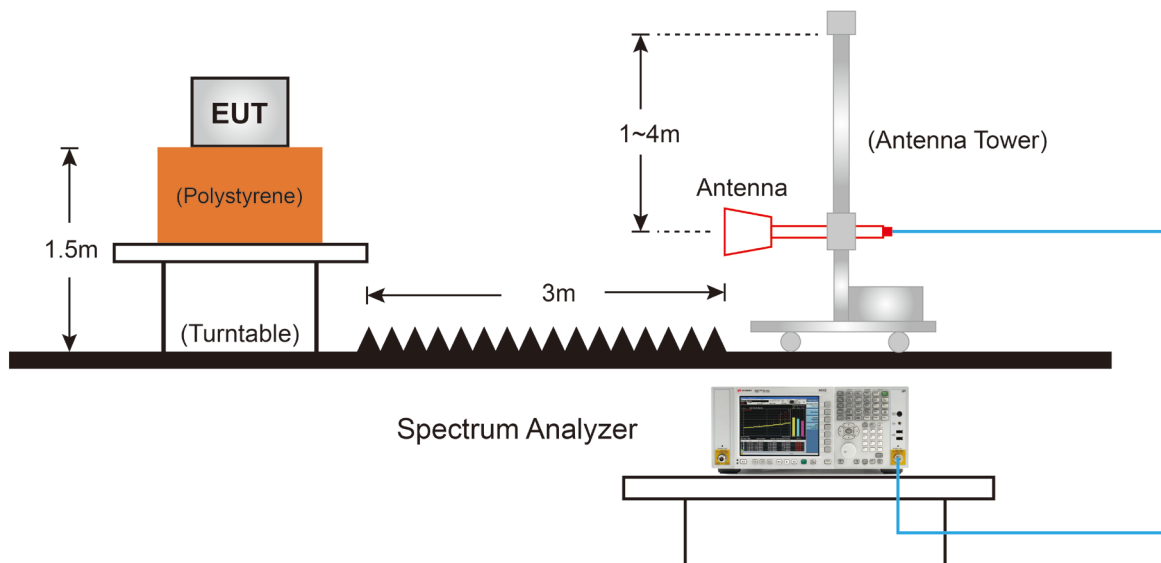

7.7.5. Test Result
Filter Configuration 4#

EUT	ACCESS POINT	Date of Test	2022-01-06
Factor	BBHA 9120D (1GHz~18GHz)_2021	Temp. / Humidity	26.2°C/52.4%
Polarity	Horizontal	Site / Test Engineer	AC1 / Jay Chu
Test Mode	Transmit by BLE 1M at Channel 2402MHz	Test Voltage	120V/60Hz

--

No	Frequency (MHz)	Reading (dBμV)	C.F (dB/m)	Measurement (dBμV/m)	Margin (dB)	Limit (dBμV/m)	Remark (QP/PK/AV)
1	2353.320	25.98	32.06	58.04	-15.96	74.00	Peak
2	2390.000	21.80	32.22	54.02	-19.98	74.00	Peak
3	* 2402.245	72.08	32.27	104.35	N/A	N/A	Peak

Note:

1. " *", means this data is the worst emission level.
2. C.F (Correction Factor) = Antenna Factor (dB/m) + Cable Loss (dB).
3. Measurement(dBμV/m) = Reading(dBμV) + C.F (Correction Factor).

EUT	ACCESS POINT	Date of Test	2022-01-06
Factor	BBHA 9120D (1GHz~18GHz)_2021	Temp. / Humidity	26.2°C/52.4%
Polarity	Horizontal	Site / Test Engineer	AC1 / Jay Chu
Test Mode	Transmit by BLE 1M at Channel 2402MHz	Test Voltage	120V/60Hz

--	--	--	--

No	Frequency (MHz)	Reading (dBμV)	C.F (dB/m)	Measurement (dBμV/m)	Margin (dB)	Limit (dBμV/m)	Remark (QP/PK/AV)
1	2390.000	10.26	32.22	42.48	-11.52	54.00	Average
2	* 2401.960	71.33	32.27	103.60	N/A	N/A	Average

Note:

- "*" means this data is the worst emission level.
- C.F (Correction Factor) = Antenna Factor (dB/m) + Cable Loss (dB).
- Measurement(dBμV/m) = Reading(dBμV) + C.F (Correction Factor).

EUT	ACCESS POINT	Date of Test	2022-01-06
Factor	BBHA 9120D (1GHz~18GHz)_2021	Temp. / Humidity	26.2°C/52.4%
Polarity	Vertical	Site / Test Engineer	AC1 / Jay Chu
Test Mode	Transmit by BLE 1M at Channel 2402MHz	Test Voltage	120V/60Hz

--	--	--	--	--	--	--	--

No	Frequency (MHz)	Reading (dB μ V)	C.F (dB/m)	Measurement (dB μ V/m)	Margin (dB)	Limit (dB μ V/m)	Remark (QP/PK/AV)
1	2381.155	25.32	32.18	57.51	-16.49	74.00	Peak
2	2390.000	23.29	32.22	55.51	-18.49	74.00	Peak
3	* 2402.245	69.18	32.27	101.45	N/A	N/A	Peak

Note:

1. " *", means this data is the worst emission level.
2. C.F (Correction Factor) = Antenna Factor (dB/m) + Cable Loss (dB).
3. Measurement(dB μ V/m) = Reading(dB μ V) + C.F (Correction Factor).

EUT	ACCESS POINT	Date of Test	2022-01-06
Factor	BBHA 9120D (1GHz~18GHz)_2021	Temp. / Humidity	26.2°C/52.4%
Polarity	Vertical	Site / Test Engineer	AC1 / Jay Chu
Test Mode	Transmit by BLE 1M at Channel 2402MHz	Test Voltage	120V/60Hz

--

No	Frequency (MHz)	Reading (dB μ V)	C.F (dB/m)	Measurement (dB μ V/m)	Margin (dB)	Limit (dB μ V/m)	Remark (QP/PK/AV)
1	2390.000	10.90	32.22	43.12	-10.88	54.00	Average
2	* 2402.008	68.50	32.27	100.77	N/A	N/A	Average

Note:

1. " *", means this data is the worst emission level.
2. C.F (Correction Factor) = Antenna Factor (dB/m) + Cable Loss (dB).
3. Measurement(dB μ V/m) = Reading(dB μ V) + C.F (Correction Factor).

EUT	ACCESS POINT	Date of Test	2022-01-06
Factor	BBHA 9120D (1GHz~18GHz)_2021	Temp. / Humidity	26.2°C/52.4%
Polarity	Horizontal	Site / Test Engineer	AC1 / Jay Chu
Test Mode	Transmit by BLE 1M at Channel 2480MHz	Test Voltage	120V/60Hz

--	--	--	--

No	Frequency (MHz)	Reading (dB μ V)	C.F (dB/m)	Measurement (dB μ V/m)	Margin (dB)	Limit (dB μ V/m)	Remark (QP/PK/AV)	
1	*	2479.727	71.82	32.59	104.41	N/A	N/A	Peak
2		2483.500	27.53	32.61	60.14	-13.86	74.00	Peak
3		2483.698	29.09	32.61	61.70	-12.30	74.00	Peak

Note:

- "*" means this data is the worst emission level.
- C.F (Correction Factor) = Antenna Factor (dB/m) + Cable Loss (dB).
- Measurement(dB μ V/m) = Reading(dB μ V) + C.F (Correction Factor).

EUT	ACCESS POINT	Date of Test	2022-01-06
Factor	BBHA 9120D (1GHz~18GHz)_2021	Temp. / Humidity	26.2°C/52.4%
Polarity	Horizontal	Site / Test Engineer	AC1 / Jay Chu
Test Mode	Transmit by BLE 1M at Channel 2480MHz	Test Voltage	120V/60Hz

(This area is reserved for test results or images. The content is currently blank.)			
---	--	--	--

No	Frequency (MHz)	Reading (dBμV)	C.F (dB/m)	Measurement (dBμV/m)	Margin (dB)	Limit (dBμV/m)	Remark (QP/PK/AV)	
1	*	2480.035	71.04	32.60	103.64	N/A	N/A	Average
2		2483.500	12.72	32.61	45.33	-8.67	54.00	Average

Note:

1. " *", means this data is the worst emission level.
2. C.F (Correction Factor) = Antenna Factor (dB/m) + Cable Loss (dB).
3. Measurement(dBμV/m) = Reading(dBμV) + C.F (Correction Factor).

EUT	ACCESS POINT	Date of Test	2022-01-06
Factor	BBHA 9120D (1GHz~18GHz)_2021	Temp. / Humidity	26.2°C/52.4%
Polarity	Vertical	Site / Test Engineer	AC1 / Jay Chu
Test Mode	Transmit by BLE 1M at Channel 2480MHz	Test Voltage	120V/60Hz

--	--	--	--

No	Frequency (MHz)	Reading (dBμV)	C.F (dB/m)	Measurement (dBμV/m)	Margin (dB)	Limit (dBμV/m)	Remark (QP/PK/AV)	
1	*	2480.233	70.16	32.60	102.76	N/A	N/A	Peak
2		2483.500	26.53	32.61	59.14	-14.86	74.00	Peak
3		2483.632	27.62	32.61	60.23	-13.77	74.00	Peak

Note:

1. " *", means this data is the worst emission level.
2. C.F (Correction Factor) = Antenna Factor (dB/m) + Cable Loss (dB).
3. Measurement(dBμV/m) = Reading(dBμV) + C.F (Correction Factor).

EUT	ACCESS POINT	Date of Test	2022-01-06
Factor	BBHA 9120D (1GHz~18GHz)_2021	Temp. / Humidity	26.2°C/52.4%
Polarity	Vertical	Site / Test Engineer	AC1 / Jay Chu
Test Mode	Transmit by BLE 1M at Channel 2480MHz	Test Voltage	120V/60Hz

--	--	--	--

No	Frequency (MHz)	Reading (dB μ V)	C.F (dB/m)	Measurement (dB μ V/m)	Margin (dB)	Limit (dB μ V/m)	Remark (QP/PK/AV)	
1	*	2480.068	69.63	32.60	102.23	N/A	N/A	Average
2		2483.500	12.14	32.61	44.75	-9.25	54.00	Average

Note:

- "*" means this data is the worst emission level.
- C.F (Correction Factor) = Antenna Factor (dB/m) + Cable Loss (dB).
- Measurement(dB μ V/m) = Reading(dB μ V) + C.F (Correction Factor).

EUT	ACCESS POINT	Date of Test	2022-01-06
Factor	BBHA 9120D (1GHz~18GHz)_2021	Temp. / Humidity	26.2°C/52.4%
Polarity	Horizontal	Site / Test Engineer	AC1 / Jay Chu
Test Mode	Transmit by BLE 2M at Channel 2402MHz	Test Voltage	120V/60Hz

(This area is reserved for test results or additional data.)							
--	--	--	--	--	--	--	--

No	Frequency (MHz)	Reading (dBμV)	C.F (dB/m)	Measurement (dBμV/m)	Margin (dB)	Limit (dBμV/m)	Remark (QP/PK/AV)
1	2357.548	26.18	32.08	58.26	-15.74	74.00	Peak
2	2390.000	24.05	32.22	56.27	-17.73	74.00	Peak
3	* 2402.482	72.19	32.27	104.46	N/A	N/A	Peak

Note:

1. " *", means this data is the worst emission level.
2. C.F (Correction Factor) = Antenna Factor (dB/m) + Cable Loss (dB).
3. Measurement(dBμV/m) = Reading(dBμV) + C.F (Correction Factor).

EUT	ACCESS POINT	Date of Test	2022-01-06
Factor	BBHA 9120D (1GHz~18GHz)_2021	Temp. / Humidity	26.2°C/52.4%
Polarity	Horizontal	Site / Test Engineer	AC1 / Jay Chu
Test Mode	Transmit by BLE 2M at Channel 2402MHz	Test Voltage	120V/60Hz

(This area is reserved for test results or graphs.)							
---	--	--	--	--	--	--	--

No	Frequency (MHz)	Reading (dBμV)	C.F (dB/m)	Measurement (dBμV/m)	Margin (dB)	Limit (dBμV/m)	Remark (QP/PK/AV)
1	2390.000	11.57	32.22	43.79	-10.21	54.00	Average
2	* 2401.960	70.20	32.27	102.46	N/A	N/A	Average

Note:

1. " *", means this data is the worst emission level.
2. C.F (Correction Factor) = Antenna Factor (dB/m) + Cable Loss (dB).
3. Measurement(dBμV/m) = Reading(dBμV) + C.F (Correction Factor).

EUT	ACCESS POINT	Date of Test	2022-01-06
Factor	BBHA 9120D (1GHz~18GHz)_2021	Temp. / Humidity	26.2°C/52.4%
Polarity	Vertical	Site / Test Engineer	AC1 / Jay Chu
Test Mode	Transmit by BLE 2M at Channel 2402MHz	Test Voltage	120V/60Hz

--	--	--	--	--	--	--	--

No	Frequency (MHz)	Reading (dBμV)	C.F (dB/m)	Measurement (dBμV/m)	Margin (dB)	Limit (dBμV/m)	Remark (QP/PK/AV)
1	2343.060	25.20	32.02	57.22	-16.78	74.00	Peak
2	2390.000	22.12	32.22	54.34	-19.66	74.00	Peak
3	* 2402.482	68.98	32.27	101.25	N/A	N/A	Peak

Note:

1. " *", means this data is the worst emission level.
2. C.F (Correction Factor) = Antenna Factor (dB/m) + Cable Loss (dB).
3. Measurement(dBμV/m) = Reading(dBμV) + C.F (Correction Factor).

EUT	ACCESS POINT	Date of Test	2022-01-06
Factor	BBHA 9120D (1GHz~18GHz)_2021	Temp. / Humidity	26.2°C/52.4%
Polarity	Vertical	Site / Test Engineer	AC1 / Jay Chu
Test Mode	Transmit by BLE 2M at Channel 2402MHz	Test Voltage	120V/60Hz

--	--	--	--	--	--	--	--

No	Frequency (MHz)	Reading (dBμV)	C.F (dB/m)	Measurement (dBμV/m)	Margin (dB)	Limit (dBμV/m)	Remark (QP/PK/AV)
1	2390.000	11.70	32.22	43.92	-10.08	54.00	Average
2	* 2401.960	66.97	32.27	99.24	N/A	N/A	Average

Note:

- "*" means this data is the worst emission level.
- C.F (Correction Factor) = Antenna Factor (dB/m) + Cable Loss (dB).
- Measurement(dBμV/m) = Reading(dBμV) + C.F (Correction Factor).

EUT	ACCESS POINT	Date of Test	2022-01-06
Factor	BBHA 9120D (1GHz~18GHz)_2021	Temp. / Humidity	26.2°C/52.4%
Polarity	Horizontal	Site / Test Engineer	AC1 / Jay Chu
Test Mode	Transmit by BLE 2M at Channel 2480MHz	Test Voltage	120V/60Hz

--	--	--	--

No	Frequency (MHz)	Reading (dBμV)	C.F (dB/m)	Measurement (dBμV/m)	Margin (dB)	Limit (dBμV/m)	Remark (QP/PK/AV)	
1	*	2479.474	71.82	32.59	104.42	N/A	N/A	Peak
2		2483.500	28.41	32.61	61.02	-12.98	74.00	Peak
3		2483.918	28.67	32.61	61.28	-12.72	74.00	Peak

Note:

1. " *", means this data is the worst emission level.
2. C.F (Correction Factor) = Antenna Factor (dB/m) + Cable Loss (dB).
3. Measurement(dBμV/m) = Reading(dBμV) + C.F (Correction Factor).

EUT	ACCESS POINT	Date of Test	2022-01-06
Factor	BBHA 9120D (1GHz~18GHz)_2021	Temp. / Humidity	26.2°C/52.4%
Polarity	Horizontal	Site / Test Engineer	AC1 / Jay Chu
Test Mode	Transmit by BLE 2M at Channel 2480MHz	Test Voltage	120V/60Hz

--	--	--	--

No	Frequency (MHz)	Reading (dBμV)	C.F (dB/m)	Measurement (dBμV/m)	Margin (dB)	Limit (dBμV/m)	Remark (QP/PK/AV)	
1	*	2479.980	69.67	32.60	102.27	N/A	N/A	Average
2		2483.500	16.59	32.61	49.21	-4.79	54.00	Average
3		2483.731	17.57	32.61	50.18	-3.82	54.00	Average

Note:

1. " *", means this data is the worst emission level.
2. C.F (Correction Factor) = Antenna Factor (dB/m) + Cable Loss (dB).
3. Measurement(dBμV/m) = Reading(dBμV) + C.F (Correction Factor).

EUT	ACCESS POINT	Date of Test	2022-01-06
Factor	BBHA 9120D (1GHz~18GHz)_2021	Temp. / Humidity	26.2°C/52.4%
Polarity	Vertical	Site / Test Engineer	AC1 / Jay Chu
Test Mode	Transmit by BLE 2M at Channel 2480MHz	Test Voltage	120V/60Hz

--	--	--	--

No	Frequency (MHz)	Reading (dBμV)	C.F (dB/m)	Measurement (dBμV/m)	Margin (dB)	Limit (dBμV/m)	Remark (QP/PK/AV)	
1	*	2479.980	68.82	32.60	101.42	N/A	N/A	Peak
2		2483.500	24.15	32.61	56.76	-17.24	74.00	Peak
3		2483.962	27.02	32.61	59.63	-14.37	74.00	Peak

Note:

1. " *", means this data is the worst emission level.
2. C.F (Correction Factor) = Antenna Factor (dB/m) + Cable Loss (dB).
3. Measurement(dBμV/m) = Reading(dBμV) + C.F (Correction Factor).

EUT	ACCESS POINT	Date of Test	2022-01-06
Factor	BBHA 9120D (1GHz~18GHz)_2021	Temp. / Humidity	26.2°C/52.4%
Polarity	Vertical	Site / Test Engineer	AC1 / Jay Chu
Test Mode	Transmit by BLE 2M at Channel 2480MHz	Test Voltage	120V/60Hz

--	--	--	--

No	Frequency (MHz)	Reading (dB μ V)	C.F (dB/m)	Measurement (dB μ V/m)	Margin (dB)	Limit (dB μ V/m)	Remark (QP/PK/AV)	
1	*	2480.035	66.76	32.60	99.36	N/A	N/A	Average
2		2483.500	14.41	32.61	47.02	-6.98	54.00	Average
3		2483.819	14.84	32.61	47.45	-6.55	54.00	Average

Note:

1. " *", means this data is the worst emission level.
2. C.F (Correction Factor) = Antenna Factor (dB/m) + Cable Loss (dB).
3. Measurement(dB μ V/m) = Reading(dB μ V) + C.F (Correction Factor).

Filter Configuration 5#

EUT	ACCESS POINT	Date of Test	2022-01-06
Factor	BBHA 9120D (1GHz~18GHz)_2021	Temp. / Humidity	26.0°C/48.2%
Polarity	Horizontal	Site / Test Engineer	AC1 / Jay Chu
Test Mode	Transmit by BLE 1M at Channel 2402MHz	Test Voltage	120V/60Hz

--	--	--	--	--	--	--	--	--	--

No	Frequency (MHz)	Reading (dBμV)	C.F (dB/m)	Measurement (dBμV/m)	Margin (dB)	Limit (dBμV/m)	Remark (QP/PK/AV)
1	2369.185	27.17	32.13	59.30	-14.70	74.00	Peak
2	2390.000	22.47	32.22	54.69	-19.31	74.00	Peak
3	* 2401.722	70.94	32.27	103.20	N/A	N/A	Peak

Note:

1. " *", means this data is the worst emission level.
2. C.F (Correction Factor) = Antenna Factor (dB/m) + Cable Loss (dB).
3. Measurement(dBμV/m) = Reading(dBμV) + C.F (Correction Factor).

EUT	ACCESS POINT	Date of Test	2022-01-06
Factor	BBHA 9120D (1GHz~18GHz)_2021	Temp. / Humidity	26.0°C/48.2%
Polarity	Horizontal	Site / Test Engineer	AC1 / Jay Chu
Test Mode	Transmit by BLE 1M at Channel 2402MHz	Test Voltage	120V/60Hz

--	--	--	--	--	--	--	--	--	--

No	Frequency (MHz)	Reading (dBμV)	C.F (dB/m)	Measurement (dBμV/m)	Margin (dB)	Limit (dBμV/m)	Remark (QP/PK/AV)
1	2389.705	11.54	32.22	43.76	-10.24	54.00	Average
2	2390.000	10.50	32.22	42.72	-11.28	54.00	Average
3	* 2402.008	70.06	32.27	102.33	N/A	N/A	Average

Note:

1. " *", means this data is the worst emission level.
2. C.F (Correction Factor) = Antenna Factor (dB/m) + Cable Loss (dB).
3. Measurement(dBμV/m) = Reading(dBμV) + C.F (Correction Factor).

EUT	ACCESS POINT	Date of Test	2022-01-06
Factor	BBHA 9120D (1GHz~18GHz)_2021	Temp. / Humidity	26.0°C/48.2%
Polarity	Vertical	Site / Test Engineer	AC1 / Jay Chu
Test Mode	Transmit by BLE 1M at Channel 2402MHz	Test Voltage	120V/60Hz

--	--	--	--

No	Frequency (MHz)	Reading (dBμV)	C.F (dB/m)	Measurement (dBμV/m)	Margin (dB)	Limit (dBμV/m)	Remark (QP/PK/AV)
1	2337.978	24.92	32.00	56.92	-17.08	74.00	Peak
2	2390.000	23.40	32.22	55.62	-18.38	74.00	Peak
3	* 2402.245	68.27	32.27	100.54	N/A	N/A	Peak

Note:

1. " *", means this data is the worst emission level.
2. C.F (Correction Factor) = Antenna Factor (dB/m) + Cable Loss (dB).
3. Measurement(dBμV/m) = Reading(dBμV) + C.F (Correction Factor).

EUT	ACCESS POINT	Date of Test	2022-01-06
Factor	BBHA 9120D (1GHz~18GHz)_2021	Temp. / Humidity	26.0°C/48.2%
Polarity	Vertical	Site / Test Engineer	AC1 / Jay Chu
Test Mode	Transmit by BLE 1M at Channel 2402MHz	Test Voltage	120V/60Hz

--	--	--	--

No	Frequency (MHz)	Reading (dBμV)	C.F (dB/m)	Measurement (dBμV/m)	Margin (dB)	Limit (dBμV/m)	Remark (QP/PK/AV)
1	2374.363	11.35	32.15	43.51	-10.49	54.00	Average
2	2390.000	10.35	32.22	42.57	-11.43	54.00	Average
3	* 2402.008	68.00	32.27	100.27	N/A	N/A	Average

Note:

1. " *", means this data is the worst emission level.
2. C.F (Correction Factor) = Antenna Factor (dB/m) + Cable Loss (dB).
3. Measurement(dBμV/m) = Reading(dBμV) + C.F (Correction Factor).

EUT	ACCESS POINT	Date of Test	2022-01-06
Factor	BBHA 9120D (1GHz~18GHz)_2021	Temp. / Humidity	26.0°C/48.2%
Polarity	Horizontal	Site / Test Engineer	AC1 / Jay Chu
Test Mode	Transmit by BLE 2M at Channel 2402MHz	Test Voltage	120V/60Hz

--	--	--	--	--	--	--	--

No	Frequency (MHz)	Reading (dBμV)	C.F (dB/m)	Measurement (dBμV/m)	Margin (dB)	Limit (dBμV/m)	Remark (QP/PK/AV)
1	2383.958	24.82	32.19	57.02	-16.98	74.00	Peak
2	2390.000	21.49	32.22	53.71	-20.29	74.00	Peak
3	* 2401.485	70.98	32.27	103.25	N/A	N/A	Peak

Note:

1. " *", means this data is the worst emission level.
2. C.F (Correction Factor) = Antenna Factor (dB/m) + Cable Loss (dB).
3. Measurement(dBμV/m) = Reading(dBμV) + C.F (Correction Factor).

EUT	ACCESS POINT	Date of Test	2022-01-06
Factor	BBHA 9120D (1GHz~18GHz)_2021	Temp. / Humidity	26.0°C/48.2%
Polarity	Horizontal	Site / Test Engineer	AC1 / Jay Chu
Test Mode	Transmit by BLE 2M at Channel 2402MHz	Test Voltage	120V/60Hz

--	--	--	--

No	Frequency (MHz)	Reading (dBμV)	C.F (dB/m)	Measurement (dBμV/m)	Margin (dB)	Limit (dBμV/m)	Remark (QP/PK/AV)
1	2372.083	12.73	32.14	44.88	-9.12	54.00	Average
2	2390.000	11.68	32.22	43.90	-10.10	54.00	Average
3	* 2401.960	68.93	32.27	101.20	N/A	N/A	Average

Note:

1. " *", means this data is the worst emission level.
2. C.F (Correction Factor) = Antenna Factor (dB/m) + Cable Loss (dB).
3. Measurement(dBμV/m) = Reading(dBμV) + C.F (Correction Factor).

EUT	ACCESS POINT	Date of Test	2022-01-06
Factor	BBHA 9120D (1GHz~18GHz)_2021	Temp. / Humidity	26.0°C/48.2%
Polarity	Vertical	Site / Test Engineer	AC1 / Jay Chu
Test Mode	Transmit by BLE 2M at Channel 2402MHz	Test Voltage	120V/60Hz

--	--	--	--	--	--	--	--

No	Frequency (MHz)	Reading (dBμV)	C.F (dB/m)	Measurement (dBμV/m)	Margin (dB)	Limit (dBμV/m)	Remark (QP/PK/AV)
1	2383.198	25.25	32.19	57.44	-16.56	74.00	Peak
2	2390.000	22.50	32.22	54.72	-19.28	74.00	Peak
3	* 2402.482	68.00	32.27	100.27	N/A	N/A	Peak

Note:

1. " *", means this data is the worst emission level.
2. C.F (Correction Factor) = Antenna Factor (dB/m) + Cable Loss (dB).
3. Measurement(dBμV/m) = Reading(dBμV) + C.F (Correction Factor).

EUT	ACCESS POINT	Date of Test	2022-01-06
Factor	BBHA 9120D (1GHz~18GHz)_2021	Temp. / Humidity	26.0°C/48.2%
Polarity	Vertical	Site / Test Engineer	AC1 / Jay Chu
Test Mode	Transmit by BLE 2M at Channel 2402MHz	Test Voltage	120V/60Hz

--	--	--	--	--	--	--	--	--	--

No	Frequency (MHz)	Reading (dBμV)	C.F (dB/m)	Measurement (dBμV/m)	Margin (dB)	Limit (dBμV/m)	Remark (QP/PK/AV)
1	2363.722	13.11	32.11	45.22	-8.78	54.00	Average
2	2390.000	12.10	32.22	44.32	-9.68	54.00	Average
3	* 2402.008	66.53	32.27	98.80	N/A	N/A	Average

Note:

1. " *", means this data is the worst emission level.
2. C.F (Correction Factor) = Antenna Factor (dB/m) + Cable Loss (dB).
3. Measurement(dBμV/m) = Reading(dBμV) + C.F (Correction Factor).

Filter Configuration 6#

EUT	ACCESS POINT	Date of Test	2022-01-06
Factor	BBHA 9120D (1GHz~18GHz)_2021	Temp. / Humidity	26.0°C/48.2%
Polarity	Horizontal	Site / Test Engineer	AC1 / Jay Chu
Test Mode	Transmit by BLE 1M at Channel 2480MHz	Test Voltage	120V/60Hz

--	--	--	--	--	--	--	--	--	--

No	Frequency (MHz)	Reading (dBμV)	C.F (dB/m)	Measurement (dBμV/m)	Margin (dB)	Limit (dBμV/m)	Remark (QP/PK/AV)	
1	*	2479.716	68.76	32.59	101.36	N/A	N/A	Peak
2		2483.500	24.12	32.61	56.73	-17.27	74.00	Peak
3		2483.885	25.35	32.61	57.96	-16.04	74.00	Peak

Note:

1. " *", means this data is the worst emission level.
2. C.F (Correction Factor) = Antenna Factor (dB/m) + Cable Loss (dB).
3. Measurement(dBμV/m) = Reading(dBμV) + C.F (Correction Factor).

EUT	ACCESS POINT	Date of Test	2022-01-06
Factor	BBHA 9120D (1GHz~18GHz)_2021	Temp. / Humidity	26.0°C/48.2%
Polarity	Horizontal	Site / Test Engineer	AC1 / Jay Chu
Test Mode	Transmit by BLE 1M at Channel 2480MHz	Test Voltage	120V/60Hz

--	--	--	--

No	Frequency (MHz)	Reading (dBμV)	C.F (dB/m)	Measurement (dBμV/m)	Margin (dB)	Limit (dBμV/m)	Remark (QP/PK/AV)	
1	*	2479.991	68.03	32.60	100.63	N/A	N/A	Average
2		2483.500	11.60	32.61	44.22	-9.78	54.00	Average
3		2483.995	12.23	32.61	44.84	-9.16	54.00	Average

Note:

1. " *", means this data is the worst emission level.
2. C.F (Correction Factor) = Antenna Factor (dB/m) + Cable Loss (dB).
3. Measurement(dBμV/m) = Reading(dBμV) + C.F (Correction Factor).

EUT	ACCESS POINT	Date of Test	2022-01-06
Factor	BBHA 9120D (1GHz~18GHz)_2021	Temp. / Humidity	26.0°C/48.2%
Polarity	Vertical	Site / Test Engineer	AC1 / Jay Chu
Test Mode	Transmit by BLE 1M at Channel 2480MHz	Test Voltage	120V/60Hz

--	--	--	--

No	Frequency (MHz)	Reading (dB μ V)	C.F (dB/m)	Measurement (dB μ V/m)	Margin (dB)	Limit (dB μ V/m)	Remark (QP/PK/AV)	
1	*	2479.705	67.31	32.59	99.91	N/A	N/A	Peak
2		2483.500	21.83	32.61	54.44	-19.56	74.00	Peak
3		2483.643	25.15	32.61	57.76	-16.24	74.00	Peak

Note:

1. " *", means this data is the worst emission level.
2. C.F (Correction Factor) = Antenna Factor (dB/m) + Cable Loss (dB).
3. Measurement(dB μ V/m) = Reading(dB μ V) + C.F (Correction Factor).

EUT	ACCESS POINT	Date of Test	2022-01-06
Factor	BBHA 9120D (1GHz~18GHz)_2021	Temp. / Humidity	26.0°C/48.2%
Polarity	Vertical	Site / Test Engineer	AC1 / Jay Chu
Test Mode	Transmit by BLE 1M at Channel 2480MHz	Test Voltage	120V/60Hz

--	--	--	--

No	Frequency (MHz)	Reading (dBμV)	C.F (dB/m)	Measurement (dBμV/m)	Margin (dB)	Limit (dBμV/m)	Remark (QP/PK/AV)	
1	*	2479.991	66.71	32.60	99.31	N/A	N/A	Average
2		2483.500	11.10	32.61	43.71	-10.29	54.00	Average
3		2483.577	11.83	32.61	44.44	-9.56	54.00	Average

Note:

1. " *", means this data is the worst emission level.
2. C.F (Correction Factor) = Antenna Factor (dB/m) + Cable Loss (dB).
3. Measurement(dBμV/m) = Reading(dBμV) + C.F (Correction Factor).

EUT	ACCESS POINT	Date of Test	2022-01-06
Factor	BBHA 9120D (1GHz~18GHz)_2021	Temp. / Humidity	26.0°C/48.2%
Polarity	Horizontal	Site / Test Engineer	AC1 / Jay Chu
Test Mode	Transmit by BLE 2M at Channel 2480MHz	Test Voltage	120V/60Hz

--	--	--	--

No	Frequency (MHz)	Reading (dBμV)	C.F (dB/m)	Measurement (dBμV/m)	Margin (dB)	Limit (dBμV/m)	Remark (QP/PK/AV)	
1	*	2479.485	68.39	32.59	100.98	N/A	N/A	Average
2		2483.500	24.29	32.61	56.90	-17.10	74.00	Average
3		2483.555	25.30	32.61	57.91	-16.09	74.00	Average

Note:

1. " *", means this data is the worst emission level.
2. C.F (Correction Factor) = Antenna Factor (dB/m) + Cable Loss (dB).
3. Measurement(dBμV/m) = Reading(dBμV) + C.F (Correction Factor).

EUT	ACCESS POINT	Date of Test	2022-01-06
Factor	BBHA 9120D (1GHz~18GHz)_2021	Temp. / Humidity	26.0°C/48.2%
Polarity	Horizontal	Site / Test Engineer	AC1 / Jay Chu
Test Mode	Transmit by BLE 2M at Channel 2480MHz	Test Voltage	120V/60Hz

--	--	--	--

No	Frequency (MHz)	Reading (dBμV)	C.F (dB/m)	Measurement (dBμV/m)	Margin (dB)	Limit (dBμV/m)	Remark (QP/PK/AV)	
1	*	2479.958	66.59	32.60	99.18	N/A	N/A	Average
2		2483.500	14.43	32.61	47.05	-6.95	54.00	Average
3		2483.698	14.81	32.61	47.42	-6.58	54.00	Average

Note:

1. " *", means this data is the worst emission level.
2. C.F (Correction Factor) = Antenna Factor (dB/m) + Cable Loss (dB).
3. Measurement(dBμV/m) = Reading(dBμV) + C.F (Correction Factor).

EUT	ACCESS POINT	Date of Test	2022-01-06
Factor	BBHA 9120D (1GHz~18GHz)_2021	Temp. / Humidity	26.0°C/48.2%
Polarity	Vertical	Site / Test Engineer	AC1 / Jay Chu
Test Mode	Transmit by BLE 2M at Channel 2480MHz	Test Voltage	120V/60Hz

--	--	--	--

No	Frequency (MHz)	Reading (dBμV)	C.F (dB/m)	Measurement (dBμV/m)	Margin (dB)	Limit (dBμV/m)	Remark (QP/PK/AV)	
1	*	2479.474	67.31	32.59	99.91	N/A	N/A	Peak
2		2483.500	21.29	32.61	53.90	-20.10	74.00	Peak
3		2484.589	24.93	32.62	57.54	-16.46	74.00	Peak

Note:

1. " *", means this data is the worst emission level.
2. C.F (Correction Factor) = Antenna Factor (dB/m) + Cable Loss (dB).
3. Measurement(dBμV/m) = Reading(dBμV) + C.F (Correction Factor).

EUT	ACCESS POINT	Date of Test	2022-01-06
Factor	BBHA 9120D (1GHz~18GHz)_2021	Temp. / Humidity	26.0°C/48.2%
Polarity	Vertical	Site / Test Engineer	AC1 / Jay Chu
Test Mode	Transmit by BLE 2M at Channel 2480MHz	Test Voltage	120V/60Hz

--	--	--	--

No	Frequency (MHz)	Reading (dBμV)	C.F (dB/m)	Measurement (dBμV/m)	Margin (dB)	Limit (dBμV/m)	Remark (QP/PK/AV)	
1	*	2479.969	65.39	32.60	97.98	N/A	N/A	Average
2		2483.500	14.04	32.61	46.65	-7.35	54.00	Average
3		2483.654	14.59	32.61	47.20	-6.80	54.00	Average

Note:

1. " *", means this data is the worst emission level.
2. C.F (Correction Factor) = Antenna Factor (dB/m) + Cable Loss (dB).
3. Measurement(dBμV/m) = Reading(dBμV) + C.F (Correction Factor).

7.8. AC Conducted Emissions Measurement

7.8.1. Test Limit

FCC Part 15 Subpart C Paragraph 15.207 Limits		
Frequency (MHz)	QP (dBuV)	AV (dBuV)
0.15 - 0.50	66 - 56	56 - 46
0.50 - 5.0	56	46
5.0 - 30	60	50

Note 1: The lower limit shall apply at the transition frequencies.

Note 2: The limit decreases linearly with the logarithm of the frequency in the range 0.15MHz to 0.5MHz.

7.8.2. Test Setup

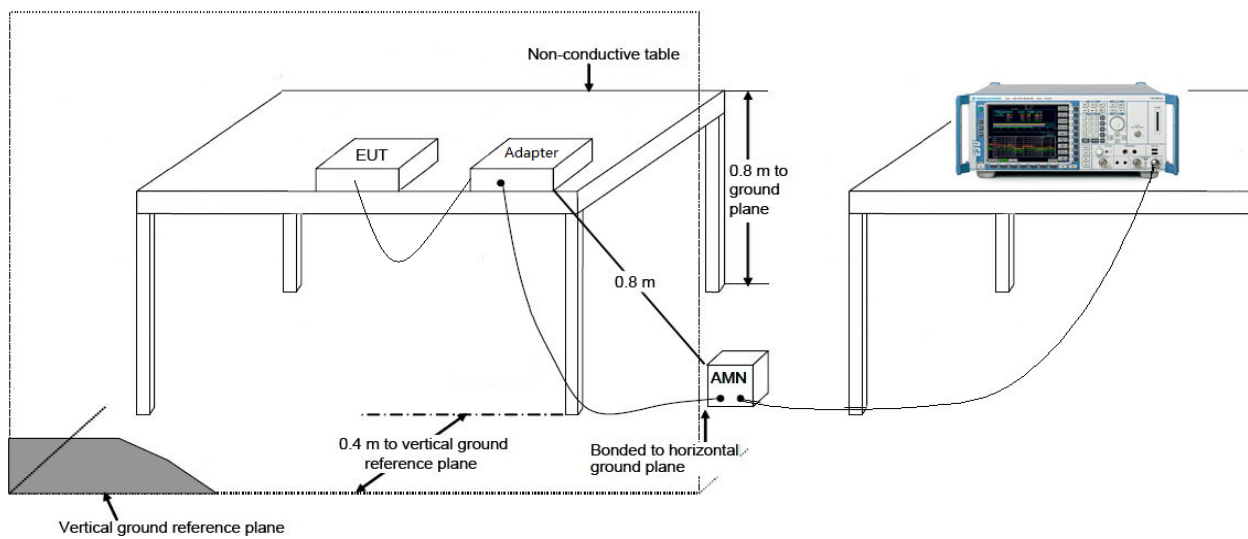

7.8.3. Test Result

EUT	ACCESS POINT	Date of Test	2022-01-06
Factor	CE_ENV216-L1 (Filter OFF)_2021	Temp. / Humidity	20.3°C /43.5%
Polarity	Line1	Site / Test Engineer	SR2 / Eric Lin
Test Mode	Transmit by BLE at channel 2440MHz -1Mbps	Test Voltage	120V/60Hz



No	Frequency (MHz)	Reading (dBμV)	C.F (dB)	Measurement (dBμV)	Margin (dB)	Limit (dBμV)	Remark (QP/PK/AV)
1	0.150	34.59	9.61	44.20	-21.80	66.00	QP
2	0.150	16.59	9.61	26.20	-29.80	56.00	Average
3	* 0.166	34.09	9.61	43.70	-21.46	65.16	QP
4	0.166	16.79	9.61	26.40	-28.76	55.16	Average
5	0.178	31.29	9.61	40.90	-23.68	64.58	QP
6	0.178	14.19	9.61	23.80	-30.78	54.58	Average
7	0.398	19.28	9.62	28.90	-29.00	57.90	QP
8	0.398	15.88	9.62	25.50	-22.40	47.90	Average
9	0.434	14.67	9.63	24.30	-32.88	57.18	QP
10	0.434	0.77	9.63	10.40	-36.78	47.18	Average
11	19.820	11.42	9.98	21.40	-38.60	60.00	QP
12	19.820	5.62	9.98	15.60	-34.40	50.00	Average

Note:

1. " *", means this data is the worst emission level.
2. C.F (Correction Factor) = LISN Factor (dB) + Cable Loss (dB).
3. Measurement(dBμV) = Reading(dBμV) + C.F (Correction Factor).

EUT	ACCESS POINT	Date of Test	2022-01-06
Factor	CE_ENV216-N (Filter OFF)_2021	Temp. / Humidity	20.3°C /43.5%
Polarity	Neutral	Site / Test Engineer	SR2 / Eric Lin
Test Mode	Transmit by BLE at channel 2440MHz -1Mbps	Test Voltage	120V/60Hz



No	Frequency (MHz)	Reading (dBμV)	C.F (dB)	Measurement (dBμV)	Margin (dB)	Limit (dBμV)	Remark (QP/PK/AV)	
1	*	0.150	35.78	9.62	45.40	-20.60	66.00	QP
2		0.150	17.28	9.62	26.90	-29.10	56.00	Average
3		0.162	34.48	9.62	44.10	-21.26	65.36	QP
4		0.162	16.88	9.62	26.50	-28.86	55.36	Average
5		0.190	29.99	9.61	39.60	-24.44	64.04	QP
6		0.190	11.99	9.61	21.60	-32.44	54.04	Average
7		0.234	23.19	9.61	32.80	-29.51	62.31	QP
8		0.234	5.59	9.61	15.20	-37.11	52.31	Average
9		0.258	20.18	9.62	29.80	-31.70	61.50	QP
10		0.258	4.68	9.62	14.30	-37.20	51.50	Average
11		19.420	14.86	10.04	24.90	-35.10	60.00	QP
12		19.420	9.56	10.04	19.60	-30.40	50.00	Average

Note:

1. "*", means this data is the worst emission level.
2. C.F (Correction Factor) = LISN Factor (dB) + Cable Loss (dB).
3. Measurement(dBμV) = Reading(dBμV) + C.F (Correction Factor).

8. CONCLUSION

The data collected relate only the item(s) tested and show that the unit is compliance with Part 15C of the FCC Rules.

_____ The End _____

Appendix A - Test Setup Photograph

Refer to “2105TW0602-Test setup photo” file.

Appendix B - EUT Photograph

Refer to "2105TW0602-EUT photo" file.