

## HPE Aruba Networking AP-ANT-325 Antenna for Indoor Access Points



### Dual-polarized cabled tri-band 2-element medium gain directional panel antenna (RP-SMA) for indoor and outdoor use

The AP-ANT-325 antenna is a tri-band, 2-element, dual-polarized panel antenna with nominal 90° H x 90° V beamwidths and 5dBi peak gain. This antenna is well suited for indoor and outdoor sector coverage for Wi-Fi access in 2.4GHz, 5GHz and/or 6GHz concurrently.

The AP-ANT-325 can be mounted directly to a wall (or ceiling) using the supplied screws and anchors, or if more flexibility is needed it can be combined with the optional AP-ANT-MNT-U articulating wall/pole mount.

## Specifications

### Frequency bands, ranges and peak gains

- |          |                     |        |
|----------|---------------------|--------|
| - 2.4GHz | 2.400GHz – 2.500GHz | 6.1dBi |
| - 5GHz   | 4.900GHz – 5.900GHz | 6.1dBi |
| - 6GHz   | 6.000GHz – 7.150GHz | 5.4dBi |

### Polarization

- Cross Pol (Ratio – 9:1)

### Pattern beamwidth (3dB)

- |           |                                    |                                  |
|-----------|------------------------------------|----------------------------------|
| - 2.4 GHz | Elevation (V): Approximately 79.1° | Azimuth (H): Approximately 79.3° |
| - 5.0 GHz | Elevation (V): Approximately 78.5° | Azimuth (H): Approximately 83.2° |
| - 6.0 GHz | Elevation (V): Approximately 78.0° | Azimuth (H): Approximately 80.3° |

### Input impedance

- 50 Ohms

### Maximum input power

- 33dBm (2 Watts) per port

### VSWR

- < 2:1

### Port isolation

- 2.4 GHz            20 dB
- 5 GHz              25 dB
- 6 GHz              23 dB

### Dimensions

- 200mm (W) x 200 mm (L) x 46.5 mm(H) (antenna itself)
- 250mm (W) x 220 mm (L) x 58 mm (H) (as it ships)

### Weight

- 0.4 kg (antenna itself)
- 0.6 kg (as it ships)

### Radome

- Material: ASA, Luran S 788T, UV
- Color: White

### Fly cable length & type / connector

- 75±0.8 cm Plenum Rated RG58LL/ RP-SMA-Male (x2)



### Operating temperature range and relative humidity

- -40°C to 65°C            10% to 95% RH

### Water and dust protection (IP rating)

- IP67

### Wind speed

- Up to 136 mph

### Lightning protection

- N/A

### Installation hardware

- There are two mounting options:
  - o Wall mounting hardware kit is included
  - o The antenna is also equipped with 4 x M5x0.8-6H for Articulating bracket option.

### Shipping content

- Antenna, mounting hardware and instruction manual included in unit carton

## Antenna patterns (averaged for both antenna elements)

Horizontal (azimuth) plane (top view) & Vertical (elevation) plane (side view)

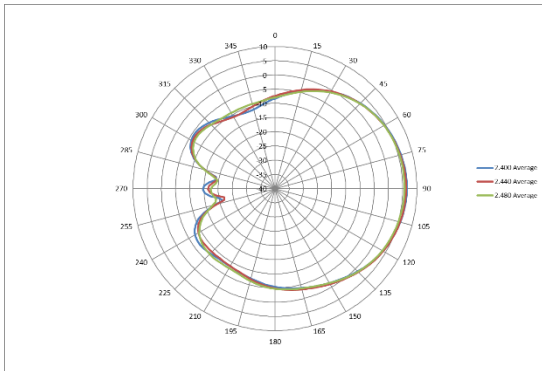

2.4GHz antenna patterns (horizontal)

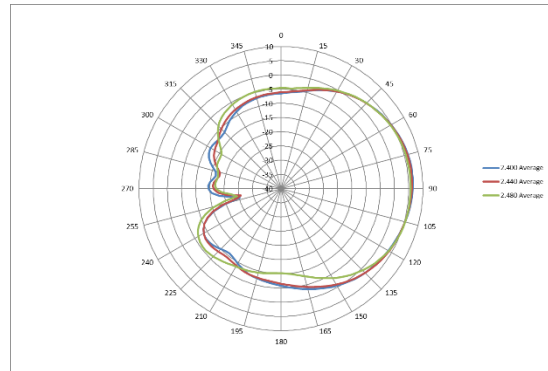

2.4GHz antenna patterns (vertical)

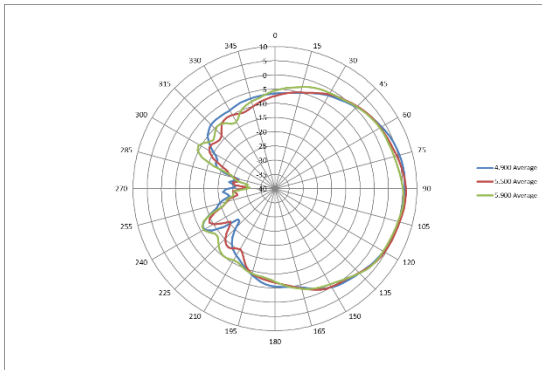

5GHz antenna patterns (horizontal)

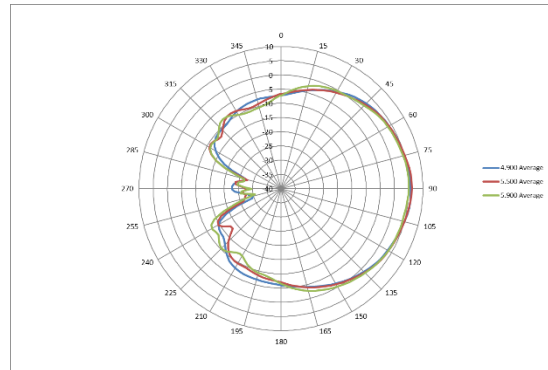

5GHz antenna patterns (vertical)

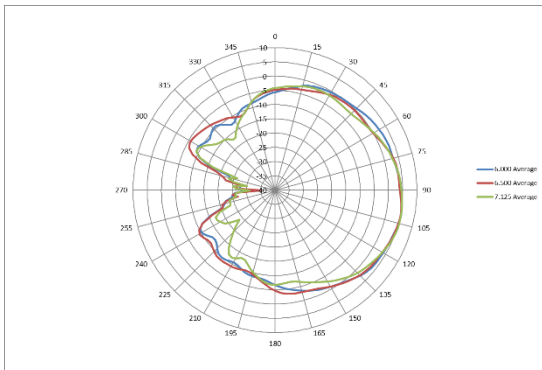

6GHz antenna patterns (horizontal)

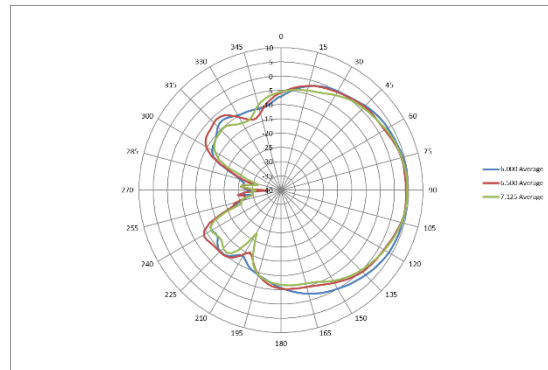

6GHz antenna patterns (vertical)

## Mechanical details

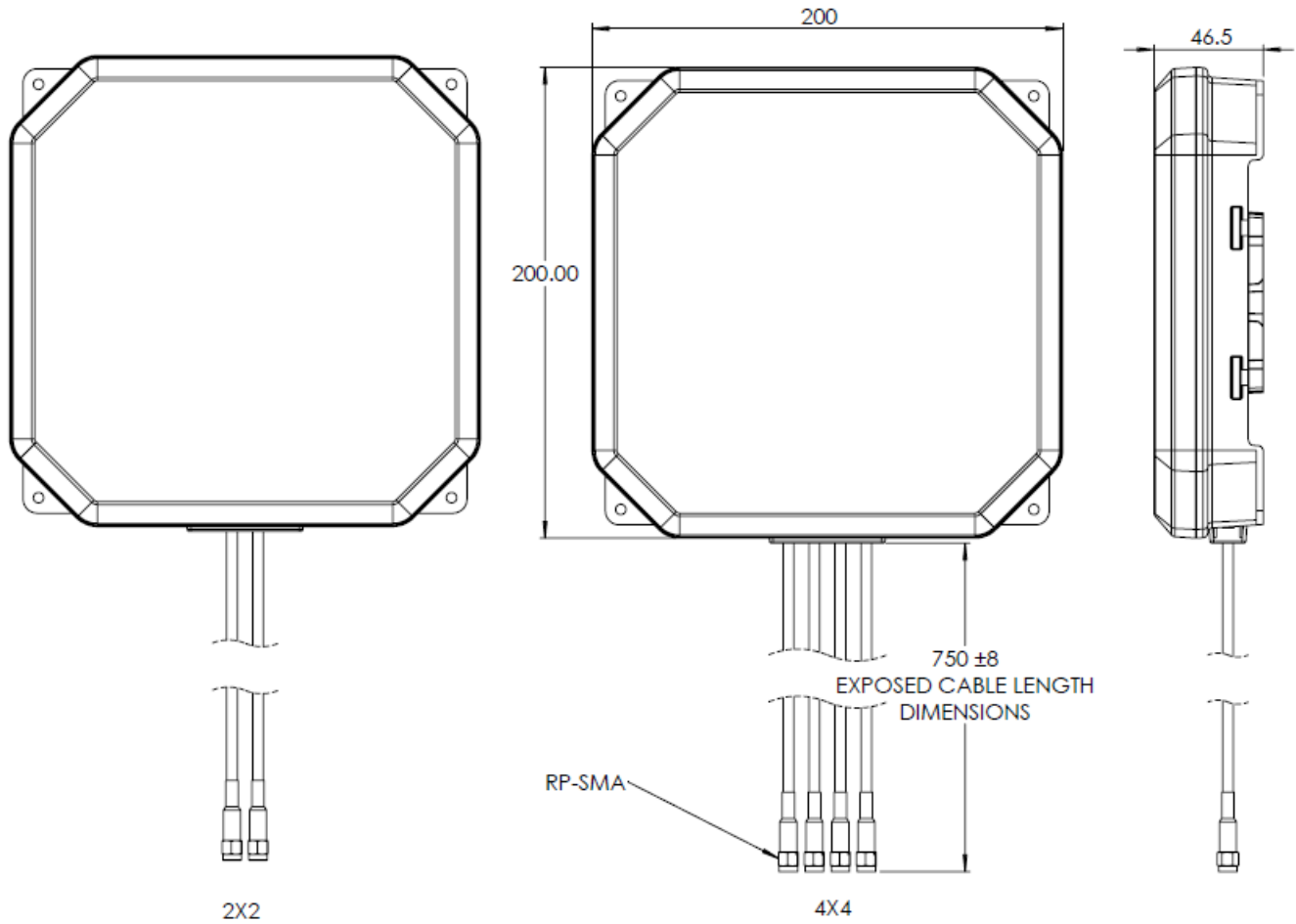

## Ordering information

Part number	Description
<b>HPE Aruba Networking Antennas for Indoor Access Points (RP-SMA)</b>	
<b>S1F86A</b>	HPE Aruba Networking AP-ANT-325 Cabled RP-SMA Tri-Band 2x2 Medium Gain Directional Panel Antenna