

Company: Aruba Networks, Inc.

Test of: APIN0334, APIN0335 Wireless Access Point

To: FCC Part 15.247 (DTS) & IC RSS-247

Report No.: ARUB196-U16 Rev A Bluetooth BLE

TEST REPORT





Test of: Aruba Networks, Inc. APIN0334, APIN0335

to

To: FCC CFR 47 Part 15 Subpart C 15.247 (DTS) & IC RSS-247

Test Report Serial No.: ARUB196-U16 Rev A Bluetooth BLE

Note: this report contains data with regard to 2400-2483.5 MHz Bluetooth BLE operational mode of the Aruba Networks APIN0334 and APIN0335 Wireless Access Point. Additional 802.11 modes for this product are reported in the following MiCOM Labs test reports 2400-2483.5 MHz ARUB196-U3, UNII-1 & UNII-3 ARUB196-U7 and UNII-2A and UNII-2C (DFS Bands) ARUB196-U10.

This report supersedes: NONE

Applicant: Aruba Networks, Inc.
1344 Crossman Ave.
Sunnyvale California 94089
USA

Product Function: Wireless access point

Issue Date: 5th May 2016

This Test Report is Issued Under the Authority of:

MiCOM Labs, Inc.
575 Boulder Court
Pleasanton California 94566
USA
Phone: +1 (925) 462-0304
Fax: +1 (925) 462-0306
www.micomlabs.com



MiCOM Labs is an ISO 17025 Accredited Testing Laboratory



Table of Contents

1. ACCREDITATION, LISTINGS & RECOGNITION	4
1.1. TESTING ACCREDITATION.....	4
1.2. RECOGNITION	5
1.3. PRODUCT CERTIFICATION	6
2. DOCUMENT HISTORY	7
3. TEST RESULT CERTIFICATE	8
4. REFERENCES AND MEASUREMENT UNCERTAINTY	9
4.1. Normative References	9
4.2. Test and Uncertainty Procedure	10
5. PRODUCT DETAILS AND TEST CONFIGURATIONS	11
5.1. Technical Details	11
5.2. Scope Of Test Program	12
5.3. Equipment Model(s) and Serial Number(s)	15
5.4. Antenna Details	15
5.5. Cabling and I/O Ports	15
5.6. Test Configurations.....	15
5.7. Equipment Modifications	16
5.8. Deviations from the Test Standard	16
6. TEST SUMMARY	17
7. TEST EQUIPMENT CONFIGURATION(S)	18
7.1. Conducted	18
7.2. Radiated Emissions.....	20
8. MEASUREMENT AND PRESENTATION OF TEST DATA	22
9. TEST RESULTS	23
9.1. 6 dB & 99% Bandwidth	23
9.2. Conducted Output Power	25
9.3. Emissions	28
9.3.1. Conducted Spurious Emissions	28
9.3.2. Conducted Band-Edge Emissions	30
9.4. Power Spectral Density	32
9.5. Radiated Emissions	34
9.5.1. Radiated Spurious Emissions	37
9.5.1.1. Restricted Band Spurious Emissions	Error! Bookmark not defined.
9.5.1.2. Restricted Band-Edge Spurious Emissions	Error! Bookmark not defined.
A. APPENDIX - GRAPHICAL IMAGES	43
A.1. 6 dB & 99% Bandwidth	44
A.2. Conducted Output Power	47
A.3. Emissions	50
A.3.1. Conducted Spurious Emissions.....	50
A.3.2. Conducted Band-Edge Emissions.....	53
A.4. Power Spectral Density	55
A.5. Radiated Spurious Emissions	58
A.5.1. Restricted Band Emissions.....	58
A.5.2. Restricted Band-Edge Emissions	61

This test report may be reproduced in full only. The document may only be updated by MiCOM Labs personnel. All changes will be noted in the Document History section of the report.

1. ACCREDITATION, LISTINGS & RECOGNITION

1.1. Testing Accreditation

MiCOM Labs, Inc. is an accredited Electrical testing laboratory per the international standard ISO/IEC 17025:2005. The company is accredited by the American Association for Laboratory Accreditation (A2LA) www.a2la.org test laboratory number 2381.01. MiCOM Labs test schedule is available at the following URL; <http://www.a2la.org/scopepdf/2381-01.pdf>



This test report may be reproduced in full only. The document may only be updated by MiCOM Labs personnel. All changes will be noted in the Document History section of the report.



1.2. Recognition

MiCOM Labs, Inc has widely recognized wireless testing capabilities. Our international recognition includes Conformity Assessment Body designation by APEC MRA countries. MiCOM Labs test reports are accepted globally.

Country	Recognition Body	Status	Phase	Identification No.
USA	Federal Communications Commission (FCC)	TCB	-	US0159 Listing #: 102167
Canada	Industry Canada (IC)	FCB	APEC MRA 2	US0159 Listing #: 4143A-2 4143A-3
Japan	MIC (Ministry of Internal Affairs and Communication)	CAB	APEC MRA 2	RCB 210
	VCCI	--	--	A-0012
Europe	European Commission	NB	EU MRA	NB 2280
Australia	Australian Communications and Media Authority (ACMA)	CAB	APEC MRA 1	US0159
Hong Kong	Office of the Telecommunication Authority (OFTA)	CAB	APEC MRA 1	
Korea	Ministry of Information and Communication Radio Research Laboratory (RRL)	CAB	APEC MRA 1	
Singapore	Infocomm Development Authority (IDA)	CAB	APEC MRA 1	
Taiwan	National Communications Commission (NCC) Bureau of Standards, Metrology and Inspection (BSMI)	CAB	APEC MRA 1	
Vietnam	Ministry of Communication (MIC)	CAB	APEC MRA 1	

EU MRA – European Union Mutual Recognition Agreement.

NB – Notified Body

APEC MRA – Asia Pacific Economic Community Mutual Recognition Agreement. Recognition agreement under which test lab is accredited to regulatory standards of the APEC member countries.

Phase I - recognition for product testing

Phase II – recognition for both product testing and certification

1.3. Product Certification

MiCOM Labs, Inc. is an accredited Product Certification Body per the international standard ISO/IEC 17065:2012. The company is accredited by the American Association for Laboratory Accreditation (A2LA) www.a2la.org test laboratory number 2381.02. MiCOM Labs test schedule is available at the following URL; <http://www.a2la.org/scopepdf/2381-02.pdf>



Accredited Product Certification Body

A2LA has accredited

MICOM LABS

Pleasanton, CA

This product certification body is accredited in accordance with the recognized International Standard ISO/IEC 17065:2012 *Requirements for bodies certifying products, processes and services*. This accreditation demonstrates technical competence for a defined scope and the operation of a management system.



Presented this 4th day of February 2016.

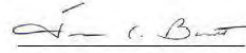

Senior Director of Quality & Communications
For the Accreditation Council
Certificate Number 2381.02
Valid to November 30, 2017

For the product certification schemes to which this accreditation applies, please refer to the organization's Product Certification Scope of Accreditation.

United States of America – Telecommunication Certification Body (TCB)
Industry Canada – Certification Body, CAB Identifier – US0159
Europe – Notified Body (NB), NB Identifier - 2280
Japan – Recognized Certification Body (RCB), RCB Identifier - 210

This test report may be reproduced in full only. The document may only be updated by MiCOM Labs personnel. All changes will be noted in the Document History section of the report.



Title: Aruba Networks, Inc AP-335
To: FCC Part 15.247 (DTS) & IC RSS-247
Serial #: ARUB196-U16 Rev A
Issue Date: 5th May 2016
Page: 7 of 63

2. DOCUMENT HISTORY

Document History		
Revision	Date	Comments
Draft	22 nd March 2016	
Rev A	5 th May 2016	Initial release

In the above table the latest report revision will replace all earlier versions.

This test report may be reproduced in full only. The document may only be updated by MiCOM Labs personnel. All changes will be noted in the Document History section of the report.



Title: Aruba Networks, Inc AP-335
To: FCC Part 15.247 (DTS) & IC RSS-247
Serial #: ARUB196-U16 Rev A
Issue Date: 5th May 2016
Page: 8 of 63

3. TEST RESULT CERTIFICATE

Manufacturer: Aruba Networks, Inc 1344 Crossman Ave. Sunnyvale California 94089 USA	Tested By: MiCOM Labs, Inc. 575 Boulder Court Pleasanton California 94566 USA
Model(s): APIN0334, APIN0335 - Bluetooth BLE	Telephone: +1 925 462 0304 Fax: +1 925 462 0306
Equipment Type: Wireless Access Point with Bluetooth BLE	
S/N's: DT0000447 DT0000334	
Test Date(s): 16 th February – 22 nd March 2016	Website: www.micomlabs.com

STANDARD(S)	TEST RESULTS
FCC CFR 47 Part 15 Subpart C 15.247 (DTS) & Industry Canada RSS-247	EQUIPMENT COMPLIES

MiCOM Labs, Inc. tested the equipment mentioned in accordance with the requirements set forth in the above standards. Test results indicate that the equipment tested is capable of demonstrating compliance with the requirements as documented within this report.

Notes:

1. This document reports conditions under which testing was conducted and the results of testing performed.
2. Details of test methods used have been recorded and kept on file by the laboratory.
3. Test results apply only to the item(s) tested.

Approved & Released for MiCOM Labs, Inc. by:



 Graeme Grieve
 Quality Manager MiCOM Labs, Inc.

 Gordon Hurst
 President & CEO MiCOM Labs, Inc.

This test report may be reproduced in full only. The document may only be updated by MiCOM Labs personnel. All changes will be noted in the Document History section of the report.

4. REFERENCES AND MEASUREMENT UNCERTAINTY

4.1. Normative References

REF.	PUBLICATION	YEAR	TITLE
I	KDB 662911	Oct 31 2013	Guidance for measurement of output emission of devices that employ single transmitter with multiple outputs or systems with multiple transmitters operating simultaneously in the same frequency band
II	KDB 558074 D01 v03r05	8 th April, 2016	Guidance for performing compliance measurements on Digital Transmission Systems (DTS) operating under section 15.247.
III	A2LA	February 2016	R105 - Requirement's When Making Reference to A2LA Accreditation Status
IV	ANSI C63.10	2013	American National Standard for Testing Unlicensed Wireless Devices
V	ANSI C63.4	2014	American National Standards for Methods of Measurement of Radio-Noise Emissions from Low-Voltage Electrical and Electronic Equipment in the Range of 9 kHz to 40 GHz
VI	CISPR 22	2008	Information technology equipment - Radio disturbance characteristics - Limits and methods of measurement
VII	ETSI TR 100 028	2001-12	Parts 1 and 2 Electromagnetic compatibility and Radio Spectrum Matters (ERM); Uncertainties in the measurement of mobile radio equipment characteristics
VIII	FCC 47 CFR Part 15.247	2014	Radio Frequency Devices; Subpart C – Intentional Radiators
IX	ICES-003	Issue 6 Jan 2012	Spectrum Management and Telecommunications; Interference-Causing Equipment Standard. Information Technology Equipment (Including Digital Apparatus) – Limits and methods of measurement.
X	M 3003	Edition 3 Nov. 2012	Expression of Uncertainty and Confidence in Measurements
XI	RSS-247 Issue 1	May 2015	Digital Transmission Systems (DTSs), Frequency Hopping System (FHSs) and Licence-Exempt Local Area Network (LE-LEN) Devices
XII	RSS-Gen Issue 4	November 2014	General Requirements and Information for the Certification of Radiocommunication Equipment
XIII	KDB 644545 D03 v01	August 14th 2014	Guidance for IEEE 802.11ac New Rules
XIV	FCC 47 CFR Part 2.1033	2014	FCC requirements and rules regarding photographs and test setup diagrams.

This test report may be reproduced in full only. The document may only be updated by MiCOM Labs personnel. All changes will be noted in the Document History section of the report.



Title: Aruba Networks, Inc AP-335
To: FCC Part 15.247 (DTS) & IC RSS-247
Serial #: ARUB196-U16 Rev A
Issue Date: 5th May 2016
Page: 10 of 63

4.2. Test and Uncertainty Procedure

Conducted and radiated emission measurements were conducted in accordance with American National Standards Institute ANSI C63.4, listed in the Normative References section of this report.

Measurement uncertainty figures are calculated in accordance with ETSI TR 100 028 Parts 1 and 2.

Measurement uncertainties stated are based on a standard uncertainty multiplied by a coverage factor $k = 2$, providing a level of confidence of approximately 95 % in accordance with UKAS document M 3003 listed in the Normative References section of this report.

This test report may be reproduced in full only. The document may only be updated by MiCOM Labs personnel. All changes will be noted in the Document History section of the report.



Title: Aruba Networks, Inc AP-335
To: FCC Part 15.247 (DTS) & IC RSS-247
Serial #: ARUB196-U16 Rev A
Issue Date: 5th May 2016
Page: 11 of 63

5. PRODUCT DETAILS AND TEST CONFIGURATIONS

5.1. Technical Details

Details	Description
Purpose:	Test of the Aruba Networks, Inc APIN0334 and APIN0335 to FCC CFR 47 Part 15 Subpart C 15.247 (DTS) and Industry Canada RSS-247
Applicant:	Aruba Networks, Inc 1344 Crossman Ave. Sunnyvale California 94089 USA
Manufacturer:	As Applicant
Laboratory performing the tests:	MiCOM Labs, Inc. 575 Boulder Court Pleasanton California 94566 USA
Test report reference number:	ARUB196-U16
Date EUT received:	16 th February 2016
Standard(s) applied:	FCC CFR 47 Part 15 Subpart C 15.247 (DTS) & Industry Canada RSS-247
Dates of test (from - to):	16 th February – 22 nd March 2016
No of Units Tested:	1
Type of Equipment:	802.11 wireless access point with Bluetooth BLE
Product Family Name:	Wireless Access Point
Model(s):	APIN0334, APIN0335
Location for use:	Indoor
Declared Frequency Range(s):	2400 - 2483.5 MHz;
Primary function of equipment:	Wireless access point
Secondary function of equipment:	Bluetooth connection
Type of Modulation:	GFSK
EUT Modes of Operation:	Bluetooth BLE
Transmit/Receive Operation:	Transceiver - Half Duplex
Rated Input Voltage and Current:	DC only (Battery operated / external supply) 48Vdc
Operating Temperature Range:	Declared Range 0°C to 40°C
ITU Emission Designator:	1M1G1D
Equipment Dimensions:	APIN0334: 225mm (W) x 224mm (D) x 52mm (H) /8.9" (W) x 8.9" (D) x 2.0" (H) APIN0335: 225mm (W) x 224mm (D) x 52mm (H) /8.9" (W) x 8.9" (D) x 2.0" (H)
Weight:	APIN0334: 1.146 kg APIN0335: 1.160 kg
Hardware Rev:	2
Software Rev:	SmartRF Studio 7 Version 2.0.0

This test report may be reproduced in full only. The document may only be updated by MiCOM Labs personnel. All changes will be noted in the Document History section of the report.

5.2. Scope Of Test Program

Aruba Networks, Inc APIN0335, APIN0335

The scope of the test program was to test the Aruba Networks, Inc APIN0334, APIN0335, 802.11 wireless access point with Bluetooth configurations in the frequency ranges 2400 - 2483.5 MHz; for compliance against the following Bluetooth BLE specification:

FCC CFR 47 Part 15 Subpart C 15.247 (DTS)

Radio Frequency Devices; Subpart C – Intentional Radiators

Industry Canada RSS-247

Digital Transmission Systems (DTSs), Frequency Hopping System (FHSs) and Licence-Exempt Local Area Network (LE-LEN) Devices

Product Family

Bluetooth BLE operates using an integral antenna – see Section 5.4 Antenna Details for antenna gain

Aruba Networks, Inc. APIN0334 External Antenna



This test report may be reproduced in full only. The document may only be updated by MiCOM Labs personnel. All changes will be noted in the Document History section of the report.

Aruba Networks, Inc. APIN0335 Integral Antenna



This test report may be reproduced in full only. The document may only be updated by MiCOM Labs personnel. All changes will be noted in the Document History section of the report.

Aruba Networks, Inc APIN0334 & APIN0335 (rear)



This test report may be reproduced in full only. The document may only be updated by MiCOM Labs personnel. All changes will be noted in the Document History section of the report.



5.3. Equipment Model(s) and Serial Number(s)

Type	Description	Manufacturer	Model	Serial no.	Delivery Date
EUT	WLAN Access Point - Bluetooth	Aruba Networks	APIN0334	DT0000447	16 th February 2016
EUT	WLAN Access Point - Bluetooth	Aruba Networks	APIN0335	DT0000334	16 th February 2016

5.4. Antenna Details

Type	Manufacturer	Model	Family	Gain (dBi)	BF Gain	Dir BW	X-Pol	Frequency Band (MHz)
APIN0335	Aruba Networks	Metal Sheet	OMNI	2.7	-	-	-	2400 - 2483.5
APIN0334	Aruba Networks	Metal Sheet	OMNI	5.1	-	-	-	2400 - 2483.5

BF Gain - Beamforming Gain
Dir BW - Directional BeamWidth
X-Pol - Cross Polarization

5.5. Cabling and I/O Ports

Port Type	Max Cable Length	# Of Ports	Screened	Conn Type	Data Type
Ethernet	100m	2	N	RJ-45	Packet Data
USB	5m	1	Y	USB	Digital

5.6. Test Configurations

Results for the following configurations are provided in this report:

Operational Mode(s)	Data Rate with Highest Power MBit/s	Channel Frequency (MHz)		
		Low	Mid	High
2400 - 2483.5 MHz				
BLE	-	2402	2442	2480



Title: Aruba Networks, Inc AP-335
To: FCC Part 15.247 (DTS) & IC RSS-247
Serial #: ARUB196-U16 Rev A
Issue Date: 5th May 2016
Page: 16 of 63

5.7. Equipment Modifications

The following modifications were required to bring the equipment into compliance:

1. NONE

5.8. Deviations from the Test Standard

The following deviations from the test standard were required in order to complete the test program:

1. NONE

This test report may be reproduced in full only. The document may only be updated by MiCOM Labs personnel. All changes will be noted in the Document History section of the report.



Title: Aruba Networks, Inc AP-335
To: FCC Part 15.247 (DTS) & IC RSS-247
Serial #: ARUB196-U16 Rev A
Issue Date: 5th May 2016
Page: 17 of 63

6. TEST SUMMARY

List of Measurements

Test Header	Result	Data Link
Conducted Testing		
15.247(a)(2) 6 dB & 99% Bandwidth	Complies	View Data
15.247(b), 15.31(e) Conducted Output Power	Complies	View Data
15.247(d) Emissions	Complies	-
(1) Conducted Emissions	Complies	-
(i) Conducted Spurious Emissions	Complies	View Data
(ii) Conducted Band-Edge Emissions	Complies	View Data
15.247(e) Power Spectral Density	Complies	View Data
Radiated Testing		
(i) 15.205 Radiated Spurious Emissions	Complies	View Data
(ii) 15.205 Radiated Spurious Band-Edge Emissions	Complies	View Data
Digital Emissions		
	See Report ARUB196-U26 Part 15B & ICES-003	
15.209 Digital Emissions	Complies	
AC Wireline Emissions		
	See Report ARUB196-U26 Part 15B & ICES-003	
15.207 AC Wireline Emissions	Complies	

This test report may be reproduced in full only. The document may only be updated by MiCOM Labs personnel. All changes will be noted in the Document History section of the report.

7. TEST EQUIPMENT CONFIGURATION(S)

7.1. Conducted

Conducted RF Emission Test Set-up(s)

The following tests were performed using the conducted test set-up shown in the diagram below.

1. 6 dB & 99% Bandwidth
2. Conducted Output Power
3. Power Spectral Density
4. Conducted Emissions (including Band-Edge)

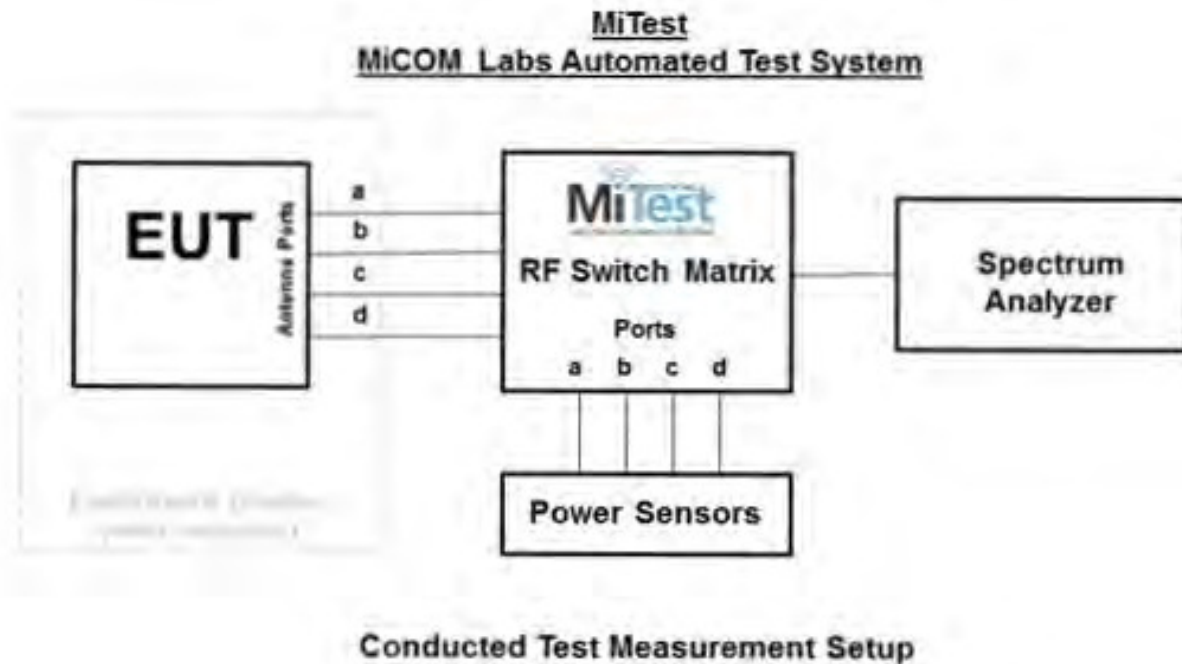

A full system calibration was performed on the test station and any resulting system losses (or gains) were taken into account in the production of all final measurement data.



Title: Aruba Networks, Inc AP-335
To: FCC Part 15.247 (DTS) & IC RSS-247
Serial #: ARUB196-U16 Rev A
Issue Date: 5th May 2016
Page: 19 of 63

Asset#	Description	Manufacturer	Model#	Serial#	Calibration Due Date
158	Barometer/Thermometer	Control Company	4196	E2846	01 Dec 2016
249	Resistance Thermometer	Thermotronics	GR2105-02	9340 #2	23 Oct 2016
287	Rohde & Schwarz 40 GHz Receiver	Rhode & Schwarz	ESIB40	100201	27 Aug 2016
361	Desktop for RF#1, Labview Software installed	Dell	Vostro 220	WS RF#1	Not Required
378	Rohde & Schwarz 40 GHz Receiver with Generator	Rhode & Schwarz	ESIB40	100107/040	04 Aug 2016
380	4x4 RF Switch Box	MiCOM Labs	MiTest RF Switch Box	MIC001	18 Jun 2016
390	USB Power Head 50MHz - 24GHz -60 to +20dBm	Agilent	U2002A	MY50000103	17 Oct 2016
398	Test Software	MiCOM	MiTest ATS	Version 3.0.0.16	Not Required
405	DC Power Supply 0-60V	Agilent	6654A	MY4001826	Cal when used
408	USB to GPIB interface	National Instruments	GPIB-USB HS	14C0DE9	Not Required
436	USB Wideband Power Sensor	Boonton	55006	8731	31 Jul 2016
437	USB Wideband Power Sensor	Boonton	55006	8759	31 Jul 2016
445	PoE Injector	D-Link	DPE-101GL	QTAH1E2000625	Not Required
461	Spectrum Analyzer	Agilent	E4440A	MY46185537	13 Aug 2016
75	Environmental Chamber	Thermatron	SE-300-2-2	27946	24 Nov 2016
RF#1 GPIB#1	GPIB cable to Power Supply	HP	GPIB	None	Not Required
RF#1 SMA SA #452	Precision SMA Male RG-402 Spectrun Analyzer	Fairview Microwave	Precision SMA Male RG 402 coax	None	18 Jun 2016
RF#1 SMA#1	EUT to Mitest box port 1	Flexco	SMA Cable port1	None	18 Jun 2016
RF#1 SMA#2	EUT to Mitest box port 2	Flexco	SMA Cable port2	None	18 Jun 2016
RF#1 SMA#3	EUT to Mitest box port 3	Flexco	SMA Cable port3	None	18 Jun 2016
RF#1 SMA#4	EUT to Mitest box port 4	Flexco	SMA Cable port4	None	18 Jun 2016
RF#1 USB#1	USB Cable to Mitest Box	Dynex	USB Cable	None	Not Required

This test report may be reproduced in full only. The document may only be updated by MiCOM Labs personnel. All changes will be noted in the Document History section of the report.

7.2. Radiated Spurious Emissions

The following tests were performed using the radiated test set-up shown in the diagram below.

1. Radiated Spurious and Band-Edge Emissions

Radiated Emission Measurement Setup Pictorial Representation

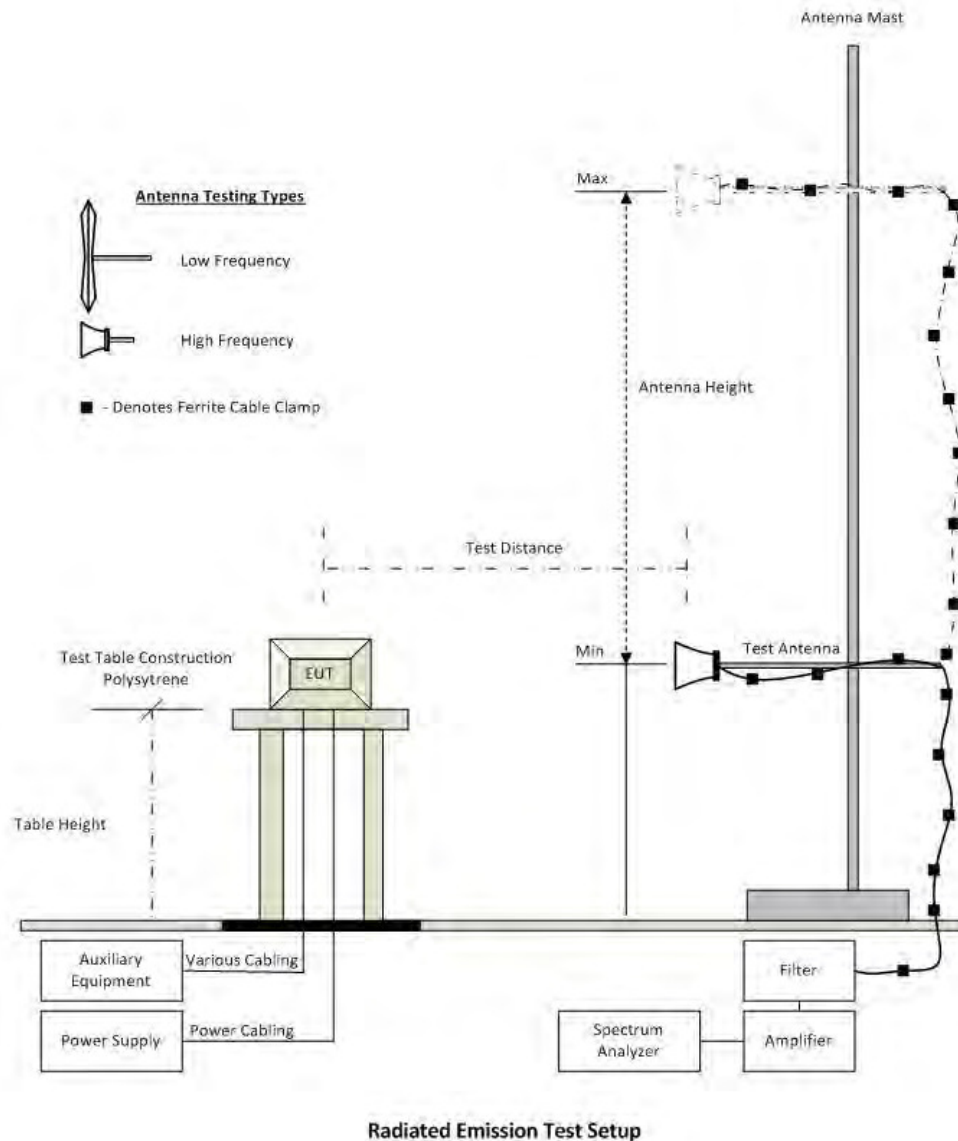

A full system calibration was performed on the test station and any resulting system losses (or gains) were taken into account in the production of all final measurement data.

This test report may be reproduced in full only. The document may only be updated by MiCOM Labs personnel. All changes will be noted in the Document History section of the report.



Title: Aruba Networks, Inc AP-335
To: FCC Part 15.247 (DTS) & IC RSS-247
Serial #: ARUB196-U16 Rev A
Issue Date: 5th May 2016
Page: 21 of 63

Asset#	Description	Manufacturer	Model#	Serial#	Calibration Due Date
158	Barometer/Thermometer	Control Company	4196	E2846	04 Dec 2016
170	Video System Controller for Semi Anechoic Chamber	Panasonic	WV-CY101	04R08507	Not Required
287	Rohde & Schwarz 40 GHz Receiver	Rhode & Schwarz	ESIB40	100201	27 Aug 2016
338	Sunol 30 to 3000 MHz Antenna	Sunol	JB3	A052907	15 Aug 2016
396	2.4 GHz Notch Filter	Microtronics	BRM50701	001	18 Aug 2016
397	Amp 10 - 2500MHz	MiCOM Labs	Amp 10 - 2500 MHz	NA	24 Feb 2016
399	ETS 1-18 GHz Horn Antenna	ETS	3117	00154575	18 th Oct 2016
406	Amplifier for Radiated Emissions	MiCOM Labs	40dB 1 to 18GHz Amp	0406	28 May 2016
410	Desktop Computer	Dell	Inspiron 620	WS38	Not Required
411	Mast/Turtable Controller	Sunol Sciences	SC98V	060199-1D	Not Required
412	USB to GPIB Interface	National Instruments	GPIB-USB HS	11B8DC2	Not Required
413	Mast Controller	Sunol Science	TWR95-4	030801-3	Not Required
415	Turtable Controller	Sunol Sciences	Turtable Controller	None	Not Required
447	Rad Emissions Test Software	MiCOM	Rad Emissions Test Software Version 1.0.73	447	Not Required
462	Schwarzbeck cable from Antenna to Amplifier.	Schwarzbeck	AK 9513	462	25 Feb 2016
463	Schwarzbeck cable from Amplifier to Bulkhead.	Schwarzbeck	AK 9513	463	25 Feb 2016
464	Schwarzbeck cable from Bulkhead to Receiver	Schwarzbeck	AK 9513	464	25 Feb 2016
465	Low Pass Filter DC-1000 MHz	Mini-Circuits	NLP-1200+	VUU01901402	18 Aug 2016
480	Cable - Bulkhead to Amp	SRC Haverhill	157-157-3050360	480	11 Aug 2016
481	Cable - Bulkhead to Receiver	SRC Haverhill	151-151-3050787	481	11 Aug 2016
482	Cable - Amp to Antenna	SRC Haverhill	157-157-3051574	482	11 Aug 2016

This test report may be reproduced in full only. The document may only be updated by MiCOM Labs personnel. All changes will be noted in the Document History section of the report.

8. MEASUREMENT AND PRESENTATION OF TEST DATA

The measurement and graphical data presented in this test report was generated automatically using state-of-the-art technology creating an easy to read report structure. Numerical measurement data is separated from supporting graphical data (plots) through hyperlinks. Numerical measurement data can be reviewed without scrolling through numerous graphical pages to arrive at the next data matrix.

Plots have been relegated into the Appendix 'Graphical Data'.

Test and report automation was performed by [MiTest](#). [MiTest](#) is an automated test system developed by MiCOM Labs. [MiTest](#) is the first cloud based modular test system enabling end-to-end automation of regulatory compliance testing for conducted RF testing.



The MiCOM Labs "[MiTest](#)" Automated Test System" (Patent Pending)

This test report may be reproduced in full only. The document may only be updated by MiCOM Labs personnel. All changes will be noted in the Document History section of the report.



9. TEST RESULTS

9.1. 6 dB & 99% Bandwidth

Conducted Test Conditions for 6 dB and 99% Bandwidth			
Standard:	FCC CFR 47:15.247	Ambient Temp. (°C):	24.0 - 27.5
Test Heading:	6 dB and 99 % Bandwidth	Rel. Humidity (%):	32 - 45
Standard Section(s):	15.247 (a)(2)	Pressure (mBars):	999 - 1001
Reference Document(s):	See Normative References		

Test Procedure for 6 dB and 99% Bandwidth Measurement
The bandwidth at 6 dB and 99 % was measured with a spectrum analyzer connected to the antenna terminal, while EUT is operating in transmission mode at the appropriate center frequency.

Testing was performed under ambient conditions at nominal voltage. Where the device operated with multiple antenna ports i.e. MIMO device, each port was measured and reported.

Test configuration and setup used for the measurement was per the Conducted Test Set-up specified in this document.

Limits for 6 dB and 99% Bandwidth
(a) Operation under the provisions of this Section is limited to frequency hopping and digitally modulated intentional radiators that comply with the following provisions:
(2) Systems using digital modulation techniques may operate in the 902-928 MHz and 2400-2483.5 MHz bands. The minimum 6 dB bandwidth shall be at least 500 kHz.

This test report may be reproduced in full only. The document may only be updated by MiCOM Labs personnel. All changes will be noted in the Document History section of the report.



Title: Aruba Networks, Inc AP-335
To: FCC Part 15.247 (DTS) & IC RSS-247
Serial #: ARUB196-U16 Rev A
Issue Date: 5th May 2016
Page: 24 of 63

Equipment Configuration for 6 dB & 99% Bandwidth

Variant:	DTS	Duty Cycle (%):	99
Data Rate:	Not Applicable	Antenna Gain (dBi):	2.7
Modulation:	FHSS	Beam Forming Gain (Y)(dB):	Not Applicable
TPC:	Not Applicable	Tested By:	SB
Engineering Test Notes:			

Test Measurement Results

Test Frequency	Measured 6 dB Bandwidth (MHz)				6 dB Bandwidth (MHz)		Limit	Lowest Margin
	Port(s)				Highest	Lowest		
	MHz	a	b	c			d	KHz
2402.0	0.705	--	--	--	0.705	0.705	≥500.0	-0.20
2442.0	0.705	--	--	--	0.705	0.705	≥500.0	-0.20
2480.0	0.697	--	--	--	0.697	0.697	≥500.0	-0.20

Test Frequency	Measured 99% Bandwidth (MHz)				Maximum 99% Bandwidth (MHz)		
	Port(s)						
	MHz	a	b	c	d		
2402.0	1.098	--	--	--	1.098		
2442.0	1.082	--	--	--	1.082		
2480.0	1.082	--	--	--	1.082		

Traceability to Industry Recognized Test Methodologies

Work Instruction:	WI-03 MEASURING RF SPECTRUM MASK
Measurement Uncertainty:	±2.81 dB

Note: click the links in the above matrix to view the graphical image (plot).

This test report may be reproduced in full only. The document may only be updated by MiCOM Labs personnel. All changes will be noted in the Document History section of the report.



9.2. Conducted Output Power

Conducted Test Conditions for Fundamental Emission Output Power			
Standard:	FCC CFR 47:15.247	Ambient Temp. (°C):	24.0 - 27.5
Test Heading:	Output Power	Rel. Humidity (%):	32 - 45
Standard Section(s):	15.247 (b) & (c)	Pressure (mBars):	999 - 1001
Reference Document(s):	See Normative References		
<p>Test Procedure for Fundamental Emission Output Power Measurement In the case of average power measurements an average power sensor was utilized.</p> <p>For peak power measurements the spectrum analyzer built-in power function was used to integrate peak power over the 20 dB bandwidth.</p> <p>Testing was performed under ambient conditions at nominal voltage only. Where the device operated with multiple antenna ports i.e. MIMO device, each port was measured, summed (Σ) and reported.</p> <p>Test configuration and setup used for the measurement was per the Conducted Test Set-up specified in this document.</p> <p>Supporting Information Calculated Power = $A + G + Y + 10 \log (1/x)$ dBm</p> <p>A = Total Power [$10 * \text{Log}_{10} (10^{a/10} + 10^{b/10} + 10^{c/10} + 10^{d/10})$] G = Antenna Gain Y = Beamforming Gain x = Duty Cycle (average power measurements only)</p> <p>Limits for Fundamental Emission Output Power (b) The maximum peak conducted output power of the intentional radiator shall not exceed the following for non-frequency hopping systems:</p> <p>(3) For systems using digital modulation in the 902-928 MHz and 2400-2483.5 MHz bands: 1 Watt. As an alternative to a peak power measurement, compliance with the one Watt limit can be based on a measurement of the maximum conducted output power. Maximum Conducted Output Power is defined as the total transmit power delivered to all antennas and antenna elements averaged across all symbols in the signaling alphabet when the transmitter is operating at its maximum power control level. Power must be summed across all antennas and antenna elements. The average must not include any time intervals during which the transmitter is off or is transmitting at a reduced power level. If multiple modes of operation are possible (e.g., alternative modulation methods), the maximum conducted output power is the highest total transmit power occurring in any mode.</p> <p>(4) The conducted output power limit specified in paragraph (b) of this section is based on the use of antennas with directional gains that do not exceed 6 dBi. Except as shown in paragraph (c) of this section, if transmitting antennas of directional gain greater than 6 dBi are used, the conducted output power from the intentional radiator shall be reduced below the stated values in paragraphs (b)(3) of this section, as appropriate, by the amount in dB that the directional gain of the antenna exceeds 6 dBi.</p> <p>(c) Operation with directional antenna gains greater than 6 dBi. (1) Fixed point-to-point operation: (i) Systems operating in the 2400-2483.5 MHz band that are used exclusively for fixed, point-to-point operations may employ transmitting antennas with directional gain greater than 6 dBi provided the maximum conducted output power of the intentional radiator is reduced by 1 dB for every 3 dB that the directional gain of the antenna exceeds 6 dBi.</p> <p>(iii) Fixed, point-to-point operation, as used in paragraphs (c)(1)(i) and (c)(1)(ii) of this section, excludes the use of point-to-multipoint systems, omnidirectional applications, and multiple co-located intentional radiators transmitting the same information. The operator of the spread spectrum or digitally modulated intentional radiator or, if the equipment is professionally installed, the installer is responsible for ensuring that the system is used exclusively for fixed, point-to-point</p>			

This test report may be reproduced in full only. The document may only be updated by MiCOM Labs personnel. All changes will be noted in the Document History section of the report.



Title: Aruba Networks, Inc AP-335
To: FCC Part 15.247 (DTS) & IC RSS-247
Serial #: ARUB196-U16 Rev A
Issue Date: 5th May 2016
Page: 26 of 63

operations. The instruction manual furnished with the intentional radiator shall contain language in the installation instructions informing the operator and the installer of this responsibility.

(2) In addition to the provisions in paragraphs (b)(3), (b)(4) and (c)(1)(i) of this section, transmitters operating in the 2400-2483.5 MHz band that emit multiple directional beams, simultaneously or sequentially, for the purpose of directing signals to individual receivers or to groups of receivers provided the emissions comply with the following:

(i) Different information must be transmitted to each receiver.

(ii) If the transmitter employs an antenna system that emits multiple directional beams but does not do emit multiple directional beams simultaneously, the total output power conducted to the array or arrays that comprise the device, i.e., the sum of the power supplied to all antennas, antenna elements, staves, etc. and summed across all carriers or frequency channels, shall not exceed the limit specified in paragraph (b)(1) or (b)(3) of this section, as applicable. However, the total conducted output power shall be reduced by 1 dB below the specified limits for each 3 dB that the directional gain of the antenna/antenna array exceeds 6 dBi. The directional antenna gain shall be computed as follows:

(A) The directional gain shall be calculated as the sum of 10 log (number of array elements or staves) plus the directional gain of the element or stave having the highest gain.

(B) A lower value for the directional gain than that calculated in paragraph (c)(2)(ii)(A) of this section will be accepted if sufficient evidence is presented, e.g., due to shading of the array or coherence loss in the beamforming.

(iii) If a transmitter employs an antenna that operates simultaneously on multiple directional beams using the same or different frequency channels, the power supplied to each emission beam is subject to the power limit specified in paragraph (c)(2)(ii) of this section. If transmitted beams overlap, the power shall be reduced to ensure that their aggregate power does not exceed the limit specified in paragraph (c)(2)(ii) of this section. In addition, the aggregate power transmitted simultaneously on all beams shall not exceed the limit specified in paragraph (c)(2)(ii) of this section by more than 8 dB.

(iv) Transmitters that emit a single directional beam shall operate under the provisions of paragraph (c)(1) of this section.

This test report may be reproduced in full only. The document may only be updated by MiCOM Labs personnel. All changes will be noted in the Document History section of the report.



Title: Aruba Networks, Inc AP-335
To: FCC Part 15.247 (DTS) & IC RSS-247
Serial #: ARUB196-U16 Rev A
Issue Date: 5th May 2016
Page: 27 of 63

Equipment Configuration for Peak Output Power

Variant:	DTS	Duty Cycle (%):	99.0
Data Rate:	Not Applicable	Antenna Gain (dBi):	2.7
Modulation:	FHSS	Beam Forming Gain (Y)(dB):	Not Applicable
TPC:	Not Applicable	Tested By:	SB
Engineering Test Notes:			

Test Measurement Results

Test Frequency	Measured Output Power + DCCF (+0.04 dB) (dBm)				Calculated Total Power Σ Port(s)	Limit	Margin	EUT Power Setting
	Port(s)							
MHz	a	b	c	d	dBm	dBm	dB	
2402.0	4.46	--	--	--	4.46	30.00	-25.54	4.00
2442.0	3.81	--	--	--	3.81	30.00	-26.19	4.00
2480.0	3.47	--	--	--	3.47	30.00	-26.53	4.00

Traceability to Industry Recognized Test Methodologies

Work Instruction:	WI-01 MEASURING RF OUTPUT POWER
Measurement Uncertainty:	± 1.33 dB

DCCF - Duty Cycle Correction Factor

This test report may be reproduced in full only. The document may only be updated by MiCOM Labs personnel. All changes will be noted in the Document History section of the report.



Title: Aruba Networks, Inc AP-335
To: FCC Part 15.247 (DTS) & IC RSS-247
Serial #: ARUB196-U16 Rev A
Issue Date: 5th May 2016
Page: 28 of 63

9.3. Conducted Spurious Emissions

9.3.1. Conducted Spurious Emissions

Conducted Test Conditions for Transmitter Conducted Spurious and Band-Edge Emissions			
Standard:	FCC CFR 47:15.247	Ambient Temp. (°C):	24.0 - 27.5
Test Heading:	Max Unwanted Emission Levels	Rel. Humidity (%):	32 - 45
Standard Section(s):	15.247 (d)	Pressure (mBars):	999 - 1001
Reference Document(s):	See Normative References		

Test Procedure for Transmitter Conducted Spurious and Band-Edge Emissions Measurement

Transmitter Conducted Spurious and Band-Edge emissions were measured at a limit of 30 dBc (average detector) or 20 dBc (peak detector) below the highest in-band spectral density measured with a spectrum analyzer connected to the antenna terminal. Measurements were made while EUT was operating in transmit mode of operation at the appropriate centre frequency closest to the band-edge. Emissions were maximized during the measurement and limits derived from the peak spectral power and drawn on each plot.

Where the device operated with multiple antenna ports i.e. MIMO device, each port was measured separately. Testing was performed under ambient conditions at nominal voltage only.

Test configuration and setup used for the measurement was per the Conducted Test Set-up specified in this document.

Limits Transmitter Conducted Spurious and Band-Edge Emissions

(d) In any 100 kHz bandwidth outside the frequency band in which the spread spectrum or digitally modulated intentional radiator is operating, the radio frequency power that is produced by the intentional radiator shall be at least 20 dB below that in the 100 kHz bandwidth within the band that contains the highest level of the desired power, based on either an RF conducted or a radiated measurement, provided the transmitter demonstrates compliance with the peak conducted power limits. If the transmitter complies with the conducted power limits based on the use of RMS averaging over a time interval, as permitted under paragraph (b)(3) of this section, the attenuation required under this paragraph shall be 30 dB instead of 20 dB. Attenuation below the general limits specified in §15.209(a) is not required. In addition, radiated emissions which fall in the restricted bands, as defined in §15.205(a), must also comply with the radiated emission limits specified in §15.209(a) (see §15.205(c)).

This test report may be reproduced in full only. The document may only be updated by MiCOM Labs personnel. All changes will be noted in the Document History section of the report.



Title: Aruba Networks, Inc AP-335
To: FCC Part 15.247 (DTS) & IC RSS-247
Serial #: ARUB196-U16 Rev A
Issue Date: 5th May 2016
Page: 29 of 63

Equipment Configuration for Transmitter Conducted Spurious Emissions

Variant:	DTS	Duty Cycle (%):	99
Data Rate:	Not Applicable	Antenna Gain (dBi):	2.7
Modulation:	FHSS	Beam Forming Gain (Y):	Not Applicable
TPC:	Not Applicable	Tested By:	SB
Engineering Test Notes:			

Test Measurement Results

Test Frequency	Frequency Range	Transmitter Conducted Spurious Emissions (dBm)							
		Port a		Port b		Port c		Port d	
		SE	Limit	SE	Limit	SE	Limit	SE	Limit
2402.0	30.0 - 26000.0	-48.920	-18.00	--	--	--	--	--	--
2442.0	30.0 - 26000.0	-51.550	-18.00	--	--	--	--	--	--
2480.0	30.0 - 26000.0	-53.900	-19.00	--	--	--	--	--	--

Traceability to Industry Recognized Test Methodologies

Work Instruction:	WI-05 MEASUREMENT OF SPURIOUS EMISSIONS
Measurement Uncertainty:	<=40 GHz ±2.37 dB, > 40 GHz ±4.6 dB

Note: click the links in the above matrix to view the graphical image (plot).

This test report may be reproduced in full only. The document may only be updated by MiCOM Labs personnel. All changes will be noted in the Document History section of the report.



Title: Aruba Networks, Inc AP-335
To: FCC Part 15.247 (DTS) & IC RSS-247
Serial #: ARUB196-U16 Rev A
Issue Date: 5th May 2016
Page: 30 of 63

9.3.2. Conducted Band-Edge Emissions

Equipment Configuration for Conducted Low Band-Edge Emissions - Peak

Variant:	DTS	Duty Cycle (%):	99.0
Data Rate:	Not Applicable	Antenna Gain (dBi):	2.7
Modulation:	FHSS	Beam Forming Gain (Y)(dB):	Not Applicable
TPC:	Not Applicable	Tested By:	SB
Engineering Test Notes:			

Test Measurement Results

Channel Frequency:	2402.0 MHz					
Band-Edge Frequency:	2400.0 MHz					
Test Frequency Range:	2350.0 - 2422.0 MHz					
Port(s)	Band-Edge Markers and Limit			Revised Limit		Margin
	M1 Amplitude (dBm)	Plot Limit (dBm)	M2 Frequency (MHz)	Amplitude (dBm)	M2A Frequency (MHz)	(MHz)
a	-32.91	-17.00	2401.20	--	--	-1.200

Traceability to Industry Recognized Test Methodologies

Work Instruction:	WI-05 MEASUREMENT OF SPURIOUS EMISSIONS
Measurement Uncertainty:	<=40 GHz ±2.37 dB, > 40 GHz ±4.6 dB

Note: click the links in the above matrix to view the graphical image (plot).

This test report may be reproduced in full only. The document may only be updated by MiCOM Labs personnel. All changes will be noted in the Document History section of the report.



Title: Aruba Networks, Inc AP-335
To: FCC Part 15.247 (DTS) & IC RSS-247
Serial #: ARUB196-U16 Rev A
Issue Date: 5th May 2016
Page: 31 of 63

Equipment Configuration for Conducted High Band-Edge Emissions - Peak			
Variant:	DTS	Duty Cycle (%):	99.0
Data Rate:	Not Applicable	Antenna Gain (dBi):	2.7
Modulation:	FHSS	Beam Forming Gain (Y)(dB):	Not Applicable
TPC:	Not Applicable	Tested By:	SB
Engineering Test Notes:			

Test Measurement Results

Channel Frequency:	2480.0 MHz					
Band-Edge Frequency:	2483.5 MHz					
Test Frequency Range:	2452.0 - 2524.0 MHz					
Port(s)	Band-Edge Markers and Limit			Revised Limit		Margin
	M3 Amplitude (dBm)	Plot Limit (dBm)	M2 Frequency (MHz)	Amplitude (dBm)	M2A Frequency (MHz)	(MHz)
a	-49.92	-17.00	2480.60	--	--	-2.900

Traceability to Industry Recognized Test Methodologies	
Work Instruction:	WI-05 MEASUREMENT OF SPURIOUS EMISSIONS
Measurement Uncertainty:	<=40 GHz ±2.37 dB, > 40 GHz ±4.6 dB

Note: click the links in the above matrix to view the graphical image (plot).

This test report may be reproduced in full only. The document may only be updated by MiCOM Labs personnel. All changes will be noted in the Document History section of the report.



9.4. Power Spectral Density

Conducted Test Conditions for Power Spectral Density			
Standard:	FCC CFR 47:15.247	Ambient Temp. (°C):	24.0 - 27.5
Test Heading:	Power Spectral Density	Rel. Humidity (%):	32 - 45
Standard Section(s):	15.247 (e)	Pressure (mBars):	999 - 1001
Reference Document(s):	See Normative References		

Test Procedure for Power Spectral Density

The transmitter output was connected to a spectrum analyzer and the measured made in a 3 kHz resolution bandwidth using the analyzer auto-coupled sweep-time. A peak value was found over the full emission bandwidth and the spectrum downloaded for post processing purposes.

Where the device operated with multiple antenna ports i.e. MIMO device, each port was measured separately. The Peak Power Spectral Density is the highest level found across the emission bandwidth. With multiple antenna port measurements the numerical analyzer data from each port is summed (à) and a link to this additional graphic is provided.

Testing was performed under ambient conditions at nominal voltage only.

Test configuration and setup used for the measurement was per the Conducted Test Set-up specified in this document.

Measure and sum the spectra across the outputs. With this technique, spectra are measured at each output of the device at the required resolution bandwidth. The individual spectra are then summed mathematically in linear power units. Unlike in-band power measurements, in which the sum involves a single measured value (output power) from each output, measurements for compliance with PSD limits involve summing entire spectra across corresponding frequency bins on the various outputs. Consistency is maintained for any device with multiple transmitter outputs to be certain the individual outputs are all aligned with the same span and same number of points. In this instance, the linear power spectrum value within the first spectral bin of output 0 is summed with that in the first spectral bin of output 1, and the first spectral bin of output 2, and so on up to the Nth output to obtain the true value for the first frequency bin of the summed spectrum. The summed spectrum value for each frequency bin is computed in this fashion. These summed spectral values were post processed and the resulting numerical and graphical data presented.

NOTE:

It may be observed that the spectrum in some antenna port plots break the limit line however this in itself does NOT constitute a failure. In all cases a spectrum summation plot is provided in order to prove compliance. A failure occurs only after the summation of all spectrum plots have been summed and are found to be greater than the limit line.

Supporting Information

Calculated Power = $A + 10 \log (1/x)$ dBm

A = Total Power Spectral Density [$10 \log_{10} (10^{a/10} + 10^{b/10} + 10^{c/10} + 10^{d/10})$]

x = Duty Cycle

Limits Power Spectral Density

For digitally modulated systems, the power spectral density conducted from the intentional radiator to the antenna shall not be greater than +8 dBm in any 3 kHz band during any time interval of continuous transmission. This power spectral density shall be determined in accordance with the provisions of paragraph (b) of this section. The same method of determining the conducted output power shall be used to determine the power spectral density.



Title: Aruba Networks, Inc AP-335
To: FCC Part 15.247 (DTS) & IC RSS-247
Serial #: ARUB196-U16 Rev A
Issue Date: 5th May 2016
Page: 33 of 63

Equipment Configuration for Power Spectral Density - Peak

Variant:	DTS	Duty Cycle (%):	99.0
Data Rate:	Not Applicable	Antenna Gain (dBi):	2.7
Modulation:	FHSS	Beam Forming Gain (Y)(dB):	Not Applicable
TPC:	Not Applicable	Tested By:	SB
Engineering Test Notes:			

Test Measurement Results							
Test Frequency	Measured Power Spectral Density				Amplitude Summation	Limit	Margin
	Port(s) (dBm/3KHz)						
MHz	a	b	c	d	dBm/3KHz	dBm/3KHz	dB
2402.0	-9.018	--	--	--	Not Applicable	8.0	-17.0
2442.0	-11.081	--	--	--	Not Applicable	8.0	-19.1
2480.0	-10.271	--	--	--	Not Applicable	8.0	-18.3

Traceability to Industry Recognized Test Methodologies	
Work Instruction:	WI-03 MEASURING RF SPECTRUM MASK
Measurement Uncertainty:	±2.81 dB

Note: click the links in the above matrix to view the graphical image (plot).

This test report may be reproduced in full only. The document may only be updated by MiCOM Labs personnel. All changes will be noted in the Document History section of the report.



9.5. Radiated Emissions

Radiated Test Conditions for Radiated Spurious and Band-Edge Emissions (Restricted Bands)			
Standard:	FCC CFR 47 Part 15 Subpart C 15.247 (DTS)	Ambient Temp. (°C):	20.0 - 24.5
Test Heading:	Radiated Spurious and Band-Edge Emissions	Rel. Humidity (%):	32 - 45
Standard Section(s):	15.205, 15.209	Pressure (mBars):	999 - 1001
Reference Document(s):	See Normative References		

Test Procedure for Radiated Spurious and Band-Edge Emissions (Restricted Bands)

Radiated emissions for restricted bands above 1 GHz are measured in the anechoic chamber at a 3-meter distance on every azimuth in both horizontal and vertical polarities. The emissions are recorded and maximized as a function of azimuth by rotation through 360° with a spectrum analyzer in peak hold mode. Depending on the frequency band spanned a notch filter and waveguide filter was used to remove the fundamental frequency. The highest emissions relative to the limit are listed for each frequency spanned. Measurements on any restricted band frequency or frequencies above 1 GHz are based on the use of measurement instrumentation employing peak and average detectors. All measurements were performed using a resolution bandwidth of 1 MHz.

Test configuration and setup for Radiated Spurious and Band-Edge Measurement were per the Radiated Test Set-up specified in this document.

Limits for Restricted Bands

Peak emission: 74 dBuV/m

Average emission: 54 dBuV/m

Field Strength Calculation

The field strength is calculated by adding the Antenna Factor and Cable Loss, and subtracting Amplifier Gain from the measured reading. All factors are included in the reported data.

$$FS = R + AF + CORR - FO$$

where:

FS = Field Strength

R = Measured Spectrum analyzer Input Amplitude

AF = Antenna Factor

CORR = Correction Factor = CL – AG + NFL

CL = Cable Loss

AG = Amplifier Gain

FO = Distance Falloff Factor

NFL = Notch Filter Loss or Waveguide Loss

Example:

Given receiver input reading of 51.5 dBmV; Antenna Factor of 8.5 dB; Cable Loss of 1.3 dB; Falloff Factor of 0 dB, an Amplifier Gain of 26 dB and Notch Filter Loss of 1 dB. The Field Strength (FS) of the measured emission is:

$$FS = 51.5 + 8.5 + 1.3 - 26.0 + 1 = 36.3 \text{ dBmV/m}$$

Conversion between dBmV/m (or dBmV) and mV/m (or mV) are as follows:

$$\text{Level (dBmV/m)} = 20 * \text{Log (level (mV/m))}$$

$$40 \text{ dBmV/m} = 100 \text{ mV/m}$$

$$48 \text{ dBmV/m} = 250 \text{ mV/m}$$

Restricted Bands of Operation (15.205)

(a) Except as shown in paragraph (d) of this section, only spurious emissions are permitted in any of the frequency bands listed below:



Frequency Band			
MHz	MHz	MHz	GHz
0.090-0.110	16.42-16.423	399.9-410	4.5-5.15
0.495-0.505	16.69475-16.69525	608-614	5.35-5.46
2.1735-2.1905	16.80425-16.80475	960-1240	7.25-7.75
4.125-4.128	25.5-25.67	1300-1427	8.025-8.5
4.17725-4.17775	37.5-38.25	1435-1626.5	9.0-9.2
4.20725-4.20775	73-74.6	1645.5-1646.5	9.3-9.5
6.215-6.218	74.8-75.2	1660-1710	10.6-12.7
6.26775-6.26825	108-121.94	1718.8-1722.2	13.25-13.4
6.31175-6.31225	123-138	2200-2300	14.47-14.5
8.291-8.294	149.9-150.05	2310-2390	15.35-16.2
8.362-8.366	156.52475-156.52525	2483.5-2500	17.7-21.4
8.37625-8.38675	156.7-156.9	2690-2900	22.01-23.12
8.41425-8.41475	162.0125-167.17	3260-3267	23.6-24.0
12.29-12.293	167.72-173.2	3332-3339	31.2-31.8
12.51975-12.52025	240-285	3345.8-3358	36.43-36.5
12.57675-12.57725	322-335.4	3600-4400	Above 38.6
13.36-13.41			

(b) Except as provided in paragraphs (d) and (e) of this section, the field strength of emissions appearing within these frequency bands shall not exceed the limits shown in §15.209. At frequencies equal to or less than 1000 MHz, compliance with the limits in §15.209 shall be demonstrated using measurement instrumentation employing a CISPR quasi-peak detector. Above 1000 MHz, compliance with the emission limits in §15.209 shall be demonstrated based on the average value of the measured emissions. The provisions in §15.35 apply to these measurements.

(c) Except as provided in paragraphs (d) and (e) of this section, regardless of the field strength limits specified elsewhere in this subpart, the provisions of this section apply to emissions from any intentional radiator.

(d) The following devices are exempt from the requirements of this section:

- (1) Swept frequency field disturbance sensors operating between 1.705 and 37 MHz provided their emissions only sweep through the bands listed in paragraph (a) of this section, the sweep is never stopped with the fundamental emission within the bands listed in paragraph (a) of this section, and the fundamental emission is outside of the bands listed in paragraph (a) of this section more than 99% of the time the device is actively transmitting, without compensation for duty cycle.
- (2) Transmitters used to detect buried electronic markers at 101.4 kHz which are employed by telephone companies.
- (3) Cable locating equipment operated pursuant to §15.213.
- (4) Any equipment operated under the provisions of §15.253, 15.255, and 15.256 in the frequency band 75-85 GHz, or §15.257 of this part.
- (5) Biomedical telemetry devices operating under the provisions of §15.242 of this part are not subject to the restricted band 608-614 MHz but are subject to compliance within the other restricted bands.
- (6) Transmitters operating under the provisions of subparts D or F of this part.

This test report may be reproduced in full only. The document may only be updated by MiCOM Labs personnel. All changes will be noted in the Document History section of the report.



Title: Aruba Networks, Inc AP-335
To: FCC Part 15.247 (DTS) & IC RSS-247
Serial #: ARUB196-U16 Rev A
Issue Date: 5th May 2016
Page: 36 of 63

(7) Devices operated pursuant to §15.225 are exempt from complying with this section for the 13.36-13.41 MHz band only.

(8) Devices operated in the 24.075-24.175 GHz band under §15.245 are exempt from complying with the requirements of this section for the 48.15-48.35 GHz and 72.225-72.525 GHz bands only, and shall not exceed the limits specified in §15.245(b).

(9) Devices operated in the 24.0-24.25 GHz band under §15.249 are exempt from complying with the requirements of this section for the 48.0-48.5 GHz and 72.0-72.75 GHz bands only, and shall not exceed the limits specified in §15.249(a).

(e) Harmonic emissions appearing in the restricted bands above 17.7 GHz from field disturbance sensors operating under the provisions of §15.245 shall not exceed the limits specified in §15.245(b).

This test report may be reproduced in full only. The document may only be updated by MiCOM Labs personnel. All changes will be noted in the Document History section of the report.



Title: Aruba Networks, Inc AP-335
To: FCC Part 15.247 (DTS) & IC RSS-247
Serial #: ARUB196-U16 Rev A
Issue Date: 5th May 2016
Page: 37 of 63

9.5.1. Restricted Band Spurious Emissions

Equipment Configuration for Radiated Spurious - Restricted Band Emissions

Antenna:	APIN0335 Antenna	Variant:	BLE
Antenna Gain (dBi):	2.70	Modulation:	GFSK
Beam Forming Gain (Y):	Not Applicable	Duty Cycle (%):	99
Channel Frequency (MHz):	2402.00	Data Rate:	Not Applicable
Power Setting:	4	Tested By:	SB

Test Measurement Results

Num	Frequency MHz	Raw dB μ V	Cable Loss	AF dB	Level dB μ V/m	Measurement Type	Pol	Hgt cm	Azt Deg	Limit dB μ V/m	Margin dB	Pass /Fail
#1	1397.64	36.66	2.26	-15.56	23.36	Max Avg	Vertical	100	202	54.0	-30.6	Pass
#2	1397.64	58.04	2.26	-15.56	44.74	Max Peak	Vertical	100	202	74.0	-29.3	Pass

This test report may be reproduced in full only. The document may only be updated by MiCOM Labs personnel. All changes will be noted in the Document History section of the report.



Title: Aruba Networks, Inc AP-335
To: FCC Part 15.247 (DTS) & IC RSS-247
Serial #: ARUB196-U16 Rev A
Issue Date: 5th May 2016
Page: 38 of 63

Equipment Configuration for Radiated Spurious - Restricted Band Emissions
--

Antenna:	APIN0335 Antenna	Variant:	BLE
Antenna Gain (dBi):	2.70	Modulation:	GFSK
Beam Forming Gain (Y):	Not Applicable	Duty Cycle (%):	99
Channel Frequency (MHz):	2442.00	Data Rate:	Not Applicable
Power Setting:	4	Tested By:	SB

Test Measurement Results

Click here to view measurement data...
--

This test report may be reproduced in full only. The document may only be updated by MiCOM Labs personnel. All changes will be noted in the Document History section of the report.



Title: Aruba Networks, Inc AP-335
To: FCC Part 15.247 (DTS) & IC RSS-247
Serial #: ARUB196-U16 Rev A
Issue Date: 5th May 2016
Page: 39 of 63

Equipment Configuration for Radiated Spurious - Restricted Band Emissions

Antenna:	APIN0335 Antenna	Variant:	BLE
Antenna Gain (dBi):	2.70	Modulation:	GFSK
Beam Forming Gain (Y):	Not Applicable	Duty Cycle (%):	99
Channel Frequency (MHz):	2480.00	Data Rate:	Not Applicable
Power Setting:	4	Tested By:	SB

Test Measurement Results

Num	Frequency MHz	Raw dBµV	Cable Loss	AF dB	Level dBµV/m	Measurement Type	Pol	Hgt cm	Azt Deg	Limit dBµV/m	Margin dB	Pass /Fail
#1	1791.95	53.28	2.46	-13.80	41.94	Peak (NRB)	Vertical	101	0	--	--	Pass
#2	1791.95	37.18	2.46	-13.80	25.84	Max Avg	Vertical	102	299	54.0	-28.2	Pass
#3	1791.95	62.72	2.46	-13.80	51.38	Max Peak	Vertical	102	299	74.0	-22.6	Pass

This test report may be reproduced in full only. The document may only be updated by MiCOM Labs personnel. All changes will be noted in the Document History section of the report.



Title: Aruba Networks, Inc AP-335
To: FCC Part 15.247 (DTS) & IC RSS-247
Serial #: ARUB196-U16 Rev A
Issue Date: 5th May 2016
Page: 40 of 63

9.5.2. Restricted Band-Edge Spurious Emissions

Aruba Networks Metal Sheet		Band-Edge Freq	Limit 54.0dB μ V/m	Limit 74.0dB μ V/m	Power Setting
Operational Mode	Operating Frequency (MHz)	MHz	dB μ V/m	dB μ V/m	
BLE	2402.00	2390.00	36.82	49.33	4
BLE	2480.00	2483.50	45.16	55.89	4

This test report may be reproduced in full only. The document may only be updated by MiCOM Labs personnel. All changes will be noted in the Document History section of the report.



Title: Aruba Networks, Inc AP-335
To: FCC Part 15.247 (DTS) & IC RSS-247
Serial #: ARUB196-U16 Rev A
Issue Date: 5th May 2016
Page: 41 of 63

Equipment Configuration for Radiated - Lower Restricted Band-Edge Emissions

Antenna:	APIN0335 Antenna	Variant:	BLE
Antenna Gain (dBi):	2.70	Modulation:	GFSK
Beam Forming Gain (Y):	Not Applicable	Duty Cycle (%):	99
Channel Frequency (MHz):	2402.00	Data Rate:	Not Applicable
Power Setting:	4	Tested By:	SB

Test Measurement Results

Num	Frequency MHz	Raw dBμV	Cable Loss	AF dB	Level dBμV/m	Measurement Type	Pol	Hgt cm	Azt Deg	Limit dBμV/m	Margin dB	Pass /Fail
#1	2338.08	2.43	2.69	31.70	36.82	Max Avg	Horizontal	159	13	54.0	-17.2	Pass
#2	2389.59	14.60	2.69	32.04	49.33	Max Peak	Horizontal	159	13	74.0	-24.7	Pass
#3	2390.00	--	--	--	--	Band-Edge	--	--	--	--	--	--

This test report may be reproduced in full only. The document may only be updated by MiCOM Labs personnel. All changes will be noted in the Document History section of the report.



Title: Aruba Networks, Inc AP-335
To: FCC Part 15.247 (DTS) & IC RSS-247
Serial #: ARUB196-U16 Rev A
Issue Date: 5th May 2016
Page: 42 of 63

Equipment Configuration for Radiated - Upper Restricted Band-Edge Emissions

Antenna:	Aruba Networks Metal Sheet	Variant:	BLE
Antenna Gain (dBi):	2.70	Modulation:	GFSK
Beam Forming Gain (Y):	Not Applicable	Duty Cycle (%):	99
Channel Frequency (MHz):	2480.00	Data Rate:	Not Applicable
Power Setting:	4	Tested By:	SB

Test Measurement Results

Num	Frequency MHz	Raw dB μ V	Cable Loss	AF dB	Level dB μ V/m	Measurement Type	Pol	Hgt cm	Azt Deg	Limit dB μ V/m	Margin dB	Pass /Fail
#1	2483.50	10.06	2.73	32.37	45.16	Max Avg	Horizontal	159	17	54.0	-8.8	Pass
#2	2483.50	20.79	2.73	32.37	55.89	Max Peak	Horizontal	159	17	74.0	-18.1	Pass
#3	2483.50	--	--	--	--	Band-Edge	--	--	--	--	--	--

This test report may be reproduced in full only. The document may only be updated by MiCOM Labs personnel. All changes will be noted in the Document History section of the report.



Title: Aruba Networks, Inc AP-335
To: FCC Part 15.247 (DTS) & IC RSS-247
Serial #: ARUB196-U16 Rev A
Issue Date: 5th May 2016
Page: 43 of 63

A. APPENDIX - GRAPHICAL IMAGES

This test report may be reproduced in full only. The document may only be updated by MiCOM Labs personnel. All changes will be noted in the Document History section of the report.



A.1. 6 dB & 99% Bandwidth



6 dB & 99% BANDWIDTH

Variant: DTS, Channel: 2402.00 MHz, Chain a, Temp: Ambient, Voltage: 48 Vdc

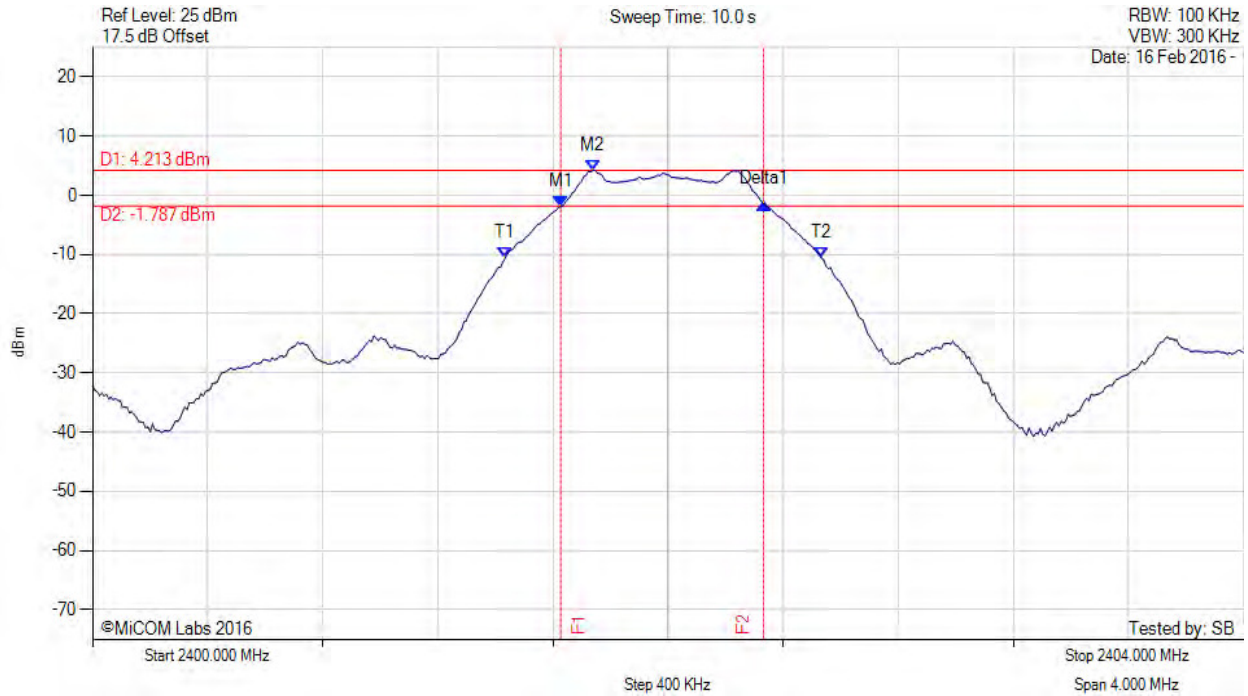

Analyzer Setup	Marker:Frequency:Amplitude	Test Results
Detector = MAX PEAK Sweep Count = 0 RF Atten (dB) = 20 Trace Mode = MAX HOLD	M1 : 2401.627 MHz : -1.953 dBm M2 : 2401.739 MHz : 4.213 dBm Delta1 : 705 KHz : 0.456 dB T1 : 2401.435 MHz : -10.513 dBm T2 : 2402.533 MHz : -10.572 dBm OBW : 1.098 MHz	Measured 6 dB Bandwidth: 0.705 MHz Limit: ≥ 500.0 kHz Margin: -0.20 MHz

[back to matrix](#)

This test report may be reproduced in full only. The document may only be updated by MiCOM Labs personnel. All changes will be noted in the Document History section of the report.



6 dB & 99% BANDWIDTH



Variant: DTS, Channel: 2442.00 MHz, Chain a, Temp: Ambient, Voltage: 48 Vdc

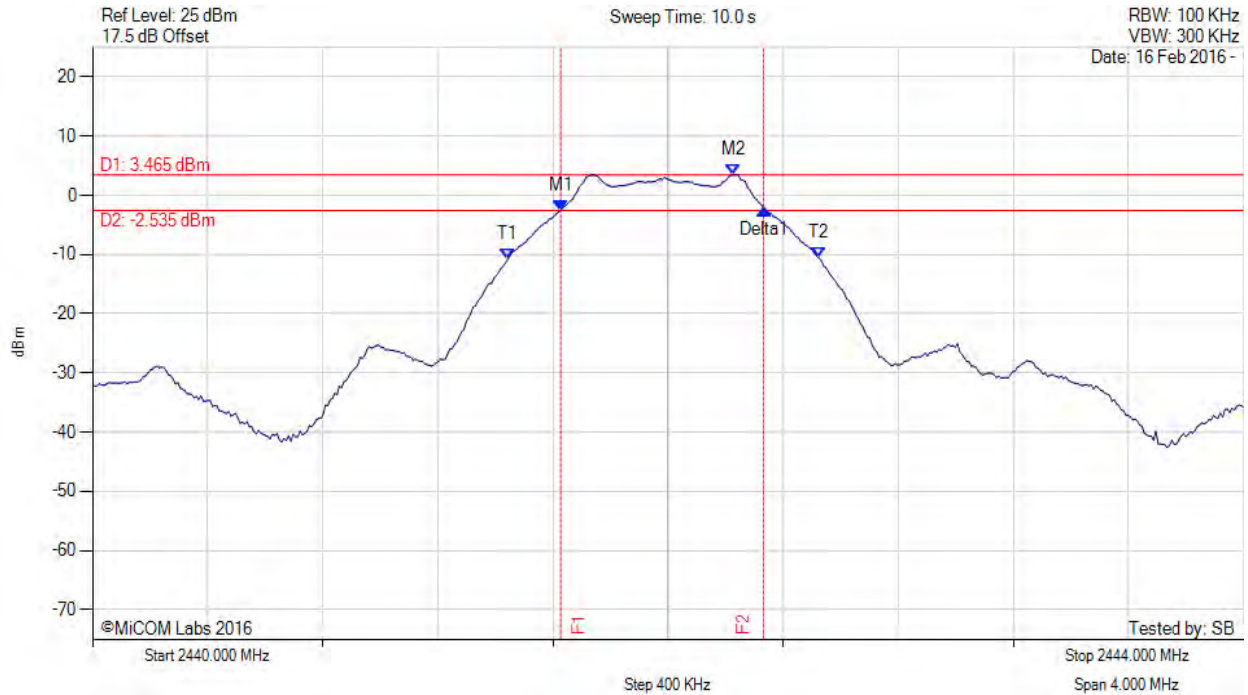

Analyzer Setup	Marker:Frequency:Amplitude	Test Results
Detector = MAX PEAK Sweep Count = 0 RF Atten (dB) = 20 Trace Mode = MAX HOLD	M1 : 2441.627 MHz : -2.553 dBm M2 : 2442.228 MHz : 3.465 dBm Delta1 : 705 KHz : 0.287 dB T1 : 2441.443 MHz : -10.818 dBm T2 : 2442.525 MHz : -10.619 dBm OBW : 1.082 MHz	Measured 6 dB Bandwidth: 0.705 MHz Limit: ≥500.0 kHz Margin: -0.20 MHz

[back to matrix](#)

This test report may be reproduced in full only. The document may only be updated by MiCOM Labs personnel. All changes will be noted in the Document History section of the report.



6 dB & 99% BANDWIDTH



Variant: DTS, Channel: 2480.00 MHz, Chain a, Temp: Ambient, Voltage: 48 Vdc

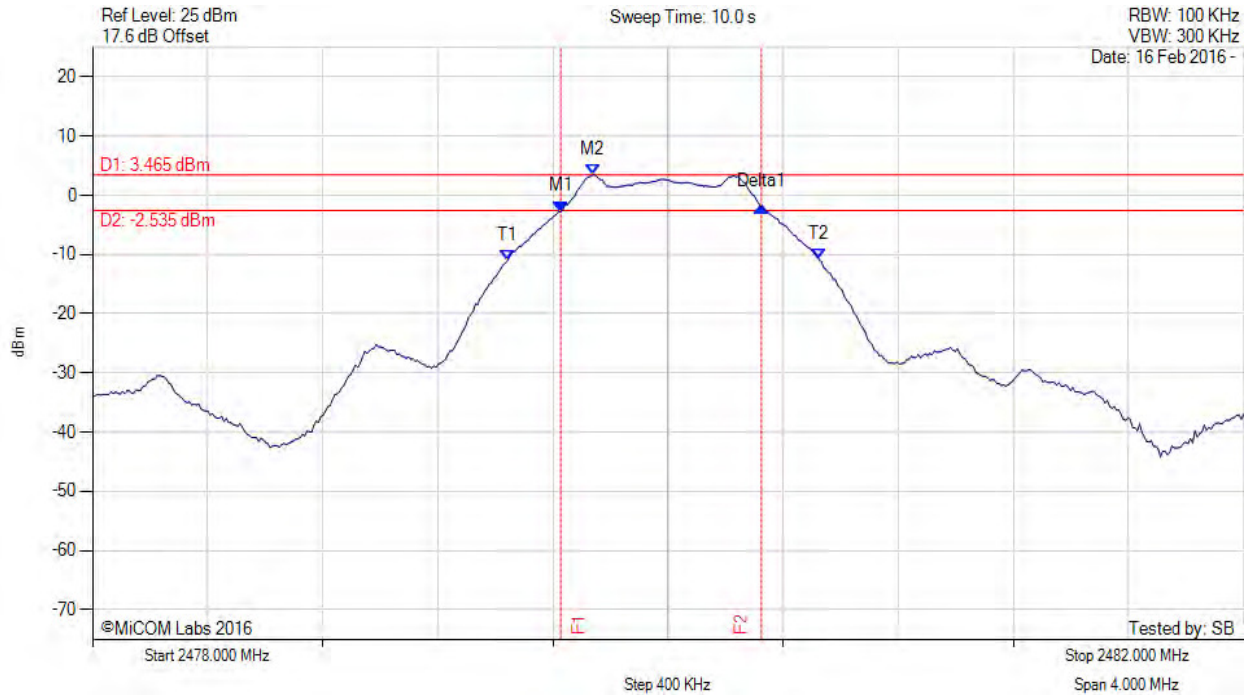

Analyzer Setup	Marker:Frequency:Amplitude	Test Results
Detector = MAX PEAK Sweep Count = 0 RF Atten (dB) = 20 Trace Mode = MAX HOLD	M1 : 2479.627 MHz : -2.722 dBm M2 : 2479.739 MHz : 3.465 dBm Delta1 : 697 KHz : 0.789 dB T1 : 2479.443 MHz : -10.967 dBm T2 : 2480.525 MHz : -10.849 dBm OBW : 1.082 MHz	Measured 6 dB Bandwidth: 0.697 MHz Limit: ≥500.0 kHz Margin: -0.20 MHz

[back to matrix](#)

This test report may be reproduced in full only. The document may only be updated by MiCOM Labs personnel. All changes will be noted in the Document History section of the report.



A.2. Conducted Output Power



PEAK OUTPUT POWER

Variant: DTS, Channel: 2402.00 MHz, Chain a, Temp: Ambient, Voltage: 48 Vdc

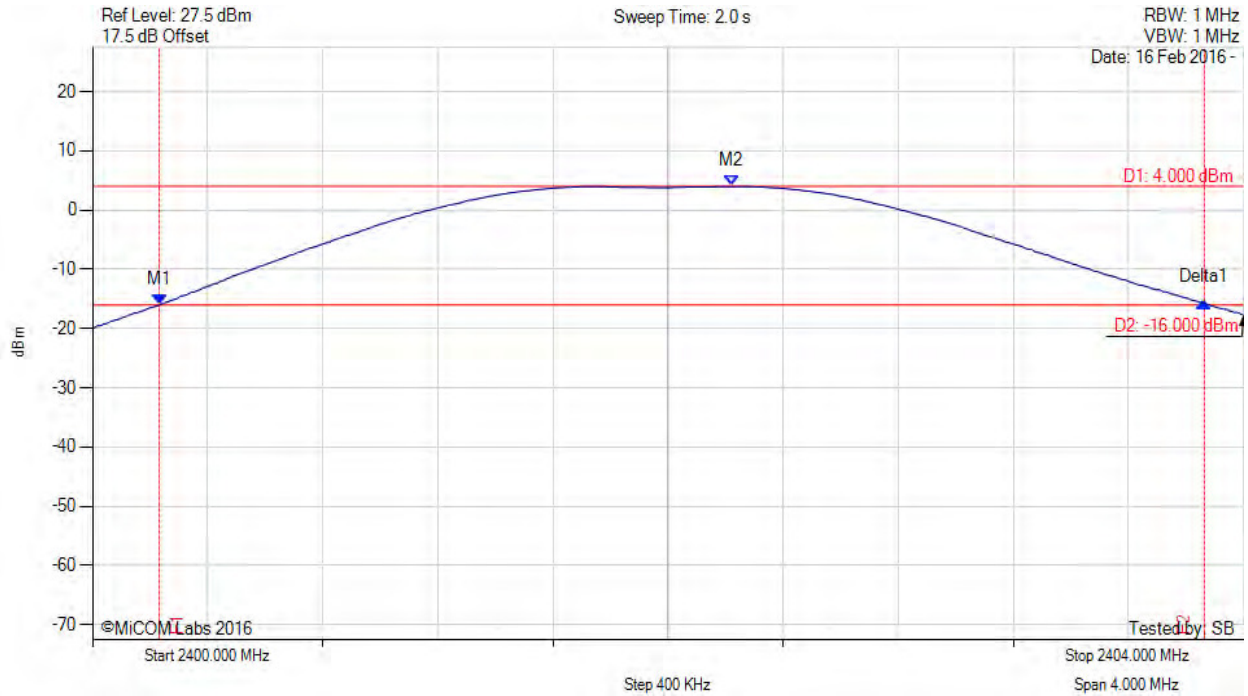

Analyzer Setup	Marker:Frequency:Amplitude	Test Results
Detector = MAX PEAK Sweep Count = 0 RF Atten (dB) = 20 Trace Mode = VIEW	M1 : 2400.232 MHz : -16.006 dBm M2 : 2402.220 MHz : 4.000 dBm Delta1 : 3.631 MHz : 0.399 dB	Channel Power: 4.46 dBm Limit: 30.00 dBm Margin: dB

[back to matrix](#)

This test report may be reproduced in full only. The document may only be updated by MiCOM Labs personnel. All changes will be noted in the Document History section of the report.



Title: Aruba Networks, Inc AP-335
To: FCC Part 15.247 (DTS) & IC RSS-247
Serial #: ARUB196-U16 Rev A
Issue Date: 5th May 2016
Page: 48 of 63

PEAK OUTPUT POWER



Variant: DTS, Channel: 2442.00 MHz, Chain a, Temp: Ambient, Voltage: 48 Vdc

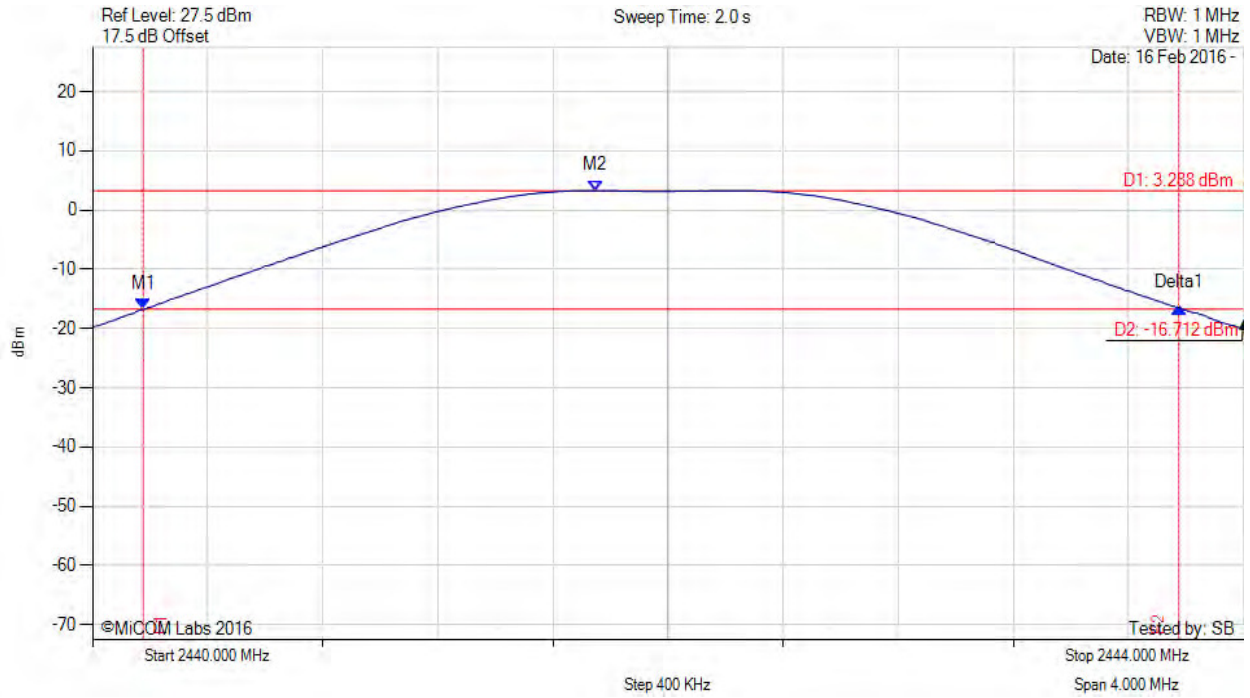

Analyzer Setup	Marker:Frequency:Amplitude	Test Results
Detector = MAX PEAK Sweep Count = 0 RF Atten (dB) = 20 Trace Mode = VIEW	M1 : 2440.176 MHz : -16.762 dBm M2 : 2441.747 MHz : 3.288 dBm Delta1 : 3.599 MHz : 0.226 dB	Channel Power: 3.81 dBm Limit: 30.00 dBm Margin: dB

[back to matrix](#)

This test report may be reproduced in full only. The document may only be updated by MiCOM Labs personnel. All changes will be noted in the Document History section of the report.



Title: Aruba Networks, Inc AP-335
To: FCC Part 15.247 (DTS) & IC RSS-247
Serial #: ARUB196-U16 Rev A
Issue Date: 5th May 2016
Page: 49 of 63

PEAK OUTPUT POWER



Variant: DTS, Channel: 2480.00 MHz, Chain a, Temp: Ambient, Voltage: 48 Vdc

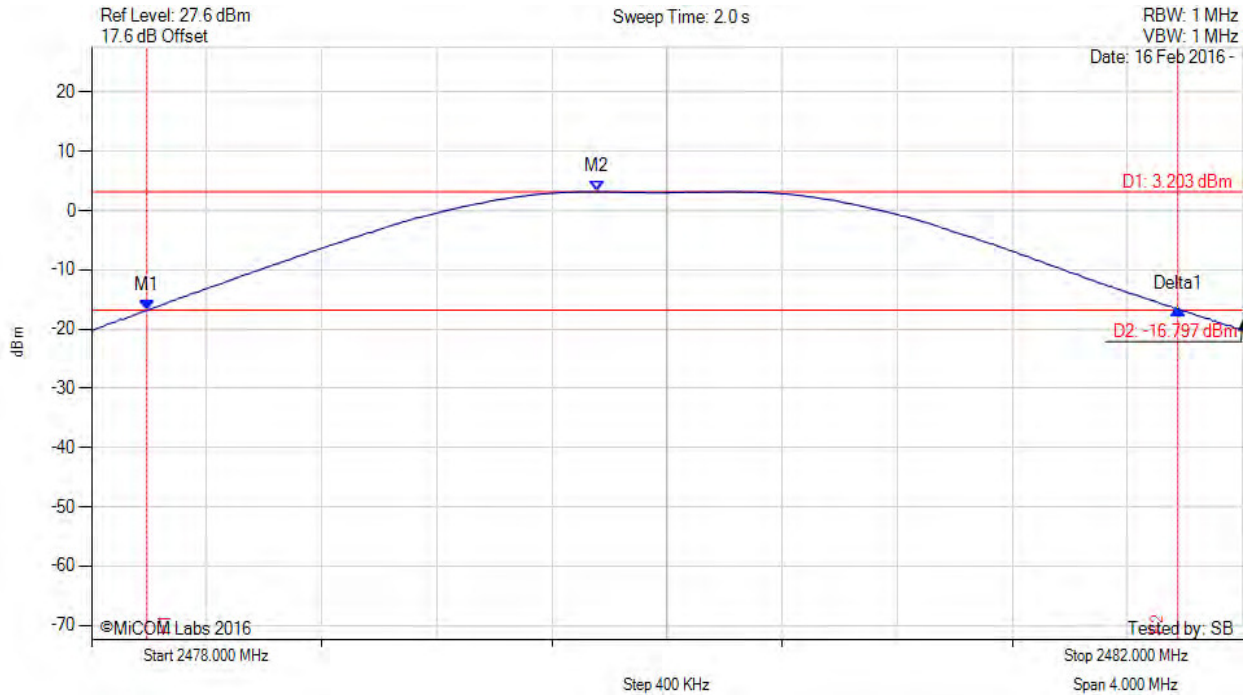

Analyzer Setup	Marker:Frequency:Amplitude	Test Results
Detector = MAX PEAK Sweep Count = 0 RF Atten (dB) = 20 Trace Mode = VIEW	M1 : 2478.192 MHz : -16.841 dBm M2 : 2479.756 MHz : 3.203 dBm Delta1 : 3.583 MHz : 0.262 dB	Channel Power: 3.47 dBm Limit: 30.00 dBm Margin: dB

[back to matrix](#)

This test report may be reproduced in full only. The document may only be updated by MiCOM Labs personnel. All changes will be noted in the Document History section of the report.



A.3. Emissions

A.3.1. Conducted Spurious Emissions

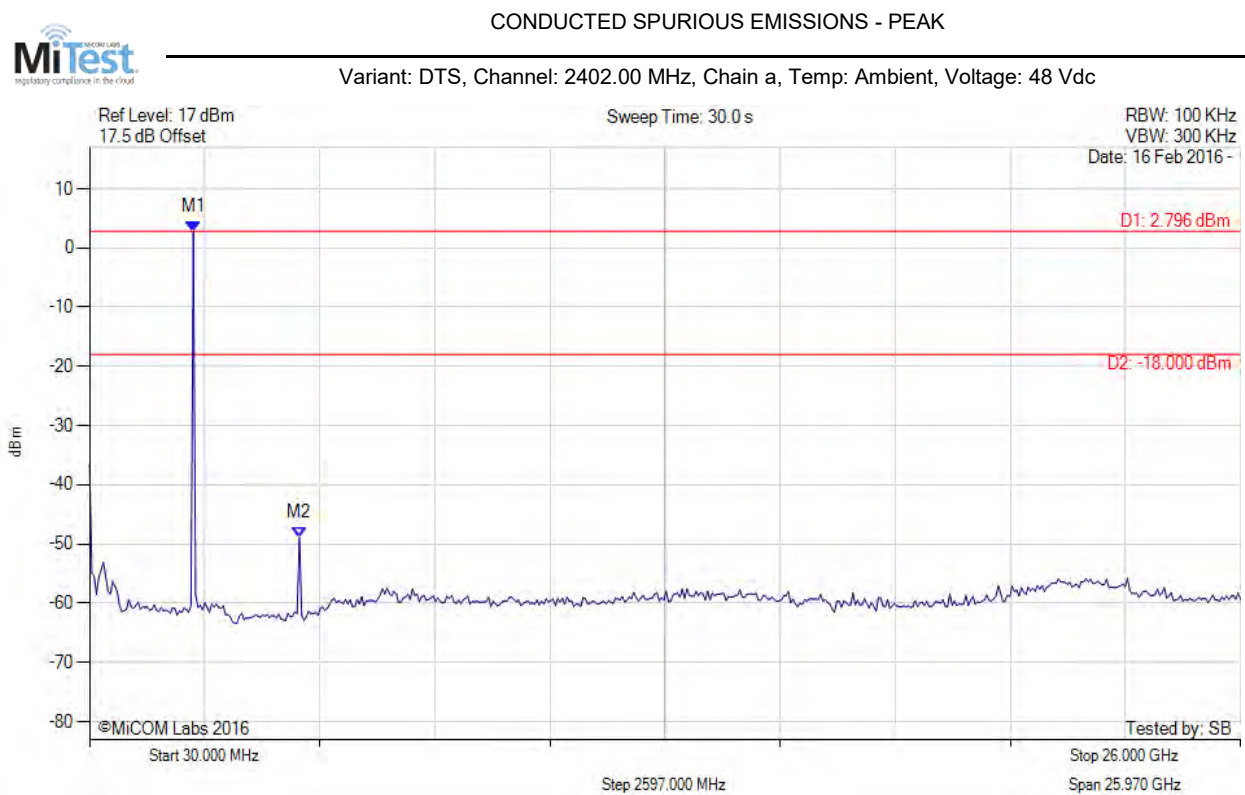

Analyzer Setup	Marker:Frequency:Amplitude	Test Results
Detector = MAX PEAK Sweep Count = 0 RF Atten (dB) = 10 Trace Mode = VIEW	M1 : 2371.984 MHz : 2.796 dBm M2 : 4766.012 MHz : -48.920 dBm	Limit: -18.00 dBm Margin: -30.92 dB

[back to matrix](#)

This test report may be reproduced in full only. The document may only be updated by MiCOM Labs personnel. All changes will be noted in the Document History section of the report.



Title: Aruba Networks, Inc AP-335
To: FCC Part 15.247 (DTS) & IC RSS-247
Serial #: ARUB196-U16 Rev A
Issue Date: 5th May 2016
Page: 51 of 63

CONDUCTED SPURIOUS EMISSIONS - PEAK



Variant: DTS, Channel: 2442.00 MHz, Chain a, Temp: Ambient, Voltage: 48 Vdc

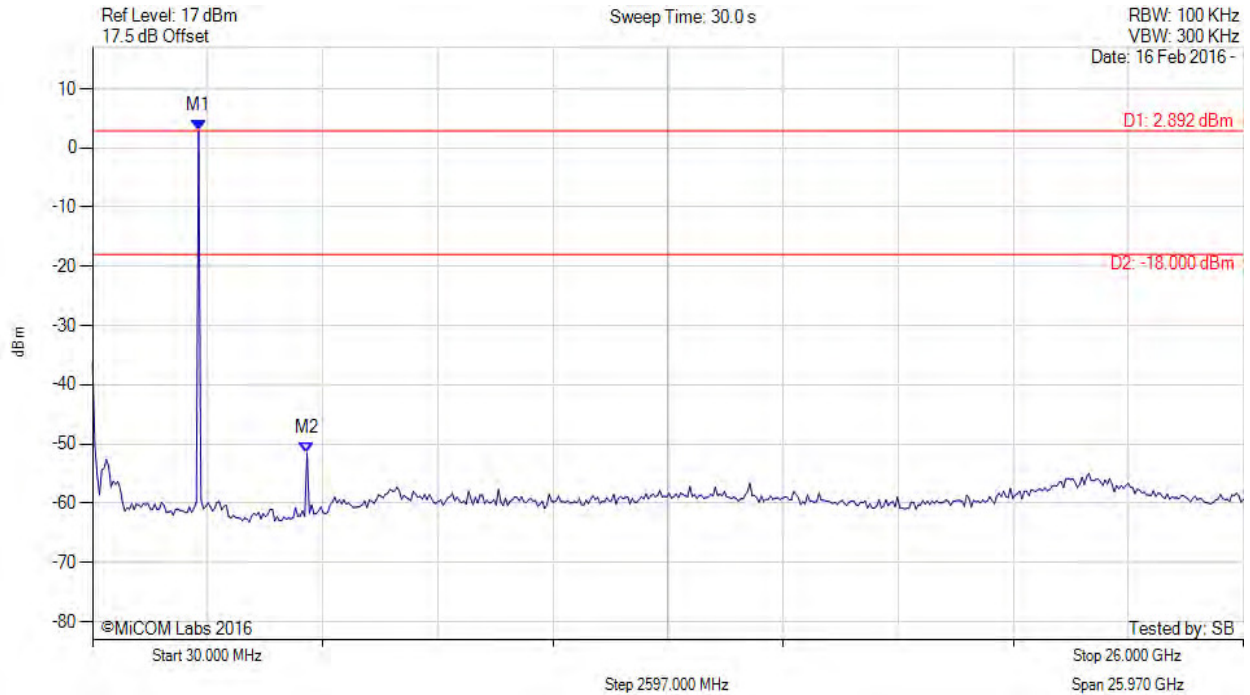

Analyzer Setup	Marker:Frequency:Amplitude	Test Results
Detector = MAX PEAK Sweep Count = 0 RF Atten (dB) = 10 Trace Mode = VIEW	M1 : 2424.028 MHz : 2.892 dBm M2 : 4870.100 MHz : -51.550 dBm	Limit: -18.00 dBm Margin: -33.55 dB

[back to matrix](#)

This test report may be reproduced in full only. The document may only be updated by MiCOM Labs personnel. All changes will be noted in the Document History section of the report.



CONDUCTED SPURIOUS EMISSIONS - PEAK



Variant: DTS, Channel: 2480.00 MHz, Chain a, Temp: Ambient, Voltage: 48 Vdc

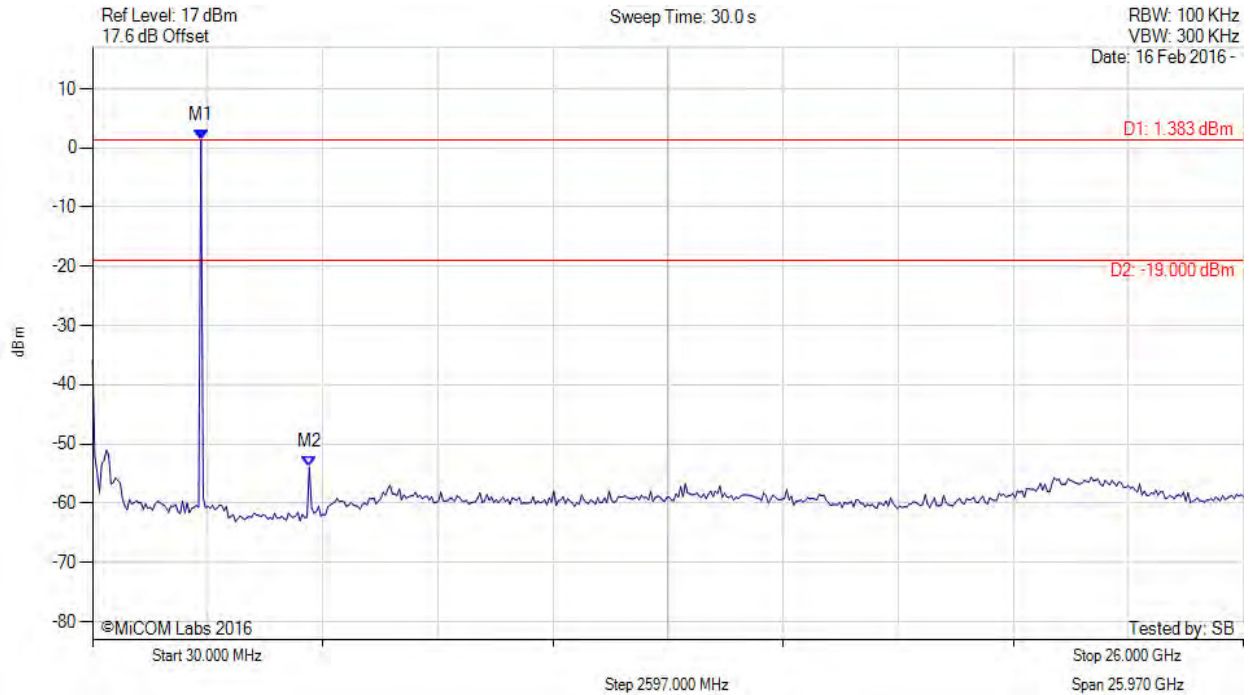

Analyzer Setup	Marker:Frequency:Amplitude	Test Results
Detector = MAX PEAK Sweep Count = 0 RF Atten (dB) = 10 Trace Mode = VIEW	M1 : 2476.072 MHz : 1.383 dBm M2 : 4922.144 MHz : -53.900 dBm	Limit: -19.00 dBm Margin: -34.90 dB

[back to matrix](#)

This test report may be reproduced in full only. The document may only be updated by MiCOM Labs personnel. All changes will be noted in the Document History section of the report.



A.3.2. Conducted Band-Edge Emissions



CONDUCTED LOW BAND-EDGE EMISSION - PEAK

Variant: DTS, Channel: 2402.00 MHz, Chain a, Temp: Ambient, Voltage: 48 Vdc

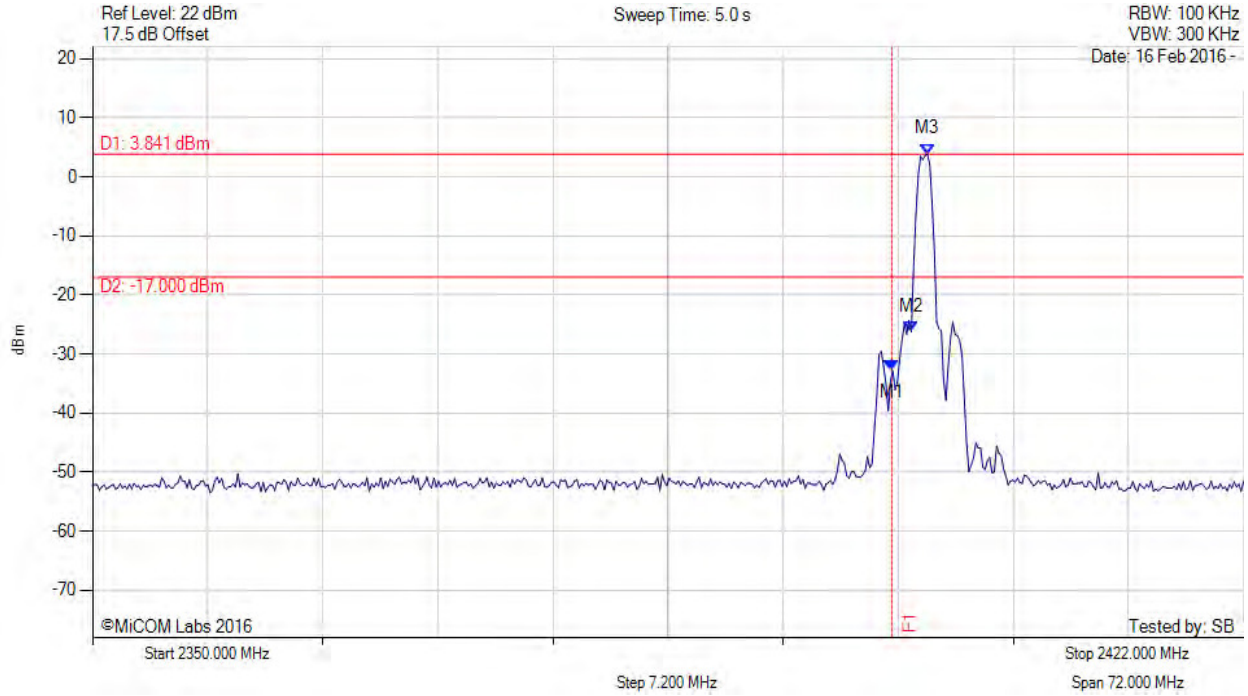

Analyzer Setup	Marker:Frequency:Amplitude	Test Results
Detector = MAX PEAK Sweep Count = 0 RF Atten (dB) = 20 Trace Mode = VIEW	M1 : 2400.000 MHz : -32.907 dBm M2 : 2401.222 MHz : -26.259 dBm M3 : 2402.232 MHz : 3.841 dBm	Channel Frequency: 2402.00 MHz

[back to matrix](#)

This test report may be reproduced in full only. The document may only be updated by MiCOM Labs personnel. All changes will be noted in the Document History section of the report.



Title: Aruba Networks, Inc AP-335
To: FCC Part 15.247 (DTS) & IC RSS-247
Serial #: ARUB196-U16 Rev A
Issue Date: 5th May 2016
Page: 54 of 63

CONDUCTED HIGH BAND-EDGE EMISSION - PEAK



Variant: DTS, Channel: 2480.00 MHz, Chain a, Temp: Ambient, Voltage: 48 Vdc

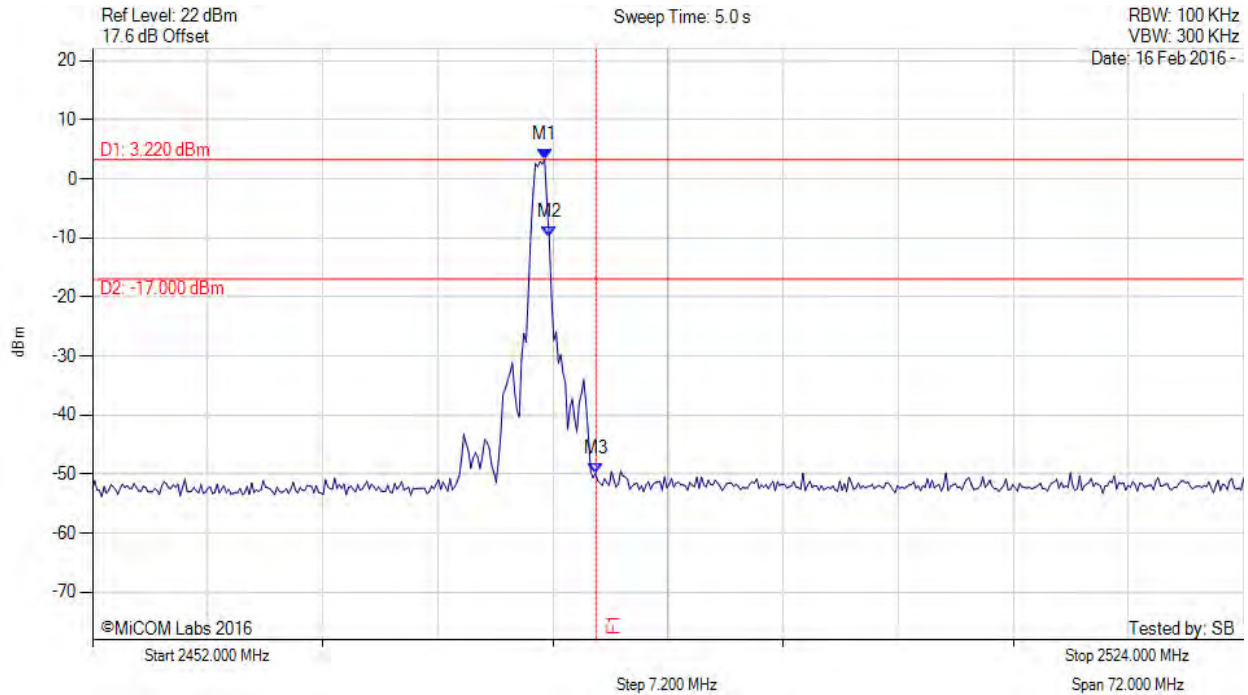

Analyzer Setup	Marker:Frequency:Amplitude	Test Results
Detector = MAX PEAK Sweep Count = 0 RF Atten (dB) = 20 Trace Mode = VIEW	M1 : 2480.281 MHz : 3.220 dBm M2 : 2480.569 MHz : -9.846 dBm M3 : 2483.500 MHz : -49.919 dBm	Channel Frequency: 2480.00 MHz

[back to matrix](#)

This test report may be reproduced in full only. The document may only be updated by MiCOM Labs personnel. All changes will be noted in the Document History section of the report.



A.4. Power Spectral Density



POWER SPECTRAL DENSITY - PEAK

Variants: DTS, Channel: 2402.00 MHz, Chain a, Temp: Ambient, Voltage: 48 Vdc

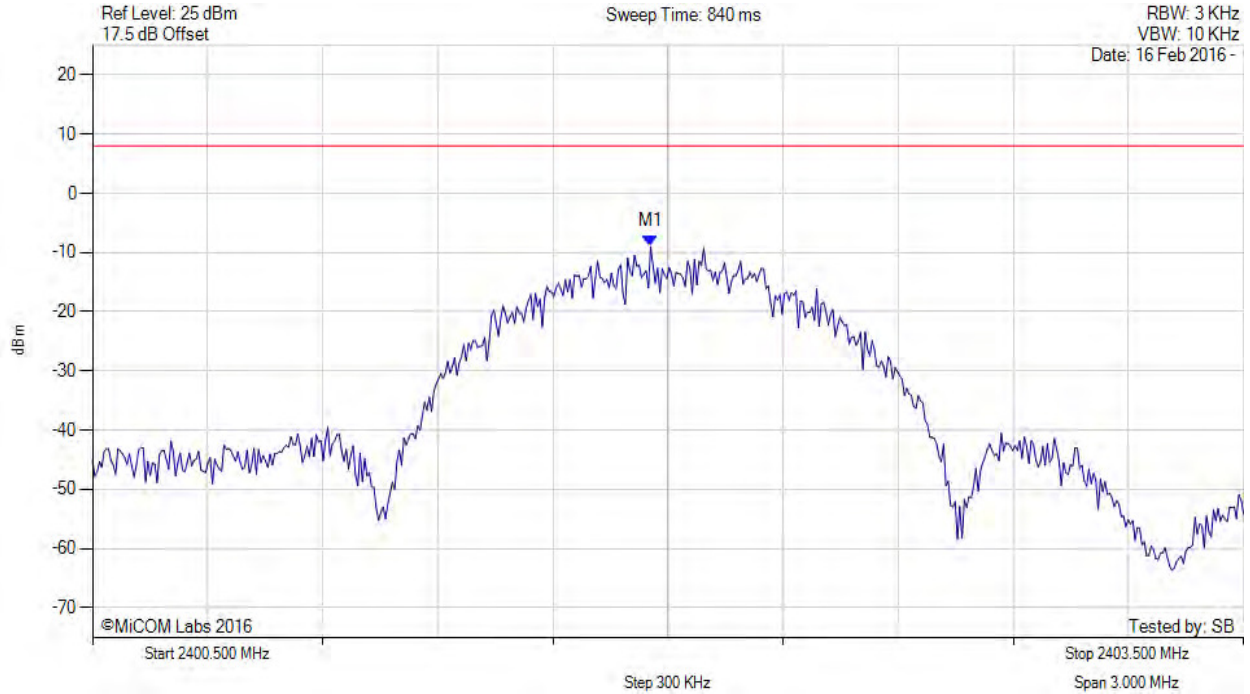

Analyzer Setup	Marker:Frequency:Amplitude	Test Results
Detector = MAX PEAK Sweep Count = 0 RF Atten (dB) = 20 Trace Mode = VIEW	M1 : 2401.955 MHz : -9.018 dBm	Limit: ≤ 8.000 dBm Margin: 17.02 dB

[back to matrix](#)

This test report may be reproduced in full only. The document may only be updated by MiCOM Labs personnel. All changes will be noted in the Document History section of the report.



Title: Aruba Networks, Inc AP-335
To: FCC Part 15.247 (DTS) & IC RSS-247
Serial #: ARUB196-U16 Rev A
Issue Date: 5th May 2016
Page: 56 of 63

POWER SPECTRAL DENSITY - PEAK



Variant: DTS, Channel: 2442.00 MHz, Chain a, Temp: Ambient, Voltage: 48 Vdc

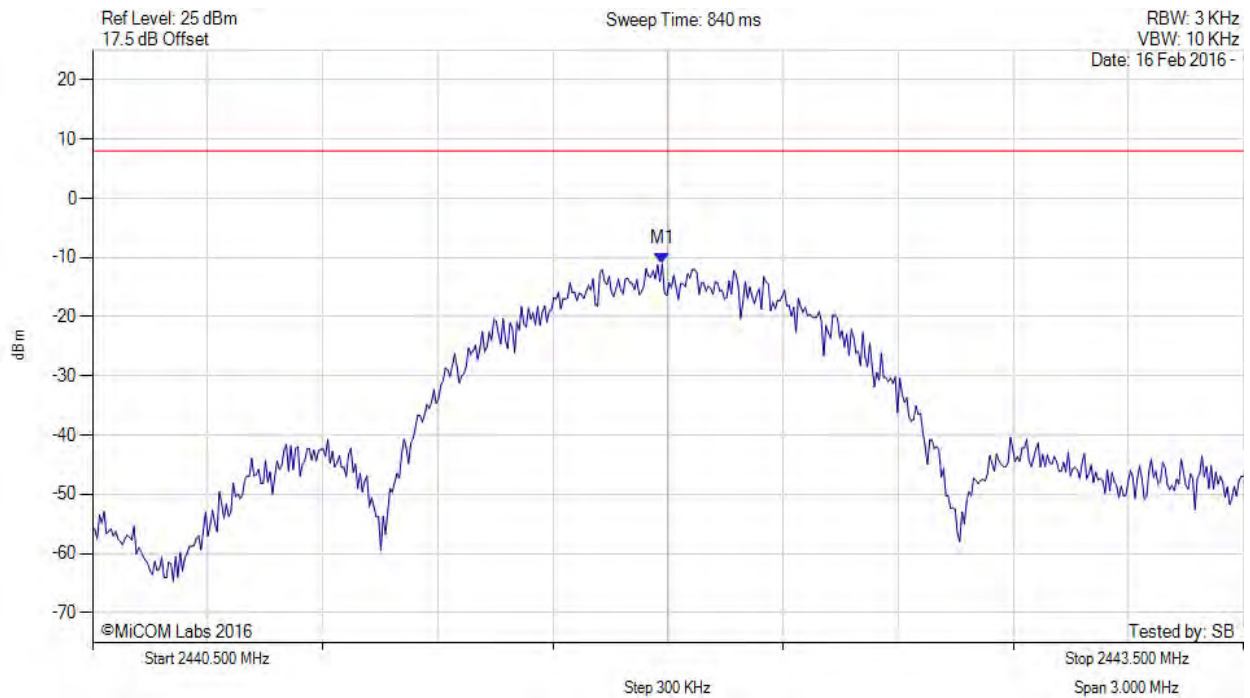

Analyzer Setup	Marker:Frequency:Amplitude	Test Results
Detector = MAX PEAK Sweep Count = 0 RF Atten (dB) = 20 Trace Mode = VIEW	M1 : 2441.985 MHz : -11.081 dBm	Limit: ≤ 8.000 dBm Margin: 19.08 dB

[back to matrix](#)

This test report may be reproduced in full only. The document may only be updated by MiCOM Labs personnel. All changes will be noted in the Document History section of the report.



POWER SPECTRAL DENSITY - PEAK



Variant: DTS, Channel: 2480.00 MHz, Chain a, Temp: Ambient, Voltage: 48 Vdc

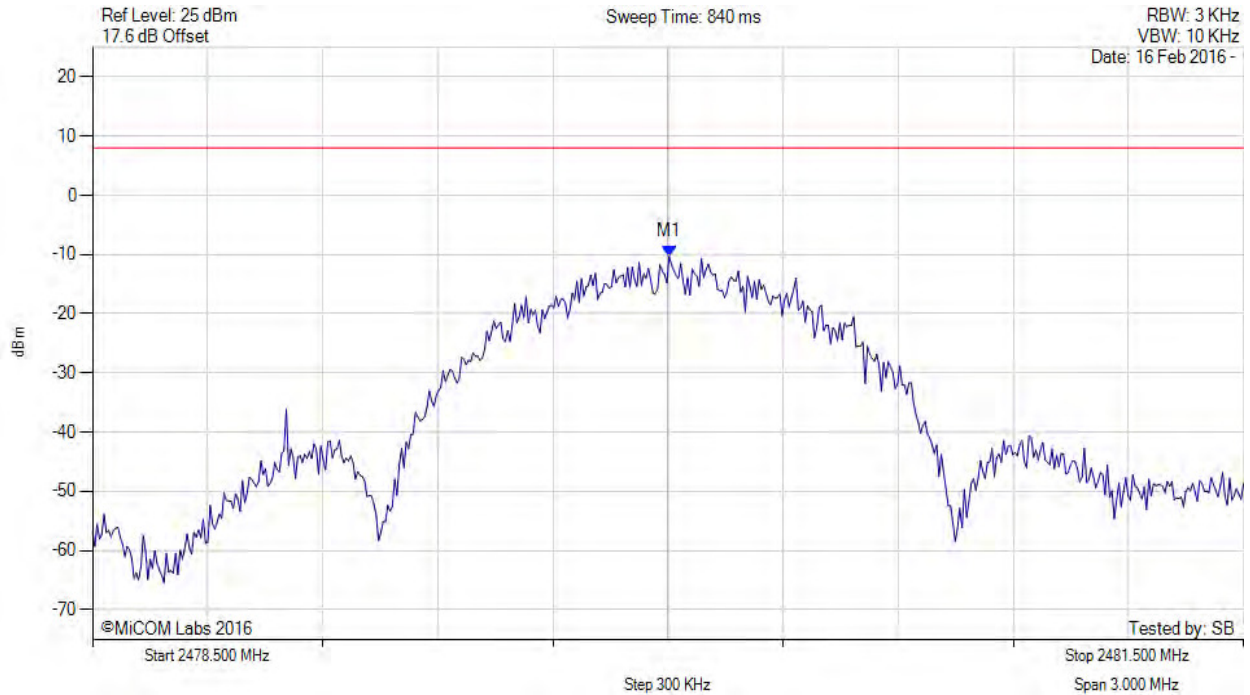

Analyzer Setup	Marker:Frequency:Amplitude	Test Results
Detector = MAX PEAK Sweep Count = 0 RF Atten (dB) = 20 Trace Mode = VIEW	M1 : 2480.003 MHz : -10.271 dBm	Limit: ≤ 8.000 dBm Margin: 18.27 dB

[back to matrix](#)

This test report may be reproduced in full only. The document may only be updated by MiCOM Labs personnel. All changes will be noted in the Document History section of the report.



A.5. Radiated Spurious Emissions

A.5.1. Restricted Band Emissions



RADIATED SPURIOUS - RESTRICTED BAND EMISSIONS

Variant: BLE, Test Freq: 2402.00 MHz, Antenna: APIN0335, Power Setting: 4, Duty Cycle (%): 99

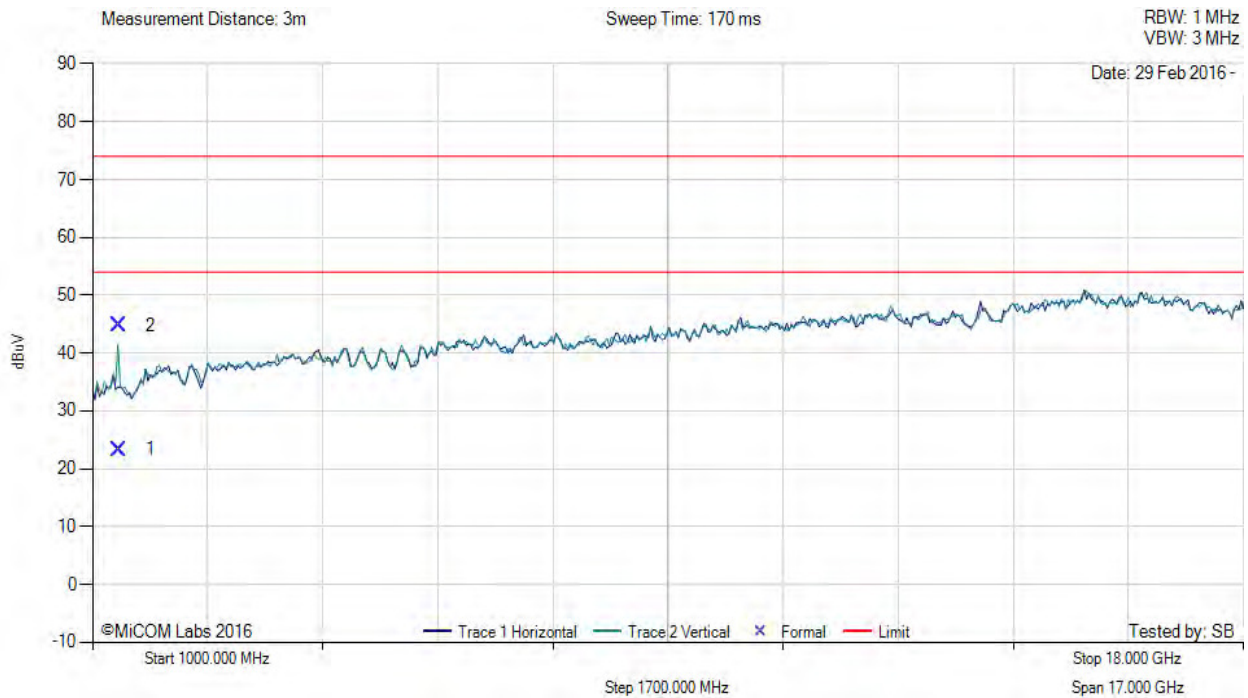

Num	Frequency MHz	Raw dB μ V	Cable Loss	AF dB	Level dB μ V/m	Measurement Type	Pol	Hgt cm	Azt Deg	Limit dB μ V/m	Margin dB	Pass /Fail
1	1397.64	36.66	2.26	-15.56	23.36	Max Avg	Vertical	100	202	54.0	-30.6	Pass
2	1397.64	58.04	2.26	-15.56	44.74	Max Peak	Vertical	100	202	74.0	-29.3	Pass

[back to matrix](#)

This test report may be reproduced in full only. The document may only be updated by MiCOM Labs personnel. All changes will be noted in the Document History section of the report.



Title: Aruba Networks, Inc AP-335
To: FCC Part 15.247 (DTS) & IC RSS-247
Serial #: ARUB196-U16 Rev A
Issue Date: 5th May 2016
Page: 59 of 63

RADIATED SPURIOUS - RESTRICTED BAND EMISSIONS



Variant: BLE, Test Freq: 2442.00 MHz, Antenna: APIN0335, Power Setting: 4, Duty Cycle (%): 99

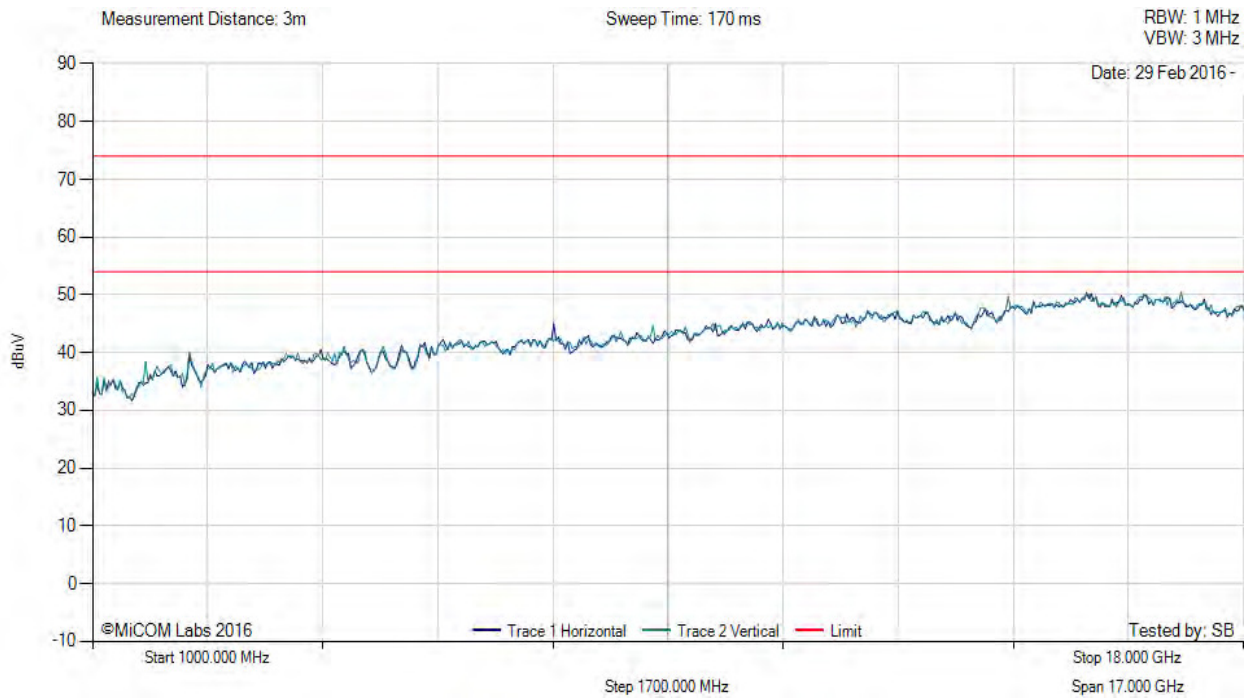

There are no emissions found within 6dB of the limit line.

[back to matrix](#)

This test report may be reproduced in full only. The document may only be updated by MiCOM Labs personnel. All changes will be noted in the Document History section of the report.



RADIATED SPURIOUS - RESTRICTED BAND EMISSIONS



Variant: BLE, Test Freq: 2480.00 MHz, Antenna: APIN0335, Power Setting: 4, Duty Cycle (%): 99

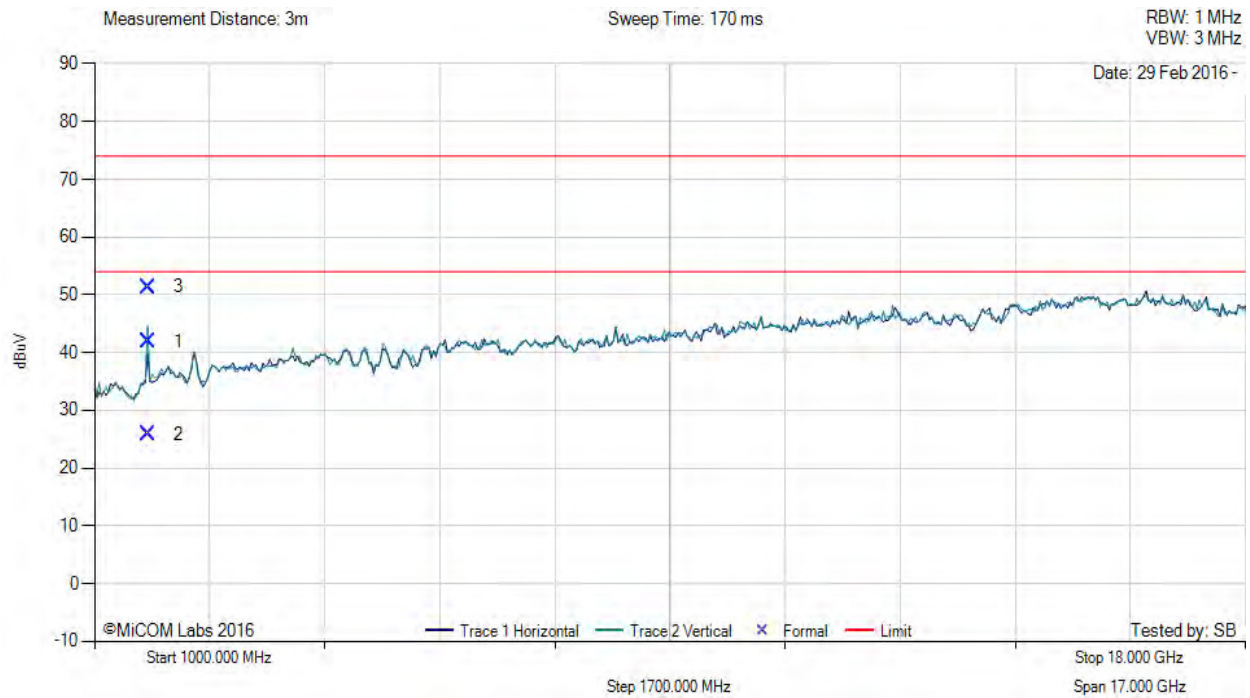

Num	Frequency MHz	Raw dBµV	Cable Loss	AF dB	Level dBµV/m	Measurement Type	Pol	Hgt cm	Azt Deg	Limit dBµV/m	Margin dB	Pass /Fail
1	1791.95	53.28	2.46	-13.80	41.94	Peak (NRB)	Vertical	101	0	--	--	Pass
2	1791.95	37.18	2.46	-13.80	25.84	Max Avg	Vertical	102	299	54.0	-28.2	Pass
3	1791.95	62.72	2.46	-13.80	51.38	Max Peak	Vertical	102	299	74.0	-22.6	Pass

[back to matrix](#)

This test report may be reproduced in full only. The document may only be updated by MiCOM Labs personnel. All changes will be noted in the Document History section of the report.



A.5.2. Restricted Band-Edge Emissions



RADIATED - LOWER RESTRICTED BAND-EDGE EMISSIONS

Variant: BLE, Test Freq: 2402.00 MHz, Antenna: APIN0335, Power Setting: 4, Duty Cycle (%): 99

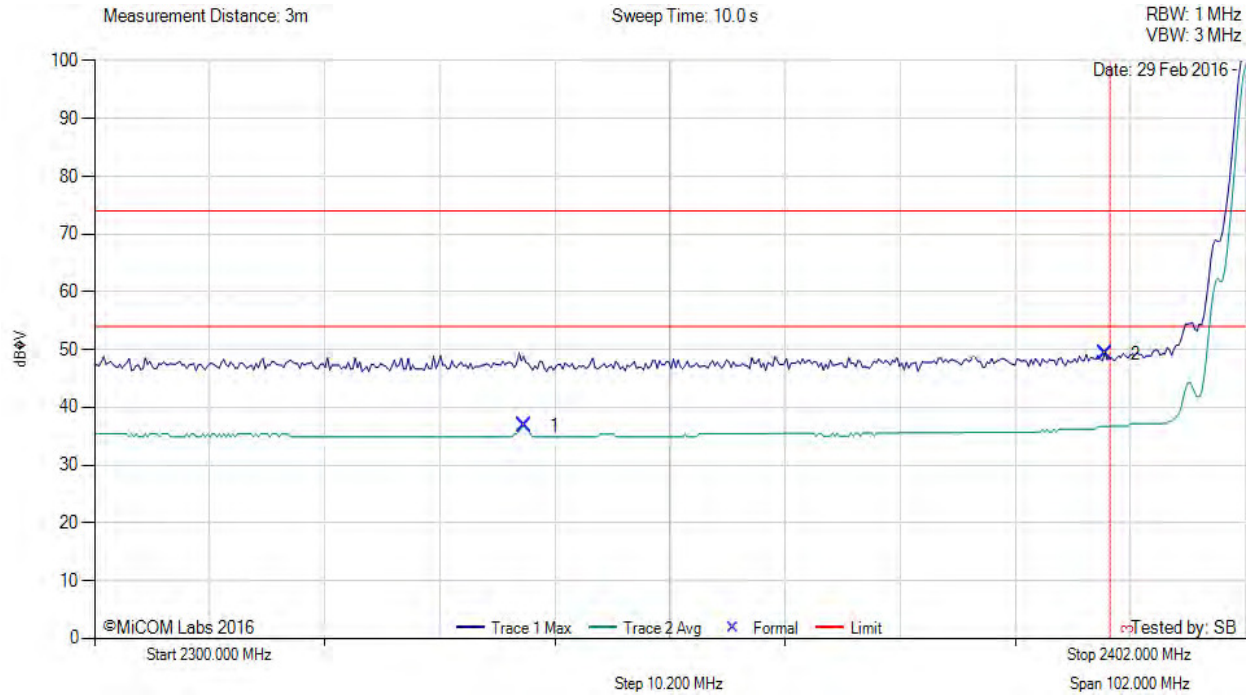

Num	Frequency MHz	Raw dBµV	Cable Loss	AF dB	Level dBµV/m	Measurement Type	Pol	Hgt cm	Azt Deg	Limit dBµV/m	Margin dB	Pass /Fail
1	2338.08	2.43	2.69	31.70	36.82	Max Avg	Horizontal	159	13	54.0	-17.2	Pass
2	2389.59	14.60	2.69	32.04	49.33	Max Peak	Horizontal	159	13	74.0	-24.7	Pass
3	2390.00	--	--	--	--	Band-Edge	--	--	--	--	--	--

[back to matrix](#)

This test report may be reproduced in full only. The document may only be updated by MiCOM Labs personnel. All changes will be noted in the Document History section of the report.



Title: Aruba Networks, Inc AP-335
To: FCC Part 15.247 (DTS) & IC RSS-247
Serial #: ARUB196-U16 Rev A
Issue Date: 5th May 2016
Page: 62 of 63

RADIATED - UPPER RESTRICTED BAND-EDGE EMISSIONS



Variant: BLE, Test Freq: 2480.00 MHz, Antenna: APIN0335, Power Setting: 4, Duty Cycle (%): 99

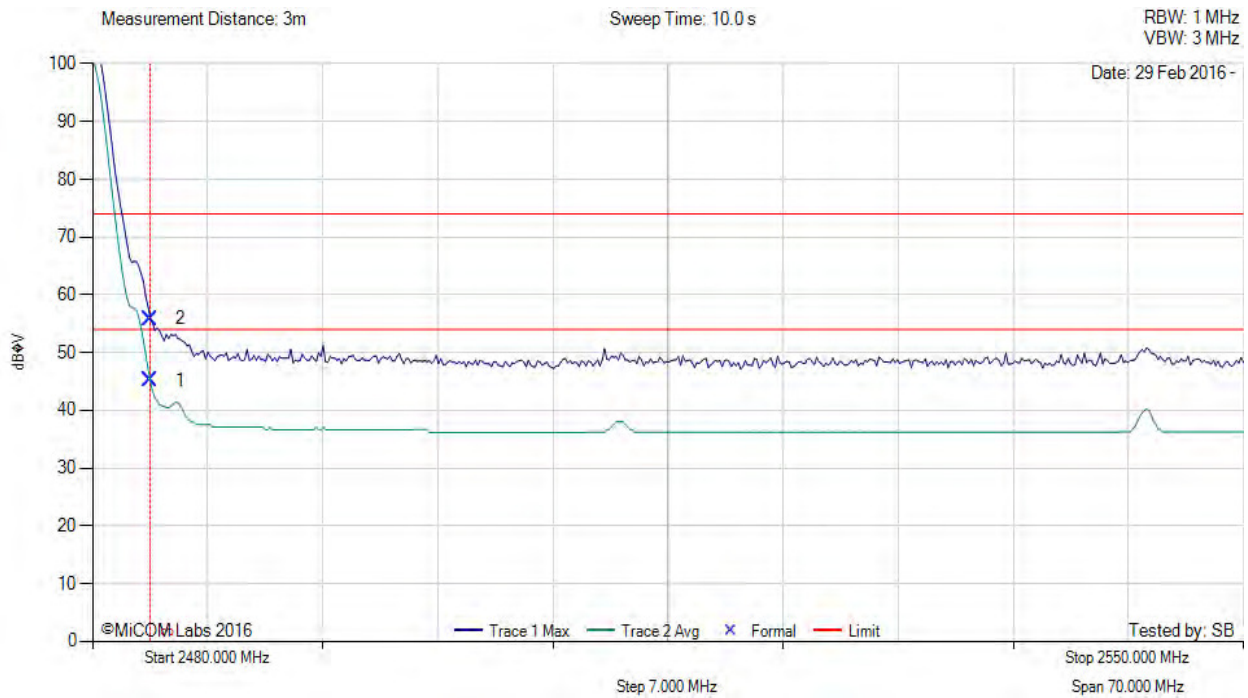

Num	Frequency MHz	Raw dBµV	Cable Loss	AF dB	Level dBµV/m	Measurement Type	Pol	Hgt cm	Azt Deg	Limit dBµV/m	Margin dB	Pass /Fail
1	2483.50	10.06	2.73	32.37	45.16	Max Avg	Horizontal	159	17	54.0	-8.8	Pass
2	2483.50	20.79	2.73	32.37	55.89	Max Peak	Horizontal	159	17	74.0	-18.1	Pass
3	2483.50	--	--	--	--	Band-Edge	--	--	--	--	--	--

[back to matrix](#)

This test report may be reproduced in full only. The document may only be updated by MiCOM Labs personnel. All changes will be noted in the Document History section of the report.



575 Boulder Court
Pleasanton, California 94566, USA
Tel: +1 (925) 462 0304
Fax: +1 (925) 462 0306
www.micomlabs.com