

Company: Aruba Networks, Inc.

Test of: APIN0334, APIN0335
To: FCC Subpart C 15.247 (DTS), IC RSS-247

Report No.: ARUB196-U3_Master Rev A

TEST REPORT





Test of: Aruba Networks, Inc. APIN0334, APIN0335

to

To: FCC Subpart C 15.247 (DTS), IC RSS-247

Test Report Serial No.: ARUB196-U3_Master Rev A

As a result of the 6 Mbyte FCC file size limitation potentially large test reports require to be split into smaller components. This document is the Master document controlling Addendum reports as listed below. This Master document combined with the Addendums demonstrate compliance with the standard

Master Document Number	Addendum Reports
ARUB196-U3_Master	ARUB196-U3_Conducted
	ARUB196-U3_Radiated
	ARUB196-U26 (FCC Part 15B & ICES-003)

This report supersedes: NONE

Applicant: Aruba Networks, Inc.
1344 Crossman Ave
Sunnyvale, California 94089
USA

Product Function: Wireless Access Point

Issue Date: 6th May 2016

This Test Report is Issued Under the Authority of:

MiCOM Labs, Inc.
575 Boulder Court
Pleasanton California 94566
USA
Phone: +1 (925) 462-0304
Fax: +1 (925) 462-0306
www.micomlabs.com



MiCOM Labs is an ISO 17025 Accredited Testing Laboratory



Title: Aruba Networks, Inc. APIN0334, APIN0335
To: FCC Subpart C 15.247 (DTS), IC RSS-247
Serial #: ARUB196-U3_Master Rev A
Issue Date: 16th March 2016
Page: 3 of 24

Table of Contents

1. ACCREDITATION, LISTINGS & RECOGNITION.....	4
1.1. Test Accreditation	4
1.2. Recognition	5
1.3. Product Certification	6
2. DOCUMENT HISTORY	7
3. TEST RESULT CERTIFICATE.....	8
4. REFERENCES AND MEASUREMENT UNCERTAINTY	9
4.1. Normative References	9
4.2. Test and Uncertainty Procedure	10
5. PRODUCT DETAILS AND TEST CONFIGURATIONS	11
5.1. Technical Details	11
5.2. Scope Of Test Program	12
5.3. Equipment Model(s) and Serial Number(s)	15
5.4. Antenna Details	15
5.5. Cabling and I/O Ports	15
5.6. Test Configurations.....	16
5.7. Equipment Modifications	16
5.8. Deviations from the Test Standard	16
6. TEST SUMMARY	17
7. TEST EQUIPMENT CONFIGURATION(S)	18
7.1. Conducted	18
7.2. Radiated Emissions	20
7.3. ac Wireline Emissions.....	22
8. MEASUREMENT AND PRESENTATION OF TEST DATA	23

This test report may be reproduced in full only. The document may only be updated by MiCOM Labs personnel. All changes will be noted in the Document History section of the report.

1. ACCREDITATION, LISTINGS & RECOGNITION

1.1. Test Accreditation

MiCOM Labs, Inc. is an accredited Electrical testing laboratory per the international standard ISO/IEC 17025:2005. The company is accredited by the American Association for Laboratory Accreditation (A2LA) www.a2la.org test laboratory number 2381.01. MiCOM Labs test schedule is available at the following URL; <http://www.a2la.org/scopepdf/2381-01.pdf>



Accredited Laboratory

A2LA has accredited

MICOM LABS

Pleasanton, CA

for technical competence in the field of

Electrical Testing

This laboratory is accredited in accordance with the recognized International Standard ISO/IEC 17025:2005 General requirements for the competence of testing and calibration laboratories. This accreditation demonstrates technical competence for a defined scope and the operation of a laboratory quality management system (refer to joint ISO-ILAC-IAF Communiqué dated 8 January 2009).



Presented this 4th day of February 2016.

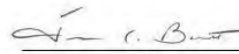

Senior Director of Quality & Communications
For the Accreditation Council
Certificate Number 2381.01
Valid to November 30, 2017

For the tests or types of tests to which this accreditation applies, please refer to the laboratory's Electrical Scope of Accreditation.

This test report may be reproduced in full only. The document may only be updated by MiCOM Labs personnel. All changes will be noted in the Document History section of the report.



1.2. Recognition

MiCOM Labs, Inc has widely recognized wireless testing capabilities. Our international recognition includes Conformity Assessment Body designation by APEC MRA countries. MiCOM Labs test reports are accepted globally.

Country	Recognition Body	Status	Phase	Identification No.
USA	Federal Communications Commission (FCC)	TCB	-	US0159 Listing #: 102167
Canada	Industry Canada (IC)	FCB	APEC MRA 2	US0159 Listing #: 4143A-2 4143A-3
Japan	MIC (Ministry of Internal Affairs and Communication)	CAB	APEC MRA 2	RCB 210
	VCCI	--	--	A-0012
Europe	European Commission	NB	EU MRA	NB 2280
Australia	Australian Communications and Media Authority (ACMA)	CAB	APEC MRA 1	US0159
Hong Kong	Office of the Telecommunication Authority (OFTA)	CAB	APEC MRA 1	
Korea	Ministry of Information and Communication Radio Research Laboratory (RRL)	CAB	APEC MRA 1	
Singapore	Infocomm Development Authority (IDA)	CAB	APEC MRA 1	
Taiwan	National Communications Commission (NCC) Bureau of Standards, Metrology and Inspection (BSMI)	CAB	APEC MRA 1	
Vietnam	Ministry of Communication (MIC)	CAB	APEC MRA 1	

EU MRA – European Union Mutual Recognition Agreement.

NB – Notified Body

APEC MRA – Asia Pacific Economic Community Mutual Recognition Agreement. Recognition agreement under which test lab is accredited to regulatory standards of the APEC member countries.

Phase I - recognition for product testing

Phase II – recognition for both product testing and certification

1.3. Product Certification

MiCOM Labs, Inc. is an accredited Product Certification Body per the international standard ISO/IEC 17065:2012. The company is accredited by the American Association for Laboratory Accreditation (A2LA) www.a2la.org test laboratory number 2381.02. MiCOM Labs test schedule is available at the following URL; <http://www.a2la.org/scopepdf/2381-02.pdf>



Accredited Product Certification Body

A2LA has accredited

MICOM LABS

Pleasanton, CA

This product certification body is accredited in accordance with the recognized International Standard ISO/IEC 17065:2012 *Requirements for bodies certifying products, processes and services*. This accreditation demonstrates technical competence for a defined scope and the operation of a management system.



Presented this 4th day of February 2016.

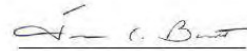

Senior Director of Quality & Communications
For the Accreditation Council
Certificate Number 2381.02
Valid to November 30, 2017

For the product certification schemes to which this accreditation applies, please refer to the organization's Product Certification Scope of Accreditation.

United States of America – Telecommunication Certification Body (TCB)
Industry Canada – Certification Body, CAB Identifier – US0159
Europe – Notified Body (NB), NB Identifier - 2280
Japan – Recognized Certification Body (RCB), RCB Identifier - 210

This test report may be reproduced in full only. The document may only be updated by MiCOM Labs personnel. All changes will be noted in the Document History section of the report.



Title: Aruba Networks, Inc. APIN0334, APIN0335
To: FCC Subpart C 15.247 (DTS), IC RSS-247
Serial #: ARUB196-U3_Master Rev A
Issue Date: 16th March 2016
Page: 7 of 24

2. DOCUMENT HISTORY

Draft History		
Revision	Date	Comments
Draft	16 th March 2016	Initial

Released Document History			
Master Revision	Addendum Revision	Date	Comments
Rev A, 6 th May 2016	Rev 1.0 Conducted	6 th May 2016	Initial Release
	Rev 1.0 Radiated	6 th May 2016	

In the above table the latest report revision will replace all earlier versions.

This test report may be reproduced in full only. The document may only be updated by MiCOM Labs personnel. All changes will be noted in the Document History section of the report.



Title: Aruba Networks, Inc. APIN0334, APIN0335
To: FCC Subpart C 15.247 (DTS), IC RSS-247
Serial #: ARUB196-U3_Master Rev A
Issue Date: 16th March 2016
Page: 8 of 24

3. TEST RESULT CERTIFICATE

Manufacturer: Aruba Networks, Inc. 1344 Crossman Ave. Sunnyvale, California 94089 USA	Tested By: MiCOM Labs, Inc. 575 Boulder Court Pleasanton California 94566 USA
Model(s): APIN0334, APIN0335	Telephone: +1 925 462 0304 Fax: +1 925 462 0306
Equipment Type: Wireless Access Point	
S/N's: DT0000446 DT0000153 DT0000491 DT0000259	
Test Date(s): 26 th January – 17 th February 2016	Website: www.micomlabs.com

STANDARD(S)	TEST RESULTS
FCC CFR 47 Part 15 Subpart C 15.247 (DTS)	EQUIPMENT COMPLIES

MiCOM Labs, Inc. tested the equipment mentioned in accordance with the requirements set forth in the above standards. Test results indicate that the equipment tested is capable of demonstrating compliance with the requirements as documented within this report.

Notes:

1. This document reports conditions under which testing was conducted and the results of testing performed.
2. Details of test methods used have been recorded and kept on file by the laboratory.
3. Test results apply only to the item(s) tested.

Approved & Released for MiCOM Labs, Inc. by:



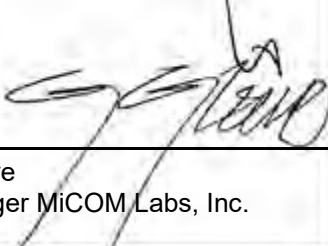

Graeme Grieve
Quality Manager MiCOM Labs, Inc.

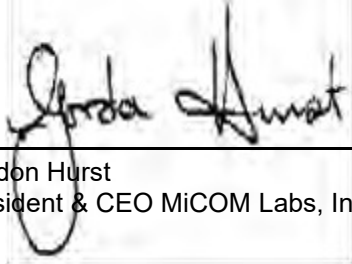

Gordon Hurst
President & CEO MiCOM Labs, Inc.

This test report may be reproduced in full only. The document may only be updated by MiCOM Labs personnel. All changes will be noted in the Document History section of the report.



Title: Aruba Networks, Inc. APIN0334, APIN0335
To: FCC Subpart C 15.247 (DTS), IC RSS-247
Serial #: ARUB196-U3_Master Rev A
Issue Date: 16th March 2016
Page: 9 of 24

4. REFERENCES AND MEASUREMENT UNCERTAINTY

4.1. Normative References

REF.	PUBLICATION	YEAR	TITLE
I	KDB 662911	Oct 31 2013	Guidance for measurement of output emission of devices that employ single transmitter with multiple outputs or systems with multiple transmitters operating simultaneously in the same frequency band
II	KDB 558074 D01 v03r05	8th April 2016	Guidance for performing compliance measurements on Digital Transmission Systems (DTS) operating under section 15.247.
III	A2LA	June 2015	R105 - Requirement's When Making Reference to A2LA Accreditation Status
IV	ANSI C63.10	2013	American National Standard for Testing Unlicensed Wireless Devices
V	ANSI C63.4	2014	American National Standards for Methods of Measurement of Radio-Noise Emissions from Low-Voltage Electrical and Electronic Equipment in the Range of 9 kHz to 40 GHz
VI	CISPR 22	2010	Information technology equipment - Radio disturbance characteristics - Limits and methods of measurement
VII	ETSI TR 100 028	2001-12	Parts 1 and 2 Electromagnetic compatibility and Radio Spectrum Matters (ERM); Uncertainties in the measurement of mobile radio equipment characteristics
VIII	FCC 47 CFR Part 15.247	2014	Radio Frequency Devices; Subpart C – Intentional Radiators
IX	ICES-003	Issue 6, January 2016	Spectrum Management and Telecommunications; Interference-Causing Equipment Standard. Information Technology Equipment (ITE) – Limits and methods of measurement.
X	M 3003	Edition 3 Nov. 2012	Expression of Uncertainty and Confidence in Measurements
XI	RSS-247 Issue 1	May 2015	Digital Transmission Systems (DTSs), Frequency Hopping System (FHSs) and Licence-Exempt Local Area Network (LE-LEN) Devices
XII	RSS-Gen Issue 4	November 2014	General Requirements and Information for the Certification of Radiocommunication Equipment
XIII	KDB 644545 D03 v01	August 14th 2014	Guidance for IEEE 802.11ac New Rules
XIV	FCC 47 CFR Part 2.1033	2014	FCC requirements and rules regarding photographs and test setup diagrams.

This test report may be reproduced in full only. The document may only be updated by MiCOM Labs personnel. All changes will be noted in the Document History section of the report.



Title: Aruba Networks, Inc. APIN0334, APIN0335
To: FCC Subpart C 15.247 (DTS), IC RSS-247
Serial #: ARUB196-U3_Master Rev A
Issue Date: 16th March 2016
Page: 10 of 24

4.2. Test and Uncertainty Procedure

Conducted and radiated emission measurements were conducted in accordance with American National Standards Institute ANSI C63.4, listed in the Normative References section of this report.

Measurement uncertainty figures are calculated in accordance with ETSI TR 100 028 Parts 1 and 2.

Measurement uncertainties stated are based on a standard uncertainty multiplied by a coverage factor $k = 2$, providing a level of confidence of approximately 95 % in accordance with UKAS document M 3003 listed in the Normative References section of this report.

This test report may be reproduced in full only. The document may only be updated by MiCOM Labs personnel. All changes will be noted in the Document History section of the report.



Title: Aruba Networks, Inc. APIN0334, APIN0335
To: FCC Subpart C 15.247 (DTS), IC RSS-247
Serial #: ARUB196-U3_Master Rev A
Issue Date: 16th March 2016
Page: 11 of 24

5. PRODUCT DETAILS AND TEST CONFIGURATIONS

5.1. Technical Details

Details	Description
Purpose:	Test of the Aruba Networks, Inc APIN0334, APIN0335 to FCC CFR 47 Part 15 Subpart C 15.247 (DTS). Radio Frequency Devices; Subpart C – Intentional Radiators
Applicant:	Aruba Networks, Inc 1344 Crossman Ave. Sunnyvale 94089 USA
Manufacturer:	As Applicant
Laboratory performing the tests:	MiCOM Labs, Inc. 575 Boulder Court Pleasanton California 94566 USA
Test report reference number:	ARUB196-U3_Master
Date EUT received:	14 th January 2016
Standard(s) applied:	FCC CFR 47 Part 15 Subpart C 15.247 (DTS), IC RSS-247
Dates of test (from - to):	26 th January – 17 th February 2016
No of Units Tested:	4
Type of Equipment:	Wireless Access Point
Product Family Name:	Glenfarclas
Model(s):	APIN0334, APIN0335
Location for use:	Indoor
Declared Frequency Range(s):	2400 - 2483.5 MHz;
Primary function of equipment:	Wireless Access Point
EUT Modes of Operation:	802.11b; 802.11g; 802.11n HT-20; 802.11n HT-40;
Type of Modulation:	Per 802.11 –CCK, BPSK, QPSK, DSSS, OFDM
Transmit/Receive Operation:	Transceiver - Half Duplex
Rated Input Voltage and Current:	DC only (Battery operated / external supply) 48Vdc
Operating Temperature Range:	Declared Range 0°C to 40°C
ITU Emission Designator:	802.11b: 13M4G1D 802.11g: 16M6D1D 802.11n HT-20: 17M6D1D 802.11n HT-40: 36M4D1D
Equipment Dimensions:	225mm (W) x 224mm (D) x 52mm (H) /8.9" (W) x 8.9" (D) x 2.0" (H)
Weight:	APIN0334: 1.146 kg APIN0335: 1.160 kg
Hardware Rev:	2
Software Rev:	QSPR Version 5.0.0 RF Test Image used with QSPR: boarddata_1_dquan_2G_GF_12082015.bin

This test report may be reproduced in full only. The document may only be updated by MiCOM Labs personnel. All changes will be noted in the Document History section of the report.

5.2. Scope Of Test Program

Aruba Networks, Inc.

The scope of the test program was to test the Aruba Networks, Inc APIN0334 & APIN0335 configurations in the frequency ranges 2400 - 2483.5 MHz; for compliance against the following specification(s):

FCC CFR 47 Part 15 Subpart C 15.247 (DTS)

Radio Frequency Devices; Subpart C – Intentional Radiators

Industry Canada RSS-247

Digital Transmission Systems (DTSs), Frequency Hopping System (FHSs) and Licence-Exempt Local Area Network (LE-LEN) Devices

Product Family

APIN0334 : External Antennas (see Section 5.4 Antenna Details for antenna and beam-forming gains)

APIN0335 : Integral Antenna (see Section 5.4 Antenna Details for integral antenna gain)

Aruba Networks, Inc. APIN0334 External Antenna



This test report may be reproduced in full only. The document may only be updated by MiCOM Labs personnel. All changes will be noted in the Document History section of the report.

Aruba Networks, Inc. APIN0335 Integral Antenna



This test report may be reproduced in full only. The document may only be updated by MiCOM Labs personnel. All changes will be noted in the Document History section of the report.

Aruba Networks, Inc APIN0334 & APIN0335 (rear)



This test report may be reproduced in full only. The document may only be updated by MiCOM Labs personnel. All changes will be noted in the Document History section of the report.



Title: Aruba Networks, Inc. APIN0334, APIN0335
To: FCC Subpart C 15.247 (DTS), IC RSS-247
Serial #: ARUB196-U3_Master Rev A
Issue Date: 16th March 2016
Page: 15 of 24

5.3. Equipment Model(s) and Serial Number(s)

Type	Description	Manufacturer	Model	Serial no.	Delivery Date
EUT	802.11a/n/ac WLAN Access Point - Conducted	Aruba Networks	APIN0334	DT0000446	21 st January 2016
EUT	802.11a/n/ac WLAN Access Point - Radiated	Aruba Networks	APIN0335	DT0000153	14 th January 2016
EUT	802.11a/n/ac WLAN Access Point - Radiated	Aruba Networks	APIN0334	DT0000491	24 th February 2016
EUT	802.11a/n/ac WLAN Access Point - Radiated	Aruba Networks	APIN0335	DT0000259	14 th January 2016

5.4. Antenna Details

Type	Manufacturer	Model	Family	Gain (dBi)	BF Gain	Dir BW	X-Pol	Frequency Band (MHz)
integral	Aruba Networks	Metal Sheet	OMNI	2.6	3.0	360	-	2400 - 2483.5
external	Aruba Networks	AP-ANT-1W	OMNI	3.8	6.0	360	-	2400 - 2483.5
external	Aruba Networks	AP-ANT-13B	Downtilt OMNI	4.4	6.0	360	-	2400 - 2483.5
external	Aruba Networks	AP-ANT-19	OMNI	3.0	6.0	360	-	2400 - 2483.5
external	Aruba Networks	AP-ANT-20W	OMNI	2.0	6.0	360	-	2400 - 2483.5
external	Aruba Networks	AP-ANT-40	Downtilt OMNI	3.9	3.0	360	-	2400 - 2483.5
external	Aruba Networks	AP-ANT-45	Multipolarized	5.0	3.0	360	-	2400 - 2483.5
external	Aruba Networks	AP-ANT-48	Multipolarized	8.5	3.0	360	-	2400 - 2483.5

BF Gain - Beamforming Gain
Dir BW - Directional BeamWidth
X-Pol - Cross Polarization

5.5. Cabling and I/O Ports

Port Type	Max Cable Length	# Of Ports	Screened	Conn Type	Data Type
Ethernet	100m	2	N	RJ-45	Packet Data
USB	5m	1	Y	USB	Digital

This test report may be reproduced in full only. The document may only be updated by MiCOM Labs personnel. All changes will be noted in the Document History section of the report.



Title: Aruba Networks, Inc. APIN0334, APIN0335
To: FCC Subpart C 15.247 (DTS), IC RSS-247
Serial #: ARUB196-U3_Master Rev A
Issue Date: 16th March 2016
Page: 16 of 24

5.6. Test Configurations

Results for the following configurations are provided in this report:

Operational Mode(s) (802.11a/b/g/n/ac)	Data Rate with Highest Power MBit/s	Channel Frequency (MHz)		
		Low	Mid	High
2400 - 2483.5 MHz				
802.11b	1	2,412.00	2,437.00	2,462.00
802.11g	6	2,412.00	2,437.00	2,462.00
802.11n HT20	6.5	2,412.00	2,437.00	2,462.00
802.11n HT40	13.5	2,422.00	2,437.00	2,452.00

5.7. Equipment Modifications

The following modifications were required to bring the equipment into compliance:

1. NONE

5.8. Deviations from the Test Standard

The following deviations from the test standard were required in order to complete the test program:

1. NONE

This test report may be reproduced in full only. The document may only be updated by MiCOM Labs personnel. All changes will be noted in the Document History section of the report.



Title: Aruba Networks, Inc. APIN0334, APIN0335
To: FCC Subpart C 15.247 (DTS), IC RSS-247
Serial #: ARUB196-U3_Master Rev A
Issue Date: 16th March 2016
Page: 17 of 24

6. TEST SUMMARY

List of Measurements

Test Header	Result	Comments
Conducted Testing	See Report Addendum ARUB196-U3_Conducted	
15.247(a)(2) 6 dB & 99% Bandwidth	Complies	
15.247(b), 15.31(e) Conducted Output Power	Complies	
15.247(d) Emissions	Complies	
(1) Conducted Emissions	Complies	
(i) Conducted Spurious Emissions	Complies	
(ii) Conducted Band-Edge Emissions	Complies	
15.247(e) Power Spectral Density	Complies	
Radiated Spurious Testing	See Report Addendum ARUB196-U7_Radiated	
Radiated Spurious & Band-Edge Emissions	Complies	
Antenna AP-ANT-13B	Complies	
Antenna AP-ANT-19	Complies	
Antenna AP-ANT-1W	Complies	
Antenna AP-ANT-20W	Complies	
Antenna AP-ANT-40	Complies	
Antenna AP-ANT-45	Complies	
Antenna AP-ANT-48	Complies	
Antenna Metal Sheet	Complies	
Digital Emissions	See Report ARUB196-U26 Part 15B & ICES-003	
15.209 Digital Emissions	Complies	
AC Wireline Emissions	See Report ARUB196-U26 Part 15B & ICES-003	
15.207 AC Wireline Emissions	Complies	

This test report may be reproduced in full only. The document may only be updated by MiCOM Labs personnel. All changes will be noted in the Document History section of the report.

7. TEST EQUIPMENT CONFIGURATION(S)

7.1. Conducted

Conducted RF Emission Test Set-up(s)

The following tests were performed using the conducted test set-up shown in the diagram below.

1. 6 dB & 99% Bandwidth
2. Conducted Output Power
3. Power Spectral Density
4. Conducted Emissions (including Band-Edge)

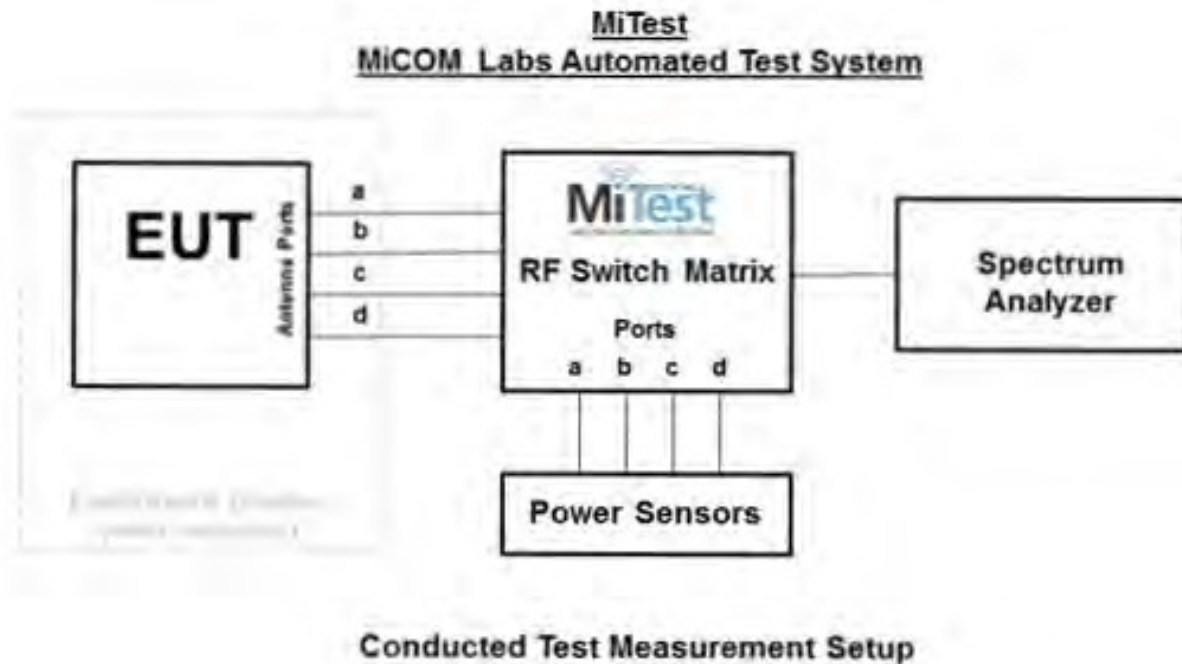

A full system calibration was performed on the test station and any resulting system losses (or gains) were taken into account in the production of all final measurement data.



Title: Aruba Networks, Inc. APIN0334, APIN0335
To: FCC Subpart C 15.247 (DTS), IC RSS-247
Serial #: ARUB196-U3_Master Rev A
Issue Date: 16th March 2016
Page: 19 of 24

Asset#	Description	Manufacturer	Model#	Serial#	Calibration Due Date
158	Barometer/Thermometer	Control Company	4196	E2846	01 Dec 2016
249	Resistance Thermometer	Thermotronics	GR2105-02	9340 #2	23 Oct 2016
287	Rohde & Schwarz 40 GHz Receiver	Rhode & Schwarz	ESIB40	100201	27 Aug 2016
361	Desktop for RF#1, Labview Software installed	Dell	Vostro 220	WS RF#1	Not Required
378	Rohde & Schwarz 40 GHz Receiver with Generator	Rhode & Schwarz	ESIB40	100107/040	04 Aug 2016
380	4x4 RF Switch Box	MiCOM Labs	MiTest RF Switch Box	MIC001	18 Jun 2016
390	USB Power Head 50MHz - 24GHz -60 to +20dBm	Agilent	U2002A	MY50000103	17 Oct 2016
398	Test Software	MiCOM	MiTest ATS	Version 3.0.0.16	Not Required
405	DC Power Supply 0-60V	Agilent	6654A	MY4001826	Cal when used
408	USB to GPIB interface	National Instruments	GPIB-USB HS	14C0DE9	Not Required
436	USB Wideband Power Sensor	Boonton	55006	8731	31 Jul 2016
437	USB Wideband Power Sensor	Boonton	55006	8759	31 Jul 2016
445	PoE Injector	D-Link	DPE-101GL	QTAH1E2000625	Not Required
461	Spectrum Analyzer	Agilent	E4440A	MY46185537	13 Aug 2016
75	Environmental Chamber	Thermatron	SE-300-2-2	27946	24 Nov 2016
RF#1 GPIB#1	GPIB cable to Power Supply	HP	GPIB	None	Not Required
RF#1 SMA SA #452	Precision SMA Male RG-402 Spectrun Analyzer	Fairview Microwave	Precision SMA Male RG 402 coax	None	18 Jun 2016
RF#1 SMA#1	EUT to Mitest box port 1	Flexco	SMA Cable port1	None	18 Jun 2016
RF#1 SMA#2	EUT to Mitest box port 2	Flexco	SMA Cable port2	None	18 Jun 2016
RF#1 SMA#3	EUT to Mitest box port 3	Flexco	SMA Cable port3	None	18 Jun 2016
RF#1 SMA#4	EUT to Mitest box port 4	Flexco	SMA Cable port4	None	18 Jun 2016
RF#1 USB#1	USB Cable to Mitest Box	Dynex	USB Cable	None	Not Required

This test report may be reproduced in full only. The document may only be updated by MiCOM Labs personnel. All changes will be noted in the Document History section of the report.

7.2. Radiated Emissions

The following tests were performed using the radiated test set-up shown in the diagram below.

1. Radiated Spurious and Band-Edge Emissions

Radiated Emission Measurement Setup Pictorial Representation

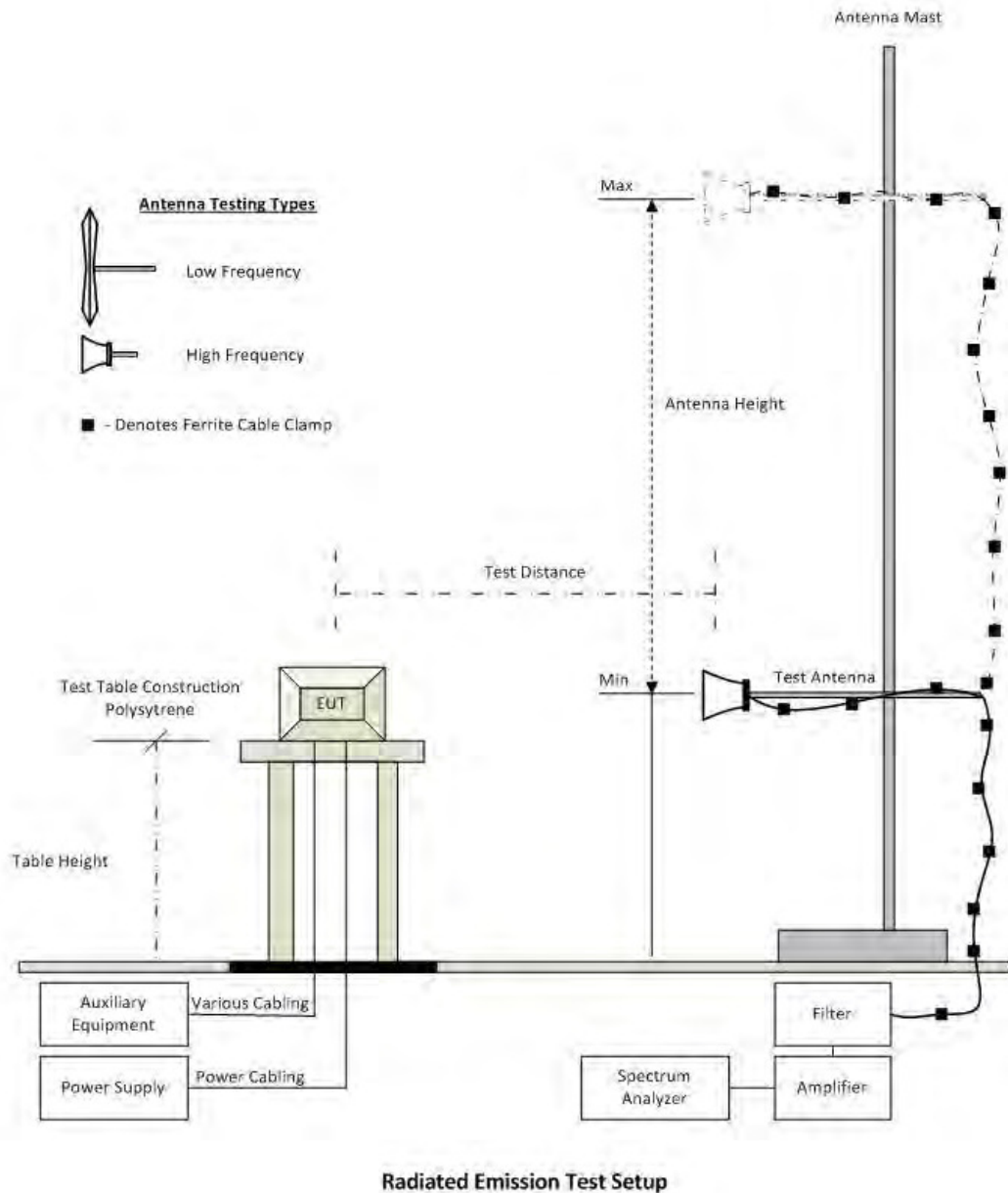

This test report may be reproduced in full only. The document may only be updated by MiCOM Labs personnel. All changes will be noted in the Document History section of the report.



Title: Aruba Networks, Inc. APIN0334, APIN0335
To: FCC Subpart C 15.247 (DTS), IC RSS-247
Serial #: ARUB196-U3_Master Rev A
Issue Date: 16th March 2016
Page: 21 of 24

Asset#	Description	Manufacturer	Model#	Serial#	Calibration Due Date
158	Barometer/Thermometer	Control Company	4196	E2846	01 Dec 2016
170	Video System Controller for Semi Anechoic Chamber	Panasonic	WV-CY101	04R08507	Not Required
287	Rohde & Schwarz 40 GHz Receiver	Rhode & Schwarz	ESIB40	100201	27 Aug 2016
338	Sunol 30 to 3000 MHz Antenna	Sunol	JB3	A052907	15 Aug 2016
396	2.4 GHz Notch Filter	Microtronics	BRM50701	001	18 Aug 2016
397	Amp 10 - 2500MHz	MiCOM Labs	Amp 10 - 2500 MHz	NA	24 Feb 2016
399	ETS 1-18 GHz Horn Antenna	ETS	3117	00154575	18 th Oct 2016
406	Amplifier for Radiated Emissions	MiCOM Labs	40dB 1 to 18GHz Amp	0406	28 May 2016
410	Desktop Computer	Dell	Inspiron 620	WS38	Not Required
411	Mast/Turtable Controller	Sunol Sciences	SC98V	060199-1D	Not Required
412	USB to GPIB Interface	National Instruments	GPIB-USB HS	11B8DC2	Not Required
413	Mast Controller	Sunol Science	TWR95-4	030801-3	Not Required
415	Turtable Controller	Sunol Sciences	Turtable Controller	None	Not Required
447	Rad Emissions Test Software	MiCOM	Rad Emissions Test Software Version 1.0.73	447	Not Required
462	Schwarzbeck cable from Antenna to Amplifier.	Schwarzbeck	AK 9513	462	25 Feb 2016
463	Schwarzbeck cable from Amplifier to Bulkhead.	Schwarzbeck	AK 9513	463	25 Feb 2016
464	Schwarzbeck cable from Bulkhead to Receiver	Schwarzbeck	AK 9513	464	25 Feb 2016
465	Low Pass Filter DC-1000 MHz	Mini-Circuits	NLP-1200+	VUU01901402	18 Aug 2016
480	Cable - Bulkhead to Amp	SRC Haverhill	157-157-3050360	480	11 Aug 2016
481	Cable - Bulkhead to Receiver	SRC Haverhill	151-151-3050787	481	11 Aug 2016
482	Cable - Amp to Antenna	SRC Haverhill	157-157-3051574	482	11 Aug 2016

This test report may be reproduced in full only. The document may only be updated by MiCOM Labs personnel. All changes will be noted in the Document History section of the report.

7.3. ac Wireline Emissions

The following tests were performed using the conducted test set-up shown in the diagram below.

1. AC Wireline Conducted Emissions

Conducted Test Set-Up Pictorial Representation

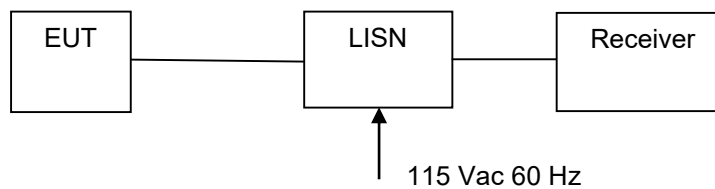

Measurement set up for ac Wireline Conducted Emissions Test

Asset#	Description	Manufacturer	Model#	Serial#	Calibration Due Date
158	Barometer/Thermometer	Control Company	4196	E2846	04 Dec 2016
184	Pulse Limiter	Rhode & Schwarz	ESH3Z2	357.8810.52	07 Jan 2016
190	LISN (two-line V-network)	Rhode & Schwarz	ESH3Z5	836679/006	29 Oct 2016
193	Receiver 20 Hz to 7 GHz	Rhode & Schwarz	ESI 7	838496/007	14 Jan 2016
287	Rohde & Schwarz 40 GHz Receiver	Rhode & Schwarz	ESIB40	100201	27 Aug 2016
307	BNC-CABLE	Megaphase	1689 1GVT4	15F50B002	07 Jan 2016
316	Dell desktop computer workstation with Vasona	Dell	Desktop	WS04	Not Required
372	AC Variable PS	California Instruments	1251P	L06951	Cal when used
378	Rohde & Schwarz 40 GHz Receiver with Generator	Rhode & Schwarz	ESIB40	100107/040	04 Aug 2016
388	LISN (3 Phase) 9kHz - 30MHz	Rohde & Schwarz	ESH2-Z5	892107/022	30 Oct 2016
ADAPT SMA#1	SMA Cable	Megaphase	SMA Cable #1	None	Cal when used

This test report may be reproduced in full only. The document may only be updated by MiCOM Labs personnel. All changes will be noted in the Document History section of the report.

8. MEASUREMENT AND PRESENTATION OF TEST DATA

The measurement and graphical data presented in this test report was generated automatically using state-of-the-art technology creating an easy to read report structure. Numerical measurement data is separated from supporting graphical data (plots) through hyperlinks. Numerical measurement data can be reviewed without scrolling through numerous graphical pages to arrive at the next data matrix.

Plots have been relegated into the Appendix 'Graphical Data'.

Test and report automation was performed by [MiTest](#). [MiTest](#) is an automated test system developed by MiCOM Labs. [MiTest](#) is the first cloud based modular test system enabling end-to-end automation of regulatory compliance testing for conducted RF testing.



The MiCOM Labs "[MiTest](#)" Automated Test System" (Patent Pending)

This test report may be reproduced in full only. The document may only be updated by MiCOM Labs personnel. All changes will be noted in the Document History section of the report.



575 Boulder Court
Pleasanton, California 94566, USA
Tel: +1 (925) 462 0304
Fax: +1 (925) 462 0306
www.micomlabs.com