

Test of APIN0224, APIN0225 802.11a/b/g/n/ac

To: FCC 47 CFR Part 15.407 & IC RSS-210

Test Report Serial No.: ARUB146-U1 Rev A



# TEST REPORT

FROM



Test of APIN0224, APIN0225 802.11a/b/g/n/ac

to

To FCC 47 CFR Part 15.407 & IC RSS-210

Test Report Serial No.: ARUB146-U1 Rev A

Note: this report contains data with regard to the 5,250 - 5,350 and 5,470 - 5,7250MHz (DFS) bands for Aruba Networks, APIN0224 and APIN0225 Wireless Access Point. 5,150 - 5,250 MHz (non-DFS) bands are reported in MiCOM Labs report ARUB145-U2 and 2.4 and 5.8 GHz test data are reported in MiCOM Labs test report ARUB145-U1

This report supersedes None

Applicant: Aruba Networks  
1344 Crossman Avenue  
Sunnyvale, California 94089  
USA

Product Function: Wireless Access Point

Copy No: pdf Issue Date: 13th June 2013

**This Test Report is Issued Under the Authority of:**

**MiCOM Labs, Inc.**  
440 Boulder Court, Suite 200  
Pleasanton, CA 94566 USA  
Phone: +1 (925) 462-0304  
Fax: +1 (925) 462-0306  
[www.micomlabs.com](http://www.micomlabs.com)



TEST CERTIFICATE #2381.01

**MiCOM Labs is an ISO 17025 Accredited Testing Laboratory**



**Title:** APIN0224, APIN0225 802.11a/b/g/n/ac  
**To:** FCC 47 CFR Part 15.407 & IC RSS-210  
**Serial #:** ARUB146-U1 Rev A  
**Issue Date:** 13th June 2013  
**Page:** 3 of 344

---

This page has been left intentionally blank

---

This test report may be reproduced in full only. The document may only be updated by MiCOM Labs personnel. Any changes will be noted in the Document History section of the report.



## TABLE OF CONTENTS

<b>ACCREDITATION, LISTINGS &amp; RECOGNITION</b> .....	<b>5</b>
TESTING ACCREDITATION .....	5
RECOGNITION .....	6
PRODUCT CERTIFICATION .....	7
<b>1. TEST RESULT CERTIFICATE</b> .....	<b>9</b>
<b>2. REFERENCES AND MEASUREMENT UNCERTAINTY</b> .....	<b>10</b>
2.1. Normative References.....	10
2.2. Test and Uncertainty Procedures.....	11
<b>3. PRODUCT DETAILS AND TEST CONFIGURATIONS</b> .....	<b>12</b>
3.1. Technical Details .....	12
3.2. Scope of Test Program .....	13
3.3. Equipment Model(s) and Serial Number(s) .....	17
3.4. Antenna Details .....	17
3.5. Cabling and I/O Ports .....	18
3.6. Test Configurations .....	19
3.7. Equipment Modifications .....	21
3.8. Deviations from the Test Standard.....	21
3.9. Subcontracted Testing or Third Party Data .....	21
<b>4. TESTING EQUIPMENT CONFIGURATION(S)</b> .....	<b>22</b>
4.1. Conducted RF Emission Test Set-up .....	22
4.2. Radiated Spurious Emission Test Set-up > 1 GHz .....	23
4.3. Digital Emissions Test Set-up (0.03 – 1 GHz).....	24
4.4. ac Wireline Emission Test Set-up .....	25
<b>5. TEST SUMMARY</b> .....	<b>26</b>
<b>6. TEST RESULTS</b> .....	<b>29</b>
6.1. Device Characteristics.....	29
6.1.1. <i>Conducted Testing</i> .....	29
6.1.2. <i>Radiated Emission Testing</i> .....	77
6.1.3. <i>AC Wireline Conducted Emissions (150 kHz – 30 MHz)</i> .....	129
<b>7. PHOTOGRAPHS</b> .....	<b>176</b>
7.1. Test Setup - Digital Emissions below 1 GHz.....	176
7.2. Radiated Emissions Test Setup >1 GHz – ANT-19 .....	178
<b>8. TEST EQUIPMENT DETAILS</b> .....	<b>180</b>
<b>APPENDIX</b> .....	<b>181</b>
<b>A. SUPPORTING INFORMATION</b> .....	<b>181</b>
A.1. CONDUCTED TEST PLOTS .....	181
A.1.1. <i>26 dB &amp; 99% Bandwidth</i> .....	182
A.1.2. <i>Peak Power Spectral Density</i> .....	259
A.1.3. <i>Peak Excursion Ratio</i> .....	334

This test report may be reproduced in full only. The document may only be updated by MiCOM Labs personnel. Any changes will be noted in the Document History section of the report.



Title: APIN0224, APIN0225 802.11a/b/g/n/ac  
To: FCC 47 CFR Part 15.407 & IC RSS-210  
Serial #: ARUB146-U1 Rev A  
Issue Date: 13th June 2013  
Page: 5 of 344

## ACCREDITATION, LISTINGS & RECOGNITION

### TESTING ACCREDITATION

MiCOM Labs, Inc. is an accredited Electrical testing laboratory per the international standard EN ISO/IEC 17025. The company is accredited by the American Association for Laboratory Accreditation (A2LA) [www.a2la.org](http://www.a2la.org) test laboratory number 2381.01. MiCOM Labs test schedule is available at the following URL; <http://www.a2la.org/scopepdf/2381-01.pdf>



This test report may be reproduced in full only. The document may only be updated by MiCOM Labs personnel. Any changes will be noted in the Document History section of the report.



## **RECOGNITION**

MiCOM Labs, Inc has widely recognized Electrical testing capabilities. Our international recognition includes Conformity Assessment Body designation by APEC MRA\*\* countries. Our test reports are widely accepted for global type approvals.

<b>Country</b>	<b>Recognition Body</b>	<b>Status</b>	<b>Phase</b>	<b>Identification No.</b>
USA	Federal Communications Commission (FCC)	TCB	-	US0159 Listing #: 102167
Canada	Industry Canada (IC)	FCB	APEC MRA 2	US0159 Listing #: 4143A-2
Japan	MIC (Ministry of Internal Affairs and Communication)	CAB	APEC MRA 2	RCB 210
	VCCI	--	--	A-0012
Europe	European Commission	NB	EU MRA	NB 2280
Australia	Australian Communications and Media Authority (ACMA)	CAB	APEC MRA 1	US0159
Hong Kong	Office of the Telecommunication Authority (OFTA)	CAB	APEC MRA 1	
Korea	Ministry of Information and Communication Radio Research Laboratory (RRL)	CAB	APEC MRA 1	
Singapore	Infocomm Development Authority (IDA)	CAB	APEC MRA 1	
Taiwan	National Communications Commission (NCC) Bureau of Standards, Metrology and Inspection (BSMI)	CAB	APEC MRA 1	
Vietnam	Ministry of Communication (MIC)	CAB	APEC MRA 1	

\*\*APEC MRA – Asia Pacific Economic Community Mutual Recognition Agreement.

Is a recognition agreement under which test lab is accredited to regulatory standards of the APEC member countries.

Phase I - recognition for product testing

Phase II – recognition for both product testing and certification

N/A – Not Applicable

\*\*EU MRA – European Union Mutual Recognition Agreement.

Is a recognition agreement under which test lab is accredited to regulatory standards of the EU member countries.

\*\*NB – Notified Body

This test report may be reproduced in full only. The document may only be updated by MiCOM Labs personnel. Any changes will be noted in the Document History section of the report.

## **PRODUCT CERTIFICATION**

MiCOM Labs, Inc. is an accredited Product Certification Body per the international standard EN ISO/IEC Guide 65. The company is accredited by the American Association for Laboratory Accreditation (A2LA) [www.a2la.org](http://www.a2la.org) test laboratory number 2381.02. MiCOM Labs test schedule is available at the following URL; <http://www.a2la.org/scopepdf/2381-02.pdf>



**USA Telecommunication Certification Body (TCB)** - TCB Identifier – US0159

**Industry Canada Certification Body** - CAB Identifier – US0159

**European Notified Body** - Notified Body Identifier - 2280

**Japan – Recognized Certification Body (RCB)** - RCB Identifier - 210

This test report may be reproduced in full only. The document may only be updated by MiCOM Labs personnel. Any changes will be noted in the Document History section of the report.



**Title:** APIN0224, APIN0225 802.11a/b/g/n/ac  
**To:** FCC 47 CFR Part 15.407 & IC RSS-210  
**Serial #:** ARUB146-U1 Rev A  
**Issue Date:** 13th June 2013  
**Page:** 8 of 344

---

## DOCUMENT HISTORY

Document History		
Revision	Date	Comments
Draft		
Rev A	13 <sup>th</sup> June 2013	Initial release

---

This test report may be reproduced in full only. The document may only be updated by MiCOM Labs personnel. Any changes will be noted in the Document History section of the report.





**Title:** APIN0224, APIN0225 802.11a/b/g/n/ac  
**To:** FCC 47 CFR Part 15.407 & IC RSS-210  
**Serial #:** ARUB146-U1 Rev A  
**Issue Date:** 13th June 2013  
**Page:** 9 of 344

## 1. TEST RESULT CERTIFICATE

<b>Applicant:</b>	Aruba Networks 1344 Crossman Avenue Sunnyvale, California 94089 USA	<b>Tested By:</b>	MiCOM Labs, Inc. 440 Boulder Court Suite 200 Pleasanton California, 94566, USA
<b>EUT:</b>	Wireless LAN Access point	<b>Tel:</b>	+1 925 462 0304
<b>Model:</b>	APIN0224 & APIN0225	<b>Fax:</b>	+1 925 462 0306
<b>S/N:</b>	BX0000206		
<b>Test Date(s):</b>	15th January - 31st March 2013	<b>Website:</b>	www.micomlabs.com

STANDARD(S)	TEST RESULTS
FCC 47 CFR Part 15.407 & IC RSS-210 (DFS Bands Only)	EQUIPMENT COMPLIES

MiCOM Labs, Inc. tested the equipment mentioned in accordance with the requirements set forth in the above standards. Test results indicate that the equipment tested is capable of demonstrating compliance with the requirements as documented within this report.

### Notes:

1. This document reports conditions under which testing was conducted and the results of testing performed.
2. Details of test methods used have been recorded and kept on file by the laboratory.
3. Test results apply only to the item(s) tested.

Approved & Released for MiCOM Labs, Inc. by:

  
\_\_\_\_\_  
Graeme Grieve  
Quality Manager MiCOM Labs,

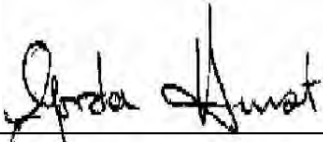
  
\_\_\_\_\_  
Gordon Hurst  
President & CEO MiCOM Labs, Inc.



TESTING CERTIFICATE #2381.01

This test report may be reproduced in full only. The document may only be updated by MiCOM Labs personnel. Any changes will be noted in the Document History section of the report.

## 2. REFERENCES AND MEASUREMENT UNCERTAINTY

### 2.1. Normative References

Ref.	Publication	Year	Title
(i)	FCC 47 CFR Part 15.407	2012	Code of Federal Regulations
(ii)	FCC 06-96	June 2006	Memorandum Opinion and Order
(iii)	FCC OET KDB 662911	4 <sup>th</sup> April 2011	Emissions Testing of Transmitters with Multiple Outputs in the Same Band
(iv)	Industry Canada RSS-210	2010	Low Power License-Exempt Radiocommunication Devices (All Frequency Bands): Category 1 Equipment
(v)	Industry Canada RSS-Gen	2010	General Requirements and Information for the Certification of Radiocommunication Equipment
(vi)	ANSI C63.4	2009	American National Standards for Methods of Measurement of Radio-Noise Emissions from Low-Voltage Electrical and Electronic Equipment in the Range of 9 kHz to 40 GHz
(vii)	CISPR 22/ EN 55022	2008 2006+A1:2007	Limits and Methods of Measurements of Radio Disturbance Characteristics of Information Technology Equipment
(viii)	M 3003	Edition 1 Dec. 1997	Expression of Uncertainty and Confidence in Measurements
(ix)	LAB34	Edition 1 Aug 2002	The expression of uncertainty in EMC Testing
(x)	ETSI TR 100 028	2001	Parts 1 and 2 Electromagnetic compatibility and Radio Spectrum Matters (ERM); Uncertainties in the measurement of mobile radio equipment characteristics
(xi)	A2LA	July 2012	Reference to A2LA Accreditation Status – A2LA Advertising Policy
(xii)	FCC Public Notice – DA 02-2138	2002	Guidelines for Assessing Unlicensed National Information Infrastructure (U-NII) Devices



**Title:** APIN0224, APIN0225 802.11a/b/g/n/ac  
**To:** FCC 47 CFR Part 15.407 & IC RSS-210  
**Serial #:** ARUB146-U1 Rev A  
**Issue Date:** 13th June 2013  
**Page:** 11 of 344

---

## **2.2. Test and Uncertainty Procedures**

Conducted and radiated emission measurements were conducted in accordance with American National Standards Institute ANSI C63.4, listed in the Normative References section of this report.

Measurement uncertainty figures are calculated in accordance with ETSI TR 100 028 Parts 1 and 2.

Measurement uncertainties stated are based on a standard uncertainty multiplied by a coverage factor  $k = 2$ , providing a level of confidence of approximately 95 % in accordance with UKAS document M 3003 listed in the Normative References section of this report.

---

This test report may be reproduced in full only. The document may only be updated by MiCOM Labs personnel. Any changes will be noted in the Document History section of the report.



**Title:** APIN0224, APIN0225 802.11a/b/g/n/ac  
**To:** FCC 47 CFR Part 15.407 & IC RSS-210  
**Serial #:** ARUB146-U1 Rev A  
**Issue Date:** 13th June 2013  
**Page:** 12 of 344

### 3. PRODUCT DETAILS AND TEST CONFIGURATIONS

#### 3.1. Technical Details

Details	Description
Purpose:	Test of the APIN0224, APIN0225 802.11a/b/g/n/ac in the frequency range 5,150 - 5,250, 5,250 – 5,350 and 5,470 - 5725 MHz to FCC Part 15.407 and Industry Canada RSS-210 regulations.
Applicant:	Aruba Networks 1344 Crossman Avenue Sunnyvale, California 94089, USA
Manufacturer:	As applicant
Laboratory performing the tests:	MiCOM Labs, Inc. 440 Boulder Court, Suite 200 Pleasanton, California 94566 USA
Test report reference number:	ARUB146-U1 Rev A
Date EUT received:	4 <sup>th</sup> January 2013
Standard(s) applied:	FCC 47 CFR Part 15.407 & IC RSS-210
Dates of test (from - to):	15th January - 31st March 2013
No of Units Tested:	One
Type of Equipment:	802.11a/b/g/n/ac Wireless Access Point 3x3 Spatial Multiplexing MIMO configuration
Applicants Trade Name:	Wireless Access Point
Model(s):	APIN0224, APIN0225
Location for use:	Indoor only
Declared Frequency Range(s):	5,150 – 5,250, 5250 – 5,350 and 5,470 – 5,725 MHz
Hardware Rev	6.3.0.0
Software Rev	37654
Type of Modulation:	Per 802.11 – OFDM
EUT Modes of Operation:	Legacy 802.11a, 802.11n HT-20, HT-40
Declared Nominal Output Power: (Average Power)	802.11a: Legacy +18 dBm, 802.11n: HT-20 +18 dBm 802.11n: HT-40 +18 dBm 802.11ac-40 +18 dBm, 802.11ac-80 +18 dBm
Transmit/Receive Operation:	Time Division Duplex
Rated Input Voltage and Current:	POE 12 Vdc 1.25 A
Operating Temperature Range:	Declared range -20° to +40°C
ITU Emission Designator:	802.11a 17M7D1D 802.11n HT-20 17M7D1D 802.11n HT-40 36M4D1D 802.11ac-40 36M9D1D 802.11ac-80 75M9D1D
Equipment Dimensions:	203mm x 203mm x 65mm / 8.0"x8.0"x2.6" (WxDxH)
Weight:	750 g / 27 oz
Primary function of equipment:	Wireless Access Point for transmitting data and voice.

This test report may be reproduced in full only. The document may only be updated by MiCOM Labs personnel. Any changes will be noted in the Document History section of the report.



**Title:** APIN0224, APIN0225 802.11a/b/g/n/ac  
**To:** FCC 47 CFR Part 15.407 & IC RSS-210  
**Serial #:** ARUB146-U1 Rev A  
**Issue Date:** 13th June 2013  
**Page:** 13 of 344

---

### 3.2. Scope of Test Program

#### **Aruba Networks APIN0224, APIN0225 Access Point RF Testing**

The scope of the test program was to test the Aruba Networks APIN0224, APIN0225 Wireless LAN Access Point, 3X3 Spatial Multiplexing MIMO configurations in the frequency range 5,250 – 5,350 and 5,470 – 5,725 MHz for compliance against FCC 47 CFR Part 15.407 and Industry Canada RSS-210 specifications.

#### **FCC OET KDB Implementation**

This test program implements the following FCC KDB – 662911 4/4/2011;

#### ***Emissions Testing of Transmitters with Multiple Outputs in the Same Band***

The KDB document provides guidance for measurements of conducted output emissions of devices that employ a single transmitter with multiple outputs in the same band, with the outputs occupying the same or overlapping frequency ranges. It applies to EMC compliance measurements on devices that transmit on multiple antennas simultaneously in the same or overlapping frequency ranges through a coordinated process. Examples include, but are not limited to, devices employing beam forming or multiple-input and multiple-output (MIMO.) This guidance applies to both licensed and unlicensed devices wherever the FCC rules call for conducted output measurements. Guidance is provided for in-band, out-of-band and spurious emission measurements.

This guidance does not apply to the multiple transmitters included in a composite device, such as a device that combines an 802.11 modem with a cell phone in one enclosure with each driving its own antenna.

---

This test report may be reproduced in full only. The document may only be updated by MiCOM Labs personnel. Any changes will be noted in the Document History section of the report.

Aruba Networks Inc  
APIN0224 External Antenna 802.11 a/b/g/n/ac Wireless Access Point



This test report may be reproduced in full only. The document may only be updated by MiCOM Labs personnel. Any changes will be noted in the Document History section of the report.

Aruba Networks Inc  
APIN0225 Integral Antenna 802.11 a/b/g/n/ac Wireless Access Point



This test report may be reproduced in full only. The document may only be updated by MiCOM Labs personnel. Any changes will be noted in the Document History section of the report.

Aruba Networks Inc  
802.11 a/b/g/n/ac Wireless Access Point (Rear)







### 3.3. Equipment Model(s) and Serial Number(s)

Type (EUT/Support)	Equipment Description (Including Brand Name)	Mfr	Model No.	Serial No.
EUT	Wireless LAN Access Point	Aruba Networks	APIN0224	BX0000206
Support	Laptop PC	IBM	Thinkpad	None

### 3.4. Antenna Details

Model	Type	Gain	Freq. Band	Note
		dBi	MHz	
AP-ANT-1B	Omni	3.8	2400 - 2500	(2x per unit)
		5.8	4900 - 5875	
AP-ANT-13B	Omni	4.4	2400 - 2500	(2x per unit)
		3.3	4900 - 5900	
AP-ANT-16	Omni	3.9	2400 - 2500	(1x per unit) 3x3 MIMO
		4.7	4900 - 5900	
AP-ANT-17	Directional 120degr.	6.0	2400 - 2500	(1x per unit) 3x3 MIMO
		5.0	4900 - 5875	
AP-ANT-18	Directional 60degr.	7.5	2400 - 2500	(1x per unit) 3x3 MIMO
		7.5	5150 - 5875	
AP-ANT-19	Omni	3.0	2400 - 2500	(2 x per unit)
		6.0	5150 - 5875	

This test report may be reproduced in full only. The document may only be updated by MiCOM Labs personnel. Any changes will be noted in the Document History section of the report.



**APIN0225 Integrated Antennas**

Model	Type	Gain	Freq. Band	Note
		dBi	MHz	
metal sheet	Omni	4.0	2400 - 2500	(3x per band, per unit)
		5.0	4900 - 5875	

### 3.5. Cabling and I/O Ports

Number and type of I/O ports

1. 2 x 10/100/1000 Ethernet ENET0, ENET1
2. Console - Serial maintenance terminal
3. 12 Vdc, supply connector
4. RF Antenna Connectors (x3) – Reverse SMA (APIN0224 Only)
5. USB



### 3.6. Test Configurations

Testing was performed to determine the highest power level versus bit rate. The variant with the highest power was used to exercise the product.

Matrix of test configurations

Operational Mode(s) (802.11)	Variant	Data Rates with Highest Power	Frequencies (MHz)
5250-5350 5470-5725	802.11a	6 MBit/s	5260,5280,5300,5320 5500,5580,5700
	802.11n HT-20	6.5 MBit/s	
	802.11n HT-40	13.5 MBit/s	5270,5310 5510,5550,5670
	ac-40		
	ac-80	29.3 MBit/s	5290 5530, 5690

---

This test report may be reproduced in full only. The document may only be updated by MiCOM Labs personnel. Any changes will be noted in the Document History section of the report.



**Spurious Emission and Band-Edge Test Strategy  
Bands 5,250 – 5,350**

11a	11n HT-20	11n HT-40	11ac-40	11ac-80
SE 5260	SE 5260	SE 5270	SE 5270	SE 5290
SE 5300	SE 5300			
SE 5320	SE 5320	SE 5310	SE 5310	
BE 5350	BE 5350	BE 5350	BE 5350	BE 5350

**Band 5,470 – 5,725**

11a	11n HT-20	11n HT-40	11ac-40	11ac-80
SE 5500	SE 5500	SE 5510	SE 5510	SE 5530
SE 5580	SE 5580	SE 5550	SE 5550	
SE 5700	SE 5700	SE 5670	SE 5670	SE 5690
BE 5470	BE 5470	BE 5470	BE 5470	BE 5470

KEY:-

SE – Spurious Emissions

BE – Band-Edge



**Title:** APIN0224, APIN0225 802.11a/b/g/n/ac  
**To:** FCC 47 CFR Part 15.407 & IC RSS-210  
**Serial #:** ARUB146-U1 Rev A  
**Issue Date:** 13th June 2013  
**Page:** 21 of 344

---

### **3.7. Equipment Modifications**

The following modifications were required to bring the equipment into compliance:

1. NONE

### **3.8. Deviations from the Test Standard**

The following deviations from the test standard were required in order to complete the test program:

1. NONE

### **3.9. Subcontracted Testing or Third Party Data**

1. NONE

---

This test report may be reproduced in full only. The document may only be updated by MiCOM Labs personnel. Any changes will be noted in the Document History section of the report.

## 4. TESTING EQUIPMENT CONFIGURATION(S)

### 4.1. Conducted RF Emission Test Set-up

The following tests were performed using the conducted test set-up shown in the diagram below.

1. Section 6.1.1.1. 26 dB and 99% Bandwidth
2. Section 6.1.1.2. Maximum Conducted Output Power
3. Section 6.1.1.3. Peak Power Spectral Density
4. Section 6.1.1.4. Peak Excursion Ratio

#### Conducted Test Set-Up Pictorial Representation

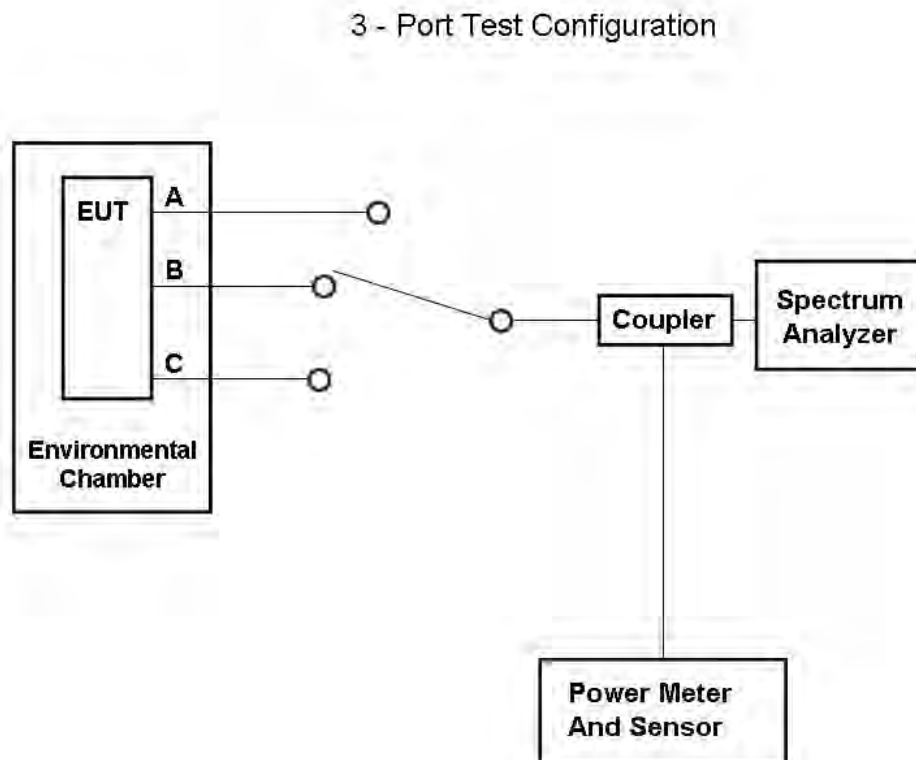

This test report may be reproduced in full only. The document may only be updated by MiCOM Labs personnel. Any changes will be noted in the Document History section of the report.

#### 4.2. Radiated Spurious Emission Test Set-up > 1 GHz

The following tests were performed using the conducted test set-up shown in the diagram below.

#### Radiated Emission Measurement Setup – Above 1 GHz

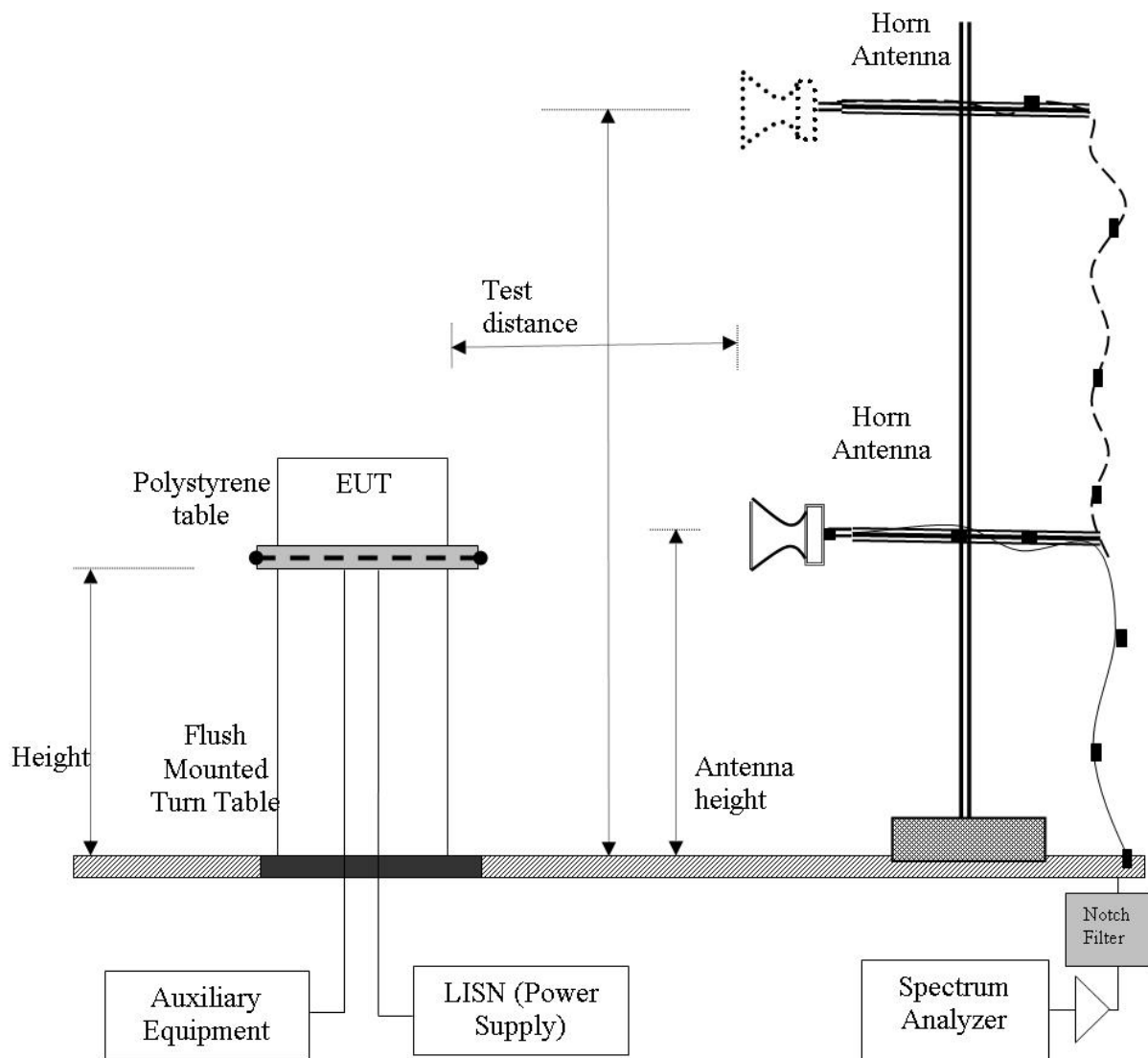

This test report may be reproduced in full only. The document may only be updated by MiCOM Labs personnel. Any changes will be noted in the Document History section of the report.

### 4.3. Digital Emissions Test Set-up (0.03 – 1 GHz)

The following tests were performed using the conducted test set-up shown in the diagram below.

1. Section 6.1.2.4. Digital Emissions

#### Digital Emission Measurement Setup – Below 1 GHz

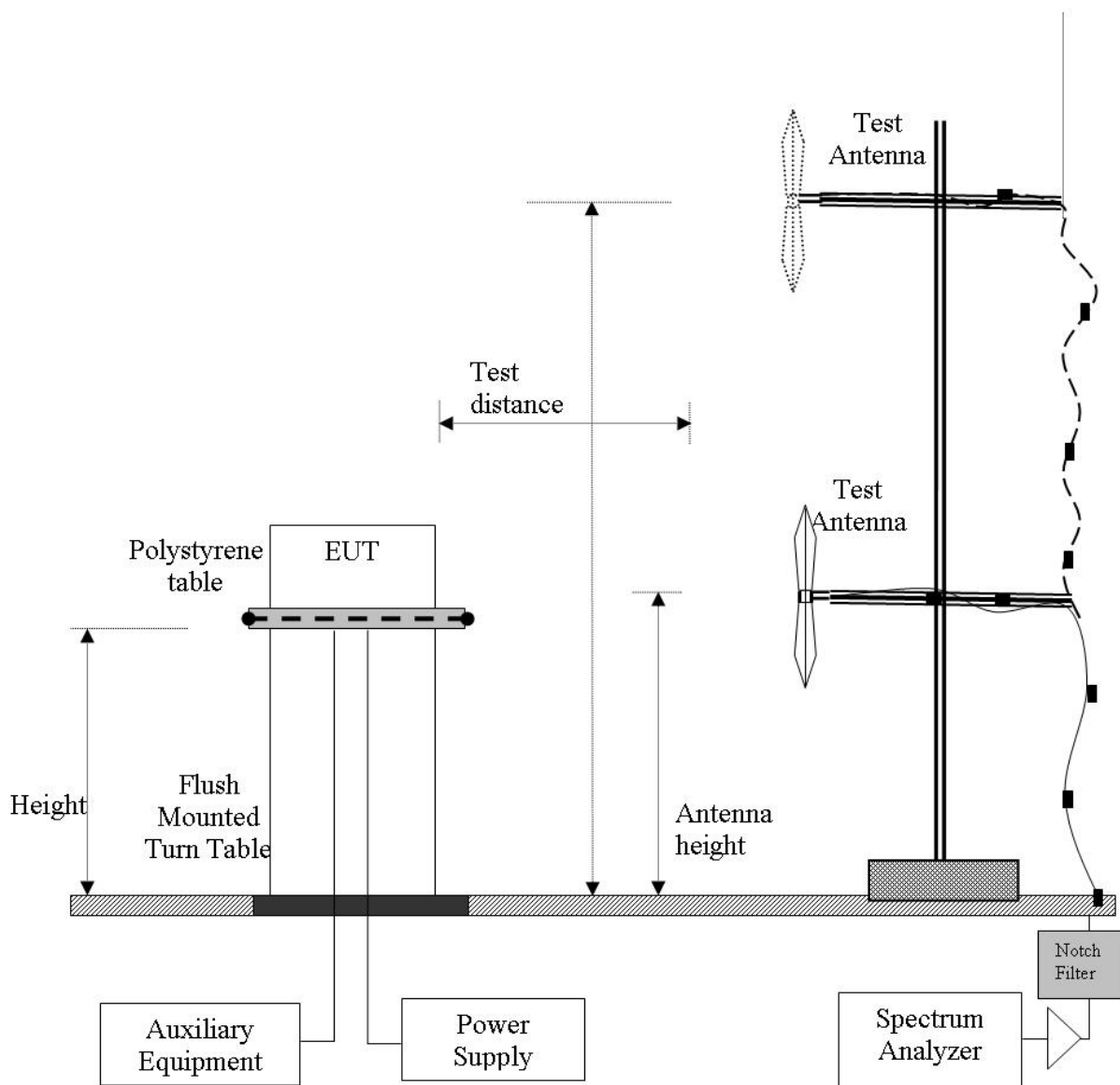

This test report may be reproduced in full only. The document may only be updated by MiCOM Labs personnel. Any changes will be noted in the Document History section of the report.



#### 4.4. ac Wireline Emission Test Set-up

The following tests were performed using the conducted test set-up shown in the diagram below.

##### 1. Section 6.1.3 ac Wireline Conducted Emissions

#### Conducted Test Set-Up Pictorial Representation

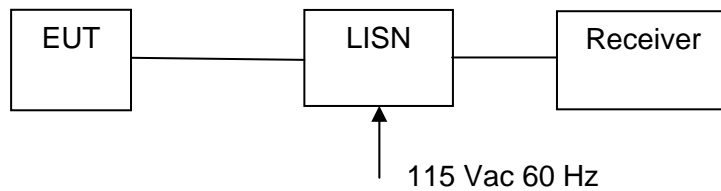

Measurement set up for ac Wireline Conducted Emissions Test



## 5. TEST SUMMARY

### List of Measurements

The following table represents the list of measurements required under the **FCC CFR47 Part 15.407** and **Industry Canada RSS-210** and **Industry Canada RSS-Gen**.

Section(s)	Test Items	Description	Condition	Result	Test Report Section
<b>15.407(a)</b> <b>A9.2(2)</b> <b>4.4</b>	26dB and 99% Emission BW	Emission bandwidth measurement	Conducted	Complies	6.1.1.1 A.1.1
<b>15.407(a)</b> <b>A9.2(2)</b> <b>4.6</b>	Maximum Conducted Output Power	Power Measurement	Conducted	Complies	6.1.1.2
<b>15.407(a)</b> <b>A9.2(2)</b>	Peak Power Spectral Density	PPSD	Conducted	Complies	6.1.1.3 A.1.2
<b>15.407(a)(6)</b>	Peak Excursion Ratio	<13dB in any 1MHz bandwidth	Conducted	Complies	6.1.1.4 A.1.3
<b>15.407(g)</b> <b>15.31</b> <b>2.1</b> <b>4.5</b>	Frequency Stability	Limits: contained within band of operation at all times.	Applicant declaration	Complies	6.1.1.5
<b>15.407(f)</b> <b>5.5</b>	Radio Frequency Radiation Exposure	Exposure to radio frequency energy levels, Maximum Permissible Exposure (MPE)	Conducted	See included MPE exhibit	--

This test report may be reproduced in full only. The document may only be updated by MiCOM Labs personnel. Any changes will be noted in the Document History section of the report.



**List of Measurements (continued)**

The following table represents the list of measurements required under the **FCC CFR47 Part 15.407** and **Industry Canada RSS-210** and **Industry Canada RSS-Gen**.

Section(s)	Test Items	Description	Condition	Result	Test Report Section
<b>15.407(b)(2)</b> <b>15.205(a)</b> <b>15.209(a)</b> <b>2.2</b> <b>2.6</b> <b>A9.3(2)</b> <b>4.7</b>	Radiated Emissions		Radiated		6.1.2
	Transmitter Radiated Spurious Emissions	Emissions above 1 GHz		Complies	6.1.2.1 6.1.2.2 6.1.2.3
	Radiated Band Edge	Band edge results		Complies	6.1.2.1 6.1.2.2 6.1.2.3
<b>15.407(b)(6)</b> <b>15.205(a)</b> <b>15.209(a)</b> <b>2.2</b>	Radiated Emissions	Emissions <1 GHz (30M-1 GHz)		Complies	6.1.2.4
<b>15.407(b)(6)</b> <b>15.207</b> <b>7.2.2</b>	AC Wireline Conducted Emissions 150 kHz–30 MHz	Conducted Emissions	Conducted	Complies ac/dc adaptor only, POE not marketed with equipment	6.1.3

Note 1: Test results reported in this document relate only to the items tested

Note 2: The required tests demonstrated compliance as per client declaration of test configuration, monitoring methodology and associated pass/fail criteria

Note 3: Section 3.7 Equipment Modifications highlights the equipment modifications that were required to bring the product into compliance with the above test matrix



## List of Measurements (cont'd)

### Dynamic Frequency Selection (DFS)

The following table represents the list of measurements required under the **FCC CFR47 Part 15.407(h)(2)** and **FCC Memorandum Opinion and Order FCC 06-96 (Compliance Measurement procedures for Unlicensed National Information Infrastructure devices operating in the 5250-5350 MHz and 5470-5725 MHz bands incorporating dynamic frequency selection)**.

### Tests performed on Master Device

Section	Test Items	Description	Condition	Result	Test Report Section
	DFS	Dynamic Frequency Selection	Conducted		6.1.4
7.8.1	Detection Bandwidth	UNII Detection Bandwidth	Conducted	Complies	
7.8.2.1	Performance Requirements Check	Initial Channel Availability Check Time	Conducted	Complies	
7.8.2.2		Radar Burst at the Beginning of the Channel Availability Check Time	Conducted	Complies	
7.8.2.3		Radar Burst at the End of the Channel Availability Check Time	Conducted	Complies	
7.8.3	In-Service Monitoring	In-Service Monitoring for Channel Move Time, Channel Closing Transmission Time and Non-Occupancy Period	Conducted	Complies	
7.8.4	Radar Detection	Statistical Performance Check	Conducted	Complies	

This test report may be reproduced in full only. The document may only be updated by MiCOM Labs personnel. Any changes will be noted in the Document History section of the report.



**Title:** APIN0224, APIN0225 802.11a/b/g/n/ac  
**To:** FCC 47 CFR Part 15.407 & IC RSS-210  
**Serial #:** ARUB146-U1 Rev A  
**Issue Date:** 13th June 2013  
**Page:** 29 of 344

## 6. TEST RESULTS

### 6.1. Device Characteristics

#### 6.1.1. Conducted Testing

##### 6.1.1.1. 26 dB and 99 % Bandwidth

Conducted Test Conditions for 26 dB and 99% Bandwidth			
<b>Standard:</b>	FCC CFR 47:15.407	<b>Ambient Temp. (°C):</b>	24.0 - 27.5
<b>Test Heading:</b>	26 dB and 99 % Bandwidth	<b>Rel. Humidity (%):</b>	32 - 45
<b>Standard Section(s):</b>	15.407 (a)	<b>Pressure (mBars):</b>	999 - 1001
<b>Reference Document(s):</b>	KDB 789033 - D01 DTS General UNII Test Procedures v01		

**Test Procedure for 26 dB and 99% Bandwidth Measurement**

The bandwidth at 26 dB and 99 % is measured with a spectrum analyzer connected to the antenna terminal, while EUT is operating in transmission mode at the appropriate center frequency. KDB 789033 Section 5.1 Emission Bandwidth was used in order to prove compliance. The Resolution Bandwidth was set to approximately 1% of the emission bandwidth.

This test report may be reproduced in full only. The document may only be updated by MiCOM Labs personnel. Any changes will be noted in the Document History section of the report.



**Title:** APIN0224, APIN0225 802.11a/b/g/n/ac  
**To:** FCC 47 CFR Part 15.407 & IC RSS-210  
**Serial #:** ARUB146-U1 Rev A  
**Issue Date:** 13th June 2013  
**Page:** 30 of 344

### Measurement Results for 26 dB and 99 % Operational Bandwidth(s)

#### Equipment Configuration for 26 dB & 99% Occupied Bandwidth

<b>Variant:</b>	802.11a	<b>Duty Cycle (%):</b>	99%
<b>Data Rate:</b>	6 MBit/s	<b>Antenna Gain (dBi):</b>	Not Applicable
<b>Modulation:</b>	OFDM	<b>Beam Forming Gain (Y):</b>	Not Applicable
<b>TPC:</b>	Not Applicable		
<b>Engineering Test Notes:</b>	Not Applicable		

#### Test Measurement Results

Test Frequency	Measured 26 dB Bandwidth (MHz)				26 dB Bandwidth (MHz)			
	Port(s)				Highest	Lowest		
MHz	a	b	c	d				
5260.0	20.641	30.160	23.246	--	30.160	20.641		
5300.0	20.641	30.461	21.743	--	30.461	20.641		
5320.0	20.641	27.154	22.345	--	27.154	20.641		

Test Frequency	Measured 99% Bandwidth (MHz)				99% Bandwidth (MHz)			
	Port(s)				Highest	Lowest		
MHz	a	b	c	d				
5260.0	17.936	18.136	17.936	--	18.136	17.936		
5300.0	17.936	18.136	17.936	--	18.136	17.936		
5320.0	17.936	18.036	17.936	--	18.036	17.936		

#### Traceability to Industry Recognized Test Methodologies

Work Instruction:	WI-03 MEASURING RF SPECTRUM MASK
Measurement Uncertainty:	±2.81 dB

This test report may be reproduced in full only. The document may only be updated by MiCOM Labs personnel. Any changes will be noted in the Document History section of the report.



**Title:** APIN0224, APIN0225 802.11a/b/g/n/ac  
**To:** FCC 47 CFR Part 15.407 & IC RSS-210  
**Serial #:** ARUB146-U1 Rev A  
**Issue Date:** 13th June 2013  
**Page:** 31 of 344

**Equipment Configuration for 26 dB & 99% Occupied Bandwidth**

<b>Variant:</b>	802.11n HT-20	<b>Duty Cycle (%):</b>	99%
<b>Data Rate:</b>	6.5 MBit/s	<b>Antenna Gain (dBi):</b>	Not Applicable
<b>Modulation:</b>	OFDM	<b>Beam Forming Gain (Y):</b>	Not Applicable
<b>TPC:</b>	Not Applicable		
<b>Engineering Test Notes:</b>	Not Applicable		

**Test Measurement Results**

Test Frequency	Measured 26 dB Bandwidth (MHz)				26 dB Bandwidth (MHz)			
	Port(s)				Highest	Lowest		
MHz	a	b	c	d				
5260.0	20.641	29.559	23.246	--	29.559	20.641		
5300.0	20.741	30.361	22.244	--	30.361	20.741		
5320.0	20.641	31.363	22.244	--	31.363	20.641		

Test Frequency	Measured 99% Bandwidth (MHz)				99% Bandwidth (MHz)			
	Port(s)				Highest	Lowest		
MHz	a	b	c	d				
5260.0	17.936	18.136	17.936	--	18.136	17.936		
5300.0	17.936	18.136	17.936	--	18.136	17.936		
5320.0	17.936	18.136	17.836	--	18.136	17.836		

**Traceability to Industry Recognized Test Methodologies**

Work Instruction:	WI-03 MEASURING RF SPECTRUM MASK
Measurement Uncertainty:	±2.81 dB

This test report may be reproduced in full only. The document may only be updated by MiCOM Labs personnel. Any changes will be noted in the Document History section of the report.



**Title:** APIN0224, APIN0225 802.11a/b/g/n/ac  
**To:** FCC 47 CFR Part 15.407 & IC RSS-210  
**Serial #:** ARUB146-U1 Rev A  
**Issue Date:** 13th June 2013  
**Page:** 32 of 344

**Equipment Configuration for 26 dB & 99% Occupied Bandwidth**

<b>Variant:</b>	802.11n HT-40	<b>Duty Cycle (%):</b>	99%
<b>Data Rate:</b>	13.5 MBit/s	<b>Antenna Gain (dBi):</b>	Not Applicable
<b>Modulation:</b>	OFDM	<b>Beam Forming Gain (Y):</b>	Not Applicable
<b>TPC:</b>	Not Applicable		
<b>Engineering Test Notes:</b>	Not Applicable		

**Test Measurement Results**

Test Frequency	Measured 26 dB Bandwidth (MHz)				26 dB Bandwidth (MHz)			
	Port(s)				Highest	Lowest		
MHz	a	b	c	d				
5270.0	40.080	39.679	39.880	--	40.080	39.679		
5310.0	40.281	39.679	39.679	--	40.281	39.679		

Test Frequency	Measured 99% Bandwidth (MHz)				99% Bandwidth (MHz)			
	Port(s)				Highest	Lowest		
MHz	a	b	c	d				
5270.0	36.473	36.273	36.273	--	36.473	36.273		
5310.0	36.673	36.273	36.473	--	36.673	36.273		

**Traceability to Industry Recognized Test Methodologies**

Work Instruction:	WI-03 MEASURING RF SPECTRUM MASK
Measurement Uncertainty:	±2.81 dB

This test report may be reproduced in full only. The document may only be updated by MiCOM Labs personnel. Any changes will be noted in the Document History section of the report.





**Title:** APIN0224, APIN0225 802.11a/b/g/n/ac  
**To:** FCC 47 CFR Part 15.407 & IC RSS-210  
**Serial #:** ARUB146-U1 Rev A  
**Issue Date:** 13th June 2013  
**Page:** 33 of 344

**Equipment Configuration for 26 dB & 99% Occupied Bandwidth**

<b>Variant:</b>	802.11ac-40	<b>Duty Cycle (%):</b>	99%
<b>Data Rate:</b>	13.5 MBit/s	<b>Antenna Gain (dBi):</b>	Not Applicable
<b>Modulation:</b>	OFDM	<b>Beam Forming Gain (Y):</b>	Not Applicable
<b>TPC:</b>	Not Applicable		
<b>Engineering Test Notes:</b>	Not Applicable		

**Test Measurement Results**

Test Frequency	Measured 26 dB Bandwidth (MHz)				26 dB Bandwidth (MHz)			
	Port(s)				Highest	Lowest		
MHz	a	b	c	d				
5270.0	40.281	56.713	49.098	--	56.713	40.281		
5310.0	40.281	57.315	45.491	--	57.315	40.281		

Test Frequency	Measured 99% Bandwidth (MHz)				99% Bandwidth (MHz)			
	Port(s)				Highest	Lowest		
MHz	a	b	c	d				
5270.0	36.673	36.874	36.673	--	36.874	36.673		
5310.0	36.673	36.673	36.673	--	36.673	36.673		

**Traceability to Industry Recognized Test Methodologies**

Work Instruction:	WI-03 MEASURING RF SPECTRUM MASK
Measurement Uncertainty:	±2.81 dB

This test report may be reproduced in full only. The document may only be updated by MiCOM Labs personnel. Any changes will be noted in the Document History section of the report.



**Title:** APIN0224, APIN0225 802.11a/b/g/n/ac  
**To:** FCC 47 CFR Part 15.407 & IC RSS-210  
**Serial #:** ARUB146-U1 Rev A  
**Issue Date:** 13th June 2013  
**Page:** 34 of 344

**Equipment Configuration for 26 dB & 99% Occupied Bandwidth**

<b>Variant:</b>	802.11ac-80	<b>Duty Cycle (%):</b>	99%
<b>Data Rate:</b>	29.3 MBit/s	<b>Antenna Gain (dBi):</b>	Not Applicable
<b>Modulation:</b>	OFDM	<b>Beam Forming Gain (Y):</b>	Not Applicable
<b>TPC:</b>	Not Applicable		
<b>Engineering Test Notes:</b>	Not Applicable		

**Test Measurement Results**

Test Frequency	Measured 26 dB Bandwidth (MHz)				26 dB Bandwidth (MHz)			
	Port(s)				Highest	Lowest		
MHz	a	b	c	d				
5290.0	84.168	119.439	84.569		119.439	84.168		

Test Frequency	Measured 99% Bandwidth (MHz)				99% Bandwidth (MHz)			
	Port(s)				Highest	Lowest		
MHz	a	b	c	d				
5290.0	76.152	76.553	76.152		76.553	76.152		

**Traceability to Industry Recognized Test Methodologies**

Work Instruction:	WI-03 MEASURING RF SPECTRUM MASK
Measurement Uncertainty:	±2.81 dB

This test report may be reproduced in full only. The document may only be updated by MiCOM Labs personnel. Any changes will be noted in the Document History section of the report.



**Title:** APIN0224, APIN0225 802.11a/b/g/n/ac  
**To:** FCC 47 CFR Part 15.407 & IC RSS-210  
**Serial #:** ARUB146-U1 Rev A  
**Issue Date:** 13th June 2013  
**Page:** 35 of 344

**Equipment Configuration for 26 dB & 99% Occupied Bandwidth**

<b>Variant:</b>	802.11a	<b>Duty Cycle (%):</b>	99%
<b>Data Rate:</b>	6 MBit/s	<b>Antenna Gain (dBi):</b>	Not Applicable
<b>Modulation:</b>	OFDM	<b>Beam Forming Gain (Y):</b>	Not Applicable
<b>TPC:</b>	Not Applicable		
<b>Engineering Test Notes:</b>			

**Test Measurement Results**

Test Frequency	Measured 26 dB Bandwidth (MHz)				26 dB Bandwidth (MHz)			
	Port(s)				Highest	Lowest		
MHz	a	b	c	d				
5500.0	22.044	21.142	27.255	-	27.255	21.142		
5580.0	20.842	24.749	22.244	-	24.749	20.842		
5700.0	23.347	26.453	20.641	-	26.453	20.641		

Test Frequency	Measured 99% Bandwidth (MHz)				99% Bandwidth (MHz)			
	Port(s)				Highest	Lowest		
MHz	a	b	c	d				
5500.0	18.036	17.836	17.936	-	18.036	17.836		
5580.0	17.936	17.836	17.836	-	17.936	17.836		
5700.0	17.936	17.936	17.836	-	17.936	17.836		

**Traceability to Industry Recognized Test Methodologies**

Work Instruction:	WI-03 MEASURING RF SPECTRUM MASK
Measurement Uncertainty:	±2.81 Db

This test report may be reproduced in full only. The document may only be updated by MiCOM Labs personnel. Any changes will be noted in the Document History section of the report.



**Title:** APIN0224, APIN0225 802.11a/b/g/n/ac  
**To:** FCC 47 CFR Part 15.407 & IC RSS-210  
**Serial #:** ARUB146-U1 Rev A  
**Issue Date:** 13th June 2013  
**Page:** 36 of 344

**Equipment Configuration for 26 dB & 99% Occupied Bandwidth**

<b>Variant:</b>	802.11n HT-20	<b>Duty Cycle (%):</b>	99%
<b>Data Rate:</b>	6.5 MBit/s	<b>Antenna Gain (dBi):</b>	Not Applicable
<b>Modulation:</b>	OFDM	<b>Beam Forming Gain (Y):</b>	Not Applicable
<b>TPC:</b>	Not Applicable		
<b>Engineering Test Notes:</b>			

**Test Measurement Results**

Test Frequency	Measured 26 dB Bandwidth (MHz)				26 dB Bandwidth (MHz)			
	Port(s)				Highest	Lowest		
MHz	a	b	c	d				
5500.0	23.447	20.641	27.956	-	27.956	20.641		
5580.0	20.842	23.547	21.042	-	23.547	20.842		
5700.0	21.844	26.854	20.541	-	26.854	20.541		

Test Frequency	Measured 99% Bandwidth (MHz)				99% Bandwidth (MHz)			
	Port(s)				Highest	Lowest		
MHz	a	b	c	d				
5500.0	17.936	17.836	17.936	-	17.936	17.836		
5580.0	17.936	17.836	17.836	-	17.936	17.836		
5700.0	18.036	17.936	17.836	-	18.036	17.836		

**Traceability to Industry Recognized Test Methodologies**

Work Instruction:	WI-03 MEASURING RF SPECTRUM MASK
Measurement Uncertainty:	±2.81 dB

This test report may be reproduced in full only. The document may only be updated by MiCOM Labs personnel. Any changes will be noted in the Document History section of the report.



**Title:** APIN0224, APIN0225 802.11a/b/g/n/ac  
**To:** FCC 47 CFR Part 15.407 & IC RSS-210  
**Serial #:** ARUB146-U1 Rev A  
**Issue Date:** 13th June 2013  
**Page:** 37 of 344

**Equipment Configuration for 26 dB & 99% Occupied Bandwidth**

<b>Variant:</b>	802.11n HT-40	<b>Duty Cycle (%):</b>	99%
<b>Data Rate:</b>	13.5 MBit/s	<b>Antenna Gain (dBi):</b>	Not Applicable
<b>Modulation:</b>	OFDM	<b>Beam Forming Gain (Y):</b>	Not Applicable
<b>TPC:</b>	Not Applicable		
<b>Engineering Test Notes:</b>			

**Test Measurement Results**

Test Frequency	Measured 26 dB Bandwidth (MHz)				26 dB Bandwidth (MHz)			
	Port(s)				Highest	Lowest		
MHz	a	b	c	d				
5510.0	40.281	39.880	40.080	-	40.281	39.880		
5550.0	40.281	39.880	40.281	-	40.281	39.880		
5670.0	40.481	39.679	39.679	-	40.481	39.679		

Test Frequency	Measured 99% Bandwidth (MHz)				99% Bandwidth (MHz)			
	Port(s)				Highest	Lowest		
MHz	a	b	c	d				
5510.0	36.673	36.473	36.673	-	36.673	36.473		
5550.0	36.473	36.473	36.673	-	36.673	36.473		
5670.0	36.473	36.473	36.473	-	36.473	36.473		

**Traceability to Industry Recognized Test Methodologies**

Work Instruction:	WI-03 MEASURING RF SPECTRUM MASK
Measurement Uncertainty:	±2.81 dB

This test report may be reproduced in full only. The document may only be updated by MiCOM Labs personnel. Any changes will be noted in the Document History section of the report.



**Title:** APIN0224, APIN0225 802.11a/b/g/n/ac  
**To:** FCC 47 CFR Part 15.407 & IC RSS-210  
**Serial #:** ARUB146-U1 Rev A  
**Issue Date:** 13th June 2013  
**Page:** 38 of 344

**Equipment Configuration for 26 dB & 99% Occupied Bandwidth**

<b>Variant:</b>	802.11ac-40	<b>Duty Cycle (%):</b>	
<b>Data Rate:</b>	13.5 MBit/s	<b>Antenna Gain (dBi):</b>	Not Applicable
<b>Modulation:</b>	OFDM	<b>Beam Forming Gain (Y):</b>	Not Applicable
<b>TPC:</b>	Not Applicable		
<b>Engineering Test Notes:</b>			

**Test Measurement Results**

Test Frequency	Measured 26 dB Bandwidth (MHz)				26 dB Bandwidth (MHz)			
	Port(s)				Highest	Lowest		
MHz	a	b	c	d				
5510.0	48.898	40.681	53.908	-	53.908	40.681		
5550.0	45.491	42.485	49.098	-	49.098	42.485		
5670.0	45.491	55.511	40.080	-	55.511	40.080		

Test Frequency	Measured 99% Bandwidth (MHz)				99% Bandwidth (MHz)			
	Port(s)				Highest	Lowest		
MHz	a	b	c	d				
5510.0	36.673	36.473	36.673		36.673	36.473		
5550.0	36.673	36.473	36.673		36.673	36.473		
5670.0	36.673	36.673	36.673		36.673	36.673		

**Traceability to Industry Recognized Test Methodologies**

Work Instruction:	WI-03 MEASURING RF SPECTRUM MASK
Measurement Uncertainty:	±2.81 dB

This test report may be reproduced in full only. The document may only be updated by MiCOM Labs personnel. Any changes will be noted in the Document History section of the report.



**Title:** APIN0224, APIN0225 802.11a/b/g/n/ac  
**To:** FCC 47 CFR Part 15.407 & IC RSS-210  
**Serial #:** ARUB146-U1 Rev A  
**Issue Date:** 13th June 2013  
**Page:** 39 of 344

**Equipment Configuration for 26 dB & 99% Occupied Bandwidth**

<b>Variant:</b>	802.11ac-80	<b>Duty Cycle (%):</b>	99%
<b>Data Rate:</b>	29.3 MBit/s	<b>Antenna Gain (dBi):</b>	Not Applicable
<b>Modulation:</b>	OFDM	<b>Beam Forming Gain (Y):</b>	Not Applicable
<b>TPC:</b>	Not Applicable		
<b>Engineering Test Notes:</b>			

**Test Measurement Results**

Test Frequency MHz	Measured 26 dB Bandwidth (MHz)				26 dB Bandwidth (MHz)			
	Port(s)				Highest	Lowest		
	a	b	c	d				
5530.0	83.768	84.569	85.772	-	85.772	83.768		
5690.0	84.970	86.573	84.569	-	86.573	84.569		

Test Frequency MHz	Measured 99% Bandwidth (MHz)				99% Bandwidth (MHz)			
	Port(s)				Highest	Lowest		
	a	b	c	D				
5530.0	76.553	76.152	76.553	-	76.553	76.152		
5690.0	76.152	76.553	76.152	-	76.553	76.152		

**Traceability to Industry Recognized Test Methodologies**

Work Instruction:	WI-03 MEASURING RF SPECTRUM MASK
Measurement Uncertainty:	±2.81 dB

This test report may be reproduced in full only. The document may only be updated by MiCOM Labs personnel. Any changes will be noted in the Document History section of the report.



## Specification

### Limits

#### FCC, Part 15 §15.407 (a)(1), (a)(2) and Industry Canada RSS-210 § A9.2(2)

**(a)(1)** For the band 5.15-5.25 GHz the maximum conducted output power over the frequency band of operation shall not exceed the lesser of 50 mW or +4 dBm + 10 log B, where B is the 26 dB emission bandwidth in megahertz. In addition, the peak power spectral density shall not exceed +4 dBm in any 1 megahertz band.

**(a)(2)** For the 5.25-5.35 GHz band the maximum conducted output power over the frequency band of operation shall not exceed the lesser of 250 mW or +11 dBm + 10 log B, where B is the 26 dB emission bandwidth in megahertz. In addition, the peak power spectral density shall not exceed +11 dBm in any 1 megahertz band.

#### Industry Canada RSS-Gen 4.4

When an occupied bandwidth value is not specified in the applicable RSS, the transmitted signal bandwidth to be reported is to be its 99% emission bandwidth, as calculated or measured.

## Traceability

### Test Equipment Used

0158, 0287, 0252, 0313, 0314, 0070, 0116, 0117





**Title:** APIN0224, APIN0225 802.11a/b/g/n/ac  
**To:** FCC 47 CFR Part 15.407 & IC RSS-210  
**Serial #:** ARUB146-U1 Rev A  
**Issue Date:** 13th June 2013  
**Page:** 41 of 344

### 6.1.1.2. Maximum Conducted Output Power

Conducted Test Conditions for Maximum Conducted Output Power			
<b>Standard:</b>	FCC CFR 47:15.407	<b>Ambient Temp. (°C):</b>	24.0 - 27.5
<b>Test Heading:</b>	Maximum Conducted Output Power	<b>Rel. Humidity (%):</b>	32 - 45
<b>Standard Section(s):</b>	15.407 (a)	<b>Pressure (mBars):</b>	999 - 1001
<b>Reference Document(s):</b>	KDB 789033 - D01 DTS General UNII Test Procedures v01		

#### Test Procedure for Maximum Conducted Output Power Measurement

Method PM (Measurement using an RF average power meter). Section C) 4) of KDB 789033 defines a methodology using an average wideband power meter. Measurements were made while the EUT was operating in a continuous transmission mode (100% duty cycle) at the appropriate center frequency. All cable losses and offsets were taken into consideration in the measured result. All operational modes and frequency bands were measured independently and the resultant calculated. For multiple outputs, the measurements were made simultaneously on each output port and summed in a linear fashion. This technique was used in order to prove compliance.

This test report may be reproduced in full only. The document may only be updated by MiCOM Labs personnel. Any changes will be noted in the Document History section of the report.



### Antenna Beam and Non-Beam Forming Power Levels

15. 407 (a)(1), (a) (2) Operation with directional antenna gains greater than 6 dBi.

If transmitting antennas of directional gain greater than 6 dBi are used, the conducted output power from the intentional radiator shall be reduced by the amount in dB that the directional gain of the antenna exceeds 6 dBi. Further FCC KDB 662911 D01 Multiple Transmitter Output v01 requires that the gain of antennas transmitting the same data (legacy 802.11a mode) must be increased by  $10 * \log(N)$  when N is the number of antenna elements.

### Operating Frequency Band 5150-5250 MHz

#### 5150 – 5250 MHz Uncorrelated Operation (MIMO)

Antenna	Gain	Max. Allowable Conducted Peak Power (dBm)		Maximum EIRP
(dB)	(dBi)	Uncorrelated	Max. Power Per Chain	(dBm)
Integral	6.0	+17.00	+12.23	+23.0

#### 5150 – 5250 MHz Correlated Operation (Non-MIMO i.e. Legacy)

Antenna	Gain dBi	Antenna Gain Increase V's No. Antenna Ports		Total Gain	Max. Allowable Conducted Peak Power	Maximum EIRP
(dB)		Ports	dB	dBi	$\Sigma$ (dBm)	(dBm)
Integral	6.0	3	4.77	10.77	+12.23	+23.0

The APIN0224 and APIN0225 does not implement beam-forming



**Maximum Transmit (Conducted) Power, FCC Limits and Industry Canada Limits**

**FCC Limits**

**Bands 5250 – 5350 and 5470 – 5725 MHz**

Limit lesser of: 250 mW or 11 dBm + 10 log (B) dBm.

Mode	Frequency Range (MHz)	Maximum 26 dB Bandwidth (MHz)	11 + 10 Log (B) (dBm)	Limit (dBm)
a	5250 – 5350 5470 – 5725	20.641	+24.15	+24.0
HT-20		20.641	+24.15	+24.0
HT-40		39.674	+26.99	+24.0
ac-40		40.281	+27.05	+24.0
ac-80		84.168	+30.25	+24.0

**Industry Canada Limits**

**Bands 5250 – 5350 and 5470 – 5725 MHz**

Limit lesser of: 250 mW or 11 dBm + 10 log (B) dBm.

Mode	Frequency Range (MHz)	99% Bandwidth (MHz)	11 + 10 Log (B) (dBm)	Limit (dBm)
a	5250 – 5350 5470 – 5725	19.936	+24.00	+24.0
HT-20		17.936	+24.00	+24.0
HT-40		36.273	+26.60	+24.0
ac-40		36.673	+26.64	+24.0
ac-80		76.152	+29.82	+24.0

This test report may be reproduced in full only. The document may only be updated by MiCOM Labs personnel. Any changes will be noted in the Document History section of the report.



**Title:** APIN0224, APIN0225 802.11a/b/g/n/ac  
**To:** FCC 47 CFR Part 15.407 & IC RSS-210  
**Serial #:** ARUB146-U1 Rev A  
**Issue Date:** 13th June 2013  
**Page:** 44 of 344

---

**APIN0224 and APIN0225 EUT Maximum Power Settings**

**Operational Mode Maximum Power Settings provided by the client**

<b>Operational Mode</b>	<b>Power Setting</b>
<b>802.11 a</b>	18.0
<b>802.11 n HT-20</b>	18.0
<b>802.11 n HT-40</b>	14.0
<b>802.11 ac-40</b>	14.0
<b>802.11 ac-80</b>	12.0

---

This test report may be reproduced in full only. The document may only be updated by MiCOM Labs personnel. Any changes will be noted in the Document History section of the report.



**Title:** APIN0224, APIN0225 802.11a/b/g/n/ac  
**To:** FCC 47 CFR Part 15.407 & IC RSS-210  
**Serial #:** ARUB146-U1 Rev A  
**Issue Date:** 13th June 2013  
**Page:** 45 of 344

**Equipment Configuration for Peak Transmit Power**

<b>Variant:</b>	802.11a	<b>Duty Cycle (%):</b>	99%
<b>Data Rate:</b>	6 MBit/s	<b>Antenna Gain (dBi):</b>	Not Applicable
<b>Modulation:</b>	OFDM	<b>Beam Forming Gain (Y):</b>	Not Applicable
<b>TPC:</b>	Not Applicable		
<b>Engineering Test Notes:</b>			

**Test Measurement Results**

Test Frequency	Measured Conducted Output Power (dBm)				Calculated Total Power	Minimum 26 dB Bandwidth	Limit	Margin	EUT Power Setting
	Port(s)								
MHz	a	b	c	d	Σ Port(s) dBm	MHz	dBm	dBm	
5260.0	18.06	18.42	18.38	-	23.06	20.641	24.00	-0.94	18.00
5300.0	18.28	18.65	18.60	-	23.28	20.641	24.00	-0.72	18.00
5320.0	18.13	18.55	18.96	-	23.33	20.641	24.00	-0.67	18.00

**Traceability to Industry Recognized Test Methodologies**

Work Instruction:	WI-03 MEASURING RF SPECTRUM MASK
Measurement Uncertainty:	±2.81 dB

This test report may be reproduced in full only. The document may only be updated by MiCOM Labs personnel. Any changes will be noted in the Document History section of the report.



**Title:** APIN0224, APIN0225 802.11a/b/g/n/ac  
**To:** FCC 47 CFR Part 15.407 & IC RSS-210  
**Serial #:** ARUB146-U1 Rev A  
**Issue Date:** 13th June 2013  
**Page:** 46 of 344

**Equipment Configuration for Peak Transmit Power**

<b>Variant:</b>	802.11n HT-20	<b>Duty Cycle (%):</b>	99%
<b>Data Rate:</b>	6.5 MBit/s	<b>Antenna Gain (dBi):</b>	Not Applicable
<b>Modulation:</b>	OFDM	<b>Beam Forming Gain (Y):</b>	Not Applicable
<b>TPC:</b>	Not Applicable		
<b>Engineering Test Notes:</b>			

Test Measurement Results									
Test Frequency	Measured Conducted Output Power (dBm)				Calculated Total Power	Minimum 26 dB Bandwidth	Limit	Margin	EUT Power Setting
	Port(s)								
MHz	a	b	c	d	$\Sigma$ Port(s) dBm	MHz	dBm	dBm	
5260.0	17.80	18.46	18.20	-	22.93	20.641	24.00	-1.07	18.00
5300.0	18.25	18.59	18.53	-	23.23	20.741	24.00	-0.77	18.00
5320.0	18.27	18.73	18.87	-	23.40	20.641	24.00	-0.60	18.00

Traceability to Industry Recognized Test Methodologies	
Work Instruction:	WI-03 MEASURING RF SPECTRUM MASK
Measurement Uncertainty:	$\pm 2.81$ dB

This test report may be reproduced in full only. The document may only be updated by MiCOM Labs personnel. Any changes will be noted in the Document History section of the report.



**Title:** APIN0224, APIN0225 802.11a/b/g/n/ac  
**To:** FCC 47 CFR Part 15.407 & IC RSS-210  
**Serial #:** ARUB146-U1 Rev A  
**Issue Date:** 13th June 2013  
**Page:** 47 of 344

<b>Equipment Configuration for Peak Transmit Power</b>
--

<b>Variant:</b>	802.11n HT-40	<b>Duty Cycle (%):</b>	99%
<b>Data Rate:</b>	13.5 MBit/s	<b>Antenna Gain (dBi):</b>	Not Applicable
<b>Modulation:</b>	OFDM	<b>Beam Forming Gain (Y):</b>	Not Applicable
<b>TPC:</b>	Not Applicable		
<b>Engineering Test Notes:</b>			

Test Measurement Results										
Test Frequency	Measured Conducted Output Power (dBm)				Calculated Total Power	Minimum 26 dB Bandwidth	Limit	Margin	EUT Power Setting	
	Port(s)									
MHz	a	b	c	d	Σ Port(s) dBm	MHz	dBm	dBm		
5270.0	13.88	14.78	13.98	-	19.00	39.679	24.00	-5.00	14.00	
5310.0	13.99	14.89	14.09	-	19.11	39.679	24.00	-4.89	14.00	

Traceability to Industry Recognized Test Methodologies	
Work Instruction:	WI-03 MEASURING RF SPECTRUM MASK
Measurement Uncertainty:	±2.81 dB

This test report may be reproduced in full only. The document may only be updated by MiCOM Labs personnel. Any changes will be noted in the Document History section of the report.



**Title:** APIN0224, APIN0225 802.11a/b/g/n/ac  
**To:** FCC 47 CFR Part 15.407 & IC RSS-210  
**Serial #:** ARUB146-U1 Rev A  
**Issue Date:** 13th June 2013  
**Page:** 48 of 344

<b>Equipment Configuration for Peak Transmit Power</b>
--

<b>Variant:</b>	802.11ac-40	<b>Duty Cycle (%):</b>	99%
<b>Data Rate:</b>	13.5 MBit/s	<b>Antenna Gain (dBi):</b>	Not Applicable
<b>Modulation:</b>	OFDM	<b>Beam Forming Gain (Y):</b>	Not Applicable
<b>TPC:</b>	Not Applicable		
<b>Engineering Test Notes:</b>			

Test Measurement Results										
Test Frequency	Measured Conducted Output Power (dBm)				Calculated Total Power	Minimum 26 dB Bandwidth	Limit	Margin	EUT Power Setting	
	Port(s)									
MHz	a	b	c	d	Σ Port(s) dBm	MHz	dBm	dBm		
5270.0	13.77	14.23	14.35		18.89	40.281	24.00	-5.11	14.00	
5310.0	14.15	14.15	14.30		18.97	40.281	24.00	-5.03	14.00	

Traceability to Industry Recognized Test Methodologies	
Work Instruction:	WI-03 MEASURING RF SPECTRUM MASK
Measurement Uncertainty:	±2.81 dB

This test report may be reproduced in full only. The document may only be updated by MiCOM Labs personnel. Any changes will be noted in the Document History section of the report.





**Title:** APIN0224, APIN0225 802.11a/b/g/n/ac  
**To:** FCC 47 CFR Part 15.407 & IC RSS-210  
**Serial #:** ARUB146-U1 Rev A  
**Issue Date:** 13th June 2013  
**Page:** 49 of 344

<b>Equipment Configuration for Peak Transmit Power</b>
--

<b>Variant:</b>	802.11ac-80	<b>Duty Cycle (%):</b>	99%
<b>Data Rate:</b>	29.3 MBit/s	<b>Antenna Gain (dBi):</b>	Not Applicable
<b>Modulation:</b>	OFDM	<b>Beam Forming Gain (Y):</b>	Not Applicable
<b>TPC:</b>	Not Applicable		
<b>Engineering Test Notes:</b>			

<b>Test Measurement Results</b>
---------------------------------

Test Frequency	Measured Conducted Output Power (dBm)				Calculated Total Power	Minimum 26 dB Bandwidth	Limit	Margin	EUT Power Setting
	Port(s)								
MHz	a	b	c	d	$\Sigma$ Port(s) dBm	MHz	dBm	dBm	
5290.0	11.33	11.92	11.97		16.52	84.168	24.00	-7.48	12.00

<b>Traceability to Industry Recognized Test Methodologies</b>
---

Work Instruction:	WI-03 MEASURING RF SPECTRUM MASK
Measurement Uncertainty:	$\pm 2.81$ dB

This test report may be reproduced in full only. The document may only be updated by MiCOM Labs personnel. Any changes will be noted in the Document History section of the report.



**Title:** APIN0224, APIN0225 802.11a/b/g/n/ac  
**To:** FCC 47 CFR Part 15.407 & IC RSS-210  
**Serial #:** ARUB146-U1 Rev A  
**Issue Date:** 13th June 2013  
**Page:** 50 of 344

<b>Equipment Configuration for Peak Transmit Power</b>
--

<b>Variant:</b>	802.11a	<b>Duty Cycle (%):</b>	99%
<b>Data Rate:</b>	6 MBit/s	<b>Antenna Gain (dBi):</b>	Not Applicable
<b>Modulation:</b>	OFDM	<b>Beam Forming Gain (Y):</b>	Not Applicable
<b>TPC:</b>	Not Applicable		
<b>Engineering Test Notes:</b>			

Test Measurement Results									
Test Frequency	Measured Conducted Output Power (dBm)				Calculated Total Power	Minimum 26 dB Bandwidth	Limit	Margin	EUT Power Setting
	Port(s)								
MHz	a	b	c	d	$\Sigma$ Port(s) dBm	MHz	dBm	dBm	
5500.0	18.26	18.96	18.84	-	23.47	21.142	24.00	-0.53	18.00
5580.0	17.79	19.45	17.60	-	23.13	20.842	24.00	-0.87	18.00
5700.0	17.73	19.26	16.96	-	22.86	20.641	24.00	-1.14	18.00

Traceability to Industry Recognized Test Methodologies	
Work Instruction:	WI-03 MEASURING RF SPECTRUM MASK
Measurement Uncertainty:	$\pm 2.81$ dB

This test report may be reproduced in full only. The document may only be updated by MiCOM Labs personnel. Any changes will be noted in the Document History section of the report.



**Title:** APIN0224, APIN0225 802.11a/b/g/n/ac  
**To:** FCC 47 CFR Part 15.407 & IC RSS-210  
**Serial #:** ARUB146-U1 Rev A  
**Issue Date:** 13th June 2013  
**Page:** 51 of 344

**Equipment Configuration for Peak Transmit Power**

<b>Variant:</b>	802.11n HT-20	<b>Duty Cycle (%):</b>	99%
<b>Data Rate:</b>	6.5 MBit/s	<b>Antenna Gain (dBi):</b>	Not Applicable
<b>Modulation:</b>	OFDM	<b>Beam Forming Gain (Y):</b>	Not Applicable
<b>TPC:</b>	Not Applicable		
<b>Engineering Test Notes:</b>			

Test Measurement Results									
Test Frequency	Measured Conducted Output Power (dBm)				Calculated Total Power	Minimum 26 dB Bandwidth	Limit	Margin	EUT Power Setting
	Port(s)								
MHz	a	b	c	d	$\Sigma$ Port(s) dBm	MHz	dBm	dBm	
5500.0	18.15	19.14	18.81	-	23.49	20.641	24.00	-0.51	18.00
5580.0	17.76	19.38	17.55	-	23.08	20.842	24.00	-0.92	18.00
5700.0	17.75	19.25	16.95	-	22.86	20.541	24.00	-1.14	18.00

Traceability to Industry Recognized Test Methodologies	
Work Instruction:	WI-03 MEASURING RF SPECTRUM MASK
Measurement Uncertainty:	$\pm 2.81$ dB

This test report may be reproduced in full only. The document may only be updated by MiCOM Labs personnel. Any changes will be noted in the Document History section of the report.



**Title:** APIN0224, APIN0225 802.11a/b/g/n/ac  
**To:** FCC 47 CFR Part 15.407 & IC RSS-210  
**Serial #:** ARUB146-U1 Rev A  
**Issue Date:** 13th June 2013  
**Page:** 52 of 344

**Equipment Configuration for Peak Transmit Power**

<b>Variant:</b>	802.11n HT-40	<b>Duty Cycle (%):</b>	99%
<b>Data Rate:</b>	13.5 MBit/s	<b>Antenna Gain (dBi):</b>	Not Applicable
<b>Modulation:</b>	OFDM	<b>Beam Forming Gain (Y):</b>	Not Applicable
<b>TPC:</b>	Not Applicable		
<b>Engineering Test Notes:</b>			

Test Measurement Results									
Test Frequency	Measured Conducted Output Power (dBm)				Calculated Total Power	Minimum 26 dB Bandwidth	Limit	Margin	EUT Power Setting
	Port(s)								
MHz	a	b	c	d	Σ Port(s) dBm	MHz	dBm	dBm	
5510.0	14.21	15.44	14.99	-	19.68	39.880	24.00	-4.32	14.00
5550.0	13.83	15.52	14.44	-	19.42	39.880	24.00	-4.58	14.00
5670.0	13.54	15.45	13.66	-	19.08	39.679	24.00	-4.92	14.00

Traceability to Industry Recognized Test Methodologies	
Work Instruction:	WI-03 MEASURING RF SPECTRUM MASK
Measurement Uncertainty:	±2.81 dB

This test report may be reproduced in full only. The document may only be updated by MiCOM Labs personnel. Any changes will be noted in the Document History section of the report.



**Title:** APIN0224, APIN0225 802.11a/b/g/n/ac  
**To:** FCC 47 CFR Part 15.407 & IC RSS-210  
**Serial #:** ARUB146-U1 Rev A  
**Issue Date:** 13th June 2013  
**Page:** 53 of 344

**Equipment Configuration for Peak Transmit Power**

<b>Variant:</b>	802.11ac-40	<b>Duty Cycle (%):</b>	99%
<b>Data Rate:</b>	13.5 MBit/s	<b>Antenna Gain (dBi):</b>	Not Applicable
<b>Modulation:</b>	OFDM	<b>Beam Forming Gain (Y):</b>	Not Applicable
<b>TPC:</b>	Not Applicable		
<b>Engineering Test Notes:</b>			

**Test Measurement Results**

Test Frequency	Measured Conducted Output Power (dBm)				Calculated Total Power	Minimum 26 dB Bandwidth	Limit	Margin	EUT Power Setting
	Port(s)								
MHz	a	b	c	d	Σ Port(s) dBm	MHz	dBm	dBm	
5510.0	14.04	15.23	14.27	-	19.32	40.681	24.00	-4.68	14.00
5550.0	13.60	13.60	13.95	-	18.49	42.485	24.00	-5.51	14.00
5670.0	13.70	15.30	13.50	-	19.02	40.080	24.00	-4.98	14.00

**Traceability to Industry Recognized Test Methodologies**

Work Instruction:	WI-03 MEASURING RF SPECTRUM MASK
Measurement Uncertainty:	±2.81 dB

This test report may be reproduced in full only. The document may only be updated by MiCOM Labs personnel. Any changes will be noted in the Document History section of the report.



**Title:** APIN0224, APIN0225 802.11a/b/g/n/ac  
**To:** FCC 47 CFR Part 15.407 & IC RSS-210  
**Serial #:** ARUB146-U1 Rev A  
**Issue Date:** 13th June 2013  
**Page:** 54 of 344

<b>Equipment Configuration for Peak Transmit Power</b>
--

<b>Variant:</b>	802.11ac-80	<b>Duty Cycle (%):</b>	99%
<b>Data Rate:</b>	29.3 MBit/s	<b>Antenna Gain (dBi):</b>	Not Applicable
<b>Modulation:</b>	OFDM	<b>Beam Forming Gain (Y):</b>	Not Applicable
<b>TPC:</b>	Not Applicable		
<b>Engineering Test Notes:</b>			

Test Measurement Results										
Test Frequency	Measured Conducted Output Power (dBm)				Calculated Total Power	Minimum 26 dB Bandwidth	Limit	Margin	EUT Power Setting	
	Port(s)									
MHz	a	b	c	d	Σ Port(s) dBm	MHz	dBm	dBm		
5530.0	11.16	12.80	12.01	-	16.81	83.768	24.00	-7.19	12.00	
5610.0	11.11	12.79	11.16	-	16.53	84.569	24.00	-7.47	12.00	

Traceability to Industry Recognized Test Methodologies	
Work Instruction:	WI-03 MEASURING RF SPECTRUM MASK
Measurement Uncertainty:	±2.81 dB

This test report may be reproduced in full only. The document may only be updated by MiCOM Labs personnel. Any changes will be noted in the Document History section of the report.



## Measurement Results for Maximum Conducted Output Power

### Specification Limits

#### **FCC, Part 15 §15.407 (a)(1), (a)(2) and Industry Canada RSS-210 § A9.2(2)**

**(a)(1)** For the band 5.15-5.25 GHz the maximum conducted output power over the frequency band of operation shall not exceed the lesser of 50 mW or +4 dBm + 10 log B, where B is the 26 dB emission bandwidth in megahertz. In addition, the peak power spectral density shall not exceed +4 dBm in any 1 megahertz band.

**(a)(2)** For the 5.25-5.35 and 5470-5725 MHz GHz band the maximum conducted output power over the frequency band of operation shall not exceed the lesser of 250 mW or +11 dBm + 10 log B, where B is the 26 dB emission bandwidth in megahertz. In addition, the peak power spectral density shall not exceed +11 dBm in any 1 megahertz band.

#### **Industry Canada RSS-210 §A9.2(2)**

For the band 5150-5250 MHz, the maximum equivalent isotropically radiated power (e.i.r.p.) shall not exceed 200 mW or 10 + 10 log<sub>10</sub> B, dBm, whichever power is less. B is the 99% emission bandwidth in MHz. The e.i.r.p. spectral density shall not exceed 10 dBm in any 1.0 MHz band.

For the band 5250-5350 MHz and 5470-5725 MHz, the maximum conducted output power shall not exceed 250 mW or 11 + 10 log<sub>10</sub> B, dBm, whichever power is less. The power spectral density shall not exceed 11 dBm in any 1.0 MHz band. The maximum e.i.r.p. shall not exceed 1.0 W or 17 + 10 log<sub>10</sub> B, dBm, whichever power is less. B is the 99% emission bandwidth in MHz.

### Traceability

Test Equipment Used
---------------------

0158, 0287, 0252, 0313, 0314, 0070, 0116, 0117
--



**Title:** APIN0224, APIN0225 802.11a/b/g/n/ac  
**To:** FCC 47 CFR Part 15.407 & IC RSS-210  
**Serial #:** ARUB146-U1 Rev A  
**Issue Date:** 13th June 2013  
**Page:** 56 of 344

### 6.1.1.3. Peak Power Spectral Density

Conducted Test Conditions for Power Spectral Density			
<b>Standard:</b>	FCC CFR 47:15.407	<b>Ambient Temp. (°C):</b>	24.0 - 27.5
<b>Test Heading:</b>	Power Spectral Density	<b>Rel. Humidity (%):</b>	32 - 45
<b>Standard Section(s):</b>	15.247 (a)	<b>Pressure (mBars):</b>	999 - 1001
<b>Reference Document(s):</b>	KDB 789033 - D01 DTS General UNII Test Procedures v01		

**Test Procedure for Power Spectral Density**

The In-Band power spectral density was measured using the measure and sum approach per FCC KDB 662911 (D01 Multiple Transmitter Output v01.)

Measure and sum the spectra across the outputs. With this technique, spectra are measured at each output of the device at the required resolution bandwidth. The individual spectra are then summed mathematically in linear power units. Unlike in-band power measurements, in which the sum involves a single measured value (output power) from each output, measurements for compliance with PSD limits involve summing entire spectra across corresponding frequency bins on the various outputs. Consistency is maintained for any device with N transmitter outputs to be certain the individual outputs are all aligned with the same span and same number of points. In this instance, the linear power spectrum value within the first spectral bin of output 0 is summed with that in the first spectral bin of output 1, and the first spectral bin of output 2, and so on up to the Nth output to obtain the true value for the first frequency bin of the summed spectrum. The summed spectrum value for each frequency bin is computed in this fashion. These summed spectral values were calculated on a computer, and the results read back into the spectrum analyzer as a data file to produce a representative plot of total spectral power density.

Calculated Power =  $A + 10 \log (1/x)$  dBm

A = Total Power Spectral Density [10 Log<sub>10</sub> (10a/10 + 10 b/10 + 10c/10 + 10d/10)]

x = Duty Cycle

This test report may be reproduced in full only. The document may only be updated by MiCOM Labs personnel. Any changes will be noted in the Document History section of the report.





**Title:** APIN0224, APIN0225 802.11a/b/g/n/ac  
**To:** FCC 47 CFR Part 15.407 & IC RSS-210  
**Serial #:** ARUB146-U1 Rev A  
**Issue Date:** 13th June 2013  
**Page:** 57 of 344

**Equipment Configuration for Peak Power Spectral Density**

<b>Variant:</b>	802.11a	<b>Duty Cycle (%):</b>	99%
<b>Data Rate:</b>	6 MBit/s	<b>Antenna Gain (dBi):</b>	Not Applicable
<b>Modulation:</b>	OFDM	<b>Beam Forming Gain (Y):</b>	Not Applicable
<b>TPC:</b>	Not Applicable		
<b>Engineering Test Notes:</b>			

**Test Measurement Results**

Test Frequency	Measured Power Spectral Density (dBm)				Calculated Total Power Spectral Density (dBm)	Limit	Margin
	Port(s)						
MHz	a	b	c	d	Σ Port(s)	dBm	dB
5260.0	0.515	1.370	1.137	-	5.793	≤ 11.00	-5.21
5300.0	0.510	1.781	1.257	-	5.985	≤ 11.00	-5.02
5320.0	0.482	1.227	1.266	-	5.778	≤ 11.00	-5.22

**Traceability to Industry Recognized Test Methodologies**

Work Instruction:	WI-03 MEASURING RF SPECTRUM MASK
Measurement Uncertainty:	±2.81 dB

This test report may be reproduced in full only. The document may only be updated by MiCOM Labs personnel. Any changes will be noted in the Document History section of the report.



**Title:** APIN0224, APIN0225 802.11a/b/g/n/ac  
**To:** FCC 47 CFR Part 15.407 & IC RSS-210  
**Serial #:** ARUB146-U1 Rev A  
**Issue Date:** 13th June 2013  
**Page:** 58 of 344

**Equipment Configuration for Peak Power Spectral Density**

<b>Variant:</b>	802.11n HT-20	<b>Duty Cycle (%):</b>	99%
<b>Data Rate:</b>	6.5 MBit/s	<b>Antenna Gain (dBi):</b>	Not Applicable
<b>Modulation:</b>	OFDM	<b>Beam Forming Gain (Y):</b>	Not Applicable
<b>TPC:</b>	Not Applicable		
<b>Engineering Test Notes:</b>			

**Test Measurement Results**

Test Frequency	Measured Power Spectral Density (dBm)				Calculated Total Power Spectral Density (dBm)	Limit	Margin
	Port(s)						
MHz	a	b	c	d	Σ Port(s)	dBm	dB
5260.0	0.628	1.635	1.259	-	5.965	≤ 11.00	-5.04
5300.0	0.638	1.571	1.422	-	6.000	≤ 11.00	-5.00
5320.0	0.371	1.543	1.345	-	5.887	≤ 11.00	-5.11

**Traceability to Industry Recognized Test Methodologies**

Work Instruction:	WI-03 MEASURING RF SPECTRUM MASK
Measurement Uncertainty:	±2.81 dB

This test report may be reproduced in full only. The document may only be updated by MiCOM Labs personnel. Any changes will be noted in the Document History section of the report.



**Title:** APIN0224, APIN0225 802.11a/b/g/n/ac  
**To:** FCC 47 CFR Part 15.407 & IC RSS-210  
**Serial #:** ARUB146-U1 Rev A  
**Issue Date:** 13th June 2013  
**Page:** 59 of 344

<b>Equipment Configuration for Peak Power Spectral Density</b>
--

<b>Variant:</b>	802.11n HT-40	<b>Duty Cycle (%):</b>	99%
<b>Data Rate:</b>	13.5 MBit/s	<b>Antenna Gain (dBi):</b>	Not Applicable
<b>Modulation:</b>	OFDM	<b>Beam Forming Gain (Y):</b>	Not Applicable
<b>TPC:</b>	Not Applicable		
<b>Engineering Test Notes:</b>			

<b>Test Measurement Results</b>
---------------------------------

Test Frequency	Measured Power Spectral Density (dBm)				Calculated Total Power Spectral Density (dBm)	Limit	Margin
	Port(s)						
	MHz	a	b	c			
5270.0	-2.503	-1.589	-2.353	-	2.642	≤ 11.00	-8.36
5310.0	-2.377	-1.540	-2.517	-	2.648	≤ 11.00	-8.35

<b>Traceability to Industry Recognized Test Methodologies</b>
---

Work Instruction:	WI-03 MEASURING RF SPECTRUM MASK
Measurement Uncertainty:	±2.81 dB

This test report may be reproduced in full only. The document may only be updated by MiCOM Labs personnel. Any changes will be noted in the Document History section of the report.



**Title:** APIN0224, APIN0225 802.11a/b/g/n/ac  
**To:** FCC 47 CFR Part 15.407 & IC RSS-210  
**Serial #:** ARUB146-U1 Rev A  
**Issue Date:** 13th June 2013  
**Page:** 60 of 344

<b>Equipment Configuration for Peak Power Spectral Density</b>
--

<b>Variant:</b>	802.11ac-40	<b>Duty Cycle (%):</b>	99%
<b>Data Rate:</b>	13.5 MBit/s	<b>Antenna Gain (dBi):</b>	Not Applicable
<b>Modulation:</b>	OFDM	<b>Beam Forming Gain (Y):</b>	Not Applicable
<b>TPC:</b>	Not Applicable		
<b>Engineering Test Notes:</b>			

<b>Test Measurement Results</b>
---------------------------------

Test Frequency	Measured Power Spectral Density (dBm)				Calculated Total Power Spectral Density (dBm)	Limit	Margin
	Port(s)						
MHz	a	b	c	d	Σ Port(s)	dBm	dB
5270.0	1.300	1.803	1.798	-	6.411	≤ 11.00	-4.59
5310.0	1.228	2.075	1.601	-	6.420	≤ 11.00	-4.58

<b>Traceability to Industry Recognized Test Methodologies</b>
---

Work Instruction:	WI-03 MEASURING RF SPECTRUM MASK
Measurement Uncertainty:	±2.81 dB

This test report may be reproduced in full only. The document may only be updated by MiCOM Labs personnel. Any changes will be noted in the Document History section of the report.



**Title:** APIN0224, APIN0225 802.11a/b/g/n/ac  
**To:** FCC 47 CFR Part 15.407 & IC RSS-210  
**Serial #:** ARUB146-U1 Rev A  
**Issue Date:** 13th June 2013  
**Page:** 61 of 344

<b>Equipment Configuration for Peak Power Spectral Density</b>
--

<b>Variant:</b>	802.11ac-80	<b>Duty Cycle (%):</b>	99%
<b>Data Rate:</b>	29.3 MBit/s	<b>Antenna Gain (dBi):</b>	Not Applicable
<b>Modulation:</b>	OFDM	<b>Beam Forming Gain (Y):</b>	Not Applicable
<b>TPC:</b>	Not Applicable		
<b>Engineering Test Notes:</b>			

<b>Test Measurement Results</b>
---------------------------------

Test Frequency	Measured Power Spectral Density (dBm)				Calculated Total Power Spectral Density (dBm)	Limit	Margin
	Port(s)						
	MHz	a	b	c			
5290.0	0.164	2.150	0.861	-	5.909	≤ 11.00	-5.09

<b>Traceability to Industry Recognized Test Methodologies</b>
---

Work Instruction:	WI-03 MEASURING RF SPECTRUM MASK
Measurement Uncertainty:	±2.81 dB

This test report may be reproduced in full only. The document may only be updated by MiCOM Labs personnel. Any changes will be noted in the Document History section of the report.



**Title:** APIN0224, APIN0225 802.11a/b/g/n/ac  
**To:** FCC 47 CFR Part 15.407 & IC RSS-210  
**Serial #:** ARUB146-U1 Rev A  
**Issue Date:** 13th June 2013  
**Page:** 62 of 344

**Equipment Configuration for Peak Power Spectral Density**

<b>Variant:</b>	802.11a	<b>Duty Cycle (%):</b>	99%
<b>Data Rate:</b>	6 MBit/s	<b>Antenna Gain (dBi):</b>	Not Applicable
<b>Modulation:</b>	OFDM	<b>Beam Forming Gain (Y):</b>	Not Applicable
<b>TPC:</b>	Not Applicable		
<b>Engineering Test Notes:</b>			

**Test Measurement Results**

Test Frequency	Measured Power Spectral Density (dBm)				Calculated Total Power Spectral Density (dBm)	Limit	Margin
	Port(s)						
MHz	a	b	c	d	Σ Port(s)	dBm	dB
5500.0	0.420	2.772	1.089	-	6.314	≤ 11.00	-4.69
5580.0	0.090	2.815	0.170	-	5.991	≤ 11.00	-5.01
5700.0	0.147	2.163	-0.720	-	5.474	≤ 11.00	-5.53

**Traceability to Industry Recognized Test Methodologies**

Work Instruction:	WI-03 MEASURING RF SPECTRUM MASK
Measurement Uncertainty:	±2.81 dB

This test report may be reproduced in full only. The document may only be updated by MiCOM Labs personnel. Any changes will be noted in the Document History section of the report.



**Title:** APIN0224, APIN0225 802.11a/b/g/n/ac  
**To:** FCC 47 CFR Part 15.407 & IC RSS-210  
**Serial #:** ARUB146-U1 Rev A  
**Issue Date:** 13th June 2013  
**Page:** 63 of 344

**Equipment Configuration for Peak Power Spectral Density**

<b>Variant:</b>	802.11n HT-20	<b>Duty Cycle (%):</b>	99%
<b>Data Rate:</b>	6.5 MBit/s	<b>Antenna Gain (dBi):</b>	Not Applicable
<b>Modulation:</b>	OFDM	<b>Beam Forming Gain (Y):</b>	Not Applicable
<b>TPC:</b>	Not Applicable		
<b>Engineering Test Notes:</b>			

**Test Measurement Results**

Test Frequency	Measured Power Spectral Density (dBm)				Calculated Total Power Spectral Density (dBm)	Limit	Margin
	Port(s)						
MHz	a	b	c	d	Σ Port(s)	dBm	dB
5500.0	0.546	2.885	1.213	-	6.434	≤ 11.00	-4.57
5580.0	-0.018	2.953	0.358	-	6.081	≤ 11.00	-4.92
5700.0	0.259	2.351	-0.315	-	5.693	≤ 11.00	-5.31

**Traceability to Industry Recognized Test Methodologies**

Work Instruction:	WI-03 MEASURING RF SPECTRUM MASK
Measurement Uncertainty:	±2.81 dB

This test report may be reproduced in full only. The document may only be updated by MiCOM Labs personnel. Any changes will be noted in the Document History section of the report.



**Title:** APIN0224, APIN0225 802.11a/b/g/n/ac  
**To:** FCC 47 CFR Part 15.407 & IC RSS-210  
**Serial #:** ARUB146-U1 Rev A  
**Issue Date:** 13th June 2013  
**Page:** 64 of 344

<b>Equipment Configuration for Peak Power Spectral Density</b>
--

<b>Variant:</b>	802.11n HT-40	<b>Duty Cycle (%):</b>	99%
<b>Data Rate:</b>	13.5 MBit/s	<b>Antenna Gain (dBi):</b>	Not Applicable
<b>Modulation:</b>	OFDM	<b>Beam Forming Gain (Y):</b>	Not Applicable
<b>TPC:</b>	Not Applicable		
<b>Engineering Test Notes:</b>			

<b>Test Measurement Results</b>
---------------------------------

Test Frequency	Measured Power Spectral Density (dBm)				Calculated Total Power Spectral Density (dBm)	Limit	Margin
	Port(s)						
	MHz	a	b	c			
5510.0	-2.793	-1.107	-1.989	-	2.863	≤ 11.00	-8.14
5550.0	-2.991	-0.979	-2.470	-	2.711	≤ 11.00	-8.29
5670.0	-2.968	-0.968	-2.929	-	2.588	≤ 11.00	-8.41

<b>Traceability to Industry Recognized Test Methodologies</b>
---

Work Instruction:	WI-03 MEASURING RF SPECTRUM MASK
Measurement Uncertainty:	±2.81 dB

This test report may be reproduced in full only. The document may only be updated by MiCOM Labs personnel. Any changes will be noted in the Document History section of the report.





**Title:** APIN0224, APIN0225 802.11a/b/g/n/ac  
**To:** FCC 47 CFR Part 15.407 & IC RSS-210  
**Serial #:** ARUB146-U1 Rev A  
**Issue Date:** 13th June 2013  
**Page:** 65 of 344

Equipment Configuration for Peak Power Spectral Density
---

<b>Variant:</b>	802.11ac-40	<b>Duty Cycle (%):</b>	99%
<b>Data Rate:</b>	13.5 MBit/s	<b>Antenna Gain (dBi):</b>	Not Applicable
<b>Modulation:</b>	OFDM	<b>Beam Forming Gain (Y):</b>	Not Applicable
<b>TPC:</b>	Not Applicable		
<b>Engineering Test Notes:</b>			

Test Measurement Results
--------------------------

Test Frequency	Measured Power Spectral Density (dBm)				Calculated Total Power Spectral Density (dBm)	Limit	Margin
	Port(s)						
MHz	a	b	c	d	Σ Port(s)	dBm	dB
5510.0	1.275	2.038	1.147	-	6.276	≤ 11.00	-4.72
5550.0	0.615	2.664	1.126	-	6.329	≤ 11.00	-4.67
5670.0	0.659	2.632	0.484	-	6.144	≤ 11.00	-4.86

Traceability to Industry Recognized Test Methodologies
--

Work Instruction:	WI-03 MEASURING RF SPECTRUM MASK
Measurement Uncertainty:	±2.81 dB

This test report may be reproduced in full only. The document may only be updated by MiCOM Labs personnel. Any changes will be noted in the Document History section of the report.



**Title:** APIN0224, APIN0225 802.11a/b/g/n/ac  
**To:** FCC 47 CFR Part 15.407 & IC RSS-210  
**Serial #:** ARUB146-U1 Rev A  
**Issue Date:** 13th June 2013  
**Page:** 66 of 344

<b>Equipment Configuration for Peak Power Spectral Density</b>
--

<b>Variant:</b>	802.11ac-80	<b>Duty Cycle (%):</b>	99%
<b>Data Rate:</b>	29.3 MBit/s	<b>Antenna Gain (dBi):</b>	Not Applicable
<b>Modulation:</b>	OFDM	<b>Beam Forming Gain (Y):</b>	Not Applicable
<b>TPC:</b>	Not Applicable		
<b>Engineering Test Notes:</b>			

<b>Test Measurement Results</b>
---------------------------------

Test Frequency	Measured Power Spectral Density (dBm)				Calculated Total Power Spectral Density (dBm)	Limit	Margin
	Port(s)						
MHz	a	b	c	d	Σ Port(s)	dBm	dB
5530.0	-0.138	2.653	0.831	-	6.044	≤ 11.00	-4.96
5690.0	-0.200	2.237	-0.298	-	5.518	≤ 11.00	-5.48

<b>Traceability to Industry Recognized Test Methodologies</b>
---

Work Instruction:	WI-03 MEASURING RF SPECTRUM MASK
Measurement Uncertainty:	±2.81 dB

This test report may be reproduced in full only. The document may only be updated by MiCOM Labs personnel. Any changes will be noted in the Document History section of the report.



**Title:** APIN0224, APIN0225 802.11a/b/g/n/ac  
**To:** FCC 47 CFR Part 15.407 & IC RSS-210  
**Serial #:** ARUB146-U1 Rev A  
**Issue Date:** 13th June 2013  
**Page:** 67 of 344

## Specification

### **FCC, Part 15 §15.407 (a)(1), (a)(2)**

#### **5150 – 5250 MHz**

**(a)(1)** The peak power spectral density shall not exceed +4 dBm in any 1 megahertz band.

#### **5250 – 5350 MHz & 5470 – 5725 MHz**

**(a)(2)** The peak power spectral density shall not exceed +11 dBm in any 1 megahertz band.

### **Industry Canada RSS-210 § A9.2(1), A9.2(2)**

#### **5150 – 5250 MHz**

§ **A9.2(1)** The eirp spectral density shall not exceed +10 dBm in any 1 MHz band

#### **5250 – 5350 MHz & 5470 – 5725 MHz**

§ **A9.2(2)** The power spectral density shall not exceed +11 dBm in any 1 MHz band

## Traceability

Test Equipment Used
---------------------

0158, 0287, 0252, 0313, 0314, 0070, 0116, 0117
--

This test report may be reproduced in full only. The document may only be updated by MiCOM Labs personnel. Any changes will be noted in the Document History section of the report.



**Title:** APIN0224, APIN0225 802.11a/b/g/n/ac  
**To:** FCC 47 CFR Part 15.407 & IC RSS-210  
**Serial #:** ARUB146-U1 Rev A  
**Issue Date:** 13th June 2013  
**Page:** 68 of 344

#### 6.1.1.4. Peak Excursion Ratio

Conducted Test Conditions for Peak Excursion Ratio			
<b>Standard:</b>	FCC CFR 47:15.407	<b>Ambient Temp. (°C):</b>	24.0 - 27.5
<b>Test Heading:</b>	Peak Excursion Ratio	<b>Rel. Humidity (%):</b>	32 - 45
<b>Standard Section(s):</b>	15.407 (a)(6)	<b>Pressure (mBars):</b>	999 - 1001
<b>Reference Document(s):</b>	KDB 789033 - D01 DTS General UNII Test Procedures v01		

##### Test Procedure for Peak Excursion Ratio

Compliance with the peak excursion requirement is demonstrated by confirming the ratio of the maximum of the peak-hold spectrum to the maximum of the average spectrum during continuous transmission. Section F) of KDB 789033 was used in order to prove compliance. This is a conducted measurement using a spectrum analyzer using dual traces. Peak Excursion Ratio is the difference in amplitude (dB) between both traces; The following identifies two spectrum traces on the same plot. Trace 1 is the max hold Peak detector, and Trace 2 is the recalled trace data from Peak Power Spectral Density measurements. Each frequency and operational mode is recalled in order to prove compliance.

This test report may be reproduced in full only. The document may only be updated by MiCOM Labs personnel. Any changes will be noted in the Document History section of the report.



**Title:** APIN0224, APIN0225 802.11a/b/g/n/ac  
**To:** FCC 47 CFR Part 15.407 & IC RSS-210  
**Serial #:** ARUB146-U1 Rev A  
**Issue Date:** 13th June 2013  
**Page:** 69 of 344

**Equipment Configuration for Peak Excursion Ratio**

<b>Variant:</b>	802.11a	<b>Duty Cycle (%):</b>	100
<b>Data Rate:</b>	6 MBit/s	<b>Antenna Gain (dBi):</b>	Not Applicable
<b>Modulation:</b>	OFDM	<b>Beam Forming Gain (Y):</b>	Not Applicable
<b>TPC:</b>	Not Applicable		
<b>Engineering Test Notes:</b>			

**Test Measurement Results**

Test Frequency MHz	Measured Peak Excursion (dB) Port(s)				Ratio (dB)		Limit dB	Lowest Margin MHz
	a	b	c	d	Highest	Lowest		
5260.0	9.28	--	--	--	9.28	9.28	13.0	-3.72

**Traceability to Industry Recognized Test Methodologies**

Work Instruction:	WI-03 MEASURING RF SPECTRUM MASK
Measurement Uncertainty:	±2.81 dB

**Equipment Configuration for Peak Excursion Ratio**

<b>Variant:</b>	802.11n HT-20	<b>Duty Cycle (%):</b>	100
<b>Data Rate:</b>	6.5 MBit/s	<b>Antenna Gain (dBi):</b>	Not Applicable
<b>Modulation:</b>	OFDM	<b>Beam Forming Gain (Y):</b>	Not Applicable
<b>TPC:</b>	Not Applicable		
<b>Engineering Test Notes:</b>			

**Test Measurement Results**

Test Frequency MHz	Measured Peak Excursion (dB) Port(s)				Ratio (dB)		Limit dB	Lowest Margin MHz
	a	b	c	d	Highest	Lowest		
5260.0	9.83	--	--	--	9.83	9.83	13.0	-3.17

**Traceability to Industry Recognized Test Methodologies**

Work Instruction:	WI-03 MEASURING RF SPECTRUM MASK
Measurement Uncertainty:	±2.81 dB

This test report may be reproduced in full only. The document may only be updated by MiCOM Labs personnel. Any changes will be noted in the Document History section of the report.



**Title:** APIN0224, APIN0225 802.11a/b/g/n/ac  
**To:** FCC 47 CFR Part 15.407 & IC RSS-210  
**Serial #:** ARUB146-U1 Rev A  
**Issue Date:** 13th June 2013  
**Page:** 70 of 344

**Equipment Configuration for Peak Excursion Ratio**

<b>Variants:</b>	802.11n HT-40	<b>Duty Cycle (%):</b>	100
<b>Data Rate:</b>	13.5 MBit/s	<b>Antenna Gain (dBi):</b>	Not Applicable
<b>Modulation:</b>	OFDM	<b>Beam Forming Gain (Y):</b>	Not Applicable
<b>TPC:</b>	Not Applicable		
<b>Engineering Test Notes:</b>			

**Test Measurement Results**

Test Frequency MHz	Measured Peak Excursion (dB) Port(s)				Ratio (dB)		Limit dB	Lowest Margin MHz
	a	b	c	d	Highest	Lowest		
5270.0	9.38	--	--	--	9.38	9.38	13.0	-3.62

**Traceability to Industry Recognized Test Methodologies**

Work Instruction:	WI-03 MEASURING RF SPECTRUM MASK
Measurement Uncertainty:	±2.81 dB

**Equipment Configuration for Peak Excursion Ratio**

<b>Variants:</b>	802.11ac-40	<b>Duty Cycle (%):</b>	100
<b>Data Rate:</b>	13.5 MBit/s	<b>Antenna Gain (dBi):</b>	Not Applicable
<b>Modulation:</b>	OFDM	<b>Beam Forming Gain (Y):</b>	Not Applicable
<b>TPC:</b>	Not Applicable		
<b>Engineering Test Notes:</b>			

**Test Measurement Results**

Test Frequency MHz	Measured Peak Excursion (dB) Port(s)				Ratio (dB)		Limit dB	Lowest Margin MHz
	a	b	c	d	Highest	Lowest		
5270.0	10.49	--	--	--	10.49	10.49	13.0	-2.51

**Traceability to Industry Recognized Test Methodologies**

Work Instruction:	WI-03 MEASURING RF SPECTRUM MASK
Measurement Uncertainty:	±2.81 dB

This test report may be reproduced in full only. The document may only be updated by MiCOM Labs personnel. Any changes will be noted in the Document History section of the report.



**Title:** APIN0224, APIN0225 802.11a/b/g/n/ac  
**To:** FCC 47 CFR Part 15.407 & IC RSS-210  
**Serial #:** ARUB146-U1 Rev A  
**Issue Date:** 13th June 2013  
**Page:** 71 of 344

Equipment Configuration for Peak Excursion Ratio			
<b>Variant:</b>	802.11ac-80	<b>Duty Cycle (%):</b>	100
<b>Data Rate:</b>	29.3 MBit/s	<b>Antenna Gain (dBi):</b>	Not Applicable
<b>Modulation:</b>	OFDM	<b>Beam Forming Gain (Y):</b>	Not Applicable
<b>TPC:</b>	Not Applicable		
<b>Engineering Test Notes:</b>			

Test Measurement Results								
Test Frequency	Measured Peak Excursion (dB)				Ratio (dB)		Limit	Lowest Margin
	Port(s)				Highest	Lowest		
MHz	a	b	c	d			dB	MHz
5290.0	8.11	--	--	--	8.11	8.11	13.0	-4.89

Traceability to Industry Recognized Test Methodologies	
Work Instruction:	WI-03 MEASURING RF SPECTRUM MASK
Measurement Uncertainty:	±2.81 dB

This test report may be reproduced in full only. The document may only be updated by MiCOM Labs personnel. Any changes will be noted in the Document History section of the report.



**Title:** APIN0224, APIN0225 802.11a/b/g/n/ac  
**To:** FCC 47 CFR Part 15.407 & IC RSS-210  
**Serial #:** ARUB146-U1 Rev A  
**Issue Date:** 13th June 2013  
**Page:** 72 of 344

**Equipment Configuration for Peak Excursion Ratio**

<b>Variant:</b>	802.11a	<b>Duty Cycle (%):</b>	100
<b>Data Rate:</b>	6 MBit/s	<b>Antenna Gain (dBi):</b>	Not Applicable
<b>Modulation:</b>	OFDM	<b>Beam Forming Gain (Y):</b>	Not Applicable
<b>TPC:</b>	Not Applicable		
<b>Engineering Test Notes:</b>			

**Test Measurement Results**

Test Frequency MHz	Measured Peak Excursion (dB) Port(s)				Ratio (dB)		Limit dB	Lowest Margin MHz
	a	b	c	d	Highest	Lowest		
5500.0	10.38	--	--	--	10.38	10.38	13.0	-2.62

**Traceability to Industry Recognized Test Methodologies**

Work Instruction:	WI-03 MEASURING RF SPECTRUM MASK
Measurement Uncertainty:	±2.81 dB

**Equipment Configuration for Peak Excursion Ratio**

<b>Variant:</b>	802.11n HT-20	<b>Duty Cycle (%):</b>	100
<b>Data Rate:</b>	6.5 MBit/s	<b>Antenna Gain (dBi):</b>	Not Applicable
<b>Modulation:</b>	OFDM	<b>Beam Forming Gain (Y):</b>	Not Applicable
<b>TPC:</b>	Not Applicable		
<b>Engineering Test Notes:</b>			

**Test Measurement Results**

Test Frequency MHz	Measured Peak Excursion (dB) Port(s)				Ratio (dB)		Limit dB	Lowest Margin MHz
	a	b	c	d	Highest	Lowest		
5500.0	9.58	--	--	--	9.58	9.58	13.0	-3.42

**Traceability to Industry Recognized Test Methodologies**

Work Instruction:	WI-03 MEASURING RF SPECTRUM MASK
Measurement Uncertainty:	±2.81 dB

This test report may be reproduced in full only. The document may only be updated by MiCOM Labs personnel. Any changes will be noted in the Document History section of the report.





**Title:** APIN0224, APIN0225 802.11a/b/g/n/ac  
**To:** FCC 47 CFR Part 15.407 & IC RSS-210  
**Serial #:** ARUB146-U1 Rev A  
**Issue Date:** 13th June 2013  
**Page:** 73 of 344

**Equipment Configuration for Peak Excursion Ratio**

<b>Variant:</b>	802.11n HT-40	<b>Duty Cycle (%):</b>	100
<b>Data Rate:</b>	13.5 MBit/s	<b>Antenna Gain (dBi):</b>	Not Applicable
<b>Modulation:</b>	OFDM	<b>Beam Forming Gain (Y):</b>	Not Applicable
<b>TPC:</b>	Not Applicable		
<b>Engineering Test Notes:</b>			

**Test Measurement Results**

Test Frequency MHz	Measured Peak Excursion (dB) Port(s)				Ratio (dB)		Limit dB	Lowest Margin MHz
	a	b	c	d	Highest	Lowest		
5510.0	10.61	--	--	--	10.61	10.61	13.0	-2.39

**Traceability to Industry Recognized Test Methodologies**

Work Instruction:	WI-03 MEASURING RF SPECTRUM MASK
Measurement Uncertainty:	±2.81 dB

**Equipment Configuration for Peak Excursion Ratio**

<b>Variant:</b>	802.11ac-40	<b>Duty Cycle (%):</b>	100
<b>Data Rate:</b>	13.5 MBit/s	<b>Antenna Gain (dBi):</b>	Not Applicable
<b>Modulation:</b>	OFDM	<b>Beam Forming Gain (Y):</b>	Not Applicable
<b>TPC:</b>	Not Applicable		
<b>Engineering Test Notes:</b>			

**Test Measurement Results**

Test Frequency MHz	Measured Peak Excursion (dB) Port(s)				Ratio (dB)		Limit dB	Lowest Margin MHz
	a	b	c	d	Highest	Lowest		
5510.0	11.13	--	--	--	11.13	11.13	13.0	-1.87

**Traceability to Industry Recognized Test Methodologies**

Work Instruction:	WI-03 MEASURING RF SPECTRUM MASK
Measurement Uncertainty:	±2.81 dB

This test report may be reproduced in full only. The document may only be updated by MiCOM Labs personnel. Any changes will be noted in the Document History section of the report.



**Title:** APIN0224, APIN0225 802.11a/b/g/n/ac  
**To:** FCC 47 CFR Part 15.407 & IC RSS-210  
**Serial #:** ARUB146-U1 Rev A  
**Issue Date:** 13th June 2013  
**Page:** 74 of 344

<b>Equipment Configuration for Peak Excursion Ratio</b>
---

<b>Variant:</b>	802.11ac-80	<b>Duty Cycle (%):</b>	100
<b>Data Rate:</b>	29.3 MBit/s	<b>Antenna Gain (dBi):</b>	Not Applicable
<b>Modulation:</b>	OFDM	<b>Beam Forming Gain (Y):</b>	Not Applicable
<b>TPC:</b>	Not Applicable		
<b>Engineering Test Notes:</b>			

<b>Test Measurement Results</b>
---------------------------------

Test Frequency	Measured Peak Excursion (dB)				Ratio (dB)		Limit	Lowest Margin
	Port(s)				Highest	Lowest		
MHz	a	b	c	d	Highest	Lowest	dB	MHz
5530.0	7.59	--	--	--	7.59	7.59	13.0	-5.41

<b>Traceability to Industry Recognized Test Methodologies</b>
---

Work Instruction:	WI-03 MEASURING RF SPECTRUM MASK
Measurement Uncertainty:	±2.81 dB

This test report may be reproduced in full only. The document may only be updated by MiCOM Labs personnel. Any changes will be noted in the Document History section of the report.



**Title:** APIN0224, APIN0225 802.11a/b/g/n/ac  
**To:** FCC 47 CFR Part 15.407 & IC RSS-210  
**Serial #:** ARUB146-U1 Rev A  
**Issue Date:** 13th June 2013  
**Page:** 75 of 344

---

## Specification

### Limits

**§15.407 (a)(6)** The ratio of the peak excursion of the modulation envelope (measured using a peak hold function) to the peak transmit power (measured as specified in this paragraph) shall not exceed 13dB across any 1MHz bandwidth or the emission bandwidth whichever is less

## Traceability

Test Equipment Used
---------------------

0158, 0287, 0252, 0313, 0314, 0070, 0116, 0117
--

---

This test report may be reproduced in full only. The document may only be updated by MiCOM Labs personnel. Any changes will be noted in the Document History section of the report.



**Title:** APIN0224, APIN0225 802.11a/b/g/n/ac  
**To:** FCC 47 CFR Part 15.407 & IC RSS-210  
**Serial #:** ARUB146-U1 Rev A  
**Issue Date:** 13th June 2013  
**Page:** 76 of 344

---

#### 6.1.1.5. Frequency Stability

**FCC, Part 15 Subpart C §15.407(g)**  
**Industry Canada RSS-210 §2.1**

##### Test Procedure

The manufacturer of the equipment is responsible for ensuring that the frequency stability is such that emissions are always maintained within the band of operation under all conditions.

##### Manufacturer Declaration

The frequency stability of the reference oscillator sets the frequency stability of the RF transceiver signals. Therefore all of the RF signals should have  $\pm 20$ ppm stability.

This stability accounts for room temp tolerance of the crystal oscillator circuit, frequency variation across temperature, and crystal ageing.

$\pm 20$ ppm at 5.250 GHz translates to a maximum frequency shift of  $\pm 105$  KHz. As the edge of the channels is at least one MHz from either of the band edges,  $\pm 105$  KHz is more than sufficient to guarantee that the intentional emission will remain in the band over the entire operating range of the EUT.

##### Specification

##### Limits

**§15.407 (g)** Manufacturers of U-NII devices are responsible for ensuring frequency stability such that an emission is maintained within the band of operation under all conditions of normal operation as specified in the user's manual.

---

This test report may be reproduced in full only. The document may only be updated by MiCOM Labs personnel. Any changes will be noted in the Document History section of the report.



### 6.1.2. Radiated Emission Testing

**FCC, Part 15 Subpart C §15.407(b)(2), §15.205(a)/15.209(a)**  
**Industry Canada RSS-210 §A9.3(2); §2.2; §2.6; RSS-Gen §4.7**

#### **Test Procedure**

Testing was performed in a 3-meter anechoic chamber. Preliminary radiated emissions were measured on every azimuth and with the receiving antenna in both horizontal and vertical polarizations. Preliminary emissions were recorded with in Spectrum Analyzer mode, using a maximum peak detector while in peak hold mode. Depending on the frequency band spanned a notch filter and/or waveguide filter was used to remove the fundamental frequency.

Emissions nearest the limits were chosen for maximization and formal measurement using a CISPR compliant receiver. Emissions above 1000 MHz are measured utilizing a CISPR compliant average detector with a tuned receiver, using a bandwidth of 1 MHz. Emissions from 30 MHz – 1000 MHz are measured utilizing a CISPR compliant quasi-peak detector with a tuned receiver, using a bandwidth of 120 kHz. Only the highest emissions relative to the limit are listed.

#### **Field Strength Calculation**

The field strength is calculated by adding the Antenna Factor and Cable Loss, and subtracting Amplifier Gain from the measured reading. All factors are included in the reported data.

$$FS = R + AF + CORR - FO$$

FS = Field Strength

R = Measured Spectrum analyzer Input Amplitude

AF = Antenna Factor

$$CORR = \text{Correction Factor} = CL - AG + NFL$$

CL = Cable Loss

AG = Amplifier Gain

FO = Distance Falloff Factor

NFL = Notch Filter Loss or Waveguide Loss

Field Strength Calculation Example:

Given receiver input reading of 51.5 dB $\mu$ V; Antenna Factor of 8.5 dB; Cable Loss of 1.3 dB; Falloff Factor of 0 dB, an Amplifier Gain of 26 dB and Notch Filter Loss of 1 dB. The Field Strength of the measured emission is:

$$FS = 51.5 + 8.5 + 1.3 - 26.0 + 1 = 36.3 \text{ dB}\mu\text{V/m}$$

Conversion between dB $\mu$ V/m (or dB $\mu$ V) and  $\mu$ V/m (or  $\mu$ V) are done as:

$$\text{Level (dB}\mu\text{V/m)} = 20 * \text{Log (level (\mu\text{V/m}))}$$

$$40 \text{ dB}\mu\text{V/m} = 100 \mu\text{V/m}$$

$$48 \text{ dB}\mu\text{V/m} = 250 \mu\text{V/m}$$

This test report may be reproduced in full only. The document may only be updated by MiCOM Labs personnel. Any changes will be noted in the Document History section of the report.

The following formula is used to convert the equipment isotropic radiated power (eirp) to field strength (dB $\mu$ V/m);

$$E = 1000000 \times \sqrt{30P} / 3 \mu\text{V/m}$$

where P is the EIRP in Watts

Therefore: -27 dBm/MHz = 68.23 dB $\mu$ V/m

**Note:** The data in this Section identifies that the EUT is in compliance with the -27dBm/MHz EIRP limit (68.23 dB $\mu$ V/m) for out of band emissions. All out of band emissions are less than 68.23 dB  $\mu$ V/m.

#### **Radiated Emissions Test Strategy**

As 802.11a provides the highest spectral power density this mode was exercised for spurious emissions. Radiated band-edge emissions was performed for all operational modes.



**Title:** APIN0224, APIN0225 802.11a/b/g/n/ac  
**To:** FCC 47 CFR Part 15.407 & IC RSS-210  
**Serial #:** ARUB146-U1 Rev A  
**Issue Date:** 13th June 2013  
**Page:** 79 of 344

## Specification

### Radiated Spurious Emissions

**15.407 (b)(2).** All emissions outside of the 5,150-5,350MHz band shall not exceed an EIRP of -27dBm/MHz.

**FCC §15.205 (a)** Except as shown in paragraph (d) of 15.205 (a), only spurious emissions are permitted in any of the frequency bands listed.

**FCC §15.205 (a)** Except as shown in paragraphs (d) and (e) of this section, the field strength of emissions appearing within these frequency bands shall not exceed the limits shown in Section §15.209. At frequencies equal to or less than 1000 MHz, compliance with the limits in Section 15.209 shall be demonstrated using measurement instrumentation employing a CISPR quasi-peak detector. Above 1000 MHz, compliance with the emission limits in Section 15.209 shall be demonstrated based on the average value of the measured emissions. The provisions in Section 15.35 apply to these measurements.

**FCC §15.209 (a)** Except as provided elsewhere in this subpart, the emissions from an intentional radiator shall not exceed the field strength levels specified in the following table.

**RSS-210 §A9.3(2)** For transmitters operating in the 5250-5350 MHz band, all emissions outside the 5150-5350 MHz band shall not exceed -27 dBm/MHz e.i.r.p. Devices operating in the 5250-5350 MHz band that generate emissions in the 5150-5250 MHz band shall not exceed out of band emission limit of 27 dBm/MHz e.i.r.p. in the 5150-5250 MHz band in order to operate indoor/outdoor, or alternatively shall comply with the spectral power density for operation within the 5150-5250 MHz band and shall be labeled "for indoor use only".

**RSS-Gen §4.7** The search for unwanted emissions shall be from the lowest frequency internally generated or used in the device (local oscillator, intermediate of carrier frequency), or from 30 MHz, whichever is the lowest frequency, to the 5<sup>th</sup> harmonic of the highest frequency generated without exceeding 40 GHz.

#### **RSS-Gen §6** Receiver Spurious Emission Standard

If a radiated measurement is made, all spurious emissions shall comply with the limits of the following Table. The resolution bandwidth of the spectrum analyzer shall be 100 kHz for spurious emission measurements below 1.0 GHz and 1.0 MHz for measurements above 1.0 GHz

This test report may be reproduced in full only. The document may only be updated by MiCOM Labs personnel. Any changes will be noted in the Document History section of the report.



**Title:** APIN0224, APIN0225 802.11a/b/g/n/ac  
**To:** FCC 47 CFR Part 15.407 & IC RSS-210  
**Serial #:** ARUB146-U1 Rev A  
**Issue Date:** 13th June 2013  
**Page:** 80 of 344

---

**Table 1: FCC 15.209 Spurious Emissions Limits**

Frequency (MHz)	Field Strength ( $\mu\text{V/m}$ )	Field Strength ( $\text{dB}\mu\text{V/m}$ )	Measurement Distance (meters)
30-88	100	40.0	3
88-216	150	43.5	3
216-960	200	46.0	3
Above 960	500	54.0	3

**Traceability:**

Test Equipment Used
0088, 0158, 0134, 0304, 0311, 0315, 0310, 0312

---

This test report may be reproduced in full only. The document may only be updated by MiCOM Labs personnel. Any changes will be noted in the Document History section of the report.





### 6.1.2.1. Integral Antenna – Spurious Emissions

<b>Test Freq.</b>	5260 MHz	<b>Engineer</b>	SB
<b>Variant</b>	802.11a; 6 Mbs	<b>Temp (°C)</b>	20
<b>Freq. Range</b>	1000 MHz - 18000 MHz	<b>Rel. Hum.(%)</b>	34
<b>Power Setting</b>	18	<b>Press. (mBars)</b>	1009
<b>Antenna</b>	Integral	<b>Duty Cycle (%)</b>	100
<b>Test Notes 1</b>	EUT Position Horizontal; BE emissions were higher when the EUT was in Hozi position vs Vert;		
<b>Test Notes 2</b>			

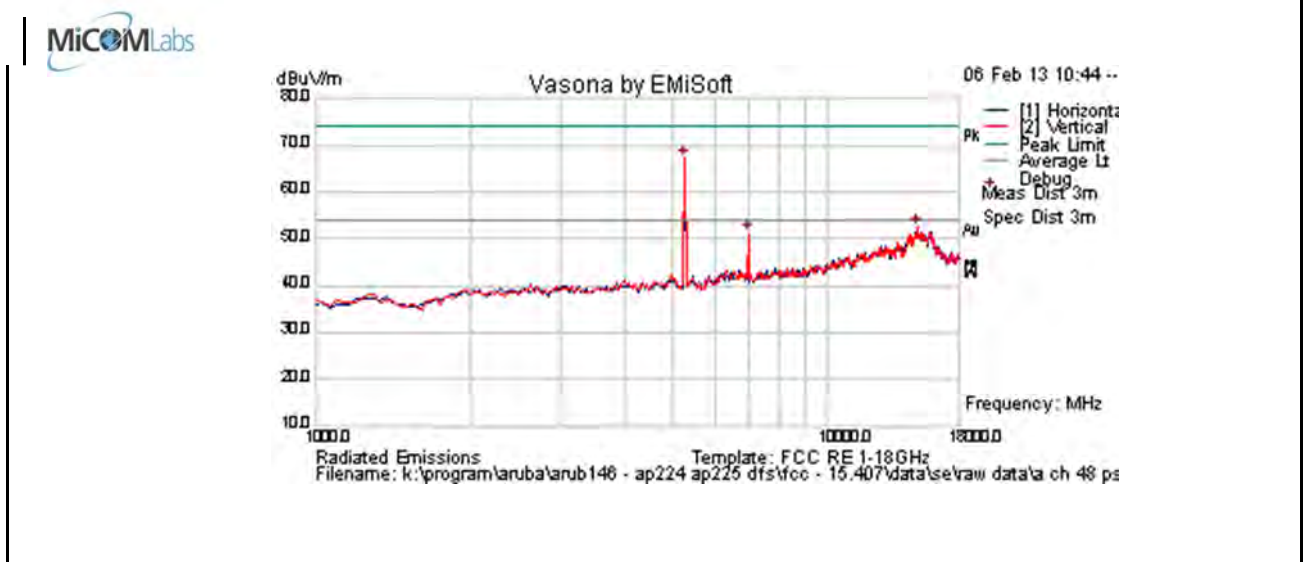

#### Formally measured emission peaks

Frequency MHz	Raw dBuV	Cable Loss	AF dB	Level dBuV/m	Measurement Type	Pol	Hgt cm	Azt Deg	Limit dBuV/m	Margin dB	Pass /Fail	Comments
5258.517	72.2	4.6	-9.7	67.1	Peak [Scan]	V						FUND
14933.868	46.7	8.1	-2.3	52.5	Peak [Scan]	V						NRB
6995.992	52.2	5.4	-6.4	51.2	Peak [Scan]	V						NRB

Legend: TX = Transmitter Emissions; DIG = Digital Emissions; FUND = Fundamental; WB = Wideband Emission  
 NRB = Non-Restricted Band. Limit = 68.23 dBuV/m; RB = Restricted Band. Limits per 15.205

This test report may be reproduced in full only. The document may only be updated by MiCOM Labs personnel. Any changes will be noted in the Document History section of the report.



**Title:** APIN0224, APIN0225 802.11a/b/g/n/ac  
**To:** FCC 47 CFR Part 15.407 & IC RSS-210  
**Serial #:** ARUB146-U1 Rev A  
**Issue Date:** 13th June 2013  
**Page:** 82 of 344

<b>Test Freq.</b>	5300 MHz	<b>Engineer</b>	SB
<b>Variant</b>	802.11a; 6 Mbs	<b>Temp (°C)</b>	20
<b>Freq. Range</b>	1000 MHz - 18000 MHz	<b>Rel. Hum.(%)</b>	34
<b>Power Setting</b>	18	<b>Press. (mBars)</b>	1009
<b>Antenna</b>	Integral	<b>Duty Cycle (%)</b>	100
<b>Test Notes 1</b>	EUT Position Horizontal; BE emissions were higher when the EUT was in Hozi position vs Vert;		
<b>Test Notes 2</b>			

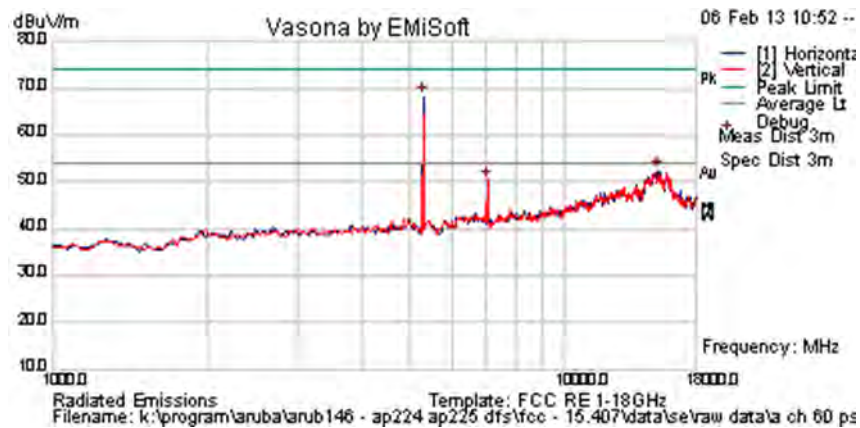

### Formally measured emission peaks

Frequency MHz	Raw dBuV	Cable Loss	AF dB	Level dBuV/m	Measurement Type	Pol	Hgt cm	Azt Deg	Limit dBuV/m	Margin dB	Pass /Fail	Comments
5292.585	73.2	4.6	-9.6	68.2	Peak [Scan]	H						FUND
15172.345	45.8	8.1	-1.6	52.4	Peak [Scan]	H						NRB
7064.128	51.2	5.4	-6.1	50.4	Peak [Scan]	V						NRB
<b>Legend:</b>	TX = Transmitter Emissions; DIG = Digital Emissions; FUND = Fundamental; WB = Wideband Emission											
	NRB = Non-Restricted Band. Limit = 68.23 dBuV/m; RB = Restricted Band. Limits per 15.205											

This test report may be reproduced in full only. The document may only be updated by MiCOM Labs personnel. Any changes will be noted in the Document History section of the report.



**Title:** APIN0224, APIN0225 802.11a/b/g/n/ac  
**To:** FCC 47 CFR Part 15.407 & IC RSS-210  
**Serial #:** ARUB146-U1 Rev A  
**Issue Date:** 13th June 2013  
**Page:** 83 of 344

<b>Test Freq.</b>	5320 MHz	<b>Engineer</b>	SB
<b>Variant</b>	802.11a; 6 Mbs	<b>Temp (°C)</b>	20
<b>Freq. Range</b>	1000 MHz - 18000 MHz	<b>Rel. Hum.(%)</b>	34
<b>Power Setting</b>	18	<b>Press. (mBars)</b>	1009
<b>Antenna</b>	Integral	<b>Duty Cycle (%)</b>	100
<b>Test Notes 1</b>	EUT Position Horizontal; BE emissions were higher when the EUT was in Hozi position vs Vert;		
<b>Test Notes 2</b>			

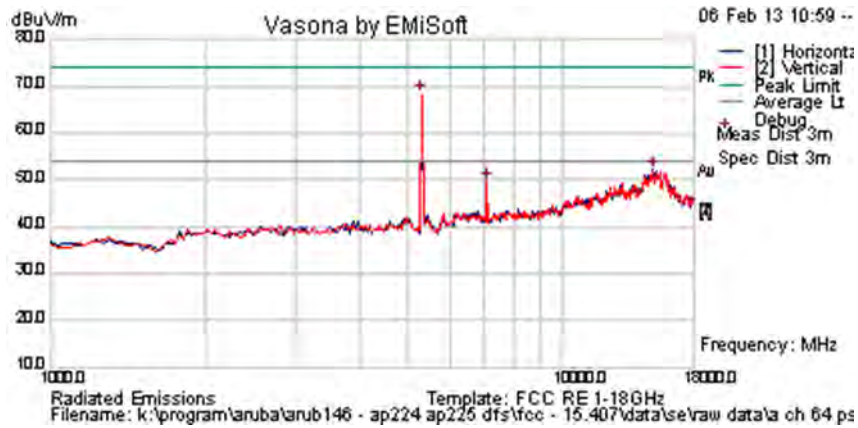

### Formally measured emission peaks

Frequency MHz	Raw dBuV	Cable Loss	AF dB	Level dBuV/m	Measurement Type	Pol	Hgt cm	Azt Deg	Limit dBuV/m	Margin dB	Pass /Fail	Comments
5312.585	73.2	4.6	-9.6	68.2	Peak [Scan]	V						FUND
15002.004	46.2	8.1	-2.1	52.1	Peak [Scan]	H						NRB
7098.196	50.2	5.4	-6.1	49.6	Peak [Scan]	V						NRB
<b>Legend:</b>	TX = Transmitter Emissions; DIG = Digital Emissions; FUND = Fundamental; WB = Wideband Emission NRB = Non-Restricted Band. Limit = 68.23 dBuV/m; RB = Restricted Band. Limits per 15.205											

This test report may be reproduced in full only. The document may only be updated by MiCOM Labs personnel. Any changes will be noted in the Document History section of the report.



**Title:** APIN0224, APIN0225 802.11a/b/g/n/ac  
**To:** FCC 47 CFR Part 15.407 & IC RSS-210  
**Serial #:** ARUB146-U1 Rev A  
**Issue Date:** 13th June 2013  
**Page:** 84 of 344

<b>Test Freq.</b>	5500 MHz	<b>Engineer</b>	SB
<b>Variants</b>	802.11a; 6 Mbs	<b>Temp (°C)</b>	20
<b>Freq. Range</b>	1000 MHz - 18000 MHz	<b>Rel. Hum.(%)</b>	34
<b>Power Setting</b>	18	<b>Press. (mBars)</b>	1009
<b>Antenna</b>	Integral	<b>Duty Cycle (%)</b>	100
<b>Test Notes 1</b>	EUT Position Horizontal; BE emissions were higher when the EUT was in Hozi position vs Vert;		
<b>Test Notes 2</b>			

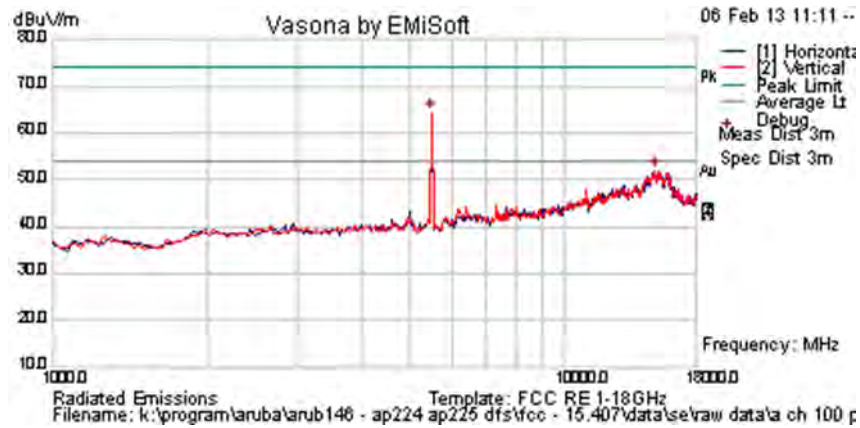

**Formally measured emission peaks**

Frequency MHz	Raw dBuV	Cable Loss	AF dB	Level dBuV/m	Measurement Type	Pol	Hgt cm	Azt Deg	Limit dBuV/m	Margin dB	Pass /Fail	Comments
5496.994	69.3	4.6	-9.6	64.4	Peak [Scan]	V						FUND
15002.004	46.1	8.1	-2.1	52.0	Peak [Scan]	H						NRB

**Legend:** TX = Transmitter Emissions; DIG = Digital Emissions; FUND = Fundamental; WB = Wideband Emission  
 NRB = Non-Restricted Band. Limit = 68.23 dBuV/m; RB = Restricted Band. Limits per 15.205

This test report may be reproduced in full only. The document may only be updated by MiCOM Labs personnel. Any changes will be noted in the Document History section of the report.



**Title:** APIN0224, APIN0225 802.11a/b/g/n/ac  
**To:** FCC 47 CFR Part 15.407 & IC RSS-210  
**Serial #:** ARUB146-U1 Rev A  
**Issue Date:** 13th June 2013  
**Page:** 85 of 344

<b>Test Freq.</b>	5580 MHz	<b>Engineer</b>	SB
<b>Variant</b>	802.11a; 6 Mbs	<b>Temp (°C)</b>	20
<b>Freq. Range</b>	1000 MHz - 18000 MHz	<b>Rel. Hum.(%)</b>	34
<b>Power Setting</b>	18	<b>Press. (mBars)</b>	1009
<b>Antenna</b>	Integral	<b>Duty Cycle (%)</b>	100
<b>Test Notes 1</b>	EUT Position Horizontal; BE emissions were higher when the EUT was in Hozi position vs Vert;		
<b>Test Notes 2</b>			

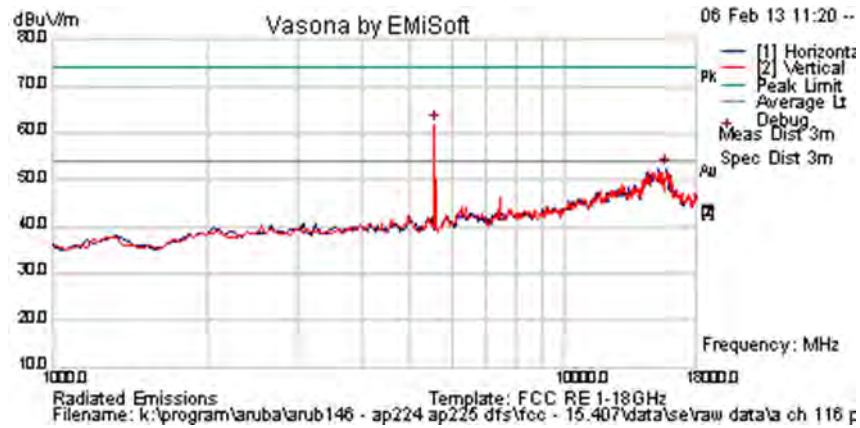

**Formally measured emission peaks**

Frequency MHz	Raw dBuV	Cable Loss	AF dB	Level dBuV/m	Measurement Type	Pol	Hgt cm	Azt Deg	Limit dBuV/m	Margin dB	Pass /Fail	Comments
5565.130	66.9	4.7	-9.7	61.9	Peak [Scan]	V						FUND
14995.511	46.4	8.1	-2.1	52.4	Peak [Scan]	H						NRB

<b>Legend:</b>	TX = Transmitter Emissions; DIG = Digital Emissions; FUND = Fundamental; WB = Wideband Emission
	NRB = Non-Restricted Band. Limit = 68.23 dBuV/m; RB = Restricted Band. Limits per 15.205

This test report may be reproduced in full only. The document may only be updated by MiCOM Labs personnel. Any changes will be noted in the Document History section of the report.



**Title:** APIN0224, APIN0225 802.11a/b/g/n/ac  
**To:** FCC 47 CFR Part 15.407 & IC RSS-210  
**Serial #:** ARUB146-U1 Rev A  
**Issue Date:** 13th June 2013  
**Page:** 86 of 344

<b>Test Freq.</b>	5700 MHz	<b>Engineer</b>	SB
<b>Variant</b>	802.11a; 6 Mbs	<b>Temp (°C)</b>	20
<b>Freq. Range</b>	1000 MHz - 18000 MHz	<b>Rel. Hum.(%)</b>	34
<b>Power Setting</b>	18	<b>Press. (mBars)</b>	1009
<b>Antenna</b>	Integral	<b>Duty Cycle (%)</b>	100
<b>Test Notes 1</b>	EUT Position Horizontal; BE emissions were higher when the EUT was in Hozi position vs Vert;		
<b>Test Notes 2</b>			

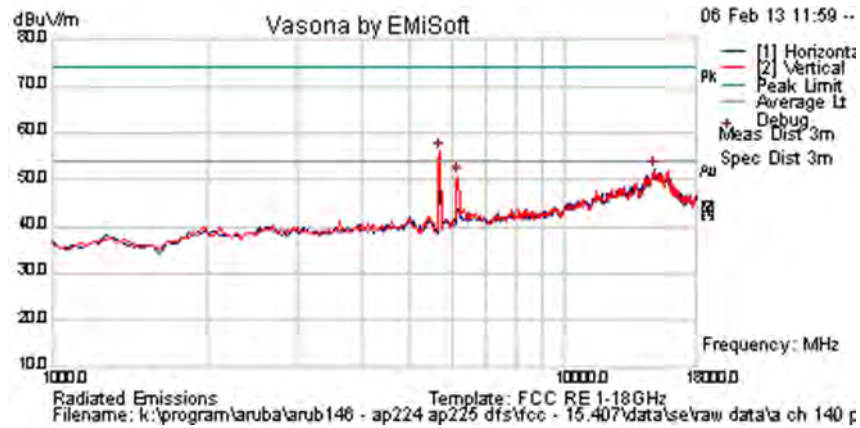

**Formally measured emission peaks**

Frequency MHz	Raw dBuV	Cable Loss	AF dB	Level dBuV/m	Measurement Type	Pol	Hgt cm	Azt Deg	Limit dBuV/m	Margin dB	Pass /Fail	Comments
5701.403	60.9	4.7	-9.6	56.1	Peak [Scan]	V						FUND
14899.8	46.4	8.1	-2.4	52.1	Peak [Scan]	H						NRB
6178.357	53.7	5.0	-7.9	50.8	Peak [Scan]	V						NRB
<b>Legend:</b>	TX = Transmitter Emissions; DIG = Digital Emissions; FUND = Fundamental; WB = Wideband Emission											
	NRB = Non-Restricted Band. Limit = 68.23 dBuV/m; RB = Restricted Band. Limits per 15.205											

This test report may be reproduced in full only. The document may only be updated by MiCOM Labs personnel. Any changes will be noted in the Document History section of the report.



**Title:** APIN0224, APIN0225 802.11a/b/g/n/ac  
**To:** FCC 47 CFR Part 15.407 & IC RSS-210  
**Serial #:** ARUB146-U1 Rev A  
**Issue Date:** 13th June 2013  
**Page:** 87 of 344

### 6.1.2.2. ANT-1B – Spurious Emissions

<b>Test Freq.</b>	5260 MHz	<b>Engineer</b>	SB
<b>Variant</b>	802.11a; 6 Mbs	<b>Temp (°C)</b>	19
<b>Freq. Range</b>	1000 MHz - 18000 MHz	<b>Rel. Hum.(%)</b>	34
<b>Power Setting</b>	18	<b>Press. (mBars)</b>	1003
<b>Antenna</b>	AP-ANT-1B	<b>Duty Cycle (%)</b>	100
<b>Test Notes 1</b>	POE located outside the chamber with ferrite a clamp on cables.		
<b>Test Notes 2</b>			

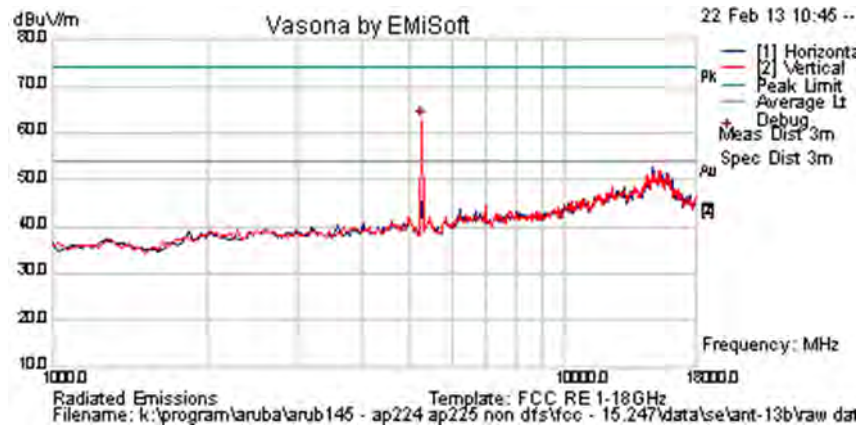

#### Formally measured emission peaks

Frequency MHz	Raw dBuV	Cable Loss	AF dB	Level dBuV/m	Measurement Type	PoI	Hgt cm	Azt Deg	Limit dBuV/m	Margin dB	Pass /Fail	Comments
5258.517	64.9	4.6	-9.7	59.8	Peak [Scan]	V	100					FUND
Legend: TX = Transmitter Emissions; DIG = Digital Emissions; FUND = Fundamental; WB = Wideband Emission NRB = Non-Restricted Band. Limit = 68.23 dBuV/m; RB = Restricted Band. Limits per 15.205												

This test report may be reproduced in full only. The document may only be updated by MiCOM Labs personnel. Any changes will be noted in the Document History section of the report.



**Title:** APIN0224, APIN0225 802.11a/b/g/n/ac  
**To:** FCC 47 CFR Part 15.407 & IC RSS-210  
**Serial #:** ARUB146-U1 Rev A  
**Issue Date:** 13th June 2013  
**Page:** 88 of 344

<b>Test Freq.</b>	5300 MHz	<b>Engineer</b>	SB
<b>Variant</b>	802.11a; 6 Mbs	<b>Temp (°C)</b>	19
<b>Freq. Range</b>	1000 MHz - 18000 MHz	<b>Rel. Hum.(%)</b>	34
<b>Power Setting</b>	18	<b>Press. (mBars)</b>	1003
<b>Antenna</b>	AP-ANT-1B	<b>Duty Cycle (%)</b>	100
<b>Test Notes 1</b>	POE located outside the chamber with ferrite a clamp on cables.		
<b>Test Notes 2</b>			

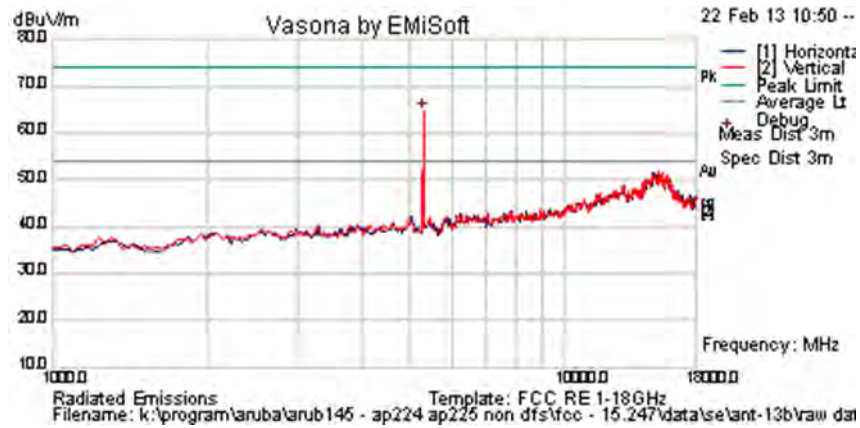

**Formally measured emission peaks**

Frequency MHz	Raw dBuV	Cable Loss	AF dB	Level dBuV/m	Measurement Type	PoI	Hgt cm	Azt Deg	Limit dBuV/m	Margin dB	Pass /Fail	Comments
5292.585	67.3	4.6	-9.6	62.3	Peak [Scan]	V	100					FUND

Legend:	TX = Transmitter Emissions; DIG = Digital Emissions; FUND = Fundamental; WB = Wideband Emission
	NRB = Non-Restricted Band. Limit = 68.23 dBuV/m; RB = Restricted Band. Limits per 15.205

This test report may be reproduced in full only. The document may only be updated by MiCOM Labs personnel. Any changes will be noted in the Document History section of the report.





**Title:** APIN0224, APIN0225 802.11a/b/g/n/ac  
**To:** FCC 47 CFR Part 15.407 & IC RSS-210  
**Serial #:** ARUB146-U1 Rev A  
**Issue Date:** 13th June 2013  
**Page:** 89 of 344

<b>Test Freq.</b>	5320 MHz	<b>Engineer</b>	SB
<b>Variant</b>	802.11a; 6 Mbs	<b>Temp (°C)</b>	19
<b>Freq. Range</b>	1000 MHz - 18000 MHz	<b>Rel. Hum.(%)</b>	34
<b>Power Setting</b>	18	<b>Press. (mBars)</b>	1003
<b>Antenna</b>	AP-ANT-1B	<b>Duty Cycle (%)</b>	100
<b>Test Notes 1</b>	POE located outside the chamber with ferrite a clamp on cables.		
<b>Test Notes 2</b>			

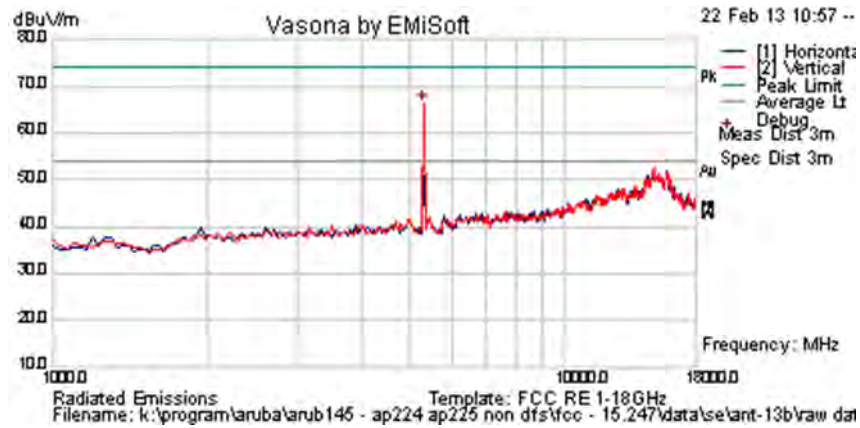

**Formally measured emission peaks**

Frequency MHz	Raw dBuV	Cable Loss	AF dB	Level dBuV/m	Measurement Type	PoI	Hgt cm	Azt Deg	Limit dBuV/m	Margin dB	Pass /Fail	Comments
5312.585	67.8	4.6	-9.6	62.9	Peak [Scan]	V	100					FUND

Legend:	TX = Transmitter Emissions; DIG = Digital Emissions; FUND = Fundamental; WB = Wideband Emission
	NRB = Non-Restricted Band. Limit = 68.23 dBuV/m; RB = Restricted Band. Limits per 15.205

This test report may be reproduced in full only. The document may only be updated by MiCOM Labs personnel. Any changes will be noted in the Document History section of the report.



**Title:** APIN0224, APIN0225 802.11a/b/g/n/ac  
**To:** FCC 47 CFR Part 15.407 & IC RSS-210  
**Serial #:** ARUB146-U1 Rev A  
**Issue Date:** 13th June 2013  
**Page:** 90 of 344

<b>Test Freq.</b>	5500 MHz	<b>Engineer</b>	SB
<b>Variant</b>	802.11a; 6 Mbs	<b>Temp (°C)</b>	19
<b>Freq. Range</b>	1000 MHz - 18000 MHz	<b>Rel. Hum.(%)</b>	34
<b>Power Setting</b>	18	<b>Press. (mBars)</b>	1003
<b>Antenna</b>	AP-ANT-1B	<b>Duty Cycle (%)</b>	100
<b>Test Notes 1</b>	POE located outside the chamber with ferrite a clamp on cables.		
<b>Test Notes 2</b>			

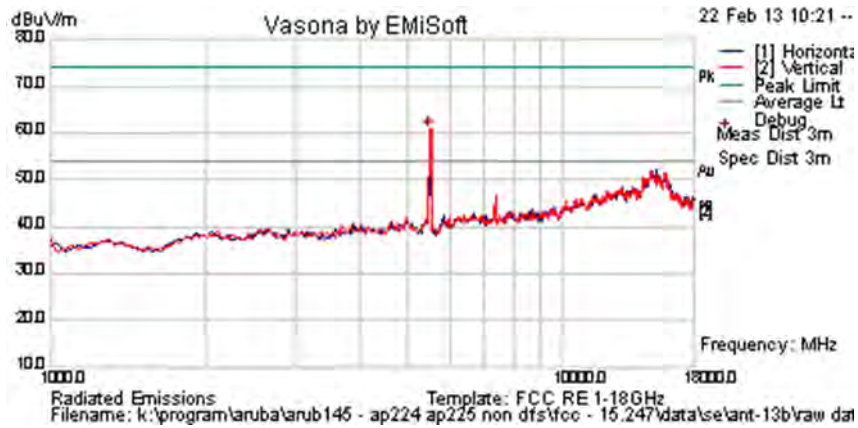

**Formally measured emission peaks**

Frequency MHz	Raw dBuV	Cable Loss	AF dB	Level dBuV/m	Measurement Type	PoI	Hgt cm	Azt Deg	Limit dBuV/m	Margin dB	Pass /Fail	Comments
5496.994	65.9	4.6	-9.6	60.9	Peak [Scan]	V	100					FUND

Legend:	TX = Transmitter Emissions; DIG = Digital Emissions; FUND = Fundamental; WB = Wideband Emission
	NRB = Non-Restricted Band. Limit = 68.23 dBuV/m; RB = Restricted Band. Limits per 15.205

This test report may be reproduced in full only. The document may only be updated by MiCOM Labs personnel. Any changes will be noted in the Document History section of the report.



**Title:** APIN0224, APIN0225 802.11a/b/g/n/ac  
**To:** FCC 47 CFR Part 15.407 & IC RSS-210  
**Serial #:** ARUB146-U1 Rev A  
**Issue Date:** 13th June 2013  
**Page:** 91 of 344

<b>Test Freq.</b>	5580 MHz	<b>Engineer</b>	SB
<b>Variant</b>	802.11a; 6 Mbs	<b>Temp (°C)</b>	19
<b>Freq. Range</b>	1000 MHz - 18000 MHz	<b>Rel. Hum.(%)</b>	34
<b>Power Setting</b>	18	<b>Press. (mBars)</b>	1003
<b>Antenna</b>	AP-ANT-1B	<b>Duty Cycle (%)</b>	100
<b>Test Notes 1</b>	POE located outside the chamber with ferrite a clamp on cables.		
<b>Test Notes 2</b>			

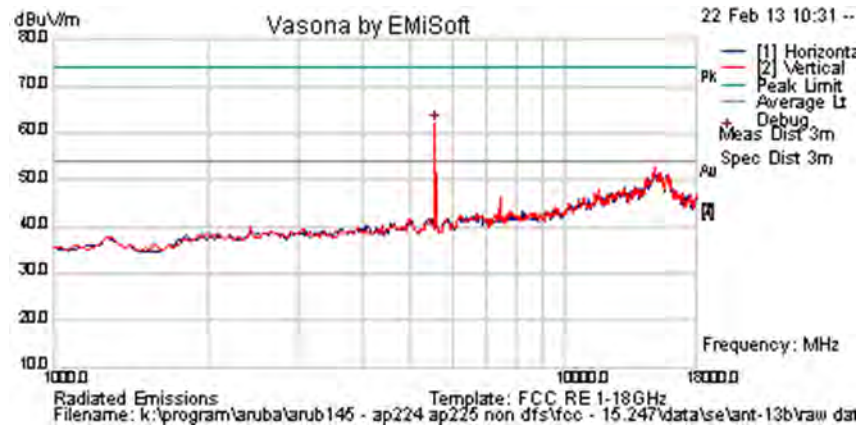

**Formally measured emission peaks**

Frequency MHz	Raw dBuV	Cable Loss	AF dB	Level dBuV/m	Measurement Type	Pol	Hgt cm	Azt Deg	Limit dBuV/m	Margin dB	Pass /Fail	Comments
5565.130	62.9	4.7	-9.7	57.9	Peak [Scan]	V	100					FUND
Legend: TX = Transmitter Emissions; DIG = Digital Emissions; FUND = Fundamental; WB = Wideband Emission NRB = Non-Restricted Band. Limit = 68.23 dBuV/m; RB = Restricted Band. Limits per 15.205												

This test report may be reproduced in full only. The document may only be updated by MiCOM Labs personnel. Any changes will be noted in the Document History section of the report.



**Title:** APIN0224, APIN0225 802.11a/b/g/n/ac  
**To:** FCC 47 CFR Part 15.407 & IC RSS-210  
**Serial #:** ARUB146-U1 Rev A  
**Issue Date:** 13th June 2013  
**Page:** 92 of 344

<b>Test Freq.</b>	5700 MHz	<b>Engineer</b>	SB
<b>Variant</b>	802.11a; 6 Mbs	<b>Temp (°C)</b>	19
<b>Freq. Range</b>	1000 MHz - 18000 MHz	<b>Rel. Hum.(%)</b>	34
<b>Power Setting</b>	18	<b>Press. (mBars)</b>	1003
<b>Antenna</b>	AP-ANT-1B	<b>Duty Cycle (%)</b>	100
<b>Test Notes 1</b>	POE located outside the chamber with ferrite a clamp on cables.		
<b>Test Notes 2</b>			

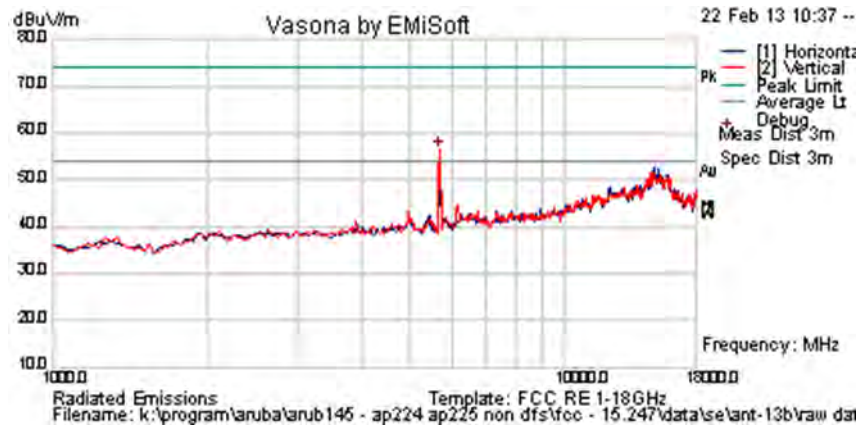

**Formally measured emission peaks**

Frequency MHz	Raw dBuV	Cable Loss	AF dB	Level dBuV/m	Measurement Type	Pol	Hgt cm	Azt Deg	Limit dBuV/m	Margin dB	Pass /Fail	Comments
5701.403	57.2	4.7	-9.6	52.4	Peak [Scan]	H	100					FUND

Legend:	TX = Transmitter Emissions; DIG = Digital Emissions; FUND = Fundamental; WB = Wideband Emission
	NRB = Non-Restricted Band. Limit = 68.23 dBuV/m; RB = Restricted Band. Limits per 15.205

This test report may be reproduced in full only. The document may only be updated by MiCOM Labs personnel. Any changes will be noted in the Document History section of the report.



**Title:** APIN0224, APIN0225 802.11a/b/g/n/ac  
**To:** FCC 47 CFR Part 15.407 & IC RSS-210  
**Serial #:** ARUB146-U1 Rev A  
**Issue Date:** 13th June 2013  
**Page:** 93 of 344

### 6.1.2.3. ANT-13B – Spurious Emissions

<b>Test Freq.</b>	5260 MHz	<b>Engineer</b>	SB
<b>Variant</b>	802.11a; 6 Mbs	<b>Temp (°C)</b>	19
<b>Freq. Range</b>	1000 MHz - 18000 MHz	<b>Rel. Hum.(%)</b>	34
<b>Power Setting</b>	18	<b>Press. (mBars)</b>	1003
<b>Antenna</b>	AP-ANT-13B	<b>Duty Cycle (%)</b>	100
<b>Test Notes 1</b>	POE located outside the chamber with ferrite a clamp on cables.		
<b>Test Notes 2</b>			

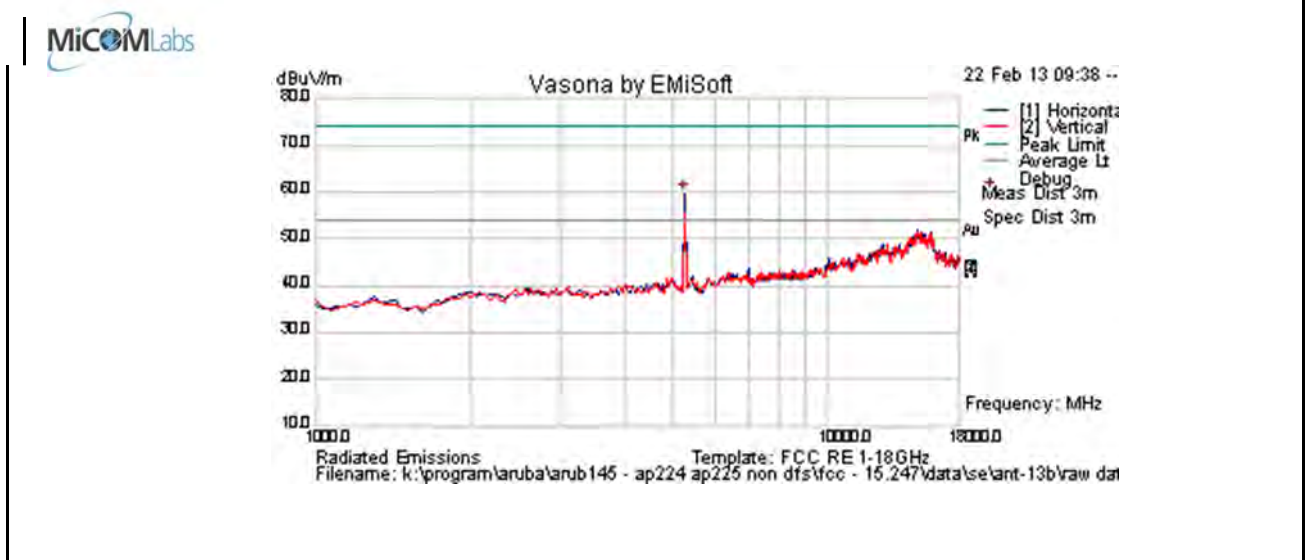

#### Formally measured emission peaks

Frequency MHz	Raw dBuV	Cable Loss	AF dB	Level dBuV/m	Measurement Type	Pol	Hgt cm	Azt Deg	Limit dBuV/m	Margin dB	Pass /Fail	Comments
5258.517	64.9	4.6	-9.7	59.8	Peak [Scan]	H	100					FUND
Legend: TX = Transmitter Emissions; DIG = Digital Emissions; FUND = Fundamental; WB = Wideband Emission NRB = Non-Restricted Band. Limit = 68.23 dBuV/m; RB = Restricted Band. Limits per 15.205												

This test report may be reproduced in full only. The document may only be updated by MiCOM Labs personnel. Any changes will be noted in the Document History section of the report.



**Title:** APIN0224, APIN0225 802.11a/b/g/n/ac  
**To:** FCC 47 CFR Part 15.407 & IC RSS-210  
**Serial #:** ARUB146-U1 Rev A  
**Issue Date:** 13th June 2013  
**Page:** 94 of 344

<b>Test Freq.</b>	5300 MHz	<b>Engineer</b>	SB
<b>Variant</b>	802.11a; 6 Mbs	<b>Temp (°C)</b>	19
<b>Freq. Range</b>	1000 MHz - 18000 MHz	<b>Rel. Hum.(%)</b>	34
<b>Power Setting</b>	18	<b>Press. (mBars)</b>	1003
<b>Antenna</b>	AP-ANT-13B	<b>Duty Cycle (%)</b>	100
<b>Test Notes 1</b>	POE located outside the chamber with ferrite a clamp on cables.		
<b>Test Notes 2</b>			

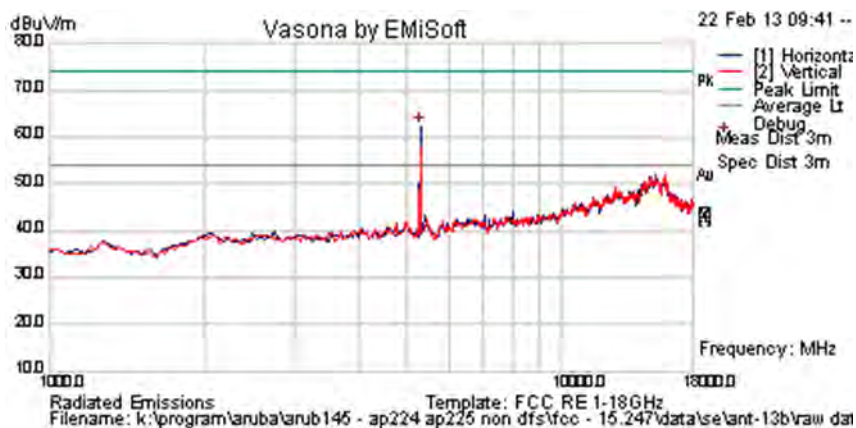

### Formally measured emission peaks

Frequency MHz	Raw dBuV	Cable Loss	AF dB	Level dBuV/m	Measurement Type	PoI	Hgt cm	Azt Deg	Limit dBuV/m	Margin dB	Pass /Fail	Comments
5292.585	67.3	4.6	-9.6	62.3	Peak [Scan]	H	100					FUND

Legend: TX = Transmitter Emissions; DIG = Digital Emissions; FUND = Fundamental; WB = Wideband Emission  
 NRB = Non-Restricted Band. Limit = 68.23 dBuV/m; RB = Restricted Band. Limits per 15.205

This test report may be reproduced in full only. The document may only be updated by MiCOM Labs personnel. Any changes will be noted in the Document History section of the report.



**Title:** APIN0224, APIN0225 802.11a/b/g/n/ac  
**To:** FCC 47 CFR Part 15.407 & IC RSS-210  
**Serial #:** ARUB146-U1 Rev A  
**Issue Date:** 13th June 2013  
**Page:** 95 of 344

<b>Test Freq.</b>	5320 MHz	<b>Engineer</b>	SB
<b>Variant</b>	802.11a; 6 Mbs	<b>Temp (°C)</b>	19
<b>Freq. Range</b>	1000 MHz - 18000 MHz	<b>Rel. Hum.(%)</b>	34
<b>Power Setting</b>	18	<b>Press. (mBars)</b>	1003
<b>Antenna</b>	AP-ANT-13B	<b>Duty Cycle (%)</b>	100
<b>Test Notes 1</b>	POE located outside the chamber with ferrite a clamp on cables.		
<b>Test Notes 2</b>			

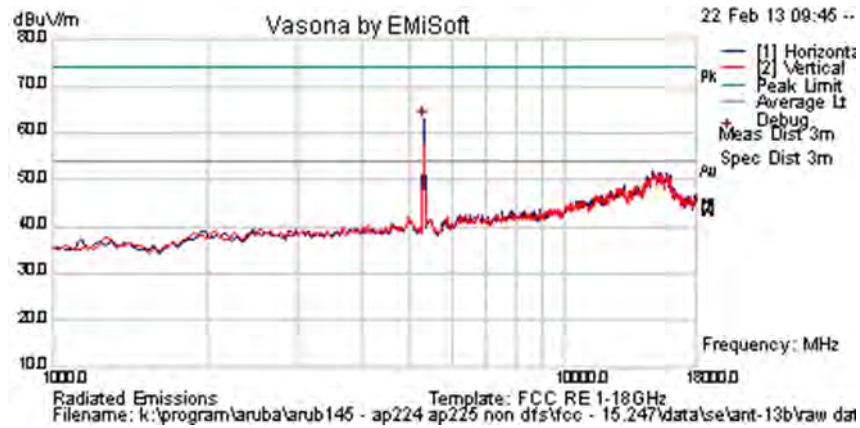

**Formally measured emission peaks**

Frequency MHz	Raw dBuV	Cable Loss	AF dB	Level dBuV/m	Measurement Type	PoI	Hgt cm	Azt Deg	Limit dBuV/m	Margin dB	Pass /Fail	Comments
5312.585	67.8	4.6	-9.6	62.9	Peak [Scan]	H	100					FUND

Legend:	TX = Transmitter Emissions; DIG = Digital Emissions; FUND = Fundamental; WB = Wideband Emission
	NRB = Non-Restricted Band. Limit = 68.23 dBuV/m; RB = Restricted Band. Limits per 15.205

This test report may be reproduced in full only. The document may only be updated by MiCOM Labs personnel. Any changes will be noted in the Document History section of the report.



**Title:** APIN0224, APIN0225 802.11a/b/g/n/ac  
**To:** FCC 47 CFR Part 15.407 & IC RSS-210  
**Serial #:** ARUB146-U1 Rev A  
**Issue Date:** 13th June 2013  
**Page:** 96 of 344

<b>Test Freq.</b>	5500 MHz	<b>Engineer</b>	SB
<b>Variant</b>	802.11a; 6 Mbs	<b>Temp (°C)</b>	19
<b>Freq. Range</b>	1000 MHz - 18000 MHz	<b>Rel. Hum.(%)</b>	34
<b>Power Setting</b>	18	<b>Press. (mBars)</b>	1003
<b>Antenna</b>	AP-ANT-13B	<b>Duty Cycle (%)</b>	100
<b>Test Notes 1</b>	POE located outside the chamber with ferrite a clamp on cables.		
<b>Test Notes 2</b>			

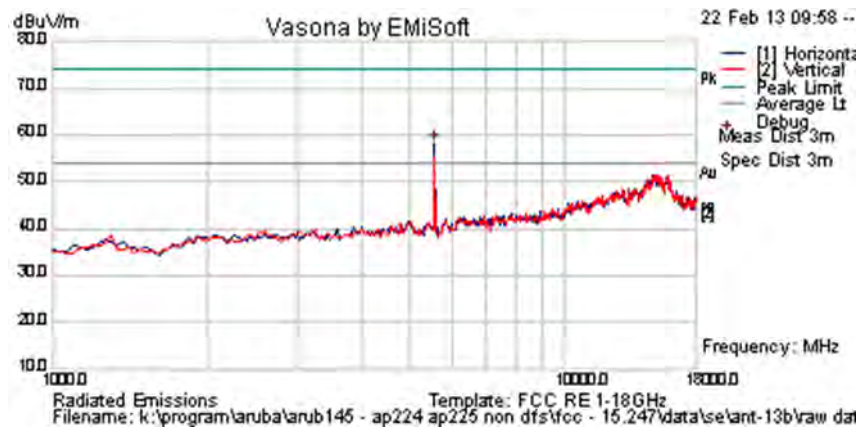

### Formally measured emission peaks

Frequency MHz	Raw dBuV	Cable Loss	AF dB	Level dBuV/m	Measurement Type	PoI	Hgt cm	Azt Deg	Limit dBuV/m	Margin dB	Pass /Fail	Comments
5505.130	63.1	4.7	-9.7	58.1	Peak [Scan]	H	100					FUND

Legend: TX = Transmitter Emissions; DIG = Digital Emissions; FUND = Fundamental; WB = Wideband Emission  
 NRB = Non-Restricted Band. Limit = 68.23 dBuV/m; RB = Restricted Band. Limits per 15.205

This test report may be reproduced in full only. The document may only be updated by MiCOM Labs personnel. Any changes will be noted in the Document History section of the report.





**Title:** APIN0224, APIN0225 802.11a/b/g/n/ac  
**To:** FCC 47 CFR Part 15.407 & IC RSS-210  
**Serial #:** ARUB146-U1 Rev A  
**Issue Date:** 13th June 2013  
**Page:** 97 of 344

<b>Test Freq.</b>	5580 MHz	<b>Engineer</b>	SB
<b>Variants</b>	802.11a; 6 Mbs	<b>Temp (°C)</b>	19
<b>Freq. Range</b>	1000 MHz - 18000 MHz	<b>Rel. Hum.(%)</b>	34
<b>Power Setting</b>	18	<b>Press. (mBars)</b>	1003
<b>Antenna</b>	AP-ANT-13B	<b>Duty Cycle (%)</b>	100
<b>Test Notes 1</b>	POE located outside the chamber with ferrite a clamp on cables.		
<b>Test Notes 2</b>			

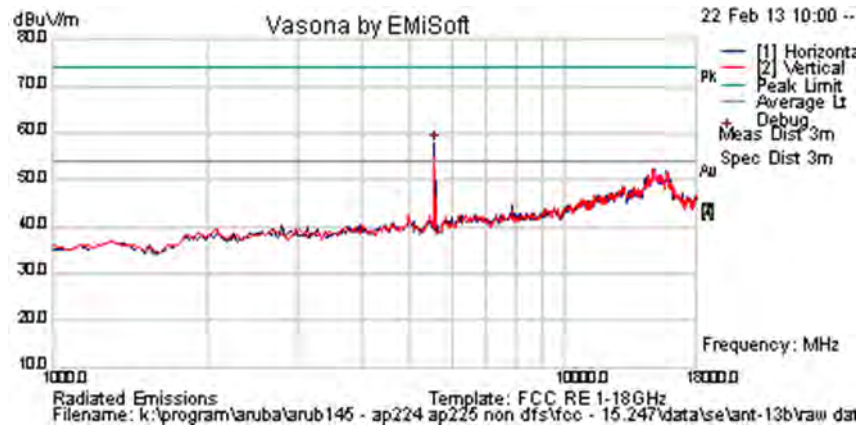

### Formally measured emission peaks

Frequency MHz	Raw dBuV	Cable Loss	AF dB	Level dBuV/m	Measurement Type	Pol	Hgt cm	Azt Deg	Limit dBuV/m	Margin dB	Pass /Fail	Comments
5565.130	62.9	4.7	-9.7	57.9	Peak [Scan]	H	100					FUND

Legend: TX = Transmitter Emissions; DIG = Digital Emissions; FUND = Fundamental; WB = Wideband Emission  
 NRB = Non-Restricted Band. Limit = 68.23 dBuV/m; RB = Restricted Band. Limits per 15.205

This test report may be reproduced in full only. The document may only be updated by MiCOM Labs personnel. Any changes will be noted in the Document History section of the report.



**Title:** APIN0224, APIN0225 802.11a/b/g/n/ac  
**To:** FCC 47 CFR Part 15.407 & IC RSS-210  
**Serial #:** ARUB146-U1 Rev A  
**Issue Date:** 13th June 2013  
**Page:** 98 of 344

<b>Test Freq.</b>	5700 MHz	<b>Engineer</b>	SB
<b>Variant</b>	802.11a; 6 Mbs	<b>Temp (°C)</b>	19
<b>Freq. Range</b>	1000 MHz - 18000 MHz	<b>Rel. Hum.(%)</b>	34
<b>Power Setting</b>	18	<b>Press. (mBars)</b>	1003
<b>Antenna</b>	AP-ANT-13B	<b>Duty Cycle (%)</b>	100
<b>Test Notes 1</b>	POE located outside the chamber with ferrite a clamp on cables.		
<b>Test Notes 2</b>			

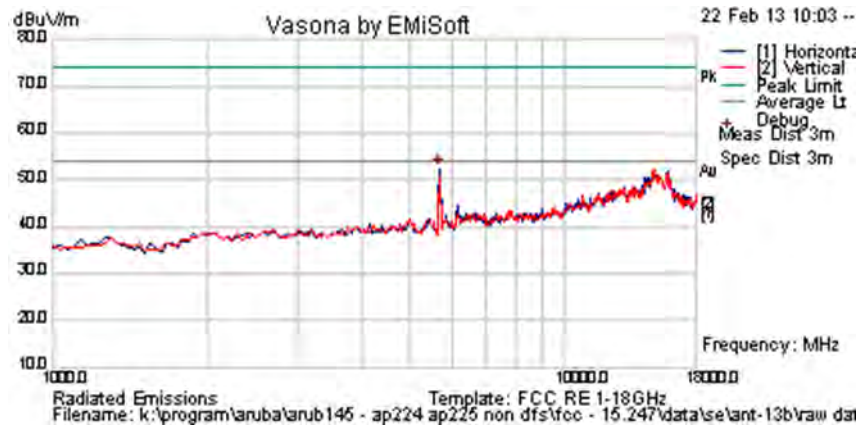

**Formally measured emission peaks**

Frequency MHz	Raw dBuV	Cable Loss	AF dB	Level dBuV/m	Measurement Type	Pol	Hgt cm	Azt Deg	Limit dBuV/m	Margin dB	Pass /Fail	Comments
5701.403	57.2	4.7	-9.6	52.4	Peak [Scan]	H	100					FUND

Legend: TX = Transmitter Emissions; DIG = Digital Emissions; FUND = Fundamental; WB = Wideband Emission  
 NRB = Non-Restricted Band. Limit = 68.23 dBuV/m; RB = Restricted Band. Limits per 15.205

This test report may be reproduced in full only. The document may only be updated by MiCOM Labs personnel. Any changes will be noted in the Document History section of the report.



**Title:** APIN0224, APIN0225 802.11a/b/g/n/ac  
**To:** FCC 47 CFR Part 15.407 & IC RSS-210  
**Serial #:** ARUB146-U1 Rev A  
**Issue Date:** 13th June 2013  
**Page:** 99 of 344

### 6.1.2.4. ANT-16 – Spurious Emissions

<b>Test Freq.</b>	5260 MHz	<b>Engineer</b>	SB
<b>Variant</b>	802.11a; 6 Mbs	<b>Temp (°C)</b>	19
<b>Freq. Range</b>	1000 MHz - 18000 MHz	<b>Rel. Hum.(%)</b>	34
<b>Power Setting</b>	18	<b>Press. (mBars)</b>	1003
<b>Antenna</b>	AP-ANT-16	<b>Duty Cycle (%)</b>	100
<b>Test Notes 1</b>	POE located outside the chamber with ferrite a clamp on cables.		
<b>Test Notes 2</b>			

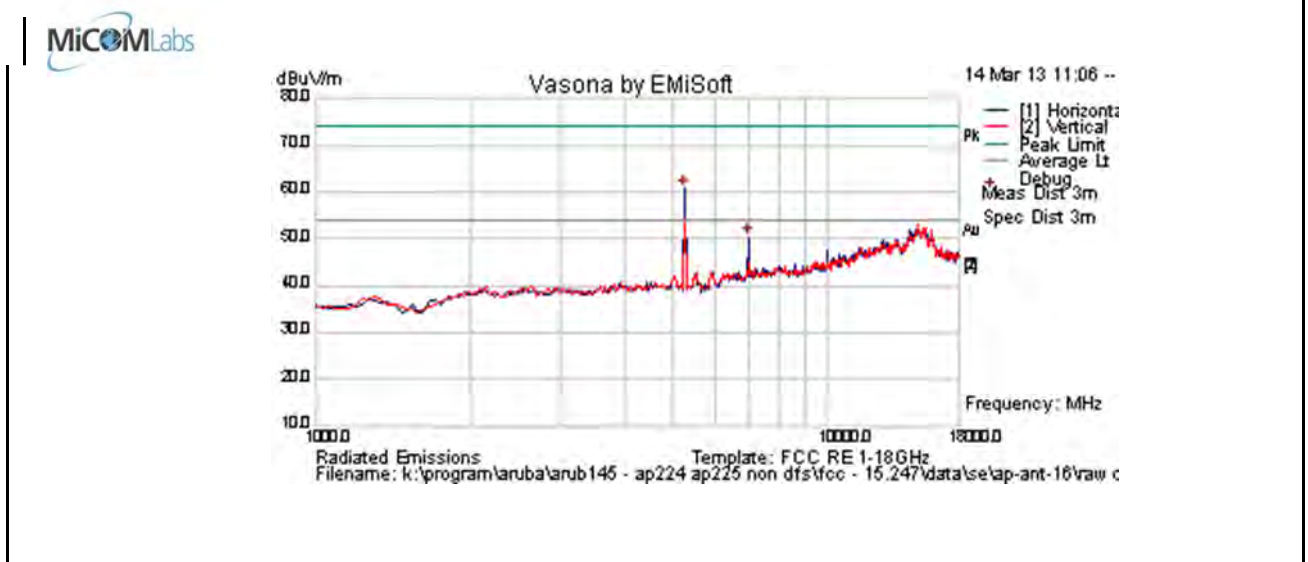

#### Formally measured emission peaks

Frequency MHz	Raw dBuV	Cable Loss	AF dB	Level dBuV/m	Measurement Type	Pol	Hgt cm	Azt Deg	Limit dBuV/m	Margin dB	Pass /Fail	Comments
5258.517	65.8	4.8	-9.7	60.8	Peak [Scan]	H	150					FUND
6995.99198	51.0	5.7	-6.4	50.3	Peak [Scan]	H	100	0	54	-3.7	Pass	NRB
Legend: TX = Transmitter Emissions; DIG = Digital Emissions; FUND = Fundamental; WB = Wideband Emission NRB = Non-Restricted Band. Limit = 68.23 dBuV/m; RB = Restricted Band. Limits per 15.205												

This test report may be reproduced in full only. The document may only be updated by MiCOM Labs personnel. Any changes will be noted in the Document History section of the report.



**Title:** APIN0224, APIN0225 802.11a/b/g/n/ac  
**To:** FCC 47 CFR Part 15.407 & IC RSS-210  
**Serial #:** ARUB146-U1 Rev A  
**Issue Date:** 13th June 2013  
**Page:** 100 of 344

<b>Test Freq.</b>	5300 MHz	<b>Engineer</b>	SB
<b>Variant</b>	802.11a; 6 Mbs	<b>Temp (°C)</b>	19
<b>Freq. Range</b>	1000 MHz - 18000 MHz	<b>Rel. Hum.(%)</b>	34
<b>Power Setting</b>	18	<b>Press. (mBars)</b>	1003
<b>Antenna</b>	AP-ANT-16	<b>Duty Cycle (%)</b>	100
<b>Test Notes 1</b>	POE located outside the chamber with ferrite a clamp on cables.		
<b>Test Notes 2</b>			

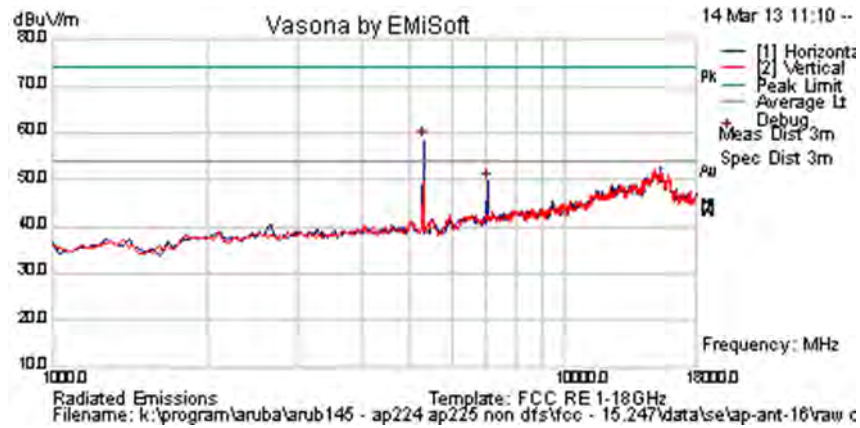

**Formally measured emission peaks**

Frequency MHz	Raw dBuV	Cable Loss	AF dB	Level dBuV/m	Measurement Type	PoI	Hgt cm	Azt Deg	Limit dBuV/m	Margin dB	Pass /Fail	Comments
5292.585	63.2	4.8	-9.6	58.5	Peak [Scan]	H	100					FUND
7064.12826	50.1	5.7	-6.1	49.7	Peak [Scan]	H	100	0	54	-4.3	Pass	NRB

<b>Legend:</b>	TX = Transmitter Emissions; DIG = Digital Emissions; FUND = Fundamental; WB = Wideband Emission
	NRB = Non-Restricted Band. Limit = 68.23 dBuV/m; RB = Restricted Band. Limits per 15.205

This test report may be reproduced in full only. The document may only be updated by MiCOM Labs personnel. Any changes will be noted in the Document History section of the report.



**Title:** APIN0224, APIN0225 802.11a/b/g/n/ac  
**To:** FCC 47 CFR Part 15.407 & IC RSS-210  
**Serial #:** ARUB146-U1 Rev A  
**Issue Date:** 13th June 2013  
**Page:** 101 of 344

<b>Test Freq.</b>	5320 MHz	<b>Engineer</b>	SB
<b>Variant</b>	802.11a; 6 Mbs	<b>Temp (°C)</b>	19
<b>Freq. Range</b>	1000 MHz - 18000 MHz	<b>Rel. Hum.(%)</b>	34
<b>Power Setting</b>	18	<b>Press. (mBars)</b>	1003
<b>Antenna</b>	AP-ANT-16	<b>Duty Cycle (%)</b>	100
<b>Test Notes 1</b>	POE located outside the chamber with ferrite a clamp on cables.		
<b>Test Notes 2</b>			

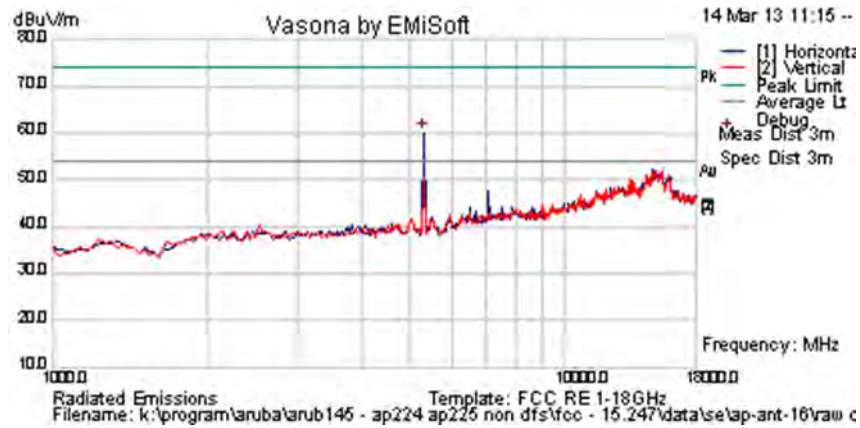

**Formally measured emission peaks**

Frequency MHz	Raw dBuV	Cable Loss	AF dB	Level dBuV/m	Measurement Type	Pol	Hgt cm	Azt Deg	Limit dBuV/m	Margin dB	Pass /Fail	Comments
5292.585	64.9	4.8	-9.6	60.1	Peak [Scan]	H	100					FUND

Legend:	TX = Transmitter Emissions; DIG = Digital Emissions; FUND = Fundamental; WB = Wideband Emission
	NRB = Non-Restricted Band. Limit = 68.23 dBuV/m; RB = Restricted Band. Limits per 15.205

This test report may be reproduced in full only. The document may only be updated by MiCOM Labs personnel. Any changes will be noted in the Document History section of the report.



**Title:** APIN0224, APIN0225 802.11a/b/g/n/ac  
**To:** FCC 47 CFR Part 15.407 & IC RSS-210  
**Serial #:** ARUB146-U1 Rev A  
**Issue Date:** 13th June 2013  
**Page:** 102 of 344

<b>Test Freq.</b>	5500 MHz	<b>Engineer</b>	SB
<b>Variant</b>	802.11a; 6 Mbs	<b>Temp (°C)</b>	19
<b>Freq. Range</b>	1000 MHz - 18000 MHz	<b>Rel. Hum.(%)</b>	34
<b>Power Setting</b>	18	<b>Press. (mBars)</b>	1003
<b>Antenna</b>	AP-ANT-16	<b>Duty Cycle (%)</b>	100
<b>Test Notes 1</b>	POE located outside the chamber with ferrite a clamp on cables.		
<b>Test Notes 2</b>			

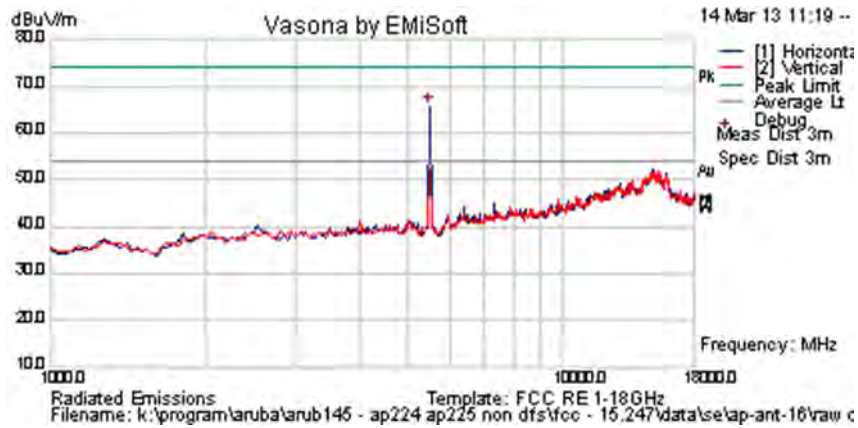

**Formally measured emission peaks**

Frequency MHz	Raw dBuV	Cable Loss	AF dB	Level dBuV/m	Measurement Type	PoI	Hgt cm	Azt Deg	Limit dBuV/m	Margin dB	Pass /Fail	Comments
5496.994	70.3	5.0	-9.6	65.6	Peak [Scan]	H	100					FUND

Legend:	TX = Transmitter Emissions; DIG = Digital Emissions; FUND = Fundamental; WB = Wideband Emission
	NRB = Non-Restricted Band. Limit = 68.23 dBuV/m; RB = Restricted Band. Limits per 15.205

This test report may be reproduced in full only. The document may only be updated by MiCOM Labs personnel. Any changes will be noted in the Document History section of the report.



**Title:** APIN0224, APIN0225 802.11a/b/g/n/ac  
**To:** FCC 47 CFR Part 15.407 & IC RSS-210  
**Serial #:** ARUB146-U1 Rev A  
**Issue Date:** 13th June 2013  
**Page:** 103 of 344

<b>Test Freq.</b>	5580 MHz	<b>Engineer</b>	SB
<b>Variant</b>	802.11a; 6 Mbs	<b>Temp (°C)</b>	19
<b>Freq. Range</b>	1000 MHz - 18000 MHz	<b>Rel. Hum.(%)</b>	34
<b>Power Setting</b>	18	<b>Press. (mBars)</b>	1003
<b>Antenna</b>	AP-ANT-16	<b>Duty Cycle (%)</b>	100
<b>Test Notes 1</b>	POE located outside the chamber with ferrite a clamp on cables.		
<b>Test Notes 2</b>			

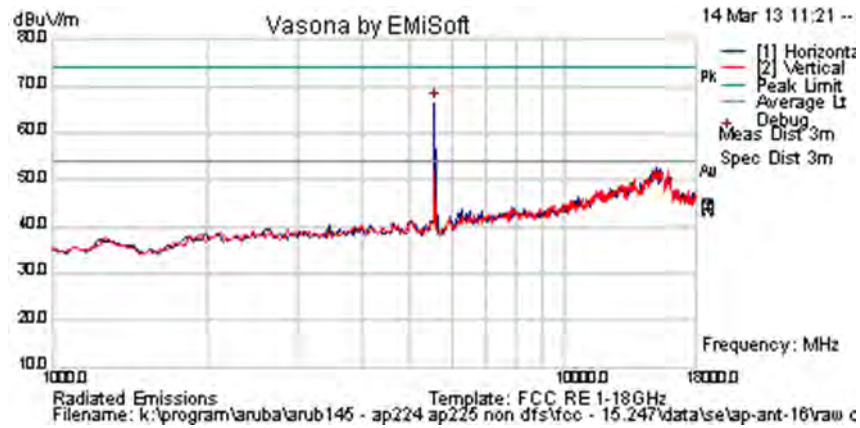

### Formally measured emission peaks

Frequency MHz	Raw dBuV	Cable Loss	AF dB	Level dBuV/m	Measurement Type	Pol	Hgt cm	Azt Deg	Limit dBuV/m	Margin dB	Pass /Fail	Comments
5565.130	71.3	4.9	-9.7	66.6	Peak [Scan]	H	100					FUND

Legend: TX = Transmitter Emissions; DIG = Digital Emissions; FUND = Fundamental; WB = Wideband Emission  
 NRB = Non-Restricted Band. Limit = 68.23 dBuV/m; RB = Restricted Band. Limits per 15.205

This test report may be reproduced in full only. The document may only be updated by MiCOM Labs personnel. Any changes will be noted in the Document History section of the report.



**Title:** APIN0224, APIN0225 802.11a/b/g/n/ac  
**To:** FCC 47 CFR Part 15.407 & IC RSS-210  
**Serial #:** ARUB146-U1 Rev A  
**Issue Date:** 13th June 2013  
**Page:** 104 of 344

<b>Test Freq.</b>	5700 MHz	<b>Engineer</b>	SB
<b>Variant</b>	802.11a; 6 Mbs	<b>Temp (°C)</b>	19
<b>Freq. Range</b>	1000 MHz - 18000 MHz	<b>Rel. Hum.(%)</b>	34
<b>Power Setting</b>	18	<b>Press. (mBars)</b>	1003
<b>Antenna</b>	AP-ANT-16	<b>Duty Cycle (%)</b>	100
<b>Test Notes 1</b>	POE located outside the chamber with ferrite a clamp on cables.		
<b>Test Notes 2</b>			

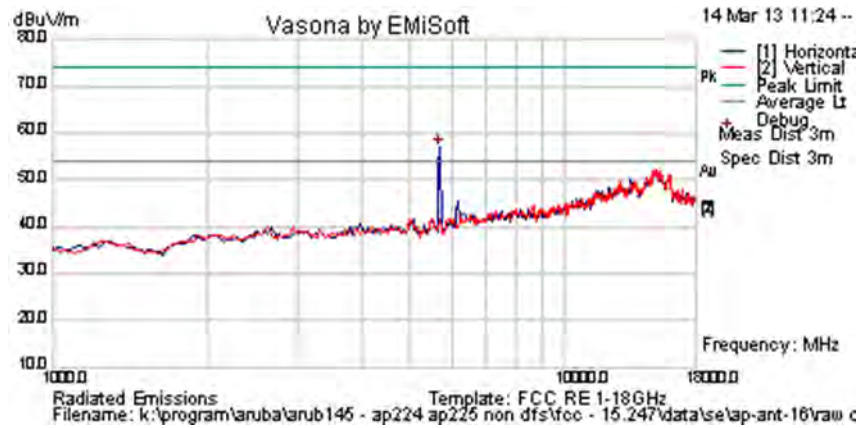

**Formally measured emission peaks**

Frequency MHz	Raw dBuV	Cable Loss	AF dB	Level dBuV/m	Measurement Type	Pol	Hgt cm	Azt Deg	Limit dBuV/m	Margin dB	Pass /Fail	Comments
5701.403	61.6	5.0	-9.6	57.0	Peak [Scan]	H	100					FUND

Legend:	TX = Transmitter Emissions; DIG = Digital Emissions; FUND = Fundamental; WB = Wideband Emission
	NRB = Non-Restricted Band. Limit = 68.23 dBuV/m; RB = Restricted Band. Limits per 15.205

This test report may be reproduced in full only. The document may only be updated by MiCOM Labs personnel. Any changes will be noted in the Document History section of the report.





**Title:** APIN0224, APIN0225 802.11a/b/g/n/ac  
**To:** FCC 47 CFR Part 15.407 & IC RSS-210  
**Serial #:** ARUB146-U1 Rev A  
**Issue Date:** 13th June 2013  
**Page:** 105 of 344

### 6.1.2.5. ANT-18 – Spurious Emissions

<b>Test Freq.</b>	5260 MHz	<b>Engineer</b>	SB
<b>Variants</b>	802.11a; 6 Mbs	<b>Temp (°C)</b>	19
<b>Freq. Range</b>	1000 MHz - 18000 MHz	<b>Rel. Hum.(%)</b>	34
<b>Power Setting</b>	18	<b>Press. (mBars)</b>	1003
<b>Antenna</b>	AP-ANT-18	<b>Duty Cycle (%)</b>	100
<b>Test Notes 1</b>	POE located outside the chamber with ferrite a clamp on cables.		
<b>Test Notes 2</b>			

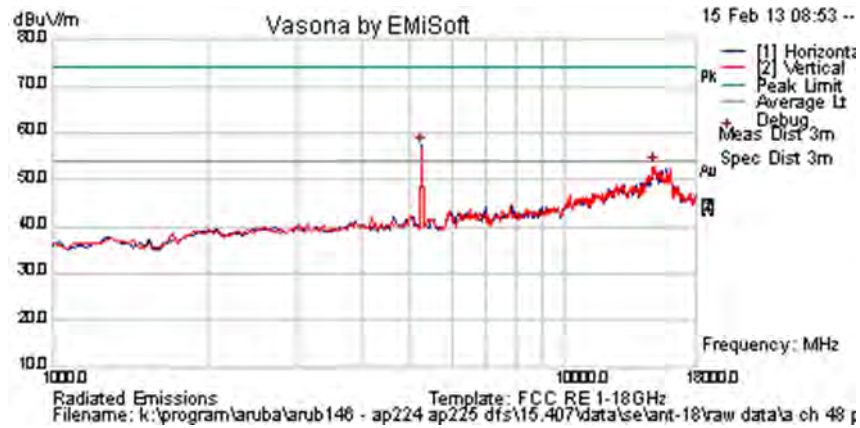

#### Formally measured emission peaks

Frequency MHz	Raw dBuV	Cable Loss	AF dB	Level dBuV/m	Measurement Type	PoI	Hgt cm	Azt Deg	Limit dBuV/m	Margin dB	Pass /Fail	Comments
5258.517	62.5	4.6	-9.7	57.3	Peak [Scan]	H	150					FUND
14865.731	47.3	8.2	-2.5	52.9	Peak [Scan]	V	100					NRB
Legend: TX = Transmitter Emissions; DIG = Digital Emissions; FUND = Fundamental; WB = Wideband Emission NRB = Non-Restricted Band. Limit = 68.23 dBuV/m; RB = Restricted Band. Limits per 15.205												

This test report may be reproduced in full only. The document may only be updated by MiCOM Labs personnel. Any changes will be noted in the Document History section of the report.



**Title:** APIN0224, APIN0225 802.11a/b/g/n/ac  
**To:** FCC 47 CFR Part 15.407 & IC RSS-210  
**Serial #:** ARUB146-U1 Rev A  
**Issue Date:** 13th June 2013  
**Page:** 106 of 344

<b>Test Freq.</b>	5300 MHz	<b>Engineer</b>	SB
<b>Variants</b>	802.11a; 6 Mbs	<b>Temp (°C)</b>	19
<b>Freq. Range</b>	1000 MHz - 18000 MHz	<b>Rel. Hum.(%)</b>	34
<b>Power Setting</b>	18	<b>Press. (mBars)</b>	1003
<b>Antenna</b>	AP-ANT-18	<b>Duty Cycle (%)</b>	100
<b>Test Notes 1</b>	POE located outside the chamber with ferrite a clamp on cables.		
<b>Test Notes 2</b>			

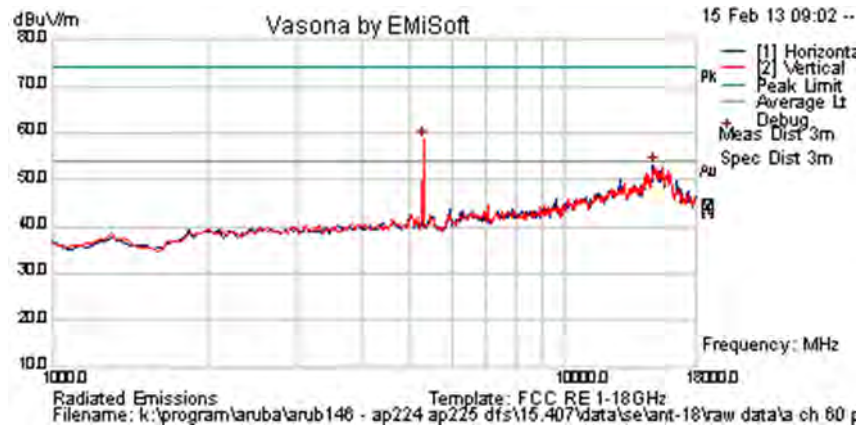

**Formally measured emission peaks**

Frequency MHz	Raw dBuV	Cable Loss	AF dB	Level dBuV/m	Measurement Type	PoI	Hgt cm	Azt Deg	Limit dBuV/m	Margin dB	Pass /Fail	Comments
5292.585	63.6	4.6	-9.6	58.6	Peak [Scan]	H	100					FUND
14865.731	47.4	8.2	-2.5	53.0	Peak [Scan]	H	100					NRB

**Legend:** TX = Transmitter Emissions; DIG = Digital Emissions; FUND = Fundamental; WB = Wideband Emission  
 NRB = Non-Restricted Band. Limit = 68.23 dBuV/m; RB = Restricted Band. Limits per 15.205

This test report may be reproduced in full only. The document may only be updated by MiCOM Labs personnel. Any changes will be noted in the Document History section of the report.



**Title:** APIN0224, APIN0225 802.11a/b/g/n/ac  
**To:** FCC 47 CFR Part 15.407 & IC RSS-210  
**Serial #:** ARUB146-U1 Rev A  
**Issue Date:** 13th June 2013  
**Page:** 107 of 344

<b>Test Freq.</b>	5320 MHz	<b>Engineer</b>	SB
<b>Variant</b>	802.11a; 6 Mbs	<b>Temp (°C)</b>	19
<b>Freq. Range</b>	1000 MHz - 18000 MHz	<b>Rel. Hum.(%)</b>	34
<b>Power Setting</b>	18	<b>Press. (mBars)</b>	1003
<b>Antenna</b>	AP-ANT-18	<b>Duty Cycle (%)</b>	100
<b>Test Notes 1</b>	POE located outside the chamber with ferrite a clamp on cables.		
<b>Test Notes 2</b>			

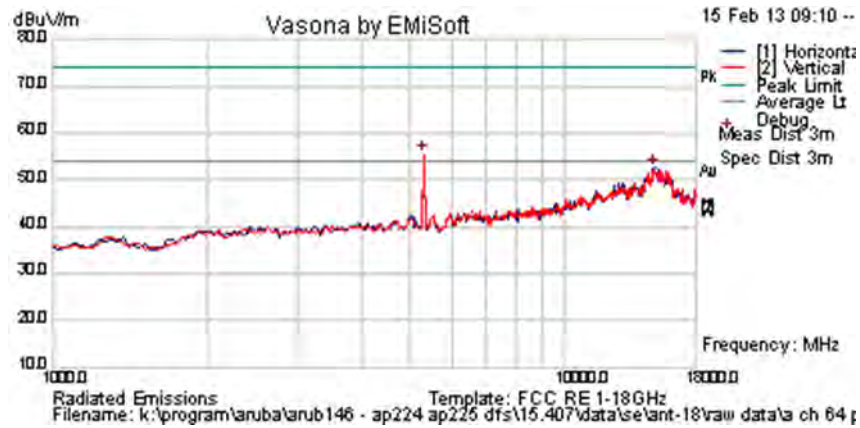

### Formally measured emission peaks

Frequency MHz	Raw dBuV	Cable Loss	AF dB	Level dBuV/m	Measurement Type	PoI	Hgt cm	Azt Deg	Limit dBuV/m	Margin dB	Pass /Fail	Comments
5312.585	60.4	4.6	-9.6	55.5	Peak [Scan]	V	200					FUND
14899.8	47.0	8.1	-2.4	52.7	Peak [Scan]	H	150					NRB

**Legend:** TX = Transmitter Emissions; DIG = Digital Emissions; FUND = Fundamental; WB = Wideband Emission  
 NRB = Non-Restricted Band. Limit = 68.23 dBuV/m; RB = Restricted Band. Limits per 15.205

This test report may be reproduced in full only. The document may only be updated by MiCOM Labs personnel. Any changes will be noted in the Document History section of the report.



**Title:** APIN0224, APIN0225 802.11a/b/g/n/ac  
**To:** FCC 47 CFR Part 15.407 & IC RSS-210  
**Serial #:** ARUB146-U1 Rev A  
**Issue Date:** 13th June 2013  
**Page:** 108 of 344

<b>Test Freq.</b>	5500 MHz	<b>Engineer</b>	SB
<b>Variant</b>	802.11a; 6 Mbs	<b>Temp (°C)</b>	19
<b>Freq. Range</b>	1000 MHz - 18000 MHz	<b>Rel. Hum.(%)</b>	34
<b>Power Setting</b>	18	<b>Press. (mBars)</b>	1003
<b>Antenna</b>	AP-ANT-18	<b>Duty Cycle (%)</b>	100
<b>Test Notes 1</b>	POE located outside the chamber with ferrite a clamp on cables.		
<b>Test Notes 2</b>			

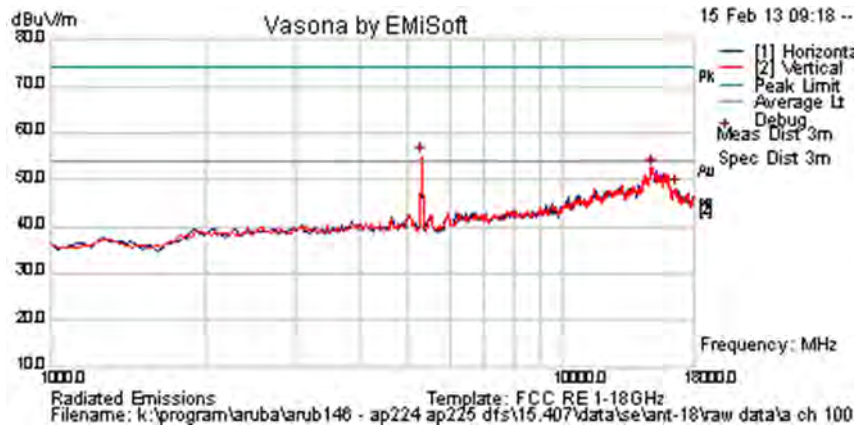

**Formally measured emission peaks**

Frequency MHz	Raw dBuV	Cable Loss	AF dB	Level dBuV/m	Measurement Type	PoI	Hgt cm	Azt Deg	Limit dBuV/m	Margin dB	Pass /Fail	Comments
5490.585	60.0	4.6	-9.6	55.0	Peak [Scan]	V	200					FUND
14865.731	47.0	8.2	-2.5	52.6	Peak [Scan]	V	100					NRB

<b>Legend:</b>	TX = Transmitter Emissions; DIG = Digital Emissions; FUND = Fundamental; WB = Wideband Emission
	NRB = Non-Restricted Band. Limit = 68.23 dBuV/m; RB = Restricted Band. Limits per 15.205

This test report may be reproduced in full only. The document may only be updated by MiCOM Labs personnel. Any changes will be noted in the Document History section of the report.



**Title:** APIN0224, APIN0225 802.11a/b/g/n/ac  
**To:** FCC 47 CFR Part 15.407 & IC RSS-210  
**Serial #:** ARUB146-U1 Rev A  
**Issue Date:** 13th June 2013  
**Page:** 109 of 344

<b>Test Freq.</b>	5580 MHz	<b>Engineer</b>	SB
<b>Variant</b>	802.11a; 6 Mbs	<b>Temp (°C)</b>	19
<b>Freq. Range</b>	1000 MHz - 18000 MHz	<b>Rel. Hum.(%)</b>	34
<b>Power Setting</b>	18	<b>Press. (mBars)</b>	1003
<b>Antenna</b>	AP-ANT-18	<b>Duty Cycle (%)</b>	100
<b>Test Notes 1</b>	POE located outside the chamber with ferrite a clamp on cables.		
<b>Test Notes 2</b>			

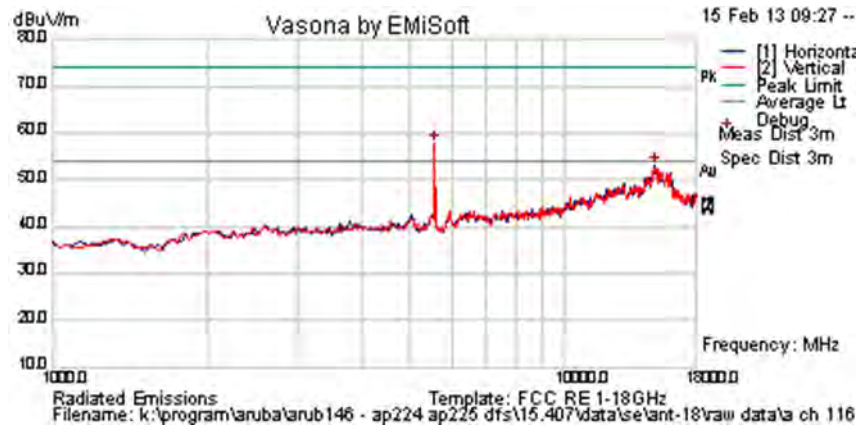

**Formally measured emission peaks**

Frequency MHz	Raw dBuV	Cable Loss	AF dB	Level dBuV/m	Measurement Type	Pol	Hgt cm	Azt Deg	Limit dBuV/m	Margin dB	Pass /Fail	Comments
5565.130	62.7	4.7	-9.7	57.7	Peak [Scan]	V	100					FUND
15002.004	47.1	8.1	-2.1	53.1	Peak [Scan]	H	100					NRB

**Legend:** TX = Transmitter Emissions; DIG = Digital Emissions; FUND = Fundamental; WB = Wideband Emission  
 NRB = Non-Restricted Band. Limit = 68.23 dBuV/m; RB = Restricted Band. Limits per 15.205

This test report may be reproduced in full only. The document may only be updated by MiCOM Labs personnel. Any changes will be noted in the Document History section of the report.



**Title:** APIN0224, APIN0225 802.11a/b/g/n/ac  
**To:** FCC 47 CFR Part 15.407 & IC RSS-210  
**Serial #:** ARUB146-U1 Rev A  
**Issue Date:** 13th June 2013  
**Page:** 110 of 344

<b>Test Freq.</b>	5700 MHz	<b>Engineer</b>	SB
<b>Variant</b>	802.11a; 6 Mbs	<b>Temp (°C)</b>	19
<b>Freq. Range</b>	1000 MHz - 18000 MHz	<b>Rel. Hum.(%)</b>	34
<b>Power Setting</b>	18	<b>Press. (mBars)</b>	1003
<b>Antenna</b>	AP-ANT-18	<b>Duty Cycle (%)</b>	100
<b>Test Notes 1</b>	POE located outside the chamber with ferrite a clamp on cables.		
<b>Test Notes 2</b>			

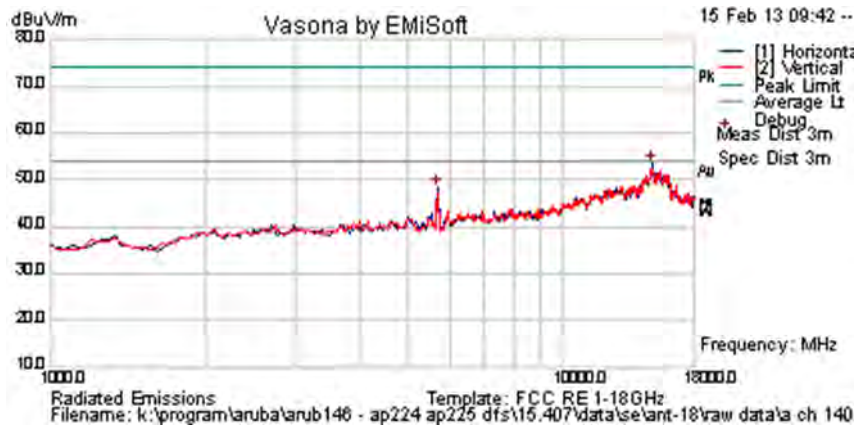

### Formally measured emission peaks

Frequency MHz	Raw dBuV	Cable Loss	AF dB	Level dBuV/m	Measurement Type	PoI	Hgt cm	Azt Deg	Limit dBuV/m	Margin dB	Pass /Fail	Comments
14933.868	47.8	8.1	-2.3	53.6	Peak [Scan]	H	150					NRB
5701.40281	53.1	4.7	-9.6	48.2	Peak [Scan]	H	100					FUND

**Legend:** TX = Transmitter Emissions; DIG = Digital Emissions; FUND = Fundamental; WB = Wideband Emission  
 NRB = Non-Restricted Band. Limit = 68.23 dBuV/m; RB = Restricted Band. Limits per 15.205

This test report may be reproduced in full only. The document may only be updated by MiCOM Labs personnel. Any changes will be noted in the Document History section of the report.



**Title:** APIN0224, APIN0225 802.11a/b/g/n/ac  
**To:** FCC 47 CFR Part 15.407 & IC RSS-210  
**Serial #:** ARUB146-U1 Rev A  
**Issue Date:** 13th June 2013  
**Page:** 111 of 344

### 6.1.2.6. ANT-19 – Spurious Emissions

<b>Test Freq.</b>	5260 MHz	<b>Engineer</b>	SB
<b>Variant</b>	802.11a; 6 Mbs	<b>Temp (°C)</b>	19
<b>Freq. Range</b>	1000 MHz - 18000 MHz	<b>Rel. Hum.(%)</b>	34
<b>Power Setting</b>	18	<b>Press. (mBars)</b>	1003
<b>Antenna</b>	AP-ANT-19	<b>Duty Cycle (%)</b>	100
<b>Test Notes 1</b>	POE located outside the chamber with ferrite a clamp on cables.		
<b>Test Notes 2</b>			

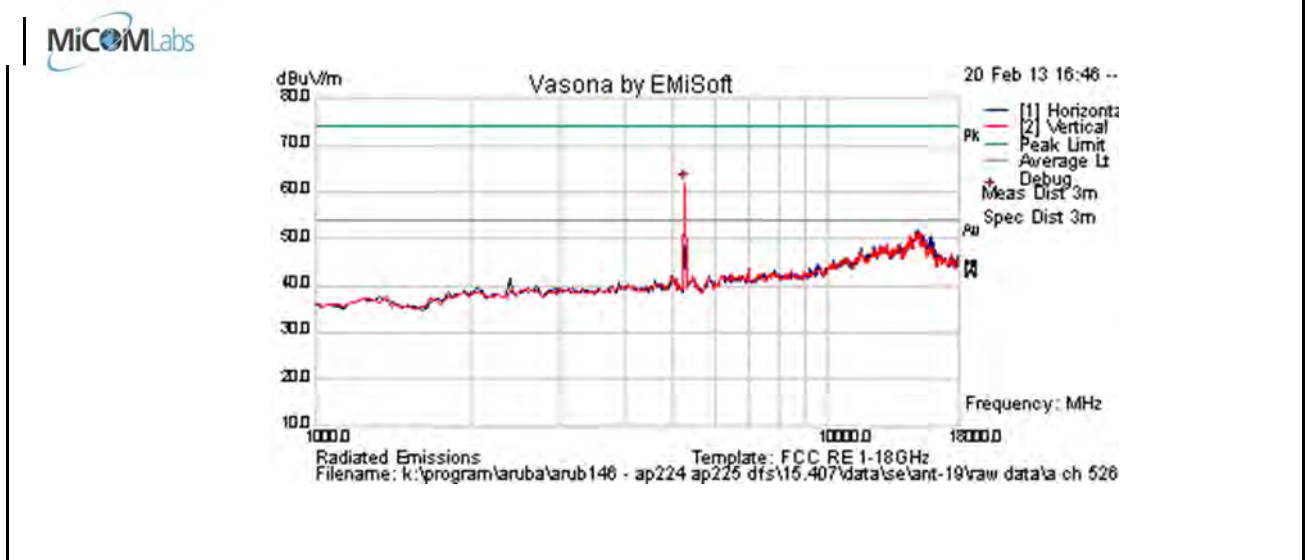

#### Formally measured emission peaks

Frequency MHz	Raw dBuV	Cable Loss	AF dB	Level dBuV/m	Measurement Type	PoI	Hgt cm	Azt Deg	Limit dBuV/m	Margin dB	Pass /Fail	Comments
5258.517	66.9	4.6	-9.7	61.7	Peak [Scan]	V	100					FUND
Legend: TX = Transmitter Emissions; DIG = Digital Emissions; FUND = Fundamental; WB = Wideband Emission NRB = Non-Restricted Band. Limit = 68.23 dBuV/m; RB = Restricted Band. Limits per 15.205												

This test report may be reproduced in full only. The document may only be updated by MiCOM Labs personnel. Any changes will be noted in the Document History section of the report.



**Title:** APIN0224, APIN0225 802.11a/b/g/n/ac  
**To:** FCC 47 CFR Part 15.407 & IC RSS-210  
**Serial #:** ARUB146-U1 Rev A  
**Issue Date:** 13th June 2013  
**Page:** 112 of 344

<b>Test Freq.</b>	5300 MHz	<b>Engineer</b>	SB
<b>Variant</b>	802.11a; 6 Mbs	<b>Temp (°C)</b>	19
<b>Freq. Range</b>	1000 MHz - 18000 MHz	<b>Rel. Hum.(%)</b>	34
<b>Power Setting</b>	18	<b>Press. (mBars)</b>	1003
<b>Antenna</b>	AP-ANT-19	<b>Duty Cycle (%)</b>	100
<b>Test Notes 1</b>	POE located outside the chamber with ferrite a clamp on cables.		
<b>Test Notes 2</b>			

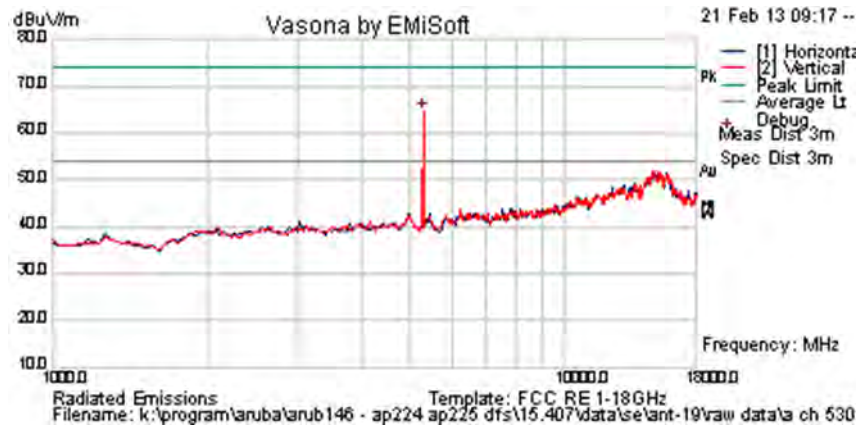

**Formally measured emission peaks**

Frequency MHz	Raw dBuV	Cable Loss	AF dB	Level dBuV/m	Measurement Type	PoI	Hgt cm	Azt Deg	Limit dBuV/m	Margin dB	Pass /Fail	Comments
5292.585	69.6	4.6	-9.6	64.6	Peak [Scan]	V	100					FUND

Legend:	TX = Transmitter Emissions; DIG = Digital Emissions; FUND = Fundamental; WB = Wideband Emission
	NRB = Non-Restricted Band. Limit = 68.23 dBuV/m; RB = Restricted Band. Limits per 15.205

This test report may be reproduced in full only. The document may only be updated by MiCOM Labs personnel. Any changes will be noted in the Document History section of the report.





**Title:** APIN0224, APIN0225 802.11a/b/g/n/ac  
**To:** FCC 47 CFR Part 15.407 & IC RSS-210  
**Serial #:** ARUB146-U1 Rev A  
**Issue Date:** 13th June 2013  
**Page:** 113 of 344

<b>Test Freq.</b>	5320 MHz	<b>Engineer</b>	SB
<b>Variant</b>	802.11a; 6 Mbs	<b>Temp (°C)</b>	19
<b>Freq. Range</b>	1000 MHz - 18000 MHz	<b>Rel. Hum.(%)</b>	34
<b>Power Setting</b>	18	<b>Press. (mBars)</b>	1003
<b>Antenna</b>	AP-ANT-19	<b>Duty Cycle (%)</b>	100
<b>Test Notes 1</b>	POE located outside the chamber with ferrite a clamp on cables.		
<b>Test Notes 2</b>			

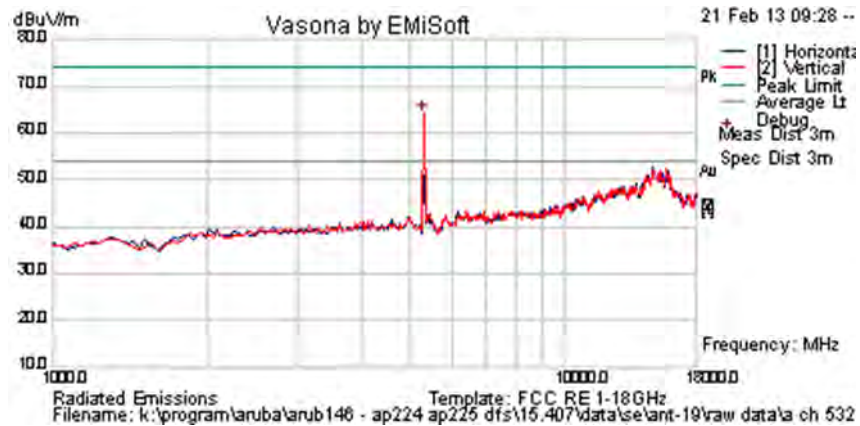

**Formally measured emission peaks**

Frequency MHz	Raw dBuV	Cable Loss	AF dB	Level dBuV/m	Measurement Type	PoI	Hgt cm	Azt Deg	Limit dBuV/m	Margin dB	Pass /Fail	Comments
5322.585	69.2	4.6	-9.6	64.2	Peak [Scan]	V	100					FUND

Legend:	TX = Transmitter Emissions; DIG = Digital Emissions; FUND = Fundamental; WB = Wideband Emission
	NRB = Non-Restricted Band. Limit = 68.23 dBuV/m; RB = Restricted Band. Limits per 15.205

This test report may be reproduced in full only. The document may only be updated by MiCOM Labs personnel. Any changes will be noted in the Document History section of the report.



**Title:** APIN0224, APIN0225 802.11a/b/g/n/ac  
**To:** FCC 47 CFR Part 15.407 & IC RSS-210  
**Serial #:** ARUB146-U1 Rev A  
**Issue Date:** 13th June 2013  
**Page:** 114 of 344

<b>Test Freq.</b>	5500 MHz	<b>Engineer</b>	SB
<b>Variant</b>	802.11a; 6 Mbs	<b>Temp (°C)</b>	19
<b>Freq. Range</b>	1000 MHz - 18000 MHz	<b>Rel. Hum.(%)</b>	34
<b>Power Setting</b>	18.0	<b>Press. (mBars)</b>	1003
<b>Antenna</b>	AP-ANT-19	<b>Duty Cycle (%)</b>	100
<b>Test Notes 1</b>	POE located outside the chamber with ferrite a clamp on cables.		
<b>Test Notes 2</b>			

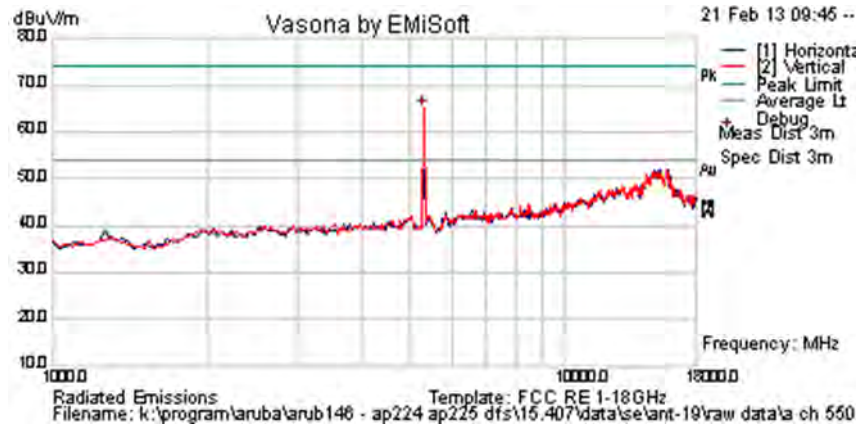

### Formally measured emission peaks

Frequency MHz	Raw dBuV	Cable Loss	AF dB	Level dBuV/m	Measurement Type	Pol	Hgt cm	Azt Deg	Limit dBuV/m	Margin dB	Pass /Fail	Comments
5502.585	70.1	4.6	-9.6	65.1	Peak [Scan]	V	100					FUND

Legend: TX = Transmitter Emissions; DIG = Digital Emissions; FUND = Fundamental; WB = Wideband Emission  
 NRB = Non-Restricted Band. Limit = 68.23 dBuV/m; RB = Restricted Band. Limits per 15.205

This test report may be reproduced in full only. The document may only be updated by MiCOM Labs personnel. Any changes will be noted in the Document History section of the report.



**Title:** APIN0224, APIN0225 802.11a/b/g/n/ac  
**To:** FCC 47 CFR Part 15.407 & IC RSS-210  
**Serial #:** ARUB146-U1 Rev A  
**Issue Date:** 13th June 2013  
**Page:** 115 of 344

<b>Test Freq.</b>	5580 MHz	<b>Engineer</b>	SB
<b>Variant</b>	802.11a; 6 Mbs	<b>Temp (°C)</b>	19
<b>Freq. Range</b>	1000 MHz - 18000 MHz	<b>Rel. Hum.(%)</b>	34
<b>Power Setting</b>	18.0	<b>Press. (mBars)</b>	1003
<b>Antenna</b>	AP-ANT-19	<b>Duty Cycle (%)</b>	100
<b>Test Notes 1</b>	POE located outside the chamber with ferrite a clamp on cables.		
<b>Test Notes 2</b>			

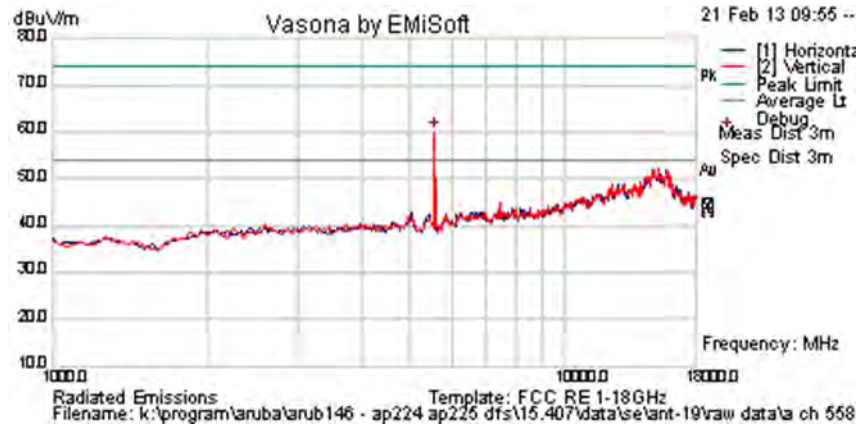

### Formally measured emission peaks

Frequency MHz	Raw dBuV	Cable Loss	AF dB	Level dBuV/m	Measurement Type	Pol	Hgt cm	Azt Deg	Limit dBuV/m	Margin dB	Pass /Fail	Comments
5565.130	65.1	4.7	-9.7	60.1	Peak [Scan]	V	100					FUND

Legend: TX = Transmitter Emissions; DIG = Digital Emissions; FUND = Fundamental; WB = Wideband Emission  
 NRB = Non-Restricted Band. Limit = 68.23 dBuV/m; RB = Restricted Band. Limits per 15.205

This test report may be reproduced in full only. The document may only be updated by MiCOM Labs personnel. Any changes will be noted in the Document History section of the report.



**Title:** APIN0224, APIN0225 802.11a/b/g/n/ac  
**To:** FCC 47 CFR Part 15.407 & IC RSS-210  
**Serial #:** ARUB146-U1 Rev A  
**Issue Date:** 13th June 2013  
**Page:** 116 of 344

<b>Test Freq.</b>	5700 MHz	<b>Engineer</b>	SB
<b>Variant</b>	802.11a; 6 Mbs	<b>Temp (°C)</b>	19
<b>Freq. Range</b>	1000 MHz - 18000 MHz	<b>Rel. Hum.(%)</b>	34
<b>Power Setting</b>	18.0	<b>Press. (mBars)</b>	1003
<b>Antenna</b>	AP-ANT-19	<b>Duty Cycle (%)</b>	100
<b>Test Notes 1</b>	POE located outside the chamber with ferrite a clamp on cables.		
<b>Test Notes 2</b>			

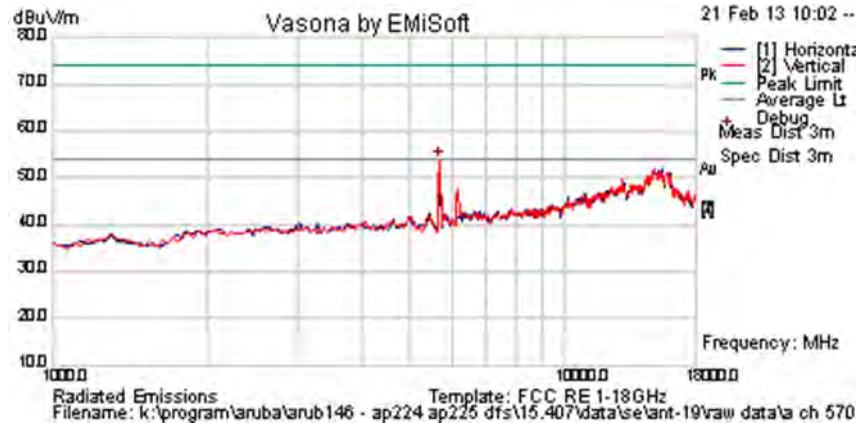

**Formally measured emission peaks**

Frequency MHz	Raw dBuV	Cable Loss	AF dB	Level dBuV/m	Measurement Type	Pol	Hgt cm	Azt Deg	Limit dBuV/m	Margin dB	Pass /Fail	Comments
5701.403	58.5	4.7	-9.6	53.6	Peak [Scan]	V	100					FUND
Legend: TX = Transmitter Emissions; DIG = Digital Emissions; FUND = Fundamental; WB = Wideband Emission NRB = Non-Restricted Band. Limit = 68.23 dBuV/m; RB = Restricted Band. Limits per 15.205												

This test report may be reproduced in full only. The document may only be updated by MiCOM Labs personnel. Any changes will be noted in the Document History section of the report.



### 6.1.2.7. Integral Antenna - Radiated Band-Edge

Peak Limit 74.0 dB $\mu$ V, Peak Limit 54.0 dB $\mu$ V

Operational Mode	5350 MHz		Power Setting
	dB $\mu$ V		
	Peak	Average	
a	68.72	52.12	18.0
n HT-20	66.51	52.15	18.0
n HT-40	63.05	45.20	14.0
ac-40	67.97	42.56	14.0
ac-80	62.72	46.15	12.0

Operational Mode	5460 MHz		
	Peak	Average	Power Setting
	a	64.02	50.73
n HT-20	61.42	50.73	18.0
n HT-40	58.88	44.30	14.0
ac-40	64.79	43.64	14.0
ac-80	61.28	45.30	12.0

This test report may be reproduced in full only. The document may only be updated by MiCOM Labs personnel. Any changes will be noted in the Document History section of the report.



### 6.1.2.8. ANT1B - Radiated Band-Edge

Peak Limit 74.0 dB $\mu$ V, Peak Limit 54.0 dB $\mu$ V

Operational Mode	5350 MHz		Power Setting
	dB $\mu$ V		
	Peak	Average	
a	67.98	52.37	18.0
n HT-20	69.04	52.52	18.0
n HT-40	64.39	45.81	14.0
ac-40	59.39	42.70	14.0
ac-80	62.26	46.78	12.0

Operational Mode	5460 MHz		
	Peak	Average	Power Setting
	a	61.47	50.24
n HT-20	60.81	50.36	18.0
n HT-40	59.21	44.45	14.0
ac-40	64.47	44.05	14.0
ac-80	64.00	45.99	18.0

This test report may be reproduced in full only. The document may only be updated by MiCOM Labs personnel. Any changes will be noted in the Document History section of the report.



### 6.1.2.9. ANT13B - Radiated Band-Edge

Peak Limit 74.0 dB $\mu$ V, Peak Limit 54.0 dB $\mu$ V

Operational Mode	5350 MHz		Power Setting
	dB $\mu$ V		
	Peak	Average	
a	64.90	48.19	18.0
n HT-20	63.48	48.17	18.0
n HT-40	56.44	38.79	14.0
ac-40	67.99	43.32	14.0
ac-80	61.61	44.16	12.0

Operational Mode	5460 MHz		
	Peak	Average	Power Setting
	a	60.39	46.36
n HT-20	60.51	46.30	18.0
n HT-40	55.08	37.93	14.0
ac-40	66.91	48.26	14.0
ac-80	65.41	49.99	12.0

This test report may be reproduced in full only. The document may only be updated by MiCOM Labs personnel. Any changes will be noted in the Document History section of the report.



### 6.1.2.10.ANT16 - Radiated Band-Edge

Peak Limit 74.0 dB $\mu$ V, Peak Limit 54.0 dB $\mu$ V

Operational Mode	5350 MHz		
	dB $\mu$ V		Power Setting
	Peak	Average	
a	63.68	48.48	18.0
n HT-20	63.19	48.42	18.0
n HT-40	67.61	43.55	14.0
ac-40	62.14	41.80	14.0
ac-80	58.25	41.81	12.0

Operational Mode	5460 MHz		
	Peak	Average	Power Setting
a	64.01	53.40	18.0
n HT-20	63.20	52.27	18.0
n HT-40	59.70	46.32	14.0
ac-40	65.21	44.02	14.0
ac-80	58.66	44.92	12.0

This test report may be reproduced in full only. The document may only be updated by MiCOM Labs personnel. Any changes will be noted in the Document History section of the report.





### 6.1.2.11.ANT18 - Radiated Band-Edge

Peak Limit 74.0 dB $\mu$ V, Peak Limit 54.0 dB $\mu$ V

Operational Mode	5350 MHz		
	dB $\mu$ V		Power Setting
	Peak	Average	
a	61.00	48.44	18.0
n HT-20	61.59	48.34	18.0
n HT-40	60.75	42.22	14.0
ac-40	67.12	45.31	14.0
ac-80	62.08	43.61	12.0

Operational Mode	5460 MHz		
	Peak	Average	Power Setting
a	64.46	41.08	18.0
n HT-20	52.48	39.08	18.0
n HT-40	52.63	38.20	14.0
ac-40	54.90	36.38	14.0
ac-80	54.43	37.82	12.0

This test report may be reproduced in full only. The document may only be updated by MiCOM Labs personnel. Any changes will be noted in the Document History section of the report.



### 6.1.2.12.ANT19 - Radiated Band-Edge

Peak Limit 74.0 dBµV, Peak Limit 54.0 dBµV

Operational Mode	5350 MHz		Power Setting
	dBµV		
	Peak	Average	
a	68.00	53.13	18.0
n HT-20	64.30	53.75	18.0
n HT-40	62.52	50.01	14.0
ac-40	69.73	47.43	14.0
ac-80	63.42	48.15	12.0

Operational Mode	5460 MHz		
	Peak	Average	Power Setting
	a	51.67	40.62
n HT-20	61.66	51.16	18.0
n HT-40	57.06	44.60	14.0
ac-40	63.56	42.52	14.0
ac-80	61.76	46.73	12.0

This test report may be reproduced in full only. The document may only be updated by MiCOM Labs personnel. Any changes will be noted in the Document History section of the report.



**Title:** APIN0224, APIN0225 802.11a/b/g/n/ac  
**To:** FCC 47 CFR Part 15.407 & IC RSS-210  
**Serial #:** ARUB146-U1 Rev A  
**Issue Date:** 13th June 2013  
**Page:** 123 of 344

### 6.1.2.13. Digital Emissions (30M-1 GHz)

**FCC, Part 15 Subpart C §15.205/ §15.209**  
**Industry Canada RSS-210 §2.2**

#### Test Procedure

Testing 30M-1 GHz was performed in a 3-meter anechoic chamber using a CISPR compliant receiver. Preliminary radiated emissions were measured on every azimuth and with the receiving antenna in both horizontal and vertical polarizations. To further maximize emissions the receive antenna was varied between 1 and 4 meters. The emissions are recorded with receiver in peak hold mode. Emissions closest to the limits are measured in the quasi-peak mode with the tuned receiver using a bandwidth of 120 kHz. Only the highest emissions relative to the limit are listed. The anechoic chamber test set-up is identified in Section 6 Test Set-Up Photographs.

The EUT had two methods of powering on ac/dc converter and Power over Ethernet (POE). Both modes were tested for emissions below 1GHz.

#### Field Strength Calculation

The field strength is calculated by adding the Antenna Factor and Cable Loss, and subtracting Amplifier Gain from the measured reading. In this test facility, the Antenna Factor, Cable Loss, and Amplifier Gains are loaded into the Rohde & Schwarz Receiver and the corrected field strength can be read directly on the receiver.

$$FS = R + AF + CORR$$

where:

FS = Field Strength  
R = Measured Receiver Input Amplitude  
AF = Antenna Factor  
CORR = Correction Factor = CL – AG + NFL  
CL = Cable Loss  
AG = Amplifier Gain

For example:

Given a Receiver input reading of 51.5dB $\mu$ V; Antenna Factor of 8.5dB; Cable Loss of 1.3dB; Falloff Factor of 0dB, an Amplifier Gain of 26dB and Notch Filter Loss of 1dB. The Field Strength of the measured emission is:

$$FS = 51.5 + 8.5 + 1.3 - 26.0 + 1 = 36.3\text{dB}\mu\text{V/m}$$

Conversion between dB $\mu$ V/m (or dB $\mu$ V) and  $\mu$ V/m (or  $\mu$ V) are done as:

$$\text{Level (dB}\mu\text{V/m)} = 20 * \text{Log (level (\mu\text{V/m}))}$$

$$40 \text{ dB}\mu\text{V/m} = 100\mu\text{V/m}$$

$$48 \text{ dB}\mu\text{V/m} = 250\mu\text{V/m}$$

This test report may be reproduced in full only. The document may only be updated by MiCOM Labs personnel. Any changes will be noted in the Document History section of the report.



**Title:** APIN0224, APIN0225 802.11a/b/g/n/ac  
**To:** FCC 47 CFR Part 15.407 & IC RSS-210  
**Serial #:** ARUB146-U1 Rev A  
**Issue Date:** 13th June 2013  
**Page:** 124 of 344

<b>Test Freq.</b>	2437 MHz	<b>Engineer</b>	SB
<b>Variant</b>	Digital Emissions	<b>Temp (°C)</b>	19.5
<b>Freq. Range</b>	30 MHz - 1000 MHz	<b>Rel. Hum.(%)</b>	34
<b>Power Setting</b>	18	<b>Press. (mBars)</b>	1001
<b>Antenna</b>	Integral		
<b>Test Notes 1</b>	Eut: Position Horizontal; S/N::C-84 Only		
<b>Test Notes 2</b>	PSU: POE (support equipment not in chamber ferrite clamp on cables)		

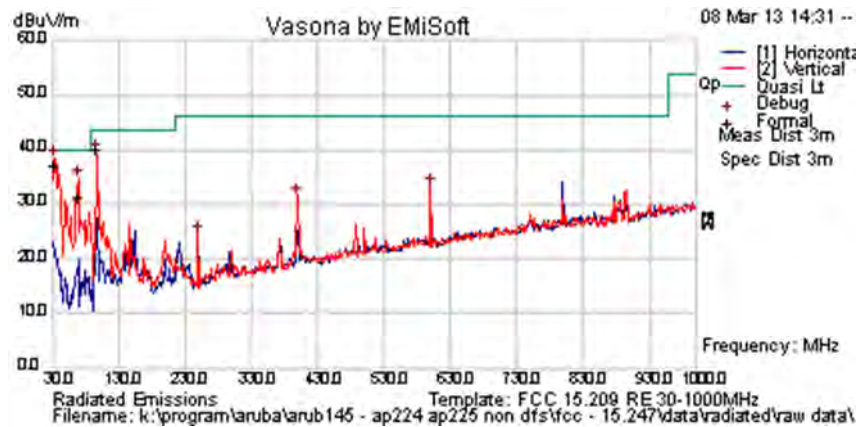

### Formally measured emission peaks

Frequency MHz	Raw dBuV	Cable Loss	AF dB	Level dBuV/m	Measurement Type	Pol	Hgt cm	Azt Deg	Limit dBuV/m	Margin dB	Pass /Fail	Comments
34.088	46.4	3.6	-13.0	37.0	Quasi Max	V	102	208	40	-3.0	Pass	
98.040	57.9	4.1	-21.8	40.1	Quasi Max	V	117	88	43.5	-3.4	Pass	
68.990	50.5	3.9	-23.2	31.2	Quasi Max	V	155	304	40	-8.8	Pass	
399.240	40.7	5.5	-14.8	31.4	Peak [Scan]	V	155	304	46	-14.6	Pass	
599.681	38.6	6.2	-11.6	33.2	Peak [Scan]	V	155	304	46	-12.8	Pass	
249.879	38.6	4.9	-19.0	24.5	Peak [Scan]	H	155	304	46	-21.5	Pass	

**Legend:** DIG = Digital Device Emission; TX = Transmitter Emission; FUND = Fundamental Frequency  
 NRB = Non-Restricted Band, Limit is 20 dB below Fundamental; RB = Restricted Band

This test report may be reproduced in full only. The document may only be updated by MiCOM Labs personnel. Any changes will be noted in the Document History section of the report.



**Title:** APIN0224, APIN0225 802.11a/b/g/n/ac  
**To:** FCC 47 CFR Part 15.407 & IC RSS-210  
**Serial #:** ARUB146-U1 Rev A  
**Issue Date:** 13th June 2013  
**Page:** 125 of 344

<b>Test Freq.</b>	2437 MHz	<b>Engineer</b>	SB
<b>Variant</b>	Digital Emissions	<b>Temp (°C)</b>	19.5
<b>Freq. Range</b>	30 MHz - 1000 MHz	<b>Rel. Hum.(%)</b>	34
<b>Power Setting</b>	18	<b>Press. (mBars)</b>	1001
<b>Antenna</b>	Integral		
<b>Test Notes 1</b>	Eut: Position Vertical; S/N::C-84 Only		
<b>Test Notes 2</b>	PSU: POE (support equipment not in chamber ferrite clamp on cables)		

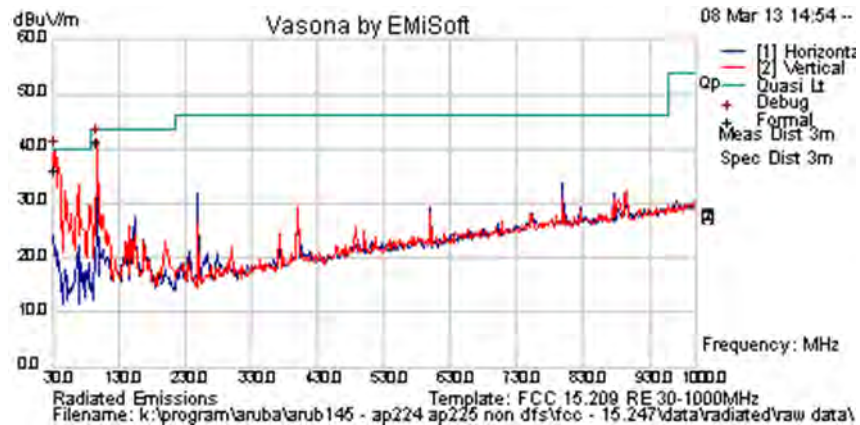

### Formally measured emission peaks

Frequency MHz	Raw dBuV	Cable Loss	AF dB	Level dBuV/m	Measurement Type	Pol	Hgt cm	Azt Deg	Limit dBuV/m	Margin dB	Pass /Fail	Comments
34.092	45.5	3.6	-13.0	36.1	Quasi Max	V	117	116	40	-3.9	Pass	
98.125	58.9	4.1	-21.8	41.2	Quasi Max	V	109	360	43.5	-2.3	Pass	
154.412	42.0	4.4	-18.9	27.5	Peak [Scan]	H	108	360	43.5	-16.0	Pass	
249.466	44.5	4.9	-19.0	30.4	Peak [Scan]	H	108	360	46	-15.6	Pass	
399.553	37.1	5.5	-14.8	27.8	Peak [Scan]	V	108	360	46	-18.2	Pass	
278.716	33.2	5.0	-17.4	20.8	Peak [Scan]	H	108	360	46	-25.2	Pass	

**Legend:** DIG = Digital Device Emission; TX = Transmitter Emission; FUND = Fundamental Frequency  
 NRB = Non-Restricted Band, Limit is 20 dB below Fundamental; RB = Restricted Band

This test report may be reproduced in full only. The document may only be updated by MiCOM Labs personnel. Any changes will be noted in the Document History section of the report.



**Title:** APIN0224, APIN0225 802.11a/b/g/n/ac  
**To:** FCC 47 CFR Part 15.407 & IC RSS-210  
**Serial #:** ARUB146-U1 Rev A  
**Issue Date:** 13th June 2013  
**Page:** 126 of 344

<b>Test Freq.</b>	2437 MHz	<b>Engineer</b>	SB
<b>Variant</b>	Digital Emissions	<b>Temp (°C)</b>	19.5
<b>Freq. Range</b>	30 MHz - 1000 MHz	<b>Rel. Hum.(%)</b>	34
<b>Power Setting</b>	18	<b>Press. (mBars)</b>	1001
<b>Antenna</b>	Integral		
<b>Test Notes 1</b>	Eut: Position Vertical; S/N::C-84 Only		
<b>Test Notes 2</b>	PSU: AC/DC 110VAC		

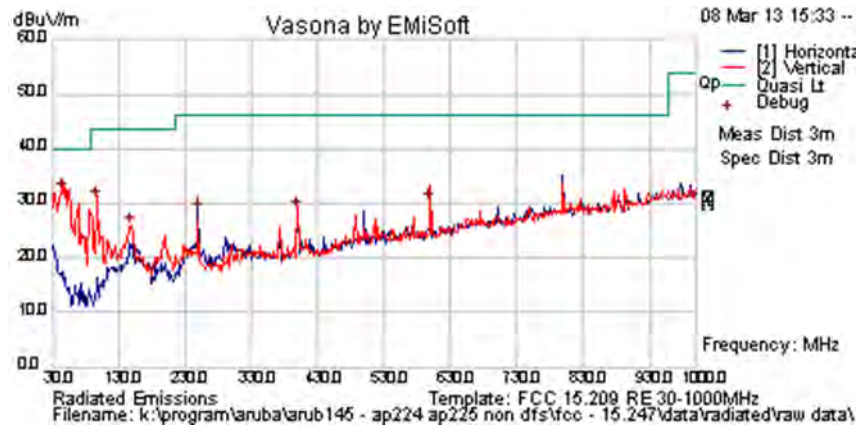

### Formally measured emission peaks

Frequency MHz	Raw dBuV	Cable Loss	AF dB	Level dBuV/m	Measurement Type	Pol	Hgt cm	Azt Deg	Limit dBuV/m	Margin dB	Pass /Fail	Comments
46.005	49.9	3.7	-21.5	32.2	Peak [Scan]	V	98	360	40	-7.8	Pass	
399.570	37.9	5.5	-14.8	28.6	Peak [Scan]	V	98	360	46	-17.4	Pass	
598.905	35.7	6.2	-11.6	30.4	Peak [Scan]	V	98	360	46	-15.7	Pass	
148.825	40.2	4.4	-18.8	25.8	Peak [Scan]	V	98	360	43.5	-17.7	Pass	
97.415	48.5	4.1	-22.0	30.6	Peak [Scan]	V	98	360	43.5	-12.9	Pass	
250.089	42.6	4.9	-19.0	28.5	Peak [Scan]	H	98	360	46	-17.6	Pass	

**Legend:** DIG = Digital Device Emission; TX = Transmitter Emission; FUND = Fundamental Frequency  
 NRB = Non-Restricted Band, Limit is 20 dB below Fundamental; RB = Restricted Band

This test report may be reproduced in full only. The document may only be updated by MiCOM Labs personnel. Any changes will be noted in the Document History section of the report.



**Title:** APIN0224, APIN0225 802.11a/b/g/n/ac  
**To:** FCC 47 CFR Part 15.407 & IC RSS-210  
**Serial #:** ARUB146-U1 Rev A  
**Issue Date:** 13th June 2013  
**Page:** 127 of 344

<b>Test Freq.</b>	2437 MHz	<b>Engineer</b>	SB
<b>Variant</b>	Digital Emissions	<b>Temp (°C)</b>	19.5
<b>Freq. Range</b>	30 MHz - 1000 MHz	<b>Rel. Hum.(%)</b>	34
<b>Power Setting</b>	18	<b>Press. (mBars)</b>	1001
<b>Antenna</b>	Integral		
<b>Test Notes 1</b>	Eut: Position Horizontal; S/N::C-84 Only		
<b>Test Notes 2</b>	PSU: AC/DC 110VAC		

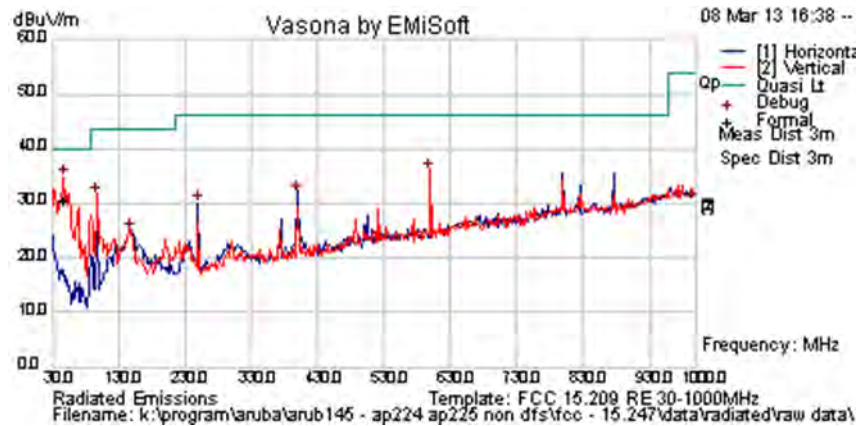

### Formally measured emission peaks

Frequency MHz	Raw dBuV	Cable Loss	AF dB	Level dBuV/m	Measurement Type	Pol	Hgt cm	Azt Deg	Limit dBuV/m	Margin dB	Pass /Fail	Comments
48.456	49.3	3.7	-22.6	30.4	Quasi Max	V	113	143	40	-9.6	Pass	
97.569	49.1	4.1	-22.0	31.2	Peak [Scan]	V	98	360	43.5	-12.3	Pass	
599.443	40.9	6.2	-11.6	35.5	Peak [Scan]	V	98	360	46	-10.5	Pass	
148.825	38.9	4.4	-18.8	24.5	Peak [Scan]	V	98	360	43.5	-19.0	Pass	
249.652	43.9	4.9	-19.0	29.8	Peak [Scan]	H	98	360	46	-16.2	Pass	
399.147	40.9	5.5	-14.8	31.6	Peak [Scan]	H	98	360	46	-14.4	Pass	

**Legend:** DIG = Digital Device Emission; TX = Transmitter Emission; FUND = Fundamental Frequency  
 NRB = Non-Restricted Band, Limit is 20 dB below Fundamental; RB = Restricted Band

This test report may be reproduced in full only. The document may only be updated by MiCOM Labs personnel. Any changes will be noted in the Document History section of the report.



## Specification

### Limits

**§15.205 (a)** Except as shown in paragraph (d) of 15.205 (a), only spurious emissions are permitted in any of the frequency bands listed.

**§15.205 (a)** Except as shown in paragraphs (d) and (e) of this section, the field strength of emissions appearing within these frequency bands shall not exceed the limits shown in Section §15.209. At frequencies equal to or less than 1000 MHz, compliance with the limits in Section 15.209 shall be demonstrated using measurement instrumentation employing a CISPR quasi-peak detector. Above 1000 MHz, compliance with the emission limits in Section 15.209 shall be demonstrated based on the average value of the measured emissions. The provisions in Section 15.35 apply to these measurements.

**§15.209 (a)** Except as provided elsewhere in this subpart, the emissions from an intentional radiator shall not exceed the field strength levels specified in the following table.

### §15.209 (a) and RSS-Gen §2.2 Limit Matrix

Frequency(MHz)	Field Strength (µV/m)	Field Strength (dBµV/m)	Measurement Distance (meters)
30-88	100	40.0	3
88-216	150	43.5	3
216-960	200	46.0	3
Above 960	500	54.0	3

### Laboratory Measurement Uncertainty for Radiated Emissions

Measurement uncertainty	+5.6/ -4.5 dB
-------------------------	---------------

### Traceability

Method	Test Equipment Used
Measurements were made per work instruction WI-03 'Measurement of Radiated Emissions'	0088, 0158, 0134, 0304, 0311, 0315, 0310, 0312

This test report may be reproduced in full only. The document may only be updated by MiCOM Labs personnel. Any changes will be noted in the Document History section of the report.



### 6.1.3. AC Wireline Conducted Emissions (150 kHz – 30 MHz)

**FCC, Part 15 Subpart C §15.207**  
**Industry Canada RSS-Gen §7.2.2**

#### **Test Procedure**

The EUT is configured in accordance with ANSI C63.4. The conducted emissions are measured in a shielded room with a spectrum analyzer in peak hold in the first instance. Emissions closest to the limit are measured in the quasi-peak mode (QP) with the tuned receiver using a bandwidth of 9 kHz. The emissions are maximized further by cable manipulation. The highest emissions relative to the limit are listed.

#### **Measurement Results for AC Wireline Conducted Emissions (150 kHz – 30 MHz)**

Ambient conditions.

Temperature: 17 to 23 °C    Relative humidity: 31 to 57 %    Pressure: 999 to 1012 mbar

#### **Test Measurement Set up**

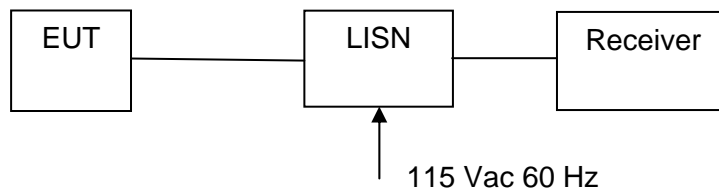

Measurement set up for AC Wireline Conducted Emissions Test

#### **Measurement Results for AC Wireline Conducted Emissions (150 kHz – 30 MHz)**

Ambient conditions.

Temperature: 17 to 23 °C    Relative humidity: 31 to 57 %    Pressure: 999 to 1012 mbar



**Title:** APIN0224, APIN0225 802.11a/b/g/n/ac  
**To:** FCC 47 CFR Part 15.407 & IC RSS-210  
**Serial #:** ARUB146-U1 Rev A  
**Issue Date:** 13th June 2013  
**Page:** 130 of 344

**ac/dc Adaptor**

<b>Test Freq.</b>	N/A	<b>Engineer</b>	SB
<b>Variant</b>	AC Line Emissions	<b>Temp (°C)</b>	20
<b>Freq. Range</b>	0.150 MHz - 30 MHz	<b>Rel. Hum.(%)</b>	32
<b>Power Setting</b>	18	<b>Press. (mBars)</b>	1011
<b>Antenna</b>	Integral		
<b>Test Notes 1</b>	Eut: Position Horizontal; S/N;;C-84 Only		
<b>Test Notes 2</b>	PSU: AC/DC 110VAC		

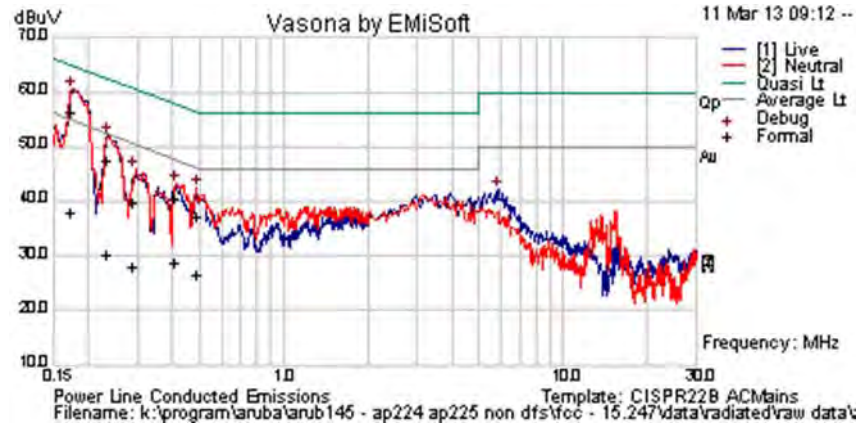

**Formally measured emission peaks**

Frequency MHz	Raw dBuV	Cable Loss	Factors dB	Level dBuV	Measurement Type	Line	Limit dBuV	Margin dB	Pass /Fail	Comments
0.174	46.4	9.9	0.1	56.4	Quasi Peak	Live	64.77	-8.4	Pass	
0.236	37.6	9.9	0.1	47.6	Quasi Peak	Live	62.24	-14.7	Pass	
0.489	27.4	9.9	0.1	37.4	Quasi Peak	Neutral	56.18	-18.8	Pass	
0.414	30.4	9.9	0.1	40.4	Quasi Peak	Neutral	57.57	-17.2	Pass	
0.291	29.9	9.9	0.1	39.9	Quasi Peak	Neutral	60.5	-20.6	Pass	
0.174	28.1	9.9	0.1	38.1	Average	Live	54.77	-16.7	Pass	
0.236	20.4	9.9	0.1	30.3	Average	Live	52.24	-21.9	Pass	
0.489	16.7	9.9	0.1	26.7	Average	Neutral	46.18	-19.5	Pass	
0.414	18.8	9.9	0.1	28.8	Average	Neutral	47.57	-18.8	Pass	
0.291	18.0	9.9	0.1	28.0	Average	Neutral	50.5	-22.5	Pass	
5.882	31.4	10.2	0.3	41.9	Peak [Scan]	Live	50	-8.1	Pass	

Legend: DIG = Digital Device Emission; TX = Transmitter Emission; FUND = Fundamental Frequency  
 NRB = Non-Restricted Band, Limit is 20 dB below Fundamental; RB = Restricted Band

This test report may be reproduced in full only. The document may only be updated by MiCOM Labs personnel. Any changes will be noted in the Document History section of the report.



## Specification

### Limit

**§15.207 (a)** Except as shown in paragraphs (b) and (c) of this section, for an intentional radiator that is designed to be connected to the public utility (AC) power line, the radio frequency voltage that is conducted back onto the AC power line on any frequency or frequencies within the band 150 kHz to 30 MHz shall not exceed the limits in the following table, as measured using a 50  $\mu\Omega$  line impedance stabilization network (LISN), see §15.207 (a) matrix below. Compliance with the provisions of this paragraph shall be based on the measurement of the radio frequency voltage between each power line and ground at the power terminal.

### RSS-Gen §7.2.2

The radio frequency voltage that is conducted back into the AC power lines in the frequency range of 0.15 MHz to 30 MHz shall not exceed the limits shown in the table below. The tighter limit applies at the frequency range boundaries.

### §15.207 (a) and RSS-Gen §7.2.2 Limit Matrix

The lower limit applies at the boundary between frequency ranges

Frequency of Emission (MHz)	Conducted Limit (dB $\mu$ V)	
	Quasi-peak	Average
0.15-0.5	66 to 56*	56 to 46*
0.5-5	56	46
5-30	60	50

\* Decreases with the logarithm of the frequency

### Laboratory Measurement Uncertainty for Conducted Emissions

Measurement uncertainty	$\pm 2.64$ dB
-------------------------	---------------

### Traceability

Method	Test Equipment Used
Measurements were made per work instruction WI-EMC-01 'Measurement of Conducted Emissions'	0158, 0184, 0287, 0190, 0293, 0307

This test report may be reproduced in full only. The document may only be updated by MiCOM Labs personnel. Any changes will be noted in the Document History section of the report.



#### 6.1.4. Dynamic Frequency Selection (DFS)

**FCC, Part 15 Subpart C §15.407(h)**  
**FCC 06-96 Memorandum Opinion and Order**  
**Industry Canada RSS-210 A9.4**

##### 6.1.4.1. Interference Threshold values, Master or Client incorporating In-Service Monitoring

Maximum Transmit Power	Value (see note)
≥ 200 milliwatt	-64 dBm
< 200 milliwatt	-62 dBm
Note 1: This is the level at the input of the receiver assuming a 0 dBi receive antenna	

##### DFS Response requirement values

Parameter	Value
<i>Non-occupancy period</i>	Minimum 30 minutes
<i>Channel Availability Check Time</i>	60 seconds
<i>Channel Move Time</i>	10 seconds See Note 1.
<i>Channel Closing Transmission Time</i>	200 milliseconds + an aggregate of 60 milliseconds over remaining 10 second period. See Notes 1 and 2.
<i>U-NII Detection Bandwidth</i>	Minimum 80% of the 99% power bandwidth See Note 3.

Note 1: The instant that the *Channel Move Time* and the *Channel Closing Transmission Time* begins is as follows:

- For the Short pulse radar Test Signals this instant is the end of the *Burst*.
- For the Frequency Hopping radar Test Signal, this instant is the end of the last radar *Burst* generated.
- For the Long Pulse radar Test Signal this instant is the end of the 12 second period defining the radar transmission.

Note 2: The *Channel Closing Transmission Time* is comprised of 200 milliseconds starting at the beginning of the *Channel Move Time* plus any additional intermittent control signals required to facilitate *Channel* changes (an aggregate of 60 milliseconds) during the remainder of the 10 second period. The aggregate duration of control signals will not count quiet periods in between transmissions.

Note 3: During the *U-NII Detection Bandwidth* detection test, radar type 1 is used and for each frequency step the minimum percentage of detection is 90%. Measurements are performed with no data traffic.



#### 6.1.4.2. Radar Test Waveforms

This section provides the parameters for required test waveforms, minimum percentage of successful detections, and the minimum number of trials that must be used for determining DFS conformance. Step intervals of 0.1 microsecond for Pulse Width, 1 microsecond for PRI, 1 MHz for chirp width and 1 for the number of pulses will be utilized for the random determination of specific test waveforms.

##### Short Pulse Radar Test Waveforms

Radar Type	Pulse Width (µsec)	PRI (µsec)	Number of Pulses	Minimum Percentage of Successful Detection	Minimum Trials
1	1	1428	18	60%	30
2	1-5	150-230	23-29	60%	30
3	6-10	200-500	16-18	60%	30
4	11-20	200-500	12-16	60%	30
Aggregate (Radar Types 1-4)				80%	120

A minimum of 30 unique waveforms are required for each of the short pulse radar types 2 through 4. For short pulse radar type 1, the same waveform is used a minimum of 30 times. If more than 30 waveforms are used for short pulse radar types 2 through 4, then each additional waveform must also be unique and not repeated from the previous waveforms. The aggregate is the average of the percentage of successful detections of short pulse radar types 1-4.

##### Long Pulse Radar Test Waveform

Radar Type	Pulse Width (µsec)	Chirp Width (MHz)	PRI (µsec)	Number of Pulses per Burst	Number of Bursts	Minimum Percentage of Successful Detection	Minimum Trials
5	50-100	5-20	1000-2000	1-3	8-20	80%	30

The parameters for this waveform are randomly chosen. Thirty unique waveforms are required for the Long Pulse radar test signal. If more than 30 waveforms are used for the Long Pulse radar test signal, then each additional waveform must also be unique and not repeated from the previous waveforms.



**Title:** APIN0224, APIN0225 802.11a/b/g/n/ac  
**To:** FCC 47 CFR Part 15.407 & IC RSS-210  
**Serial #:** ARUB146-U1 Rev A  
**Issue Date:** 13th June 2013  
**Page:** 134 of 344

---

Each waveform is defined as follows:

- 1) The transmission period for the Long Pulse Radar test signal is 12 seconds.
- 2) There are a total of 8 to 20 *Bursts* in the 12 second period, with the number of *Bursts* being randomly chosen. This number is *Burst Count*.
- 3) Each *Burst* consists of 1 to 3 pulses, with the number of pulses being randomly chosen. Each *Burst* within the 12 second sequence may have a different number of pulses.
- 4) The pulse width is between 50 and 100 microseconds, with the pulse width being randomly chosen. Each pulse within a *Burst* will have the same pulse width. Pulses in different *Bursts* may have different pulse widths.
- 5) Each pulse has a linear FM chirp between 5 and 20 MHz, with the chirp width being randomly chosen. Each pulse within a *Burst* will have the same chirp width. Pulses in different *Bursts* may have different chirp widths. The chirp is centered on the pulse. For example, with a radar frequency of 5300 MHz and a 20 MHz chirped signal, the chirp starts at 5290 MHz and ends at 5310 MHz.
- 6) If more than one pulse is present in a *Burst*, the time between the pulses will be between 1000 and 2000 microseconds, with the time being randomly chosen. If three pulses are present in a *Burst*, the time between the first and second pulses is chosen independently of the time between the second and third pulses.
- 7) The 12 second transmission period is divided into even intervals. The number of intervals is equal to *Burst\_Count*. Each interval is of length  $(12,000,000 / \textit{Burst\_Count})$  microseconds. Each interval contains one *Burst*. The start time for the *Burst*, relative to the beginning of the interval, is between 1 and  $[(12,000,000 / \textit{Burst\_Count}) - (\textit{Total Burst Length}) + (\textit{One Random PRI Interval})]$  microseconds, with the start time being randomly chosen. The step interval for the start time is 1 microsecond. The start time for each *Burst* is chosen independently.

---

This test report may be reproduced in full only. The document may only be updated by MiCOM Labs personnel. Any changes will be noted in the Document History section of the report.

**A representative example of a Long Pulse radar test waveform:**

- 1) The total test signal length is 12 seconds.
- 2) 8 *Bursts* are randomly generated for the *Burst\_Count*.
- 3) *Burst 1* has 2 randomly generated pulses.
- 4) The pulse width (for both pulses) is randomly selected to be 75 microseconds.
- 5) The PRI is randomly selected to be at 1213 microseconds.
- 6) *Bursts 2* through 8 are generated using steps 3 – 5.
- 7) Each *Burst* is contained in even intervals of 1,500,000 microseconds. The starting location for Pulse 1, *Burst 1* is randomly generated (1 to 1,500,000 minus the total *Burst 1* length + 1 random PRI interval) at the 325,001 microsecond step. *Bursts 2* through 8 randomly fall in successive 1,500,000 microsecond intervals (i.e. *Burst 2* falls in the 1,500,001 – 3,000,000 microsecond range).

**Graphical representation of the Long Pulse radar Test Waveform.**

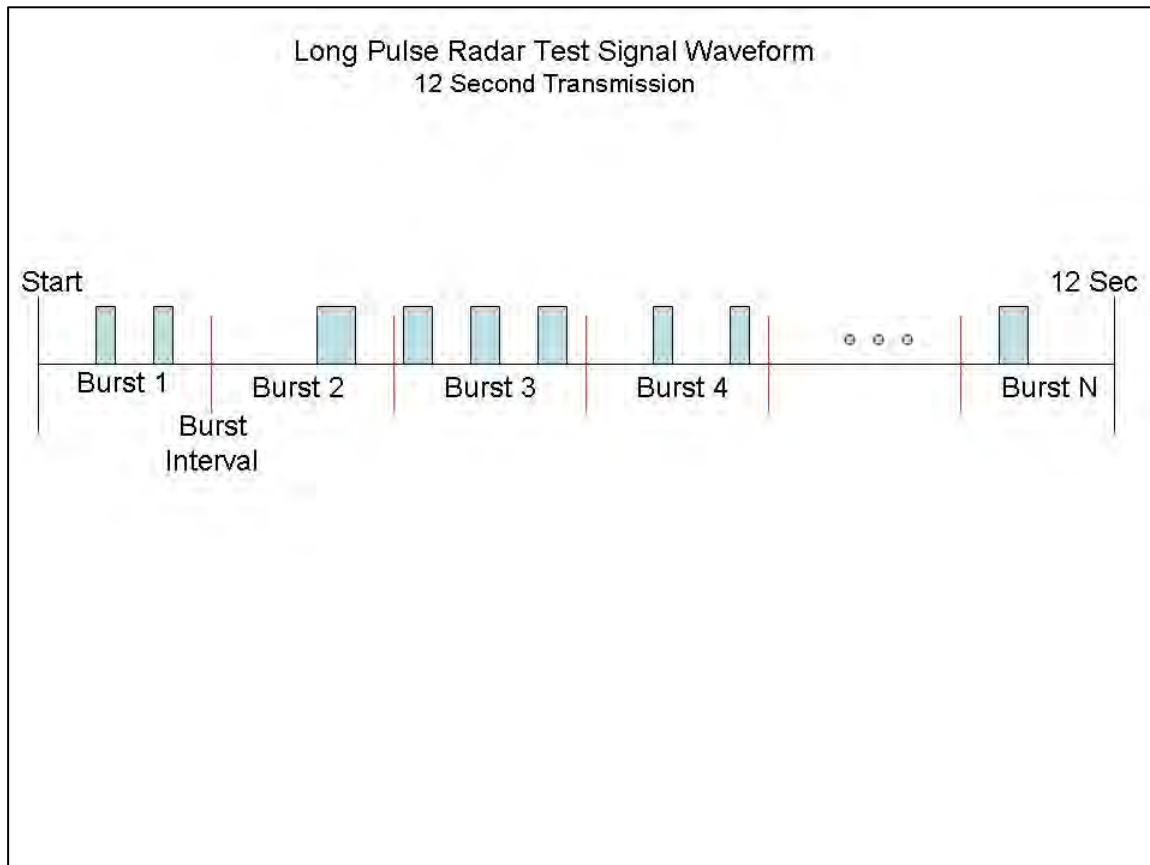

This test report may be reproduced in full only. The document may only be updated by MiCOM Labs personnel. Any changes will be noted in the Document History section of the report.

### 6.1.4.3. Frequency Hopping Radar Test Waveform

**Frequency Hopping Radar Test Waveform**

Radar Type	Pulse Width (μsec)	PRI (μsec)	Pulses per Hop	Hopping Rate (kHz)	Hopping Sequence Length (msec)	Minimum Percentage of Successful Detection	Minimum Trials
6	1	333	9	.333	300	70%	30

For the Frequency Hopping Radar Type, the same *Burst* parameters are used for each waveform. The hopping sequence is different for each waveform and a 100-length segment is selected from the hopping sequence defined by the following algorithm:

### 6.1.4.4. Radar Waveform Calibration

The following equipment setup was used to calibrate the conducted Radar Waveform. A spectrum analyzer was used to establish the test signal level for each radar type. During this process there were no transmissions by either the Master or Client Device. The spectrum analyzer was switched to the zero span (Time Domain) mode at the frequency of the Radar Waveform generator. Peak detection was utilized. The spectrum analyzer resolution bandwidth (RBW) and video bandwidth (VBW) were set to 3 MHz.

The signal generator amplitude was set so that the power level measured at the spectrum analyzer was -61dBm (Ref Section 5.1). The 30dB amplifier gain was entered as an amplitude offset on the spectrum analyzer.

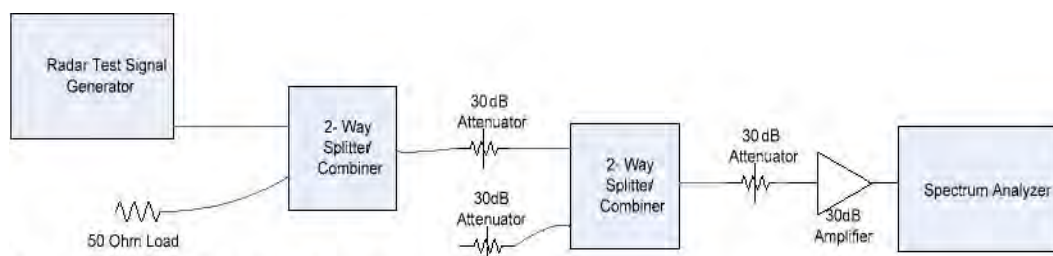

**Conducted Calibration Setup**





### 6.1.4.5. Weather Radar Band Edge Plots

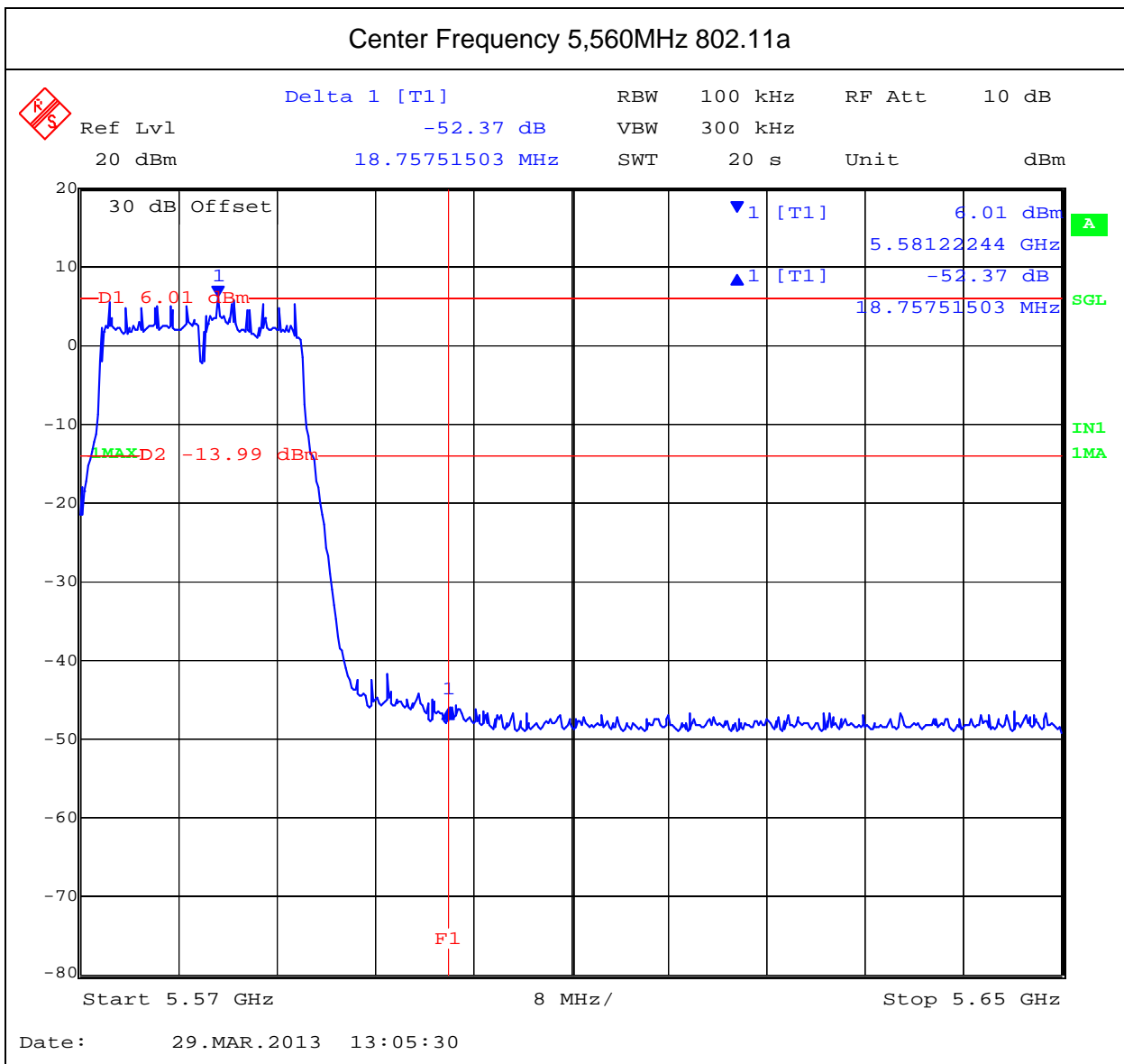

This test report may be reproduced in full only. The document may only be updated by MiCOM Labs personnel. Any changes will be noted in the Document History section of the report.



Center Frequency 5,550MHz 802.11n HT40

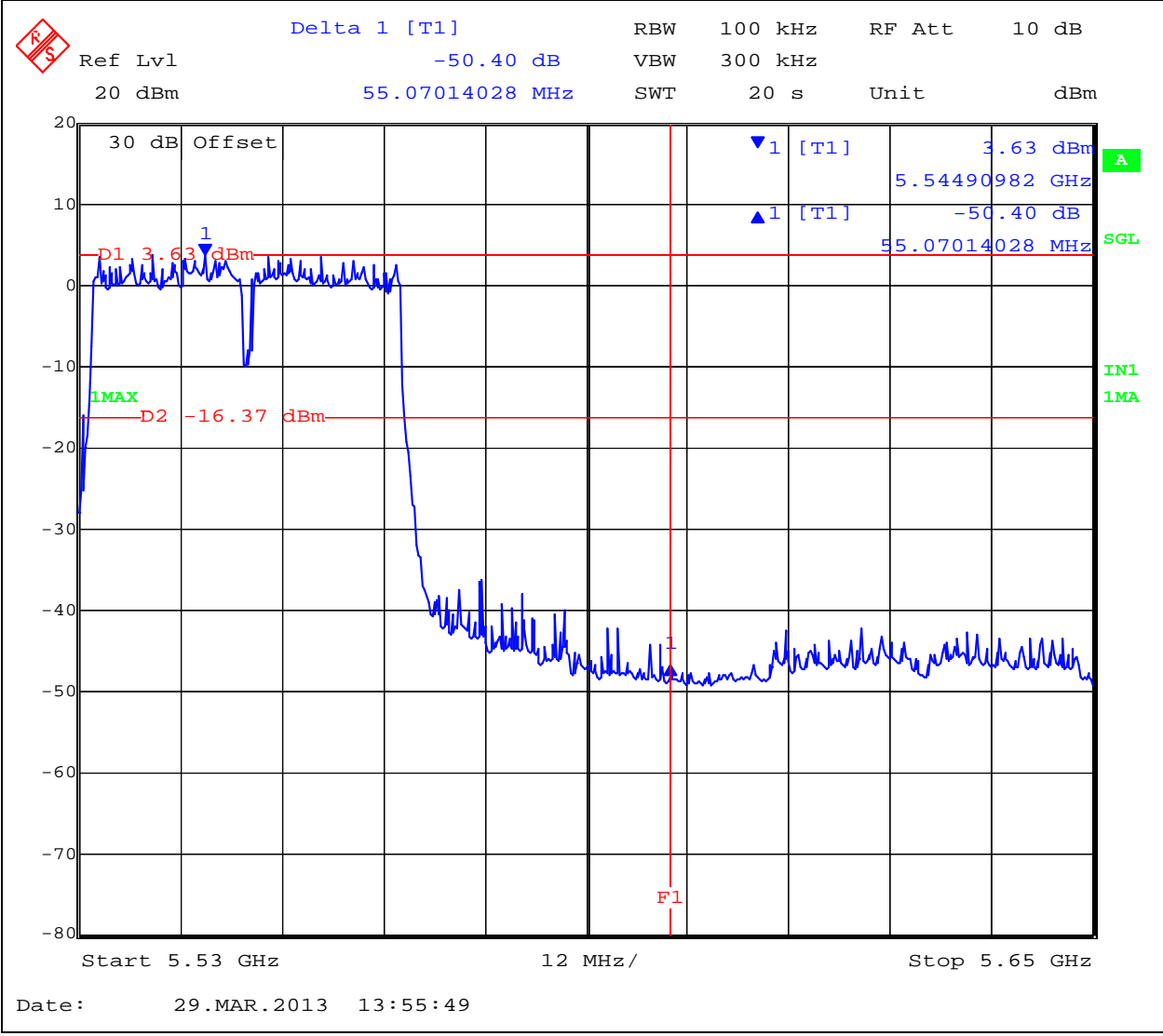

This test report may be reproduced in full only. The document may only be updated by MiCOM Labs personnel. Any changes will be noted in the Document History section of the report.

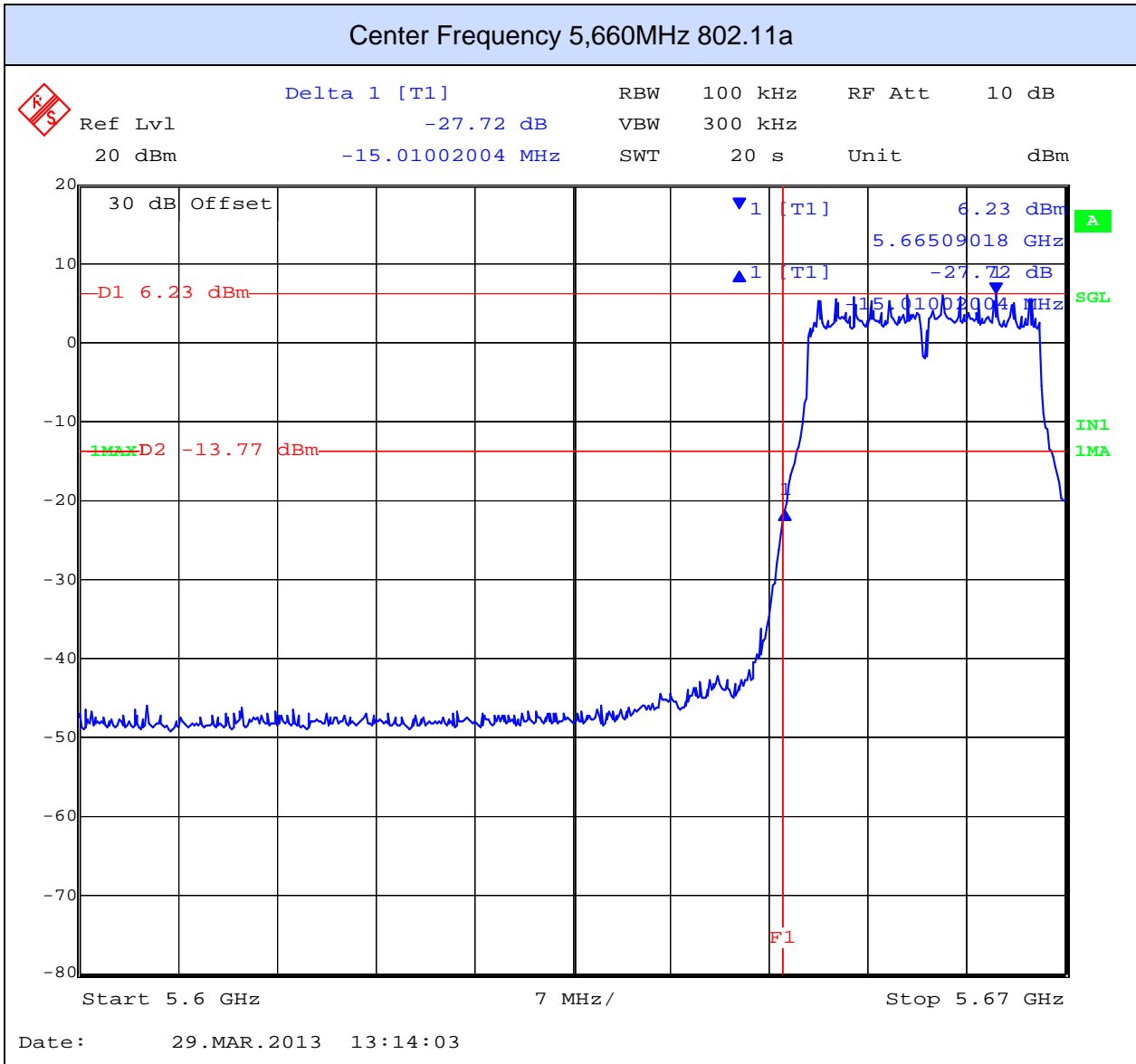

This test report may be reproduced in full only. The document may only be updated by MiCOM Labs personnel. Any changes will be noted in the Document History section of the report.

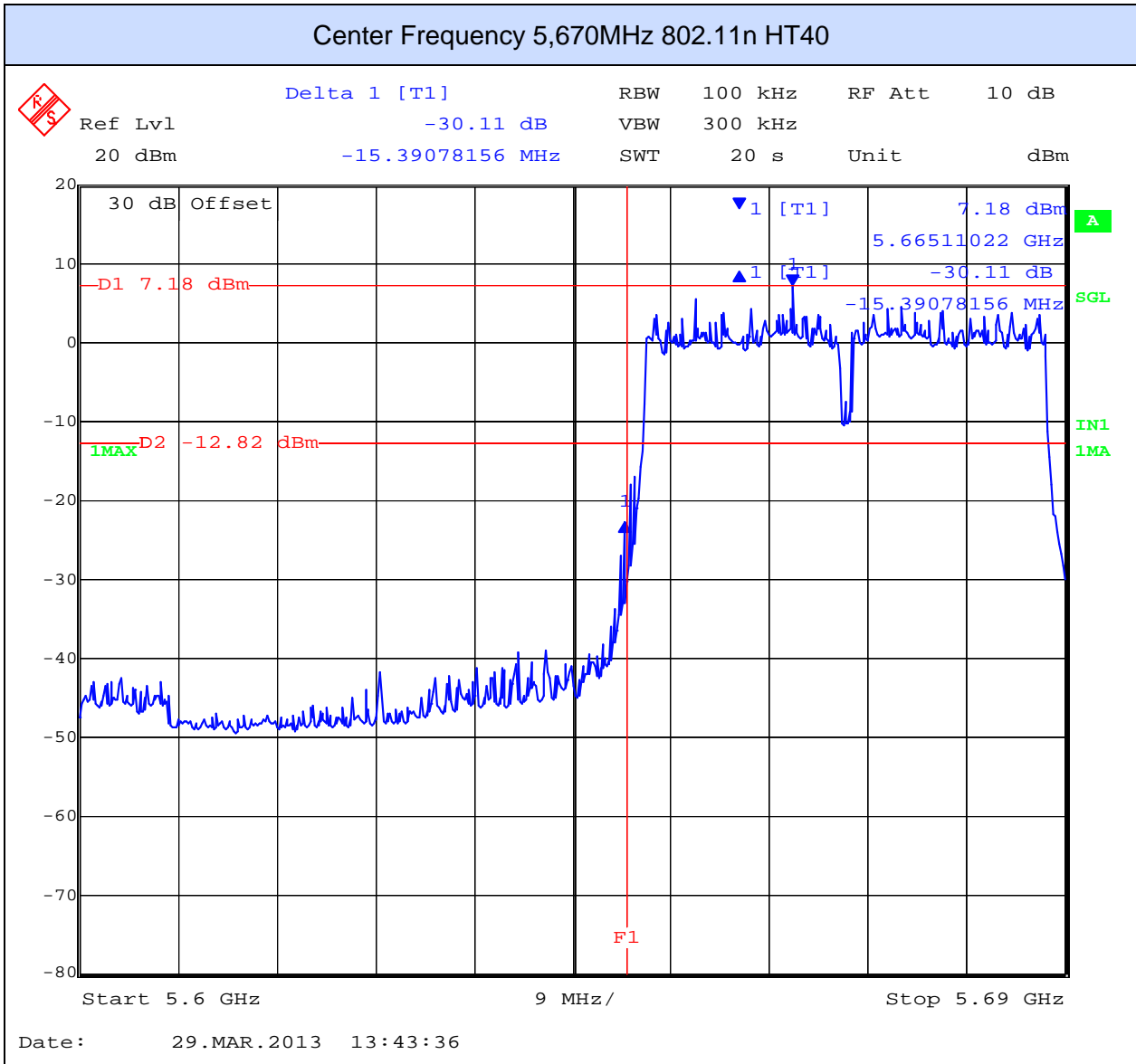

This test report may be reproduced in full only. The document may only be updated by MiCOM Labs personnel. Any changes will be noted in the Document History section of the report.

### 6.1.4.6. DFS Test Results

Setup for Conducted Measurements where the EUT is the Master with injection of Radar Test Waveforms at the Master.

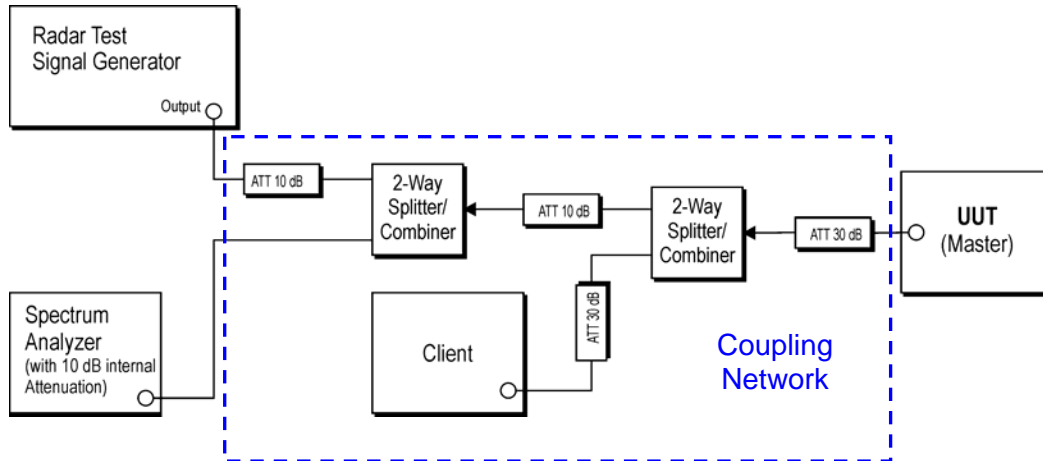

### Support Equipment Configuration

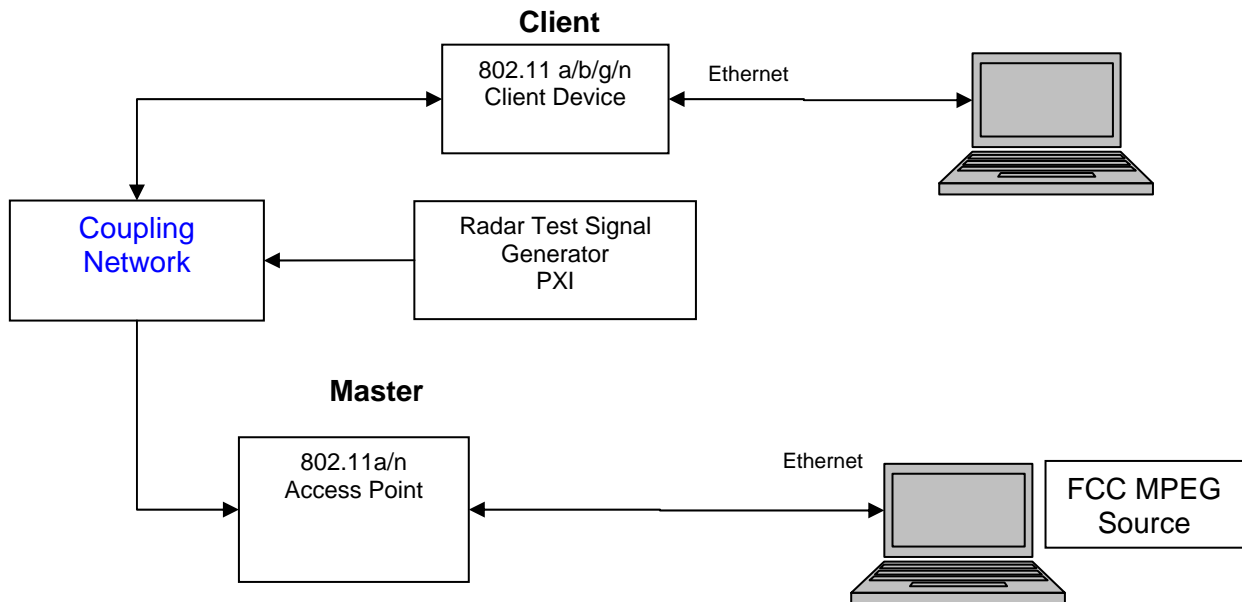

This test report may be reproduced in full only. The document may only be updated by MiCOM Labs personnel. Any changes will be noted in the Document History section of the report.



The EUT is a Master Device with radar detection.

**Applicability of DFS Requirements Prior to Use of a Channel**  
**(Ref Table 1 of FCC 06-96)**

Requirement	Operational Mode		
	Master	Client Without Radar Detection	Client With Radar Detection
<i>Non-Occupancy Period</i>	Yes	Not required	Yes
<i>DFS Detection Threshold</i>	Yes	Not required	Yes
<i>Channel Availability Check Time</i>	Yes	Not required	Not required
<i>Uniform Spreading</i>	Yes	Not required	Not required
<i>U-NII Detection Bandwidth</i>	Yes	Not required	Yes

**Applicability of DFS requirements during normal operation**  
**(Ref Table 2 of FCC 06-96)**

Requirement	Operational Mode		
	Master	Client Without Radar Detection	Client With Radar Detection
<i>DFS Detection Threshold</i>	Yes	Not required	Yes
<i>Channel Closing Transmission Time</i>	Yes	Yes	Yes
<i>Channel Move Time</i>	Yes	Yes	Yes
<i>U-NII Detection Bandwidth</i>	Yes	Not required	Yes

This test report may be reproduced in full only. The document may only be updated by MiCOM Labs personnel. Any changes will be noted in the Document History section of the report.



**Title:** APIN0224, APIN0225 802.11a/b/g/n/ac  
**To:** FCC 47 CFR Part 15.407 & IC RSS-210  
**Serial #:** ARUB146-U1 Rev A  
**Issue Date:** 13th June 2013  
**Page:** 143 of 344

---

For the frequency band 5,470 – 5,725 MHz, the Master device provides, on aggregate, uniform loading of the spectrum across all devices by selecting an operating channel among the available channels using a random algorithm. The EUT was tested in HT-40 mode.

Declared minimum antenna gain 2.5 dBi. ;

Radar receive signal level = -62 dBm + minimum antenna gain

$$= -62 + 2.5$$

Radar receive signal level = -59.5 dBm

### **Measurement Results - Dynamic Frequency Selection (DFS)**

Ambient conditions.

Temperature: 17 to 23 °C    Relative humidity: 31 to 57%    Pressure: 999 to 1012 mbar

Radio parameters.

Test methodology: Conducted

Device Type: Master

Transmit Power: Maximum

### **Operational Details - Dynamic Frequency Selection (DFS)**

Operational Modes: 802.11a & 802.11n HT40

Data Rates: 6mpbs 802.11a/ 0MCS 802.11n

*\*Note\* No video pixilation was observed during the video stream at these rates. Video frames per second were noted to be at 30fps.*

### **Video Streaming Method - Dynamic Frequency Selection (DFS)**

Using the VideoLan player a video stream was setup on the master laptop with the destination being the client laptop. The video profile chosen for the video stream is "MPEG-2 + MPGA (TS)". On the client laptop the VideoLan player was setup to listen to an incoming video stream from the master device.

The requisite MPEG video file ("TestFile.mpg" available on the NTIA website at the following link <http://ntiacsd.ntia.doc.gov/dfs/>) is used during this video stream.

### **EUT Image Version Build: 37654**

**Note: EUT provided and ARM scan function, this had to be disabled to complete testing**

---

This test report may be reproduced in full only. The document may only be updated by MiCOM Labs personnel. Any changes will be noted in the Document History section of the report.



**Title:** APIN0224, APIN0225 802.11a/b/g/n/ac  
**To:** FCC 47 CFR Part 15.407 & IC RSS-210  
**Serial #:** ARUB146-U1 Rev A  
**Issue Date:** 13th June 2013  
**Page:** 144 of 344

---

#### **6.1.4.6.1. UNII Detection Bandwidth:**

All UNII channels for this device have identical channel bandwidths and DFS testing was completed on channel 5,500 MHz (802.11a) and 5510MHz (HT40).

The generating equipment is configured as shown in the Conducted Test Setup above. A single Burst of the short pulse radar Type 1 through 6 was produced at 5,500 MHz (802.11a) and 5,510 MHz (802.11n HT40) at a level of -61 dBm (Ref Section 5.1). The EUT is set up as a standalone device (no associated Client and no traffic).

A single radar Burst is generated for a minimum of 10 trials, and the response of the EUT is noted. The EUT must detect the Radar Waveform 90% or more of the time.

The radar frequency is increased in 1 MHz steps, repeating the above test sequence, until the detection rate falls below 90%. The highest frequency at which detection is greater than or equal to 90% is denoted as  $F_H$ .

The radar frequency is decreased in 1 MHz steps, repeating the above test sequence, until the detection rate falls below 90%. The lowest frequency at which detection is greater than or equal to 90% is denoted as  $F_L$ .

The U-NII Detection Bandwidth is calculated as follows:

$$\text{U-NII Detection Bandwidth} = F_H - F_L$$

The U-NII Detection Bandwidth must be at least 80% of the EUT transmitter 99% power  
Table of results are continued on the next page.

---

This test report may be reproduced in full only. The document may only be updated by MiCOM Labs personnel. Any changes will be noted in the Document History section of the report.





**Title:** APIN0224, APIN0225 802.11a/b/g/n/ac  
**To:** FCC 47 CFR Part 15.407 & IC RSS-210  
**Serial #:** ARUB146-U1 Rev A  
**Issue Date:** 13th June 2013  
**Page:** 145 of 344

EUT Frequency= 5,500 MHz 802.11a (Detection = √, No Detection = 0)											
Radar Frequency (MHz)	1	2	3	4	5	6	7	8	9	10	Detection Rate (%)
-20											%
-19											%
-18											%
-17											%
-16											%
-15											%
-14											%
-13											%
-12											%
-11											%
-10											%
-9	0	0									<90%
-8	√	√	√	√	√	√	√	√	√	√	100%
-7	√	√	√	√	√	√	√	√	√	√	100%
-6	√	√	√	√	√	√	√	√	√	√	100%
-5	√	√	√	√	√	√	√	√	√	√	100%
-4	√	√	√	√	√	√	√	√	√	√	90%
-3	√	√	√	√	√	√	√	√	√	√	100%
-2	√	√	√	√	√	√	√	√	√	√	100%
-1	√	√	√	√	√	√	√	√	√	√	100%
F <sub>0</sub>	√	√	√	√	√	√	√	√	√	√	100%
+1	√	√	√	√	√	√	√	√	√	√	100%
+2	√	√	√	√	√	√	√	√	√	√	90%
+3	√	√	√	√	√	√	√	√	√	√	100%
+4	√	√	√	√	√	√	√	√	√	√	100%
+5	√	√	√	√	√	√	√	√	√	√	100%
+6	√	√	√	√	√	√	√	√	√	√	100%
+7	√	√	√	√	√	√	√	√	√	√	100%
+8	√	√	√	√	√	√	√	√	√	√	100%
+9	0	0									<90%
+10											%
+11											%
+12											%
+13											%
+14											%
+15											%
+16											%
+17											%

Detection Bandwidth =  $F_H - F_L = 5508 - 5492 = 16$  MHz  
 EUT 99% Bandwidth = 18.03 MHz (ref. bandwidth channel 5500 MHz)  
 18.03 MHz \*80% = 14.4MHz

For each frequency step the minimum percentage detection is 90%

This test report may be reproduced in full only. The document may only be updated by MiCOM Labs personnel. Any changes will be noted in the Document History section of the report.



**Title:** APIN0224, APIN0225 802.11a/b/g/n/ac  
**To:** FCC 47 CFR Part 15.407 & IC RSS-210  
**Serial #:** ARUB146-U1 Rev A  
**Issue Date:** 13th June 2013  
**Page:** 146 of 344

EUT Frequency= 5,510 MHz 802.11n HT40 (Detection = √, No Detection = 0)											
Radar Frequency (MHz)	1	2	3	4	5	6	7	8	9	10	Detection Rate (%)
-23											%
-22	0	0									<90%
-21	v	v	v	v	v	v	v	v	v	v	100%
-20	v	v	v	v	v	v	v	v	v	v	100%
-19	v	v	v	v	v	v	v	v	v	v	100%
-18	v	v	v	v	v	v	v	v	v	v	100%
-17	v	v	v	v	v	v	v	v	v	v	100%
-16	v	v	v	v	v	v	v	v	v	v	100%
-15	v	v	v	v	v	v	v	v	v	v	100%
-14	v	v	v	v	v	v	v	v	v	v	100%
-13	v	v	v	v	v	v	v	v	v	v	100%
-12	v	v	v	v	v	v	v	v	v	v	100%
-11	v	v	v	v	v	v	v	v	v	v	100%
-10	v	v	v	v	v	v	v	v	v	v	100%
-9	v	v	v	v	v	v	v	v	v	v	100%
-8	v	v	v	v	v	v	v	v	v	v	100%
-7	v	v	v	v	v	v	v	v	v	v	100%
-6	v	v	v	v	v	v	v	v	v	v	100%
-5	v	v	v	v	v	v	v	v	v	v	100%
-4	v	v	v	v	v	v	v	v	v	v	100%
-3	v	v	v	v	v	v	v	v	v	v	100%
-2	v	v	v	v	v	v	v	v	v	v	100%
-1	v	v	v	v	v	v	v	v	v	v	100%
F <sub>0</sub>	v	v	v	v	v	v	v	v	v	v	100%

This test report may be reproduced in full only. The document may only be updated by MiCOM Labs personnel. Any changes will be noted in the Document History section of the report.



**Title:** APIN0224, APIN0225 802.11a/b/g/n/ac  
**To:** FCC 47 CFR Part 15.407 & IC RSS-210  
**Serial #:** ARUB146-U1 Rev A  
**Issue Date:** 13th June 2013  
**Page:** 147 of 344

EUT Frequency= 5,510 MHz 802.11n HT40 (Detection = √, No Detection = 0)											
Radar Frequency (MHz)	1	2	3	4	5	6	7	8	9	10	Detection Rate (%)
F <sub>0</sub>	v	v	v	v	v	v	v	v	v	v	100%
+1	v	v	v	v	v	v	v	v	v	v	100%
+2	v	v	v	v	v	v	v	v	v	v	100%
+3	v	v	v	v	v	v	v	v	v	v	100%
+4	v	v	v	v	v	v	v	v	v	v	100%
+5	v	v	v	v	v	v	v	v	v	v	100%
+6	v	v	v	v	v	v	v	v	v	v	100%
+7	v	v	v	v	v	v	v	v	v	v	100%
+8	v	v	v	v	v	v	v	v	v	v	100%
+9	v	v	v	v	v	v	v	v	v	v	100%
+10	v	v	v	v	v	v	v	v	v	v	100%
+11	v	v	v	v	v	v	v	v	v	v	100%
+12	v	v	v	v	v	v	v	v	v	v	100%
+13	v	v	v	v	v	v	v	v	v	v	100%
+14	v	v	v	v	v	v	v	v	v	v	100%
+15	v	v	v	v	v	v	v	v	v	v	100%
+16	v	v	v	v	v	v	v	v	v	v	100%
+17	v	v	v	v	v	v	v	v	v	v	100%
+18	v	v	v	v	v	v	v	v	v	v	100%
+19	v	v	v	v	v	v	v	v	v	v	100%
+20	v	v	v	v	v	v	v	v	v	v	100%
+21	v	v	v	v	v	v	v	v	v	v	100%
+22	0	0									<90%
+23											%
Detection Bandwidth = F <sub>H</sub> -F <sub>L</sub> = 5531-5489 = 42 MHz											
EUT 99% Bandwidth = 36.6 MHz (ref. bandwidth channel 5510 MHz)											
36.6 MHz *80% = 29.28 MHz											

For each frequency step the minimum percentage detection is 90%

This test report may be reproduced in full only. The document may only be updated by MiCOM Labs personnel. Any changes will be noted in the Document History section of the report.



**Title:** APIN0224, APIN0225 802.11a/b/g/n/ac  
**To:** FCC 47 CFR Part 15.407 & IC RSS-210  
**Serial #:** ARUB146-U1 Rev A  
**Issue Date:** 13th June 2013  
**Page:** 148 of 344

---

#### 6.1.4.6.2. Initial Channel Availability Check Time

This test verifies that the EUT does not emit pulse, control, or data signals on the test Channel until the power-up sequence has been completed and the U-NII device checks for Radar Waveforms for one minute on the test Channel. This test does not use any Radar Waveforms.

The U-NII device is powered on and be instructed to operate at 5,500MHz 802.11a and 5,510MHz 802.11n HT40. At the same time the EUT is powered on, the spectrum analyzer is set for zero span with a 1 MHz resolution bandwidth at 5,500& 5,510 MHz with a 260 second sweep time. The analyzer's sweep will be started the same time power is applied to the U-NII device.

The EUT should not transmit any pulse or data transmissions until at least 1 minute after the completion of the power-on cycle.

The first red marker line shown on the following plot denotes the instant when the EUT starts its power-up sequence i.e.  $T_0$  (as defined within the FCC's MO&O 06-96 Normative Reference 2 ). The power-up reference  $T_0$  is determined by the time it takes for the EUT to start "beaconing" i.e. initial beacon – 60 secs = end of power-up.

The Channel Availability Check Time commences at instant  $T_0$  and will end no sooner than  $T_0 + 60$  seconds.

---

This test report may be reproduced in full only. The document may only be updated by MiCOM Labs personnel. Any changes will be noted in the Document History section of the report.



**EUT power up and Initial Channel Availability Check Time**  
**5,500MHz 802.11a Power On = 88.57 Seconds**

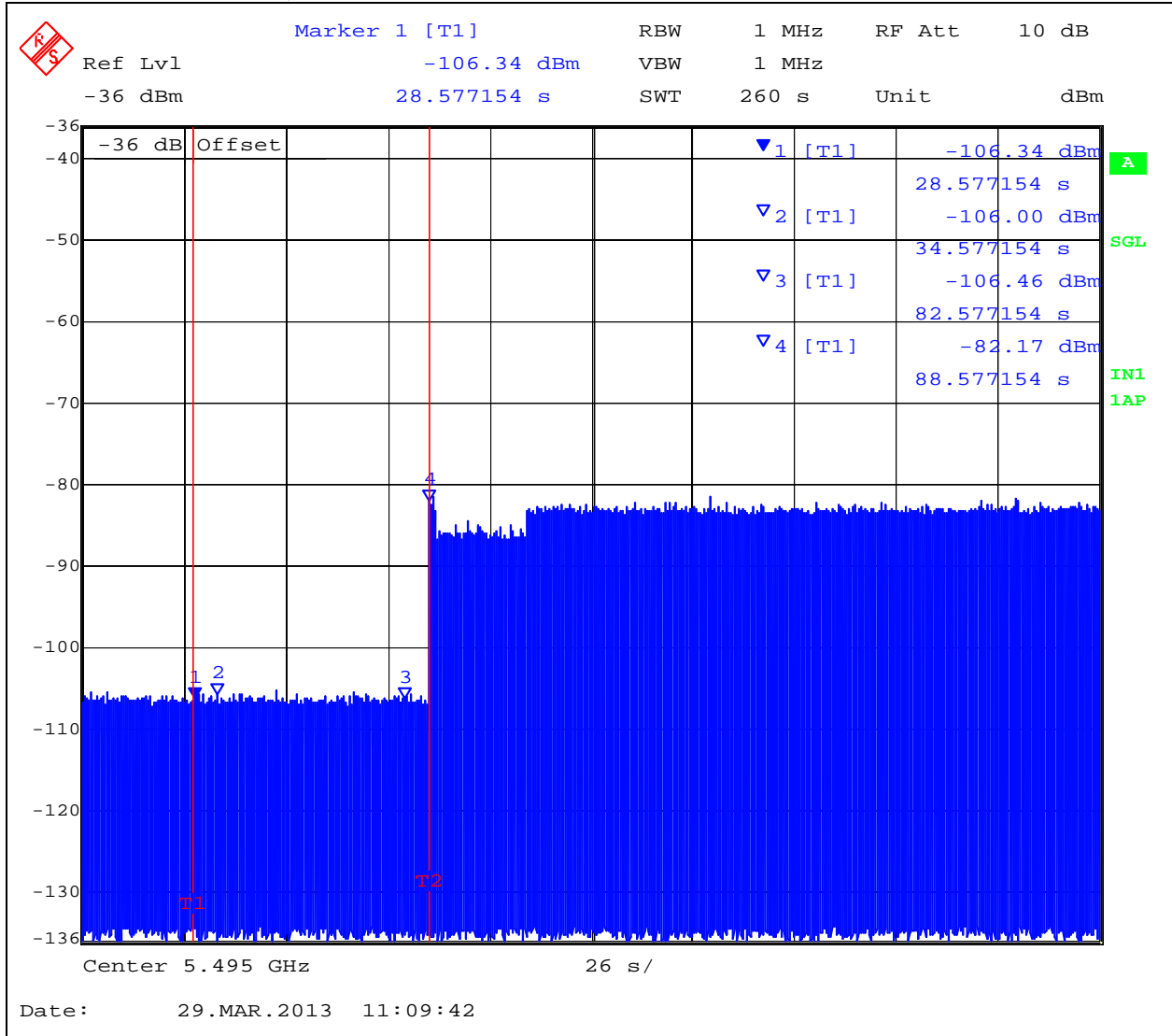

This test report may be reproduced in full only. The document may only be updated by MiCOM Labs personnel. Any changes will be noted in the Document History section of the report.



**Title:** APIN0224, APIN0225 802.11a/b/g/n/ac  
**To:** FCC 47 CFR Part 15.407 & IC RSS-210  
**Serial #:** ARUB146-U1 Rev A  
**Issue Date:** 13th June 2013  
**Page:** 150 of 344

**EUT power up and Initial Channel Availability Check Time**  
**5,510MHz 802.11n HT40 Power On = 88.05 Seconds**

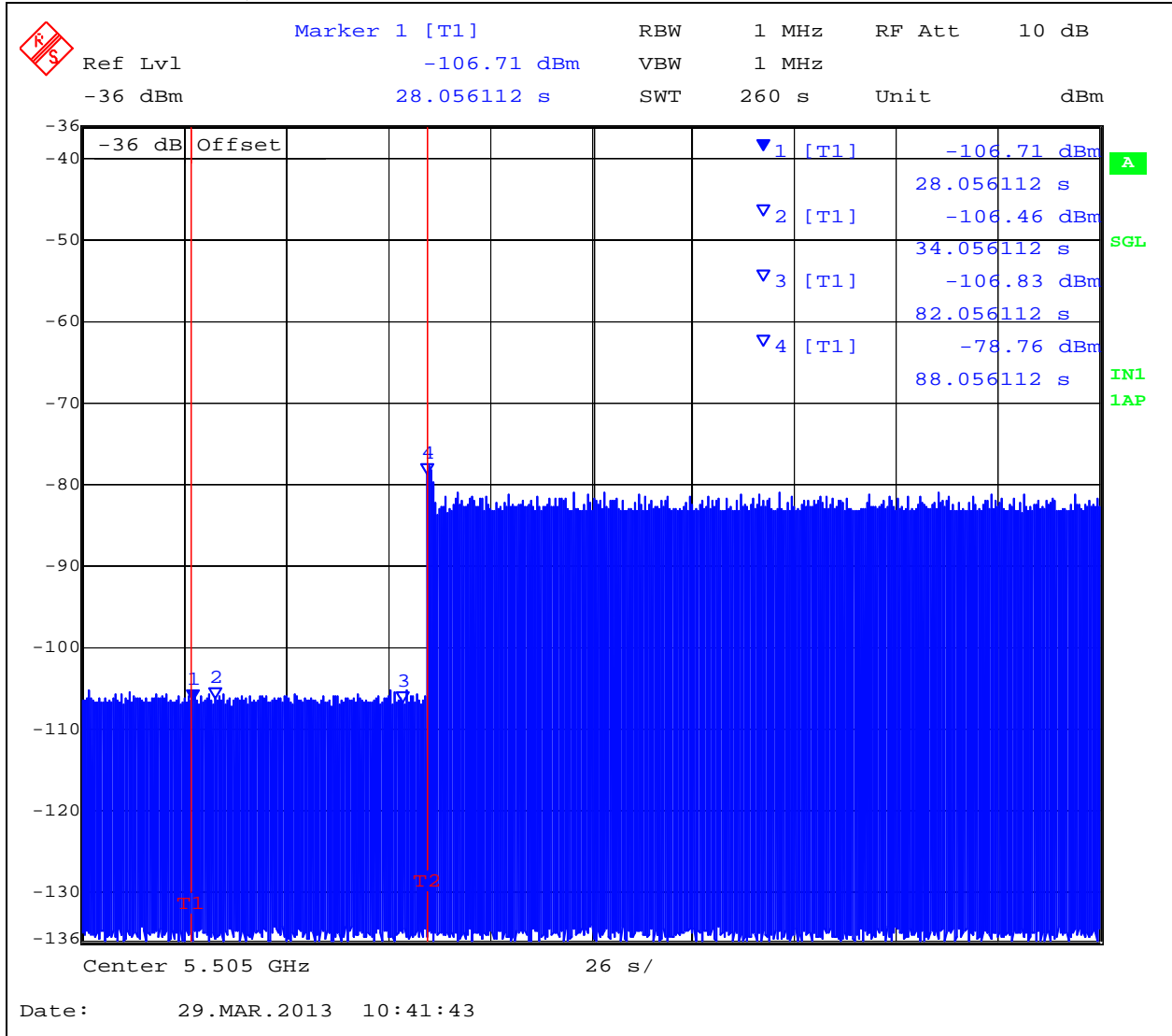

This test report may be reproduced in full only. The document may only be updated by MiCOM Labs personnel. Any changes will be noted in the Document History section of the report.



**Title:** APIN0224, APIN0225 802.11a/b/g/n/ac  
**To:** FCC 47 CFR Part 15.407 & IC RSS-210  
**Serial #:** ARUB146-U1 Rev A  
**Issue Date:** 13th June 2013  
**Page:** 151 of 344

---

#### **6.1.4.6.3. Radar Burst at the Beginning of the Channel Availability Check Time:**

The steps below define the procedure to verify successful radar detection on the selected Channel during a period equal to the Channel Availability Check Time and avoidance of operation on that Channel when a radar Burst with a level equal to the DFS Detection Threshold +6 dB (-62 dBm Ref Section 6.1.7) occurs at the beginning of the Channel Availability Check Time.

A single Burst of short pulse of radar Type 1 will commence within a 6 second window starting at  $T_0$  (first red marker line on the following plot).

Visual indication on the EUT of successful detection of the radar Burst will be recorded and reported. Observation of emissions at 5,500MHz 802.11a & 5,510MHz 802.11n HT40 will continue for 2.5 minutes after the radar burst has been generated.

---

This test report may be reproduced in full only. The document may only be updated by MiCOM Labs personnel. Any changes will be noted in the Document History section of the report.



### Channel Availability Check Time at the start T0 + 6 seconds Check Time 5,500MHz 802.11a

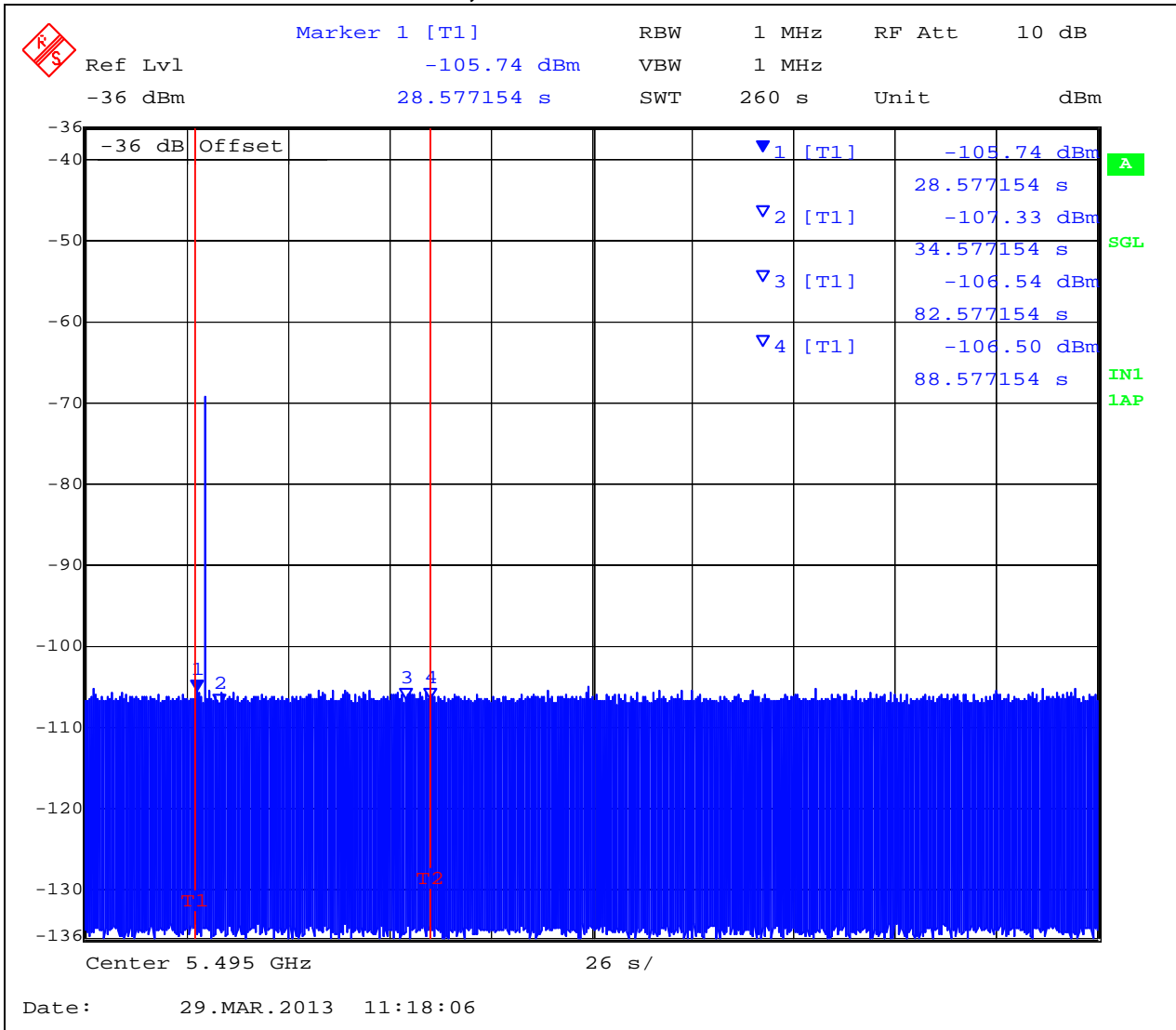

This test report may be reproduced in full only. The document may only be updated by MiCOM Labs personnel. Any changes will be noted in the Document History section of the report.





**Channel Availability Check Time at the start T0 + 6 seconds Check Time**  
**5,510MHz 802.11n HT40**

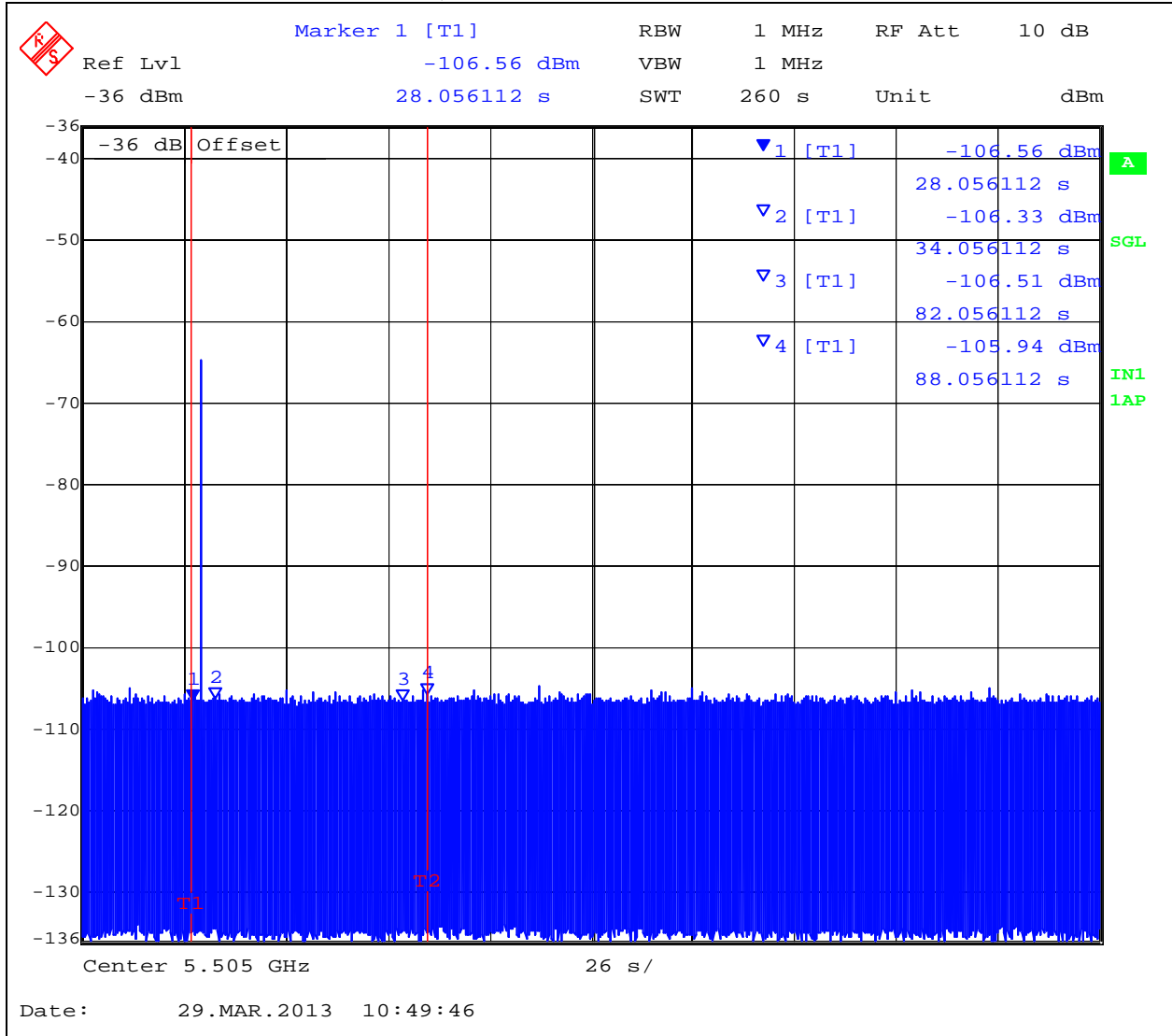

This test report may be reproduced in full only. The document may only be updated by MiCOM Labs personnel. Any changes will be noted in the Document History section of the report.



**Title:** APIN0224, APIN0225 802.11a/b/g/n/ac  
**To:** FCC 47 CFR Part 15.407 & IC RSS-210  
**Serial #:** ARUB146-U1 Rev A  
**Issue Date:** 13th June 2013  
**Page:** 154 of 344

---

#### **6.1.4.6.4. Radar Burst at the End of the Channel Availability Check Time:**

The steps below define the procedure to verify successful radar detection on the selected Channel during a period equal to the Channel Availability Check Time and avoidance of operation on that Channel when a radar Burst with a level equal to the DFS Detection Threshold occurs at the end of the Channel Availability Check Time.

A single Burst of short pulse of radar type 1 will commence within a 6 second window starting at  $T_0 + 54$  seconds. The window will commence at marker 2 and end at the red frequency line  $T_2$ .

Visual indication on the EUT of successful detection of the radar Burst will be recorded and reported. Observation of emissions at 5,500MHz 802.11a & 5,510MHz 802.11n HT40 will continue for 2.5 minutes after the radar burst has been generated.

---

This test report may be reproduced in full only. The document may only be updated by MiCOM Labs personnel. Any changes will be noted in the Document History section of the report.



Channel Availability Check Time at T0 + 54 seconds Check Time  
5,500MHz 802.11a

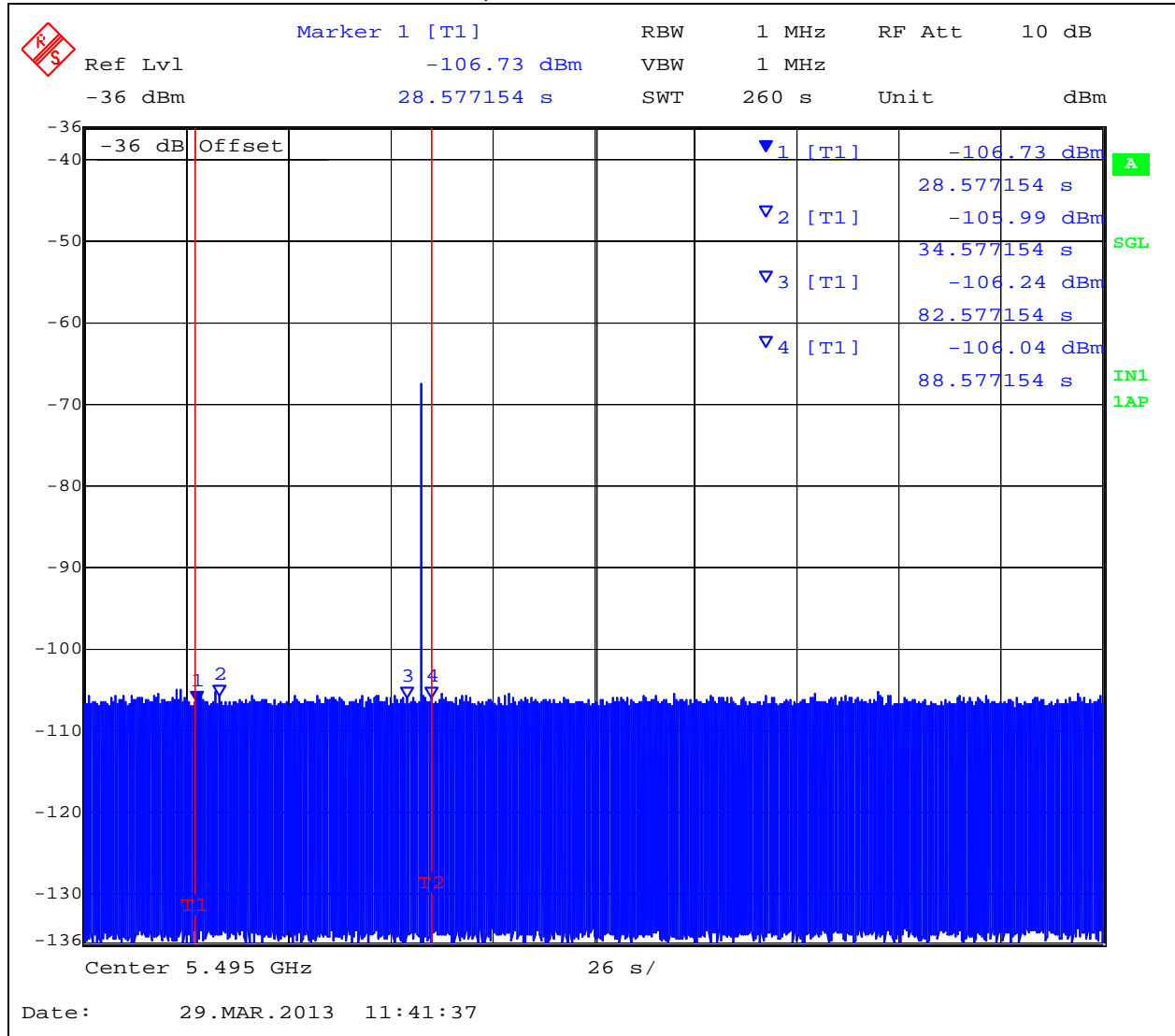

This test report may be reproduced in full only. The document may only be updated by MiCOM Labs personnel. Any changes will be noted in the Document History section of the report.



**Channel Availability Check Time at T0 + 54 seconds Check Time**  
**5,510MHz 802.11n HT40**

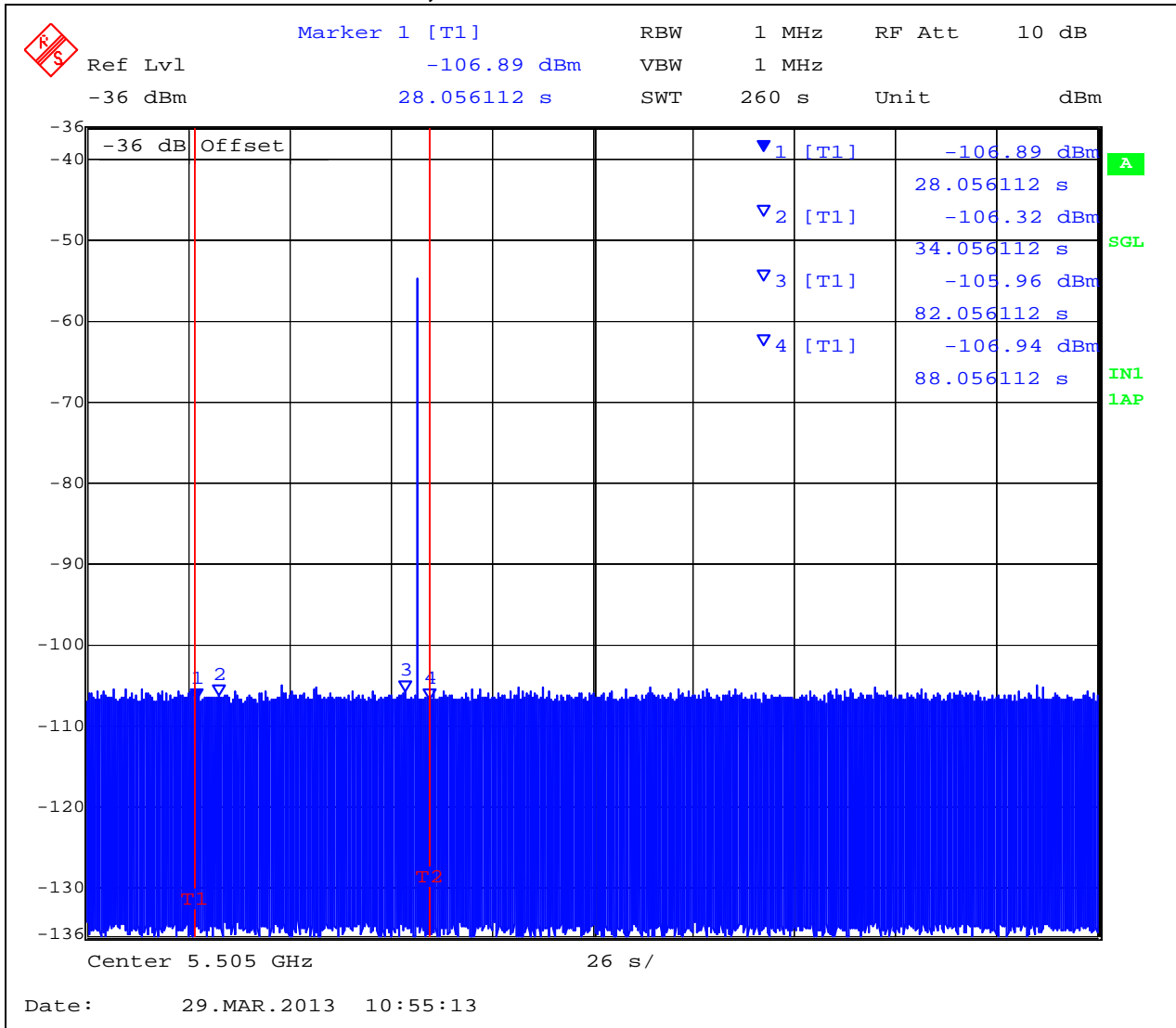

This test report may be reproduced in full only. The document may only be updated by MiCOM Labs personnel. Any changes will be noted in the Document History section of the report.



#### 6.1.4.6.5. In-Service Monitoring for Channel Move Time, Channel Closing Transmission Time and Non-Occupancy Period

##### **FCC §15.407(h)(2)(iii)**

The steps below define the procedure to determine the above mentioned parameters when a radar Burst with a level equal to the DFS Detection Threshold is generated on the Operating Channel of the U-NII device.

A U-NII device operating as a Client Device will associate with the EUT (Master). The requisite MPEG video file ("TestFile.mpg" available on the NTIA website at the following link <http://ntiacsd.ntia.doc.gov/dfs/>) is streamed from the master device (AP) to the client.

#### **Channel Closing Transmission Time - Measurement**

A Type 1 waveform was introduced to the EUT, from which a 12 second transmission record was digitally captured, collecting nearly 250M samples of data, which included in excess of 600 ms of pre-trigger data. This Type 1 waveform had an integral marker built into its construction, marking the start of the radar waveform play, which directly triggered the PXI digitizer's data capture via the PXI backplane trigger bus.

The test system was set-up to capture all transmission data for access point events above a threshold level of -50 dBm. The test equipment time stamps all captured events with respect to  $T_0$  (zero time indicating the start of the measurements sequence) starting the 612.1 ms pre-trigger period followed by the radar type 1 burst period.

Radar (Type 1) Pre-trigger period      612.1 ms

Type 1 burst period                      25.70 ms

(The period of the 18 pulse burst includes [18 pulses \* 1.428mS PRI] = 25.704 ms. Then add 1  $\mu$ s pulse width for the final pulse.)

Channel Closing Transmission Time starts immediately after the last radar pulse is transmitted i.e. 637.8 ms after the start of the trace capture period.



**Title:** APIN0224, APIN0225 802.11a/b/g/n/ac  
**To:** FCC 47 CFR Part 15.407 & IC RSS-210  
**Serial #:** ARUB146-U1 Rev A  
**Issue Date:** 13th June 2013  
**Page:** 158 of 344

Therefore, pulses seen after this 637.8 ms boundary are identified and totaled to provide an aggregate total of transmissions in order to determine whether the EUT is compliant with the Channel Closing Transmission Time requirements as described in MO&O FCC 06-96. In this case, it was found that an aggregate total of 0.00 ms of transmission time accrued. This value is found at the right hand side at the foot of the following plot (10s Total).

**Channel Closing Transmission Time 5,500 MHz (802.11a) = 17.42 mSecs (limit 260 mSecs)**

**Channel Move Time 5,500MHz (802.11a) = 0.4622 Secs (limit 10 Secs)**

### Channel Move Time, Channel Closing Transmission Time for Type 1 Radar Captured by the Test System - 0 to 2 seconds

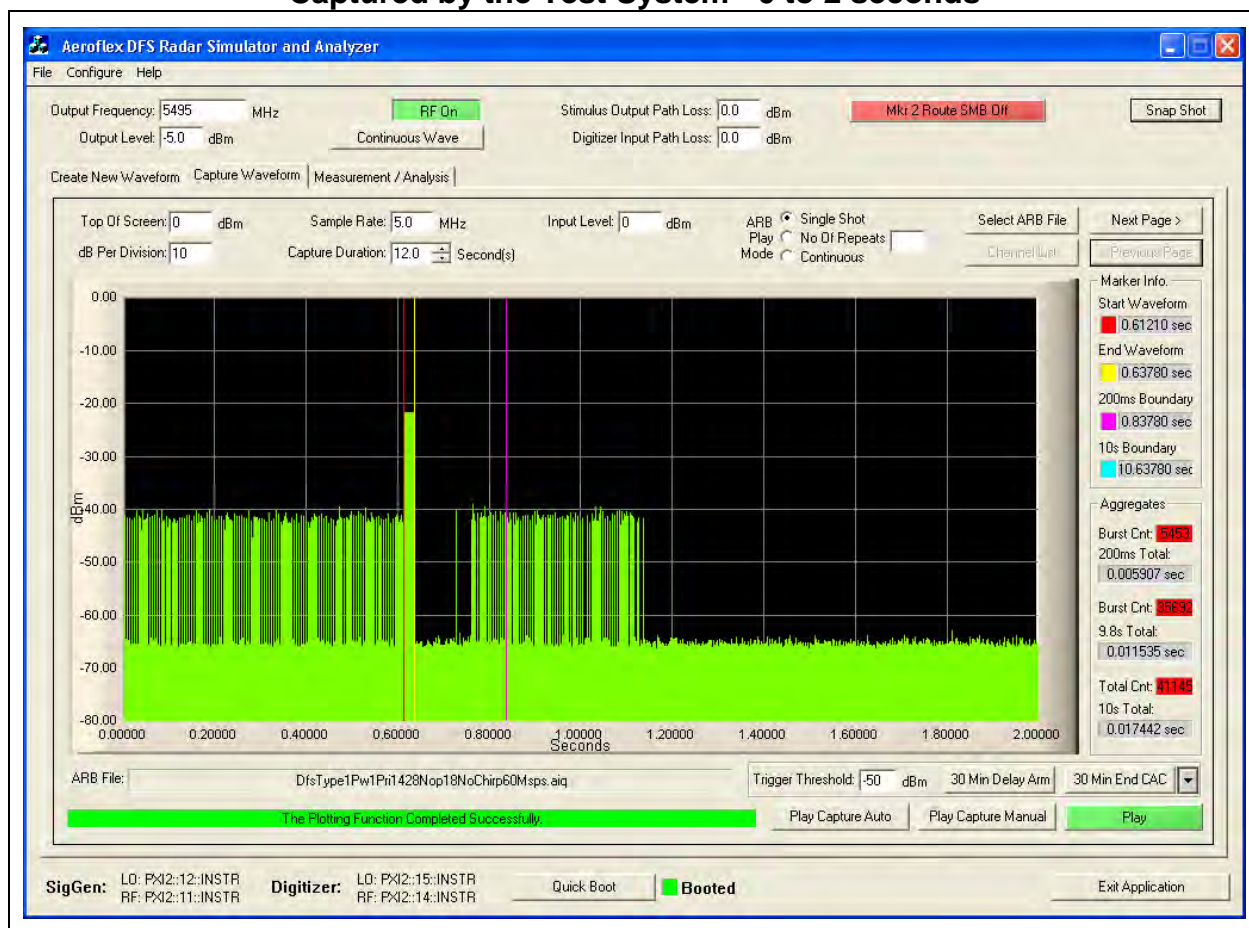

This test report may be reproduced in full only. The document may only be updated by MiCOM Labs personnel. Any changes will be noted in the Document History section of the report.



**Title:** APIN0224, APIN0225 802.11a/b/g/n/ac  
**To:** FCC 47 CFR Part 15.407 & IC RSS-210  
**Serial #:** ARUB146-U1 Rev A  
**Issue Date:** 13th June 2013  
**Page:** 159 of 344

### Channel Move Time, Channel Closing Transmission Time for Type 1 Radar Captured by the Test System - 2 to 4 seconds

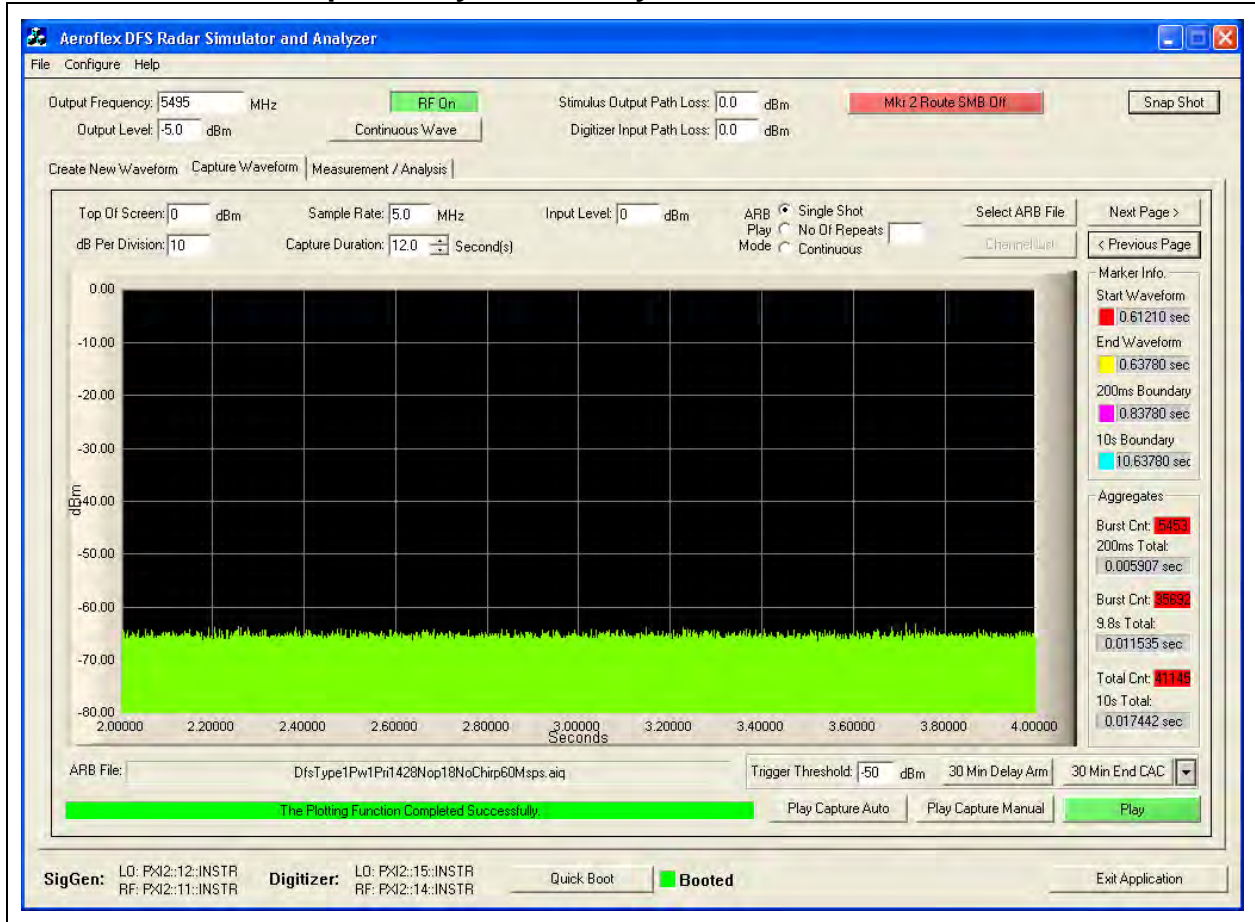

This test report may be reproduced in full only. The document may only be updated by MiCOM Labs personnel. Any changes will be noted in the Document History section of the report.



**Title:** APIN0224, APIN0225 802.11a/b/g/n/ac  
**To:** FCC 47 CFR Part 15.407 & IC RSS-210  
**Serial #:** ARUB146-U1 Rev A  
**Issue Date:** 13th June 2013  
**Page:** 160 of 344

### Channel Move Time, Channel Closing Transmission Time for Type 1 Radar Captured by the Test System - 4 to 6 seconds

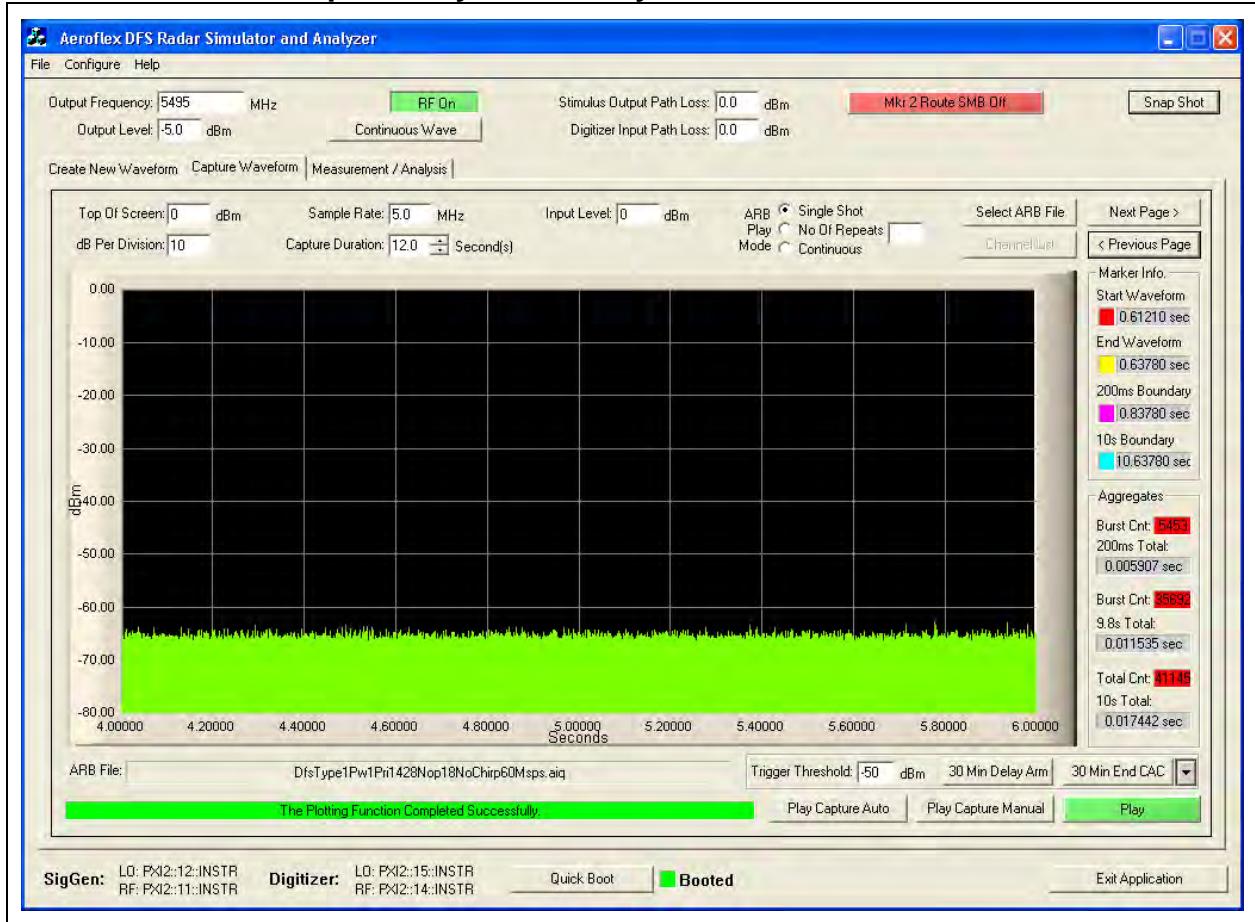

This test report may be reproduced in full only. The document may only be updated by MiCOM Labs personnel. Any changes will be noted in the Document History section of the report.





**Title:** APIN0224, APIN0225 802.11a/b/g/n/ac  
**To:** FCC 47 CFR Part 15.407 & IC RSS-210  
**Serial #:** ARUB146-U1 Rev A  
**Issue Date:** 13th June 2013  
**Page:** 161 of 344

### Channel Move Time, Channel Closing Transmission Time for Type 1 Radar Captured by the Test System - 6 to 8 seconds

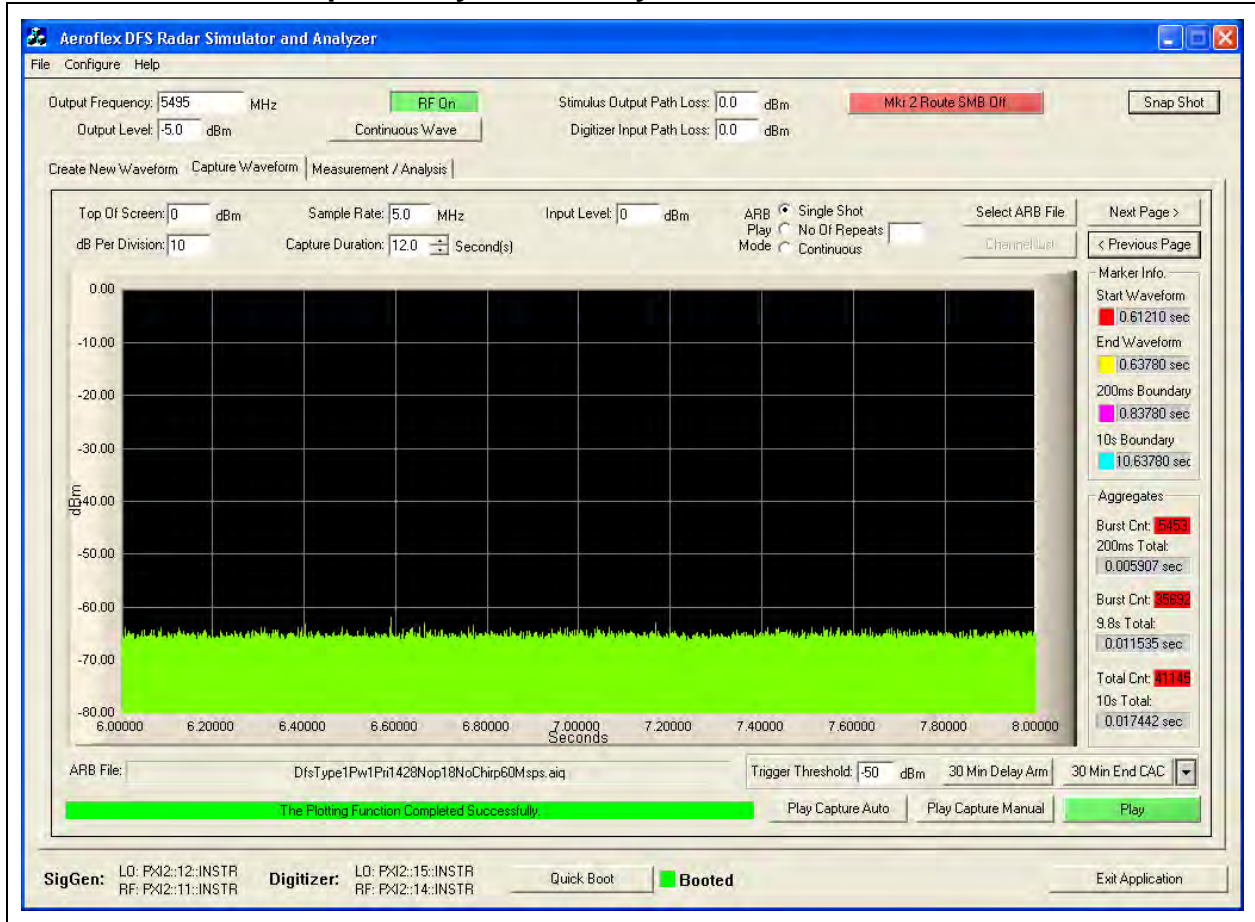

This test report may be reproduced in full only. The document may only be updated by MiCOM Labs personnel. Any changes will be noted in the Document History section of the report.



Title: APIN0224, APIN0225 802.11a/b/g/n/ac  
To: FCC 47 CFR Part 15.407 & IC RSS-210  
Serial #: ARUB146-U1 Rev A  
Issue Date: 13th June 2013  
Page: 162 of 344

### Channel Move Time, Channel Closing Transmission Time for Type 1 Radar Captured by the Test System - 8 to 10 seconds

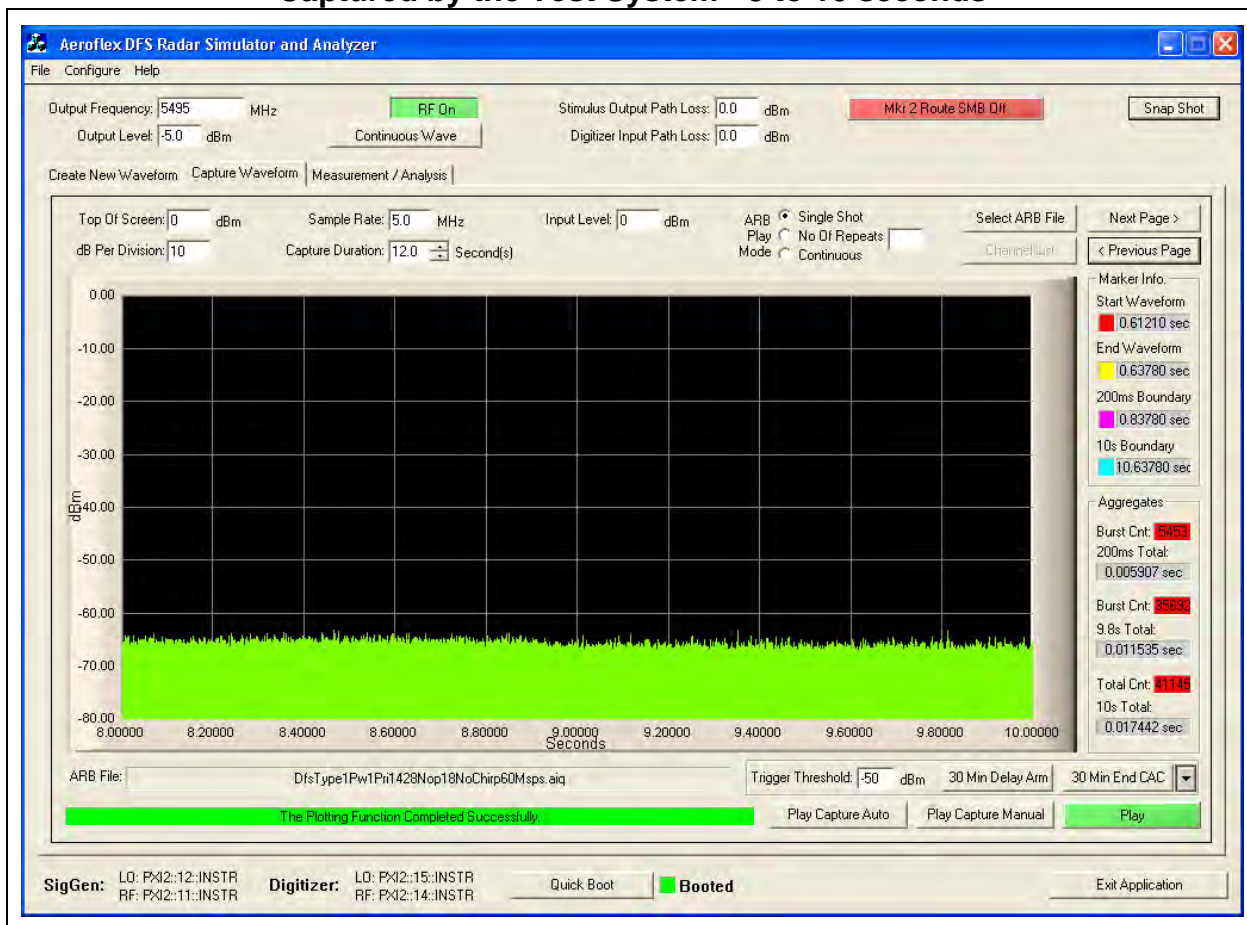

This test report may be reproduced in full only. The document may only be updated by MiCOM Labs personnel. Any changes will be noted in the Document History section of the report.



**Title:** APIN0224, APIN0225 802.11a/b/g/n/ac  
**To:** FCC 47 CFR Part 15.407 & IC RSS-210  
**Serial #:** ARUB146-U1 Rev A  
**Issue Date:** 13th June 2013  
**Page:** 163 of 344

### Channel Move Time, Channel Closing Transmission Time for Type 1 Radar Captured by the Test System - 10 to 12 seconds

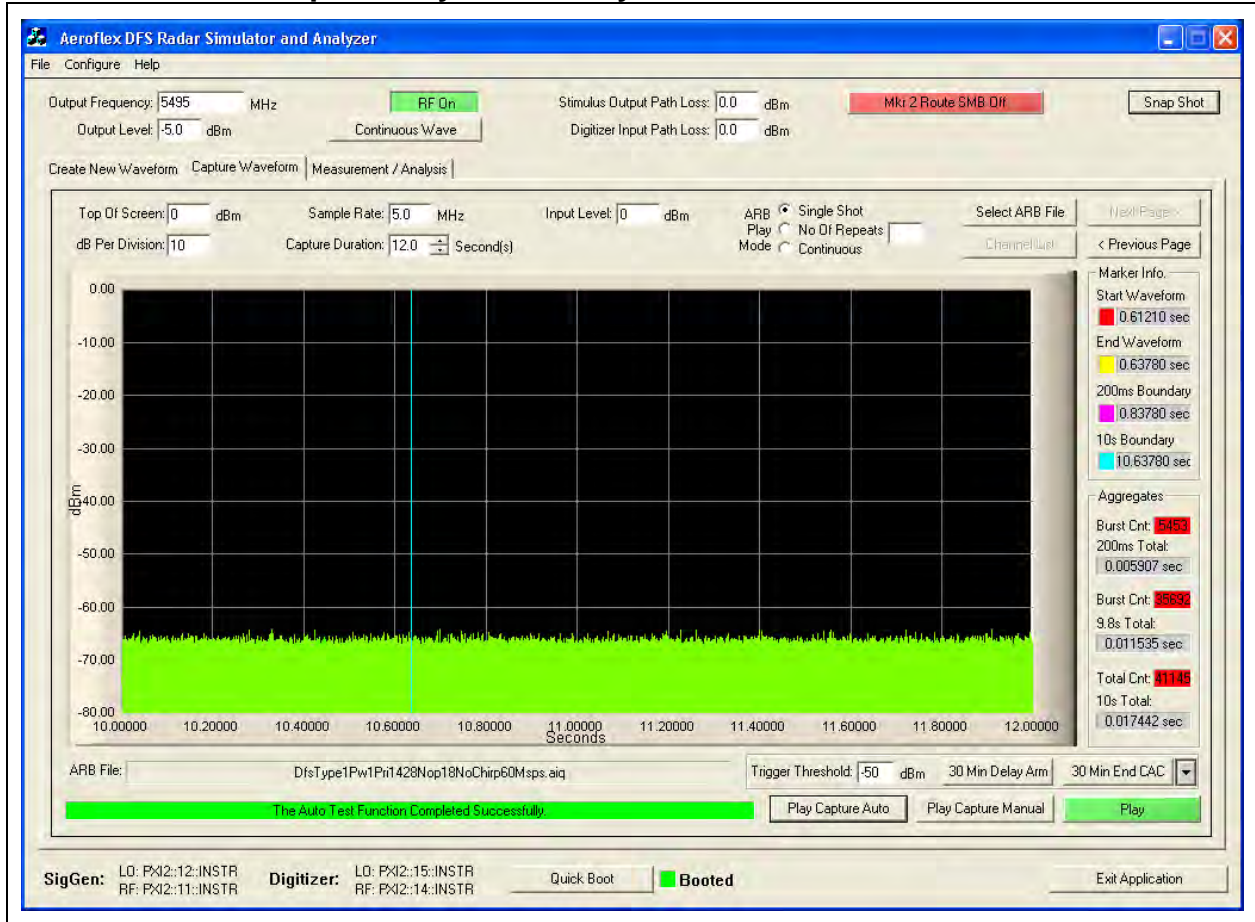

This test report may be reproduced in full only. The document may only be updated by MiCOM Labs personnel. Any changes will be noted in the Document History section of the report.



**Title:** APIN0224, APIN0225 802.11a/b/g/n/ac  
**To:** FCC 47 CFR Part 15.407 & IC RSS-210  
**Serial #:** ARUB146-U1 Rev A  
**Issue Date:** 13th June 2013  
**Page:** 164 of 344

**Channel Closing Transmission Time 5,510 MHz (802.11n HT40) = 42.29 mSecs**  
**(limit 260 mSecs)**

**Channel Move Time 5,510 MHz (802.11n HT40) = 1.1422 Secs** (limit 10 Secs)

### Channel Move Time, Channel Closing Transmission Time for Type 1 Radar Captured by the Test System - 0 to 2 seconds

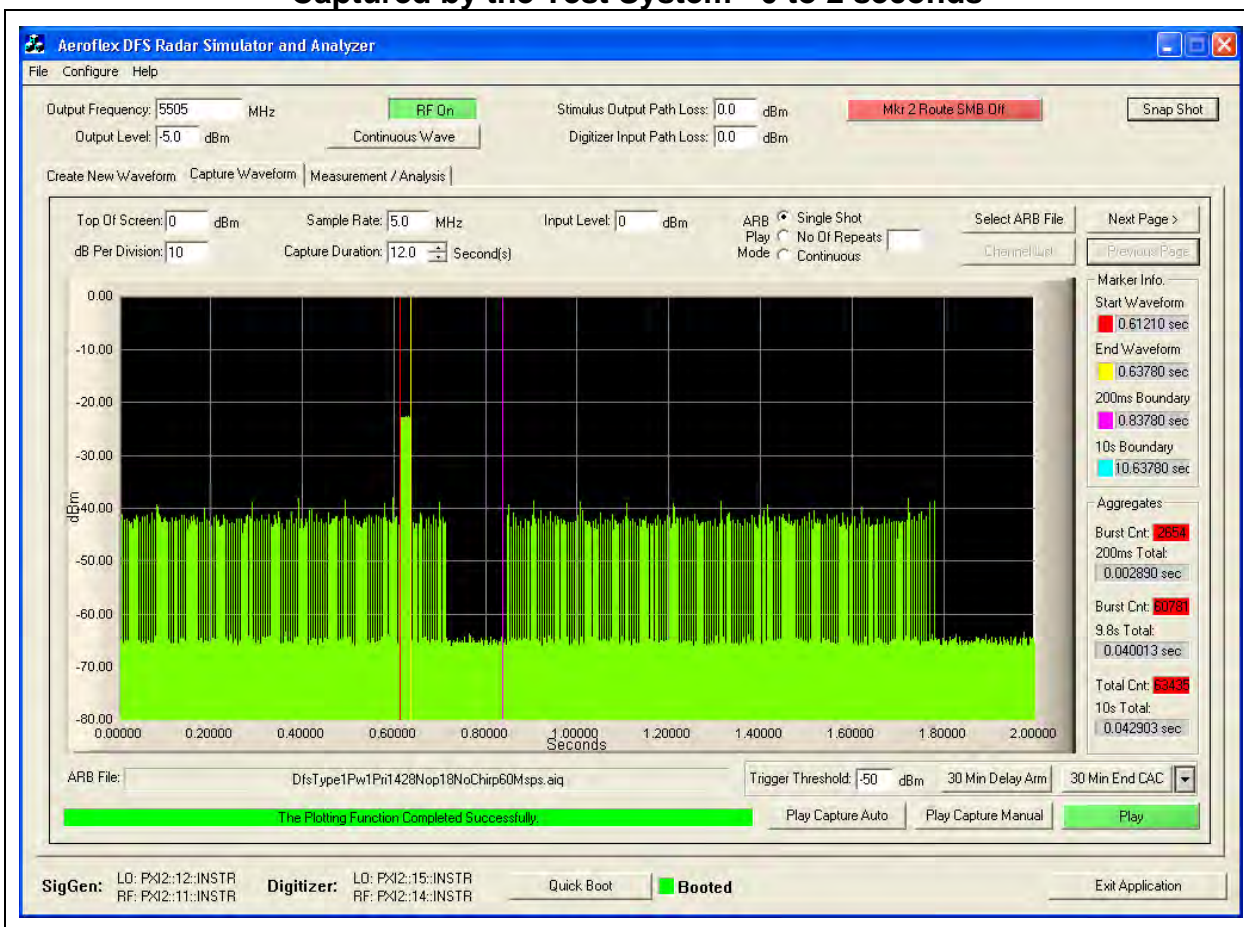

This test report may be reproduced in full only. The document may only be updated by MiCOM Labs personnel. Any changes will be noted in the Document History section of the report.



Title: APIN0224, APIN0225 802.11a/b/g/n/ac  
To: FCC 47 CFR Part 15.407 & IC RSS-210  
Serial #: ARUB146-U1 Rev A  
Issue Date: 13th June 2013  
Page: 165 of 344

### Channel Move Time, Channel Closing Transmission Time for Type 1 Radar Captured by the Test System - 2 to 4 seconds

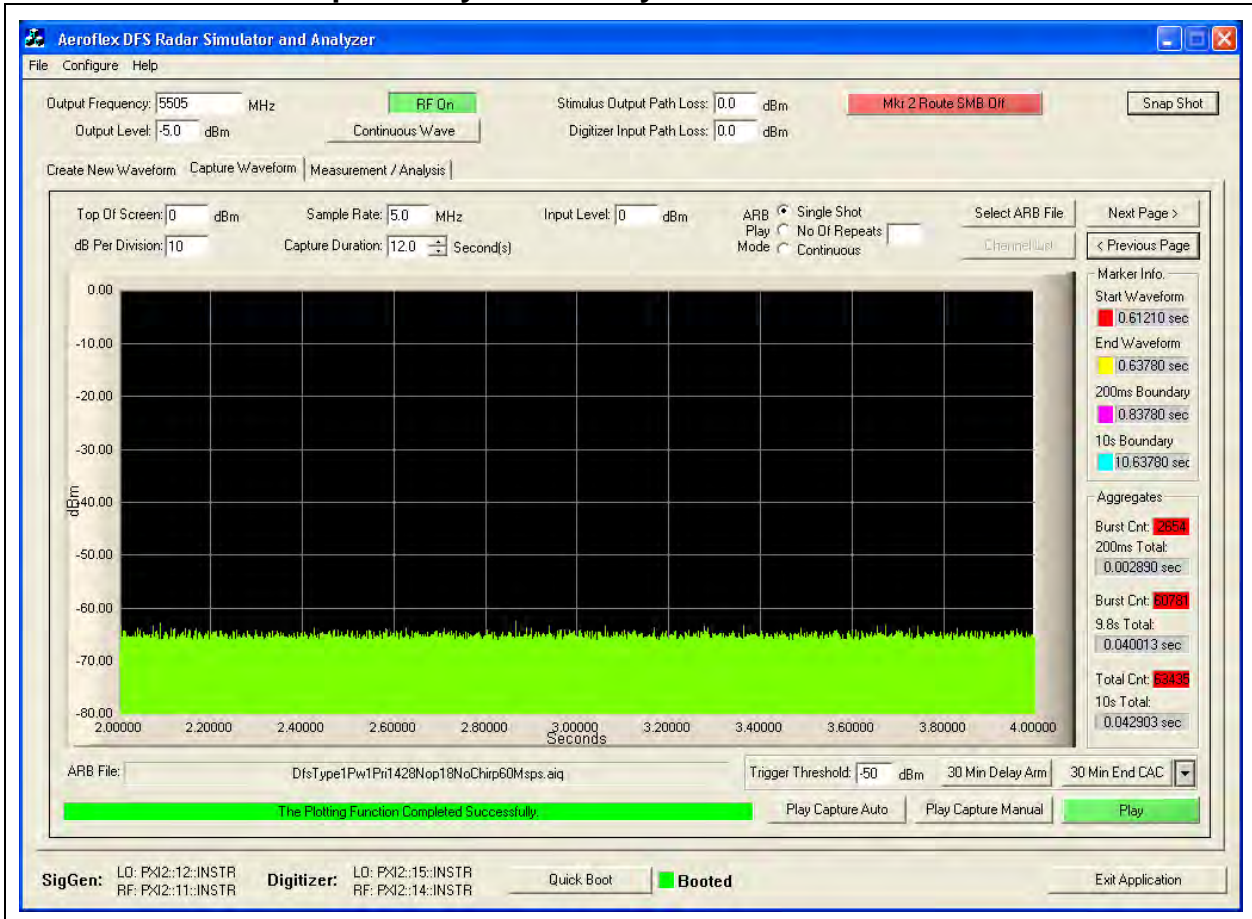

This test report may be reproduced in full only. The document may only be updated by MiCOM Labs personnel. Any changes will be noted in the Document History section of the report.



**Title:** APIN0224, APIN0225 802.11a/b/g/n/ac  
**To:** FCC 47 CFR Part 15.407 & IC RSS-210  
**Serial #:** ARUB146-U1 Rev A  
**Issue Date:** 13th June 2013  
**Page:** 166 of 344

### Channel Move Time, Channel Closing Transmission Time for Type 1 Radar Captured by the Test System - 4 to 6 seconds

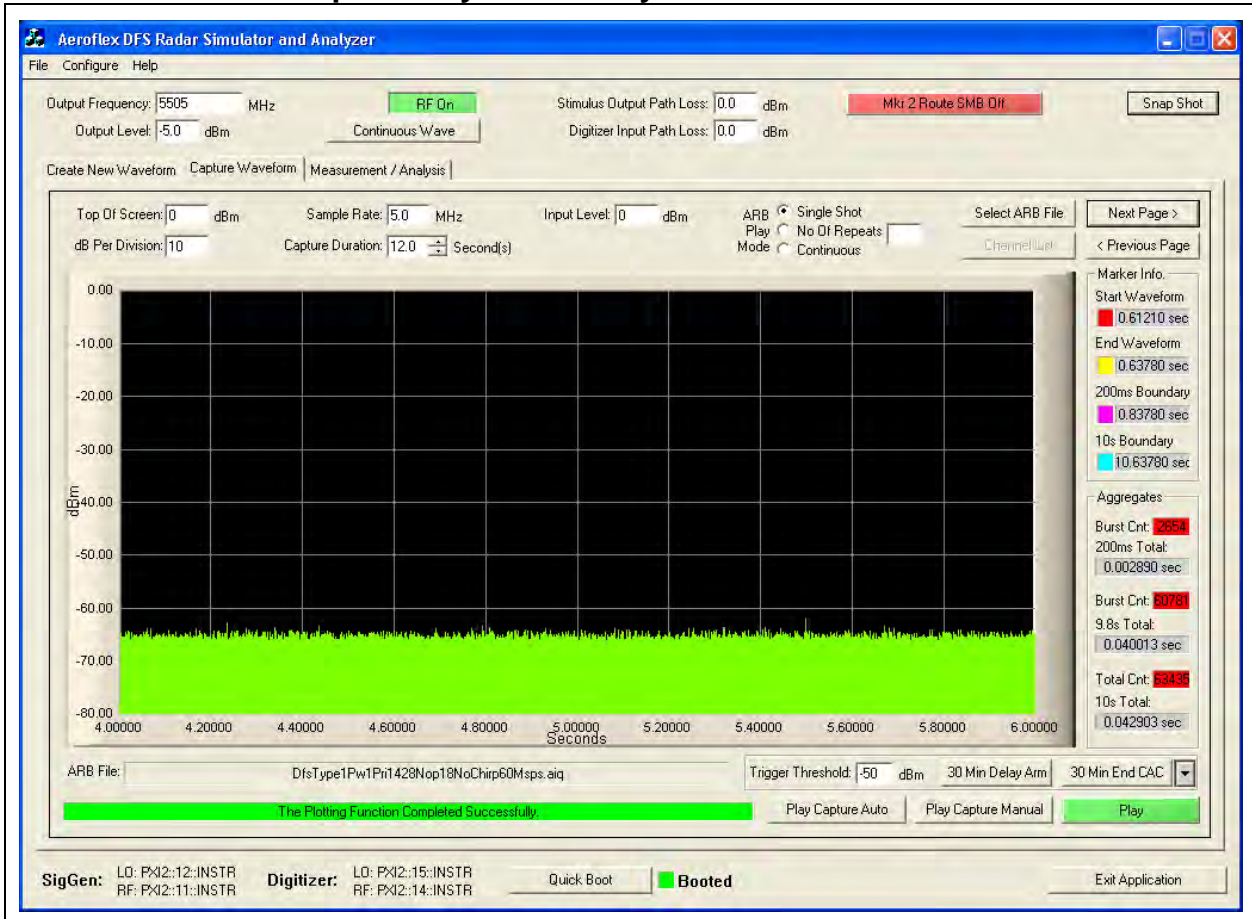

This test report may be reproduced in full only. The document may only be updated by MiCOM Labs personnel. Any changes will be noted in the Document History section of the report.



Title: APIN0224, APIN0225 802.11a/b/g/n/ac  
To: FCC 47 CFR Part 15.407 & IC RSS-210  
Serial #: ARUB146-U1 Rev A  
Issue Date: 13th June 2013  
Page: 167 of 344

### Channel Move Time, Channel Closing Transmission Time for Type 1 Radar Captured by the Test System - 6 to 8 seconds

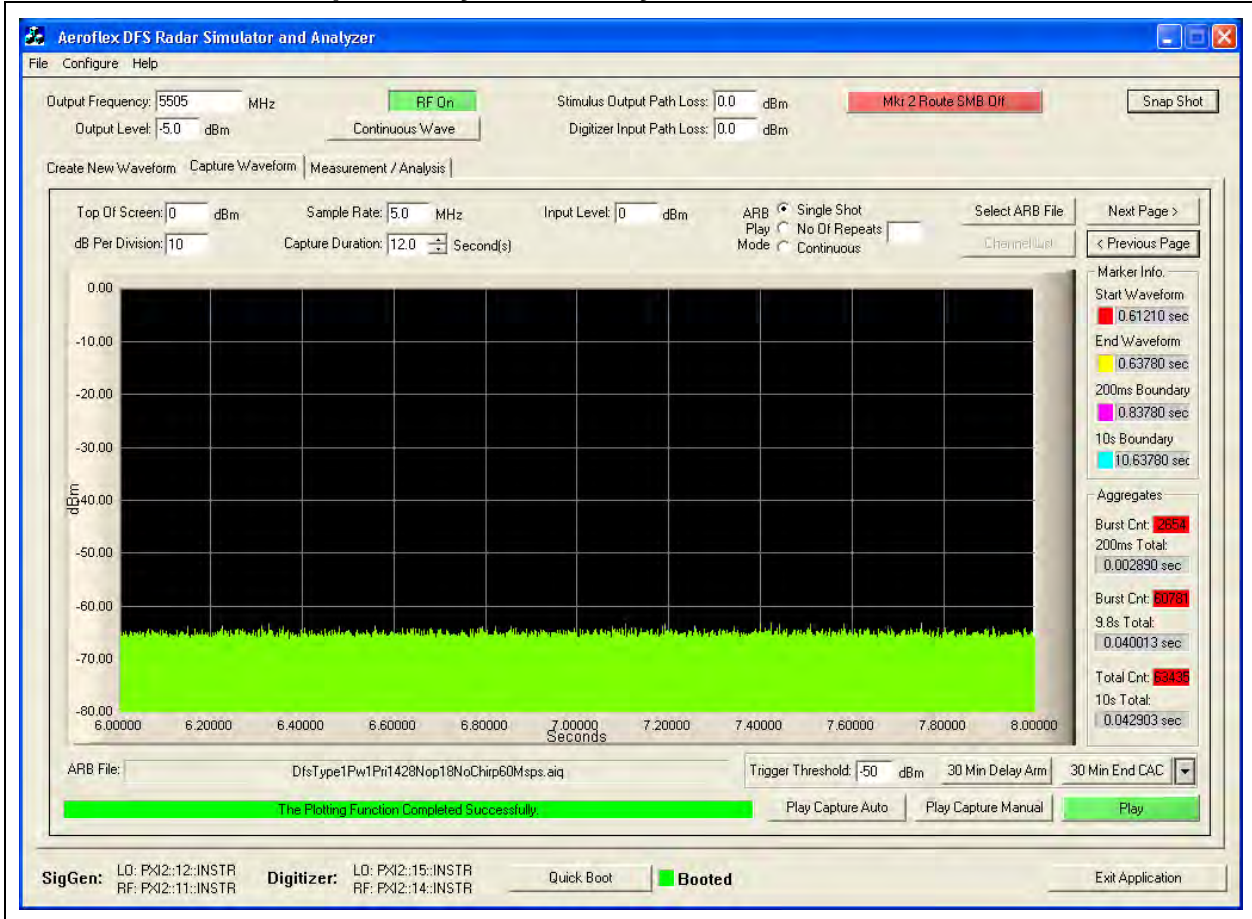

This test report may be reproduced in full only. The document may only be updated by MiCOM Labs personnel. Any changes will be noted in the Document History section of the report.



**Title:** APIN0224, APIN0225 802.11a/b/g/n/ac  
**To:** FCC 47 CFR Part 15.407 & IC RSS-210  
**Serial #:** ARUB146-U1 Rev A  
**Issue Date:** 13th June 2013  
**Page:** 168 of 344

### Channel Move Time, Channel Closing Transmission Time for Type 1 Radar Captured by the Test System - 8 to 10 seconds

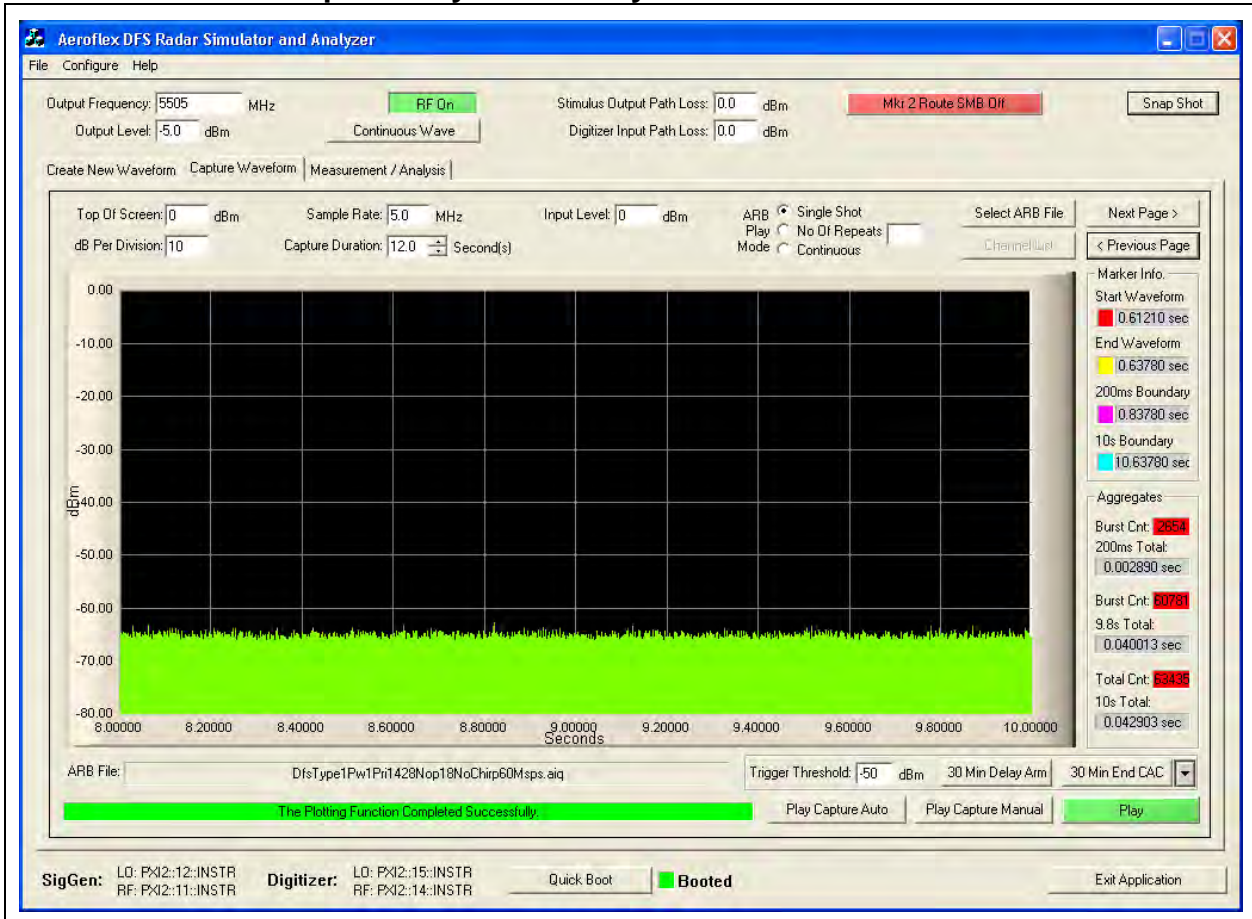

This test report may be reproduced in full only. The document may only be updated by MiCOM Labs personnel. Any changes will be noted in the Document History section of the report.





Title: APIN0224, APIN0225 802.11a/b/g/n/ac  
To: FCC 47 CFR Part 15.407 & IC RSS-210  
Serial #: ARUB146-U1 Rev A  
Issue Date: 13th June 2013  
Page: 169 of 344

### Channel Move Time, Channel Closing Transmission Time for Type 1 Radar Captured by the Test System - 10 to 12 seconds

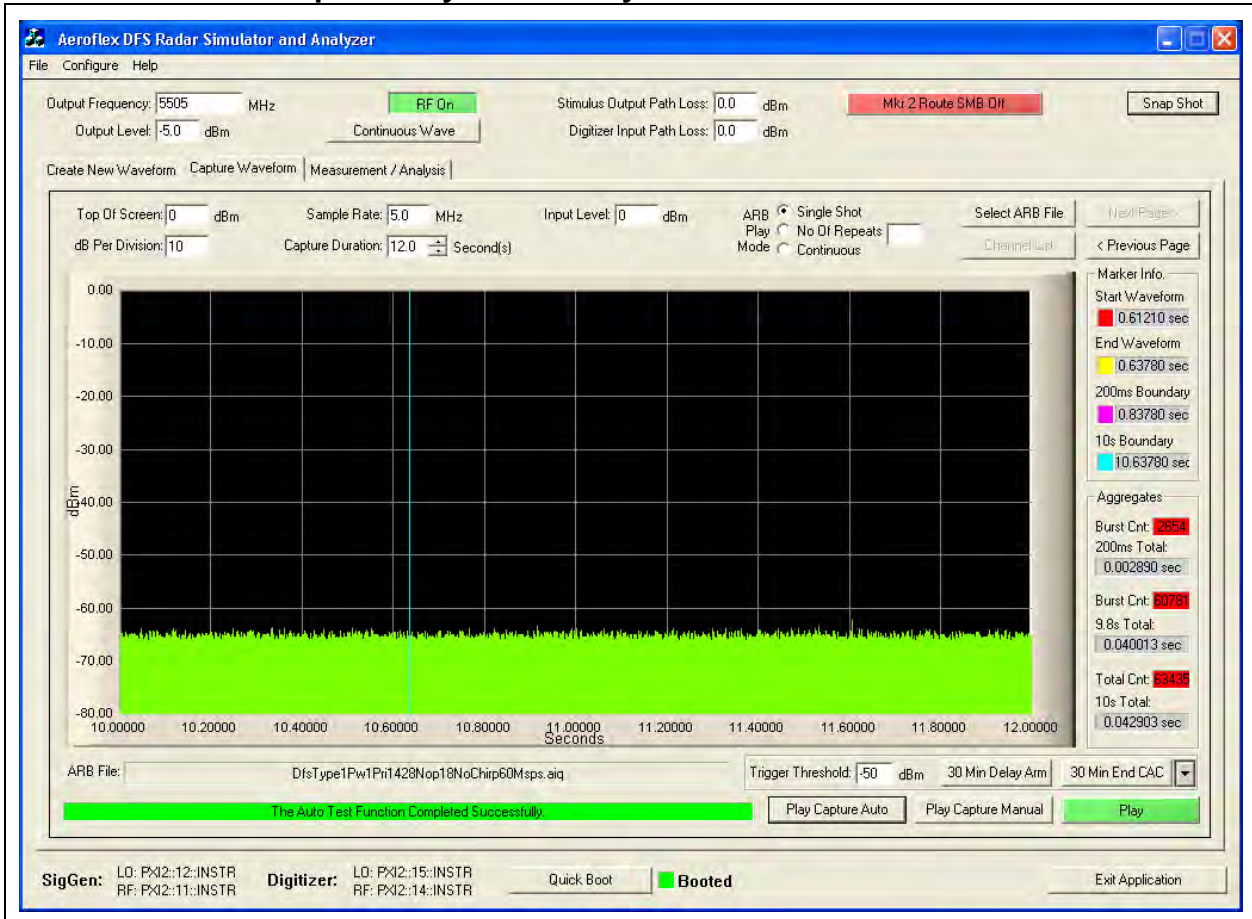

This test report may be reproduced in full only. The document may only be updated by MiCOM Labs personnel. Any changes will be noted in the Document History section of the report.



### 30 Minute Non-Occupancy Period

The EUT is monitored for more than 30 minutes following the channel close/move time to verify no transmissions resume on this Channel.

### 30 Minute Non-Occupancy Period Type 1 Radar 5,500MHz 802.11a

	Delta 1 [T1]	RBW	1 MHz	RF Att	10 dB
	Ref Lvl	-43.92 dB	VBW	1 MHz	
	-36 dBm	1.800000 ks	SWT	2000 s	Unit dBm

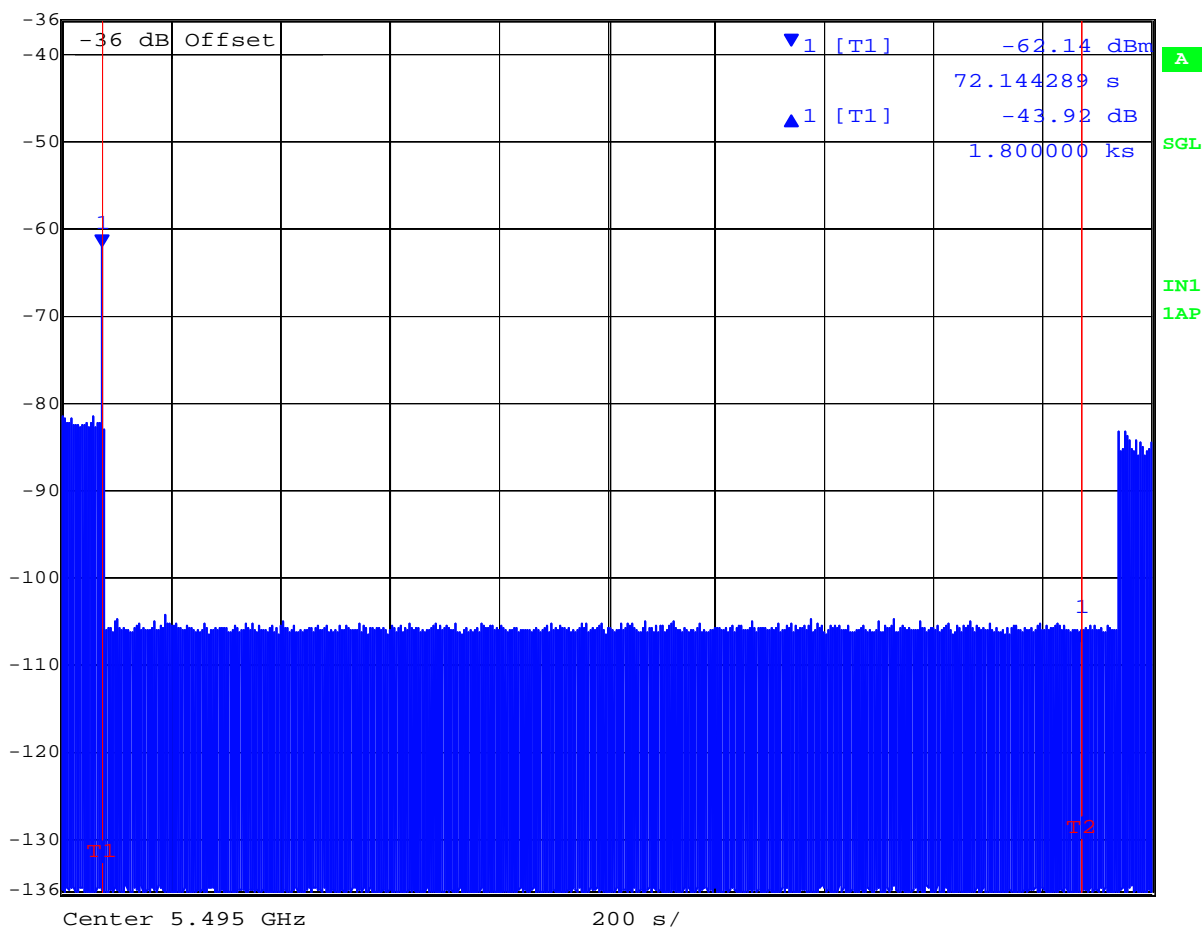

Date: 29.MAR.2013 12:27:39

This test report may be reproduced in full only. The document may only be updated by MiCOM Labs personnel. Any changes will be noted in the Document History section of the report.



Title: APIN0224, APIN0225 802.11a/b/g/n/ac  
To: FCC 47 CFR Part 15.407 & IC RSS-210  
Serial #: ARUB146-U1 Rev A  
Issue Date: 13th June 2013  
Page: 171 of 344

### 30 Minute Non-Occupancy Period Type 1 Radar 5,510 MHz 802.11n HT40

Delta 1 [T1] RBW 1 MHz RF Att 10 dB  
Ref Lvl -35.59 dB VBW 1 MHz  
-36 dBm 1.800000 ks SWT 2000 s Unit dBm

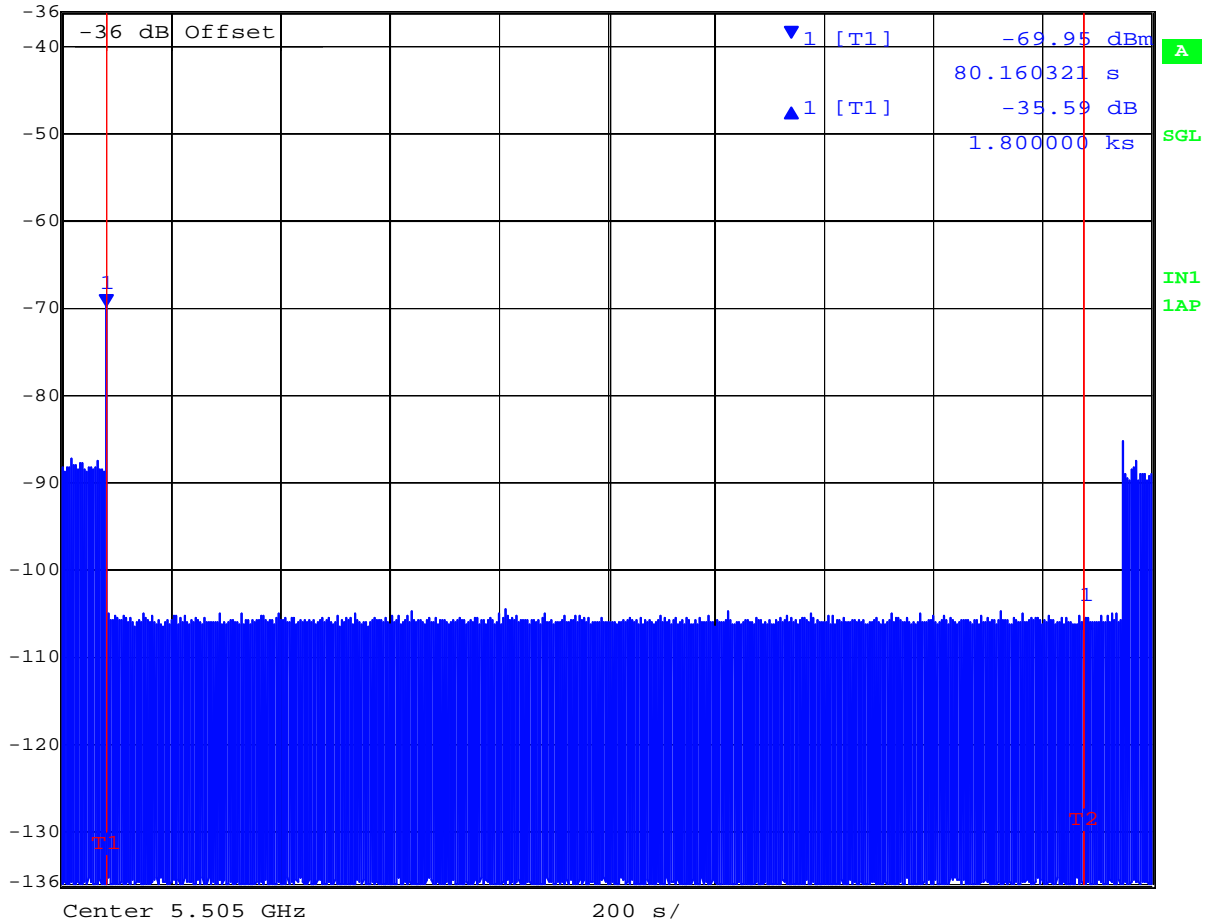

Date: 29.MAR.2013 10:19:46

This test report may be reproduced in full only. The document may only be updated by MiCOM Labs personnel. Any changes will be noted in the Document History section of the report.



**Title:** APIN0224, APIN0225 802.11a/b/g/n/ac  
**To:** FCC 47 CFR Part 15.407 & IC RSS-210  
**Serial #:** ARUB146-U1 Rev A  
**Issue Date:** 13th June 2013  
**Page:** 172 of 344

---

#### **6.1.4.6.6. Statistical Performance Check**

The steps below define the procedure to determine the minimum percentage of detection when a radar burst with a level equal to the DFS Detection Threshold is generated on the Operating Channel of the U-NII device.

A U-NII device operating as a Client Device will associate with the UUT (Master) at 5,500MHz 802.11a and 5,510MHz 802.11n HT40.

The Radar Waveform generator sends the individual waveform for each of the radar types 1-6. Statistical data will be gathered to determine the ability of the device to detect the radar test waveforms. The device can utilize a test mode to demonstrate when detection occurs to prevent the need to reset the device between trial runs. The percentage of successful detection is calculated by:

Total # of detections ÷ Total # of Trials × 100 = Probability of Detection

The Minimum number of trails, minimum percentage of successful detection and the average minimum percentage of successful detection are found in the Radar Test Waveforms section.

---

This test report may be reproduced in full only. The document may only be updated by MiCOM Labs personnel. Any changes will be noted in the Document History section of the report.



**Verification of Detection 5,500MHz (5 MHz Offset 5495MHz) 802.11a**

Trial #	Detection = √, No Detection = 0					
	Type 1	Type 2	Type 3	Type 4	Type 5	Type 6
1	√	√	√	√	√	√
2	√	√	√	√	√	√
3	√	√	0	√	√	√
4	√	√	√	√	√	√
5	√	√	√	√	√	√
6	√	√	√	√	√	√
7	√	√	√	√	√	√
8	√	√	√	√	0	√
9	√	√	√	√	√	√
10	√	√	√	√	√	√
11	√	√	√	√	√	√
12	√	√	√	√	√	√
13	√	√	√	√	0	√
14	√	√	√	√	0	√
15	√	√	√	√	√	√
16	√	√	√	√	√	√
17	√	√	√	√	√	√
18	√	√	0	√	√	√
19	√	√	√	√	√	√
20	√	√	√	√	√	√
21	√	√	√	√	√	√
22	√	√	√	√	0	0
23	√	√	√	√	√	√
24	√	√	√	√	√	√
25	√	√	√	√	√	√
26	√	√	√	√	0	√
27	√	√	√	√	√	√
28	√	√	√	√	√	√
29	√	√	√	√	√	√
30	√	√	√	√	√	√
<b>Detection Percentage</b>	100% (>60%)	100% (>60%)	93.3% (>60%)	100% (>60%)	83.3% (>80%)	96.6% (>70%)

In addition an average minimum percentage of successful detection across all four Short pulse radar test waveforms is required and calculated as follows;

$$(P_{d1} + P_{d2} + P_{d3} + P_{d4}) / 4 = (100\% + 100\% + 93.3\% + 100\%) / 4 = 98.3\% (> 80\%)$$

This test report may be reproduced in full only. The document may only be updated by MiCOM Labs personnel. Any changes will be noted in the Document History section of the report.



**Verification of Detection 5,510MHz (5 MHz Offset 5505MHz) 802.11n HT40**

Trial #	Detection = √, No Detection = 0					
	Type 1	Type 2	Type 3	Type 4	Type 5	Type 6
1	√	√	√	√	√	√
2	√	√	√	√	√	√
3	√	√	√	√	√	√
4	√	√	√	√	√	√
5	√	√	√	√	√	√
6	√	√	√	√	√	√
7	√	0	0	√	√	√
8	√	√	√	√	0	√
9	√	0	√	√	√	√
10	√	√	√	√	√	√
11	√	√	√	√	√	√
12	√	√	√	√	√	√
13	√	√	0	√	√	√
14	√	√	√	√	0	√
15	√	√	√	√	√	√
16	√	√	√	√	√	√
17	√	√	√	√	√	√
18	√	√	√	0	√	√
19	√	√	√	√	√	√
20	√	√	√	0	√	√
21	√	√	√	√	√	√
22	√	√	√	√	√	√
23	√	√	√	√	√	√
24	√	√	0	0	√	√
25	√	√	0	√	0	√
26	√	√	√	√	0	√
27	√	√	√	√	√	√
28	√	√	√	√	√	√
29	√	√	√	0	√	√
30	√	0	√	0	√	√
<b>Detection Percentage</b>	100% (>60%)	90% (>60%)	86.6% (>60%)	83.3% (>60%)	86.6% (>80%)	100% (>70%)

In addition an average minimum percentage of successful detection across all four Short pulse radar test waveforms is required and calculated as follows;

$$(P_{d1} + P_{d2} + P_{d3} + P_{d4}) / 4 = (\% + \% + \% + \%) / 4 = 89\% (> 80\%)$$

This test report may be reproduced in full only. The document may only be updated by MiCOM Labs personnel. Any changes will be noted in the Document History section of the report.



**Title:** APIN0224, APIN0225 802.11a/b/g/n/ac  
**To:** FCC 47 CFR Part 15.407 & IC RSS-210  
**Serial #:** ARUB146-U1 Rev A  
**Issue Date:** 13th June 2013  
**Page:** 175 of 344

---

**Measurement Uncertainty Time/Power**

Measurement uncertainty		
- Time		4%
- Power		1.33dB

**Traceability**

Test Equipment Used
0072, 0083, 0098, 0116, 0132, 0158, 0313, 0314, 0193, 0223, 0252, 0253, 0251, 0256, 0328, 0329

---

This test report may be reproduced in full only. The document may only be updated by MiCOM Labs personnel. Any changes will be noted in the Document History section of the report.

## 7. PHOTOGRAPHS

### 7.1. Test Setup - Conducted

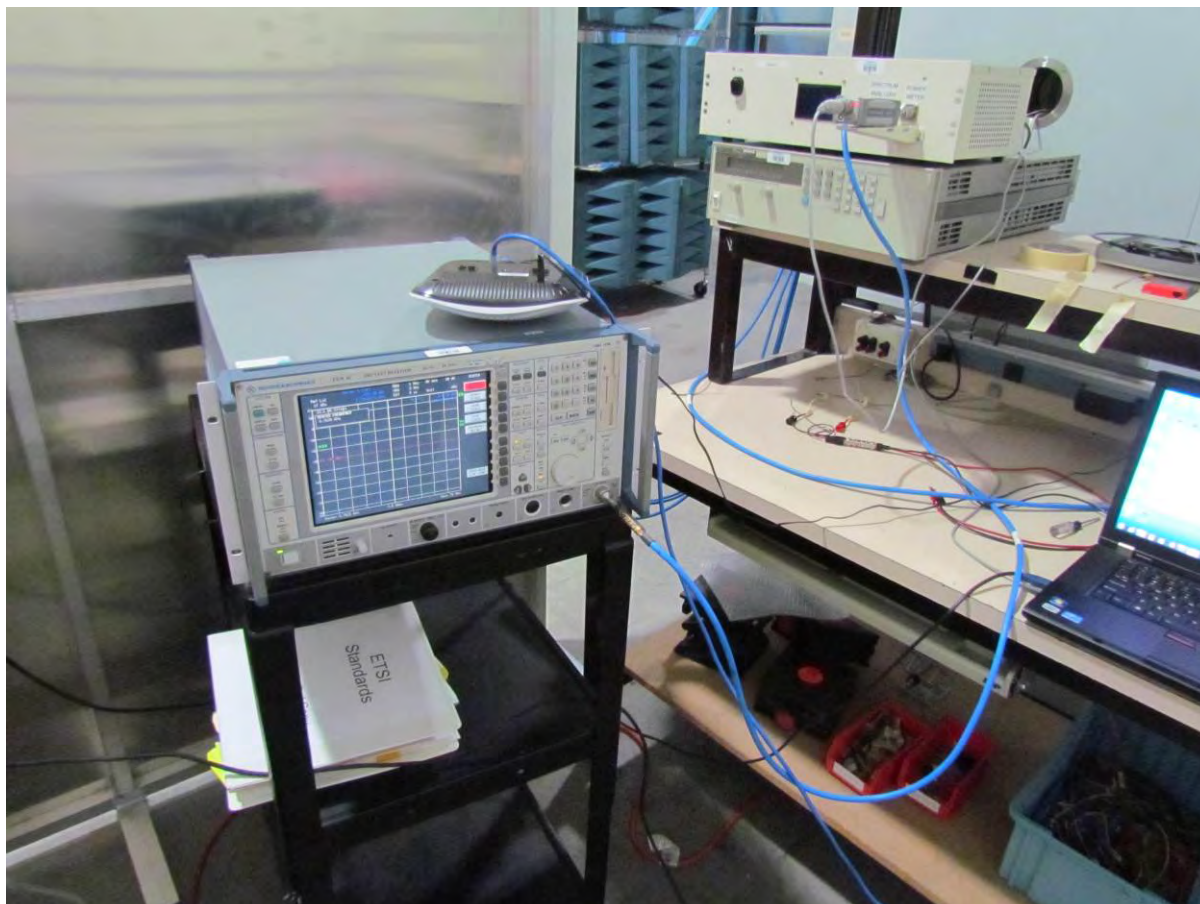

---

This test report may be reproduced in full only. The document may only be updated by MiCOM Labs personnel. Any changes will be noted in the Document History section of the report.



## 7.2. Test Setup - Digital Emissions < 1 GHz



---

This test report may be reproduced in full only. The document may only be updated by MiCOM Labs personnel. Any changes will be noted in the Document History section of the report.

### 7.3. Radiated Emissions Test Setup >1 GHz

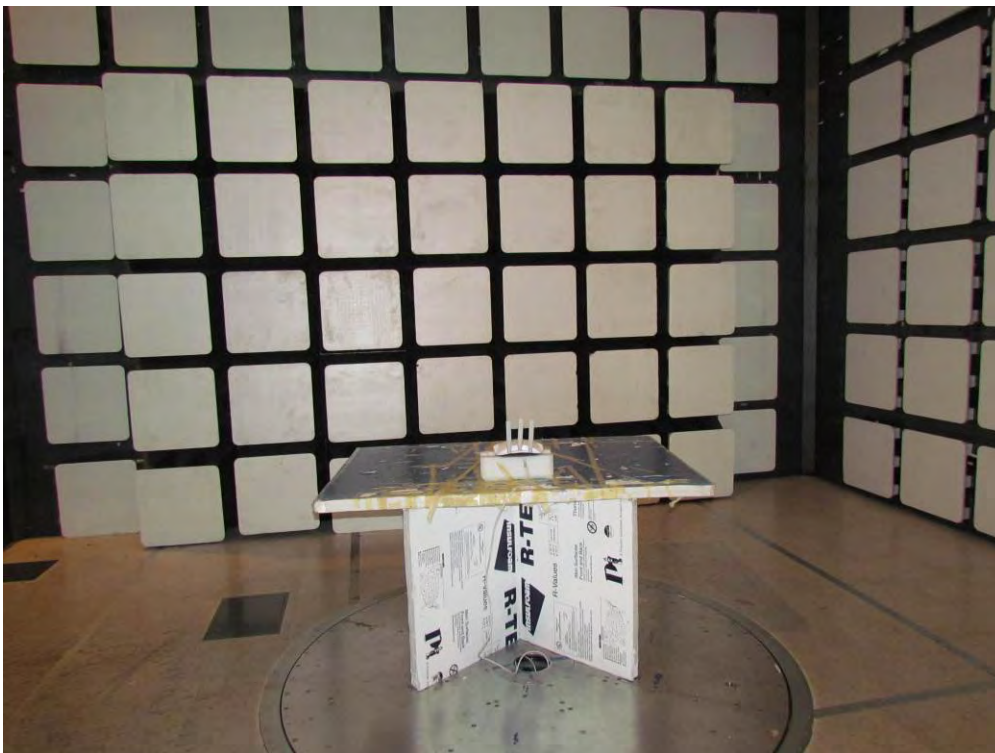

---

This test report may be reproduced in full only. The document may only be updated by MiCOM Labs personnel. Any changes will be noted in the Document History section of the report.

#### 7.4. Dynamic Frequency Selection (DFS)



---

This test report may be reproduced in full only. The document may only be updated by MiCOM Labs personnel. Any changes will be noted in the Document History section of the report.



**Title:** APIN0224, APIN0225 802.11a/b/g/n/ac  
**To:** FCC 47 CFR Part 15.407 & IC RSS-210  
**Serial #:** ARUB146-U1 Rev A  
**Issue Date:** 13th June 2013  
**Page:** 180 of 344

## 8. TEST EQUIPMENT DETAILS

Asset #	Instrument	Manufacturer	Part #	Serial #	Calibration Due Date
0070	Power Meter	Hewlett Packard	437B	3125U11552	28 <sup>th</sup> Nov 13
0117	Power Sensor	Hewlett Packard	8487D	3318A00371	15 <sup>th</sup> Nov 13
0223	Power Meter	Hewlett Packard	EPM-442A	US37480256	15 <sup>th</sup> Nov 13
0374	Power Sensor	Hewlett Packard	8485A	3318A19694	29 <sup>th</sup> Nov 13
0158	Barometer /Thermometer	Control Co.	4196	E2846	8 <sup>th</sup> Dec 13
0193	EMI Receiver	Rhode & Schwartz	ESI 7	838496/007	2 <sup>nd</sup> Dec 13
0287	EMI Receiver	Rhode & Schwartz	ESIB40	100201	16 <sup>th</sup> Nov 13
0338	30 - 3000 MHz Antenna	Sunol	JB3	A052907	8 <sup>th</sup> Nov 13
0335	1-18 GHz Horn Antenna	EMCO	3117	00066580	7 <sup>th</sup> Nov 13
0252	SMA Cable	Megaphase	Sucoflex 104	None	N/A
0293	BNC Cable	Megaphase	1689 1GVT4	15F50B001	N/A
0307	BNC Cable	Megaphase	1689 1GVT4	15F50B002	N/A
0310	2m SMA Cable	Micro-Coax	UFA210A-0-0787-3G03G0	209089-001	N/A
0312	3m SMA Cable	Micro-Coax	UFA210A-1-1181-3G0300	209092-001	N/A
0314	30dB N-Type Attenuator	ARRA	N9444-30	1623	N/A
	EMC Test Software	EMISoft	Vasona	5.0051	N/A
	RF Conducted Test Software	National Instruments	Labview	Version 8.2	N/A
	RF Conducted Test Software	MiCOM Labs ATS		Version 1.5	N/A

This test report may be reproduced in full only. The document may only be updated by MiCOM Labs personnel. Any changes will be noted in the Document History section of the report.



**Title:** APIN0224, APIN0225 802.11a/b/g/n/ac  
**To:** FCC 47 CFR Part 15.407 & IC RSS-210  
**Serial #:** ARUB146-U1 Rev A  
**Issue Date:** 13th June 2013  
**Page:** 181 of 344

---

## **APPENDIX**

### **A. SUPPORTING INFORMATION**

#### **A.1. CONDUCTED TEST PLOTS**

---

This test report may be reproduced in full only. The document may only be updated by MiCOM Labs personnel. Any changes will be noted in the Document History section of the report.



### A.1.1. 26 dB & 99% Bandwidth



#### 26 dB & 99% BANDWIDTH

Variant: 802.11a, Channel: 5260.00 MHz, Chain a, Temp: Ambient, Voltage: 12 Vdc

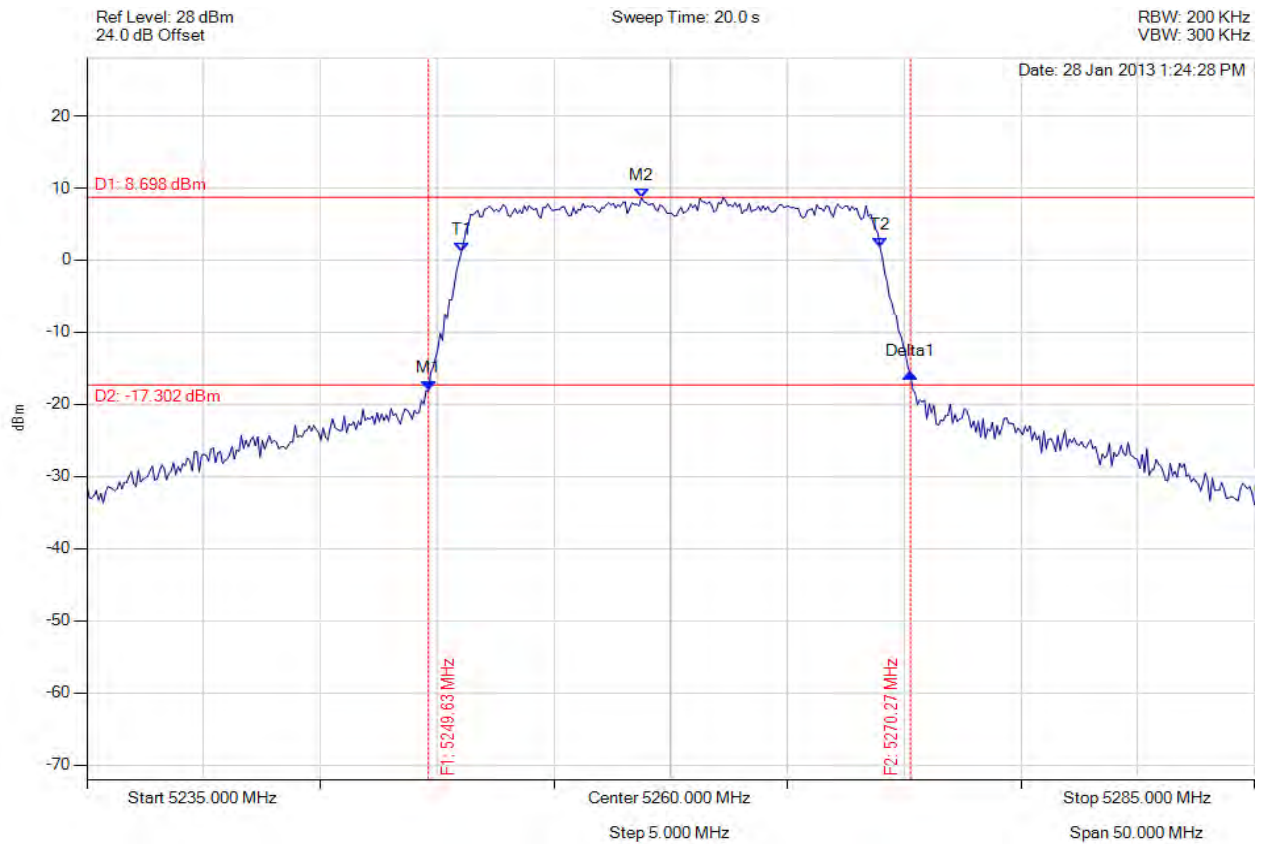

Analyser Setup	Marker : Frequency : Amplitude	Test Results
Detector = MAX PEAK Sweep Count = 0 RF Atten (dB) = 20 Trace Mode = VIEW	M1 : 5249.629 MHz : -18.087 dBm M2 : 5258.747 MHz : 8.698 dBm Delta1 : 20.641 MHz : 2.323 dB T1 : 5251.032 MHz : 1.077 dBm T2 : 5268.968 MHz : 1.730 dBm OBW : 17.936 MHz	Measured 26 dB Bandwidth: 20.641 MHz Measured 99% Bandwidth: 17.936 MHz

[Back to the Matrix](#)

This test report may be reproduced in full only. The document may only be updated by MiCOM Labs personnel. Any changes will be noted in the Document History section of the report.



**26 dB & 99% BANDWIDTH**

Variant: 802.11a, Channel: 5260.00 MHz, Chain b, Temp: Ambient, Voltage: 12 Vdc

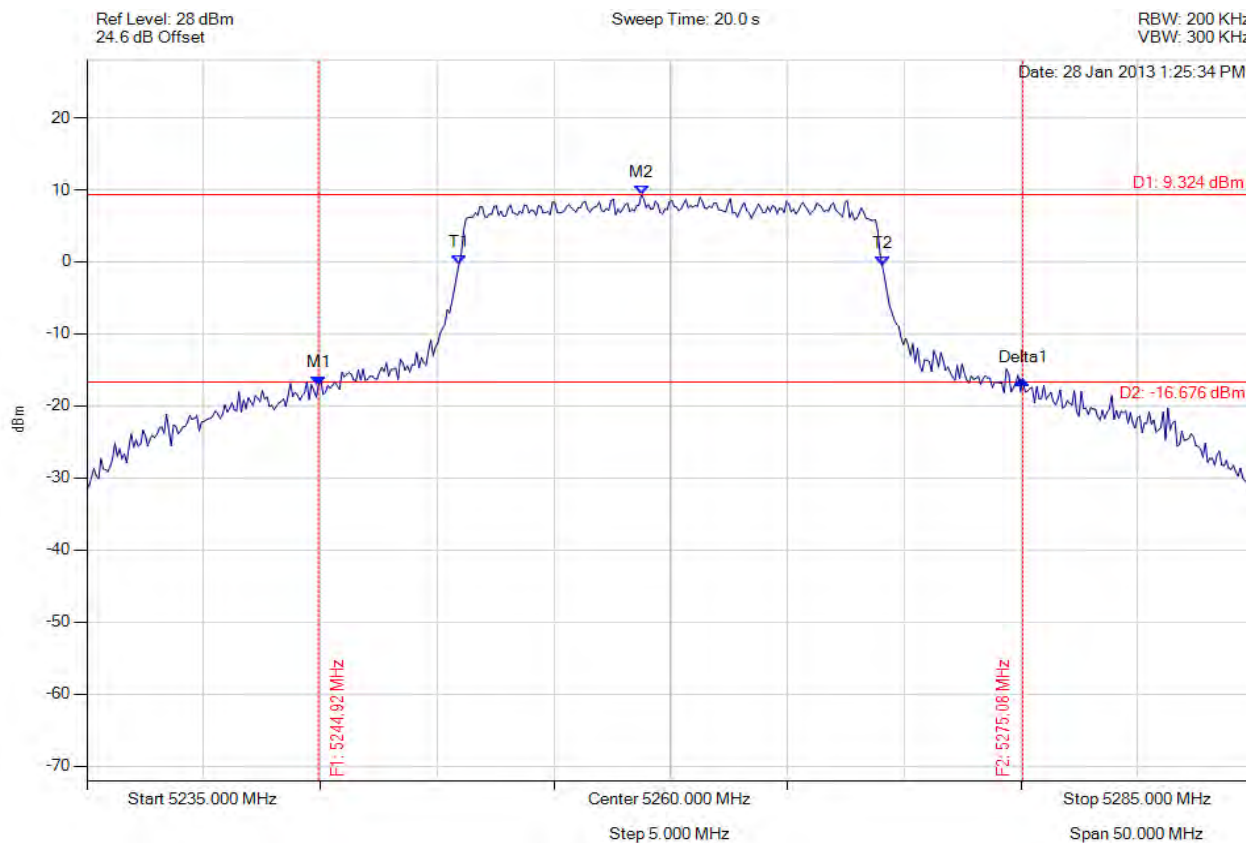

Analyser Setup	Marker : Frequency : Amplitude	Test Results
Detector = MAX PEAK Sweep Count = 0 RF Atten (dB) = 20 Trace Mode = VIEW	M1 : 5244.920 MHz : -17.139 dBm M2 : 5258.747 MHz : 9.324 dBm Delta1 : 30.160 MHz : 0.746 dB T1 : 5250.932 MHz : -0.322 dBm T2 : 5269.068 MHz : -0.601 dBm OBW : 18.136 MHz	Measured 26 dB Bandwidth: 30.160 MHz Measured 99% Bandwidth: 18.136 MHz

[Back to the Matrix](#)

This test report may be reproduced in full only. The document may only be updated by MiCOM Labs personnel. Any changes will be noted in the Document History section of the report.



**Title:** APIN0224, APIN0225 802.11a/b/g/n/ac  
**To:** FCC 47 CFR Part 15.407 & IC RSS-210  
**Serial #:** ARUB146-U1 Rev A  
**Issue Date:** 13th June 2013  
**Page:** 184 of 344



### 26 dB & 99% BANDWIDTH

Variant: 802.11a, Channel: 5260.00 MHz, Chain c, Temp: Ambient, Voltage: 12 Vdc

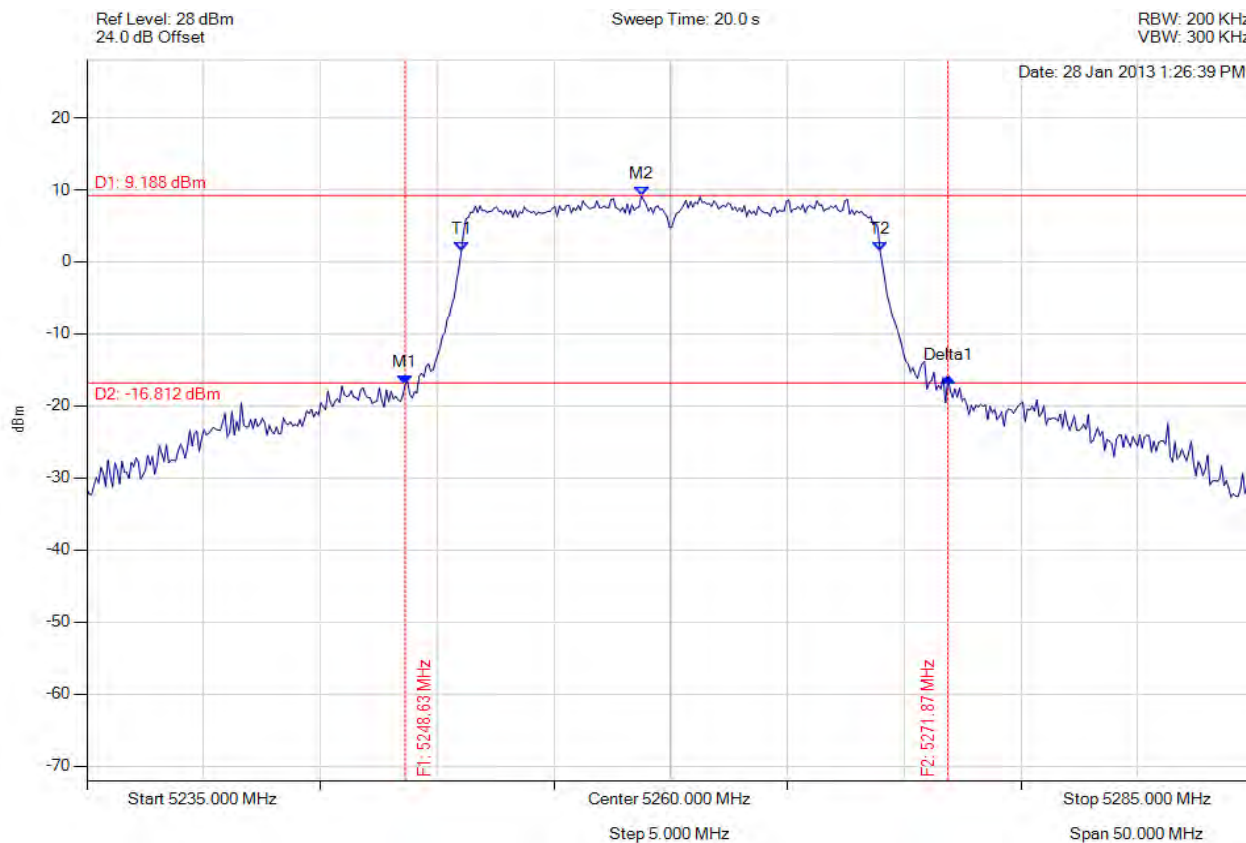

Analyser Setup	Marker : Frequency : Amplitude	Test Results
Detector = MAX PEAK Sweep Count = 0 RF Atten (dB) = 20 Trace Mode = VIEW	M1 : 5248.627 MHz : -17.123 dBm M2 : 5258.747 MHz : 9.188 dBm Delta1 : 23.246 MHz : 1.088 dB T1 : 5251.032 MHz : 1.443 dBm T2 : 5268.968 MHz : 1.478 dBm OBW : 17.936 MHz	Measured 26 dB Bandwidth: 23.246 MHz Measured 99% Bandwidth: 17.936 MHz

[Back to the Matrix](#)

This test report may be reproduced in full only. The document may only be updated by MiCOM Labs personnel. Any changes will be noted in the Document History section of the report.





**26 dB & 99% BANDWIDTH**

Variant: 802.11a, Channel: 5300.00 MHz, Chain a, Temp: Ambient, Voltage: 12 Vdc

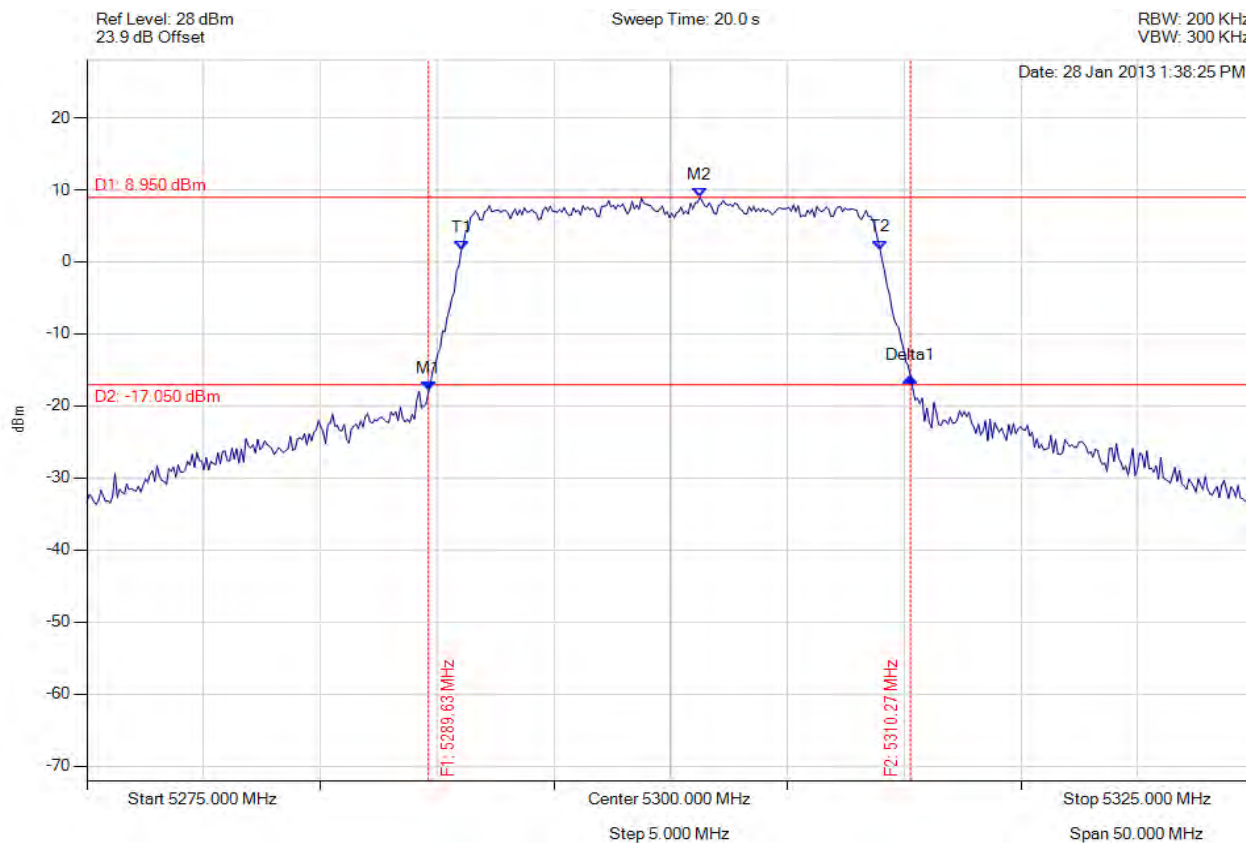

Analyser Setup	Marker : Frequency : Amplitude	Test Results
Detector = MAX PEAK Sweep Count = 0 RF Atten (dB) = 20 Trace Mode = VIEW	M1 : 5289.629 MHz : -17.959 dBm M2 : 5301.253 MHz : 8.950 dBm Delta1 : 20.641 MHz : 1.973 dB T1 : 5291.032 MHz : 1.580 dBm T2 : 5308.968 MHz : 1.708 dBm OBW : 17.936 MHz	Measured 26 dB Bandwidth: 20.641 MHz Measured 99% Bandwidth: 17.936 MHz

[Back to the Matrix](#)

This test report may be reproduced in full only. The document may only be updated by MiCOM Labs personnel. Any changes will be noted in the Document History section of the report.



**Title:** APIN0224, APIN0225 802.11a/b/g/n/ac  
**To:** FCC 47 CFR Part 15.407 & IC RSS-210  
**Serial #:** ARUB146-U1 Rev A  
**Issue Date:** 13th June 2013  
**Page:** 186 of 344



### 26 dB & 99% BANDWIDTH

Variant: 802.11a, Channel: 5300.00 MHz, Chain b, Temp: Ambient, Voltage: 12 Vdc

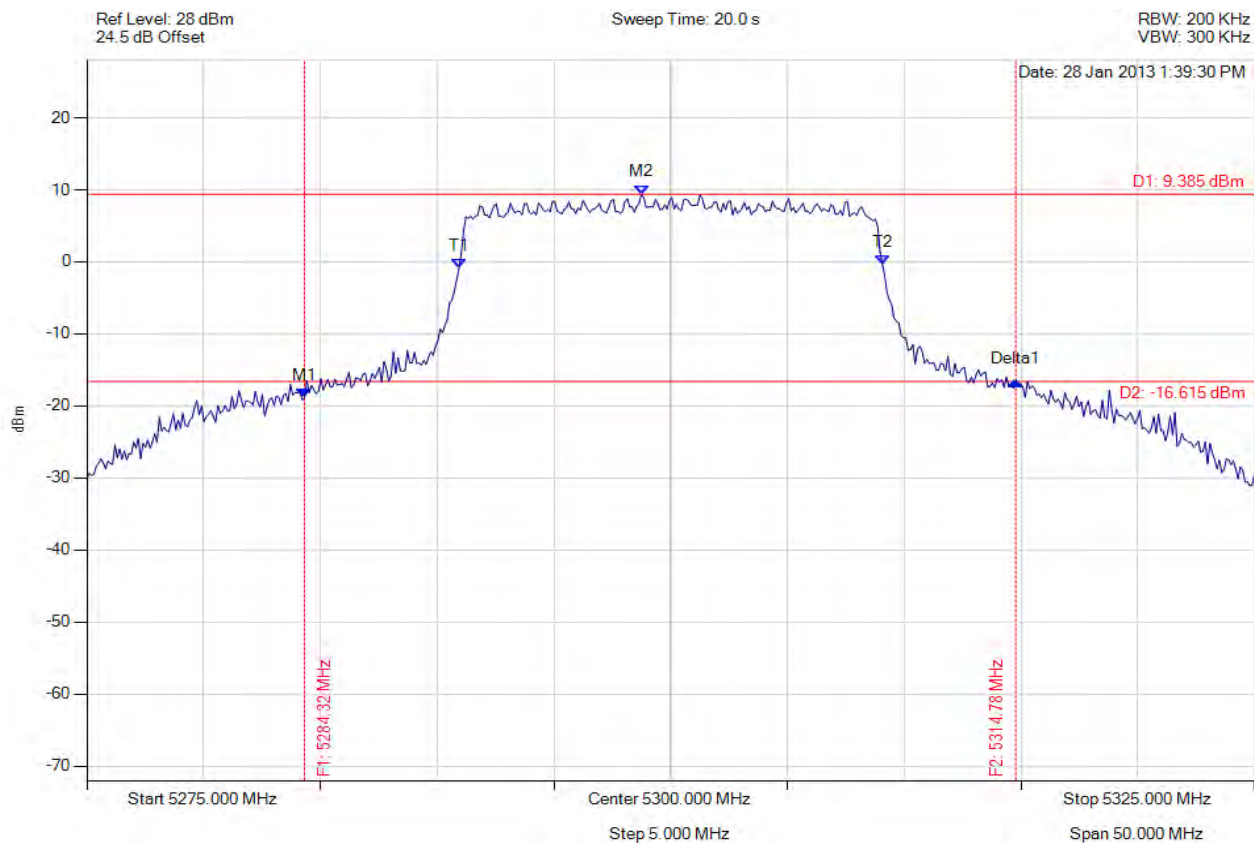

Analyser Setup	Marker : Frequency : Amplitude	Test Results
Detector = MAX PEAK Sweep Count = 0 RF Atten (dB) = 20 Trace Mode = VIEW	M1 : 5284.319 MHz : -18.870 dBm M2 : 5298.747 MHz : 9.385 dBm Delta1 : 30.461 MHz : 2.390 dB T1 : 5290.932 MHz : -0.934 dBm T2 : 5309.068 MHz : -0.361 dBm OBW : 18.136 MHz	Measured 26 dB Bandwidth: 30.461 MHz Measured 99% Bandwidth: 18.136 MHz

[Back to the Matrix](#)

This test report may be reproduced in full only. The document may only be updated by MiCOM Labs personnel. Any changes will be noted in the Document History section of the report.



**Title:** APIN0224, APIN0225 802.11a/b/g/n/ac  
**To:** FCC 47 CFR Part 15.407 & IC RSS-210  
**Serial #:** ARUB146-U1 Rev A  
**Issue Date:** 13th June 2013  
**Page:** 187 of 344



**26 dB & 99% BANDWIDTH**

Variant: 802.11a, Channel: 5300.00 MHz, Chain c, Temp: Ambient, Voltage: 12 Vdc

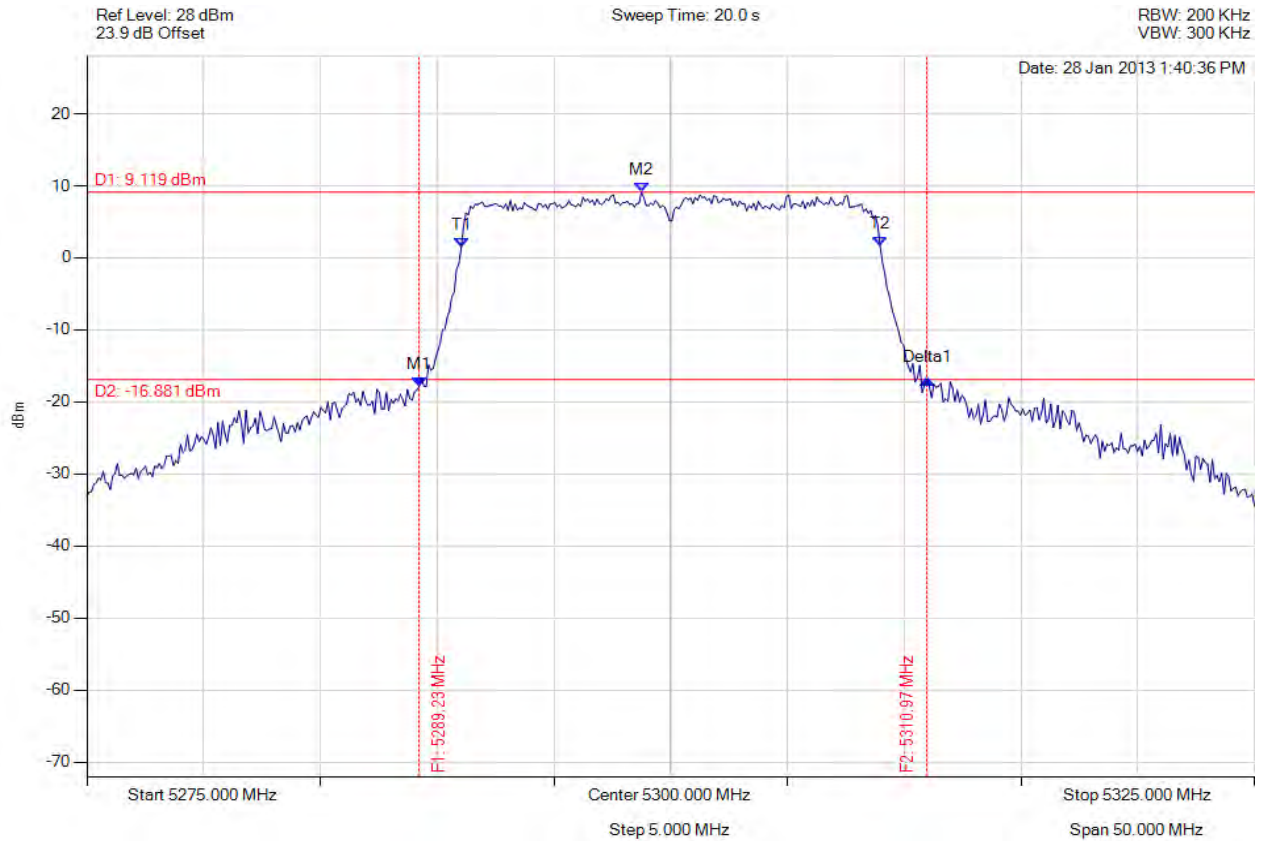

Analyser Setup	Marker : Frequency : Amplitude	Test Results
Detector = MAX PEAK Sweep Count = 0 RF Atten (dB) = 20 Trace Mode = VIEW	M1 : 5289.228 MHz : -17.824 dBm M2 : 5298.747 MHz : 9.119 dBm Delta1 : 21.743 MHz : 0.946 dB T1 : 5291.032 MHz : 1.447 dBm T2 : 5308.968 MHz : 1.620 dBm OBW : 17.936 MHz	Measured 26 dB Bandwidth: 21.743 MHz Measured 99% Bandwidth: 17.936 MHz

[Back to the Matrix](#)

This test report may be reproduced in full only. The document may only be updated by MiCOM Labs personnel. Any changes will be noted in the Document History section of the report.



**Title:** APIN0224, APIN0225 802.11a/b/g/n/ac  
**To:** FCC 47 CFR Part 15.407 & IC RSS-210  
**Serial #:** ARUB146-U1 Rev A  
**Issue Date:** 13th June 2013  
**Page:** 188 of 344



**26 dB & 99% BANDWIDTH**

Variant: 802.11a, Channel: 5320.00 MHz, Chain a, Temp: Ambient, Voltage: 12 Vdc

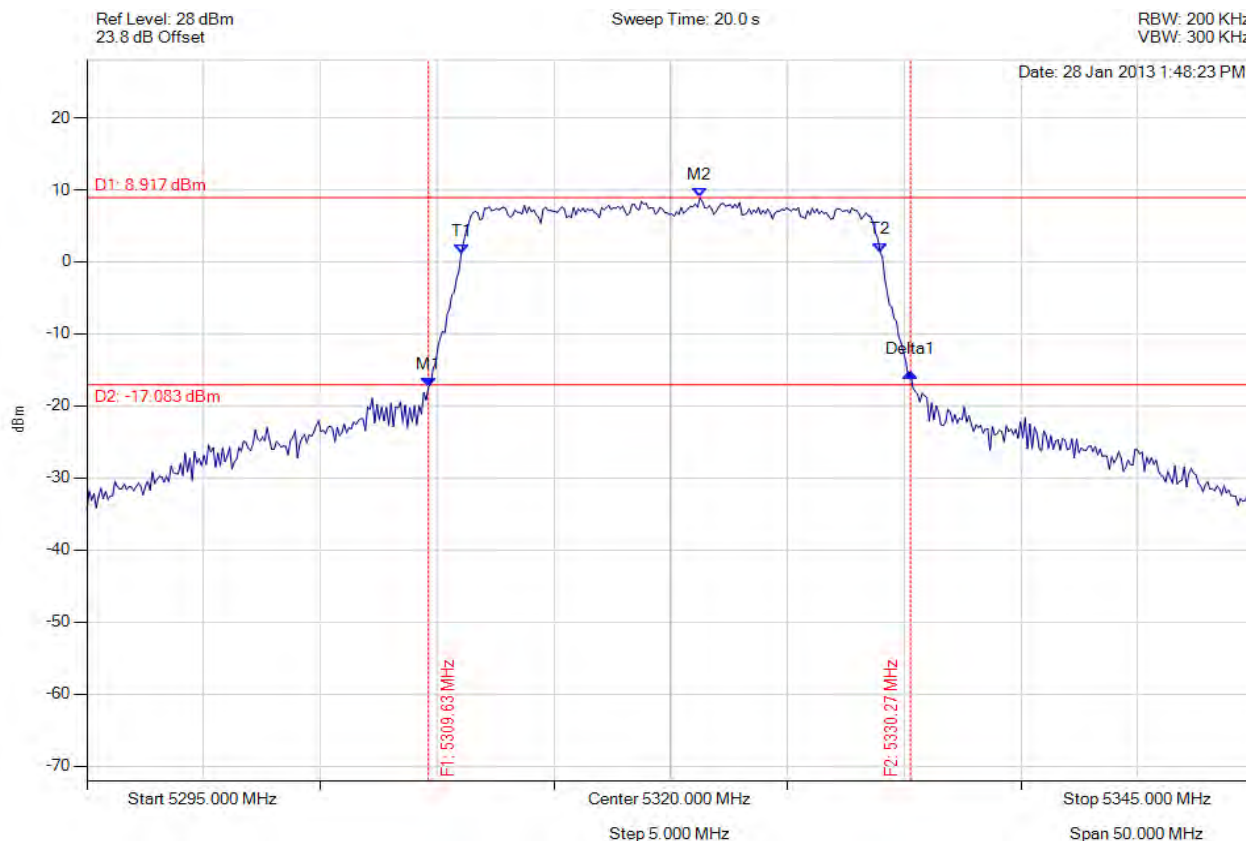

Analyser Setup	Marker : Frequency : Amplitude	Test Results
Detector = MAX PEAK Sweep Count = 0 RF Atten (dB) = 20 Trace Mode = VIEW	M1 : 5309.629 MHz : -17.322 dBm M2 : 5321.253 MHz : 8.917 dBm Delta1 : 20.641 MHz : 2.030 dB T1 : 5311.032 MHz : 1.183 dBm T2 : 5328.968 MHz : 1.378 dBm OBW : 17.936 MHz	Measured 26 dB Bandwidth: 20.641 MHz Measured 99% Bandwidth: 17.936 MHz

[Back to the Matrix](#)

This test report may be reproduced in full only. The document may only be updated by MiCOM Labs personnel. Any changes will be noted in the Document History section of the report.



**26 dB & 99% BANDWIDTH**

Variant: 802.11a, Channel: 5320.00 MHz, Chain b, Temp: Ambient, Voltage: 12 Vdc

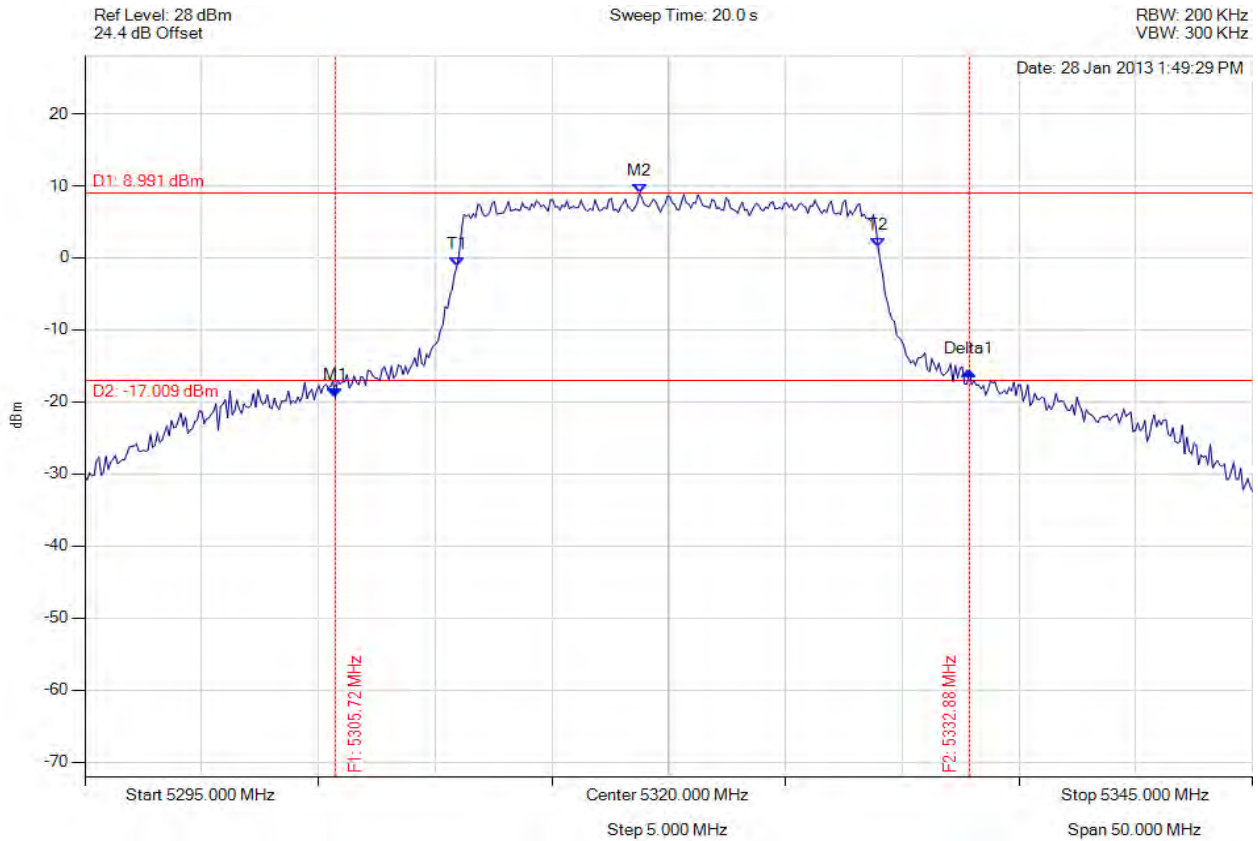

Analyser Setup	Marker : Frequency : Amplitude	Test Results
Detector = MAX PEAK Sweep Count = 0 RF Atten (dB) = 20 Trace Mode = VIEW	M1 : 5305.721 MHz : -19.455 dBm M2 : 5318.747 MHz : 8.991 dBm Delta1 : 27.154 MHz : 3.693 dB T1 : 5310.932 MHz : -1.196 dBm T2 : 5328.968 MHz : 1.508 dBm OBW : 18.036 MHz	Measured 26 dB Bandwidth: 27.154 MHz Measured 99% Bandwidth: 18.036 MHz

[Back to the Matrix](#)

This test report may be reproduced in full only. The document may only be updated by MiCOM Labs personnel. Any changes will be noted in the Document History section of the report.



**Title:** APIN0224, APIN0225 802.11a/b/g/n/ac  
**To:** FCC 47 CFR Part 15.407 & IC RSS-210  
**Serial #:** ARUB146-U1 Rev A  
**Issue Date:** 13th June 2013  
**Page:** 190 of 344



**26 dB & 99% BANDWIDTH**

Variant: 802.11a, Channel: 5320.00 MHz, Chain c, Temp: Ambient, Voltage: 12 Vdc

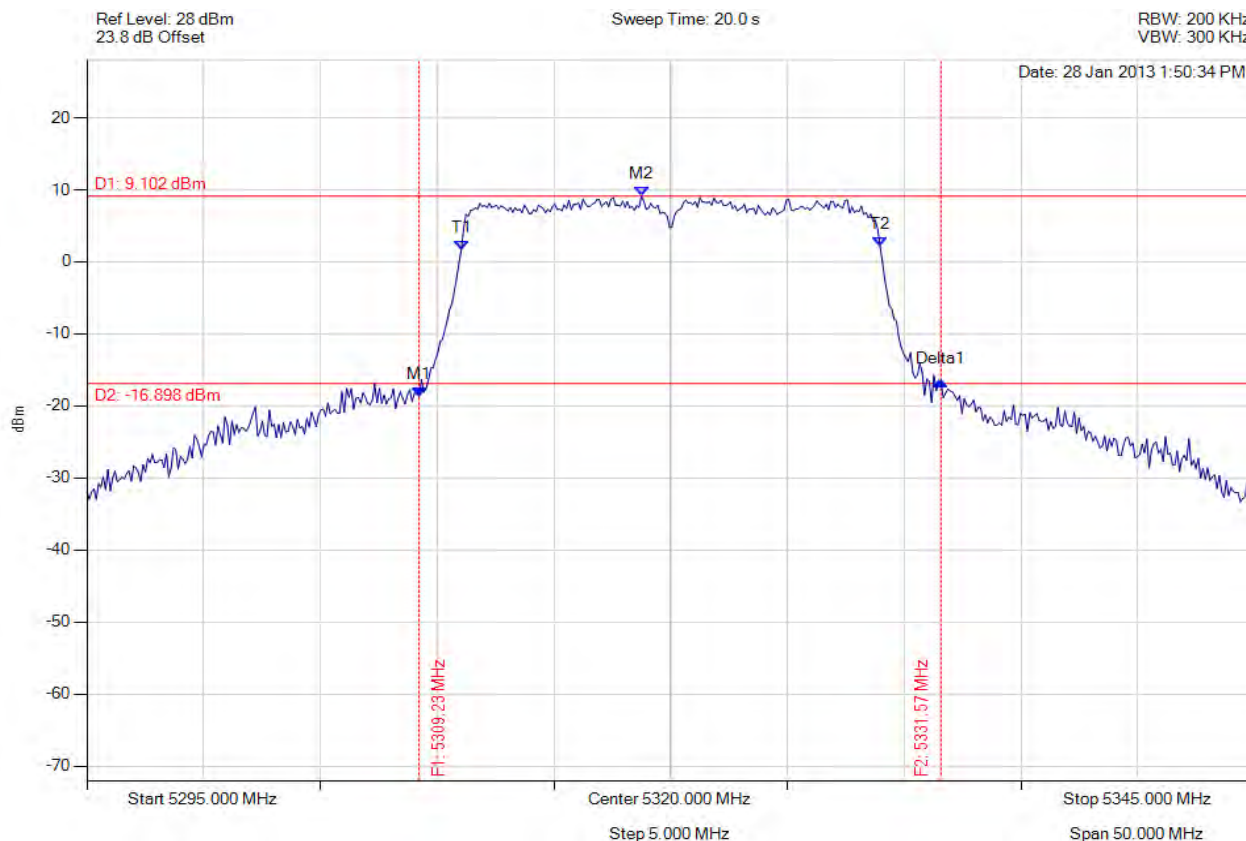

Analyser Setup	Marker : Frequency : Amplitude	Test Results
Detector = MAX PEAK Sweep Count = 0 RF Atten (dB) = 20 Trace Mode = VIEW	M1 : 5309.228 MHz : -18.683 dBm M2 : 5318.747 MHz : 9.102 dBm Delta1 : 22.345 MHz : 2.107 dB T1 : 5311.032 MHz : 1.657 dBm T2 : 5328.968 MHz : 2.123 dBm OBW : 17.936 MHz	Measured 26 dB Bandwidth: 22.345 MHz Measured 99% Bandwidth: 17.936 MHz

[Back to the Matrix](#)

This test report may be reproduced in full only. The document may only be updated by MiCOM Labs personnel. Any changes will be noted in the Document History section of the report.



**26 dB & 99% BANDWIDTH**

Variant: 802.11n HT-20, Channel: 5260.00 MHz, Chain a, Temp: Ambient, Voltage: 12 Vdc

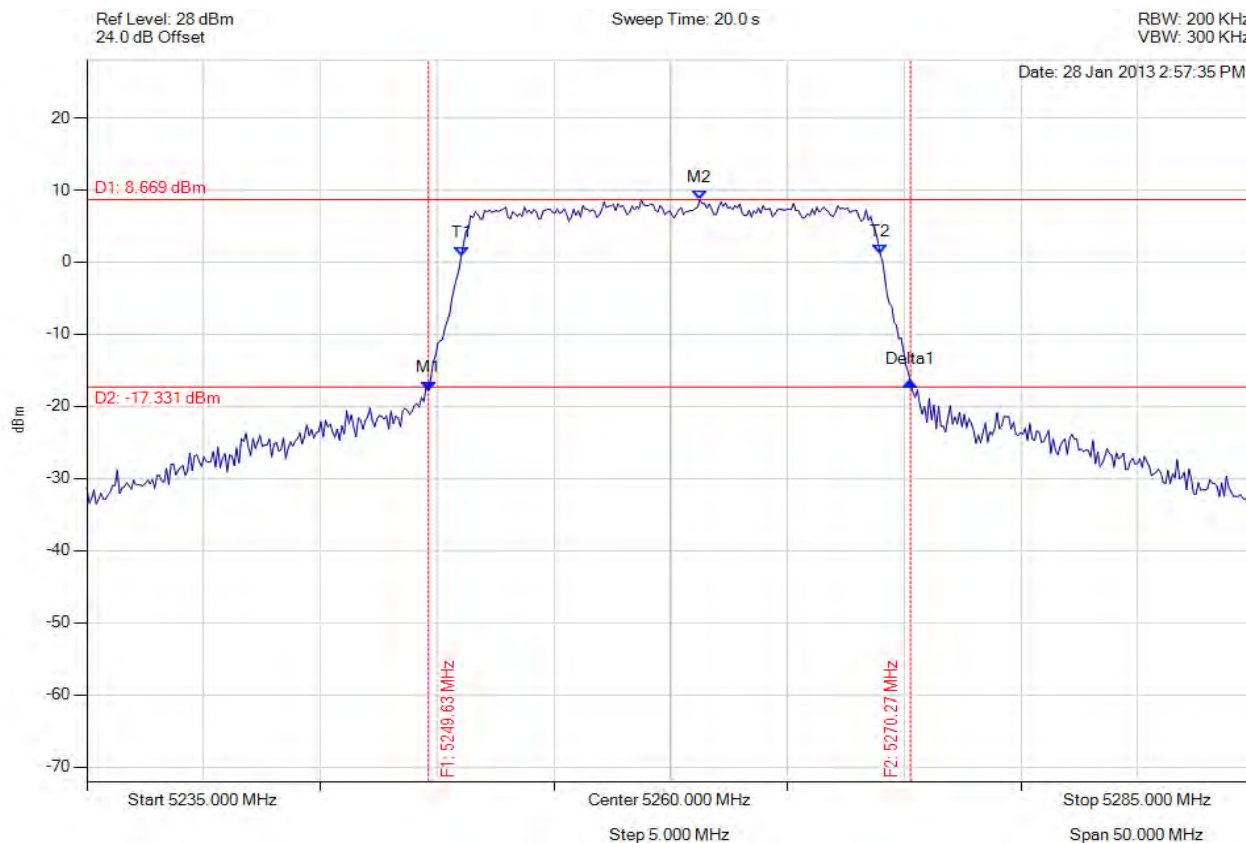

Analyser Setup	Marker : Frequency : Amplitude	Test Results
Detector = MAX PEAK Sweep Count = 0 RF Atten (dB) = 20 Trace Mode = VIEW	M1 : 5249.629 MHz : -17.798 dBm M2 : 5261.253 MHz : 8.669 dBm Delta1 : 20.641 MHz : 1.196 dB T1 : 5251.032 MHz : 0.886 dBm T2 : 5268.968 MHz : 1.199 dBm OBW : 17.936 MHz	Measured 26 dB Bandwidth: 20.641 MHz Measured 99% Bandwidth: 17.936 MHz

[Back to the Matrix](#)

This test report may be reproduced in full only. The document may only be updated by MiCOM Labs personnel. Any changes will be noted in the Document History section of the report.



**26 dB & 99% BANDWIDTH**

Variant: 802.11n HT-20, Channel: 5260.00 MHz, Chain b, Temp: Ambient, Voltage: 12 Vdc

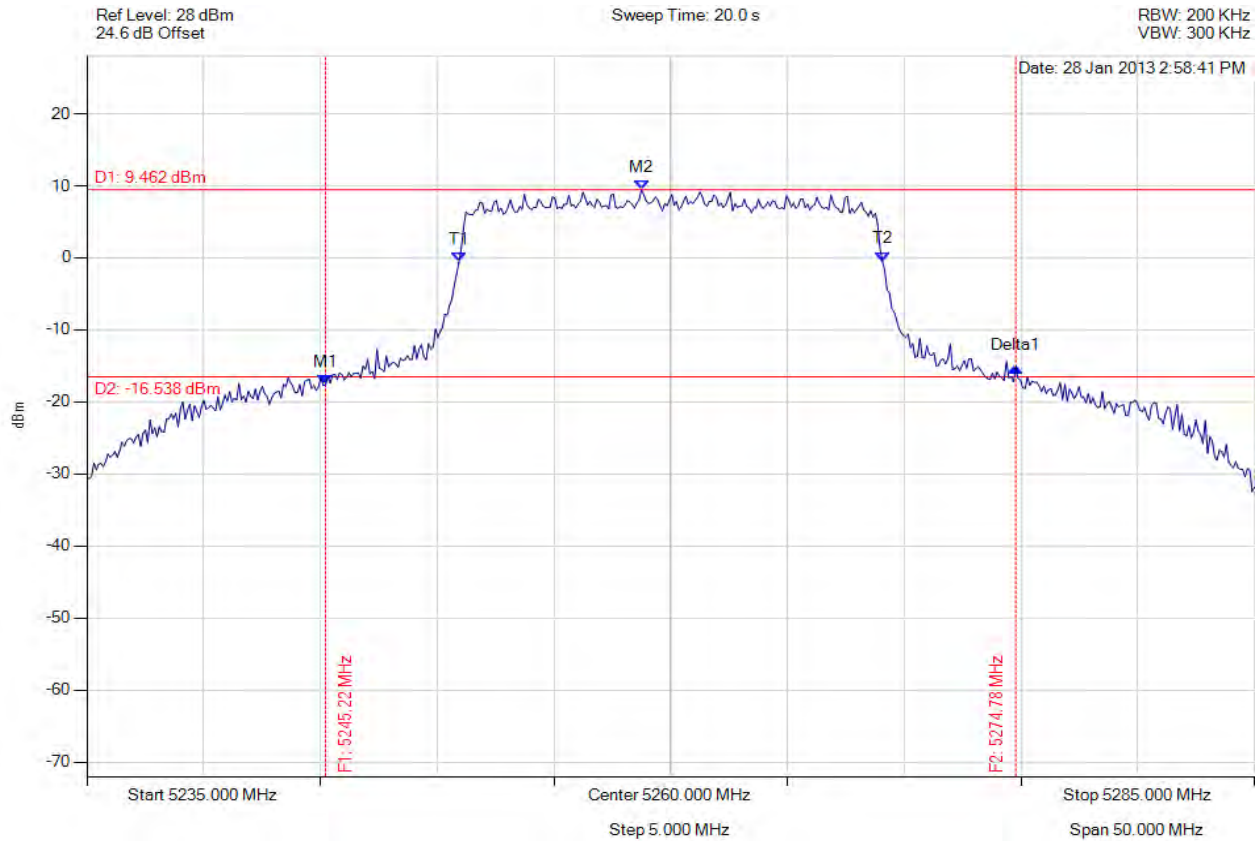

Analyser Setup	Marker : Frequency : Amplitude	Test Results
Detector = MAX PEAK Sweep Count = 0 RF Atten (dB) = 20 Trace Mode = VIEW	M1 : 5245.220 MHz : -17.623 dBm M2 : 5258.747 MHz : 9.462 dBm Delta1 : 29.559 MHz : 2.426 dB T1 : 5250.932 MHz : -0.592 dBm T2 : 5269.068 MHz : -0.460 dBm OBW : 18.136 MHz	Measured 26 dB Bandwidth: 29.559 MHz Measured 99% Bandwidth: 18.136 MHz

[Back to the Matrix](#)

This test report may be reproduced in full only. The document may only be updated by MiCOM Labs personnel. Any changes will be noted in the Document History section of the report.





**26 dB & 99% BANDWIDTH**

Variant: 802.11n HT-20, Channel: 5260.00 MHz, Chain c, Temp: Ambient, Voltage: 12 Vdc

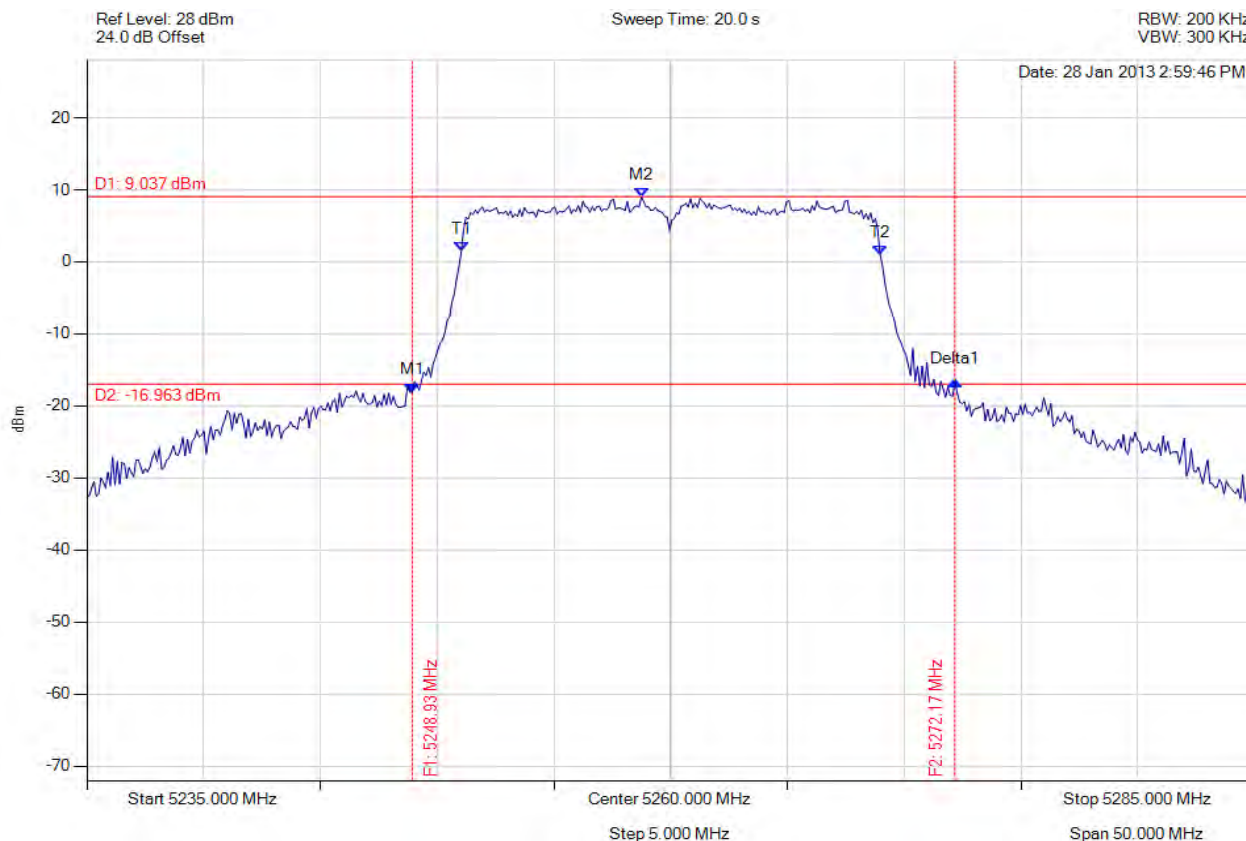

Analyser Setup	Marker : Frequency : Amplitude	Test Results
Detector = MAX PEAK Sweep Count = 0 RF Atten (dB) = 20 Trace Mode = VIEW	M1 : 5248.928 MHz : -18.131 dBm M2 : 5258.747 MHz : 9.037 dBm Delta1 : 23.246 MHz : 1.576 dB T1 : 5251.032 MHz : 1.388 dBm T2 : 5268.968 MHz : 0.984 dBm OBW : 17.936 MHz	Measured 26 dB Bandwidth: 23.246 MHz Measured 99% Bandwidth: 17.936 MHz

[Back to the Matrix](#)

This test report may be reproduced in full only. The document may only be updated by MiCOM Labs personnel. Any changes will be noted in the Document History section of the report.



**26 dB & 99% BANDWIDTH**

Variant: 802.11n HT-20, Channel: 5300.00 MHz, Chain a, Temp: Ambient, Voltage: 12 Vdc

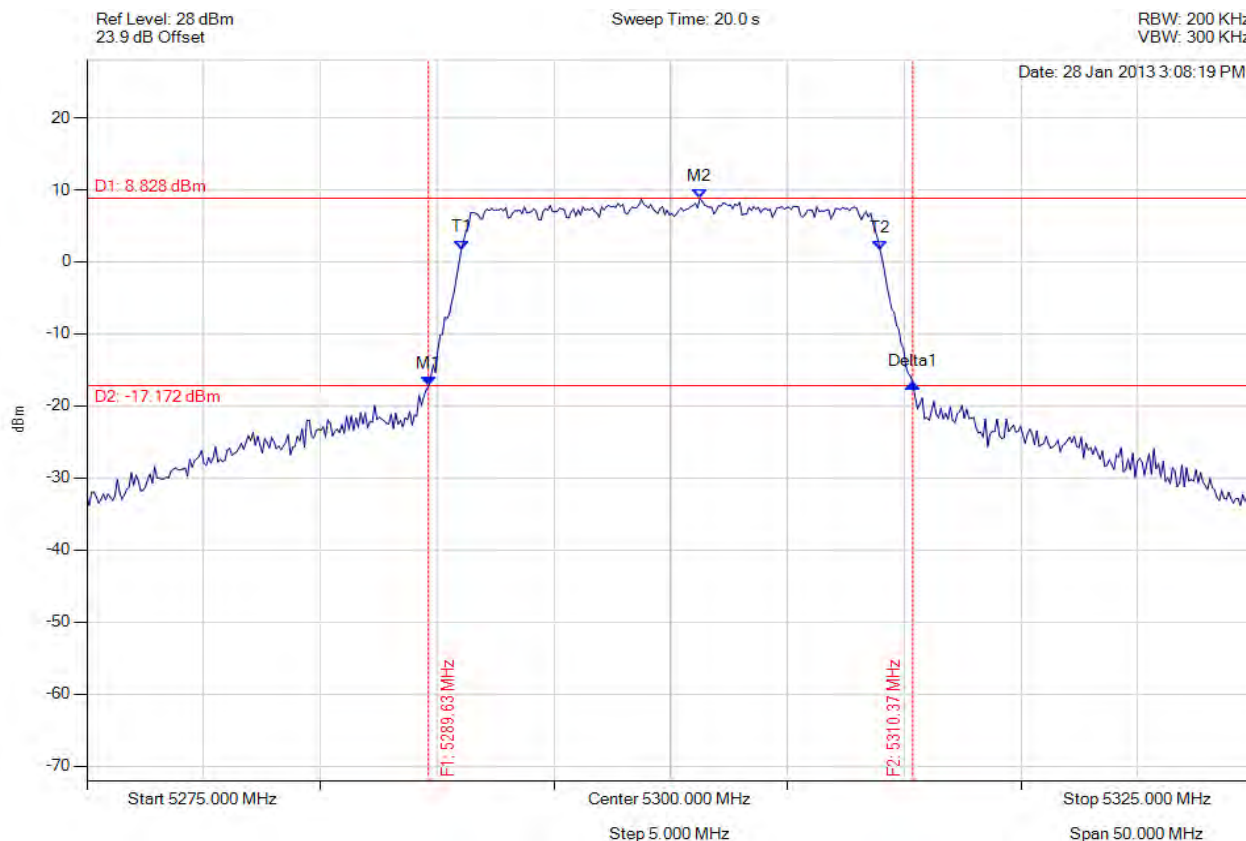

Analyser Setup	Marker : Frequency : Amplitude	Test Results
Detector = MAX PEAK Sweep Count = 0 RF Atten (dB) = 20 Trace Mode = VIEW	M1 : 5289.629 MHz : -17.257 dBm M2 : 5301.253 MHz : 8.828 dBm Delta1 : 20.741 MHz : 0.403 dB T1 : 5291.032 MHz : 1.714 dBm T2 : 5308.968 MHz : 1.600 dBm OBW : 17.936 MHz	Measured 26 dB Bandwidth: 20.741 MHz Measured 99% Bandwidth: 17.936 MHz

[Back to the Matrix](#)

This test report may be reproduced in full only. The document may only be updated by MiCOM Labs personnel. Any changes will be noted in the Document History section of the report.



**26 dB & 99% BANDWIDTH**

Variant: 802.11n HT-20, Channel: 5300.00 MHz, Chain b, Temp: Ambient, Voltage: 12 Vdc

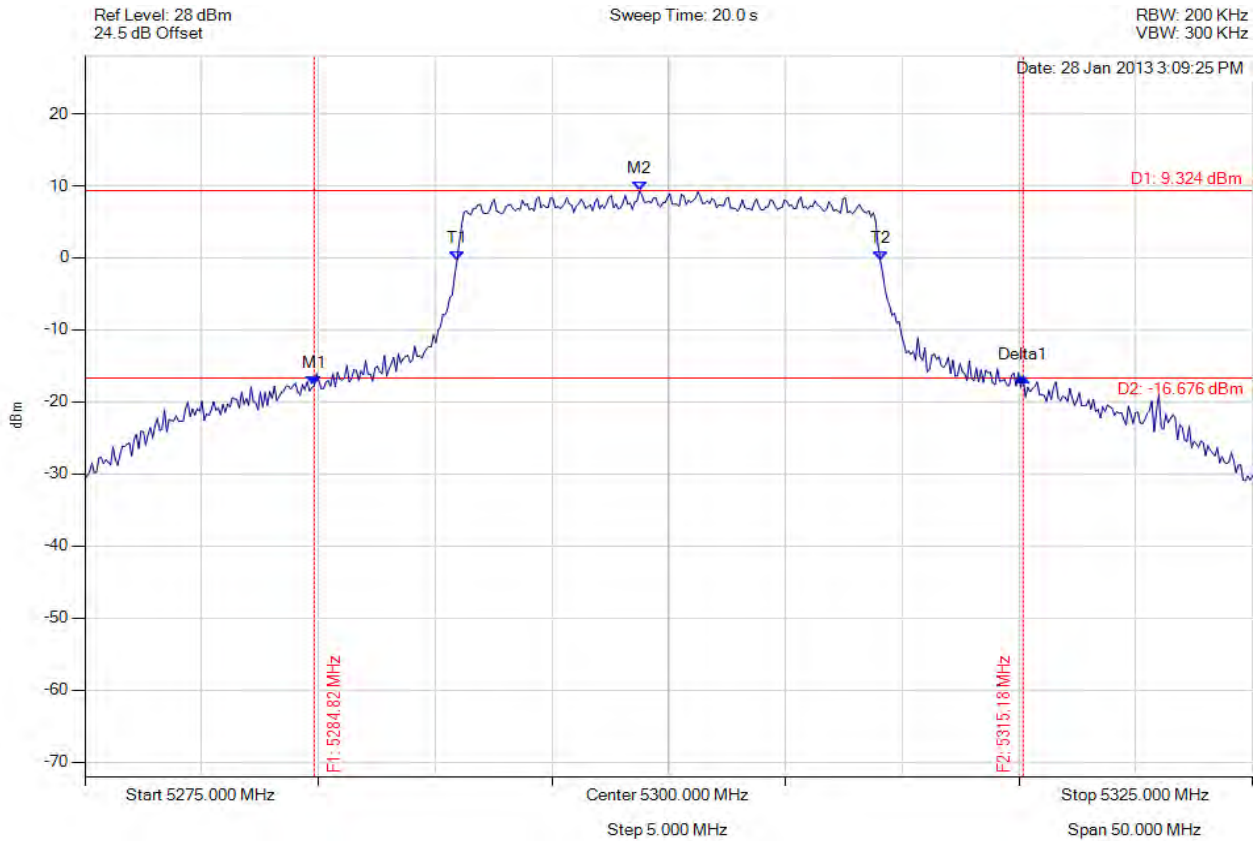

Analyser Setup	Marker : Frequency : Amplitude	Test Results
Detector = MAX PEAK Sweep Count = 0 RF Atten (dB) = 20 Trace Mode = VIEW	M1 : 5284.820 MHz : -17.751 dBm M2 : 5298.747 MHz : 9.324 dBm Delta1 : 30.361 MHz : 1.165 dB T1 : 5290.932 MHz : -0.397 dBm T2 : 5309.068 MHz : -0.442 dBm OBW : 18.136 MHz	Measured 26 dB Bandwidth: 30.361 MHz Measured 99% Bandwidth: 18.136 MHz

[Back to the Matrix](#)

This test report may be reproduced in full only. The document may only be updated by MiCOM Labs personnel. Any changes will be noted in the Document History section of the report.

**26 dB & 99% BANDWIDTH**

Variant: 802.11n HT-20, Channel: 5300.00 MHz, Chain c, Temp: Ambient, Voltage: 12 Vdc

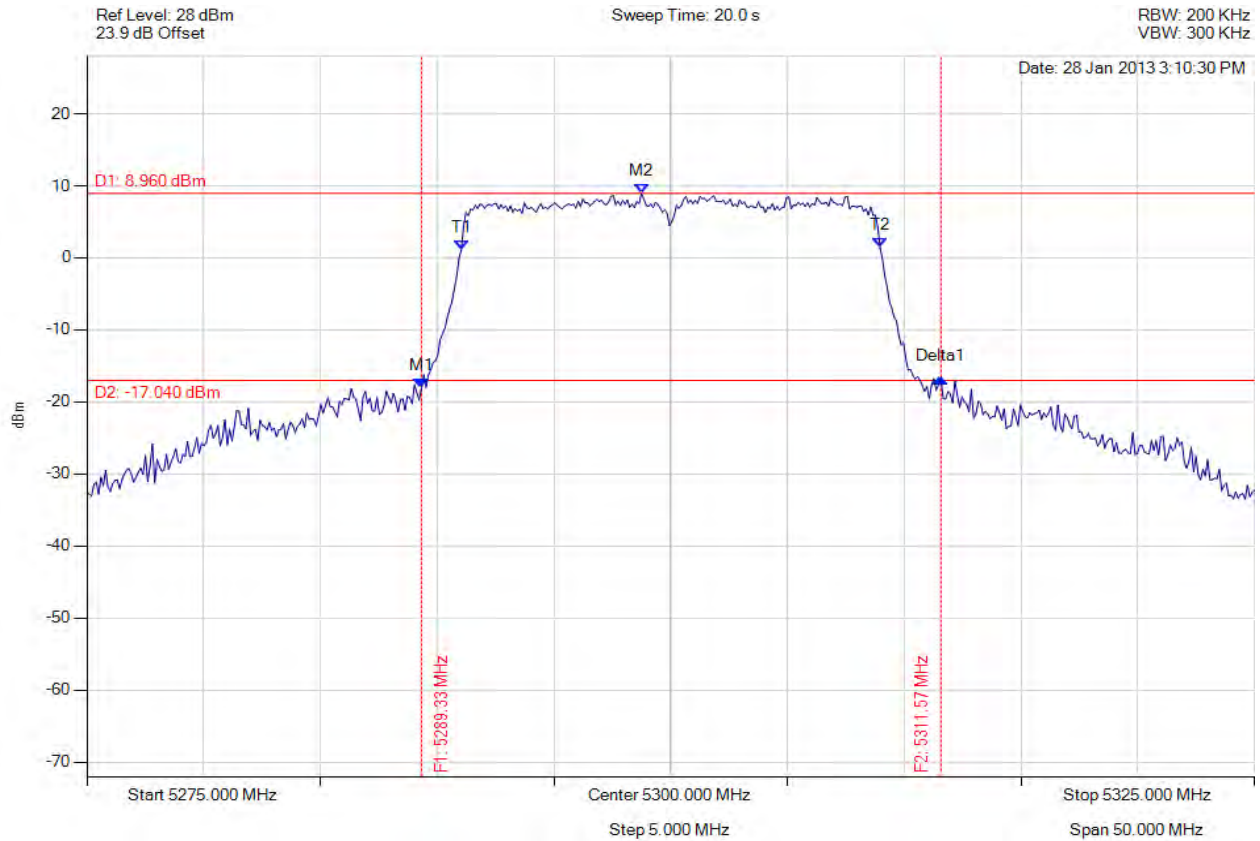

Analyser Setup	Marker : Frequency : Amplitude	Test Results
Detector = MAX PEAK Sweep Count = 0 RF Atten (dB) = 20 Trace Mode = VIEW	M1 : 5289.329 MHz : -18.115 dBm M2 : 5298.747 MHz : 8.960 dBm Delta1 : 22.244 MHz : 1.348 dB T1 : 5291.032 MHz : 1.096 dBm T2 : 5308.968 MHz : 1.393 dBm OBW : 17.936 MHz	Measured 26 dB Bandwidth: 22.244 MHz Measured 99% Bandwidth: 17.936 MHz

[Back to the Matrix](#)

This test report may be reproduced in full only. The document may only be updated by MiCOM Labs personnel. Any changes will be noted in the Document History section of the report.



**26 dB & 99% BANDWIDTH**

Variant: 802.11n HT-20, Channel: 5320.00 MHz, Chain a, Temp: Ambient, Voltage: 12 Vdc

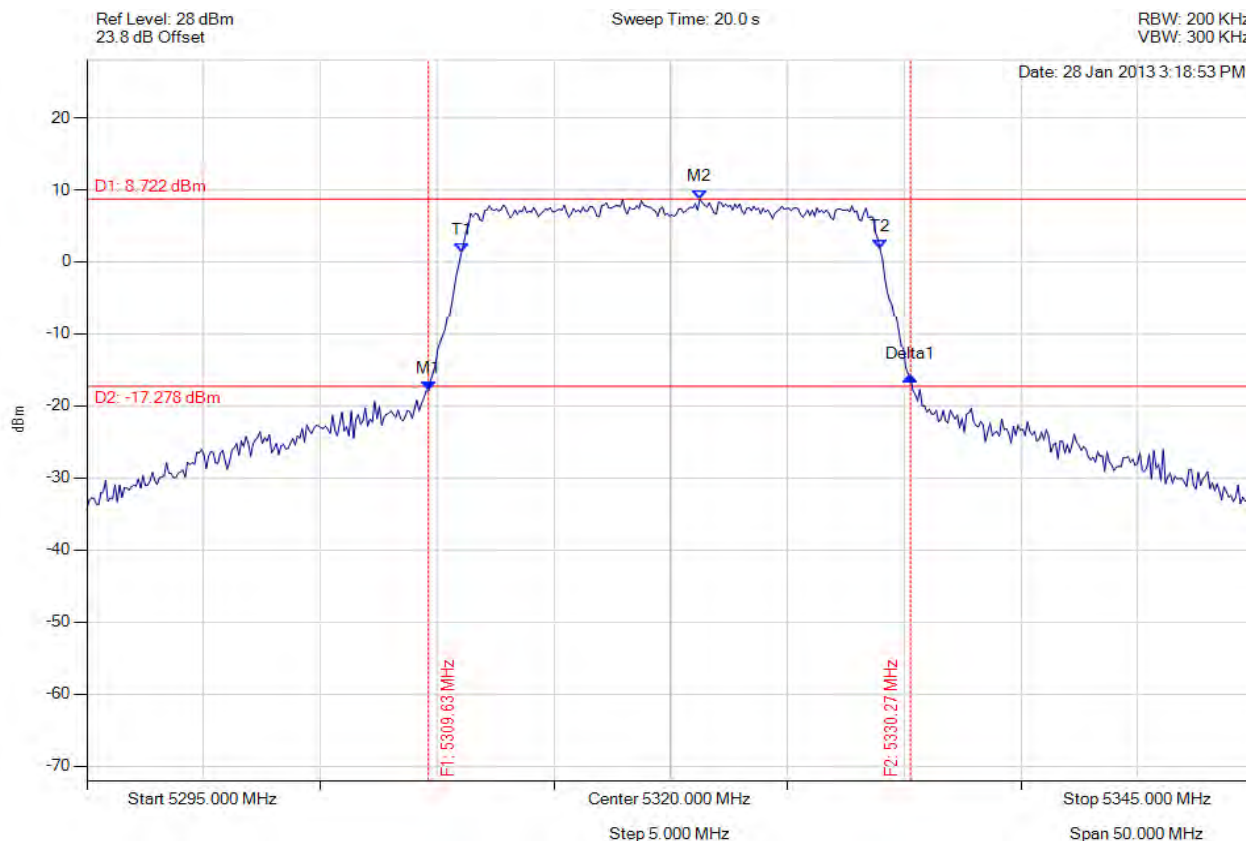

Analyser Setup	Marker : Frequency : Amplitude	Test Results
Detector = MAX PEAK Sweep Count = 0 RF Atten (dB) = 20 Trace Mode = VIEW	M1 : 5309.629 MHz : -17.924 dBm M2 : 5321.253 MHz : 8.722 dBm Delta1 : 20.641 MHz : 2.089 dB T1 : 5311.032 MHz : 1.246 dBm T2 : 5328.968 MHz : 1.742 dBm OBW : 17.936 MHz	Measured 26 dB Bandwidth: 20.641 MHz Measured 99% Bandwidth: 17.936 MHz

[Back to the Matrix](#)

This test report may be reproduced in full only. The document may only be updated by MiCOM Labs personnel. Any changes will be noted in the Document History section of the report.



**Title:** APIN0224, APIN0225 802.11a/b/g/n/ac  
**To:** FCC 47 CFR Part 15.407 & IC RSS-210  
**Serial #:** ARUB146-U1 Rev A  
**Issue Date:** 13th June 2013  
**Page:** 198 of 344



### 26 dB & 99% BANDWIDTH

Variant: 802.11n HT-20, Channel: 5320.00 MHz, Chain b, Temp: Ambient, Voltage: 12 Vdc

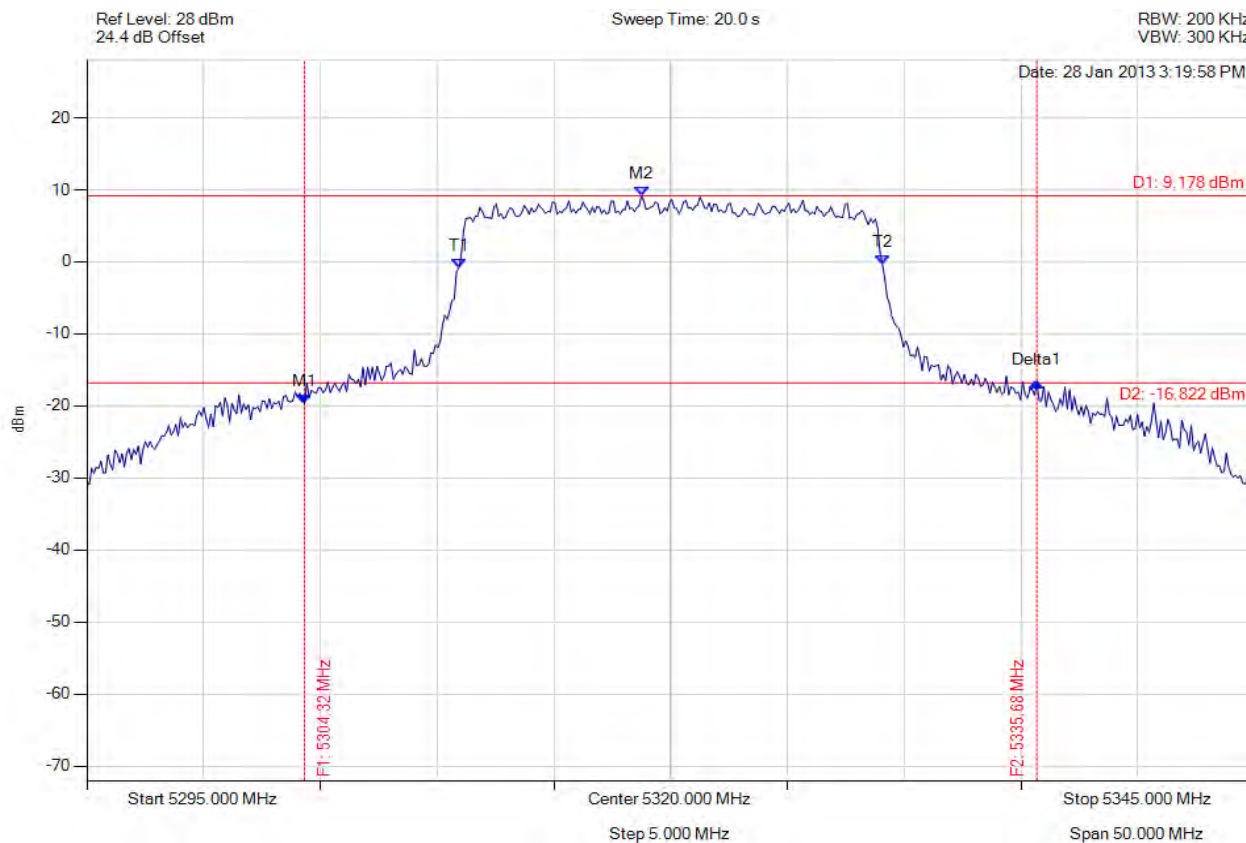

Analyser Setup	Marker : Frequency : Amplitude	Test Results
Detector = MAX PEAK Sweep Count = 0 RF Atten (dB) = 20 Trace Mode = VIEW	M1 : 5304.319 MHz : -19.689 dBm M2 : 5318.747 MHz : 9.178 dBm Delta1 : 31.363 MHz : 2.937 dB T1 : 5310.932 MHz : -0.851 dBm T2 : 5329.068 MHz : -0.324 dBm OBW : 18.136 MHz	Measured 26 dB Bandwidth: 31.363 MHz Measured 99% Bandwidth: 18.136 MHz

[Back to the Matrix](#)

This test report may be reproduced in full only. The document may only be updated by MiCOM Labs personnel. Any changes will be noted in the Document History section of the report.



**26 dB & 99% BANDWIDTH**

Variant: 802.11n HT-20, Channel: 5320.00 MHz, Chain c, Temp: Ambient, Voltage: 12 Vdc

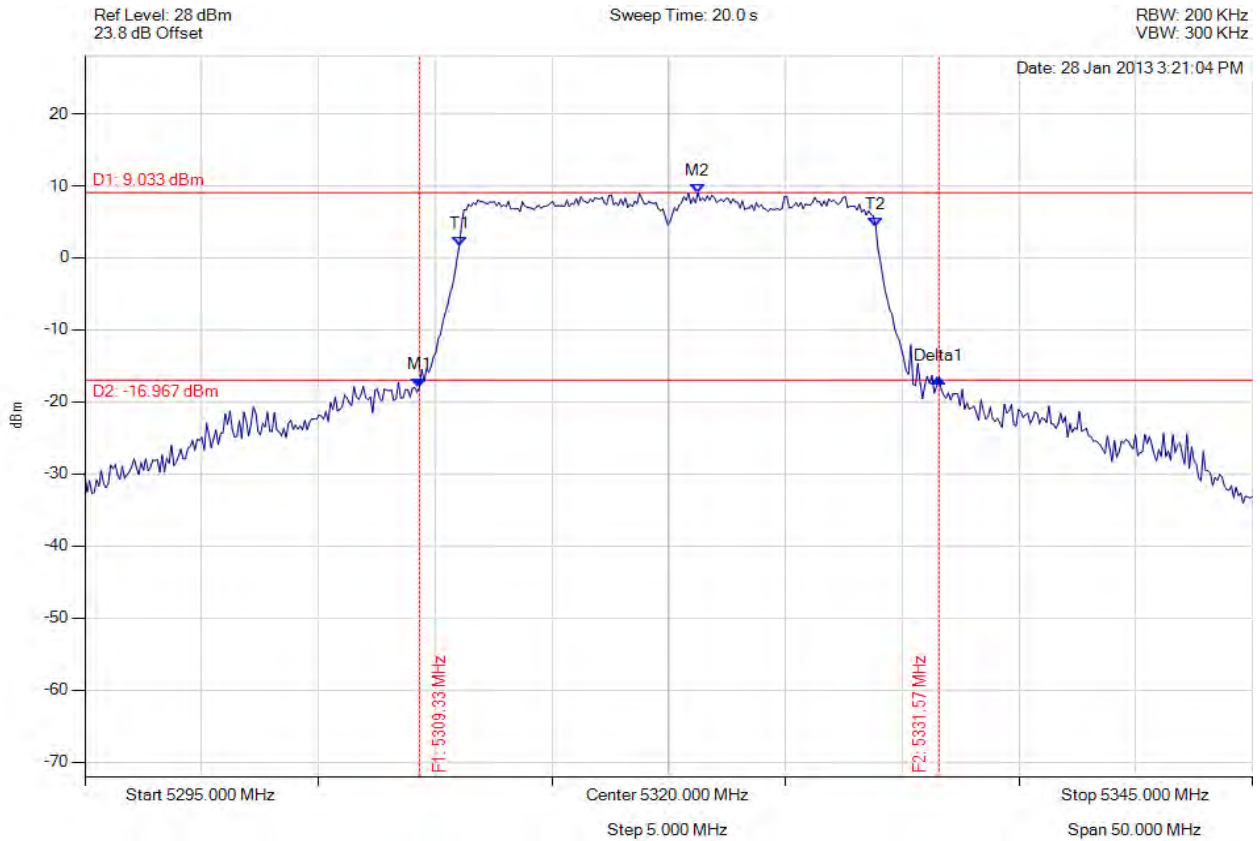

Analyser Setup	Marker : Frequency : Amplitude	Test Results
Detector = MAX PEAK Sweep Count = 0 RF Atten (dB) = 20 Trace Mode = VIEW	M1 : 5309.329 MHz : -17.963 dBm M2 : 5321.253 MHz : 9.033 dBm Delta1 : 22.244 MHz : 1.269 dB T1 : 5311.032 MHz : 1.598 dBm T2 : 5328.868 MHz : 4.317 dBm OBW : 17.836 MHz	Measured 26 dB Bandwidth: 22.244 MHz Measured 99% Bandwidth: 17.836 MHz

[Back to the Matrix](#)

This test report may be reproduced in full only. The document may only be updated by MiCOM Labs personnel. Any changes will be noted in the Document History section of the report.



**Title:** APIN0224, APIN0225 802.11a/b/g/n/ac  
**To:** FCC 47 CFR Part 15.407 & IC RSS-210  
**Serial #:** ARUB146-U1 Rev A  
**Issue Date:** 13th June 2013  
**Page:** 200 of 344



**26 dB & 99% BANDWIDTH**

Variant: 802.11n HT-40, Channel: 5270.00 MHz, Chain a, Temp: Ambient, Voltage: 12 Vdc

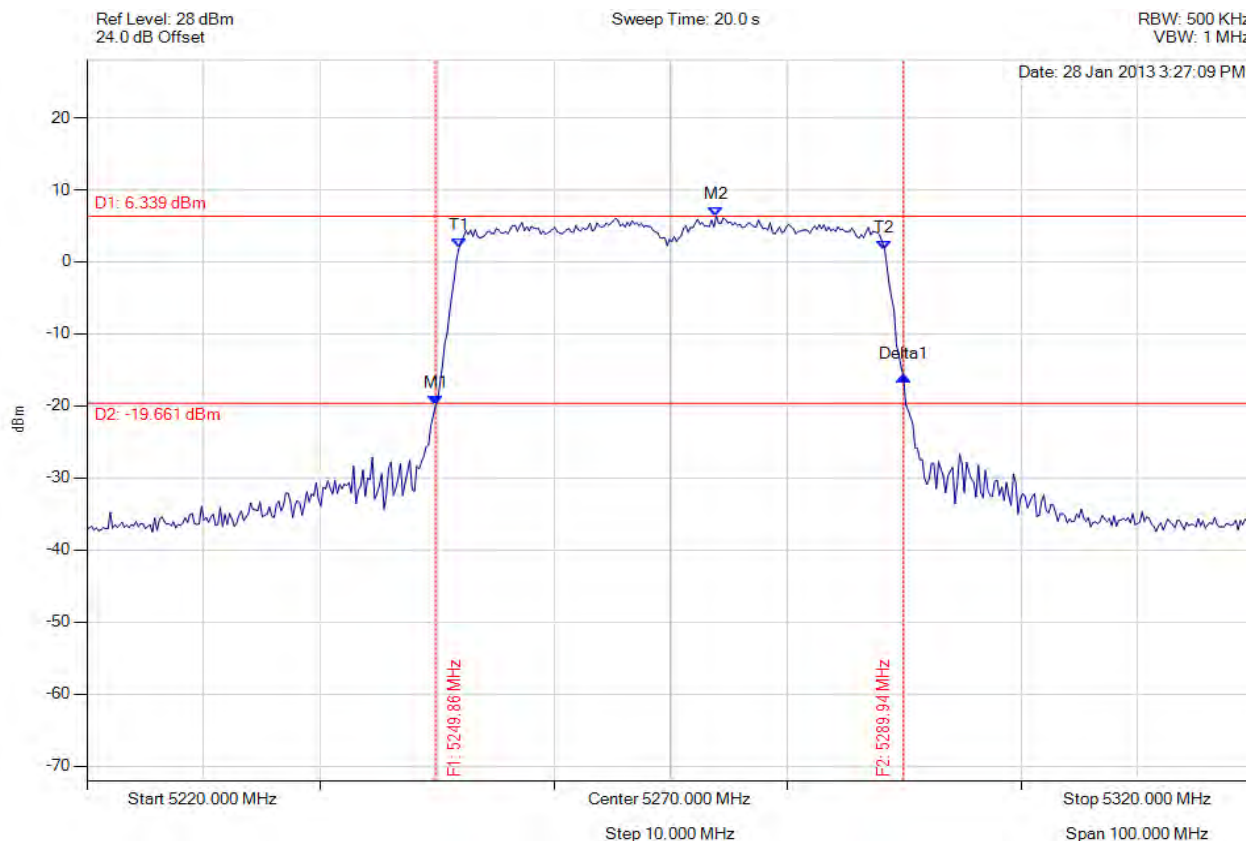

Analyser Setup	Marker : Frequency : Amplitude	Test Results
Detector = MAX PEAK Sweep Count = 0 RF Atten (dB) = 20 Trace Mode = VIEW	M1 : 5249.860 MHz : -19.954 dBm M2 : 5273.908 MHz : 6.339 dBm Delta1 : 40.080 MHz : 4.017 dB T1 : 5251.864 MHz : 1.891 dBm T2 : 5288.337 MHz : 1.630 dBm OBW : 36.473 MHz	Measured 26 dB Bandwidth: 40.080 MHz Measured 99% Bandwidth: 36.473 MHz

[Back to the Matrix](#)

This test report may be reproduced in full only. The document may only be updated by MiCOM Labs personnel. Any changes will be noted in the Document History section of the report.





**26 dB & 99% BANDWIDTH**

Variant: 802.11n HT-40, Channel: 5270.00 MHz, Chain b, Temp: Ambient, Voltage: 12 Vdc

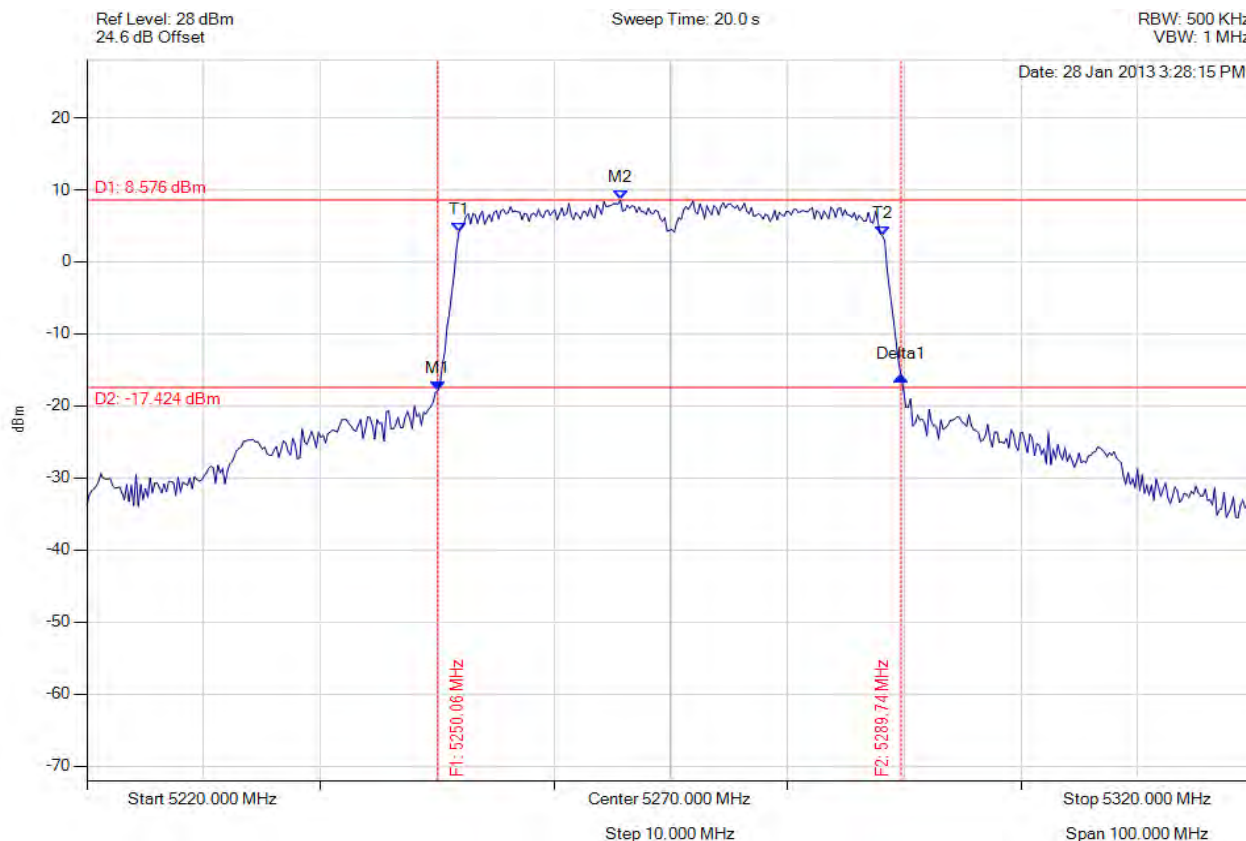

Analyser Setup	Marker : Frequency : Amplitude	Test Results
Detector = MAX PEAK Sweep Count = 0 RF Atten (dB) = 20 Trace Mode = VIEW	M1 : 5250.060 MHz : -17.873 dBm M2 : 5265.691 MHz : 8.576 dBm Delta1 : 39.679 MHz : 1.948 dB T1 : 5251.864 MHz : 4.187 dBm T2 : 5288.136 MHz : 3.593 dBm OBW : 36.273 MHz	Measured 26 dB Bandwidth: 39.679 MHz Measured 99% Bandwidth: 36.273 MHz

[Back to the Matrix](#)

This test report may be reproduced in full only. The document may only be updated by MiCOM Labs personnel. Any changes will be noted in the Document History section of the report.



**Title:** APIN0224, APIN0225 802.11a/b/g/n/ac  
**To:** FCC 47 CFR Part 15.407 & IC RSS-210  
**Serial #:** ARUB146-U1 Rev A  
**Issue Date:** 13th June 2013  
**Page:** 202 of 344



**26 dB & 99% BANDWIDTH**

Variant: 802.11n HT-40, Channel: 5270.00 MHz, Chain c, Temp: Ambient, Voltage: 12 Vdc

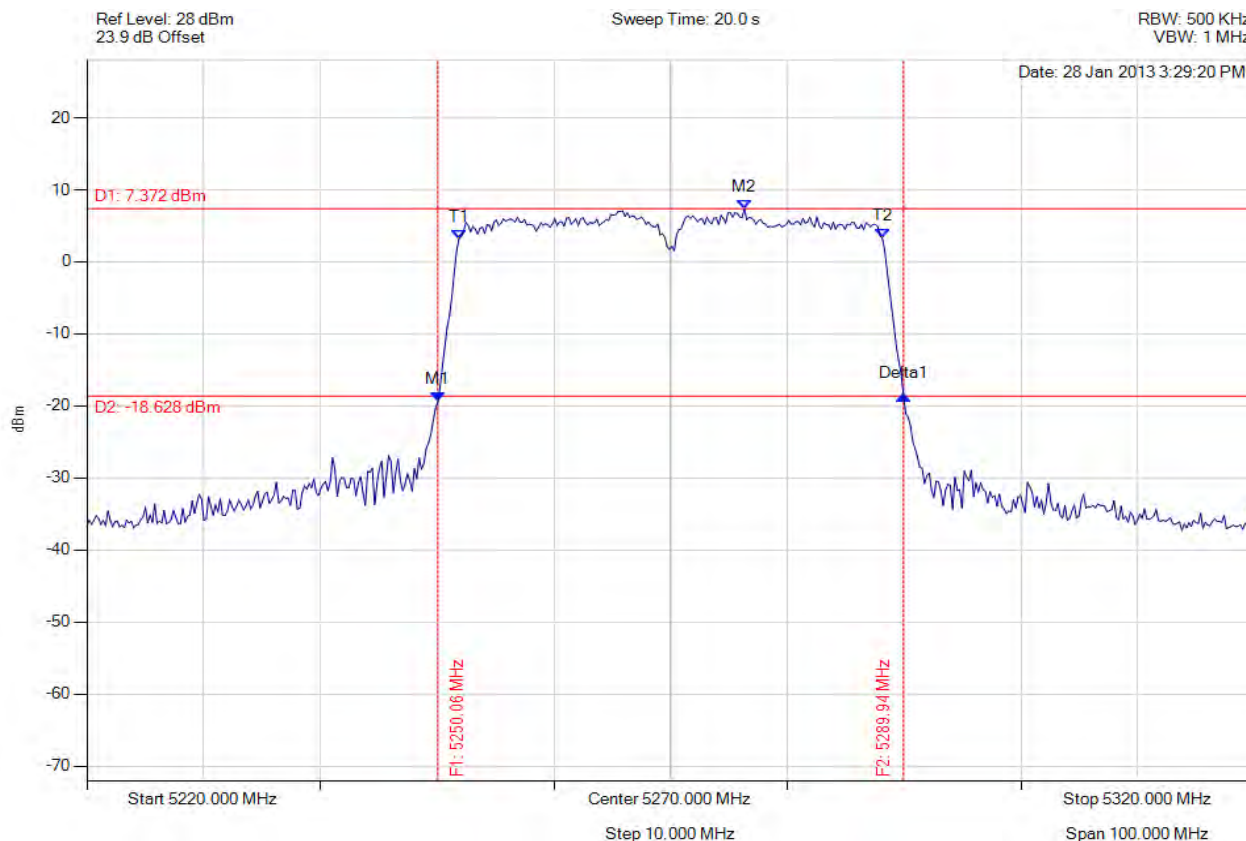

Analyser Setup	Marker : Frequency : Amplitude	Test Results
Detector = MAX PEAK Sweep Count = 0 RF Atten (dB) = 20 Trace Mode = VIEW	M1 : 5250.060 MHz : -19.435 dBm M2 : 5276.313 MHz : 7.372 dBm Delta1 : 39.880 MHz : 0.921 dB T1 : 5251.864 MHz : 3.198 dBm T2 : 5288.136 MHz : 3.245 dBm OBW : 36.273 MHz	Measured 26 dB Bandwidth: 39.880 MHz Measured 99% Bandwidth: 36.273 MHz

[Back to the Matrix](#)

This test report may be reproduced in full only. The document may only be updated by MiCOM Labs personnel. Any changes will be noted in the Document History section of the report.



**Title:** APIN0224, APIN0225 802.11a/b/g/n/ac  
**To:** FCC 47 CFR Part 15.407 & IC RSS-210  
**Serial #:** ARUB146-U1 Rev A  
**Issue Date:** 13th June 2013  
**Page:** 203 of 344



**26 dB & 99% BANDWIDTH**

Variant: 802.11n HT-40, Channel: 5310.00 MHz, Chain a, Temp: Ambient, Voltage: 12 Vdc

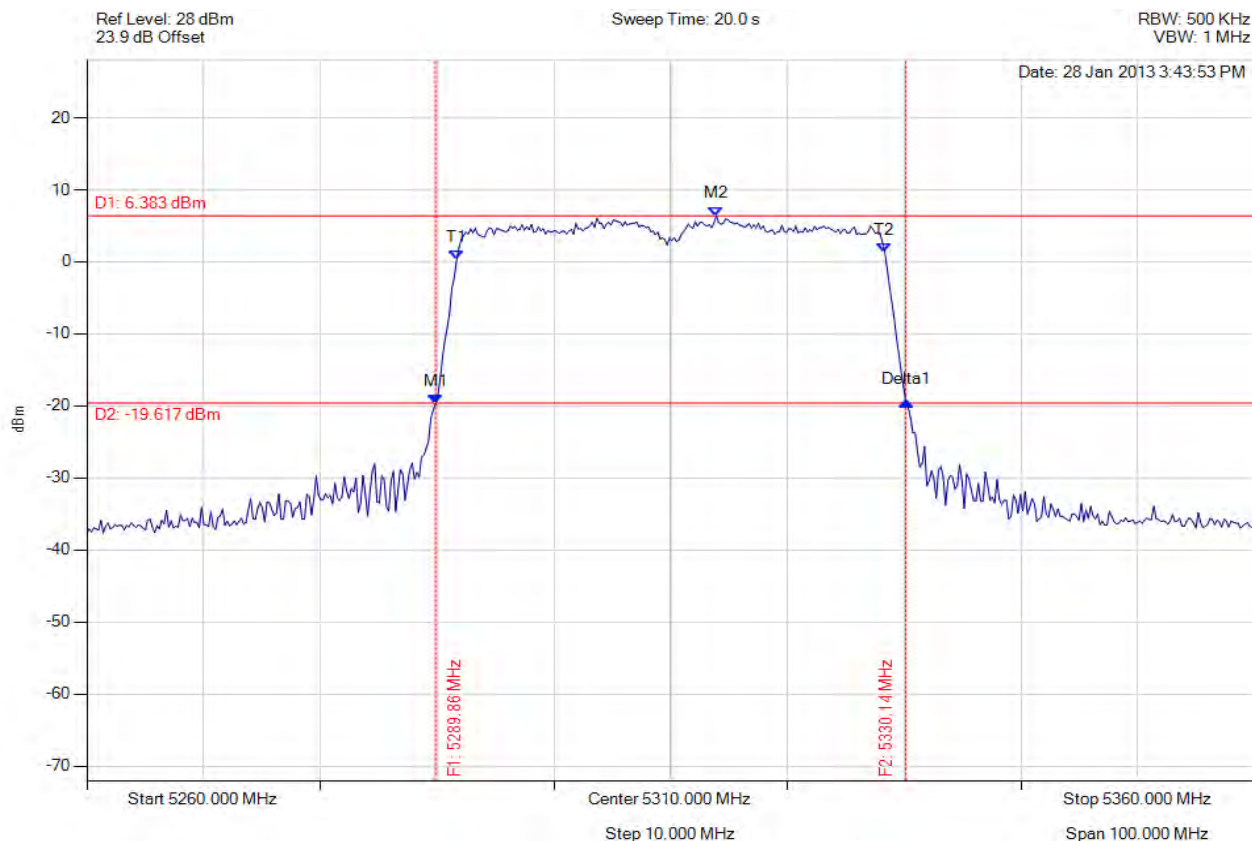

Analyser Setup	Marker : Frequency : Amplitude	Test Results
Detector = MAX PEAK Sweep Count = 0 RF Atten (dB) = 20 Trace Mode = VIEW	M1 : 5289.860 MHz : -19.781 dBm M2 : 5313.908 MHz : 6.383 dBm Delta1 : 40.281 MHz : 0.411 dB T1 : 5291.663 MHz : 0.241 dBm T2 : 5328.337 MHz : 1.348 dBm OBW : 36.673 MHz	Measured 26 dB Bandwidth: 40.281 MHz Measured 99% Bandwidth: 36.673 MHz

[Back to the Matrix](#)

This test report may be reproduced in full only. The document may only be updated by MiCOM Labs personnel. Any changes will be noted in the Document History section of the report.



**Title:** APIN0224, APIN0225 802.11a/b/g/n/ac  
**To:** FCC 47 CFR Part 15.407 & IC RSS-210  
**Serial #:** ARUB146-U1 Rev A  
**Issue Date:** 13th June 2013  
**Page:** 204 of 344



### 26 dB & 99% BANDWIDTH

Variant: 802.11n HT-40, Channel: 5310.00 MHz, Chain b, Temp: Ambient, Voltage: 12 Vdc

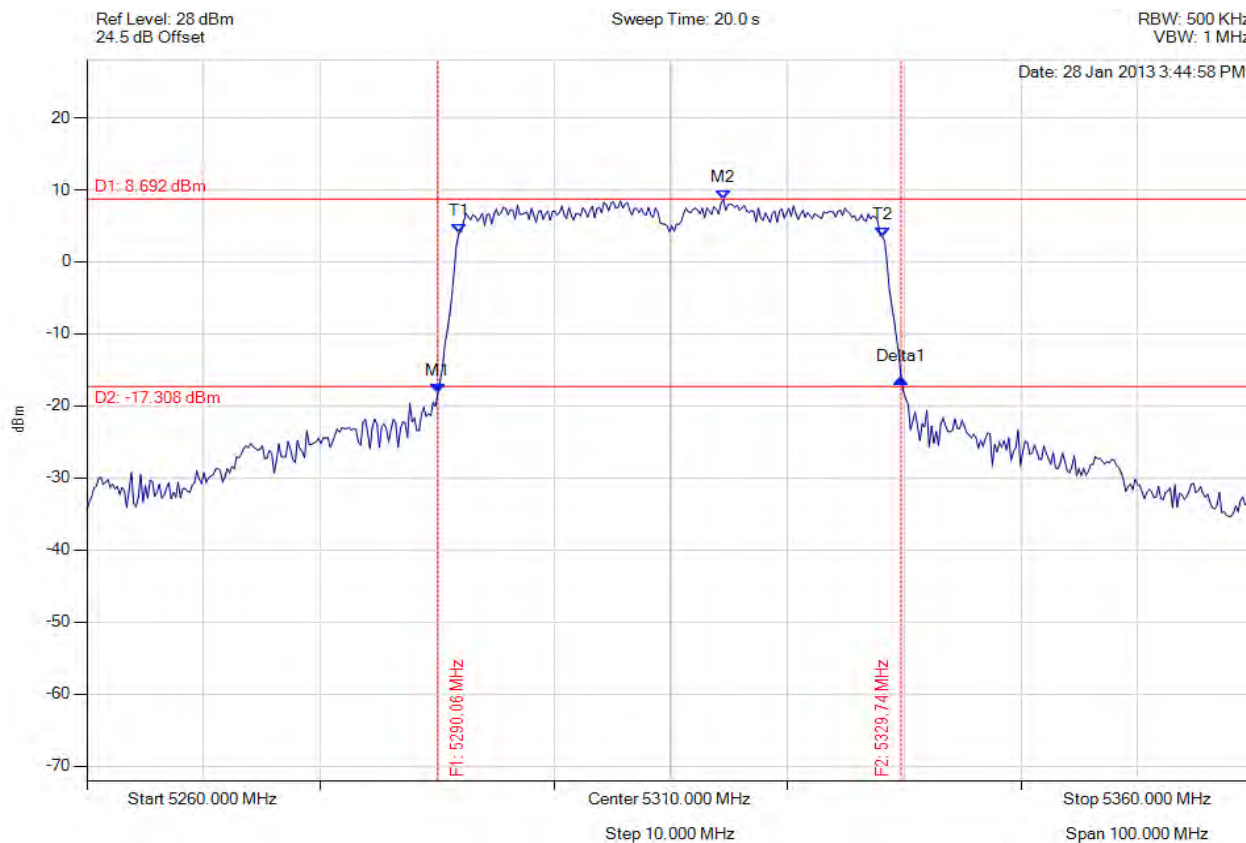

Analyser Setup	Marker : Frequency : Amplitude	Test Results
Detector = MAX PEAK Sweep Count = 0 RF Atten (dB) = 20 Trace Mode = VIEW	M1 : 5290.060 MHz : -18.207 dBm M2 : 5314.509 MHz : 8.692 dBm Delta1 : 39.679 MHz : 2.050 dB T1 : 5291.864 MHz : 4.028 dBm T2 : 5328.136 MHz : 3.532 dBm OBW : 36.273 MHz	Measured 26 dB Bandwidth: 39.679 MHz Measured 99% Bandwidth: 36.273 MHz

[Back to the Matrix](#)

This test report may be reproduced in full only. The document may only be updated by MiCOM Labs personnel. Any changes will be noted in the Document History section of the report.



**26 dB & 99% BANDWIDTH**

Variant: 802.11n HT-40, Channel: 5310.00 MHz, Chain c, Temp: Ambient, Voltage: 12 Vdc

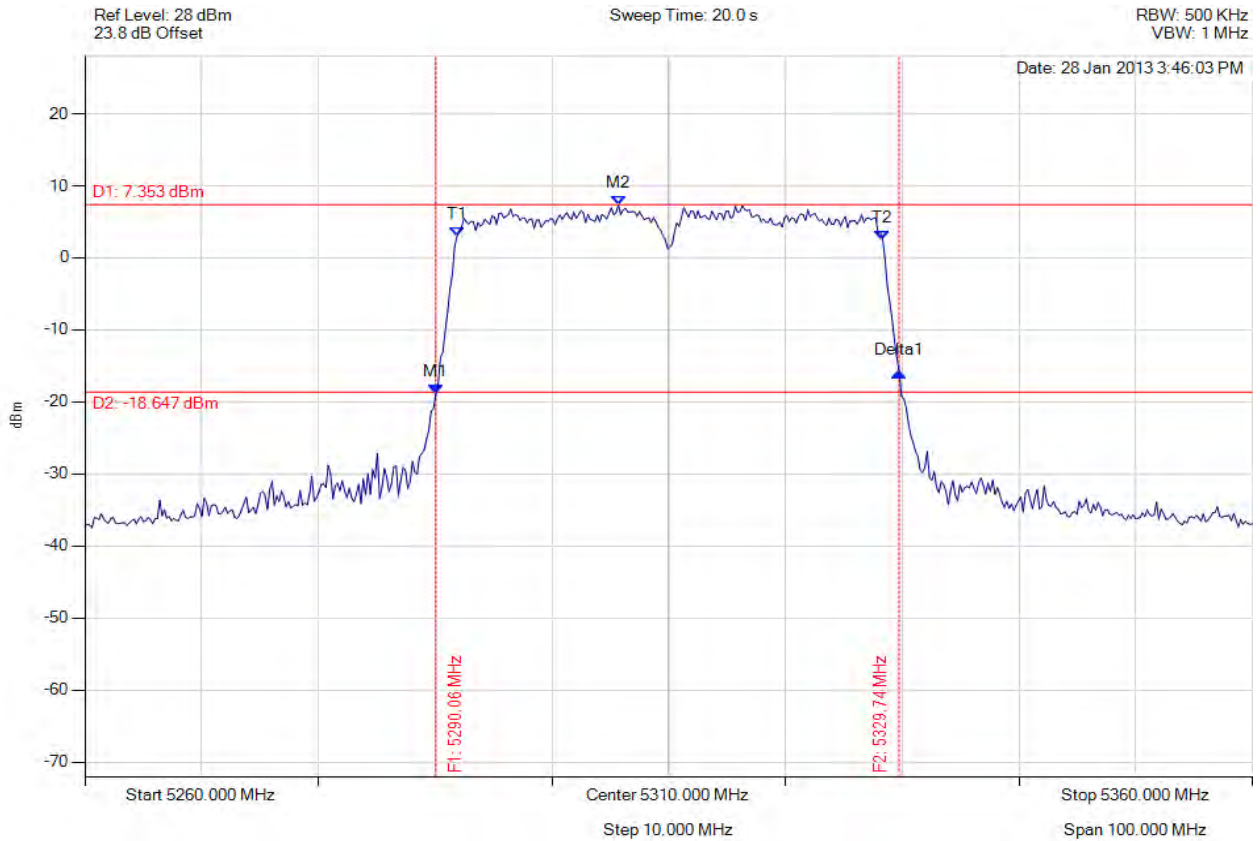

Analyser Setup	Marker : Frequency : Amplitude	Test Results
Detector = MAX PEAK Sweep Count = 0 RF Atten (dB) = 20 Trace Mode = VIEW	M1 : 5290.060 MHz : -18.864 dBm M2 : 5305.691 MHz : 7.353 dBm Delta1 : 39.679 MHz : 3.042 dB T1 : 5291.864 MHz : 2.991 dBm T2 : 5328.337 MHz : 2.519 dBm OBW : 36.473 MHz	Measured 26 dB Bandwidth: 39.679 MHz Measured 99% Bandwidth: 36.473 MHz

[Back to the Matrix](#)

This test report may be reproduced in full only. The document may only be updated by MiCOM Labs personnel. Any changes will be noted in the Document History section of the report.



**26 dB & 99% BANDWIDTH**

Variant: 802.11ac-40, Channel: 5270.00 MHz, Chain a, Temp: Ambient, Voltage: 12 Vdc

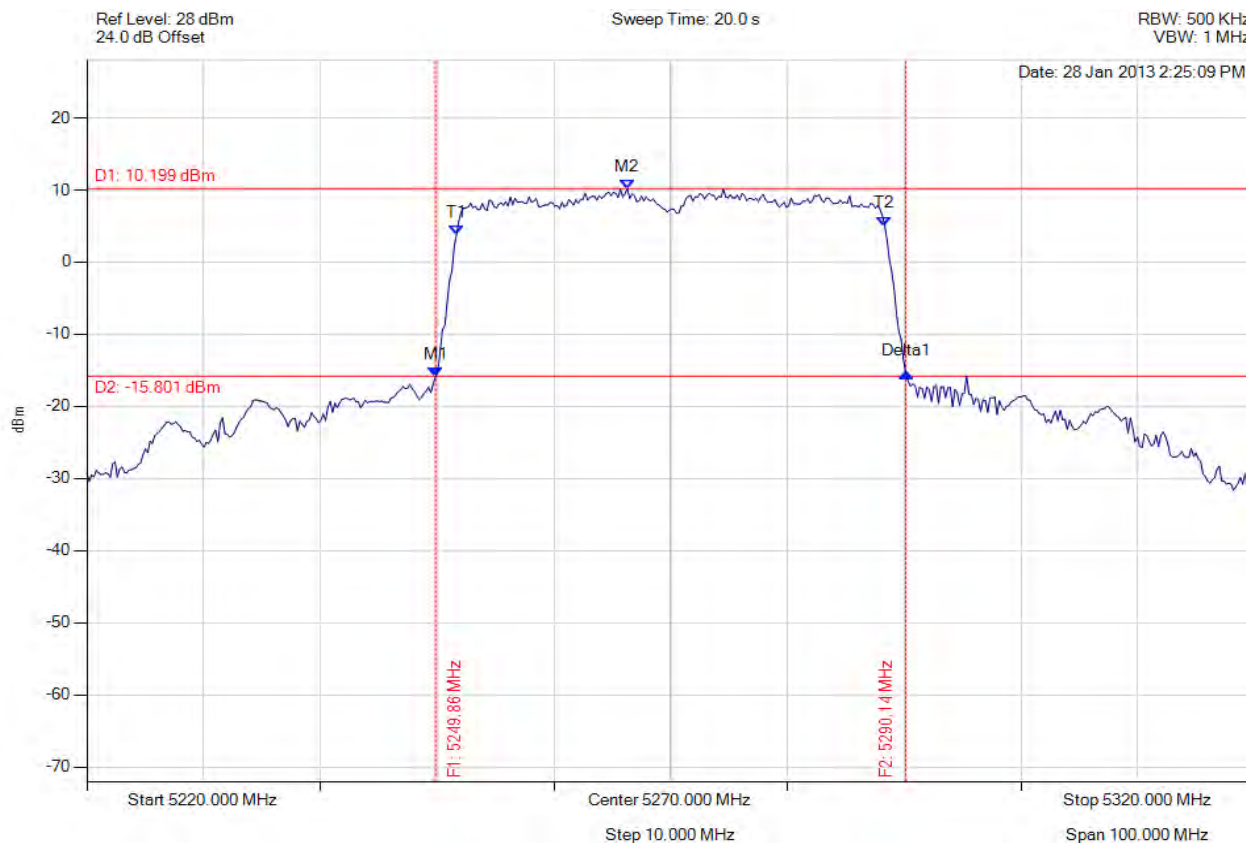

Analyser Setup	Marker : Frequency : Amplitude	Test Results
Detector = MAX PEAK Sweep Count = 0 RF Atten (dB) = 20 Trace Mode = VIEW	M1 : 5249.860 MHz : -15.866 dBm M2 : 5266.293 MHz : 10.199 dBm Delta1 : 40.281 MHz : 0.437 dB T1 : 5251.663 MHz : 3.861 dBm T2 : 5288.337 MHz : 5.055 dBm OBW : 36.673 MHz	Measured 26 dB Bandwidth: 40.281 MHz Measured 99% Bandwidth: 36.673 MHz

[Back to the Matrix](#)

This test report may be reproduced in full only. The document may only be updated by MiCOM Labs personnel. Any changes will be noted in the Document History section of the report.



**26 dB & 99% BANDWIDTH**

Variant: 802.11ac-40, Channel: 5270.00 MHz, Chain b, Temp: Ambient, Voltage: 12 Vdc

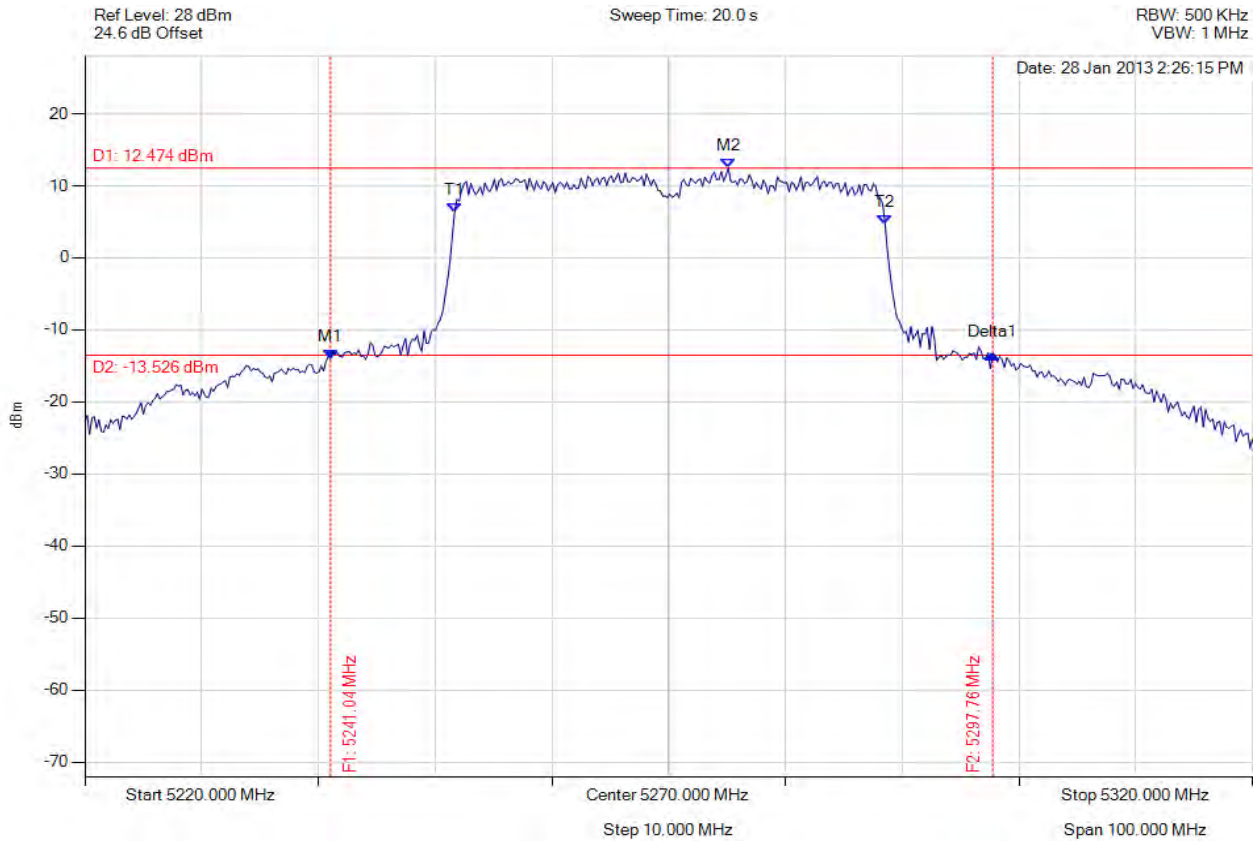

Analyser Setup	Marker : Frequency : Amplitude	Test Results
Detector = MAX PEAK Sweep Count = 0 RF Atten (dB) = 20 Trace Mode = VIEW	M1 : 5241.042 MHz : -13.987 dBm M2 : 5275.110 MHz : 12.474 dBm Delta1 : 56.713 MHz : 0.665 dB T1 : 5251.663 MHz : 6.310 dBm T2 : 5288.537 MHz : 4.642 dBm OBW : 36.874 MHz	Measured 26 dB Bandwidth: 56.713 MHz Measured 99% Bandwidth: 36.874 MHz

[Back to the Matrix](#)

This test report may be reproduced in full only. The document may only be updated by MiCOM Labs personnel. Any changes will be noted in the Document History section of the report.



**26 dB & 99% BANDWIDTH**

Variant: 802.11ac-40, Channel: 5270.00 MHz, Chain c, Temp: Ambient, Voltage: 12 Vdc

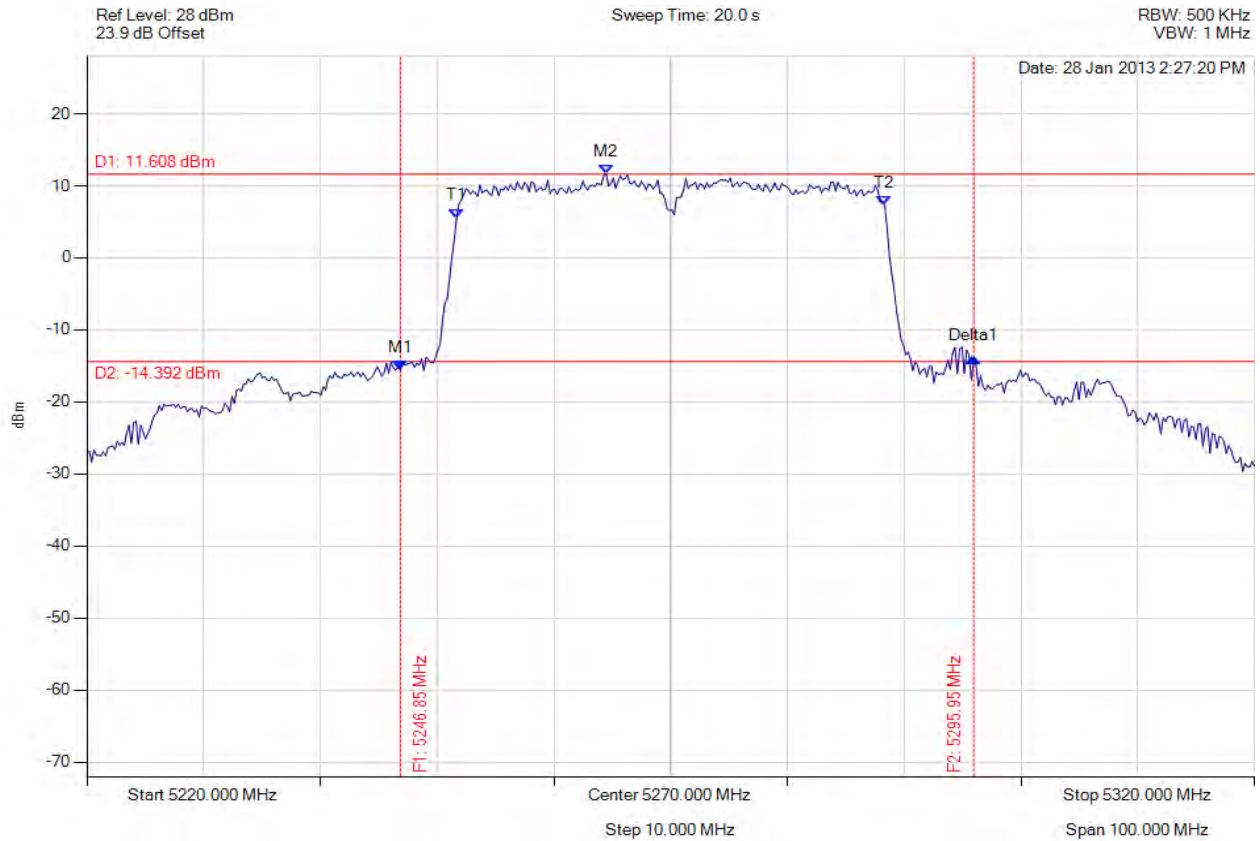

Analyser Setup	Marker : Frequency : Amplitude	Test Results
Detector = MAX PEAK Sweep Count = 0 RF Atten (dB) = 20 Trace Mode = VIEW	M1 : 5246.854 MHz : -15.591 dBm M2 : 5264.489 MHz : 11.608 dBm Delta1 : 49.098 MHz : 1.668 dB T1 : 5251.663 MHz : 5.543 dBm T2 : 5288.337 MHz : 7.229 dBm OBW : 36.673 MHz	Measured 26 dB Bandwidth: 49.098 MHz Measured 99% Bandwidth: 36.673 MHz

[Back to the Matrix](#)

This test report may be reproduced in full only. The document may only be updated by MiCOM Labs personnel. Any changes will be noted in the Document History section of the report.





**26 dB & 99% BANDWIDTH**

Variant: 802.11ac-40, Channel: 5310.00 MHz, Chain a, Temp: Ambient, Voltage: 12 Vdc

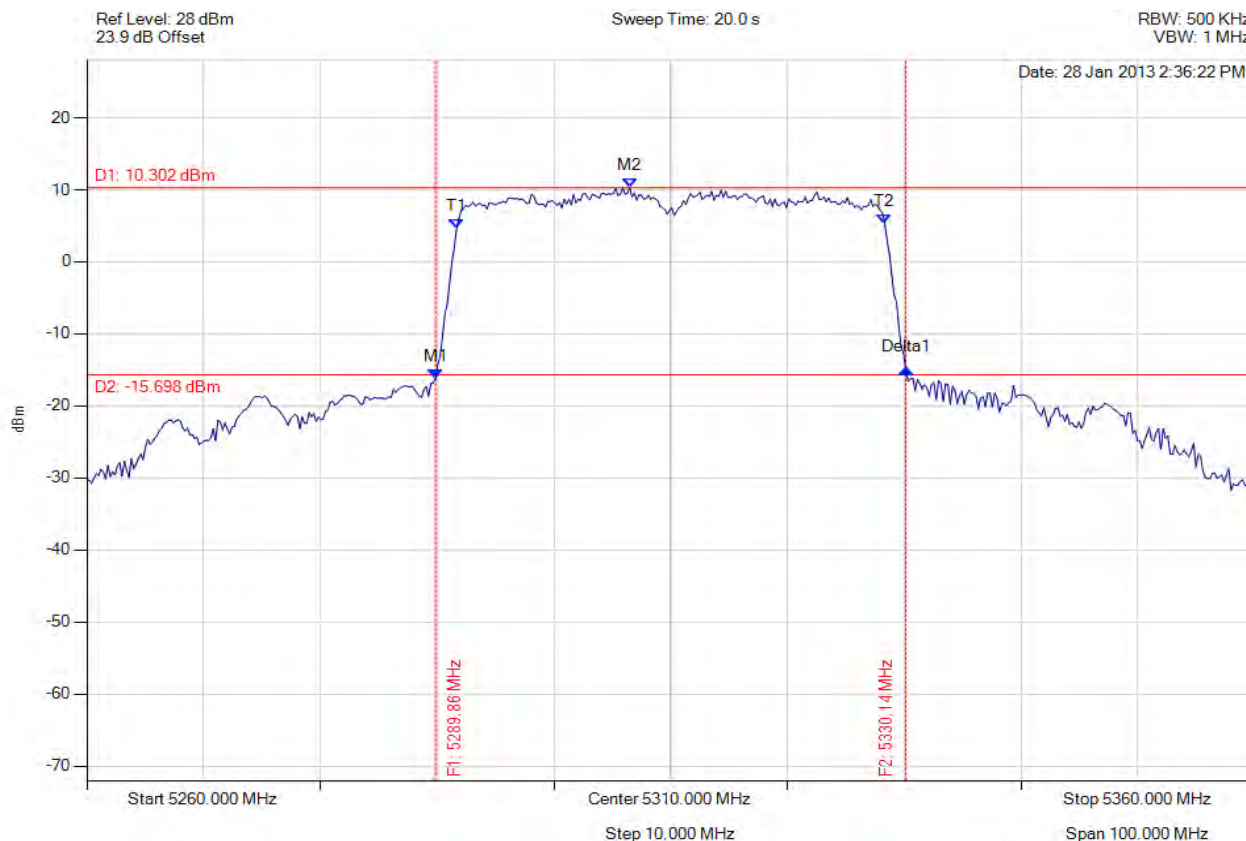

Analyser Setup	Marker : Frequency : Amplitude	Test Results
Detector = MAX PEAK Sweep Count = 0 RF Atten (dB) = 20 Trace Mode = VIEW	M1 : 5289.860 MHz : -16.197 dBm M2 : 5306.493 MHz : 10.302 dBm Delta1 : 40.281 MHz : 1.251 dB T1 : 5291.663 MHz : 4.604 dBm T2 : 5328.337 MHz : 5.366 dBm OBW : 36.673 MHz	Measured 26 dB Bandwidth: 40.281 MHz Measured 99% Bandwidth: 36.673 MHz

[Back to the Matrix](#)

This test report may be reproduced in full only. The document may only be updated by MiCOM Labs personnel. Any changes will be noted in the Document History section of the report.



**Title:** APIN0224, APIN0225 802.11a/b/g/n/ac  
**To:** FCC 47 CFR Part 15.407 & IC RSS-210  
**Serial #:** ARUB146-U1 Rev A  
**Issue Date:** 13th June 2013  
**Page:** 210 of 344



**26 dB & 99% BANDWIDTH**

Variant: 802.11ac-40, Channel: 5310.00 MHz, Chain b, Temp: Ambient, Voltage: 12 Vdc

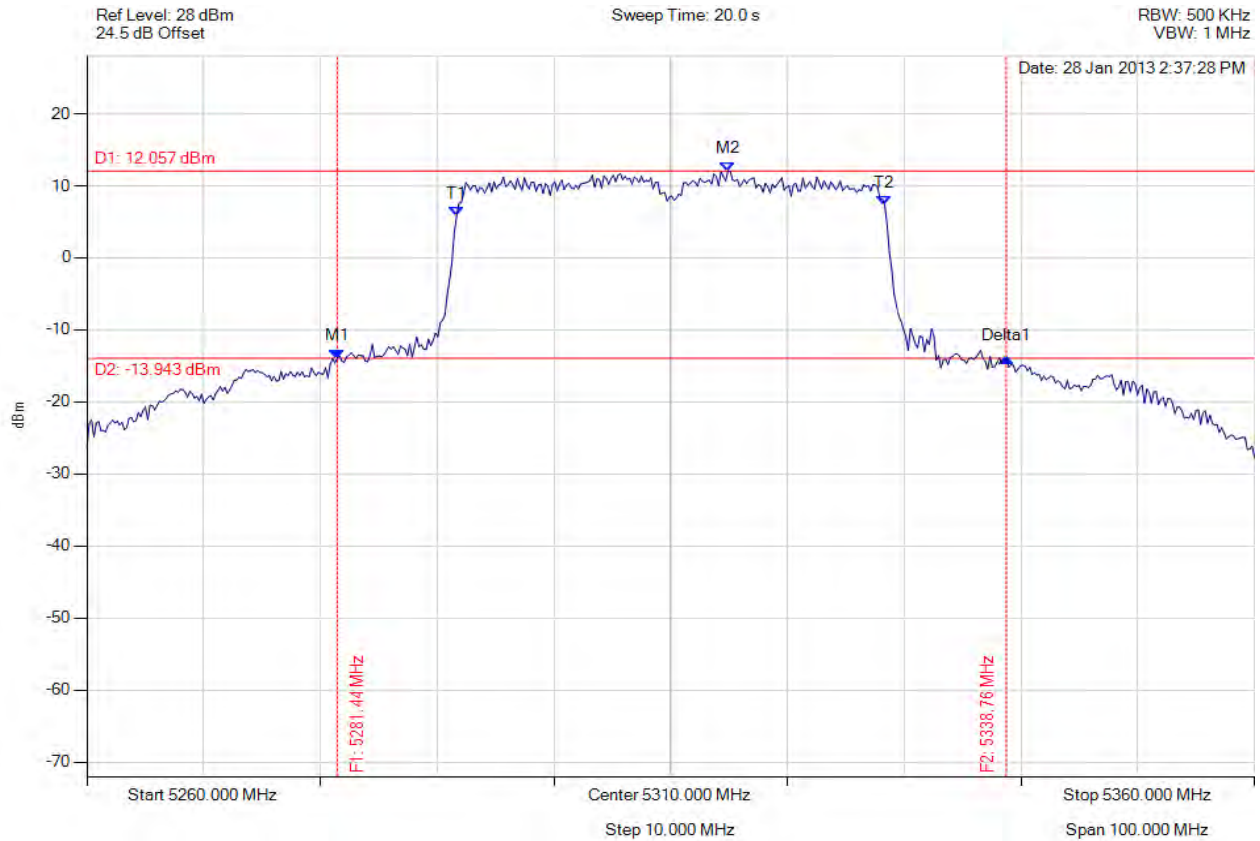

Analyser Setup	Marker : Frequency : Amplitude	Test Results
Detector = MAX PEAK Sweep Count = 0 RF Atten (dB) = 20 Trace Mode = VIEW	M1 : 5281.443 MHz : -13.964 dBm M2 : 5314.910 MHz : 12.057 dBm Delta1 : 57.315 MHz : 0.065 dB T1 : 5291.663 MHz : 5.730 dBm T2 : 5328.337 MHz : 7.315 dBm OBW : 36.673 MHz	Measured 26 dB Bandwidth: 57.315 MHz Measured 99% Bandwidth: 36.673 MHz

[Back to the Matrix](#)

This test report may be reproduced in full only. The document may only be updated by MiCOM Labs personnel. Any changes will be noted in the Document History section of the report.



**26 dB & 99% BANDWIDTH**

Variant: 802.11ac-40, Channel: 5310.00 MHz, Chain c, Temp: Ambient, Voltage: 12 Vdc

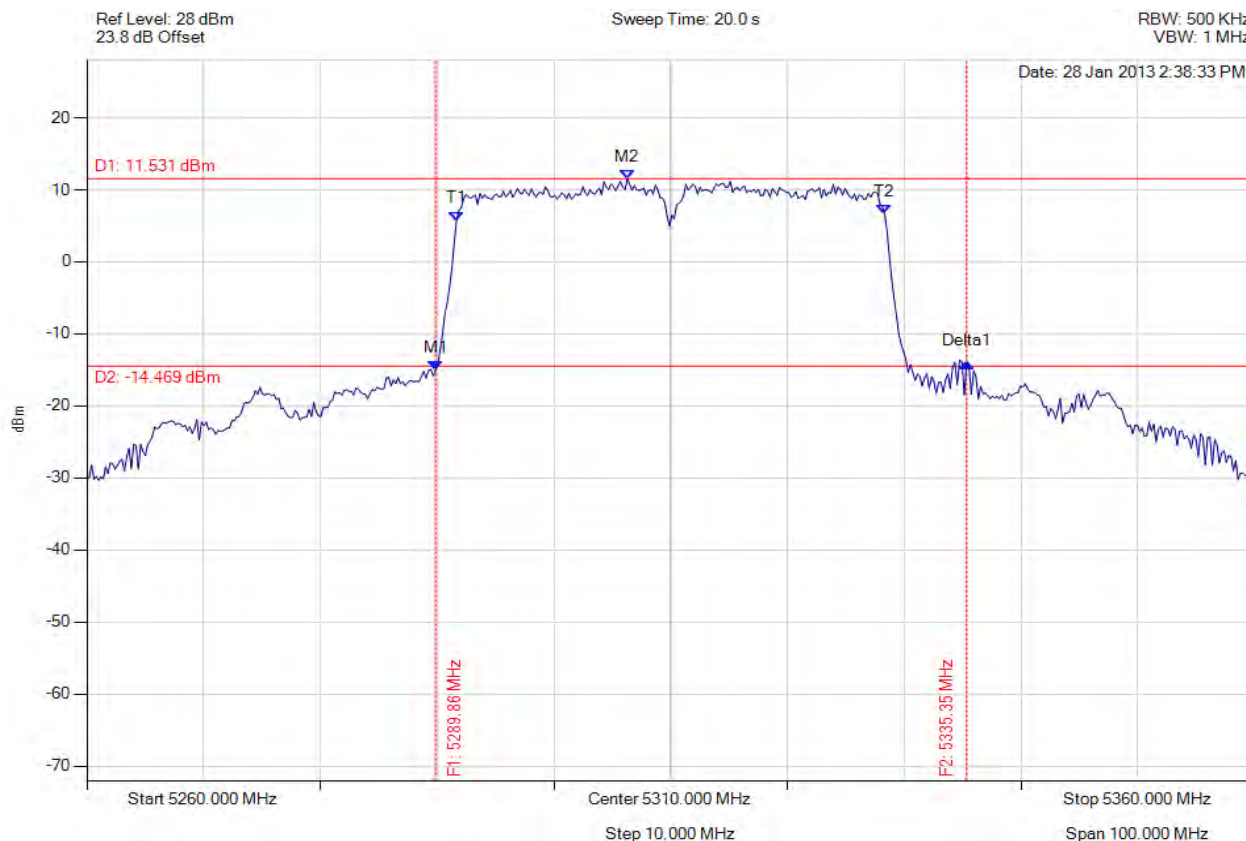

Analyser Setup	Marker : Frequency : Amplitude	Test Results
Detector = MAX PEAK Sweep Count = 0 RF Atten (dB) = 20 Trace Mode = VIEW	M1 : 5289.860 MHz : -15.052 dBm M2 : 5306.293 MHz : 11.531 dBm Delta1 : 45.491 MHz : 1.011 dB T1 : 5291.663 MHz : 5.714 dBm T2 : 5328.337 MHz : 6.562 dBm OBW : 36.673 MHz	Measured 26 dB Bandwidth: 45.491 MHz Measured 99% Bandwidth: 36.673 MHz

[Back to the Matrix](#)

This test report may be reproduced in full only. The document may only be updated by MiCOM Labs personnel. Any changes will be noted in the Document History section of the report.



**26 dB & 99% BANDWIDTH**

Variant: 802.11ac-80, Channel: 5290.00 MHz, Chain a, Temp: Ambient, Voltage: 12 Vdc

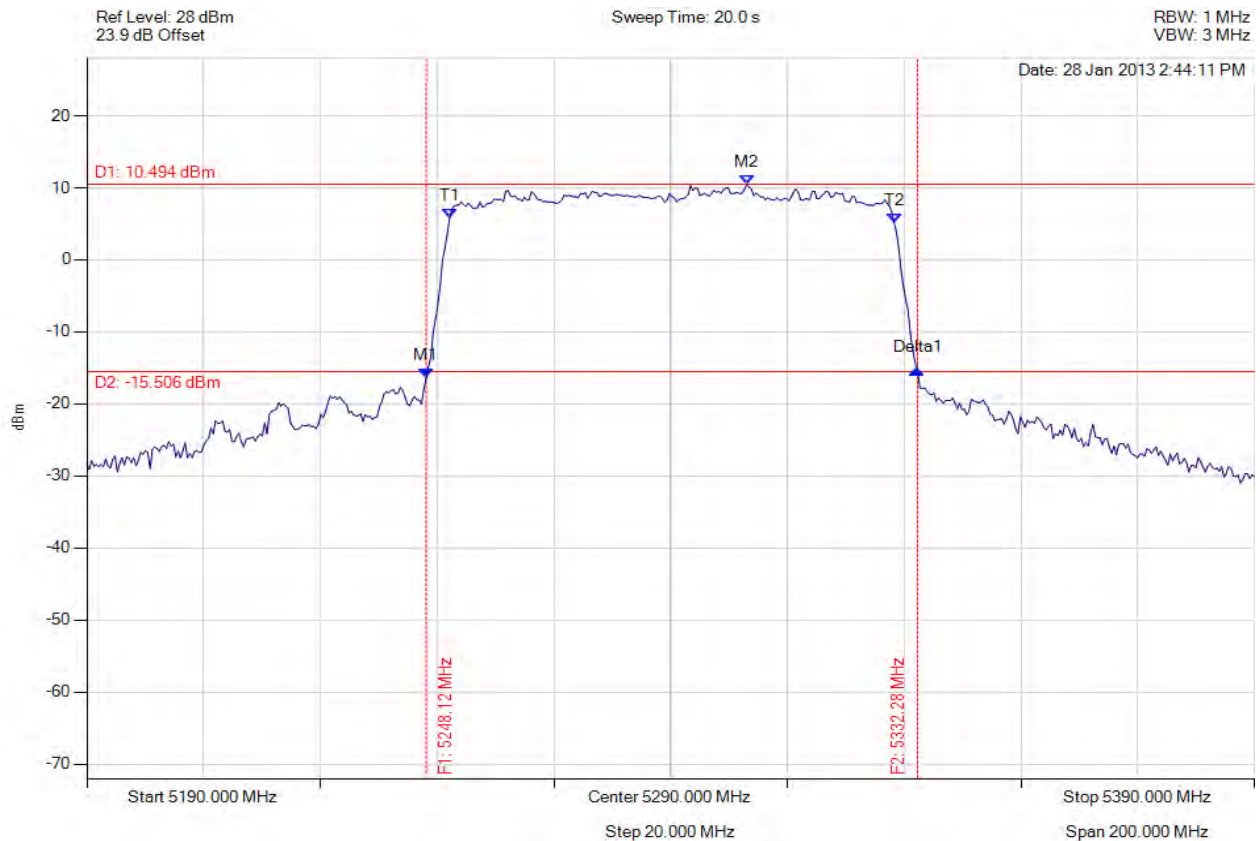

Analyser Setup	Marker : Frequency : Amplitude	Test Results
Detector = MAX PEAK Sweep Count = 0 RF Atten (dB) = 20 Trace Mode = VIEW	M1 : 5248.116 MHz : -16.450 dBm M2 : 5303.026 MHz : 10.494 dBm Delta1 : 84.168 MHz : 1.159 dB T1 : 5252.124 MHz : 5.765 dBm T2 : 5328.277 MHz : 5.167 dBm OBW : 76.152 MHz	Measured 26 dB Bandwidth: 84.168 MHz Measured 99% Bandwidth: 76.152 MHz

[Back to the Matrix](#)

This test report may be reproduced in full only. The document may only be updated by MiCOM Labs personnel. Any changes will be noted in the Document History section of the report.



**Title:** APIN0224, APIN0225 802.11a/b/g/n/ac  
**To:** FCC 47 CFR Part 15.407 & IC RSS-210  
**Serial #:** ARUB146-U1 Rev A  
**Issue Date:** 13th June 2013  
**Page:** 213 of 344



**26 dB & 99% BANDWIDTH**

Variant: 802.11ac-80, Channel: 5290.00 MHz, Chain b, Temp: Ambient, Voltage: 12 Vdc

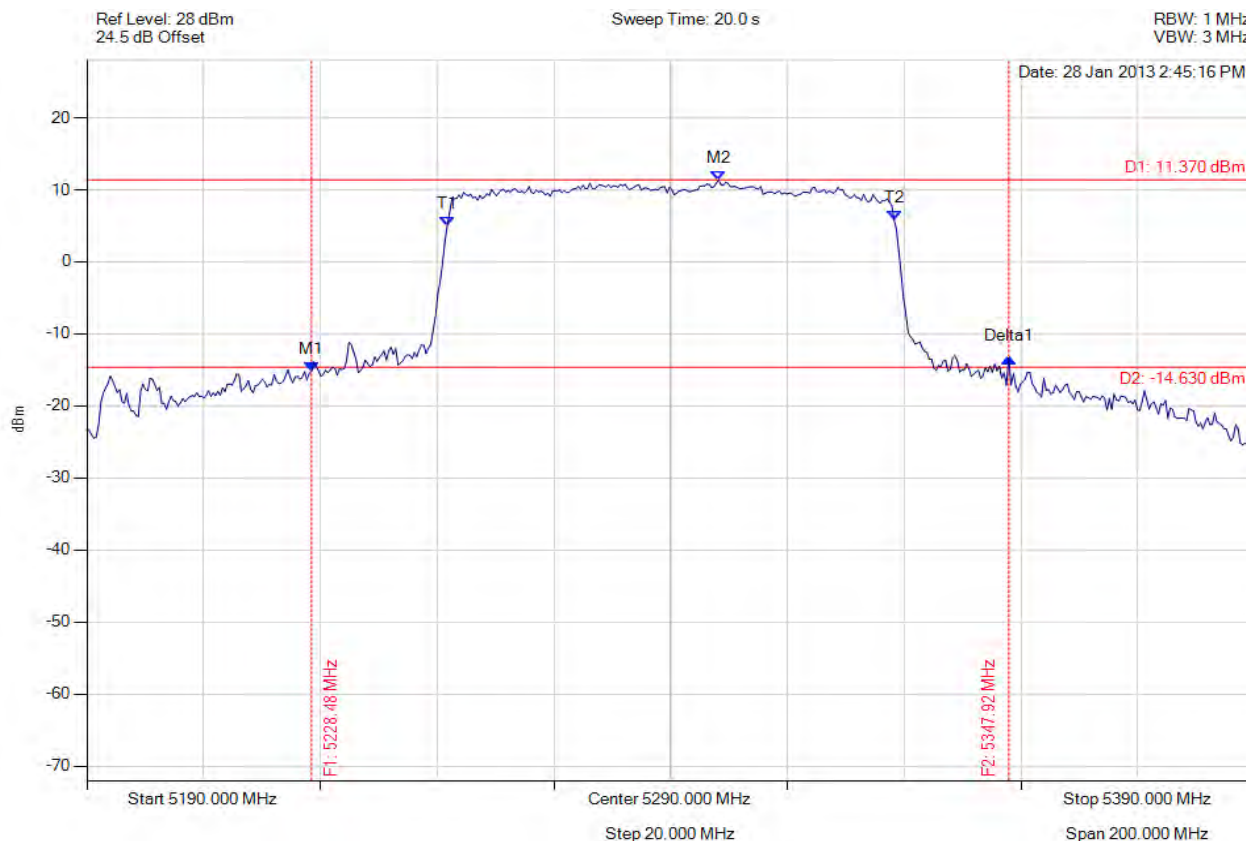

Analyser Setup	Marker : Frequency : Amplitude	Test Results
Detector = MAX PEAK Sweep Count = 0 RF Atten (dB) = 20 Trace Mode = VIEW	M1 : 5228.477 MHz : -15.158 dBm M2 : 5298.216 MHz : 11.370 dBm Delta1 : 119.439 MHz : 1.782 dB T1 : 5251.723 MHz : 4.990 dBm T2 : 5328.277 MHz : 5.808 dBm OBW : 76.553 MHz	Measured 26 dB Bandwidth: 119.439 MHz M Measured 99% Bandwidth: 76.553 MHz

[Back to the Matrix](#)

This test report may be reproduced in full only. The document may only be updated by MiCOM Labs personnel. Any changes will be noted in the Document History section of the report.



**Title:** APIN0224, APIN0225 802.11a/b/g/n/ac  
**To:** FCC 47 CFR Part 15.407 & IC RSS-210  
**Serial #:** ARUB146-U1 Rev A  
**Issue Date:** 13th June 2013  
**Page:** 214 of 344



**26 dB & 99% BANDWIDTH**

Variant: 802.11ac-80, Channel: 5290.00 MHz, Chain c, Temp: Ambient, Voltage: 12 Vdc

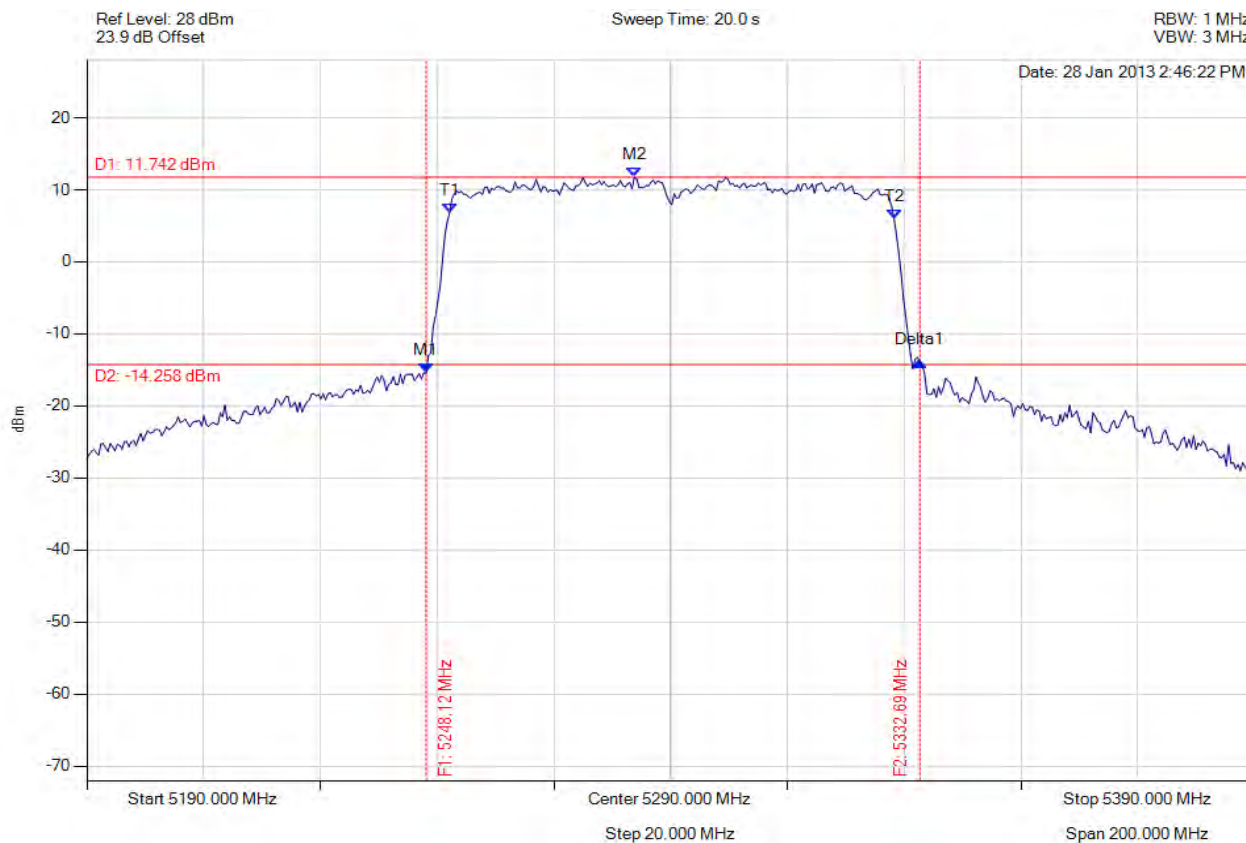

Analyser Setup	Marker : Frequency : Amplitude	Test Results
Detector = MAX PEAK Sweep Count = 0 RF Atten (dB) = 20 Trace Mode = VIEW	M1 : 5248.116 MHz : -15.433 dBm M2 : 5283.788 MHz : 11.742 dBm Delta1 : 84.569 MHz : 1.556 dB T1 : 5252.124 MHz : 6.794 dBm T2 : 5328.277 MHz : 5.991 dBm OBW : 76.152 MHz	Measured 26 dB Bandwidth: 84.569 MHz Measured 99% Bandwidth: 76.152 MHz

[Back to the Matrix](#)

This test report may be reproduced in full only. The document may only be updated by MiCOM Labs personnel. Any changes will be noted in the Document History section of the report.



**26 dB & 99% BANDWIDTH**

Variant: 802.11a, Channel: 5500.00 MHz, Chain a, Temp: Ambient, Voltage: 12 Vdc

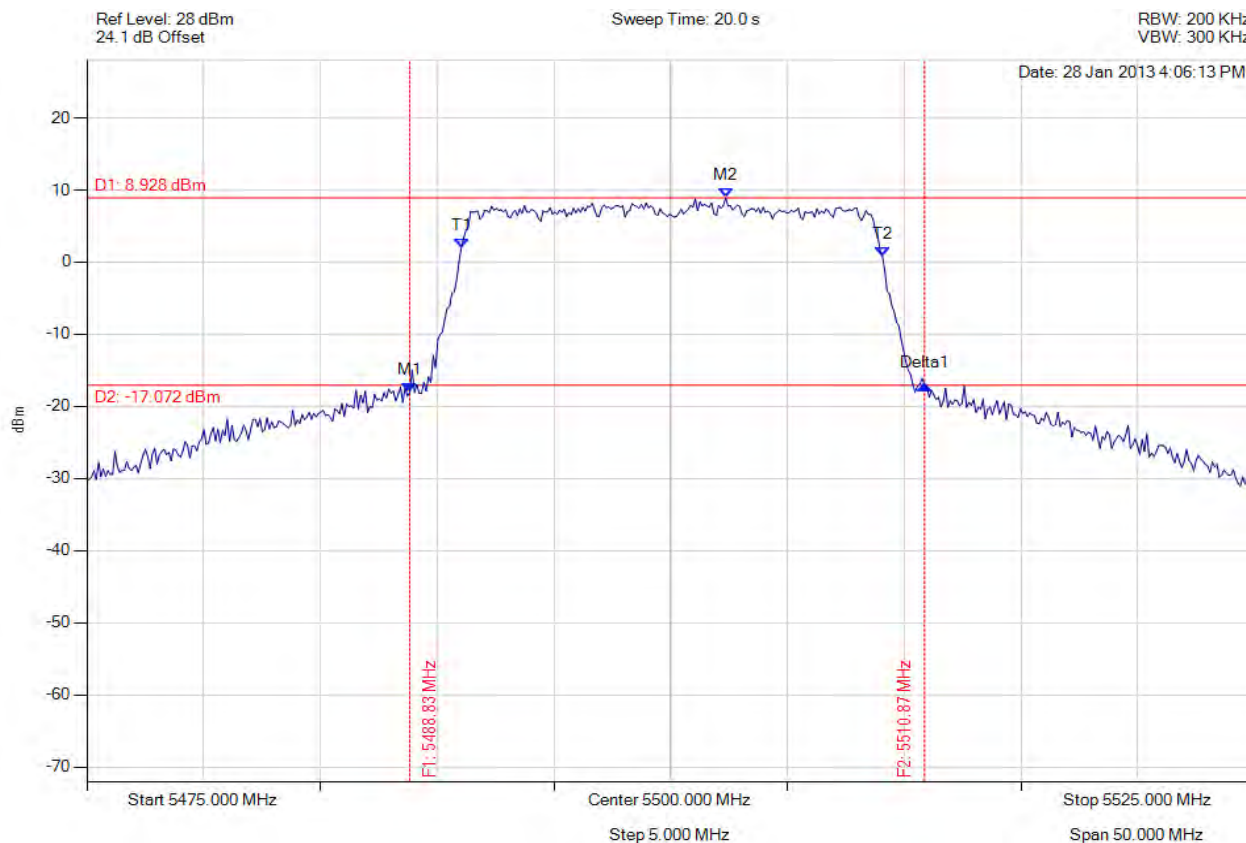

Analyser Setup	Marker : Frequency : Amplitude	Test Results
Detector = MAX PEAK Sweep Count = 0 RF Atten (dB) = 20 Trace Mode = VIEW	M1 : 5488.828 MHz : -18.009 dBm M2 : 5502.355 MHz : 8.928 dBm Delta1 : 22.044 MHz : 0.982 dB T1 : 5491.032 MHz : 2.003 dBm T2 : 5509.068 MHz : 0.839 dBm OBW : 18.036 MHz	Measured 26 dB Bandwidth: 22.044 MHz Measured 99% Bandwidth: 18.036 MHz

[Back to the Matrix](#)

This test report may be reproduced in full only. The document may only be updated by MiCOM Labs personnel. Any changes will be noted in the Document History section of the report.



**26 dB & 99% BANDWIDTH**

Variant: 802.11a, Channel: 5500.00 MHz, Chain b, Temp: Ambient, Voltage: 12 Vdc

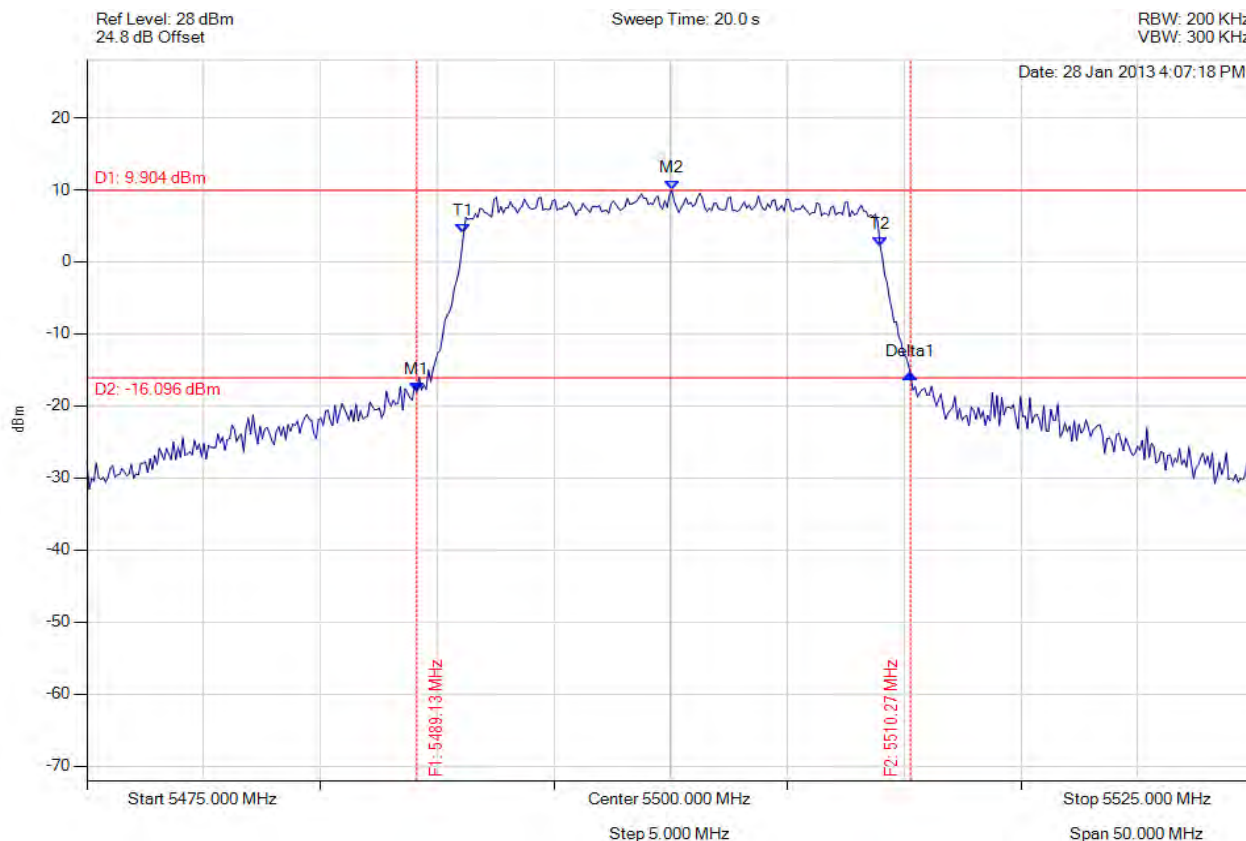

Analyser Setup	Marker : Frequency : Amplitude	Test Results
Detector = MAX PEAK Sweep Count = 0 RF Atten (dB) = 20 Trace Mode = VIEW	M1 : 5489.128 MHz : -18.097 dBm M2 : 5500.050 MHz : 9.904 dBm Delta1 : 21.142 MHz : 2.483 dB T1 : 5491.132 MHz : 3.933 dBm T2 : 5508.968 MHz : 2.204 dBm OBW : 17.836 MHz	Measured 26 dB Bandwidth: 21.142 MHz Measured 99% Bandwidth: 17.836 MHz

[Back to the Matrix](#)

This test report may be reproduced in full only. The document may only be updated by MiCOM Labs personnel. Any changes will be noted in the Document History section of the report.





**26 dB & 99% BANDWIDTH**

Variant: 802.11a, Channel: 5500.00 MHz, Chain c, Temp: Ambient, Voltage: 12 Vdc

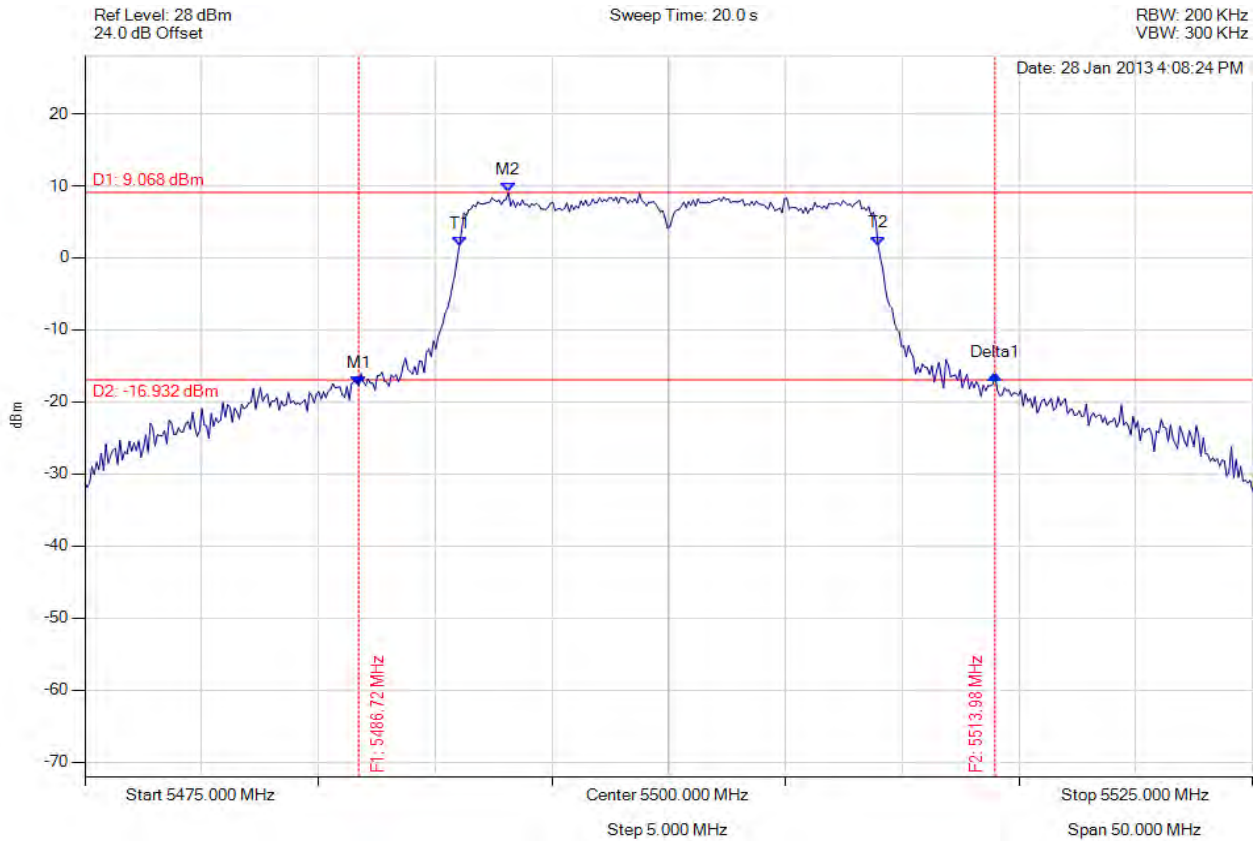

Analyser Setup	Marker : Frequency : Amplitude	Test Results
Detector = MAX PEAK Sweep Count = 0 RF Atten (dB) = 20 Trace Mode = VIEW	M1 : 5486.723 MHz : -17.786 dBm M2 : 5493.136 MHz : 9.068 dBm Delta1 : 27.255 MHz : 1.501 dB T1 : 5491.032 MHz : 1.569 dBm T2 : 5508.968 MHz : 1.720 dBm OBW : 17.936 MHz	Measured 26 dB Bandwidth: 27.255 MHz Measured 99% Bandwidth: 17.936 MHz

[Back to the Matrix](#)

This test report may be reproduced in full only. The document may only be updated by MiCOM Labs personnel. Any changes will be noted in the Document History section of the report.



**26 dB & 99% BANDWIDTH**

Variant: 802.11a, Channel: 5580.00 MHz, Chain a, Temp: Ambient, Voltage: 12 Vdc

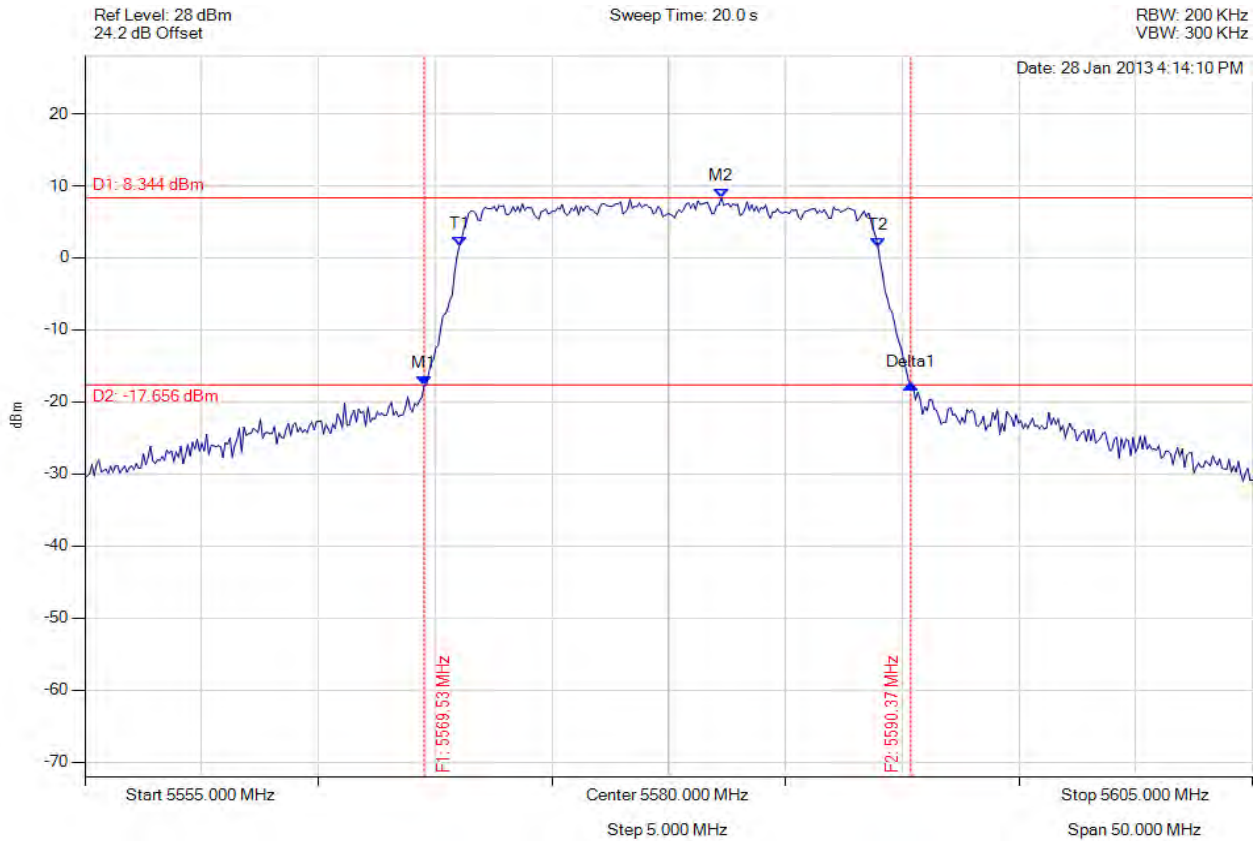

Analyser Setup	Marker : Frequency : Amplitude	Test Results
Detector = MAX PEAK Sweep Count = 0 RF Atten (dB) = 20 Trace Mode = VIEW	M1 : 5569.529 MHz : -17.747 dBm M2 : 5582.255 MHz : 8.344 dBm Delta1 : 20.842 MHz : 0.236 dB T1 : 5571.032 MHz : 1.606 dBm T2 : 5588.968 MHz : 1.458 dBm OBW : 17.936 MHz	Measured 26 dB Bandwidth: 20.842 MHz Measured 99% Bandwidth: 17.936 MHz

[Back to the Matrix](#)

This test report may be reproduced in full only. The document may only be updated by MiCOM Labs personnel. Any changes will be noted in the Document History section of the report.



**Title:** APIN0224, APIN0225 802.11a/b/g/n/ac  
**To:** FCC 47 CFR Part 15.407 & IC RSS-210  
**Serial #:** ARUB146-U1 Rev A  
**Issue Date:** 13th June 2013  
**Page:** 219 of 344



**26 dB & 99% BANDWIDTH**

Variant: 802.11a, Channel: 5580.00 MHz, Chain b, Temp: Ambient, Voltage: 12 Vdc

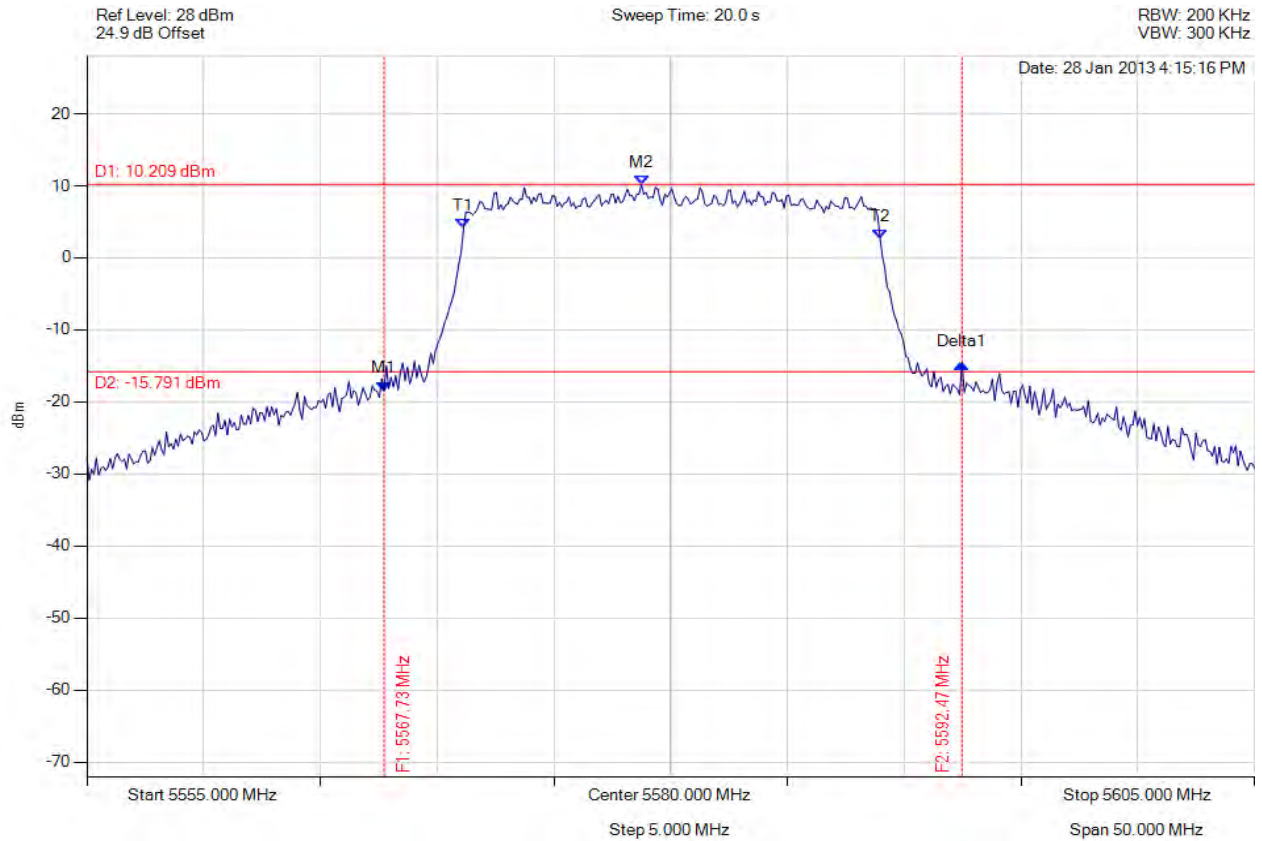

Analyser Setup	Marker : Frequency : Amplitude	Test Results
Detector = MAX PEAK Sweep Count = 0 RF Atten (dB) = 20 Trace Mode = VIEW	M1 : 5567.725 MHz : -18.473 dBm M2 : 5578.747 MHz : 10.209 dBm Delta1 : 24.749 MHz : 3.809 dB T1 : 5571.132 MHz : 4.112 dBm T2 : 5588.968 MHz : 2.666 dBm OBW : 17.836 MHz	Measured 26 dB Bandwidth: 24.749 MHz Measured 99% Bandwidth: 17.836 MHz

[Back to the Matrix](#)

This test report may be reproduced in full only. The document may only be updated by MiCOM Labs personnel. Any changes will be noted in the Document History section of the report.



**26 dB & 99% BANDWIDTH**

Variant: 802.11a, Channel: 5580.00 MHz, Chain c, Temp: Ambient, Voltage: 12 Vdc

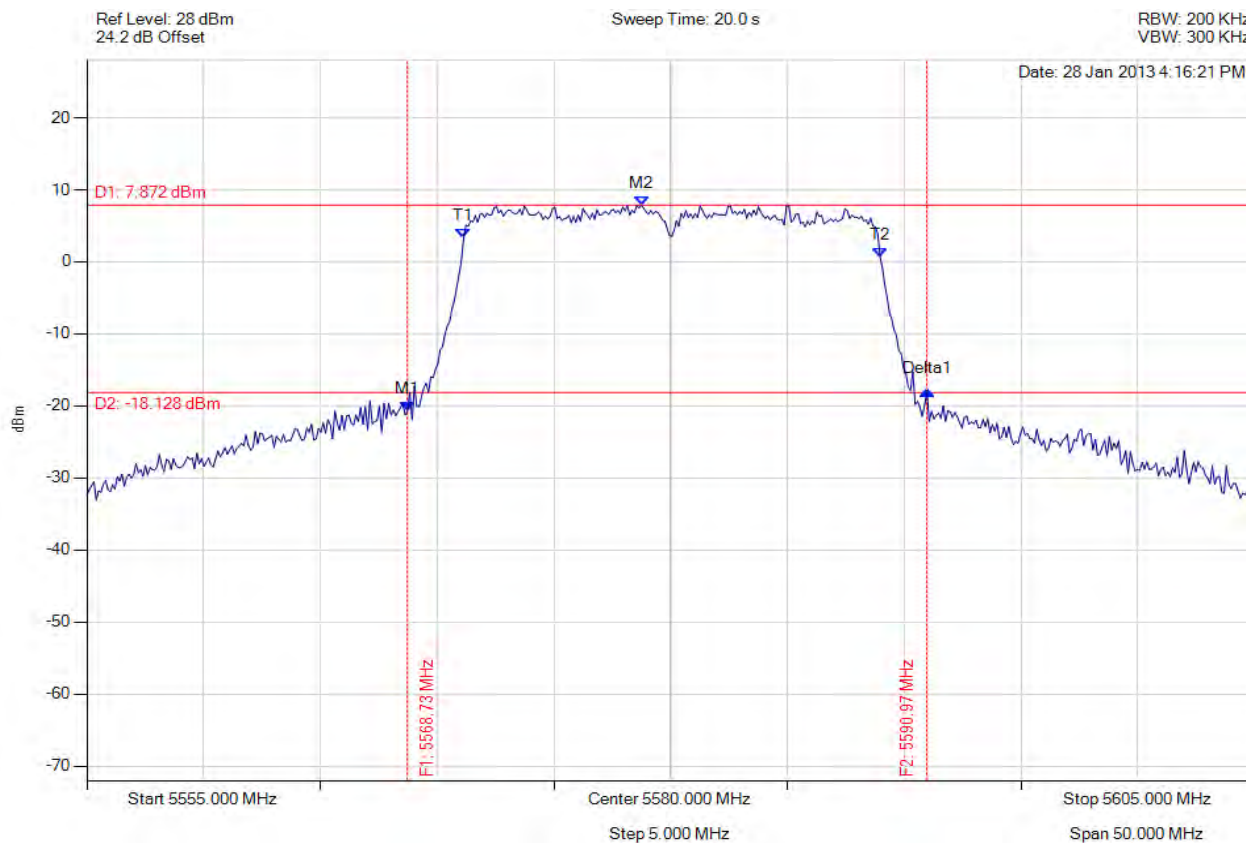

Analyser Setup	Marker : Frequency : Amplitude	Test Results
Detector = MAX PEAK Sweep Count = 0 RF Atten (dB) = 20 Trace Mode = VIEW	M1 : 5568.727 MHz : -20.733 dBm M2 : 5578.747 MHz : 7.872 dBm Delta1 : 22.244 MHz : 2.825 dB T1 : 5571.132 MHz : 3.229 dBm T2 : 5588.968 MHz : 0.662 dBm OBW : 17.836 MHz	Measured 26 dB Bandwidth: 22.244 MHz Measured 99% Bandwidth: 17.836 MHz

[Back to the Matrix](#)

This test report may be reproduced in full only. The document may only be updated by MiCOM Labs personnel. Any changes will be noted in the Document History section of the report.



**26 dB & 99% BANDWIDTH**

Variant: 802.11a, Channel: 5700.00 MHz, Chain a, Temp: Ambient, Voltage: 12 Vdc

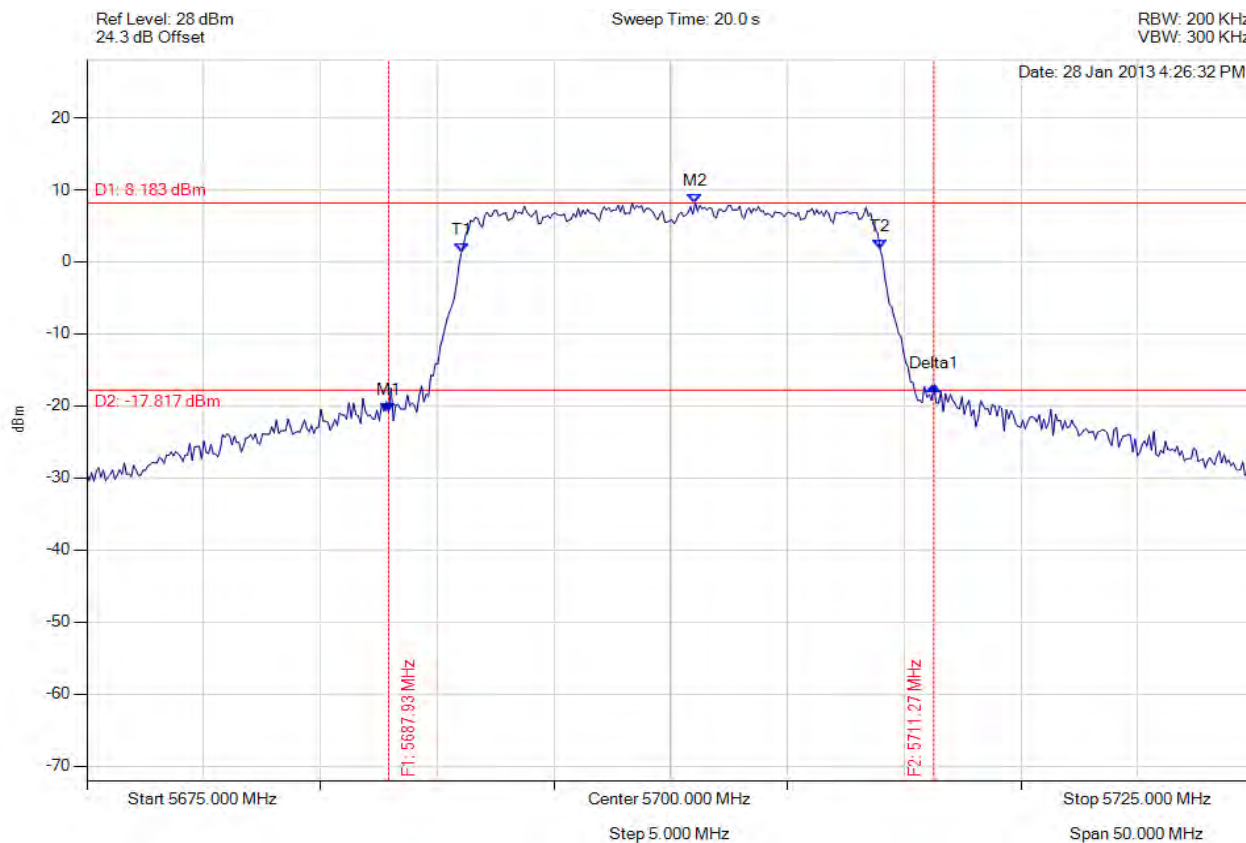

Analyser Setup	Marker : Frequency : Amplitude	Test Results
Detector = MAX PEAK Sweep Count = 0 RF Atten (dB) = 20 Trace Mode = VIEW	M1 : 5687.926 MHz : -20.844 dBm M2 : 5701.052 MHz : 8.183 dBm Delta1 : 23.347 MHz : 3.610 dB T1 : 5691.032 MHz : 1.232 dBm T2 : 5708.968 MHz : 1.761 dBm OBW : 17.936 MHz	Measured 26 dB Bandwidth: 23.347 MHz Measured 99% Bandwidth: 17.936 MHz

[Back to the Matrix](#)

This test report may be reproduced in full only. The document may only be updated by MiCOM Labs personnel. Any changes will be noted in the Document History section of the report.



**26 dB & 99% BANDWIDTH**

Variant: 802.11a, Channel: 5700.00 MHz, Chain b, Temp: Ambient, Voltage: 12 Vdc

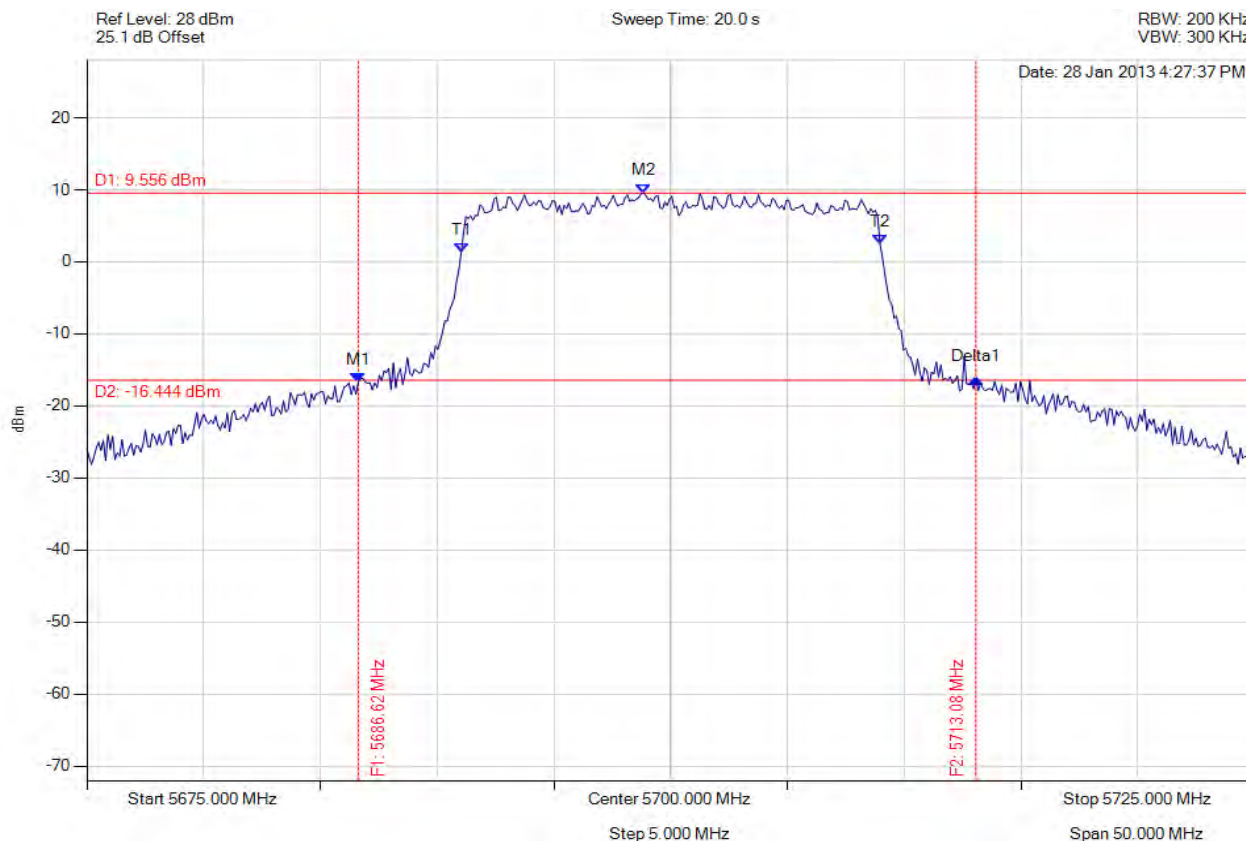

Analyser Setup	Marker : Frequency : Amplitude	Test Results
Detector = MAX PEAK Sweep Count = 0 RF Atten (dB) = 20 Trace Mode = VIEW	M1 : 5686.623 MHz : -16.690 dBm M2 : 5698.848 MHz : 9.556 dBm Delta1 : 26.453 MHz : 0.529 dB T1 : 5691.032 MHz : 1.346 dBm T2 : 5708.968 MHz : 2.413 dBm OBW : 17.936 MHz	Measured 26 dB Bandwidth: 26.453 MHz Measured 99% Bandwidth: 17.936 MHz

[Back to the Matrix](#)

This test report may be reproduced in full only. The document may only be updated by MiCOM Labs personnel. Any changes will be noted in the Document History section of the report.



**26 dB & 99% BANDWIDTH**

Variant: 802.11a, Channel: 5700.00 MHz, Chain c, Temp: Ambient, Voltage: 12 Vdc

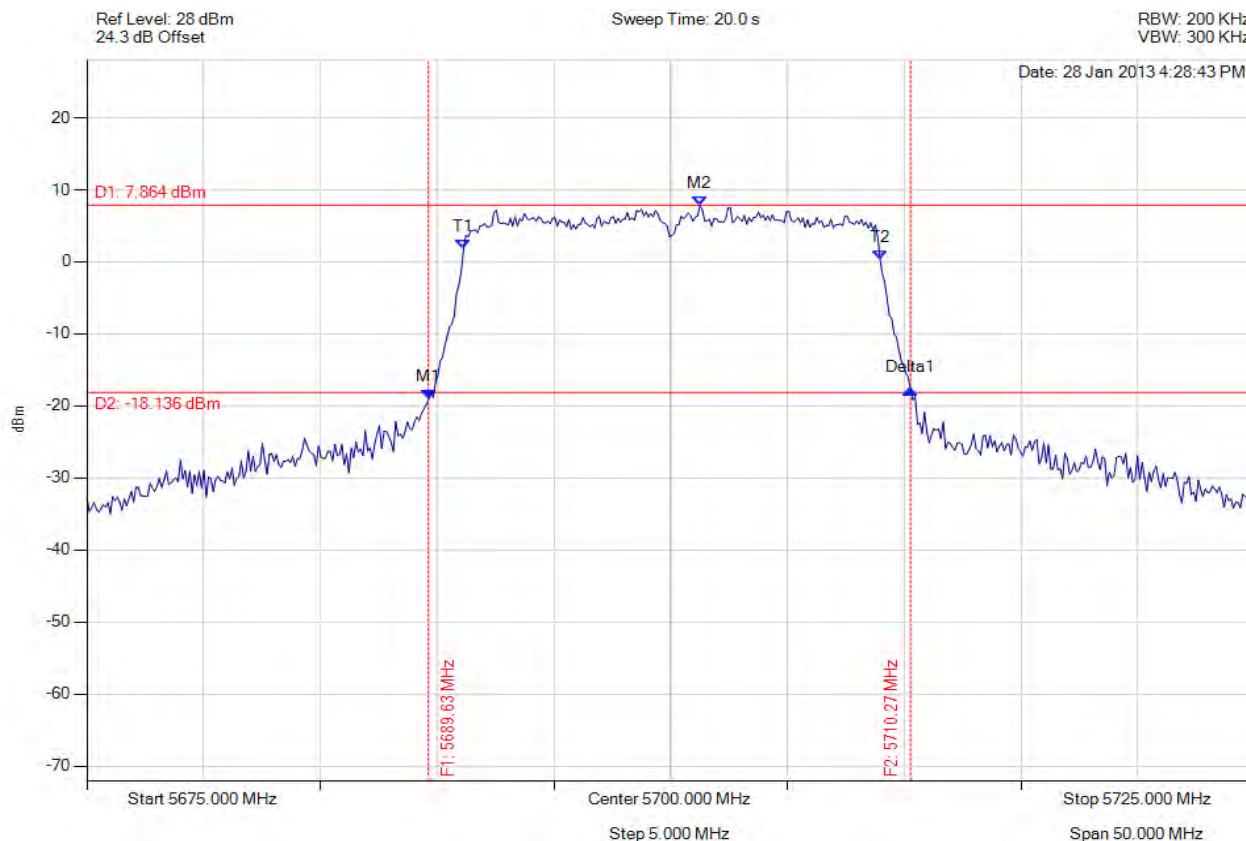

Analyser Setup	Marker : Frequency : Amplitude	Test Results
Detector = MAX PEAK Sweep Count = 0 RF Atten (dB) = 20 Trace Mode = VIEW	M1 : 5689.629 MHz : -19.114 dBm M2 : 5701.253 MHz : 7.864 dBm Delta1 : 20.641 MHz : 1.381 dB T1 : 5691.132 MHz : 1.824 dBm T2 : 5708.968 MHz : 0.294 dBm OBW : 17.836 MHz	Measured 26 dB Bandwidth: 20.641 MHz Measured 99% Bandwidth: 17.836 MHz

[Back to the Matrix](#)

This test report may be reproduced in full only. The document may only be updated by MiCOM Labs personnel. Any changes will be noted in the Document History section of the report.



**26 dB & 99% BANDWIDTH**

Variant: 802.11n HT-20, Channel: 5500.00 MHz, Chain a, Temp: Ambient, Voltage: 12 Vdc

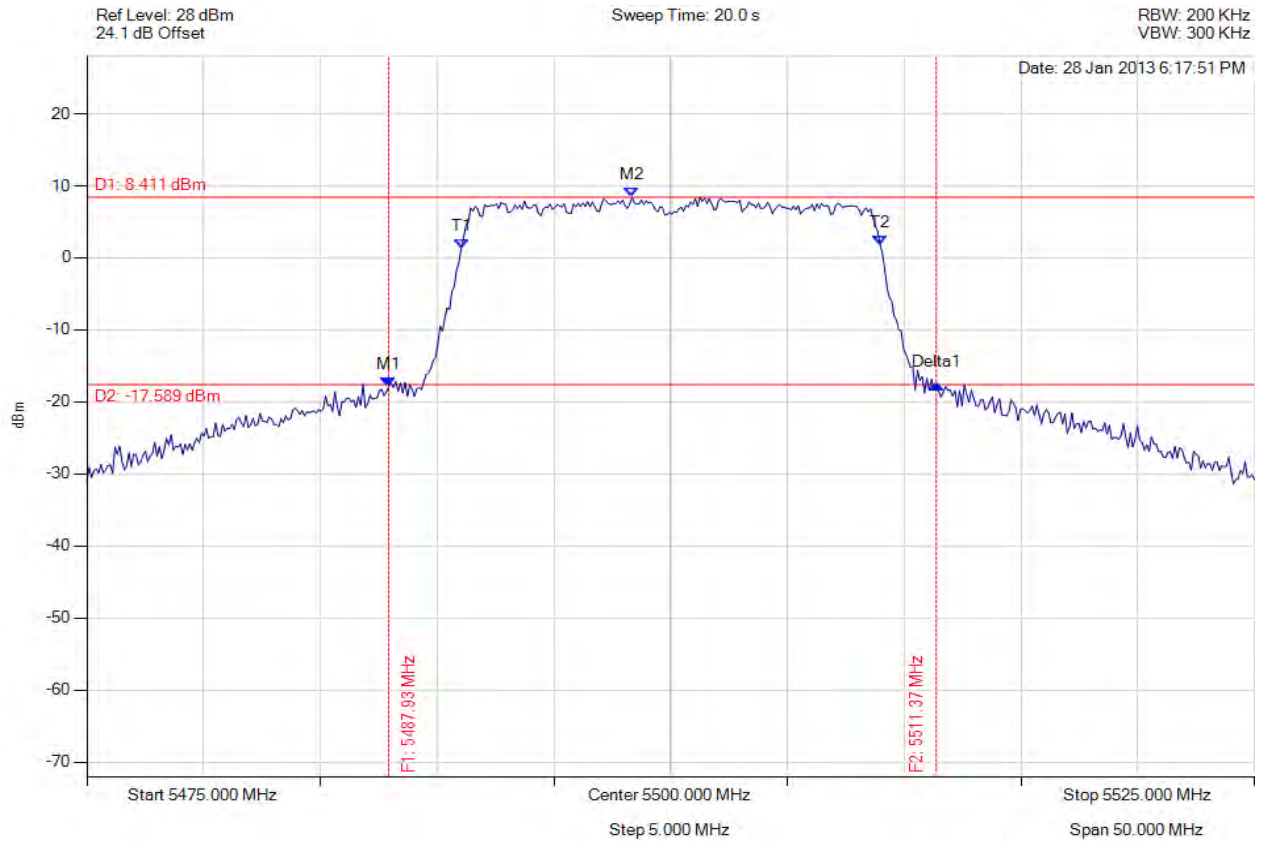

Analyser Setup	Marker : Frequency : Amplitude	Test Results
Detector = MAX PEAK Sweep Count = 0 RF Atten (dB) = 20 Trace Mode = VIEW	M1 : 5487.926 MHz : -17.845 dBm M2 : 5498.347 MHz : 8.411 dBm Delta1 : 23.447 MHz : 0.266 dB T1 : 5491.032 MHz : 1.354 dBm T2 : 5508.968 MHz : 1.832 dBm OBW : 17.936 MHz	Measured 26 dB Bandwidth: 23.447 MHz Measured 99% Bandwidth: 17.936 MHz

[Back to the Matrix](#)

This test report may be reproduced in full only. The document may only be updated by MiCOM Labs personnel. Any changes will be noted in the Document History section of the report.





**Title:** APIN0224, APIN0225 802.11a/b/g/n/ac  
**To:** FCC 47 CFR Part 15.407 & IC RSS-210  
**Serial #:** ARUB146-U1 Rev A  
**Issue Date:** 13th June 2013  
**Page:** 225 of 344



**26 dB & 99% BANDWIDTH**

Variant: 802.11n HT-20, Channel: 5500.00 MHz, Chain b, Temp: Ambient, Voltage: 12 Vdc

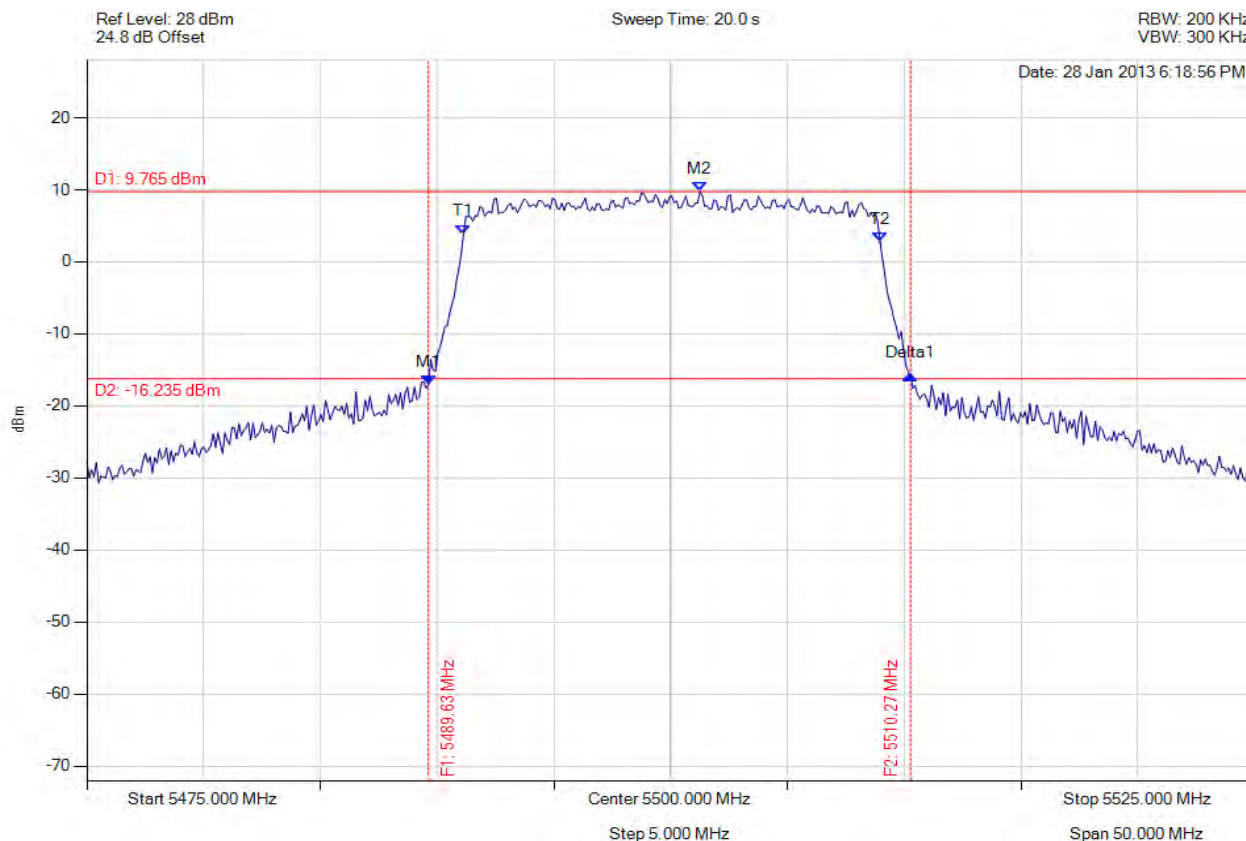

Analyser Setup	Marker : Frequency : Amplitude	Test Results
Detector = MAX PEAK Sweep Count = 0 RF Atten (dB) = 20 Trace Mode = VIEW	M1 : 5489.629 MHz : -16.995 dBm M2 : 5501.253 MHz : 9.765 dBm Delta1 : 20.641 MHz : 1.263 dB T1 : 5491.132 MHz : 3.888 dBm T2 : 5508.968 MHz : 2.763 dBm OBW : 17.836 MHz	Measured 26 dB Bandwidth: 20.641 MHz Measured 99% Bandwidth: 17.836 MHz

[Back to the Matrix](#)

This test report may be reproduced in full only. The document may only be updated by MiCOM Labs personnel. Any changes will be noted in the Document History section of the report.